

# Traction Theory



# Fundamental Mechanics Approach

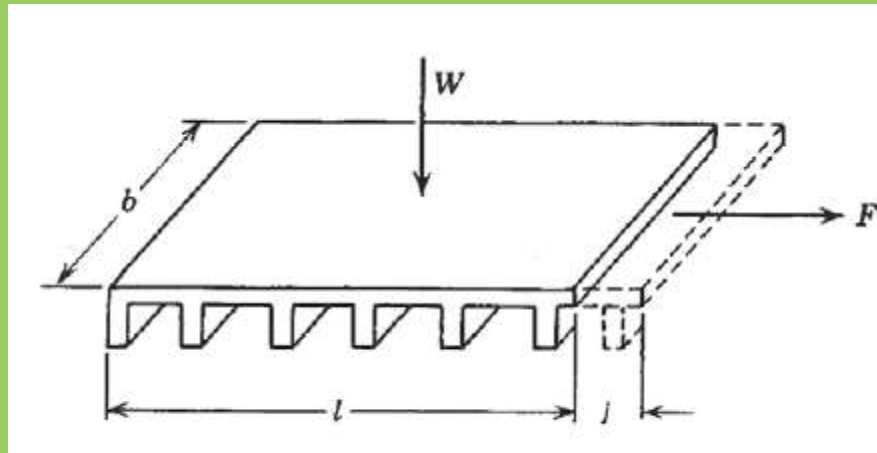
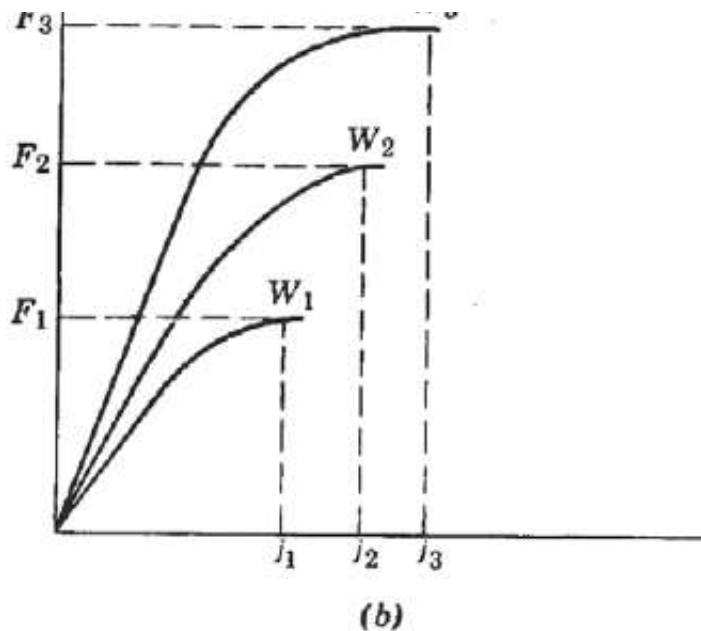

Fig. 1(a) Shear plate apparatus for measuring soil shear strength.



(b)

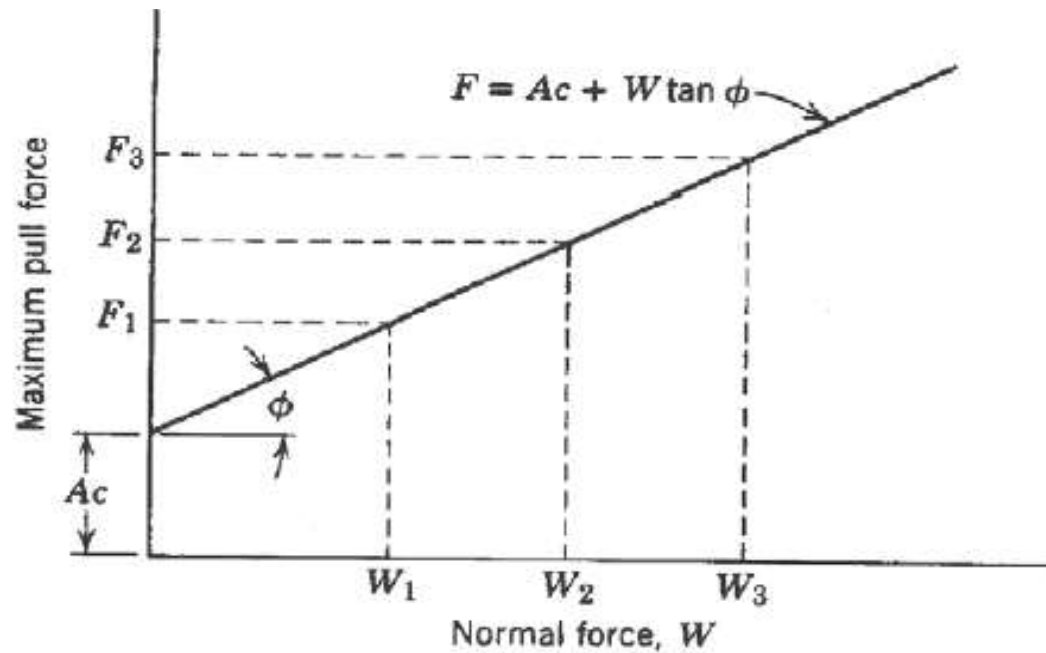

Fig. 1 (c) The soil parameters  $c$  and  $\phi$  can be determined from a plot of the maximum shear force versus the normal force.

Fig. 1 (b) Nature of the shear force versus shear displacement relation for various vertical loads.

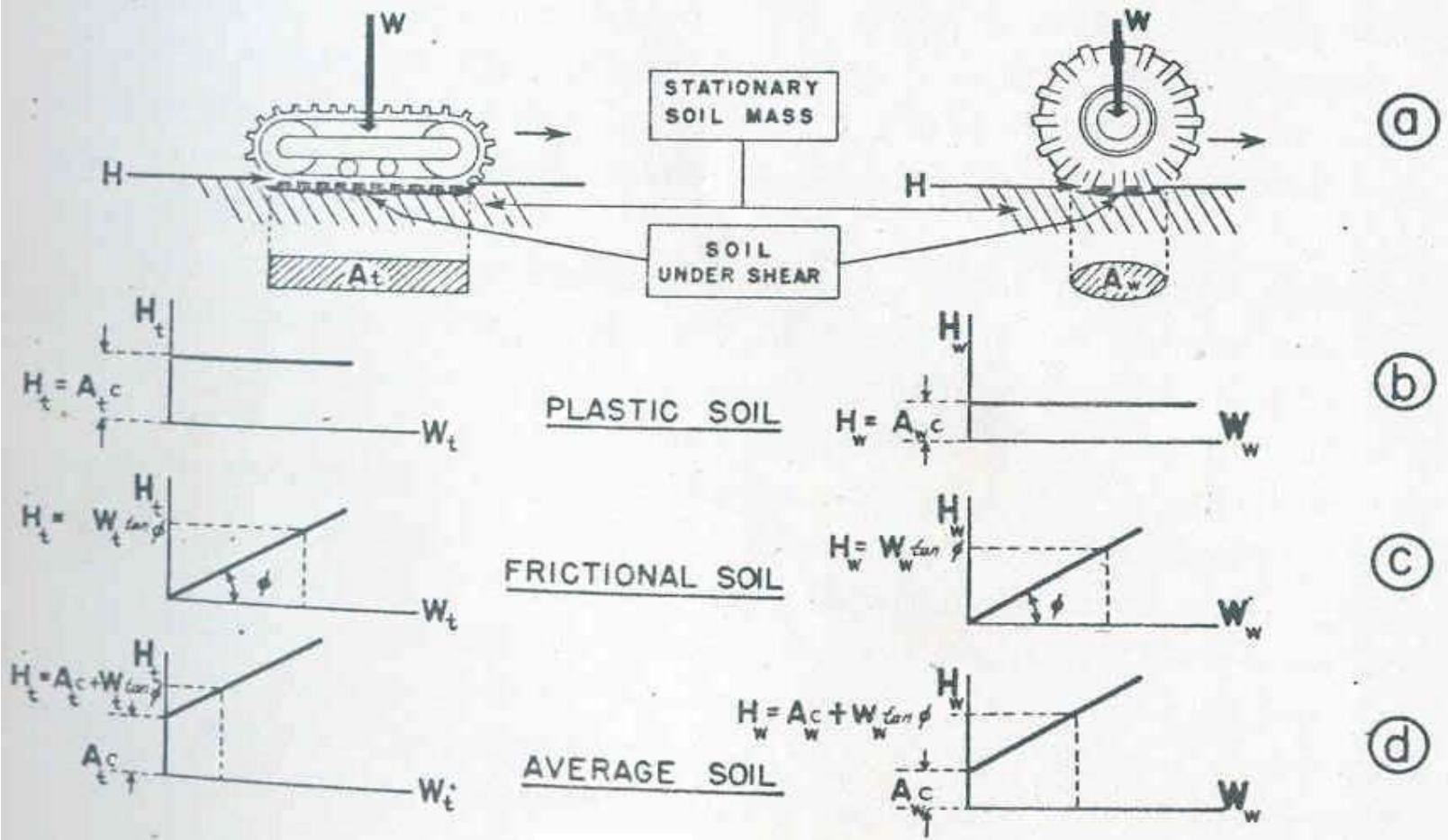

Fig. 2 Soil shear.

# Traction Mechanics

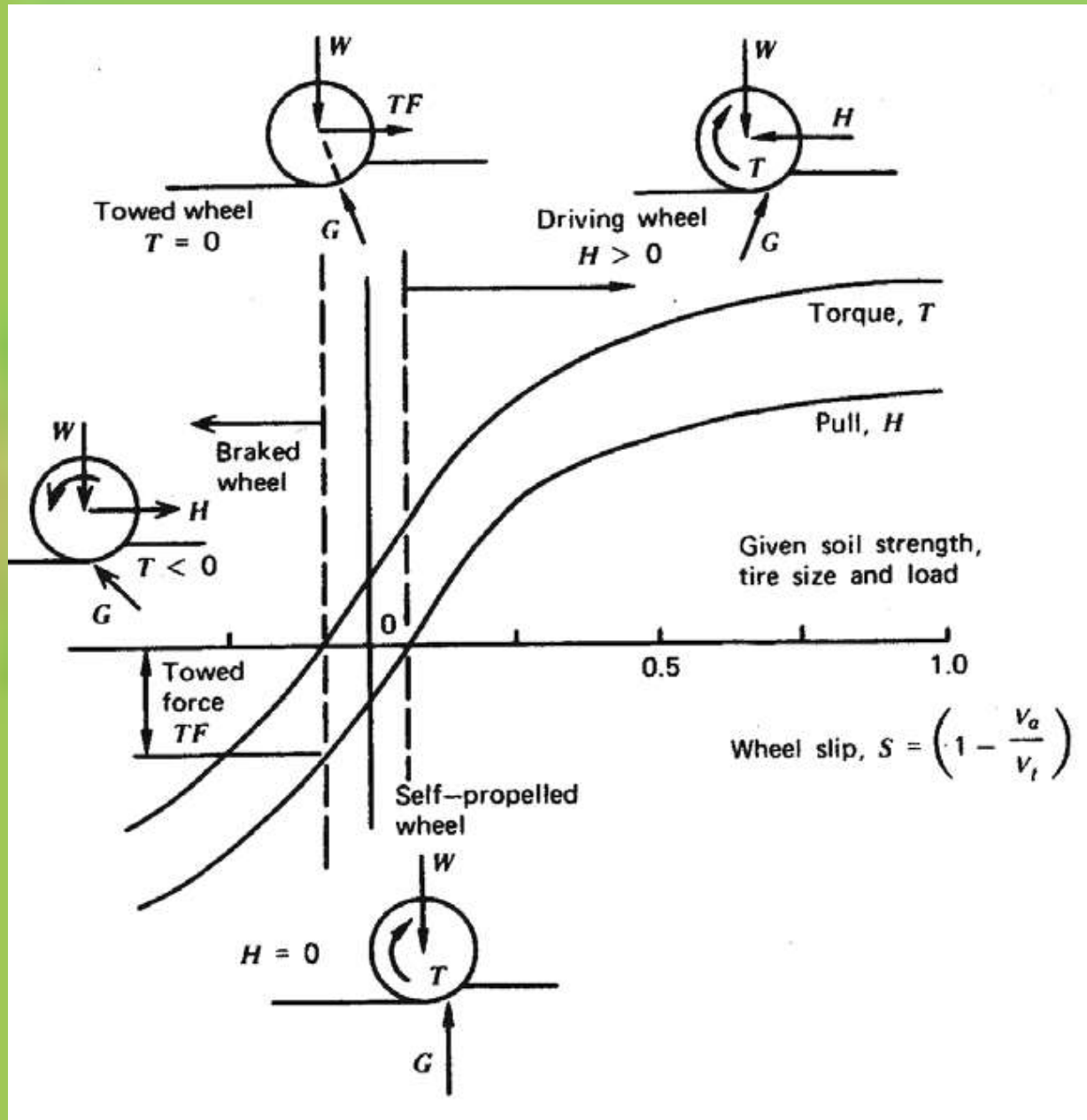
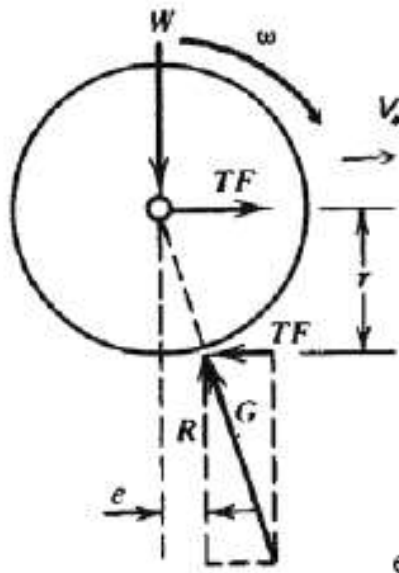

Fig. 3 Net traction (pull)-torque-slip relation for wheels on soil. (From Wismer and Luth, 1974.)



**Fig. 4 (a)**  
Free body  
diagram of a  
towed wheel.

$$TF r - R e = 0$$

$$e = (TF/R)r = (TF/W)r$$

$$\rho = TF/W. \text{ Thus } e = \rho r.$$

$$H = F - TF$$

$$\mu_g = F/R = F/W$$

$$\mu = H/R = H/W$$

$$\frac{H}{W} = \mu = \frac{F}{W} - \frac{TF}{W} = \mu_g - \rho$$

$$T - (F - TF)r - R e = 0$$

$$T = F r$$

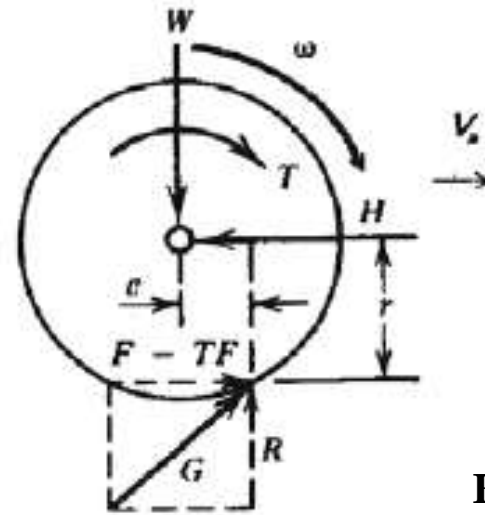

**Fig 4 (b)**  
Free body  
diagram of  
a driving wheel.

# Traction Parameters

$$\text{TRR} = 1 - \frac{\text{Actual Velocity}}{\text{Theoretical Velocity}} = 1 - \frac{V_a}{V_t}$$

Travel reduction ratio (TRR), commonly called "slip" and expressed in percent.

Zero travel reduction can be defined using any of four methods (*ASAE Standards, 2001b*):

1. A self-propelled (zero net traction) condition on a non-deforming surface (recommended for rolling circumference data, as in published tire data).
2. A self-propelled (zero net traction) condition on the test surface.
3. A towed (zero gross traction, i.e., zero torque) condition on a non-deforming surface.
4. A towed (zero gross traction) condition on the test surface.

***Net Traction Ratio (NTR)***

$$\text{NTR} = \frac{\text{Net Traction}}{\text{Dynamic Reaction Force}} = \frac{\text{NT}}{\text{Wd}}$$

$$\begin{aligned}
 \text{TE (ratio)} &= \frac{\text{Output Power}}{\text{Input Power}} = \frac{\text{NT} \times \text{Va}}{\text{Axle Power}} \\
 &= \frac{\text{NT}}{\text{GT}} \frac{\text{Va}}{\text{Vt}} = \frac{\text{NT} / \text{Wd}}{\text{GT} / \text{Wd}} \frac{\text{Va}}{\text{Vt}} = \left( \frac{\text{NTR}}{\text{GTR}} \right) \left( \frac{\text{Va}}{\text{Vt}} \right) = \frac{\mu}{\mu_{\xi}} (1 - s) = \left( 1 - \frac{\rho}{\mu_{\xi}} \right) (1 - s)
 \end{aligned}$$

### ***Gross Traction Ratio (GTR)***

$$\text{GTR} = \frac{\text{GT}}{\text{Wd}} = \frac{\text{T}}{\text{rt} \times \text{Wd}}$$

$$\text{GTR} = \left( \frac{\text{NTR}}{\text{TE}} \right) \left( \frac{\text{Va}}{\text{Vt}} \right) = \left( \frac{\text{NTR}}{\text{TE}} \right) (1 - \text{TRR})$$

### ***Motion Resistance Ratio (MRR)***

$$\text{MRR} = \text{GTR} - \text{NTR}$$

# Traction Data Analysis

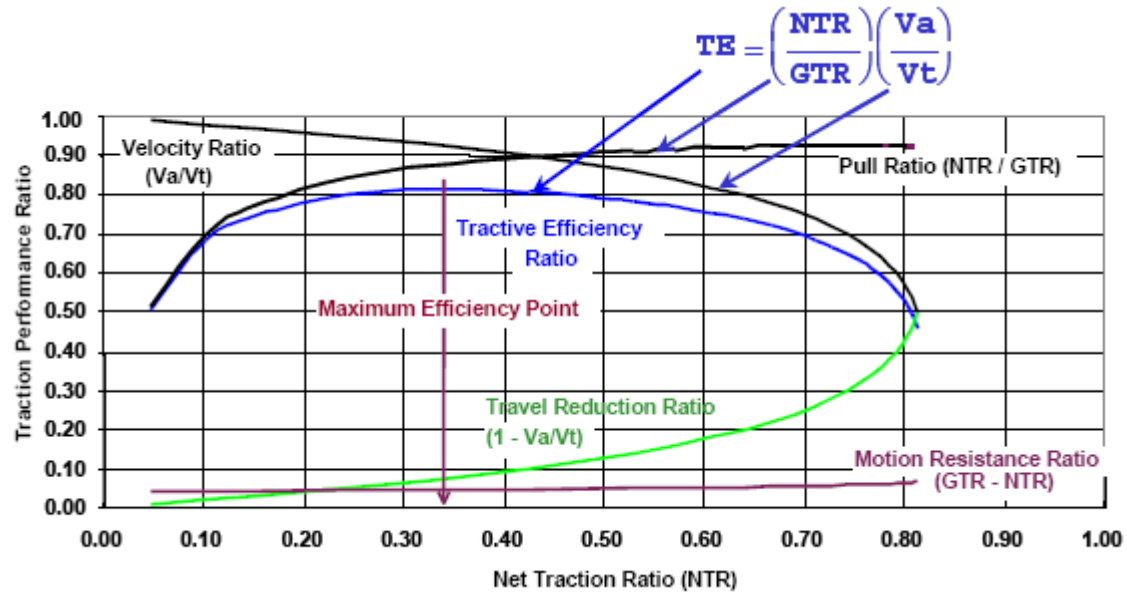

**Fig. 5 Overall tractive efficiency with velocity and pull losses.**

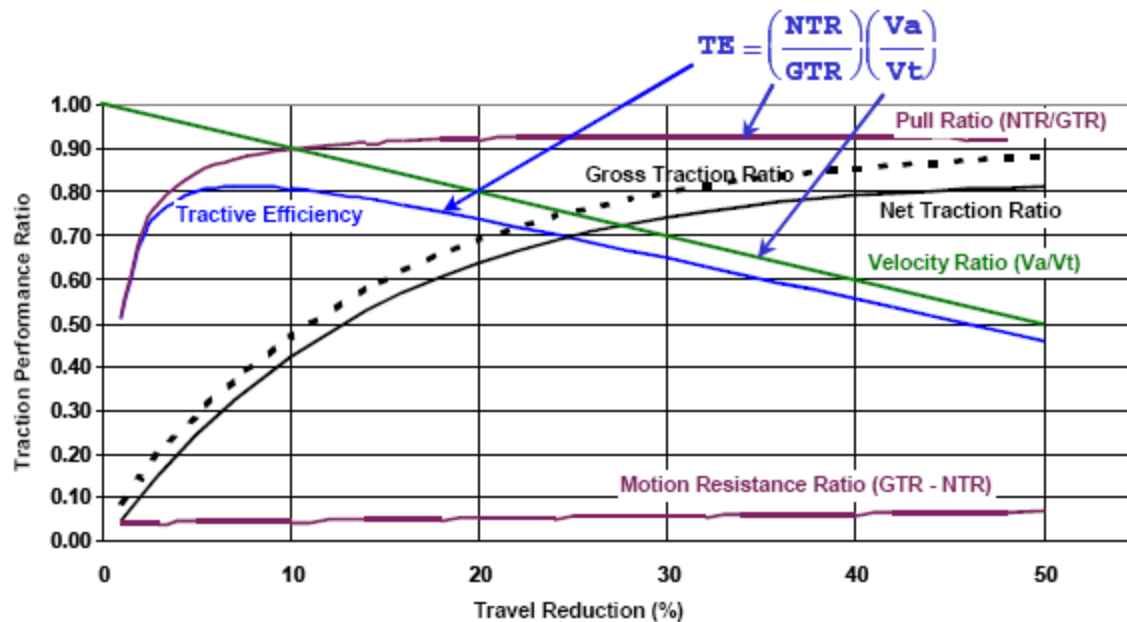

**Fig. 6 Traction losses with travel reduction (slip) as independent variable.**



Axle Wt = 8304 kg Tire = 20.8R42 Duals Pressure = 83 kPa Surface = Tilled

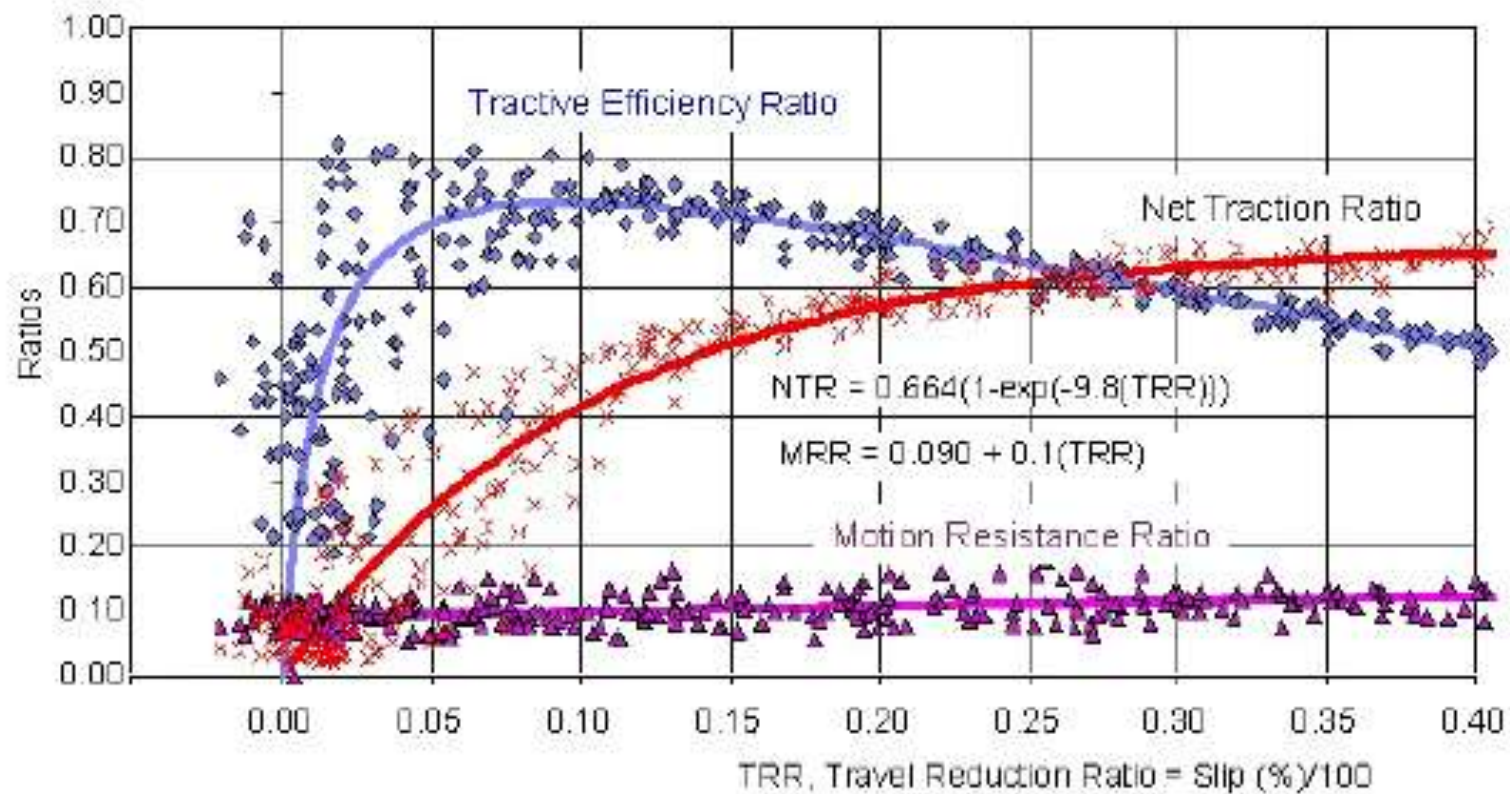

**Fig. 7** Tractive efficiency, net traction ratio, and motion resistance ratio versus slip results for a typical traction test. (From Zoz, Turner, and Shell, 2002.)

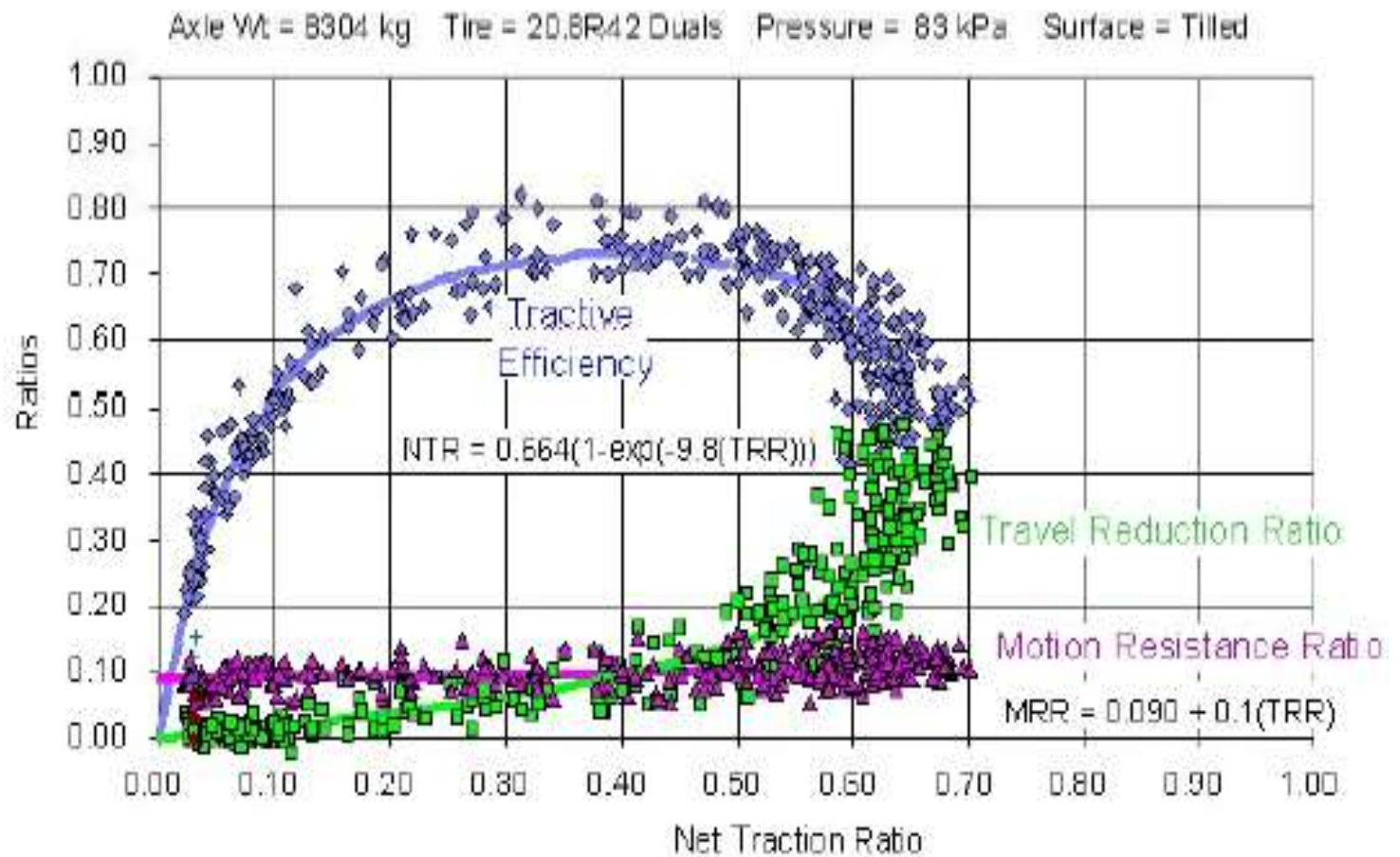

**Fig. 8** The traction test results from Figure 7 plotted as a function of net traction ratio. (From Zoz, Turner, and Shell, 2002.)

# Interpretation of Traction Plots

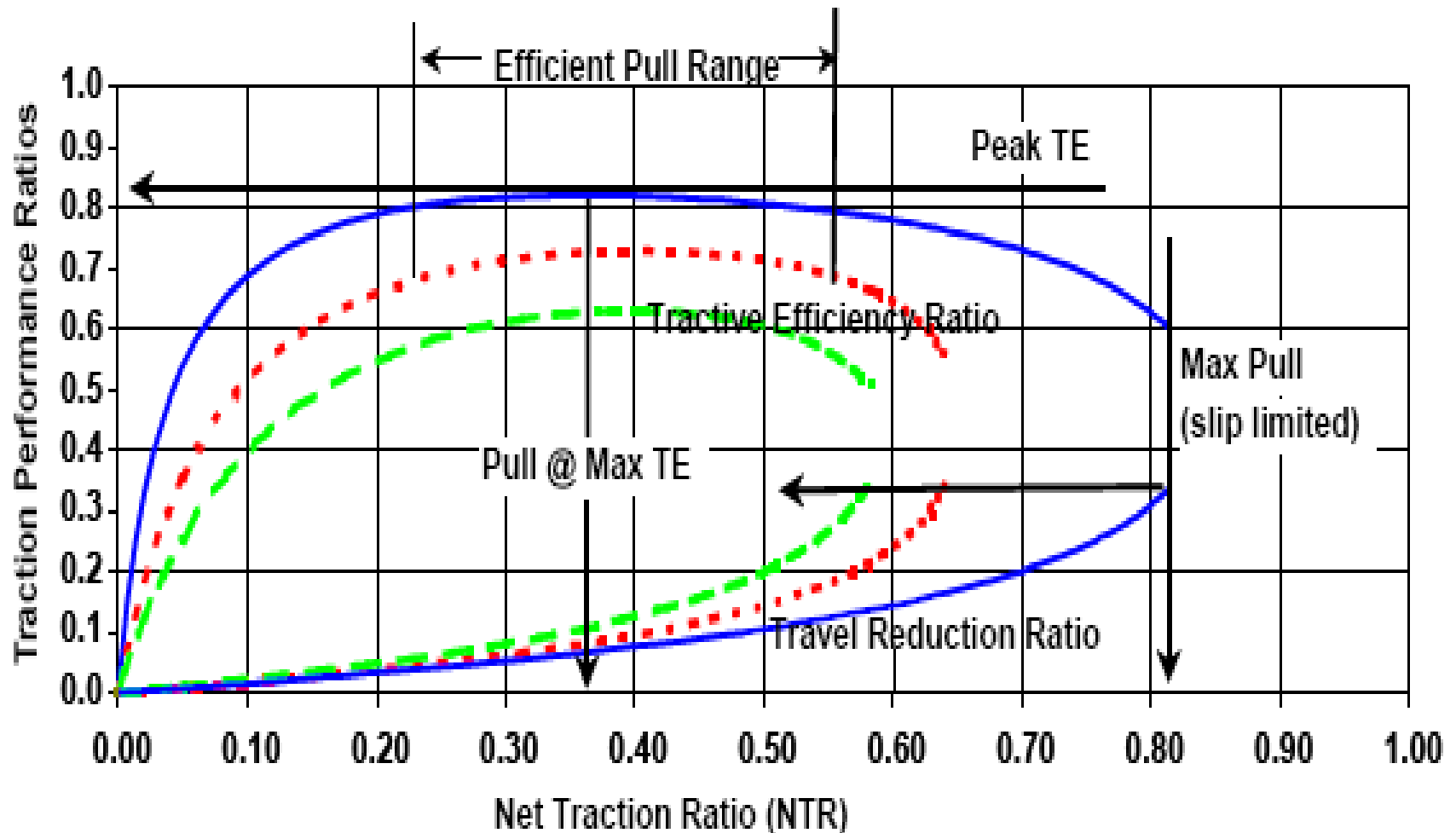
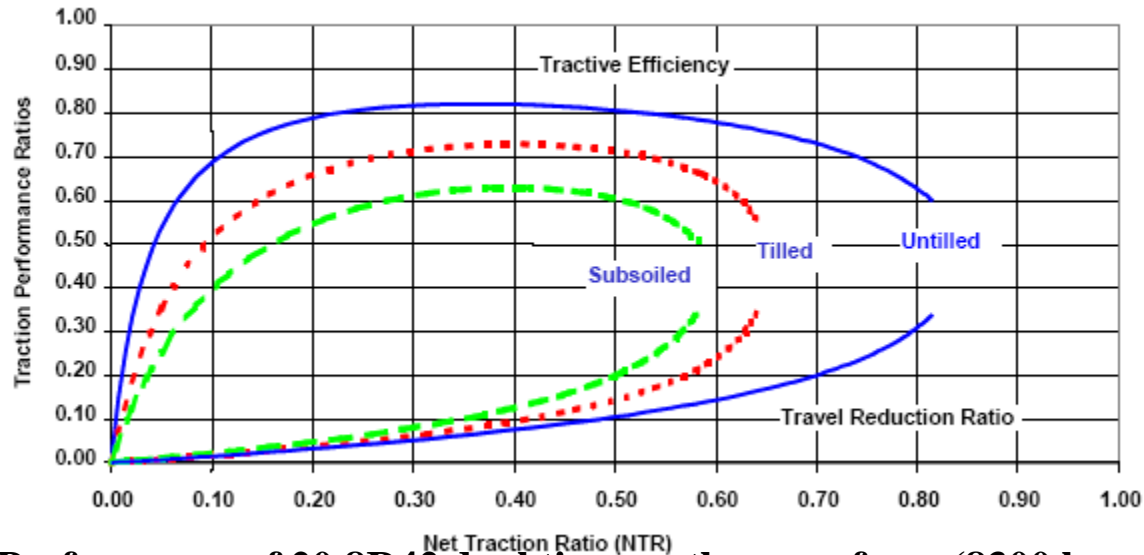
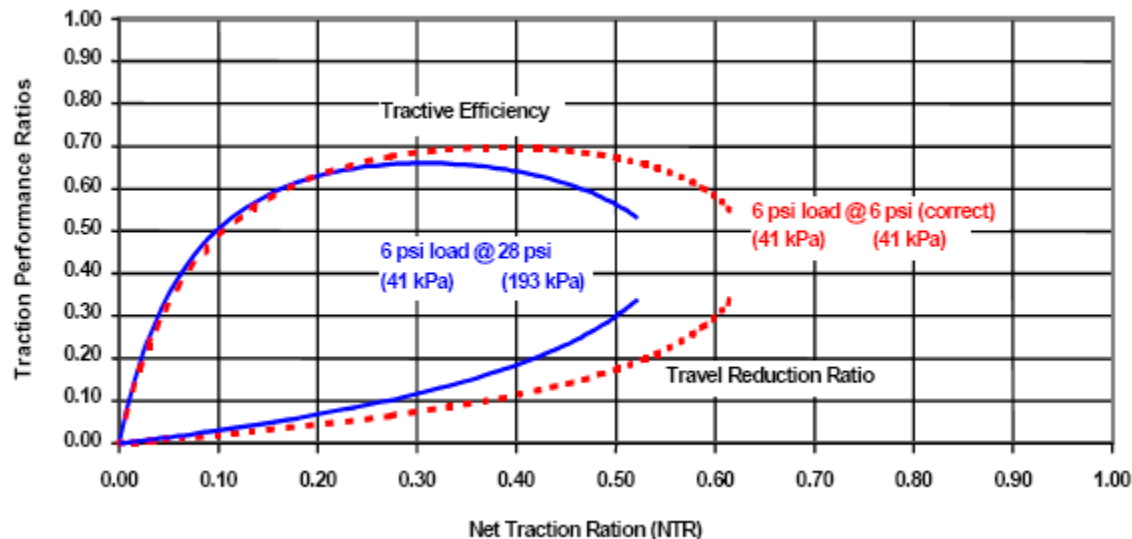

Fig. 9 Performance of 20.8R42 dual tires on three surfaces.

# Traction Performance



**Fig. 10 Performance of 20.8R42 dual tires on three surfaces (8300 kg axle load, 83 kPa tire pressure).**



**Fig. 11 Performance of single tire (Firestone 710/70R38 ATR) at two inflation pressures in tilled (loose) tractive conditions.**

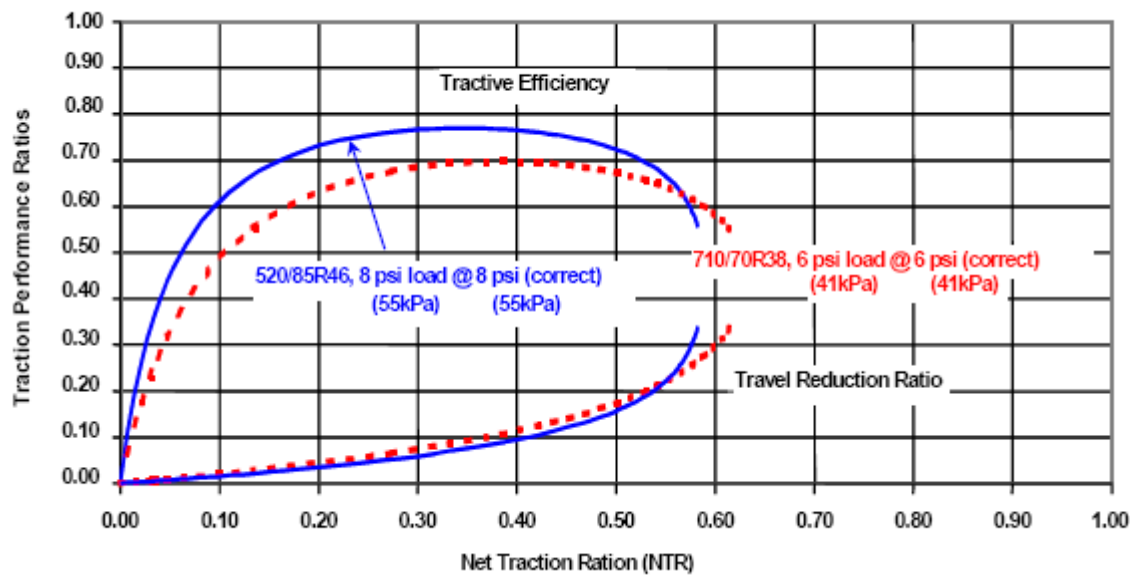

**Fig. 12 Performance of two sizes of single tires at correct inflation pressures in tilled (loose) tractive conditions.**

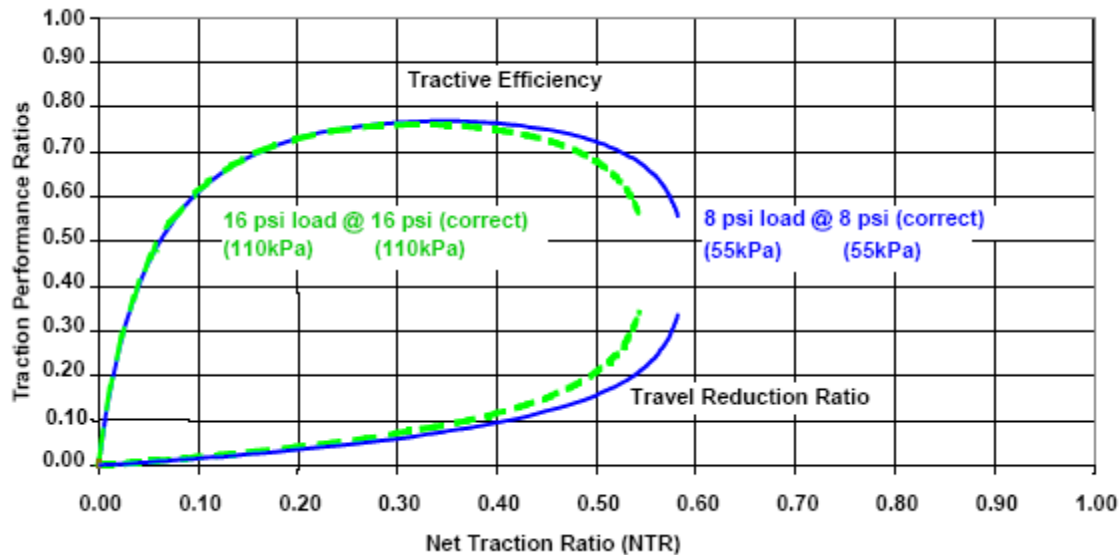

**Fig. 13 Performance of single tire (Goodyear 520/85R46 DTR) at two weights with correct pressures in tilled (loose) tractive conditions.**

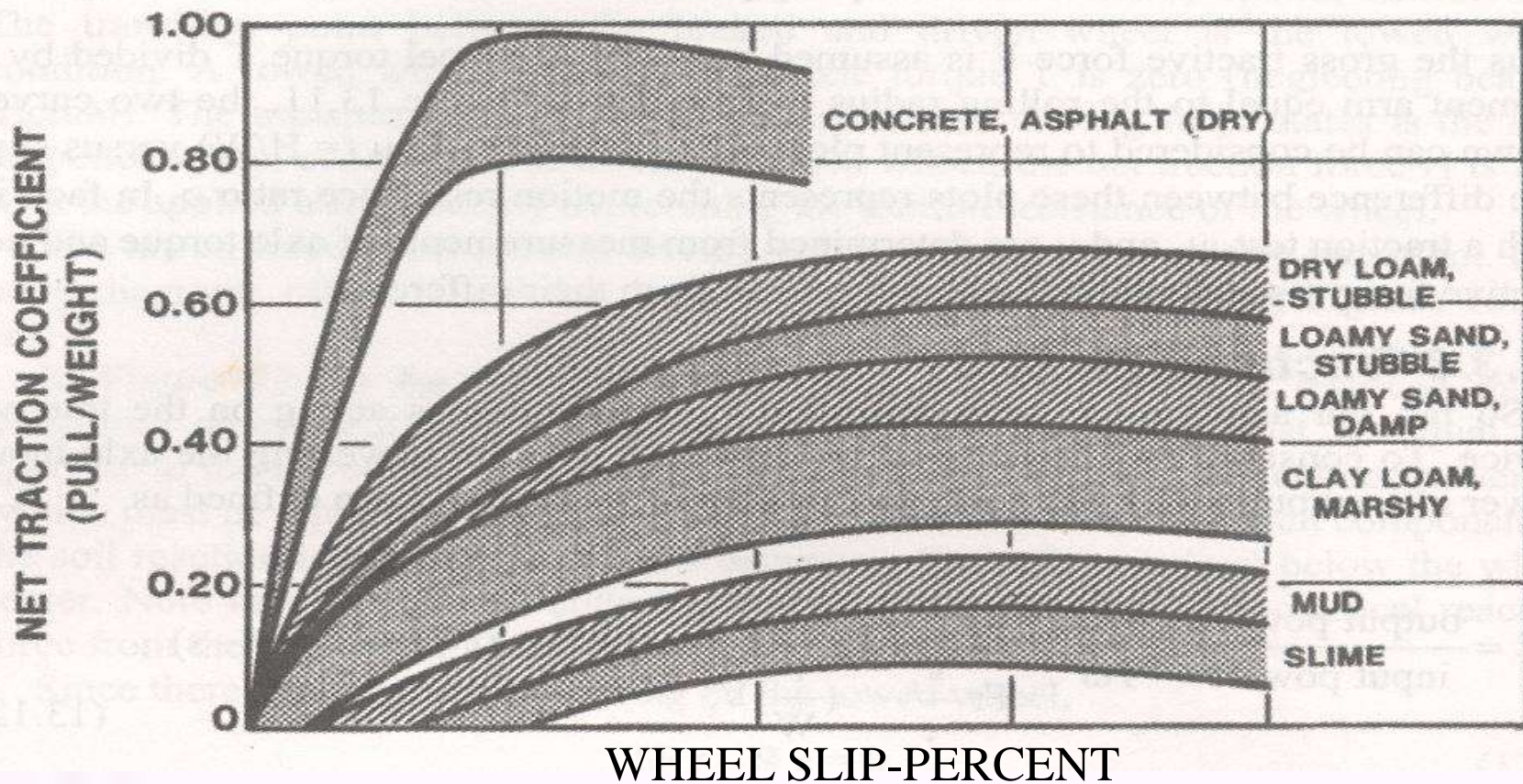

**Fig.14** Net traction and motion resistance ratio as a function of slip for a variety of surface conditions

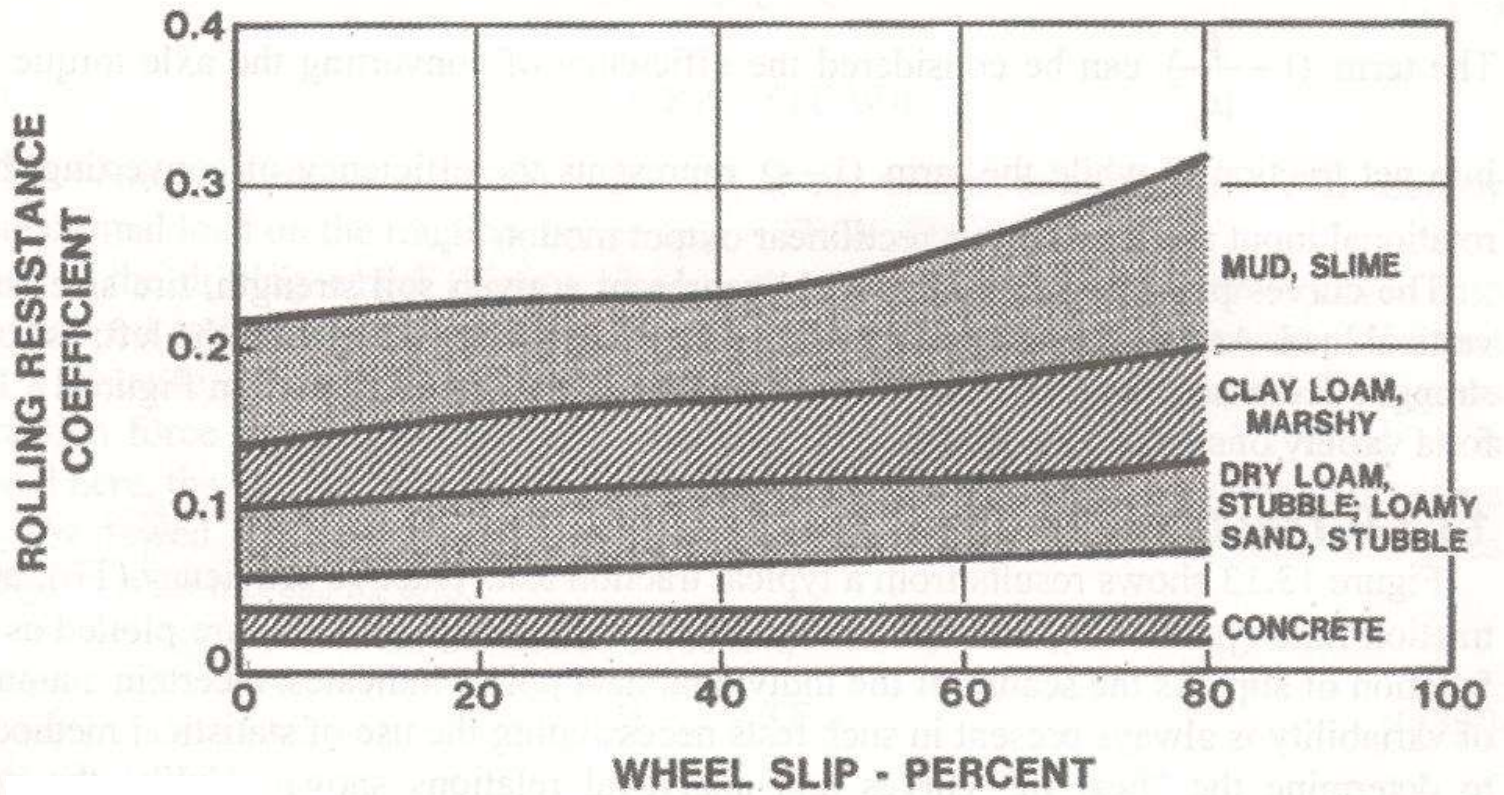

**Fig. 15** Net traction and motion resistance ratios as a function of slip for a variety of surface conditions. (From Wismer, 1982.)

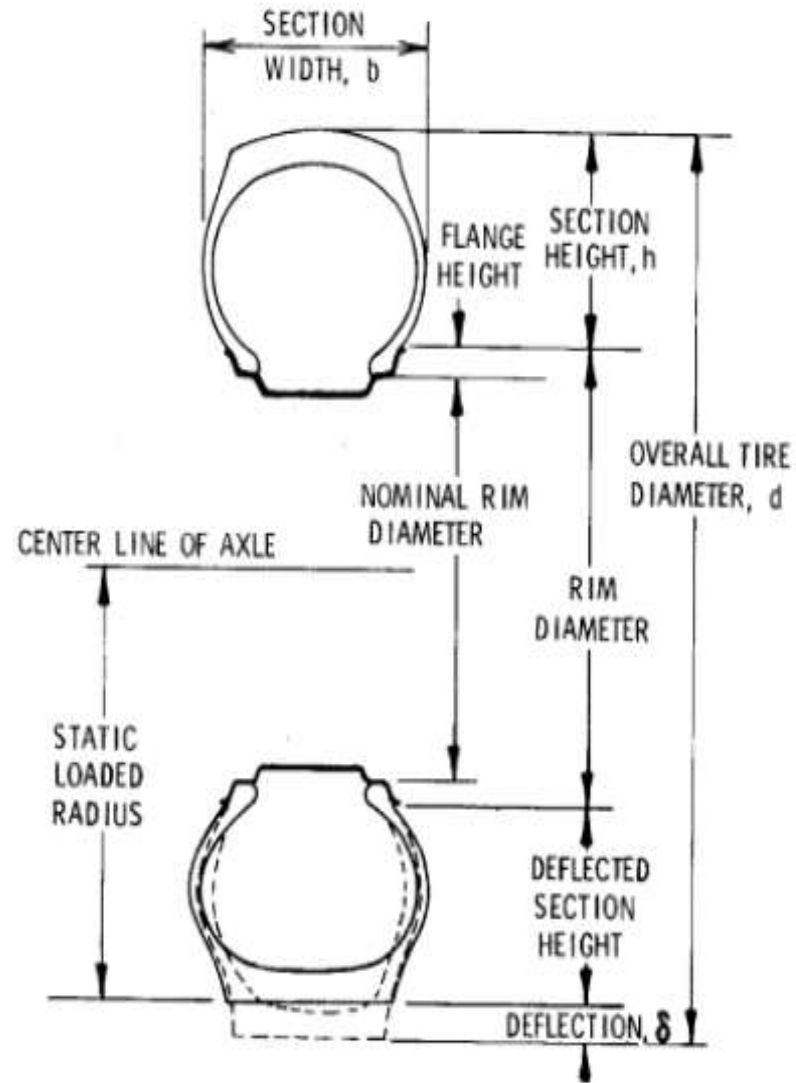

**Fig. 16** Tire Parameters. (From Brixius, 1987.)





Centurion  
UNIVERSITY  
Shaping Lives...  
Empowering Communities

## Tyre Parameters

**b** - Section width(m). This is the first number in a tire size designation.

Example: 0.468 m (18.4 inches) for an 18.4-38 tire.

**d** - Overall unloaded diameter (m). Tire diameter is standard information in tire data book.

**h** - section height (m). Section height is equal to:

$$h = \frac{d - \text{rim diameter}}{2}$$

Rim diameter is given in tire book or can be estimated by 1.06 times the nominal rim diameter. Nominal rim diameter is the second number in the tire size designation. Example: 0.965 m (38 inches) for an 18.4-38 tire.



**Centurion**  
UNIVERSITY  
Shaping Lives...  
Empowering Communities...

-Loaded tire deflection (m). Deflection is equal to:

$$\delta = \frac{d}{2} - \textit{static loaded radius}$$

Static loaded radius for the maximum rated load is standard information in tire data books. Tire deflection versus tire load curve can be obtained from tire companies.

**r** - rolling radius on hard surface (m). This can be measured or can be estimated as :

$$r = \frac{2.5 \left( \frac{d}{2} \right) (\textit{static loaded radius})}{1.5 \left( \frac{d}{2} \right) + (\textit{static loaded radius})}$$

**w** - Vertical load on tire (kN). Vertical load (W) is the dynamic tire load resulting from the static load plus any dynamic load transfers to or from the tire.

# Cone index

Table 1

Table 13.1. Cone index values for a range of soil conditions. (From Brixius, 1987.)

Soil Class	Cone Index $\text{kN/m}^2$ (kPa)	Typical Operating Conditions
Soft or sandy soil	350	Rice harvest
	480	Disking on plowed ground or low-land logging
	700	Spring plowing or earthmoving on moist soil
Medium or tilled soil	850	Planting, field cultivating
	1000	Corn harvesting, fall plowing
	1200	Wheat harvesting
Firm	1750	Summer plowing, logging in dry season, earthmoving on dry, clay soil

# Dimensional analysis

<i>Torque Ratio</i>	$\frac{Q}{rW}$
<i>Motion Resistance Ratio</i>	$\frac{M}{W}$
<i>Pull Ratio</i>	$\frac{P}{W}$
<i>Wheel Numeric(<math>C_n</math>)</i>	$\frac{Clbd}{W}$
<i>Width to Diameter Ratio</i>	$\frac{b}{d}$
<i>Deflection Ratio</i>	$\frac{\delta}{h}$
<i>Slip</i>	$S$
<i>Rolling Radius Ratio</i>	$\frac{r}{d}$
<i>Section Height Ratio</i>	$\frac{h}{d}$

However, two of the ratios can be derived from other terms:

$$\frac{P}{W} = \frac{Q}{rW} - \frac{M}{W} \quad \& \quad \frac{h}{d} = \frac{1 - \frac{2r}{d}}{\frac{\delta}{h}}$$

# Traction prediction equations

$$\frac{Q}{rW}, \frac{M}{W} = f \left( \frac{Clbd}{W}, S, \frac{b}{d}, \frac{\delta}{h} \right)$$

## *Mobility Number*

$$B_n = \left( \frac{Clbd}{W} \right) \left( \frac{1+S}{1+3} \frac{\frac{\delta}{h}}{\frac{b}{d}} \right)$$

## *Torque Ratio*

$$\frac{Q}{rW} = 0.88 \left( 1 - e^{-0.1B_n} \right) \left( 1 - e^{-7.5S} \right) + 0.04$$

$$\frac{Q}{rW}$$

Torque ratio is analogous to a friction coefficient,  $f$ :

$$f = \frac{H}{W} = \frac{Q}{rW}$$

where  $H = \frac{Q}{R}$  is the gross thrust developed at the wheel-soil surface. The largest frictional coefficient is developed at a high slip when there is a large relative movement between the wheel and the soil.

0.88

The constant 0.88 limits the maximum torque ratio developed by a wheel on soil to  $0.92 = 0.88 + 0.04$ . This is obtained with a mobility number at high slip.



$$e^{-0.1B_n}$$

The mobility number ( $B_n$ ) controls the maximum value of the torque ratio, which is attained at high slip. The mobility number and thus, the torque ratio, increases when:

- Soil strength (CI) increases
- Tire diameter (d) or section width (b) increase
- Load (W) decreases
- Deflection ratio  $\left(\frac{\delta}{h}\right)$  increases
- Width to diameter ratio (b/d) decreases

$$e^{-7.5S}$$

The constant 7.5, which may be called a gripping or surface factor controls the rate of torque ratio increase with slip. The factor is smaller than 7.5 on a wet surface and significantly larger for staked wheels or tracks

$$0.04$$

The constant 0.04 approximates the torque ratio at zero slip for all conditions. On a hard surface, zero slip occurs when the wheel is in the self propelled state. Under this condition torque is required only to overcome motion resistance due to tire flexing and scrubbing

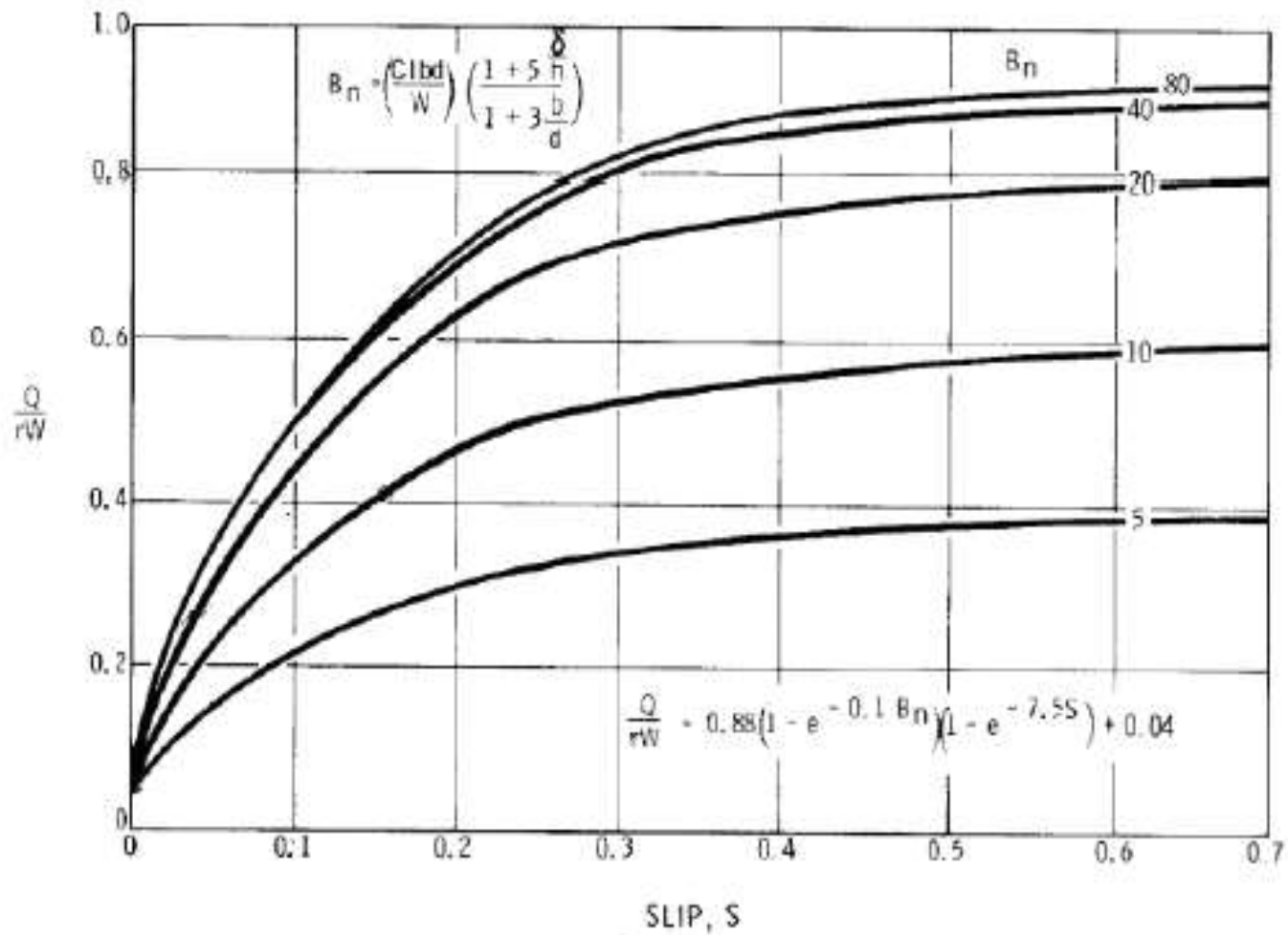

**Fig. 17.** Gross tractive ratio as a function of slip and mobility number,  $B_n$ .



# Motion Resistance Ratio

$$\frac{M}{W} = \frac{1.0}{B_n} + 0.04 + \frac{0.5S}{\sqrt{B_n}}$$

$$\frac{M}{W}$$

Motion resistance is caused by several factors:

- Tire flexing and scrubbing (hard surface)
- Compaction of soil
- Bulldozing of soil to the side
- Lateral drag caused by soil adherence and viscosity

$$\frac{M}{W}$$

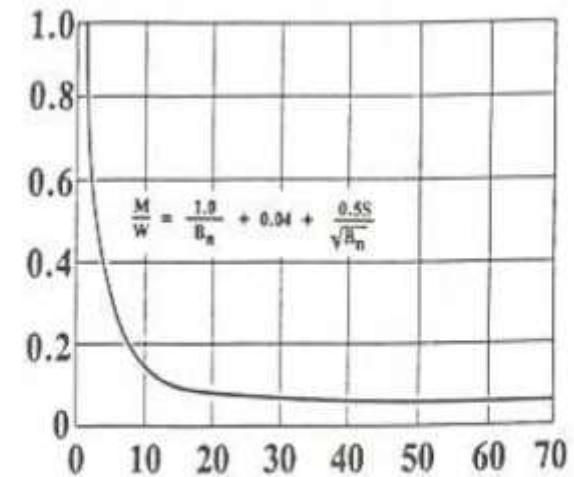

$$\frac{1.0}{B_n}$$

As  $B_n$  decreases, motion resistance increases due to increased soil compaction and sinkage. A decrease in the wheel numeric  $C_n = (CIbd/W)$  corresponds to a decrease in soil strength and /or an increase in soil-tire contact pressure

0.04

Motion resistance ratio equals 0.04 on a hard surface and represents a minimum value for any surface. This term is due to tire flexing and scrubbing.

$$\frac{0.5S}{\sqrt{B_n}}$$

Motion resistance increases with slip due to increased tire sinkage and soil shearing. Towed force can be approximated by Equation 11 by setting this term equal to zero.

#### **Pull Ratio**

Pull ratio, the net pull of the wheel divided by wheel load, is defined by Equation 12.

$$\frac{P}{W} = \frac{Q}{rW} - \frac{M}{W}$$

# Tractive efficiency



$$TE = \frac{\text{Output power}}{\text{Input power}} = \frac{\frac{P}{W}}{\frac{Q}{rW}} (1 - S)$$

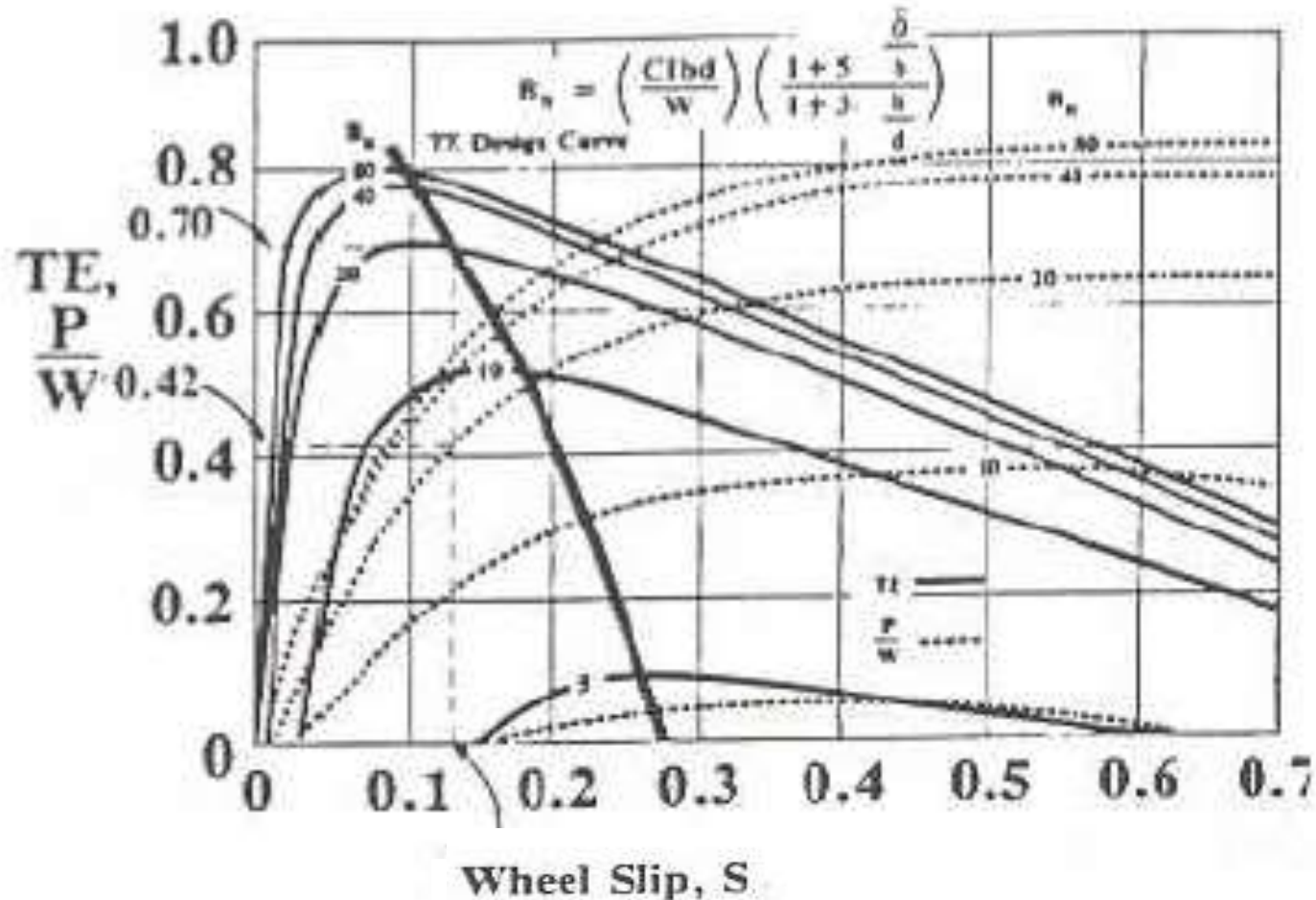

Fig. 18 Tractive efficiency design curve

# Traction models

## *Wismer and Luth Approach (1973)*

$$\mu_g = 0.75 \times \left( 1 - e^{-(0.3 C_n \cdot i)} \right)$$

$$f_r = \frac{1.2}{C_n} + 0.04$$

$$C_n = \frac{CI b d}{(W_{dr}/2)}$$

$$COT = \mu_g - f_r$$

$$TE = \frac{COT(1-i)}{(COT + f_r)}$$

This approach holds good for the conditions where,  $b/d \approx 0.30$ ,  $\delta/h \approx 0.20$ ,  $r/d \approx 0.475$ .

## *Brixius approach (1987)*

For Bias ply tyres

$$\mu_g = 0.88 (1 - e^{-0.1B_n}) (1 - e^{-7.5s}) + 0.04$$

$$\rho = \frac{1.0}{B_n} + 0.04 + \frac{0.5s}{\sqrt{B_n}}$$

$$B_n = \left( \frac{CIbd}{W} \right) \left( \frac{1 + 5\frac{\delta}{h}}{1 + 3\frac{b}{d}} \right)$$

For radial ply tyres

$$\mu_g = 0.88 (1 - e^{-0.1B_n}) (1 - e^{-9.5s}) + 0.0325$$

$$\rho = \frac{0.9}{B_n} + 0.0325 + \frac{0.5s}{\sqrt{B_n}}$$

**Thank you**