



**Centurion**  
**UNIVERSITY**

*Shaping Lives...  
Empowering Communities...*

# QUADRATURE AMPLITUDE MODULATION (QAM)

Electronics & Communication Engg. Dept.

School of Engineering & Technology

CUTM

# QAM

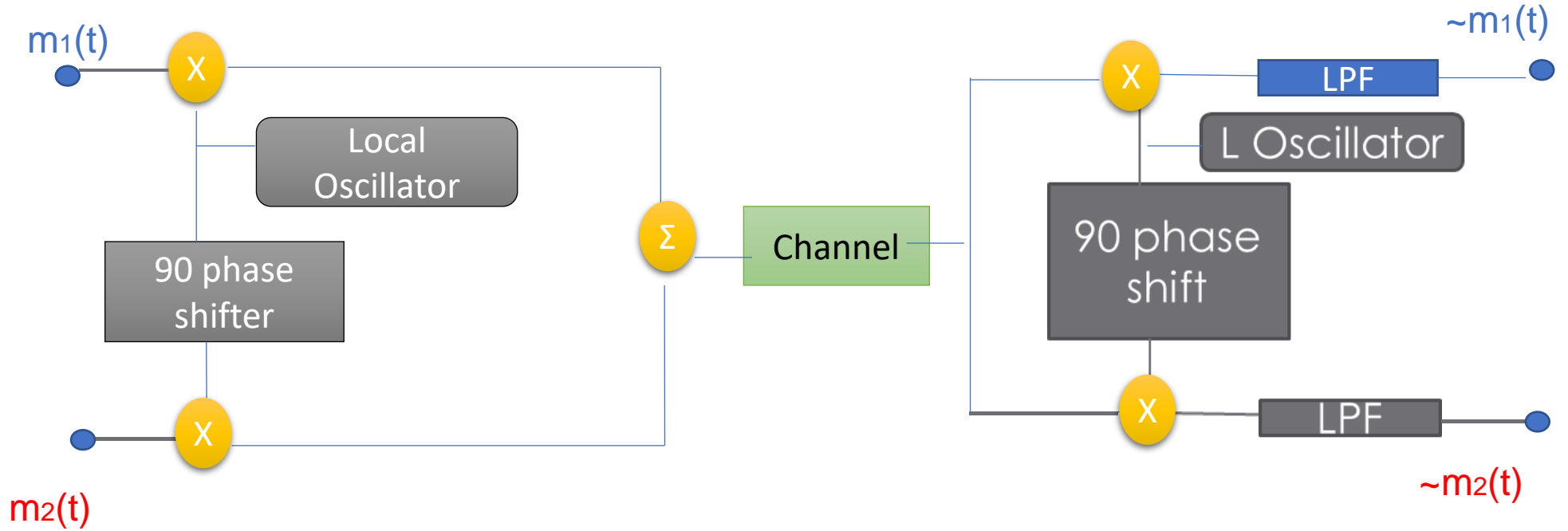

# Single-Sideband Modulation

Motivation: Bandwidth occupancy can be minimized by transmitting either the lower or the upper sideband of the message signal.

Consider the following transmitter

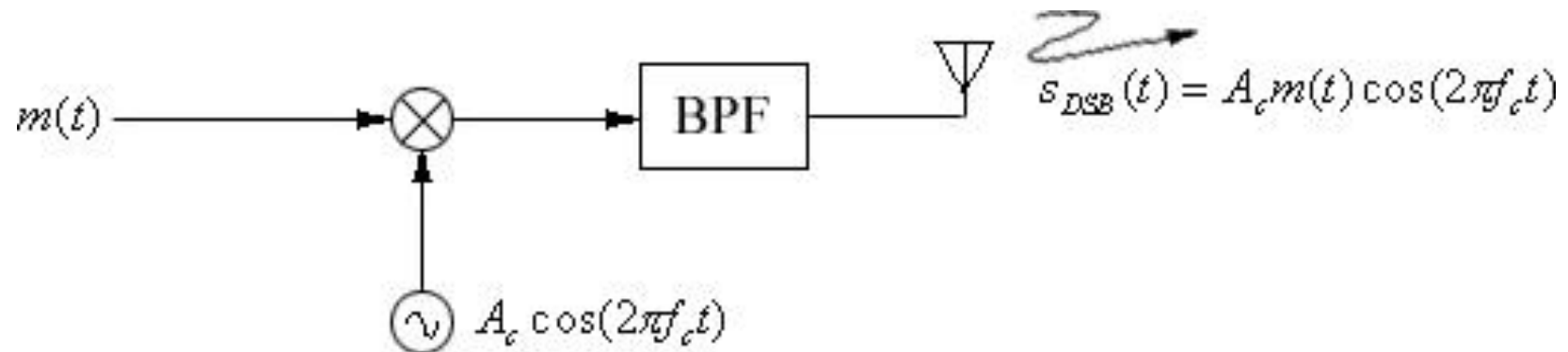

Suppose we want to transmit the upper sideband, then the following choice of bandpass filter yields the correct result

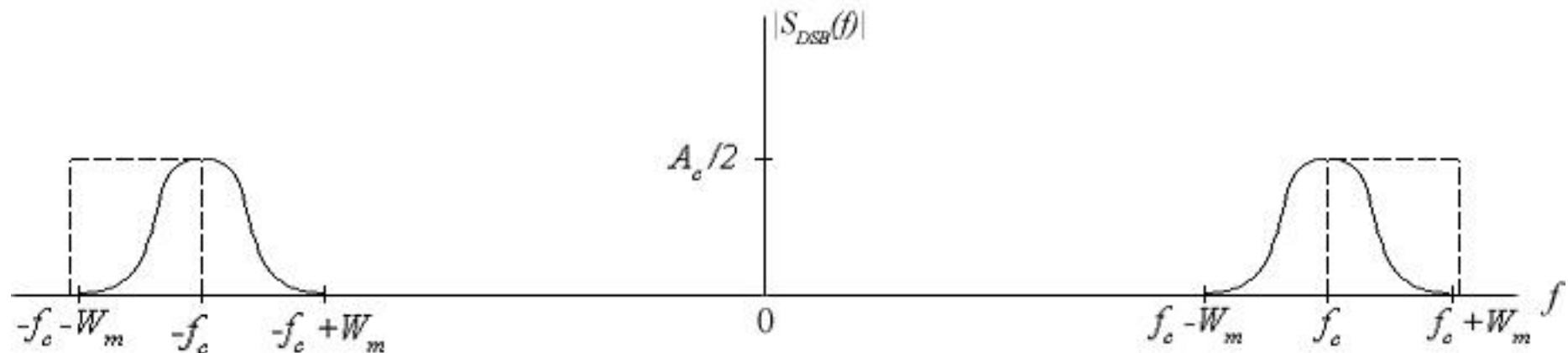

At the output of the bandpass filter,

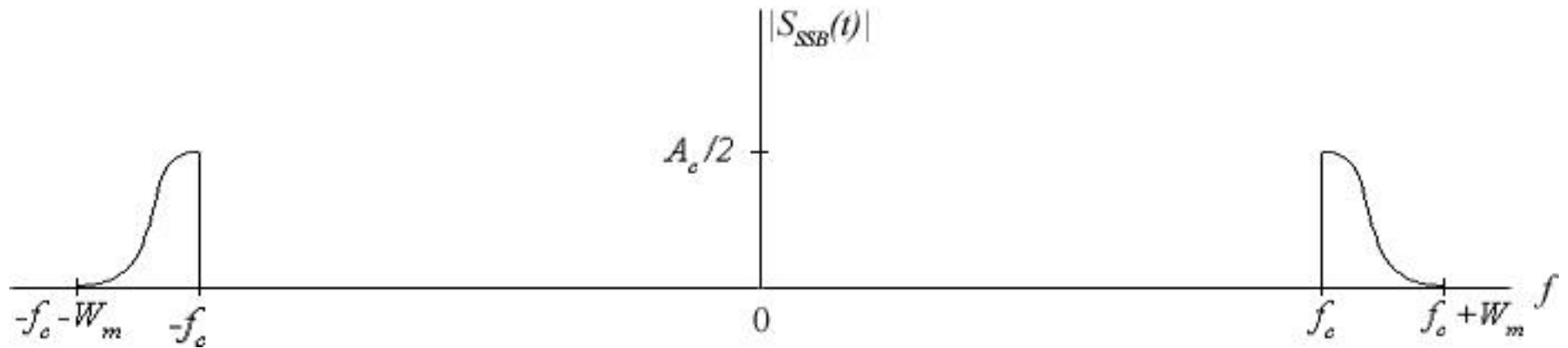

Observation: A practical bandpass filter will cause severe distortion.

Suppose the original message signal contains a gap in its magnitude spectrum around the origin, i.e.,

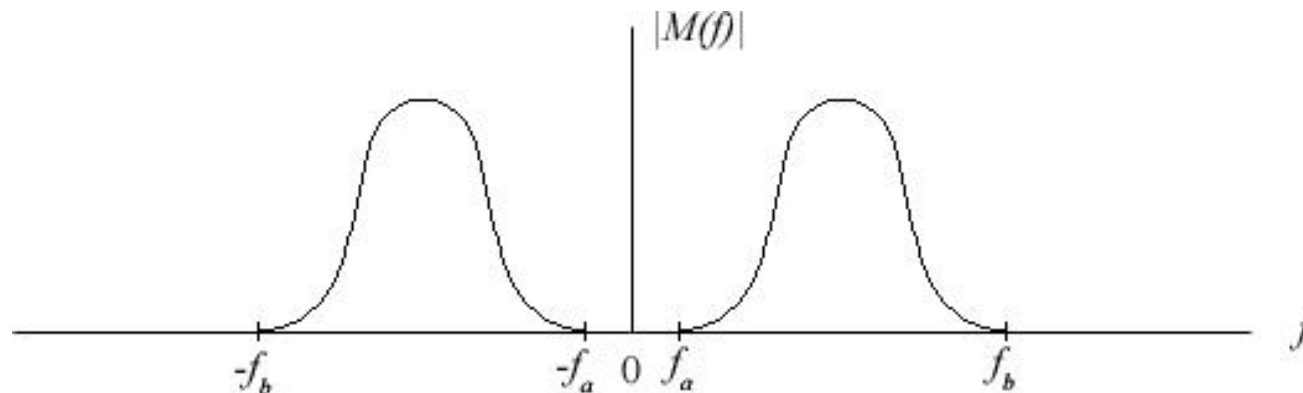

Then, SSB demodulation can be obtained by

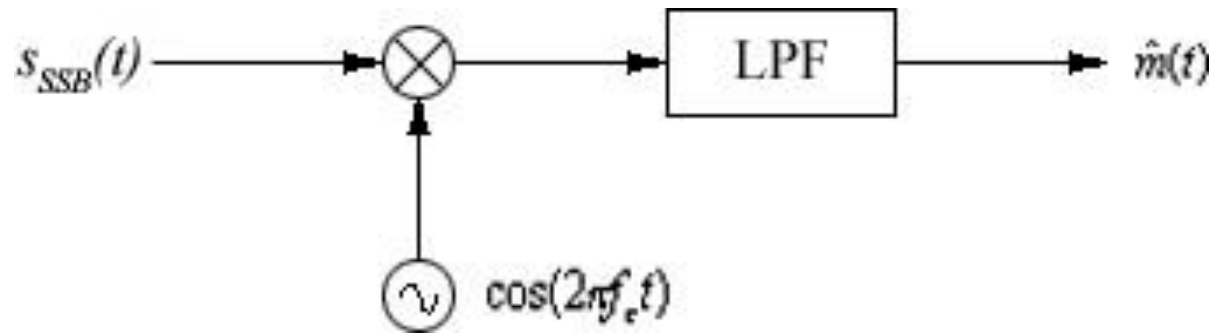

Synthesis and analysis of SSB:

Let the spectrum of a DSB-SC signal be given by

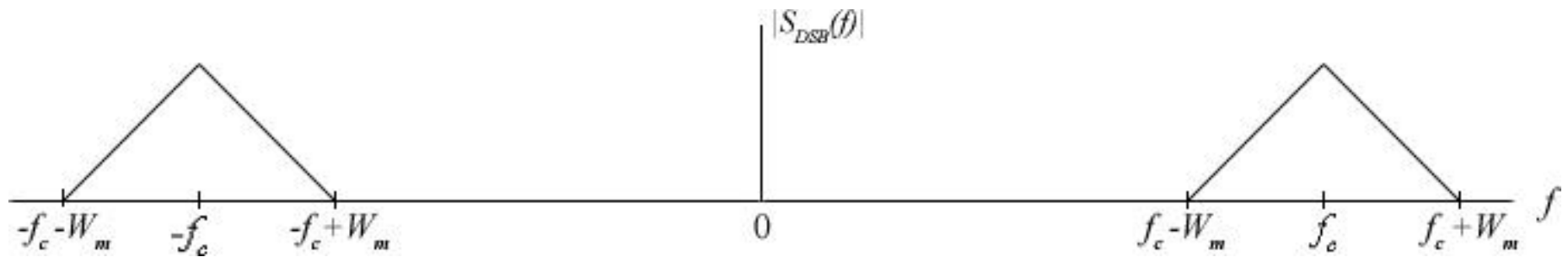

Let this DSB-SC signal be the input of a lowpass filter with magnitude response

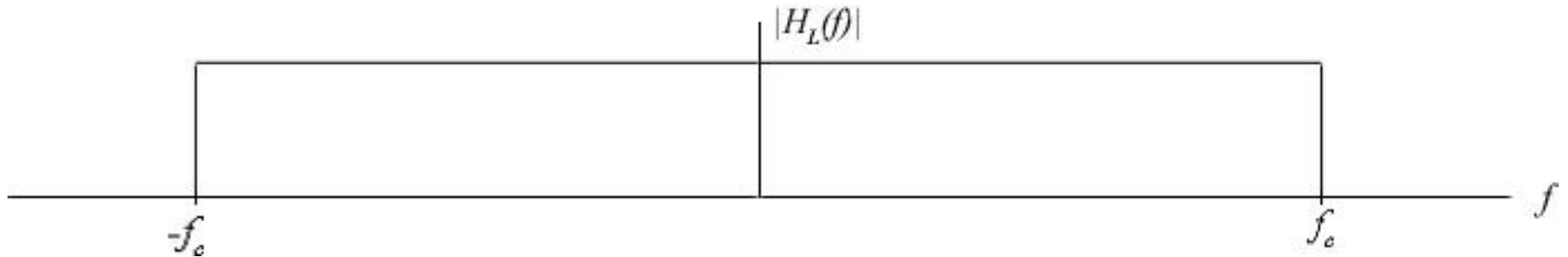

Then the resulting (output) signal would have the spectrum

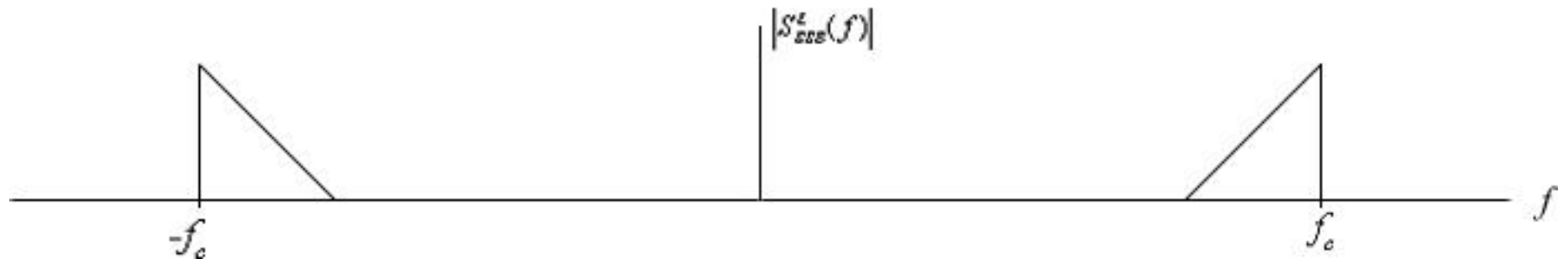

The filter  $H_L(f)$  can be represented by the algebraic sum

$$H_L(f) = \frac{1}{2} [\text{sgn}(f + f_c) - \text{sgn}(f - f_c)]$$

Also,

$$\begin{aligned} S_{SSB}^L(t) &= H_L(f) \cdot S_{DSB}(f) \\ &= H_L(f) \cdot \frac{A_c}{2} [M(f + f_c) + M(f - f_c)] \\ &= \frac{A_c}{4} [M(f + f_c) \text{sgn}(f + f_c) + M(f - f_c) \text{sgn}(f + f_c)] \\ &\quad - \frac{A_c}{4} [M(f + f_c) \text{sgn}(f - f_c) + M(f - f_c) \text{sgn}(f - f_c)] \\ &= \frac{A_c}{4} [M(f + f_c) + M(f - f_c)] \\ &\quad + \frac{A_c}{4} [M(f + f_c) \text{sgn}(f + f_c) - M(f - f_c) \text{sgn}(f - f_c)] \end{aligned}$$



To shed more light on the last equation, let us introduce the concept of the Hilbert transform.

### **Definition**

A Hilbert transform filter is a filter that simply phase shifts all frequency components by  $\pi/2$  radians, i.e., its transfer functions is described by

$$H(f) = -j \operatorname{sgn}(f)$$

where the signum function is defined by

$$\operatorname{sgn}(f) = \begin{cases} 1, & f > 0 \\ 0, & f = 0 \\ -1, & f < 0 \end{cases}$$

### Observations:

1.  $|H(f)| = 1$
2.  $\arg(H(f)) = \begin{cases} -\pi/2, & f > 0 \\ \pi/2, & f < 0 \end{cases}$

In the time domain, the impulse response of the filter is given by  $h(t) = \frac{1}{\pi t}$

Therefore, the Hilbert transform of a function  $g(t)$  can be interpreted as the convolution of the impulse response of the filter  $h(t)$  and  $g(t)$ , i.e.,

$$\begin{aligned}\tilde{g}(t) &= h(t) * g(t) \\ &= \frac{1}{\pi} \int_{-\infty}^{\infty} \frac{g(\tau)}{t - \tau} d\tau\end{aligned}$$

In the frequency domain,

$$\tilde{G}(f) = -j \operatorname{sgn}(f) G(f)$$

Therefore,

$$\tilde{g}(t) \stackrel{F}{\Leftrightarrow} -j \operatorname{sgn}(f) G(f)$$

Using the exponential modulation theorem,

$$\tilde{g}(t) e^{\pm j 2\pi f_c t} \stackrel{F}{\Leftrightarrow} -j G(f \mp f_c) \operatorname{sgn}(f \mp f_c)$$

In the time domain, we can synthesize lower SSB mathematically as follows:

$$\begin{aligned}
 s_{SSB}^L(t) &= F^{-1} \left\{ S_{SSB}^L(f) \right\} \\
 &= F^{-1} \left\{ \frac{1}{4} A_c [M(f + f_c) + M(f - f_c)] \right\} \\
 &\quad + F^{-1} \left\{ \frac{1}{4} A_c [M(f + f_c) \operatorname{sgn}(f + f_c) - M(f - f_c) \operatorname{sgn}(f - f_c)] \right\} \\
 &= \frac{1}{2} A_c m(t) \cos(2\pi f_c t) + \frac{1}{-j4} A_c \tilde{m}(t) e^{-j2\pi f_c t} - \frac{1}{-j4} A_c \tilde{m}(t) e^{j2\pi f_c t} \\
 &= \frac{1}{2} A_c m(t) \cos(2\pi f_c t) + \frac{1}{2} A_c \tilde{m}(t) \sin(2\pi f_c t)
 \end{aligned}$$

where  $\tilde{m}(t)$  is the Hilbert transform of  $m(t)$

Likewise, the upper SSB signal is described by

$$s_{SSB}^U(t) = \frac{1}{2} A_c m(t) \cos(2\pi f_c t) - \frac{1}{2} A_c \tilde{m}(t) \sin(2\pi f_c t)$$

A widely used form of SSB is vestigial sideband, which is used in TV broadcasts.

SSB is a special case of VSB, since the filter that is used to obtain SSB is a limiting case of the filter used to generate VSB.

# SINGLE SIDEBAND MODULATION

- Lower the bandwidth of modulated signal , more is the number of channels that can be accommodated in a given frequency space.
- The message signal appears twice in the DSB-SC signal , and it unnecessarily increases the bandwidth. But 1 sideband of DSB-SC signal contains the entire information.
- It is therefore desirable to transmit only one sideband and at the same time it reduces the bandwidth by half . This means we can accommodate twice number of channels in a given frequency space by using single sideband.
- Modulation of this type which provides a single sideband with suppressed carrier is known as SSB-SC system.

# Spectrum of SSB

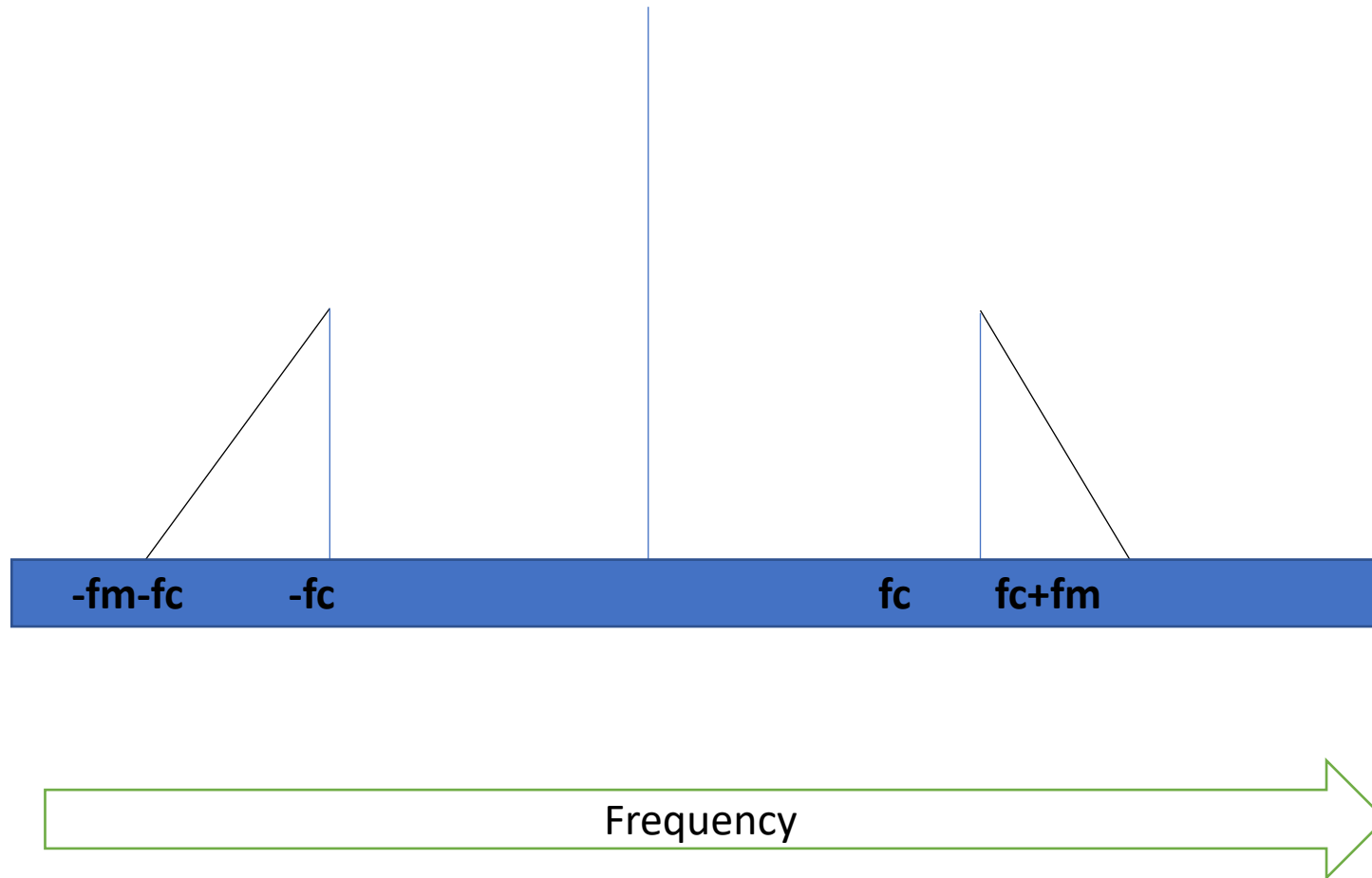

# GENERATION OF SSB-SC SIGNALS

SSB-SC waves can be generated by 2 methods:

1. frequency discrimination method or filter method
2. phase shifting method.

## 1) FILTER METHOD:

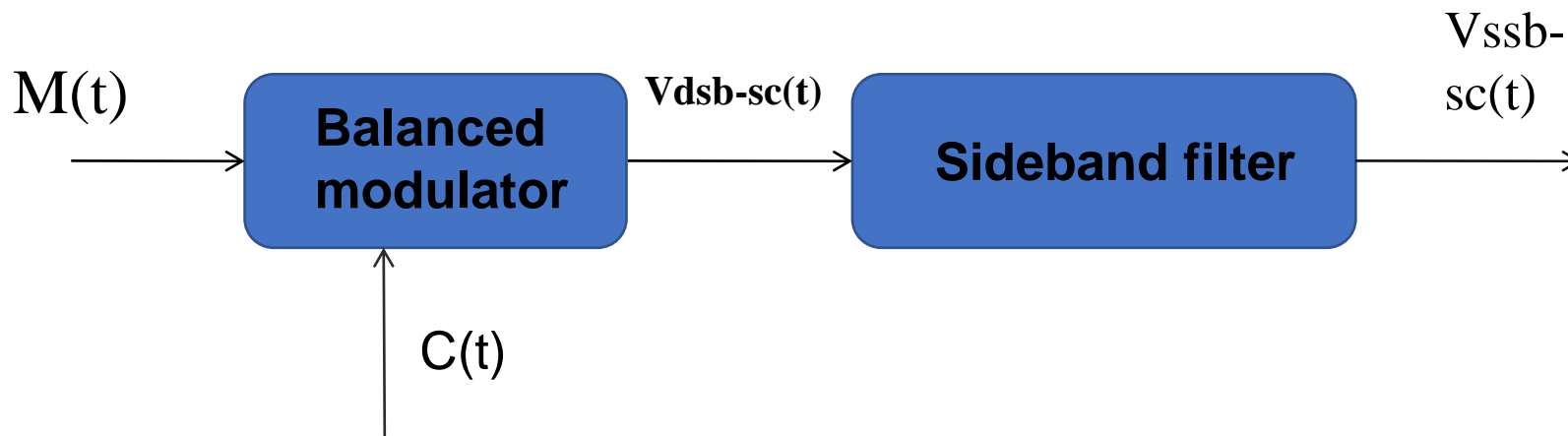

$$V_{dsb-sc}(t) = m(t) \cos \omega_c t$$

$$V_{dsb-sc}(f) = [M(f - f_c) + M(f + f_c)] / 2$$

$$V_{ssb-sc}(f) = M(f - f_c) / 2 \quad \{ \text{lower sideband} \}$$

$$V_{ssb-sc}(f) = M(f + f_c) / 2 \quad \{ \text{upper sideband} \}$$

# LIMITATIONS

- This method is useful only when the message is restricted at its lower edge, so that upper and lower sidebands are non overlapping. So filter need not have a sharp cutoff frequency.
- The baseband should be appropriately related to the carrier frequency design of band pass filter become very difficult if carrier frequency is much higher than bandwidth of signals. This problem is solved by using several frequency translation stages.



## 2. PHASE SHIFTING METHOD

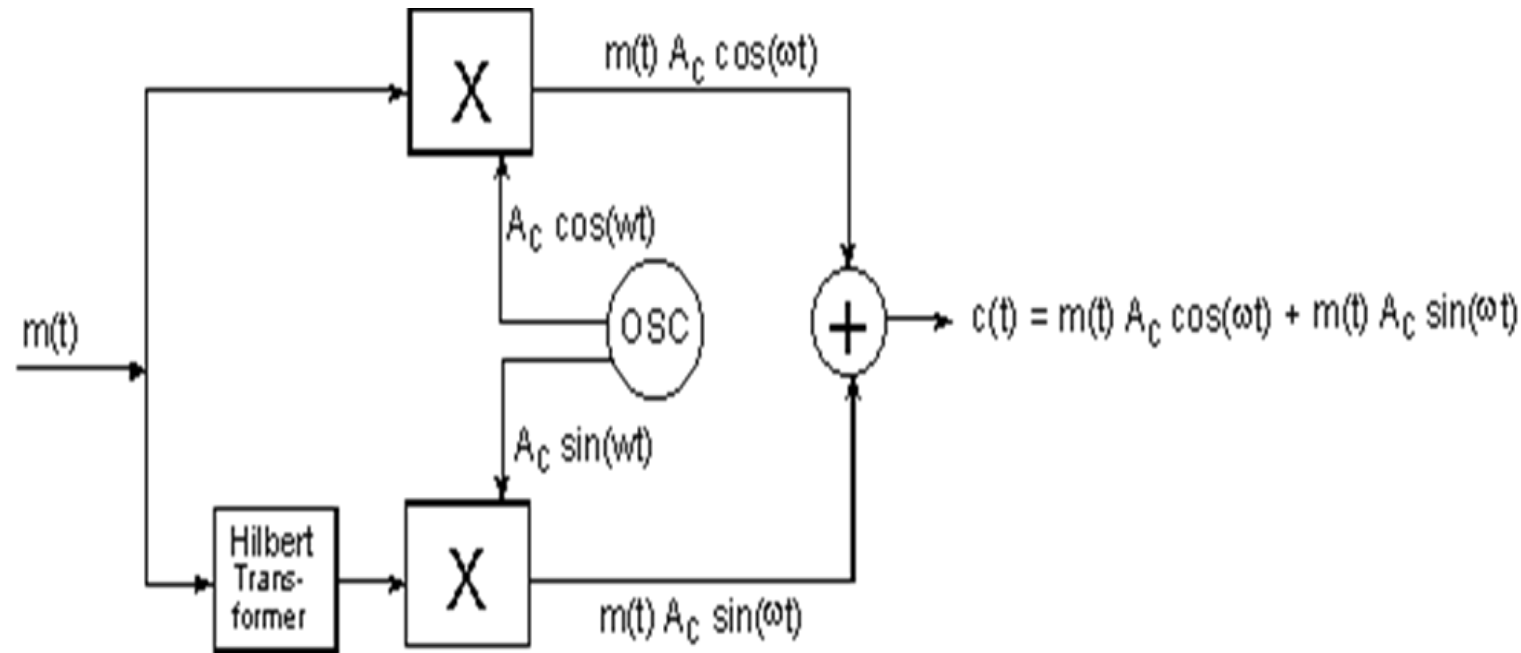

Method of generation of SSB

A lower sideband SSB-SC signal is given by the expression

$$V_{ssb}(t) = m(t) \cos \omega_c t + \hat{m}(t) \sin \omega_c t$$

# MERITS

- This method doesn't require any sharp cutoff filter.
- It is possible to generate the desired sideband in a single frequency translation step, regardless of how large the carrier frequency may be.

# DEMERITS:

- Each balanced modulator need to be carefully balanced in order to suppress the carrier.
- It is difficult to design a wideband phase shifting network needed to generate Hilbert transform of message signal.
- Each modulator should have equal sensitivity to message signal.
- The carrier phase shifting network must provide an exact 90 phase shift at carrier frequency.

# SSB DEMODULATION

- SYNCHRONOUS DEMODULATION:

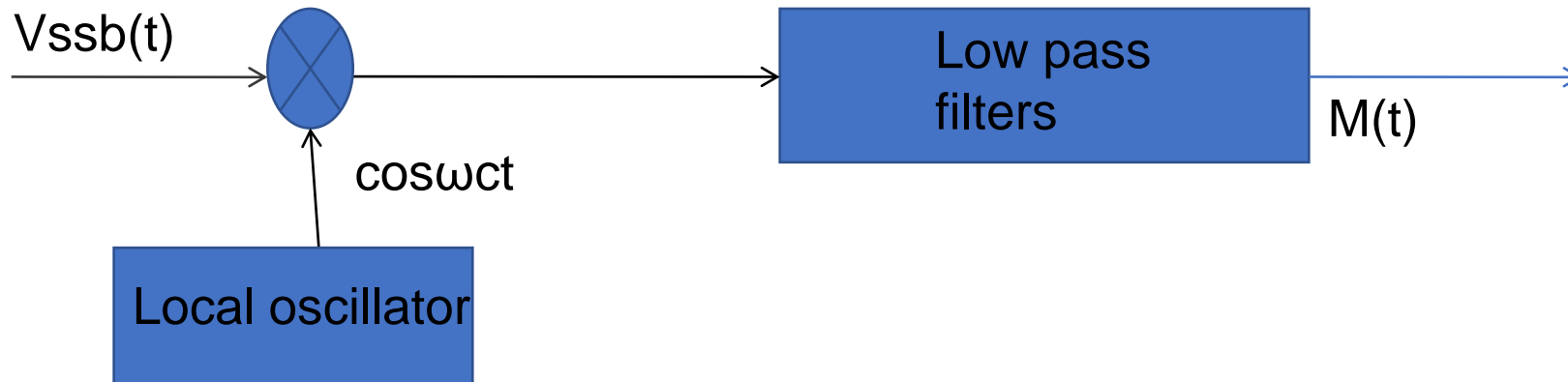

$$V_{ssb}(t) = m(t) \cos \omega_c t + m^{\wedge}(t) \sin \omega_c t$$

$$\begin{aligned} \text{Hence, } [m(t) \cos \omega_c t + m^{\wedge}(t) \sin \omega_c t] * \cos \omega_c t \\ &= m(t) \cos^2 \omega_c t + m^{\wedge}(t) \sin \omega_c t * \cos \omega_c t \\ &= m(t)/2 [1 + \cos 2\omega_c t] + m^{\wedge}(t)/2 [\sin 2\omega_c t] \\ &= m(t)/2 \\ &= m(t) \end{aligned}$$

- There is another technique called carrier –reinsertion technique in which a large carrier is introduced and an envelope detector provides the approximate baseband signal.

# SSB Advantages

- SSB occupies spectrum space only one half that of DSB signals.
- SSB transmitters can be made smaller and lighter than equivalent DSB Transmitters because of less circuitry and power are used .
- Because SSB signals occupy a narrow bandwidth ,the amount of noise in the signal is reduced .
- There is less selective fading of an SSB signal over long distances.

## DISADVANTAGES:

- Harder to modulate
- difficult to design BPF used in generation

## Generation of VSB

Instead of the ideal filter used in SSB, let us use the following filter:

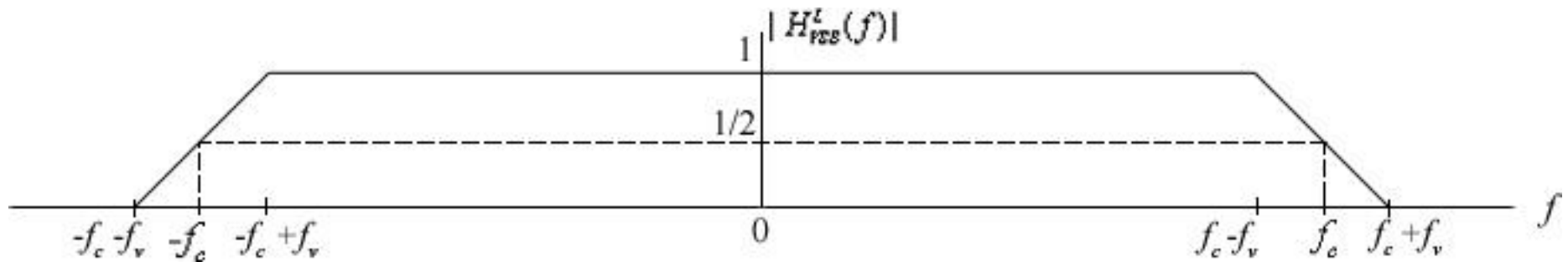

can be analytically described by  $H_{VSB}^L(f)$

$$H_{VSB}^L(f) = -j[H_Q(f + f_c) - H_Q(f - f_c)]$$

The transfer function  $H_Q(f)$  has the following characteristics:

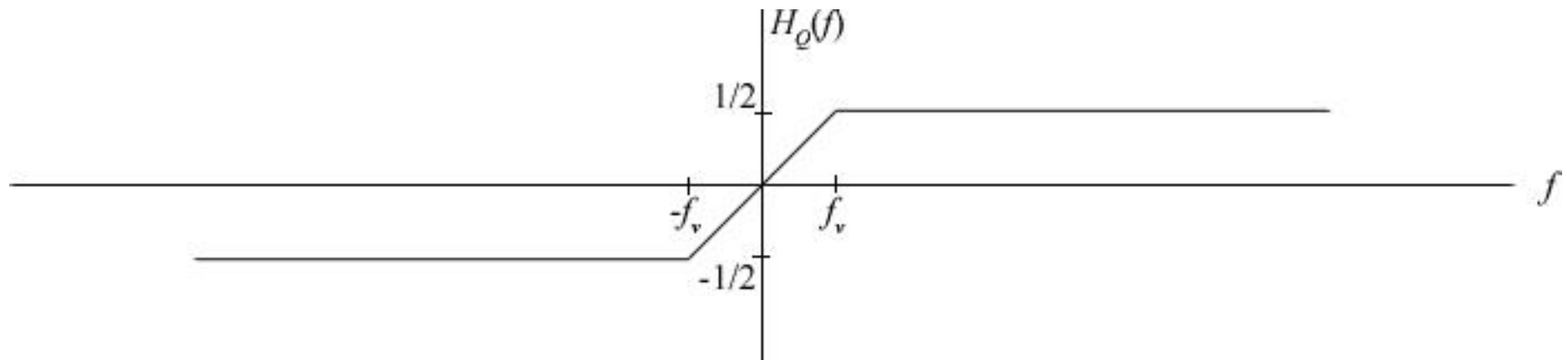

Observations about  $H_Q(f)$ :

- Odd symmetry about the origin
- Linear phase

Mathematically,

and 
$$s_{VSB}^L(t) = \frac{1}{2} A_c m(t) \cos(2\pi f_c t) + \frac{1}{2} A_c m'(t) \sin(2\pi f_c t)$$

$$s_{VSB}^U(t) = \frac{1}{2} A_c m(t) \cos(2\pi f_c t) - \frac{1}{2} A_c m'(t) \sin(2\pi f_c t)$$

The '+' sign means that a vestige of the upper sideband is transmitted and a '-' sign means that a vestige of the lower sideband is transmitted.

Example: Now, if the magnitude spectrum of the DSB signal is as described before, then the magnitude spectrum of  $s_{VSB}^L(t)$  is

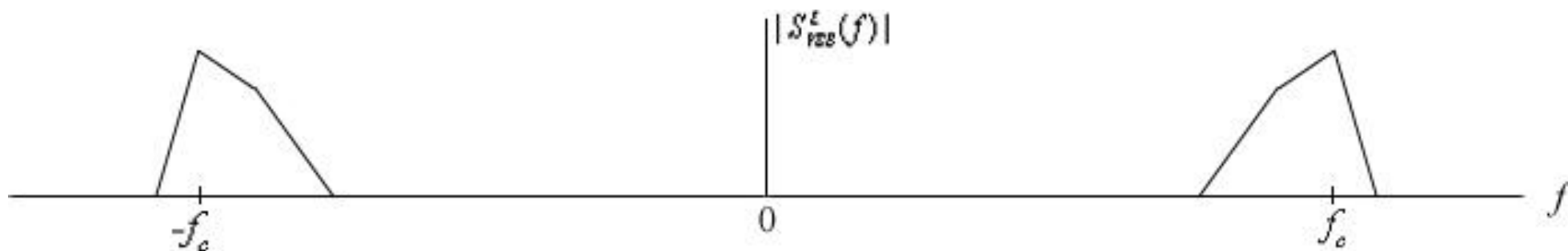

Vestigial sideband magnitude spectrum (upper sideband vestige).

To help in the demodulation process, let us insert a pilot signal to the VSB signal

$$s_{VSB}^P(t) = k_a \left[ \frac{1}{2} A_c m(t) \cos(2\pi f_c t) \pm \frac{1}{2} A_c m'(t) \sin(2\pi f_c t) \right] + A_c \cos(2\pi f_c t)$$

or

$$s_{VSB}^P(t) = A_c \left[ 1 + \frac{1}{2} k_a m(t) \right] \cos(2\pi f_c t) \pm \frac{1}{2} k_a A_c m'(t) \sin(2\pi f_c t),$$

where  $s_{VSB}^P(t) = m_I(t) \cos(2\pi f_c t) - m_Q(t) \sin(2\pi f_c t)$

$$m_I(t) = A_c \left[ 1 + \frac{1}{2} k_a m(t) \right]$$

Therefore, the complex envelope of this pilot aided VSB signal is

$$\tilde{s}_{VSB}^P(t) = m_I(t) + jm_Q(t) = a(t)e^{j\phi(t)},$$



where the real envelope  $a(t)$  is described by

$$a(t) = \sqrt{m_I^2(t) + m_Q^2(t)}$$

and its phase is

$$= \left\{ A_c^2 \left[ 1 + \frac{1}{2} k_a m(t) \right]^2 + A_c^2 \left[ \frac{1}{2} k_a m'(t) \right]^2 \right\}^{1/2}$$

$$\phi(t) = \tan^{-1} \left[ \frac{m_Q(t)}{m_I(t)} \right]$$

If we use an envelope detector to demodulate the pilot-aided VSB, its output would be

$$a(t) = A_c \left\{ \left[ 1 + \frac{1}{2} k_a m(t) \right]^2 + \left[ \frac{1}{2} k_a m'(t) \right]^2 \right\}^{1/2}$$

$$= A_c \left[ 1 + \frac{1}{2} k_a m(t) \right] \left\{ 1 + \frac{\frac{1}{2} k_a^2 m'(t)^2}{\left[ 1 + \frac{1}{2} k_a m(t) \right]^2} \right\}^{1/2}$$

Clearly, if  $m'(t)$  is small, then we can extract the message signal  $m(t)$  by using a DC blocking capacitor.

In practice,  $m'(t)$  is minimized by increasing the width of the vestigial sideband.

# Vestigial side band (vsb) modulation

- The generation of a DSB signal is much simpler, but it requires twice of the signal bandwidth.
- SSB-SC system has got the advantage over the DSB-SC system due to reduced band width. But SSB-SC signals are relatively difficult to generate due to the difficulty in isolating the desired side band. The required filter must have a sharp cut off frequency ,particularly when baseband signal is a video signal.
- This difficulty is overcome by a scheme known as **Vestigial sideband modulation** ,which is a compromise between DSB-SC and SSB-SC system.
- In this system a small portion of unwanted sideband is allowed for transmission.

# Filtering of VSB

$$g_{DSBSC}(t) = 2m(t) \cos(\omega_c t)$$

$$G_{DSBSC}(\omega) = M(\omega - \omega_c) + M(\omega + \omega_c)$$

$$G_{VSB}(\omega) = H_{VSB}(\omega) [M(\omega - \omega_c) + M(\omega + \omega_c)]$$

$$X(\omega) = H_{VSB}(\omega - \omega_c) \left[ \underbrace{M(\omega - 2\omega_c)}_{at + 2\omega_c} + \underbrace{M(\omega)}_{Baseband} \right]$$

$$+ H_{VSB}(\omega + \omega_c) \left[ \underbrace{M(\omega)}_{baseband} + \underbrace{M(\omega + 2\omega_c)}_{at - 2\omega_c} \right]$$

$$Z(\omega) = H_{LPF}(\omega) [H_{VSB}(\omega - \omega_c) + H_{VSB}(\omega + \omega_c)] M(\omega)$$

$$H_{LPF}(\omega) = \frac{1}{H_{VSB}(\omega - \omega_c) + H_{VSB}(\omega + \omega_c)} \quad ; \quad |\omega| \leq 2\pi B$$

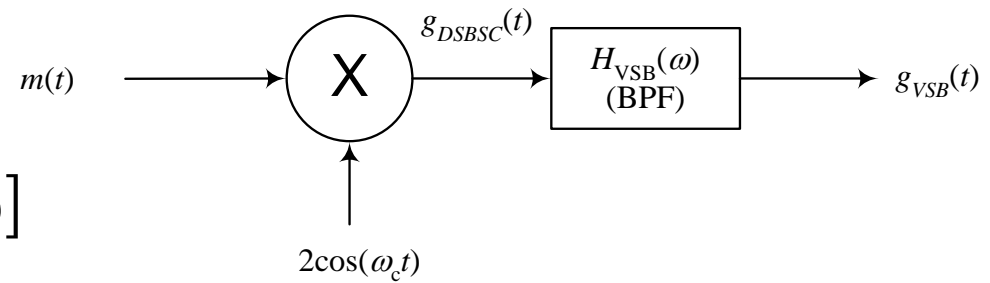

VSB Modulator (transmitter)

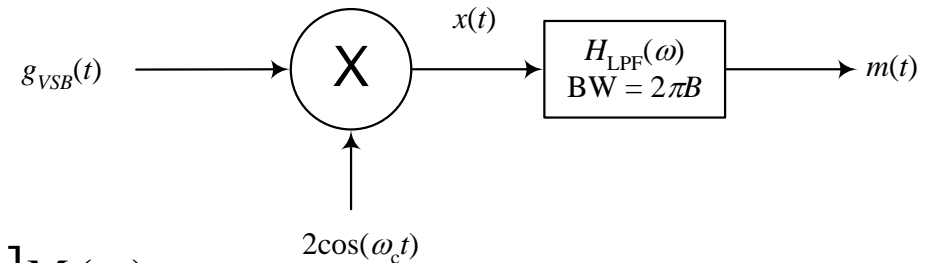

VSB Demodulator (receiver)

## Applications of VSB

- A workable compromise between the spectrum-conserving characteristic of SSB and demodulation simplicity of DSB am is found in VSB system which is standard in television broadcasting.
- The decision to leave a vestige of the nominally suppressed SB is dictated by an engg. Compromise between bandwidth economy and faithfulness of reproduction of picture.
- VSB attempts to eliminate the spectral redundancy of PAM signals.

# Frequency division multiplexing

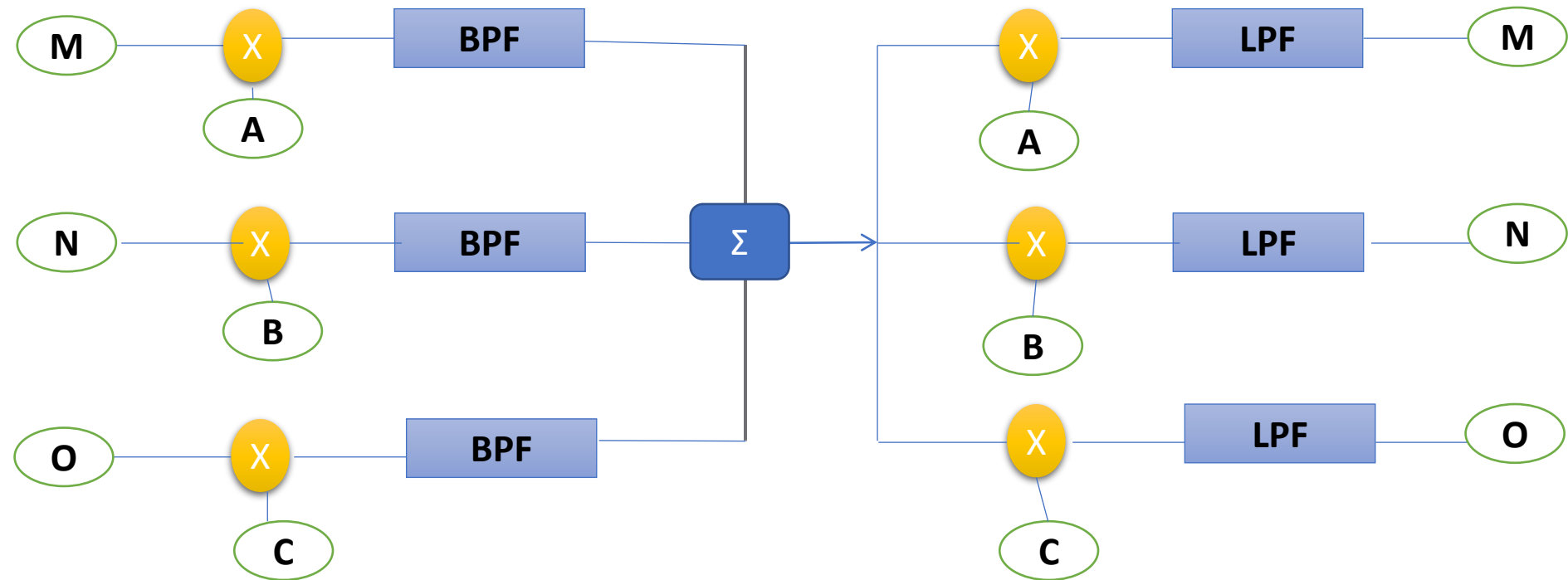

# FDM and its advantages

Frequency-division multiplexing (FDM) is a scheme in which numerous signals are combined for transmission on a single communications line or channel. Each signal is assigned a different frequency (sub-channel) within the main channel.

Each signal is modulated to a different carrier frequency. Carrier frequencies separated so signals do not overlap (guard bands). Guard band thus helps to avoid interference of message signals.

To get the same message signal at the receiver side , synchronisation should be maintained i.e same carrier signal should be multiplied in the receiver side.

Extraction of signal is possible due to guard band.



**Centurion**  
**UNIVERSITY**

*Shaping Lives...*  
*Empowering Communities...*

**THANK YOU.....**