

CHAPTER-4

BASIC CONCEPTS OF PLANNING, DESIGN AND LAYOUT OF AIRPORTS

Construction of airport is multi disciplinary project and in it involves the pooling of various engineering disciplines, agencies, experts, contractors, executives and the end users. Before entering into the real case studies of construction of runways and application of supply chain management technique it is essential to built up the concepts and the general idea about the about airport planning and construction.

Airport Planning and Design

Fundamentally, the airport is a point of connectivity in the transportation system. At the ends of a trip the airport provides for the change of mode from a ground to air mode or vice versa. As such, the airport is often analyzed using the schematic of Figure. 4.1, with the airport's *airside* consisting of approach airspace, landing aids, runways, taxiways, and aprons, all leading to the gate where the passenger (or cargo) passes through; and the airport's *landside* consisting of the areas where the passenger (or cargo) is processed for further movement on land: the arrival and departure concourses, baggage handling, curbsides, and access to parking lots, roads, and various forms of transit. Most design aspects of the airport must reflect the composite understanding of several interrelated factors. Factors include aircraft performance and size, air traffic management, demand for safe and effective operation, the effects of noise on communities, and obstacles on the airways. Various disciplines of engineering are called into use in airport planning and design.

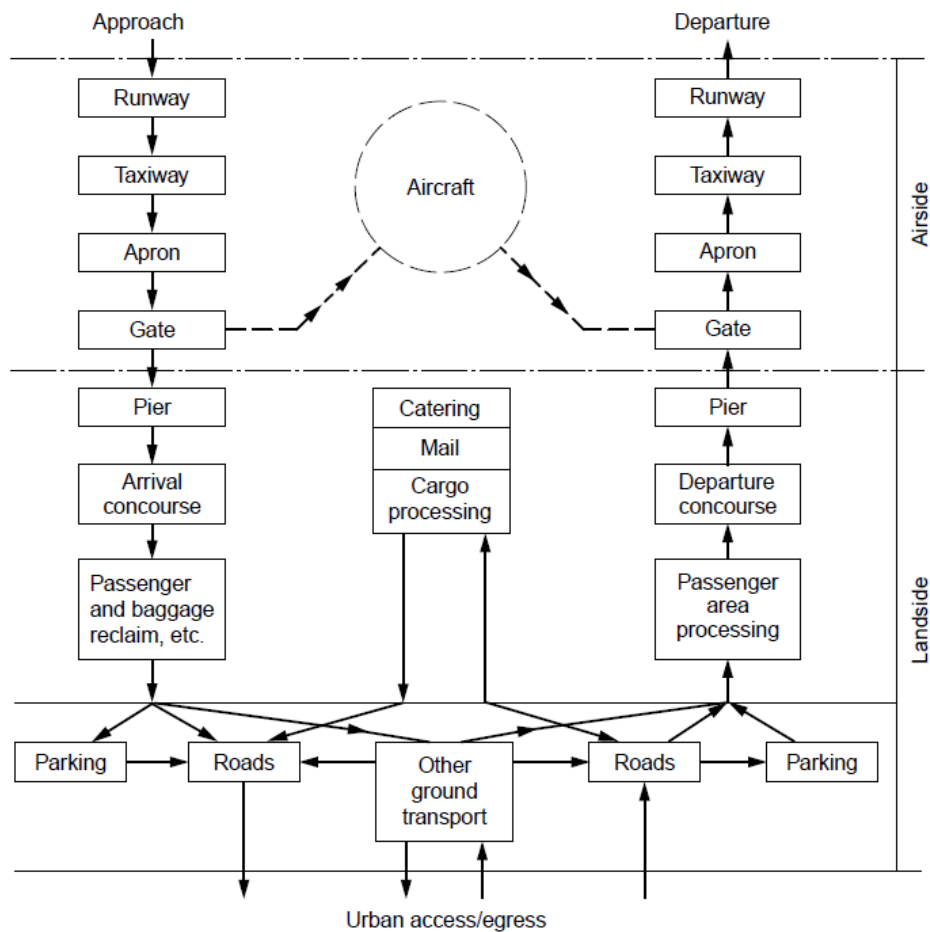

Figure:5.1 The airport system. (From Ashford, N., Stanton, H., and Moore, P., *Airport Operations*, Pitman, London, 1991.)

Airport Planning Process

Master Plan Airport

An airport master plan is a concept of the ultimate development of an airport. This plan is not simply the physical form of the airport development but a description of stage development of the entire airport area, both for aviation and non aviation demand and land use adjacent to the airport, while involving both financial implications and physical studies. The components of a typical airport system are shown in ---. The major components of the system are air side and

land side. The terminal building is the major interface between the two components. Following are the objectives of the airport master plan

- Developing the physical facilities of an airport and future land used in the vicinity of the airport.
- Establishing schedule of priorities for the implementation of the phase development and improvement proposed in the plan.
- Establishing the techno-economic and financial feasibility of the proposed development. This should include environmental concerns of the airport operations as well
- Documenting policies and future aeronautical demand with reference to spending, depth incurrence and land use control.

The salient features of ICAO guidelines for a master plan are enumerated in the Table 5.1

Table5.1: ICAO guidelines for a master plan of airport

Planning step	Description
Preplanning considerations	Coordination, planning, procedure, planning organization, goals and policy objectives.
Forecasting for planning purposes	Requirements, forecasts required accuracy, methods and principles of forecasting, factors, presentation of forecasts.
Financial arrangements and controls	Capital costs: currency requirements, source of funds, domestic and foreign financing. Operational costs: source of income, financial control and accounting
Site evaluation and selection	Land required, location of potential sites, factors affecting airport location, preliminary study of possible sites, site inspection; operational, social and cost considerations, environmental study, review of potential sites, outline plans and estimate of costs and revenues, final evaluation

Runway and Taxiways	Dimensions, strength, aircraft characteristics, performance and runways length, configuration airfields capacity.
Aprons	Layout of Aprons, size of stands, parking, service and hanger aprons, holding bays, security, apron accommodation.
Air and ground navigational and traffic control aids	Visual aids, radio navigation aids and their buildings, demarcation of critical areas, air traffic services search and resume services, apron control communications.
Passenger bulding	Planning principles, airport traffic and service characteristics, factors effecting scale of services to be supplies, capacity and demand.
Cargo facilities	Siting, building function and type, apron, facility requirement, access parking, inspection and control
Ground transport and internal airport vehicle circulation and parking	Private and public transport modes, traffic data, internal roadway circulation curbside, vehicle parking.
Airport operation and support facilities	Administration and maintenance, medical centre, ground vehicle fuel stations, generating stations, water supply and sanitation, meteorological services, air crew buildings, aircraft maintenance, rescue firefighting , general aviation facilities. Air craft fuel facilities.
Security	Air side security: roads fencing isolated parking positions, security parking area. Land side security: Passenger buildings, public storage lockers.

The individual airport master plan is the cornerstone of the continuing, comprehensive, and cooperative planning process [FAA, 1975]. The master plan reflects the complexity and size of the airport. Frequently,

the master plan is aimed at solving a specific problem, such as repairing runways, evaluating obstructions, or improving the navigation or terminal landing aids. Physical improvements such as added or extended runways, taxiways, and apron expansion are also identified in the master plan.

Airport Planning Issues and Existing Conditions

Almost every airport has some deficiency that the airport board or the community or some other airport stakeholder would like to see addressed. These issues can range from improving the capacity (and hence reducing the delay) to a desired improvement in the baggage-handling system. The study is undertaken by first identifying and gathering the issues obtained by examining prior studies and reports and by having in-depth discussions with the all concerned agencies of airport management, the air traffic controller, the airlines, and others involved in the airport use. Next, data are collected on the airport, the airspace infrastructure, and the non aviation areas of airport land use. The data consist of an inventory of the existing physical plant, including an assessment of its condition and useful life, and other relevant items, such as land use surrounding the airport, financial data on the airport operation, community social and demographic data (to aid in forecasting), operational data on the airport, meteorological data, environmental data, ground access data, and air traffic management data. To avoid collecting unnecessary data, the particular issues defined in the preplanning will help to focus the efforts.

Forecasting Airport Traffic

Planning for an airport and building a credible airport investment program require that future traffic be forecast in a thorough, sensible manner. An overly optimistic forecast may cause premature investment costs and higher-than-needed operating costs; an overly conservative forecast will promote increased congestion with high levels of delay and potentially lost revenues.

Some important factors that need to consider in the planning for a specific airport include the following:

- Unusual demographic factors existing in the community
- Geographic factors that will affect the amount of airplane use
- Changes in disposable income permitting some travelers to travel more

- Nearby airports whose operation may draw from the airport being planned
- Changes in how airlines use the airport (more hubbing, route changes, etc.)
- New local industry, meaning more jobs and more business travel
- New resort and convention industries or capacity that will bring vacation travelers

Requirements Analysis: Capacity and Delay

Armed with the demand forecasts and having developed an inventory of the airport and reviewed its condition, the planning proceeds to determine the capability of the airport to accommodate the forecast demand. First is the determination of the capacity of the airport relative to the demand, with special attention to the delay that will be incurred at peak times. Capacity is used to denote the processing capability of a facility to serve its users over some period of time. For a facility to reach its maximum capacity there must be a continuous demand for service. At most facilities such a demand would result in large delays for the user and eventually become intolerable. To develop a facility where there was virtually no delay would require facilities that could not be economically justified. The second key aspect in the requirements analysis is to assess the capability of the airport to provide the traffic controls during poor weather flying conditions (IFR) as well as during good weather conditions (VFR). Except in airspace under positive control, VFR flying is based on a “pilot beware” or “see and be seen” approach to flying. General aviation pilots flying in VFR need only a functioning radio and altimeter. Commercial aircraft and many business aircraft are equipped with beacons, radar, and other equipment that permits them to fly in instrument weather and in controlled airspace. Capability for landing on a given runway and the use of navigation aids varies from airport to airport. “In discharging its responsibility for managing the air traffic control system and in assuring flight safety, the FAA performs a number of functions which have a direct bearing on the development of the master plan” [FAA, 1985]. Of particular interest are the following:

1. Establishment of air traffic control procedures for a particular volume of terminal airspace
2. Determination of what constitutes an obstruction to air navigation.
3. Provision of electronic and visual approach and landing aids related to the landing, ground control, and takeoff at the airport

Airport Site Determination and Considerations

It is often situations within 10 miles of the airport site that will have significant bearing on the success of an airport project. The airspace and associated ground tracks along the takeoff and landing corridors are critical not only to site location, but also for runway orientation, since they define:

- Where safe landing of aircraft for over 95% of the wind conditions must occur
- Where obstacles projecting into the flight path must be eliminated
- Where houses, buildings, and recreation sites could be subjected to unacceptable levels of aircraft noise.

Siting of runways must seek to provide solutions to all three of these constraints. In addition, runways must avoid landing and takeoff paths that are over landfills and other areas that are prime bird habitats. In recognition of the severity of aircraft crashes when they occur in the vicinity of public assembly buildings, particularly schools, communities are encouraged to control the land use within 3 miles from the airport reference point (ARP), restricting the building of any such buildings [FAA, 1983a]. Other site considerations are the usual civil engineering concerns of soil condition, required grading and earthwork, wetlands, and suitable access connecting the airport with major business and industrial areas nearby.

Airside Layout and Design

Design begins with the knowledge of both the performance and physical characteristics of the aircraft that will use the airport. The approach or landing speed defines an aircraft category as A, B, C, or D. The designation of aircraft size is based on grouping aircraft according to the length of their wingspan, called *aircraft design group* (ADG), as follows:

- Group I: up to but not including 49 ft (15 meters)
- Group II: 49 ft (15 m) up to but not including 79 ft (24 m)
- Group III: 79 ft (24 m) up to but not including 118 ft (36 m)
- Group IV: 118 ft (36 m) up to but not including 171 ft (52 m)
- Group V: 171 ft (52 m) up to but not including 214 ft (65 m)
- Group VI: 214 ft (65 m) up to but not including 262 ft (80 m)

MODEL	MAXIMUM TAKEOFF WEIGHT	MAXIMUM LANDING WEIGHT	A	B	C	D	E	F	G	J	K	M	N	P	TURN RADIUS
100	160,000 LB 72,575 KG	137,500 LB 62,369 KG	1080' 32.92M	1332' 40.58M	345' 10.44M	525' 16.23M	684' 20.83M	189' 5.72M	93' 2.82M	426' 12.96M	104' 3.15M	144' 4.37M	59' 1.72M	120' 3.66M	720' 21.95M
100-C	160,000 LB 72,575 KG	137,500 LB 62,369 KG	1080' 32.92M	1332' 40.58M	345' 10.44M	525' 16.23M	684' 20.83M	189' 5.72M	93' 2.82M	426' 12.96M	104' 3.15M	144' 4.37M	59' 1.72M	120' 3.66M	720' 21.95M
200	172,000 LB 78,018 KG	150,000 LB 68,039 KG	1080' 32.92M	1522' 46.68M	341.1' 10.45M	625' 19.28M	784' 23.89M	189' 5.72M	93' 2.82M	426' 12.96M	104' 3.15M	169.1' 5.16M	49' 1.44M	120' 3.66M	820' 24.99M

NOTE: OPTIONAL TAKEOFF AND LANDING WEIGHTS:

100	160,000 LB (72,575 KG)	142,500 LB (64,637 KG)	168,000 LB (76,657 KG)	142,500 LB (64,637 KG)	MAXIMUM TAKEOFF WEIGHT	MAXIMUM LANDING WEIGHT
100C	160,000 LB (72,575 KG)	140,000 LB (63,503 KG)	168,000 LB (76,657 KG)	142,500 LB (64,637 KG)	MAXIMUM TAKEOFF WEIGHT	MAXIMUM LANDING WEIGHT
200	184,800 LB (83,824 KG)	154,500 LB (70,080 KG)	180,500 LB (81,409 KG)	154,500 LB (70,080 KG)	197,000 LB (89,358 KG)	161,000 LB (73,028 KG)

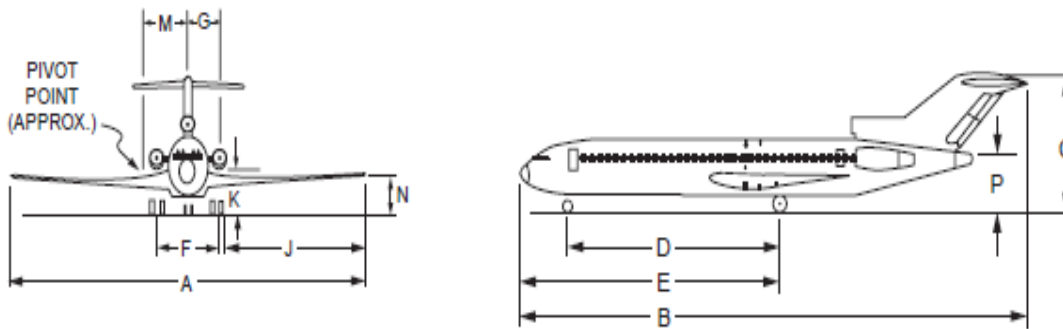

Figure:5.2 Sample aircraft dimensions (Boeing 727) for airport design. (From FAA, *Airport Design*, Advisory Circular AC150/5300-13, change 1, 1991c.)

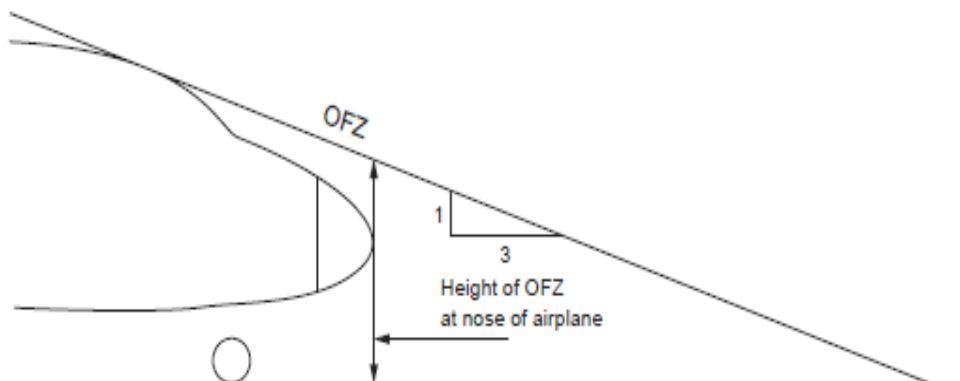

Figure:5.3 Object-free zone requirements as viewed from the cockpit. (From FAA, *Airport Design*, Advisory Circular AC150/5300-13, change 1, 1991c.)

The important physical characteristics of the aircraft affecting airport design are maximum takeoff weight (W), wingspan (A), length (B), tail height (C), wheel base (D), nose to centerline of main gear (E), undercarriage width (1.15 \times main gear track, F), and line-of-sight/obstacle-free zone at the nose of the aircraft. For reference, these are presented for the Boeing 727 in Fig. 5.2 . Figure 5.3 displays a major problem faced by aircraft as they land and travel on the runway, taxiway, or taxi-lane system. The pilot's view of the ground directly in front of the aircraft is obscured by the nose. This blind zone for the pilot is known as the object-free zone (OFZ) and is important for safe ground movement of aircraft. It affects the geometric design of the runway and taxiway.

Runway Length

The length of the runway is determined by the aircraft, maximum takeoff weights, engine capabilities, landing and braking capabilities, flap settings, and required safety factors. For example, the runway length for landing must be capable of permitting safe braking if touchdown occurs one third the length of the runway past the threshold. The runway must also be long enough to meet the obstacle-free capability to permit each aircraft to take off with one engine out. The stopping zone must include ample stopping distance in case the pilot chooses to abort takeoff just before rotating to become airborne (called stopway). As discussed, the runway safety areas are a must for airport control. Figure 5.4 shows the stopway, to prevent accidents at the end of the runway, and the clearway, also called the runway protection zone. The altitude of the airport and the temperature also have a significant impact on the airport runway length, because lift capability is proportional to the air density, which diminishes as the altitude and temperature increase. Figure 5.5 illustrates how dramatic that change is for a Boeing 727-200 with a JT8D-15 engine, a takeoff weight of 150,000 pounds, and its wing flaps set at 20 degrees. The requirement for longer runways increases significantly as the altitude of the site above sea level increases. At an average temperature of 65 degrees Fahrenheit, the increase is from 4900 feet at sea level to 8660 feet at an altitude of 8000 feet, or about 370 feet

of added runway for each 1000-foot increase in altitude.

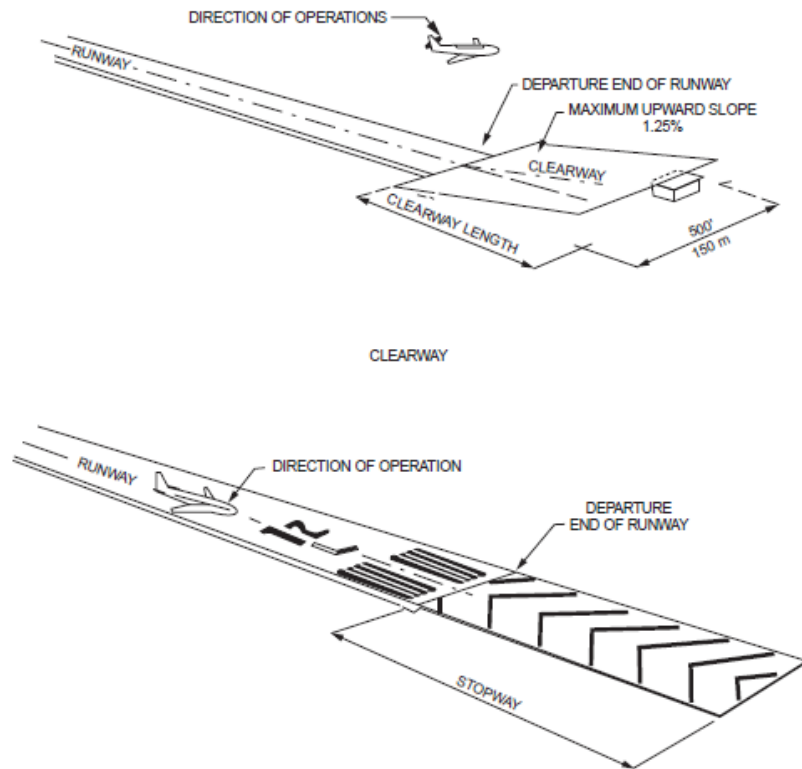

Figure 5.4 View of the clearway and stopway. (From FAA, *Airport Design*, Advisory Circular AC150/5300-change 1, 1991c.)

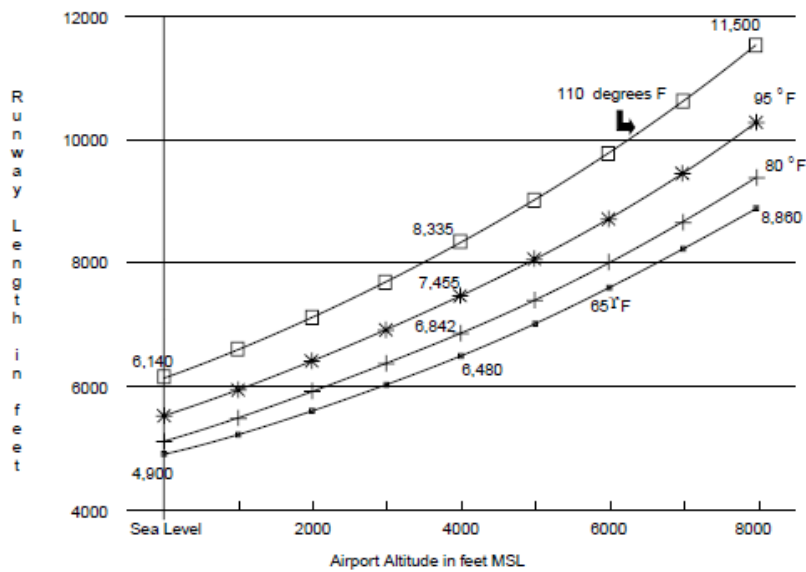

Figure 5.5 Change of required takeoff runway length due to temperature and altitude.

Runway and Taxiway Width and Clearance Design Standards

The FAA has developed a set of standard dimensions that determine runway width, separations between runways and taxiways, safety areas around runways and taxiways, shoulder width (possible areas of less-than- full-strength pavement), pads to deflect jet blast, object-free areas, and the like. These standards are a function of approach speed and aircraft size. Figure 5.6 presents the overall dimensions that are involved in parallel runways and taxiways. Figure 5.7 shows the plan view of major runway parabolic vertical curves are used for geometric design, as shown in Fig. 5.8

Runway Gradients

Longitudinal Gradient

The desire at any airport site is to have the runways and taxiways as level as possible, allowing for drainage with the design of the transverse grade. In many locations the grading for a perfectly level site would be too expensive when most aircraft can easily accept 1% grade. Where longitudinal grades are used, parabolic vertical curves are used for geometric design, as shown in Fig. 5.8. The penalty for gradients is to reduce the effective runway length by *10 feet per foot of difference between maximum and minimum elevation of the runway* [FAA, 1992]. and the lowest point along the runway of 70 feet, the effective runway length for MATOW calculations would be 9500 (10,200 – 70 × 10) feet.

Line of Sight

The line-of-sight requirements also determine the acceptable profile of the runway. Any two points 5 feet above the runway centerline must be mutually visible for the entire runway or if on a parallel runway or taxiway for one half of the runway. Likewise, there needs to be a clear line of sight at the intersection of two runways, two taxiways, and taxiways that cross an active runway. Most line-of-sight requirements are within 800 to 1350 feet of the intersection, depending on the configuration.

Transverse Gradients

The transverse gradients are important to ensure adequate drainage from the runways and the taxiways. The plan view shown in Fig. 5.7 indicates the typical gradients that are included in

runways and taxiways. The chief concern is drainage and the line of sight to adjacent runways or taxiways.

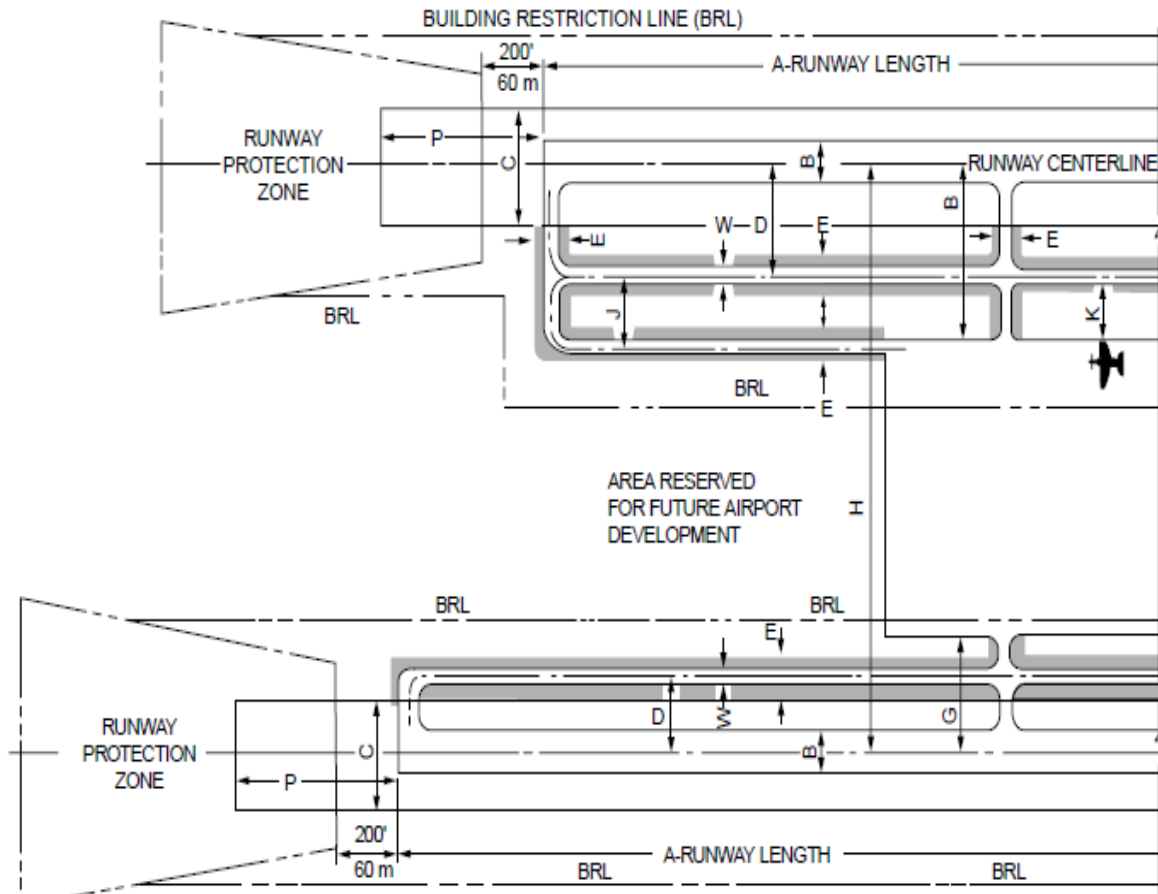

- NOTES: 1. DIMENSION LETTERS ARE KEYED TO TABLES 2-1, 2, 3, 5; 3-1,2,3; 4-1
 2. SHADED AREA SURROUNDING TAXIWAYS DELINEATES THE LIMITS OF THE TAXIWAY SAFETY AREA.
 3. PREFERRED LOCATION FOR BUILDING AND AIRPLANE PARKING AREA IS MIDPOINT OF RUNWAY. THE SIZE AND SHAPE ARE VARIABLE AS REQUIRED.

FIGURE 5.6 Runway and taxiway dimensions. (From FAA, *Airport Design*, Advisory Circular AC150/5300-13, change 1, 1991c)

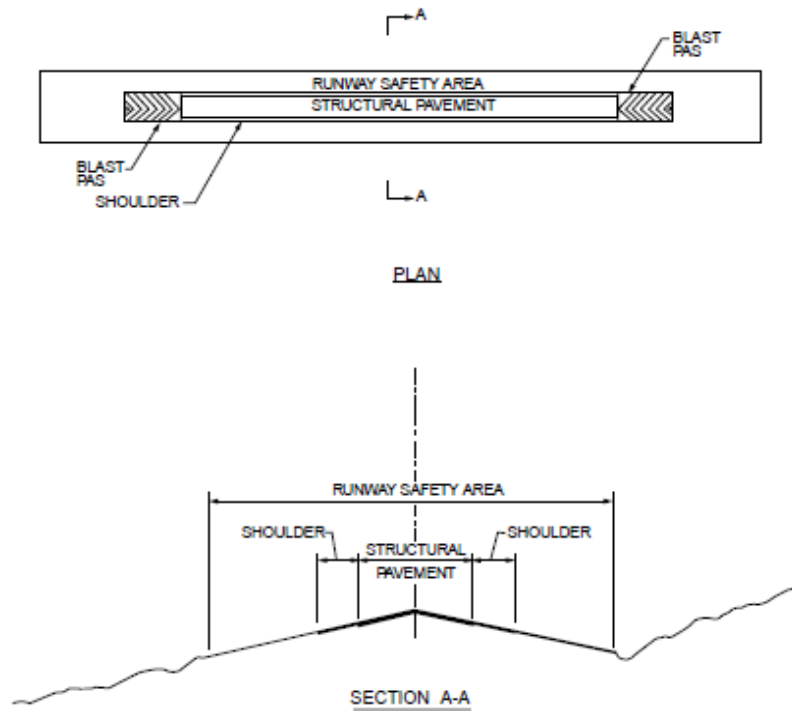
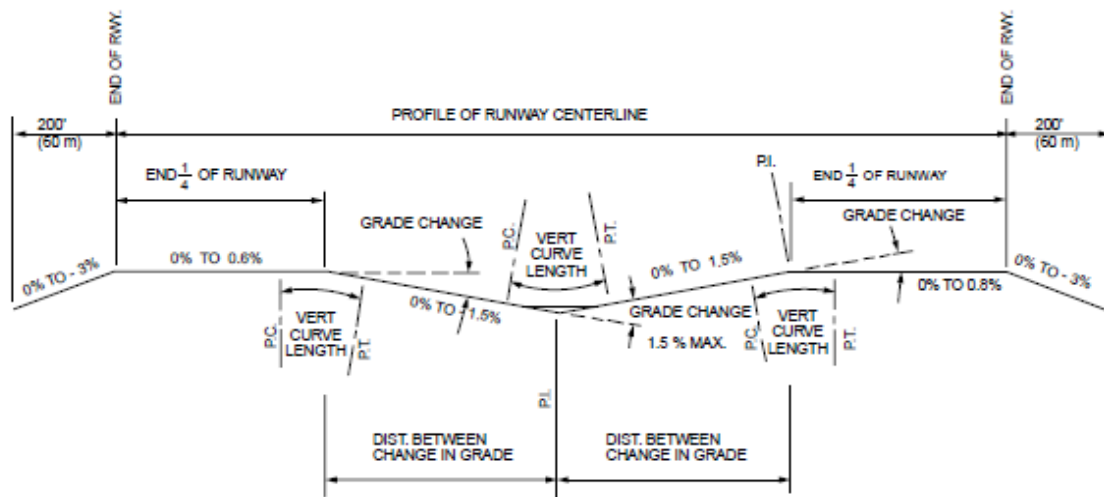

Figure 5.7 Plan and cross section view of the runway elements. (From FAA, *Airport Design*, Advisory Circular AC150/5300-13, change 1, 1991c.)



MINIMUM DISTANCE BETWEEN CHANGE IN GRADE = 1000' (300 m) x SUM OF GRADE CHANGES (IN PERCENT).

MINIMUM LENGTH OF VERTICAL CURVES = 1000' (300 m) x GRADE CHANGE (IN PERCENT)

Figure 5.8 Longitudinal grade criteria for airports (C and D approach criteria). (From FAA, *Airport Design*, Advisory Circular AC150/5300-13, change 1, 1991c.)

Drainage

Drainage on the airport surface is a prime requisite for operational safety and pavement durability. The drainage design is handled like most drainage for streets and highways. Avoidance of ponding and erosion of slopes that would weaken pavement foundations is critical for design. Because of the need for quick and total water removal over the vast, relatively flat airport surface, an integrated drainage system is a must. Runoff is removed from the airport by means of surface gradients, ditches, inlets, an underground system of pipes, and retention ponds. [Figure 5.9](#) shows one portion of an airport drainage system. Because of their large contiguous area, aprons are critical and must have an adequate sewer system. Runoff water treatment is required when there are fuel spills or during the winter, when a deicing chemical is used.

Airport Lighting and Signing

Runway

Lighting and signing of the runway shown in [Fig. 5.10](#) provide the pilot visual cues to ensure alignment with the runway, lateral displacement, and distance along the runway. Runway edge lights standing no more than 30 inches and no more than 10 ft from the runway edge are 200 ft or less apart and are white, except for the last 2000 ft of runway, when they show yellow. Centerline lights are white and set 2 ft off the centerline of the runway, except for the last 3000 ft. In this area they are alternating red and white for 2000 ft, and they are red 1000 ft from the runway end. When aircraft are approaching the runway to land, the pilot determines the threshold because it is marked by a bar of green lights. However, those lights show red when aircraft approach the end of the runway from the other direction. As shown in [Fig. 5.11](#) painted markings also indicate where the aircraft is relative to distance past the threshold. Exits, particularly high-speed exits, are clearly marked by signs placed at a distance of 1200 to 1500 ft before the exit.

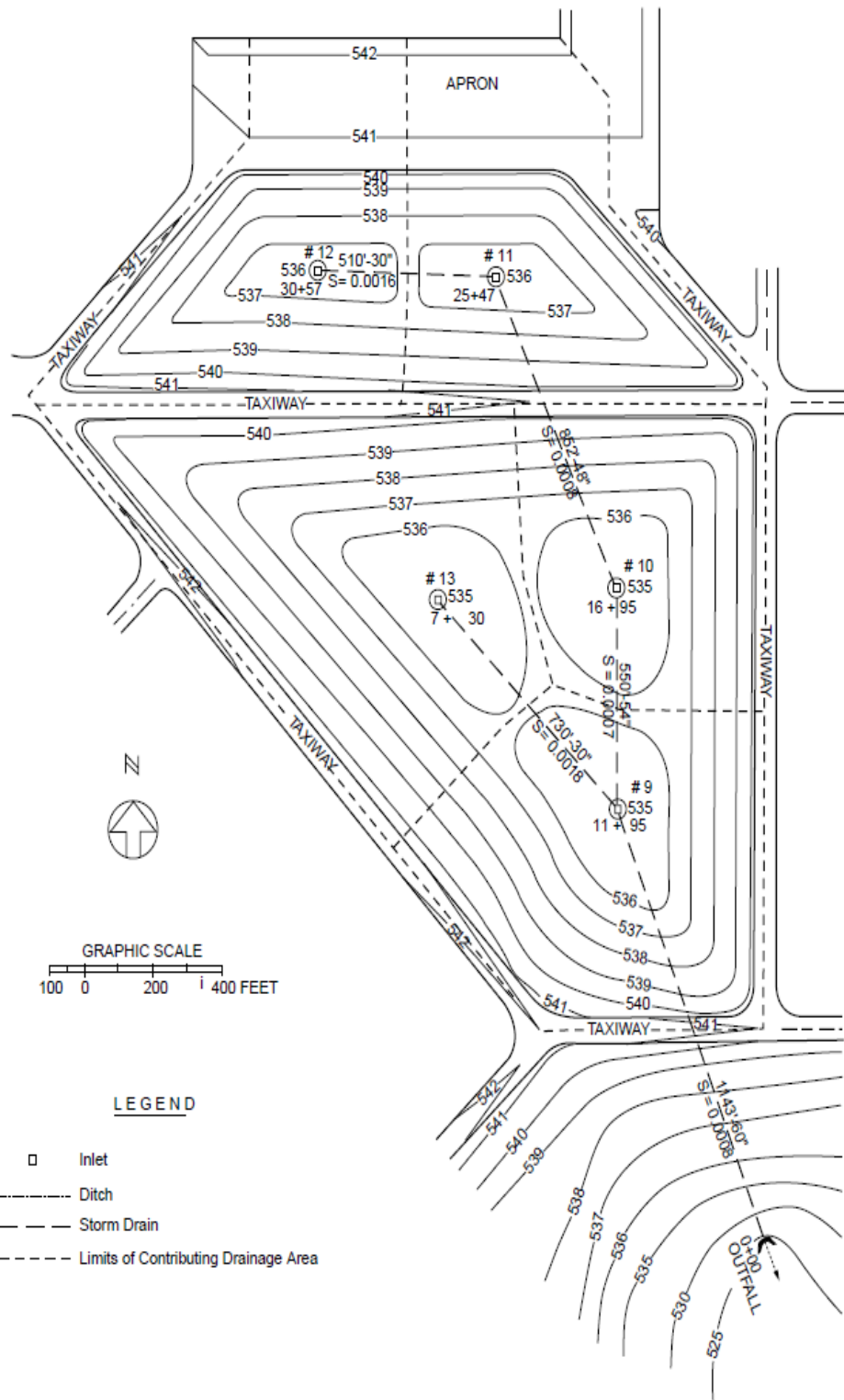

FIGURE 5.9 Portion of an airport showing drainage design. (From FAA, *Airport Drainage*, Advisory Circular AC150/5320-5B, 1970.)

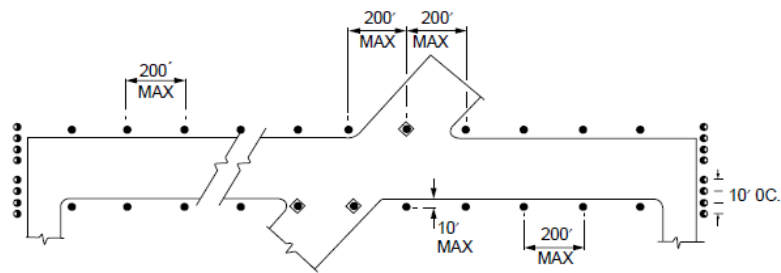
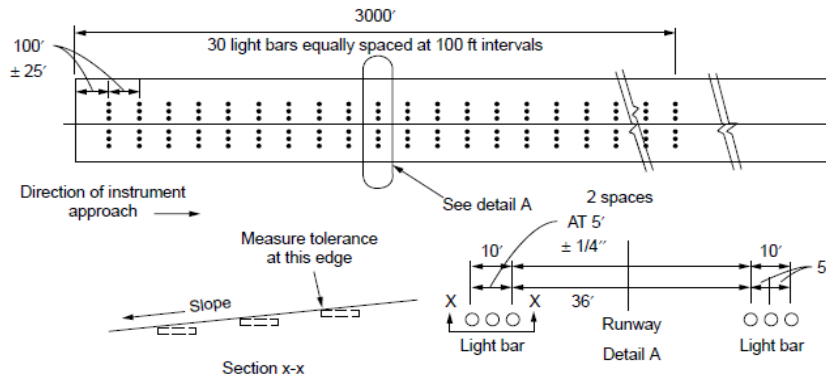

Figure 5.10 Runway lighting. (From FAA, *Standards for Airport Markings*, Advisory Circular AC150/5340-IG, 1993c.)

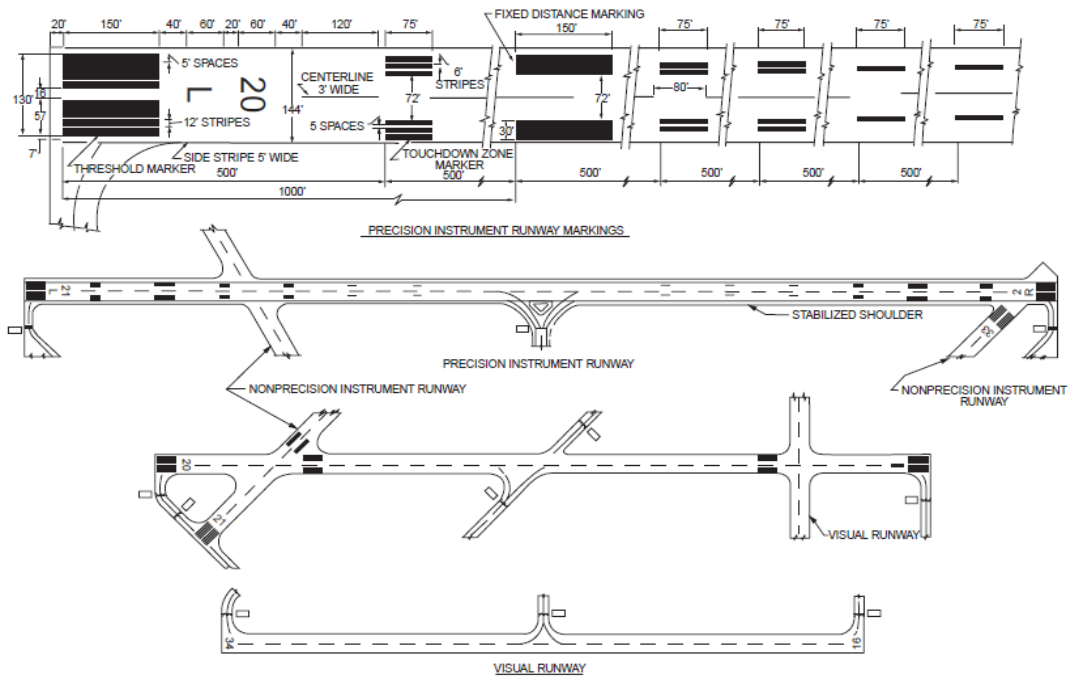

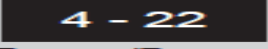
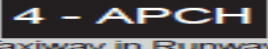

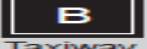
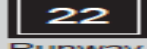
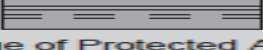

Figure 5.11 Marking along the runway. (From FAA, *Standards for Airport Markings*, Advisory Circular AC150/5340-IG, 1993c.)

Airfield

The airfield is marked with a variety of signs delineating the taxiways, stoplines, holding areas, and the like. Blue lights indicate taxiway edges. Stop bars before crossing or entering an active runway are yellow. There have been a number of accidents and near accidents on the ground, especially when the visibility is low. The FAA is experimenting with a new lighted stop bar. The controller controls the lights. When the bar is lit there are now center lights ahead, creating a black hole effect. Once the aircraft is permitted on the runway, the light bar is extinguished and the taxiway/runway lights are illuminated to guide the pilot onto the runway for takeoff [FAA, 1993b]. Typical airfield markings give the pilot directions to the ramp, parking areas, fuel, gates, areas for itinerant aircraft, ramps for military aircraft, cargo terminals, international terminals, and other airside functions. Visual cues also aid the pilot in docking the aircraft at the gate. Generally there is also an airline ground employee with handheld signal lights to direct the pilot as the aircraft pulls into the gate. [Figure 5.12](#) shows the FAA's 1993 guide to airfield signs.

GUIDE TO AIRFIELD SIGNS (U.S.)	
SIGN and LOCATION	PILOT ACTION or SIGN PURPOSE
 4 - 22 On Taxiways at Intersection with a Runway	Controlled Airport - Hold unless ATC clearance has been received. Uncontrolled Airport - Proceed when no traffic conflict exists.
 4 - 22 Runway/Runway Intersection	Taxing - Same action as above. Taking Off or Landing - Disregard unless a "Land, Hold Short" clearance has been accepted.
*  4 - APCH Taxiway in Runway Approach or Departure Area	Controlled Airport - Hold when instructed by ATC. Uncontrolled Airport - Proceed when no traffic conflict exists.
*  ILS ILS Critical Area	Hold when approaches are being made with visibility less than 2 miles or ceiling less than 800 feet.
 Areas where Aircraft are Forbidden to Enter	Do not enter.
 B Taxiway	Identifies taxiway on which aircraft is positioned.
 22 Runway	Identifies runway on which aircraft is positioned.
*  Edge of Protected Area for Runway	These signs are used on controlled airports to identify the boundary of the runway protected area. It is intended that pilots exiting this area would use this sign as a guide to judge when the aircraft is clear of the protected area.

Notes:
 1. See the *Airman's Information Manual* for additional information on airfield signs.
 2. The signs shown on this guide comply with FAA standards. In some cases ICAO's proposed sign standards differ with FAA's. The asterisk (*) in the left column denotes these cases so the pilot can be aware that some differences may be encountered outside the United States.

FIGURE 5.12 Guide to airfield signs. (From FAA, *Standards for Airport Markings*, Advisory Circular AC150/5340-IG, 1993c.)

Approach to the Runway

The approach lighting system (ALS) dictates the navigation and approach capability. Light bars may extend as much as 3000 feet from the threshold along the aircraft's desired glide path. Lighting systems are available to provide runway glide slope cues indicating whether the pilot is above, below, right, or left of the hypothetical wire representing the proper descent trajectory. The visual approach slope indicator systems (VASIS) provide at the side of the runway red and white light bars. The precision approach path indicator (PAPI) system provides upper and lower lights of red and white that in various combinations indicate whether the pilot is too low or too high. For example, an all-white bar indicates the aircraft is on a glide slope greater than 3.5 degrees, while an all-red bar is less than 2.5 degrees. Equal red and white indicates the aircraft is on the 3-degree glide slope. Positioning along the glide path is accomplished by the use of light bars extending from the runway along the flight path. There are several different approach lighting systems, as suggested in [Fig. 5.13](#) For precision approaches (category I, II, or III) ILS, the high-intensity approach lighting system with sequenced flashing lights (ALSF) is employed. The ALS consists of light bars 3000 ft from the threshold. From 3000 to 1000 ft the lights are a sequenced flasher that gives the appearance of a rolling ball leading to the runway centerline. From 1000 ft (inner marker) to the threshold there are white light bars in the center and bars of red lights on either side of the centerline spaced 100 ft apart. An extra light bar is placed at 500 ft to provide an added visual cue.

Runway Pavement Design

Pavement design methods are based on the gross weight of the aircraft. Since it is impracticable to develop design curves for each type of aircraft, composite aircraft are determined and loads are converted from the actual aircraft to the design aircraft, the design aircraft being the one that requires the greatest thickness of pavement. The traffic forecast, which includes the mix of aircraft anticipated, is converted to a traffic forecast of equivalent annual departures. FAA Advisory Circular AC150/5320-6C CHG 2 [1978] presents a number of curves to be used to design the pavement thickness for both flexible and rigid pavements.

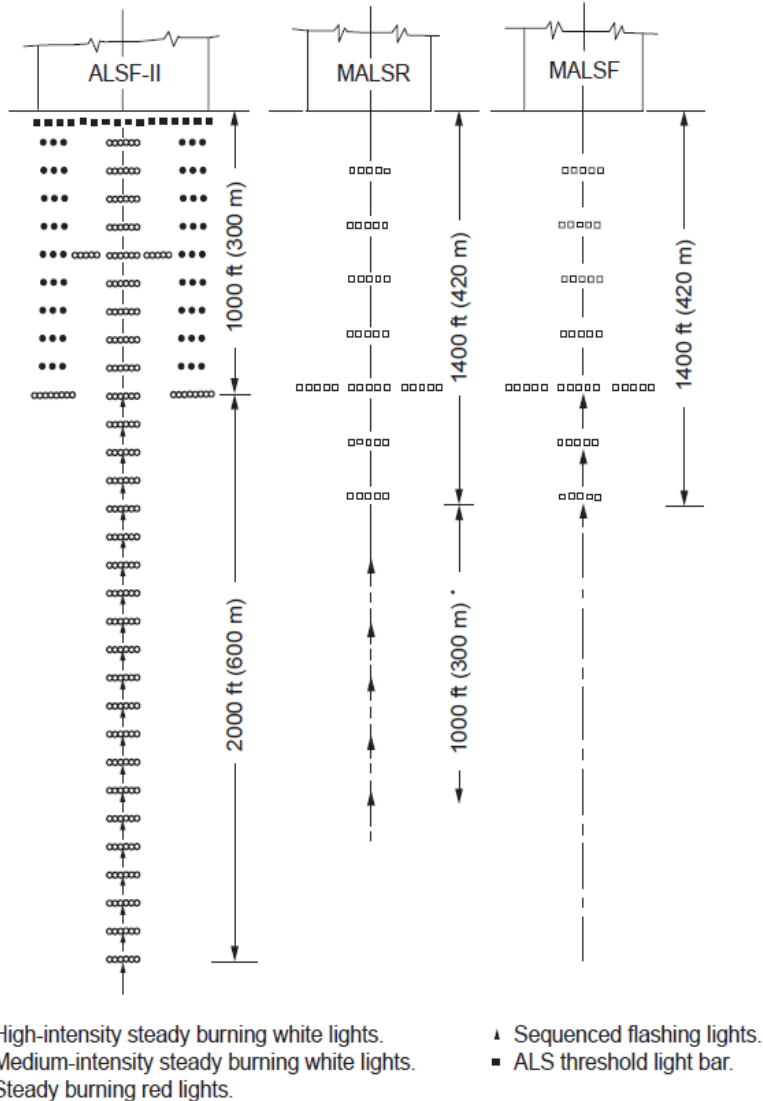

Figure 5.13 FAA approach light systems. (From FAA, *Standards for Airport Markings*, Advisory Circular AC150/5340-IG, 1993c.)

Airport Plans

Upon completion of the inventory, forecasting, requirements analysis, and site evaluation, the master planning proceeds to the synthesis of airside and landside concepts and plans. These include an airport layout plan and an approach and clear zone plan. Other plans could include the site plan, the access plan, and the environmental plan.

Airport Layout Plan

The airport layout plan is a graphic representation to scale of existing and future airport facilities on the airport. An example is presented in [Fig. 5.14](#) It will serve as the airport's public document, giving aeronautical requirements as well as pertinent clearance and dimensional data and relationships with the external area. The airfield configuration of runways, taxiways, aprons, and the terminal are shown schematically.

Approach and Runway Clear Zone Plan

The approach and clear zone drawing permits the planner to determine how the airport will interface with the surrounding area in terms of safe flight. An example is presented in [Fig. 5.15](#) It includes:

- Area under the imaginary surfaces defined in U.S. Code FAR, Part 77 [1975]
- Existing and ultimate approach slopes or slope protection established by local ordinance
- Runway clear zones and approach zones showing controlling objects in the airspace
- Obstructions that exceed the criteria
- Tall smokestacks, television towers, garbage dumps, landfills, or other bird habitats that could pose a hazard to flight

Other Plans

Terminal Area Plan

The terminal area plan usually consists of a conceptual drawing showing the general plan for the terminal, including its possible expansion. Under some changes the terminal modification will have a major impact on the taxiway and apron and will be reflected in an altered ALP.

Noise Compatibility Plan

Using future airport traffic, noise contours should be generated to identify future impacts of noise in the community. The plan would include alternative takeoff tracks and operational constraints. It would also identify buildings and other facilities that might potentially need to be moved or soundproofed.

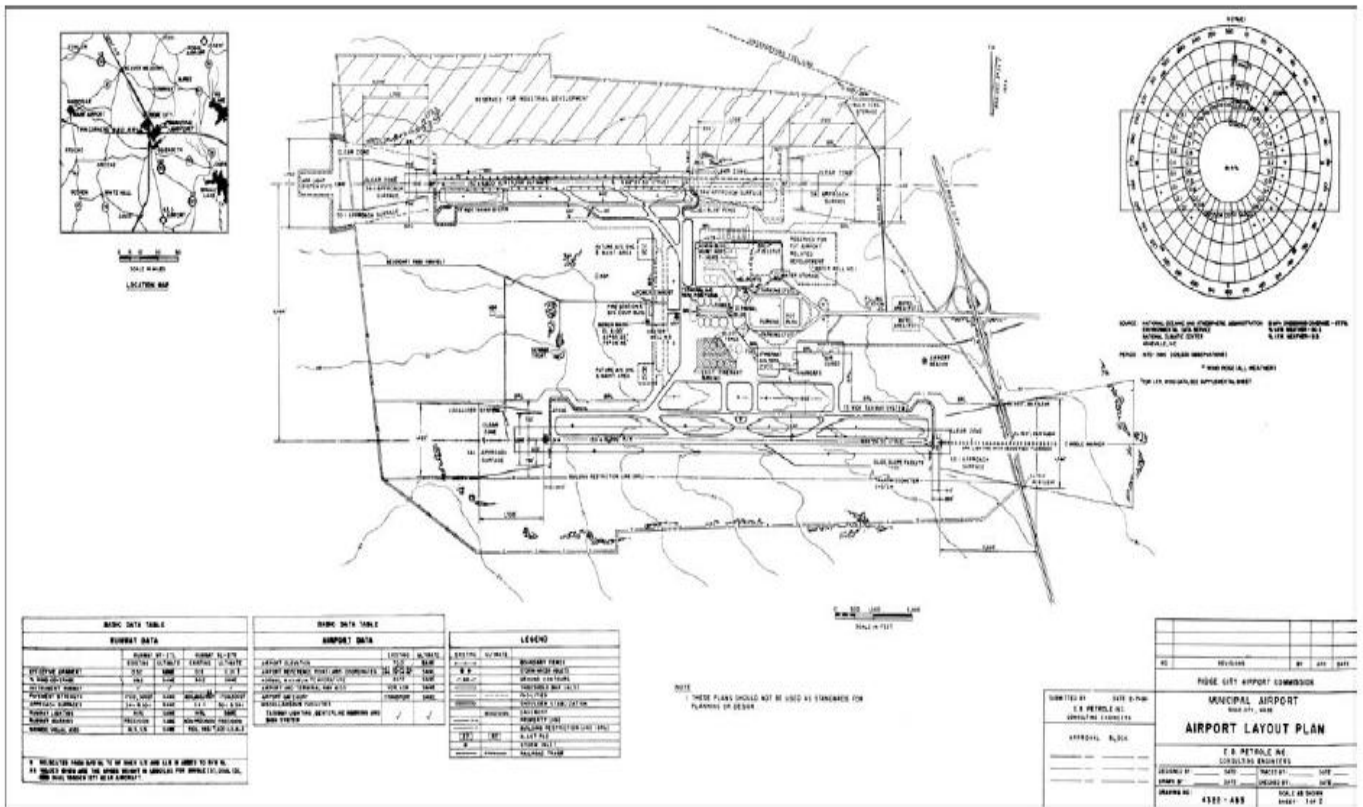

Figure.5.14

Sample airport layout plan. (From FAA, *Airport Master Plans*, Advisory Circular AC150/5070-6A, 1985.)

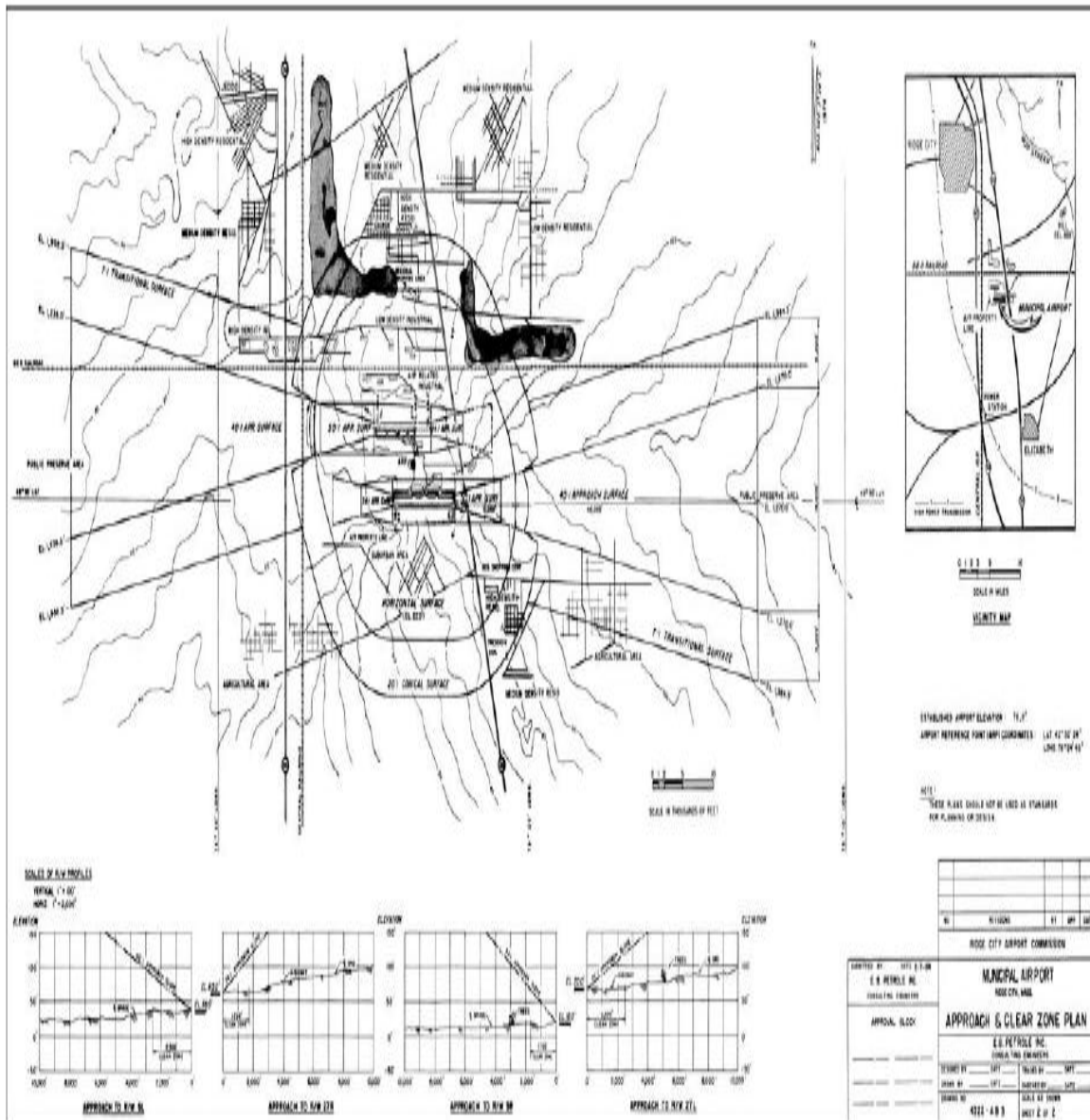

Figure 5.15 Sample runway and approach plan. (From FAA, *Airport Master Plans*, Advisory Circular AC150/5070-6A, 1985.)

