

# COMPONENTS OF AIRPLANE

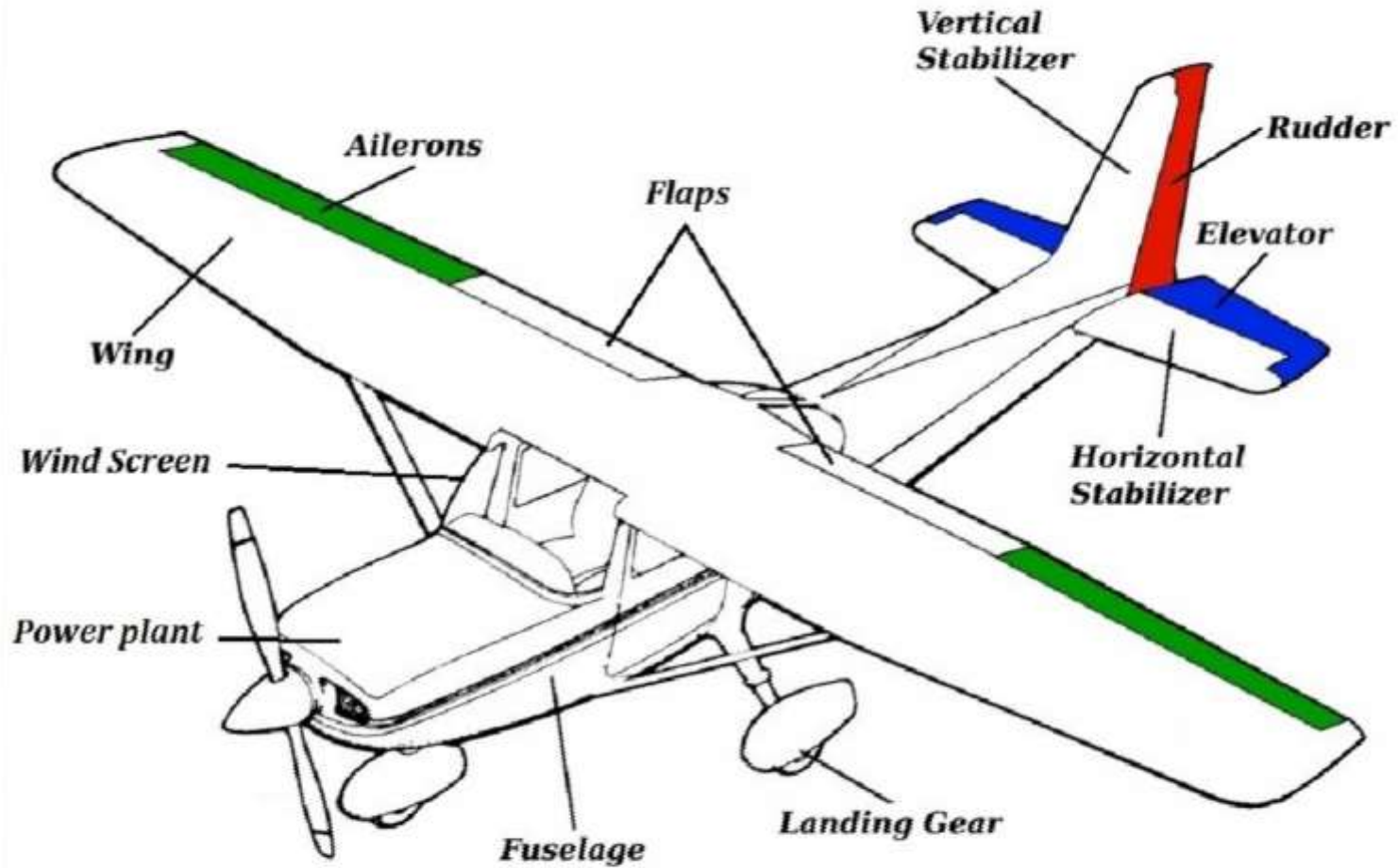

Sangram Samal

# PARTS OF A CONVENTIONAL AIRPLANE



# EXPLODED VIEW OF BEECHCRAFT

An exploded view of a Beechcraft Skipper

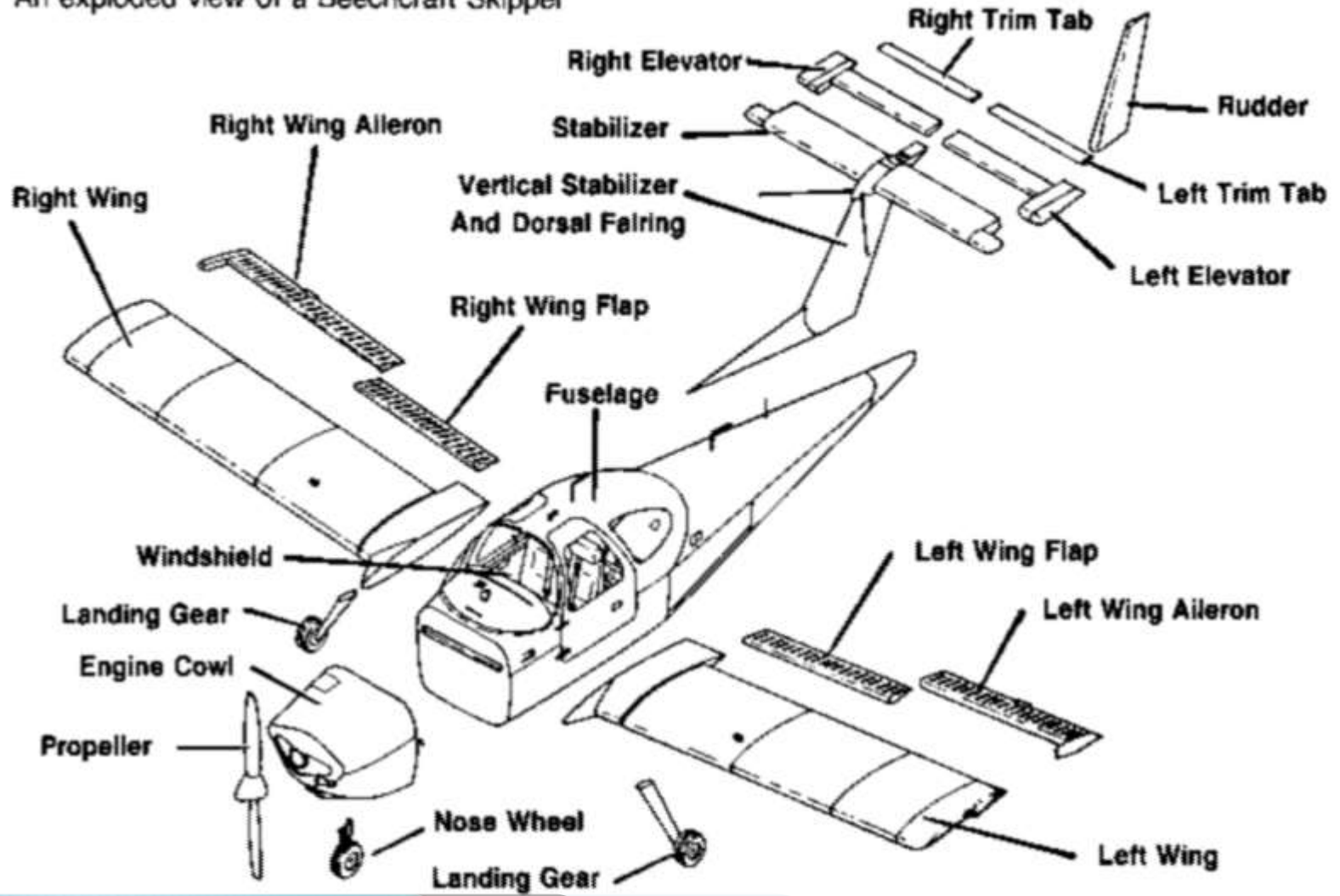

# EMPENNAGE

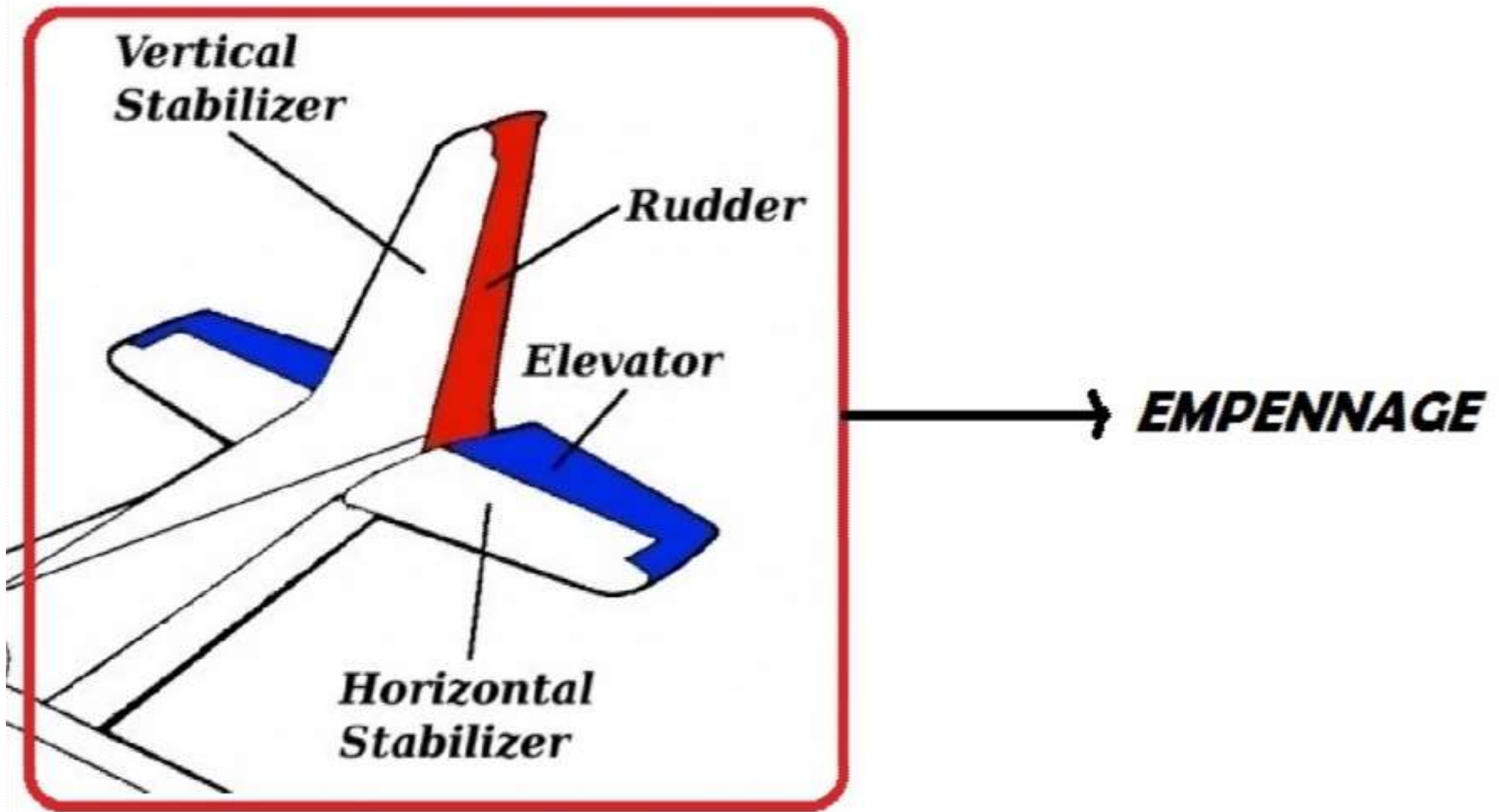

# STABILATOR

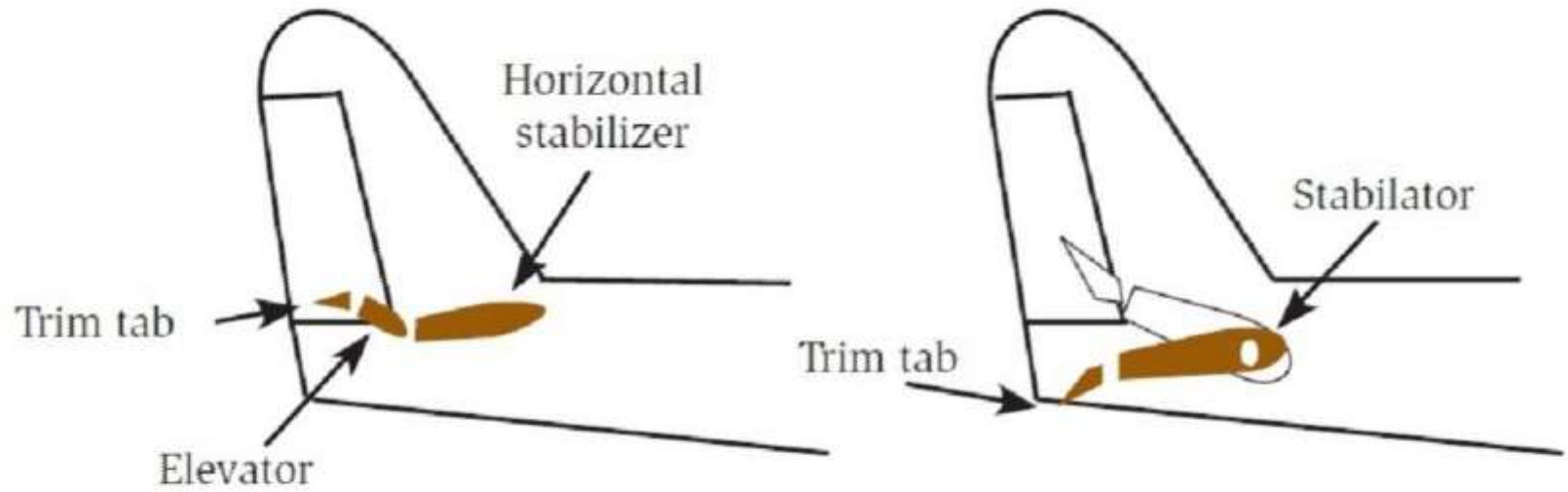

# Parts of an Airliner





# Parts of a Fighter Aircraft

---

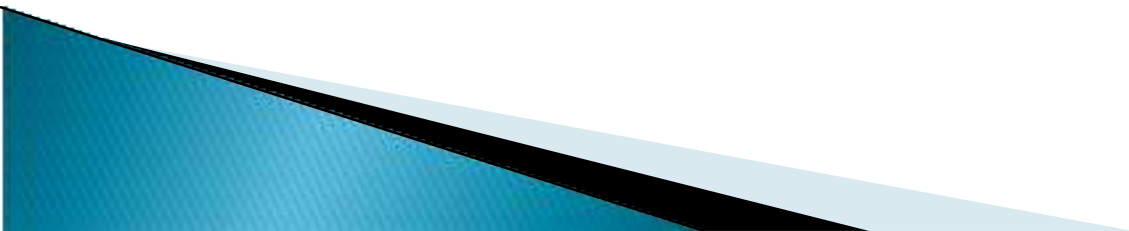

# Parts of an F-22 Raptor

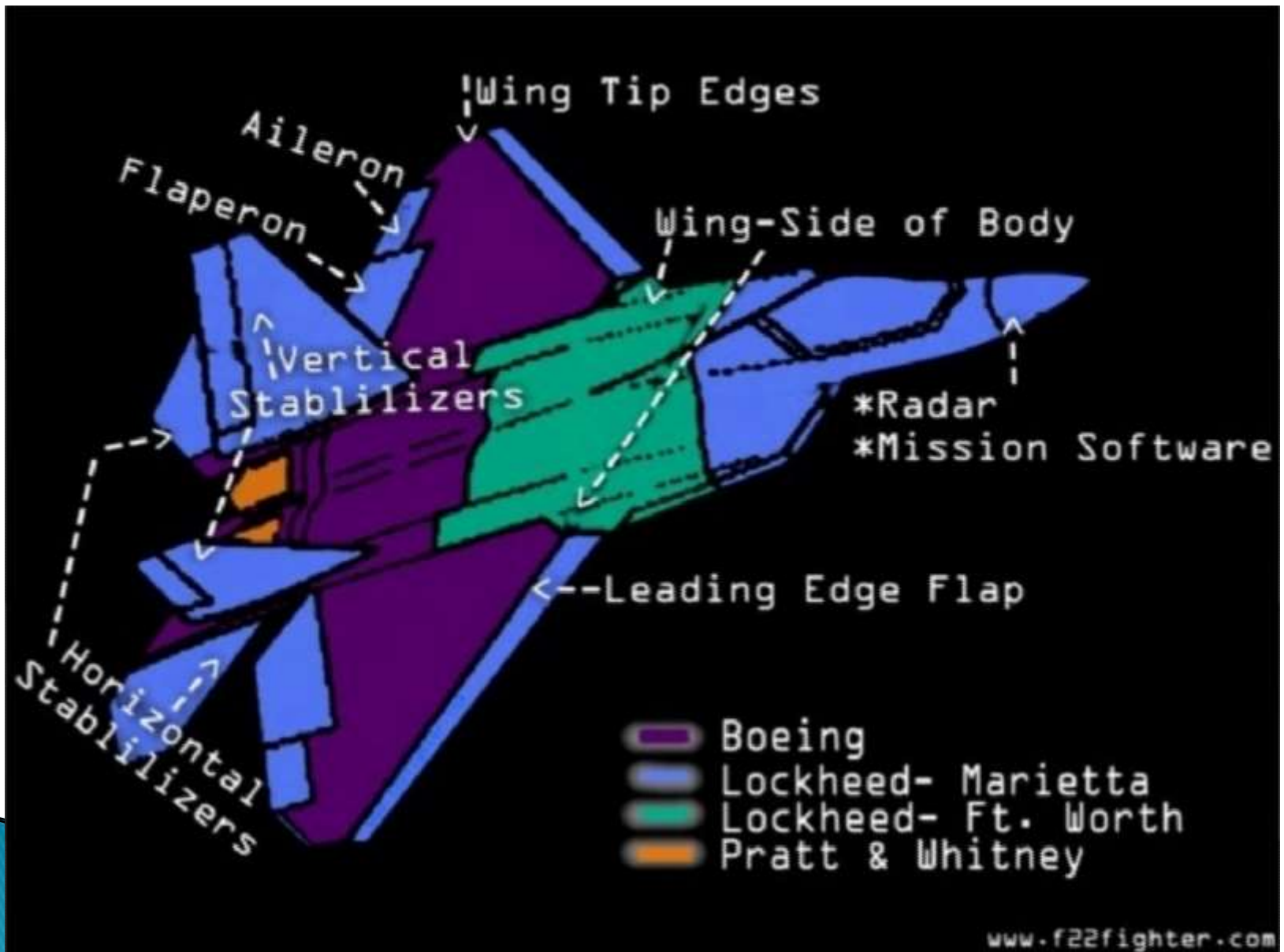



A high-angle, rear-quarter view of a fighter jet, possibly an F-16, flying over a rugged, mountainous terrain. The aircraft is white with dark markings and is carrying several missiles on its wings. The background shows a vast landscape of brown and green mountains under a blue sky with scattered white clouds. The word "STARBOARD" is written in yellow, bold, sans-serif font on the left side of the image, and the word "PORT" is written in the same style on the right side.

**STARBOARD**

**PORT**

# FLYING WING CONCEPT



# FRONT VIEW OF B2 STEALTH BOMBER





# LATERAL VIEW OF B2

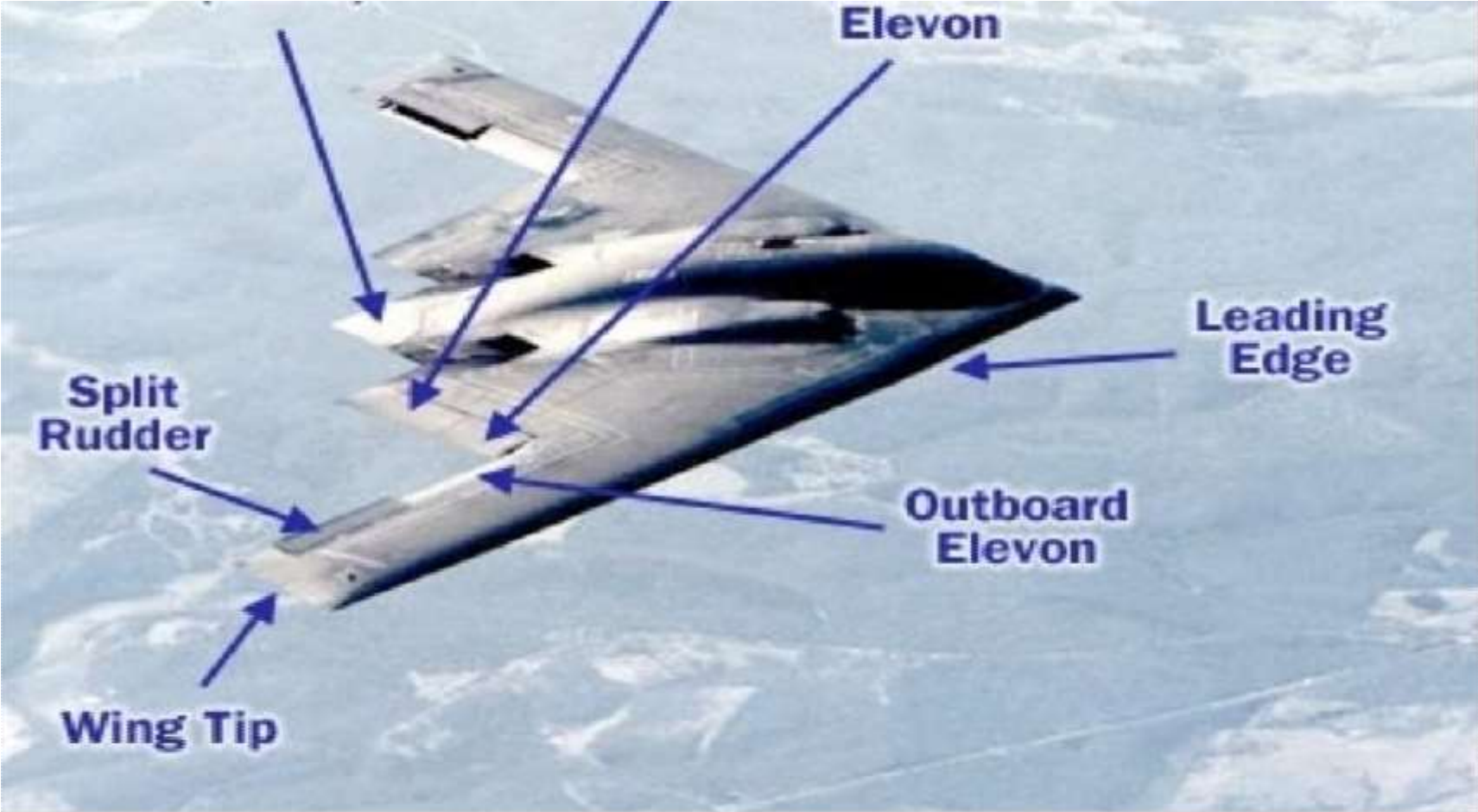

# THE FOUR FORCES

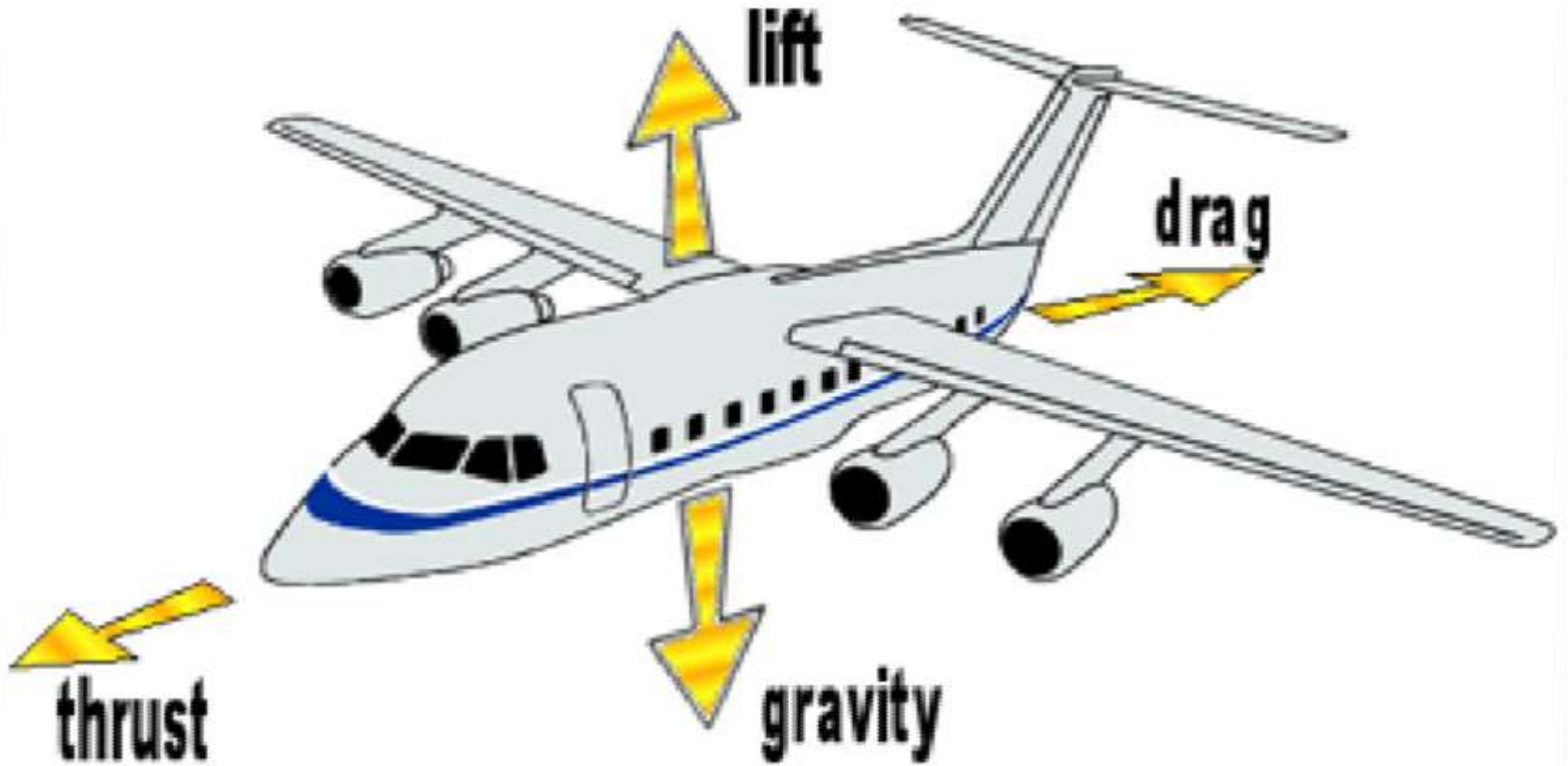

# SIX COMPONENTS (FORCES AND MOMENTS)

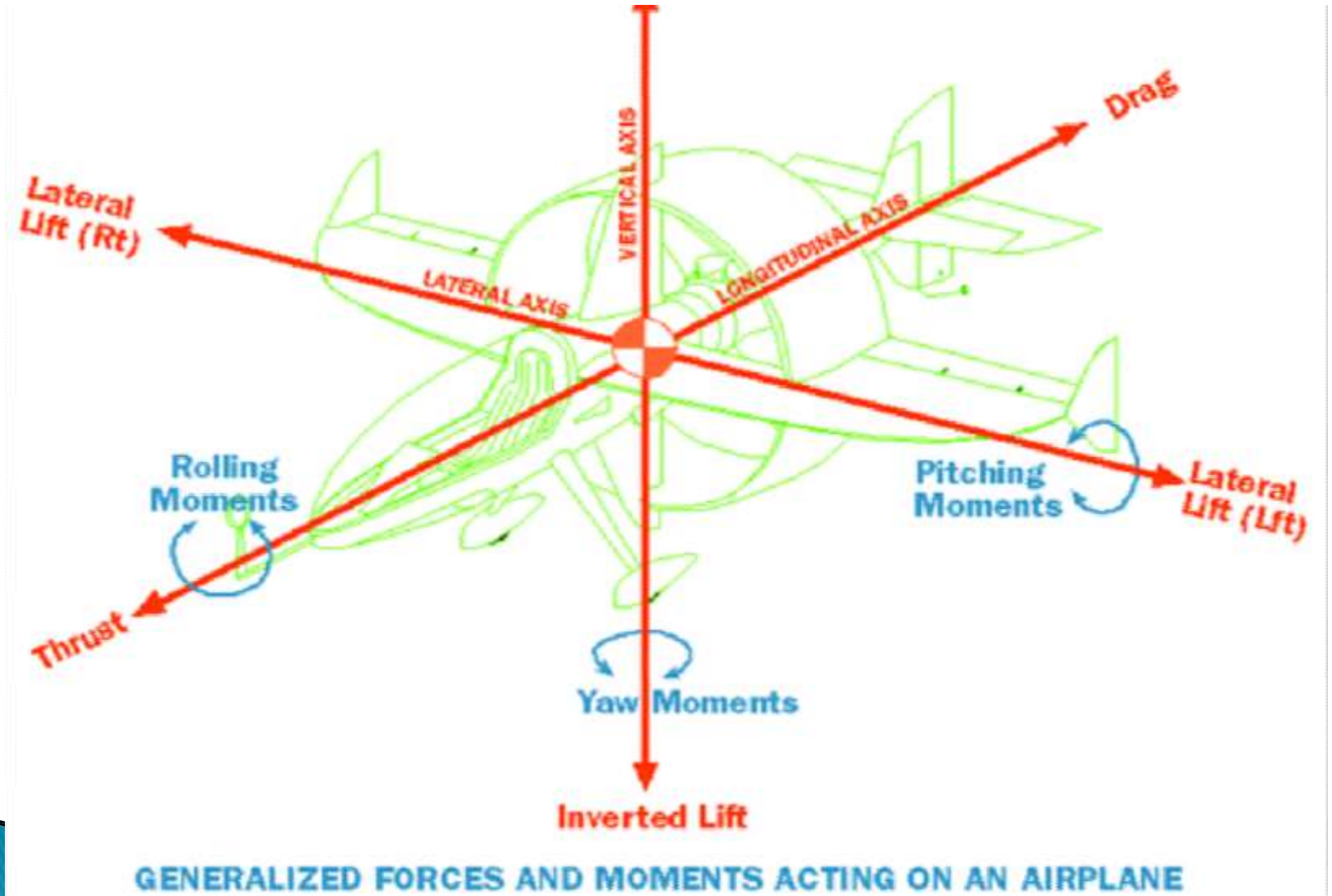



# PITCH



# ROLL



# YAW











# STOL/VTOL



# SHORT TAKE OFF OFF F-35 JSF

# BOEING 787 DREAMLINER LANDING

# VTOL OF HARRIER AIRCRAFT

# VTOL Of F-35 JSF

THANK YOU

