



**Centurion**  
**UNIVERSITY**

*Shaping Lives...*  
*Empowering Communities...*

# Digital Communication Systems

Harish Chandra Mohanta, CUTM, Bhubaneswar Campus



**Centurion**  
**UNIVERSITY**

*Shaping Lives...  
Empowering Communities...*

# Information Representation

Communication systems convert information into a form suitable for transmission

Analog systems → Analog signals are modulated (AM, FM radio)

Digital system generate bits and transmit digital signals (Computers)

Analog signals can be converted to digital signals.



Centurion  
UNIVERSITY

Shaping Lives...  
Empowering Communities...

# Analog vs. Digital

- Analog signals

- Value varies continuously

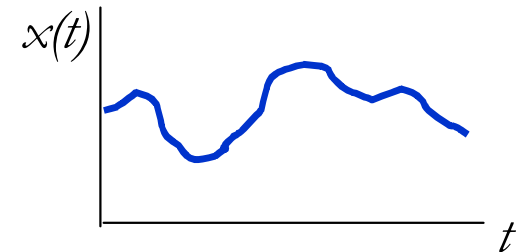

- Digital signals

- Value limited to a finite set

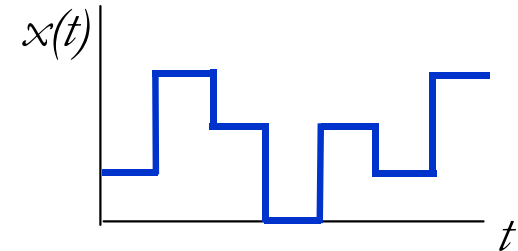

- Binary signals

- Has at most 2 values
- Used to represent bit values
- Bit time  $T$  needed to send 1 bit
- Data rate  $R=1/T$  bits per second

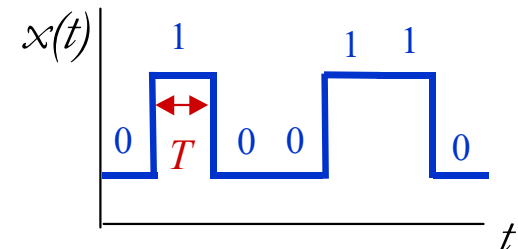



**Centurion**  
**UNIVERSITY**

*Shaping Lives...  
Empowering Communities...*

# Block Diagram

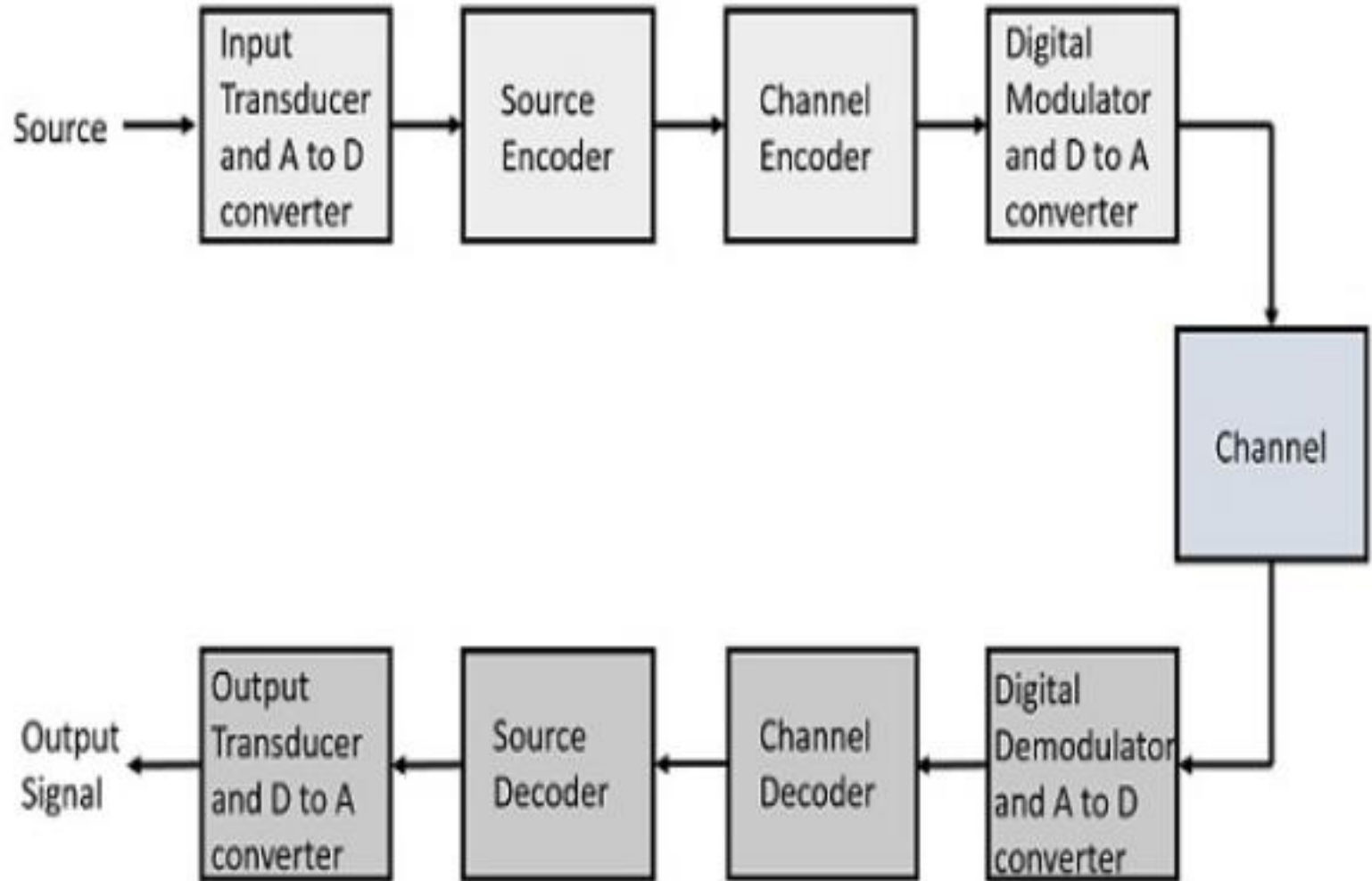



**Centurion**  
**UNIVERSITY**

Shaping Lives...  
Empowering Communities...

# Digital Data System

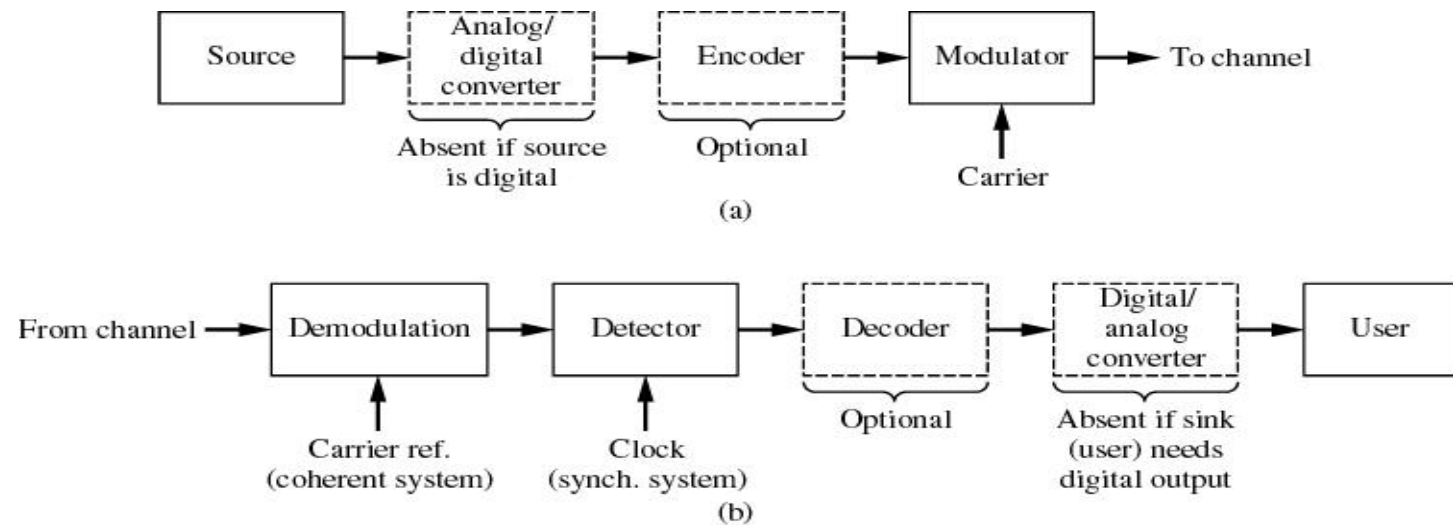

Figure 7-1 Block diagram of a digital data system. (a) Transmitter.  
(b) Receiver.

*Principles of Communications, 5/E* by Rodger Ziemer and William Tranter  
Copyright © 2002 John Wiley & Sons, Inc. All rights reserved.



Centurion  
UNIVERSITY

Shaping Lives...  
Empowering Communities...

# Components of Digital Communication

**Sampling:** If the message is analog, it's converted to discrete time by sampling.

(What should the sampling rate be ?)

**Quantization:** Quantized in amplitude.

Discrete in time and amplitude

**Encoder:**

Convert message or signals in accordance with a set of rules

Translate the discrete set of sample values to a signal.

**Decoder:** Decodes received signals back into original message



**Centurion**  
**UNIVERSITY**

*Shaping Lives...  
Empowering Communities...*

# Advantages

**Stability of components:** Analog hardware change due to component aging, heat, etc.

**Flexibility:**

Perform encryption

Compression

Error correction/detection

**Reliable reproduction**



**Centurion**  
**UNIVERSITY**

*Shaping Lives...  
Empowering Communities...*

# Advantages of Digital communication

- The greatest advantage of digital communication over analog communication is the viability of regenerative repeaters in the former.
- Digital hardware implementation is flexible and permits the use of microprocessors, mini-processors, digital switching, and large scale integrated circuits.
- Digital Signals can be coded to yield extremely low error rates and high fidelity as well as privacy.
- It is easier and more efficient to multiplex several digital signals.
- Digital communication is inherently more efficient than analog in realizing the exchange of SNR for bandwidth.
- Digital signal storage is relatively easy and inexpensive.



**Centurion**  
**UNIVERSITY**

*Shaping Lives...  
Empowering Communities...*

# Applications

Digital Audio  
Transmission

Telephone channels

Lowpass filter, sample,  
quantize

32kbps-64kbps  
(depending on the  
encoder)

Digital Audio  
Recording

LP vs. CD

Improve fidelity (How?)

More durable and don't  
deteriorate with time



Centurion  
UNIVERSITY

Shaping Lives...  
Empowering Communities...

# Classification of Digital Communication

- Digital communication is classified into two types.
  - (1) Baseband data transmission
  - (2) Bandpass data transmission
- Baseband data transmissions are of two types
  - a) Pulse analog (PAM, PWM, PPM)
  - b) Pulse digital (PCM, DPCM, DM, ADM)
- The fundamental difference between baseband and bandpass data transmission is with respect to channel.
- For bandpass, the channel is free space and for baseband, the channel is coaxial cable or fibre optic cable or twisted pair.



Centurion  
UNIVERSITY

Shaping Lives...  
Empowering Communities...

# Sampling: Time Domain

- Many signals originate as continuous-time signals, e.g. conventional music or voice
- By sampling a continuous-time signal at isolated, equally-spaced points in time, we obtain a sequence of numbers

$$n \in \{\dots, -2, -1, 0, 1, 2, \dots\}$$

$T_s$  is the sampling period.

$$s[n] = s(n T_s)$$

$$S_{\text{sampled}}(t) = s(t) \sum_{n=-\infty}^{\infty} \delta(t - n T_s)$$

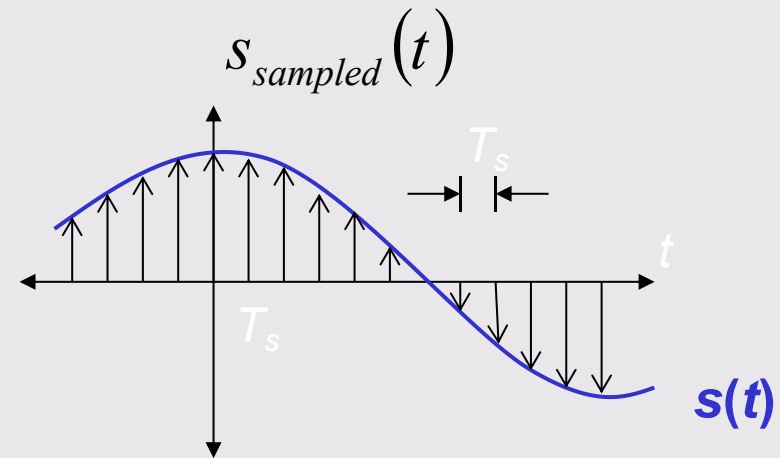

**Sampled analog  
waveform**



# Sampling: Frequency Domain

Replicates spectrum of continuous-time signal

At offsets that are integer multiples of sampling frequency

Fourier series of impulse train where  $\omega_s = 2\pi f_s$

## Example

$$g(t) = f(t) \delta_{T_s}(t) = \frac{1}{T_s} (f(t) + 2f(t)\cos(\omega_s t) + 2f(t)\cos(2\omega_s t) + \dots)$$

$$\delta_{T_s}(t) = \sum_{n=-\infty}^{\infty} \delta(t - nT_s) = \frac{1}{T_s} + \underbrace{\frac{2}{T_s} \cos(\omega_s t)}_{\text{Modulation by } \cos(\omega_s t)} + \underbrace{\frac{2}{T_s} \cos(2\omega_s t)}_{\text{Modulation by } \cos(2\omega_s t)} + \dots$$

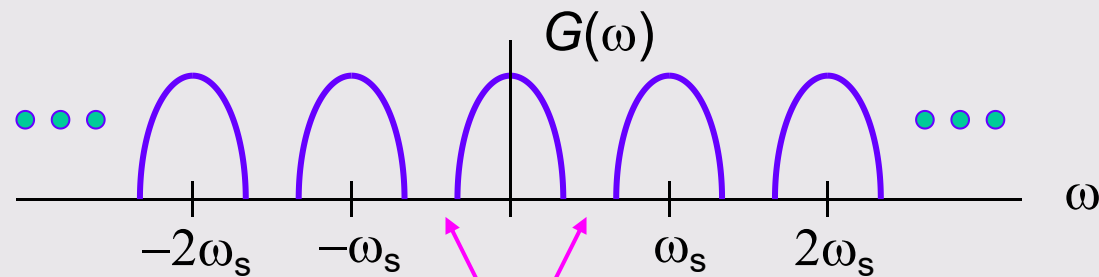
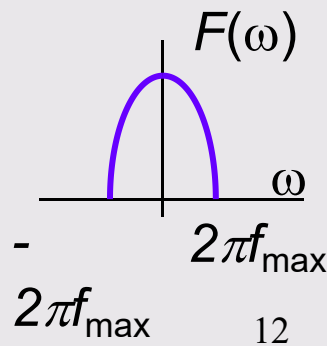

5/28/2020

gap if and only if  $2\pi f_{\max} < 2\pi f_s - 2\pi f_{\max}$



Centurion  
UNIVERSITY

Shaping Lives...  
Empowering Communities...

# Shannon Sampling Theorem

A continuous-time signal  $x(t)$  with frequencies no higher than  $f_{max}$  can be reconstructed from its samples  $x[n] = x(n T_s)$  if the samples are taken at a rate  $f_s$  which is greater than  $2 f_{max}$ .

$$\text{Nyquist rate} = 2 f_{max}$$

$$\text{Nyquist frequency} = f_s/2.$$

What happens if  $f_s = 2f_{max}$ ?

Consider a sinusoid  $\sin(2\pi f_{max} t)$

Use a sampling period of  $T_s = 1/f_s = 1/2f_{max}$ .

Sketch: sinusoid with zeros at  $t = 0, 1/2f_{max}, 1/f_{max}, \dots$



Centurion  
UNIVERSITY

Shaping Lives...  
Empowering Communities...

# Shannon Sampling Theorem

## Assumption

Continuous-time signal has no frequency content above  $f_{\max}$

Sampling time is exactly the same between any two samples

Sequence of numbers obtained by sampling is represented in exact precision

Conversion of sequence to continuous time is ideal

## In Practice



Centurion  
UNIVERSITY

Shaping Lives...  
Empowering Communities...

# Why 44.1 kHz for Audio CDs?

Sound is audible in 20 Hz to 20 kHz range:

$$f_{\max} = 20 \text{ kHz and the Nyquist rate } 2 f_{\max} = 40 \text{ kHz}$$

What is the extra 10% of the bandwidth used?

Rolloff from passband to stopband in the magnitude response of the anti-aliasing filter

Okay, 44 kHz makes sense. Why 44.1 kHz?

At the time the choice was made, only recorders capable of storing such high rates were VCRs.

NTSC: 490 lines/frame, 3 samples/line, 30 frames/s  
= 44100 samples/s

PAL: 588 lines/frame, 3 samples/line, 25 frames/s =  
44100 samples/s



Centurion  
UNIVERSITY

Shaping Lives...  
Empowering Communities...

# Sampling

As sampling rate increases, sampled waveform looks more and more like the original

Many applications (e.g. communication systems) care more about frequency content in the waveform and not its shape

Zero crossings: frequency content of a sinusoid

Distance between two zero crossings: one half period.

With the sampling theorem satisfied, sampled sinusoid crosses zero at the right times even though its waveform shape may be difficult to recognize



Centurion  
UNIVERSITY

Shaping Lives...  
Empowering Communities...

# Aliasing

Analog sinusoid

$$x(t) = A \cos(2\pi f_0 t + \phi)$$

Sample at  $T_s = 1/f_s$

$$x[n] = x(T_s n) = A \cos(2\pi f_0 T_s n + \phi)$$

Keeping the sampling period same, sample

$$y(t) = A \cos(2\pi(f_0 + lf_s)t + \phi) \quad y[n] \text{ indistinguishable from } x[n]$$

where  $l$  is an integer

$$\begin{aligned} y[n] &= y(T_s n) \\ &= A \cos(2\pi(f_0 + lf_s)T_s n + \phi) \\ &= A \cos(2\pi f_0 T_s n + 2\pi lf_s T_s n + \phi) \\ &= A \cos(2\pi f_0 T_s n + 2\pi l n + \phi) \\ &= A \cos(2\pi f_0 T_s n + \phi) \\ &= x[n] \end{aligned}$$

Here,  $f_s T_s = 1$

Since  $l$  is an integer,  
 $\cos(x + 2\pi l) = \cos(x)$

Frequencies  $f_0 + l f_s$  for  $l \neq 0$  are aliases of frequency  $f_0$



**Centurion**  
**UNIVERSITY**

*Shaping Lives...  
Empowering Communities...*

# ANALOG-TO-DIGITAL CONVERSION

- **A digital signal is superior to an analog signal because it is more robust to noise and can easily be recovered, corrected and amplified. For this reason, the tendency today is to change an analog signal to digital data. In this section we describe two techniques, pulse code modulation and delta modulation.**

## Topics discussed in this section:

- **Pulse Code Modulation (PCM)**
- **Delta Modulation (DM)**

# PCM



Centurion  
UNIVERSITY

Shaping Lives...  
Empowering Communities...

PCM consists of three steps to digitize an analog signal:

1. Sampling
  2. Quantization
  3. Binary encoding
- Before we sample, we have to filter the signal to limit the maximum frequency of the signal as it affects the sampling rate.
  - Filtering should ensure that we do not distort the signal, ie remove high frequency components that affect the signal shape.



**Centurion**  
**UNIVERSITY**

*Shaping Lives...  
Empowering Communities...*

# BLOCK DIAGRAM of PCM

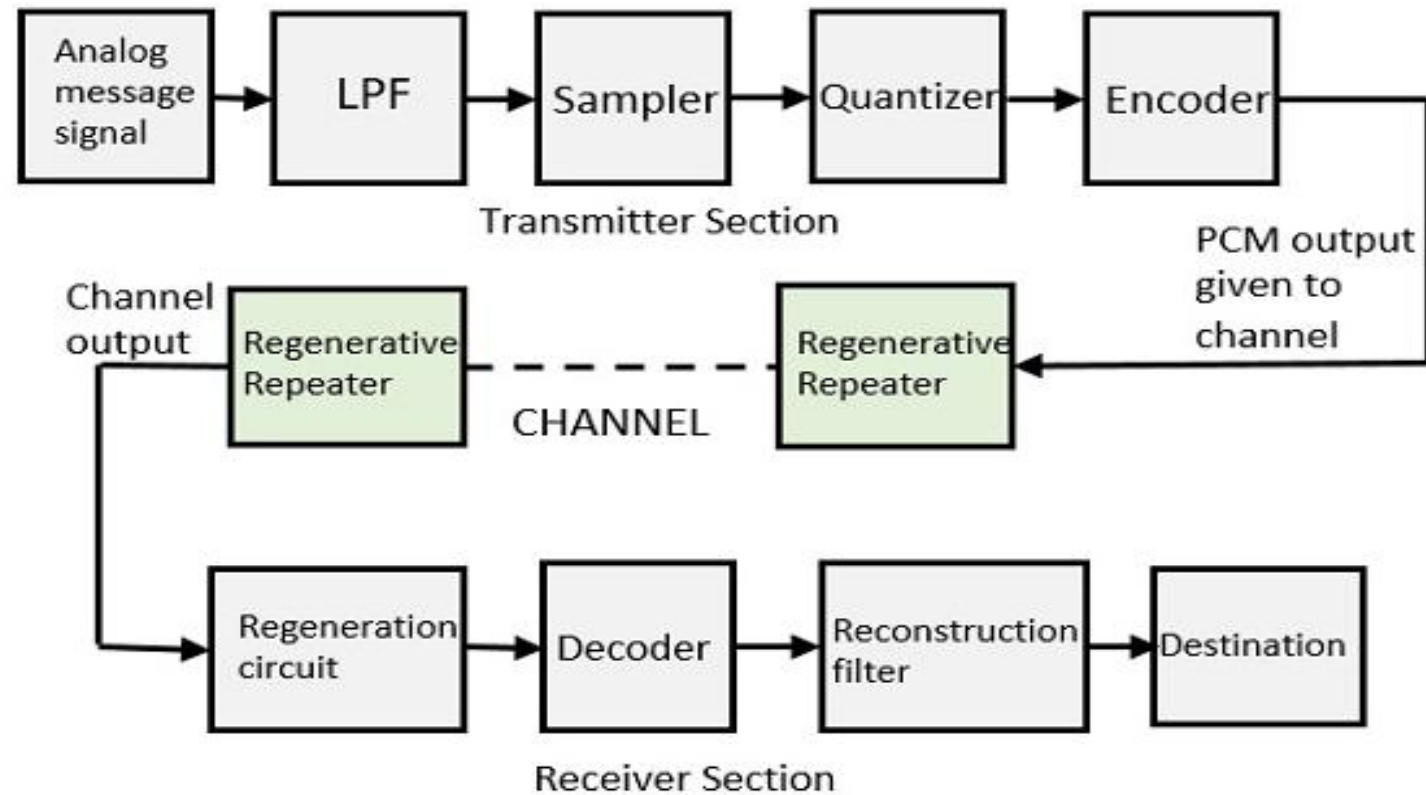



**Centurion**  
**UNIVERSITY**  
*Shaping Lives...  
Empowering Communities...*

# Components of PCM encoder

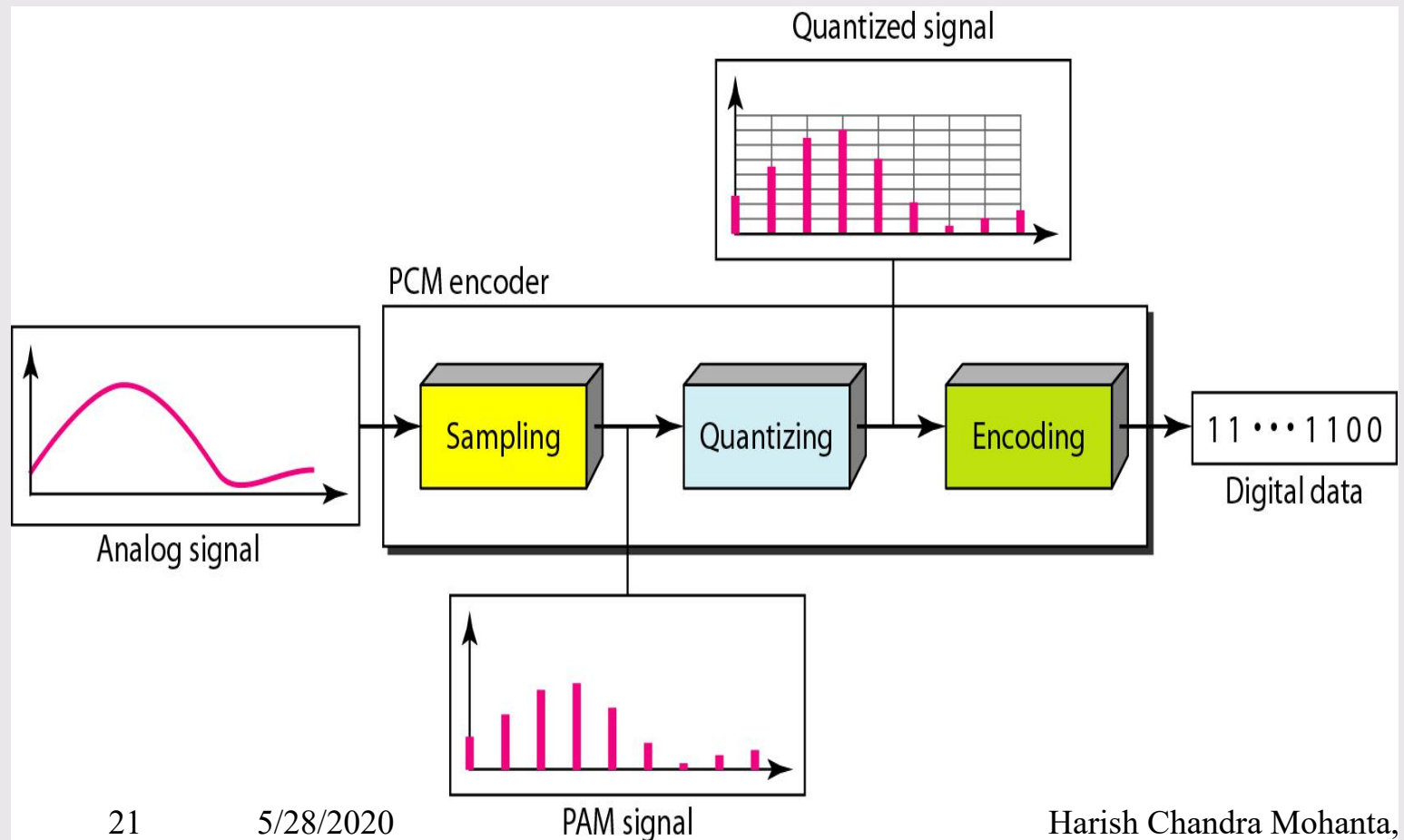



Centurion  
UNIVERSITY

Shaping Lives...  
Empowering Communities...

# Sampling

Analog signal is sampled every  $T_s$  secs.

$T_s$  is referred to as the sampling interval.

$f_s = 1/T_s$  is called the sampling rate or sampling frequency.

There are 3 sampling methods:

Ideal - an impulse at each sampling instant

Natural - a pulse of short width with varying amplitude

Flattop - sample and hold, like natural but with single amplitude value

The process is referred to as pulse amplitude modulation PAM and the outcome is a signal with analog (non integer) values



**Centurion**  
**UNIVERSITY**

Shaping Lives...  
Empowering Communities...

# Three different sampling methods for PCM

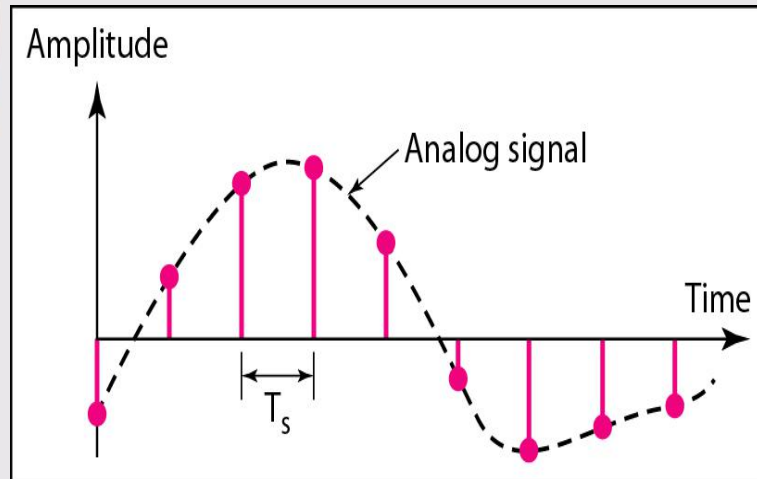

a. Ideal sampling

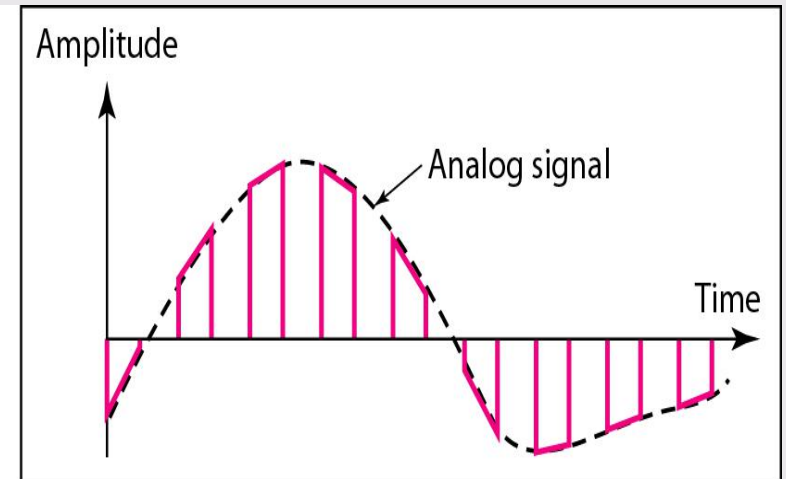

b. Natural sampling

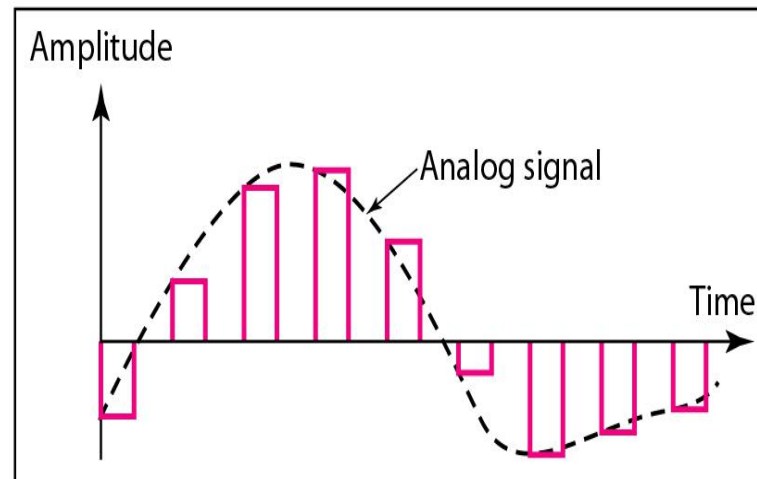

c. Flat-top sampling



**Centurion**  
**UNIVERSITY**

*Shaping Lives...  
Empowering Communities...*

## **Note**

**According to the Nyquist theorem, the sampling rate must be at least 2 times the highest frequency contained in the signal.**



Centurion  
UNIVERSITY

Shaping Lives...  
Empowering Communities...

# Nyquist sampling rate for low-pass and bandpass signals

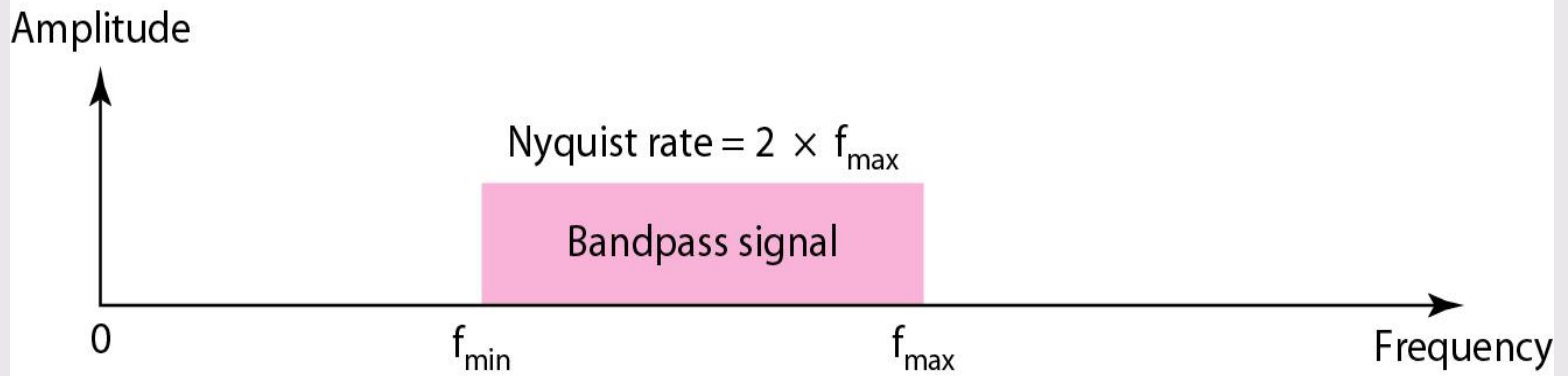
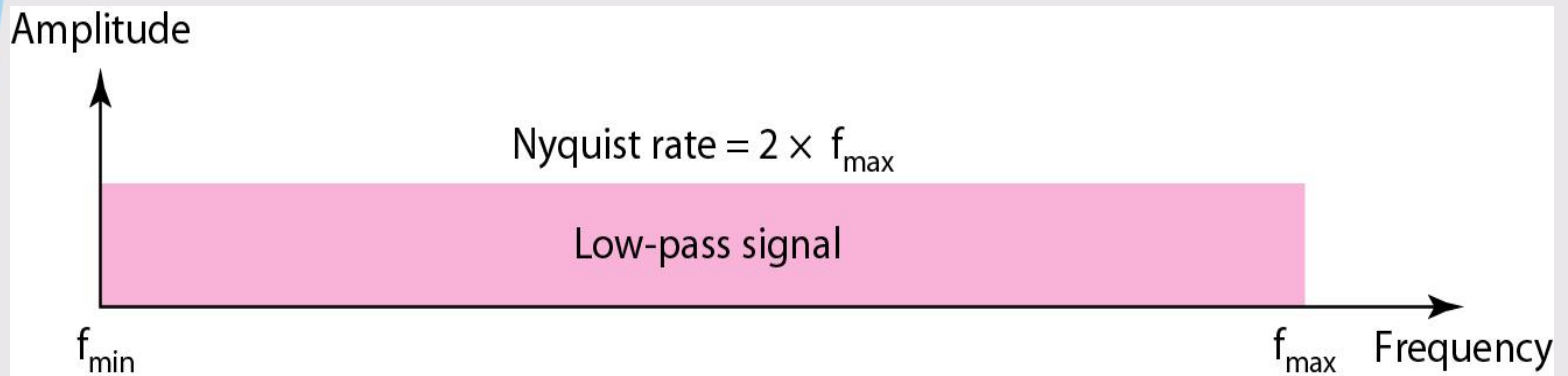



**Centurion**  
**UNIVERSITY**

*Shaping Lives...  
Empowering Communities...*

# Example

For an intuitive example of the Nyquist theorem, let us sample a simple sine wave at three sampling rates:  $f_s = 4f$  (2 times the Nyquist rate),  $f_s = 2f$  (Nyquist rate), and  $f_s = f$  (one-half the Nyquist rate). Figure 4.24 shows the sampling and the subsequent recovery of the signal.

It can be seen that sampling at the Nyquist rate can create a good approximation of the original sine wave (part a). Oversampling in part b can also create the same approximation, but it is redundant and unnecessary. Sampling below the Nyquist rate (part c) does not produce a signal that looks like the original sine wave.



**Centurion**  
**UNIVERSITY**  
*Shaping Lives...  
Empowering Communities...*

## Recovery of a sampled sine wave for different sampling rates

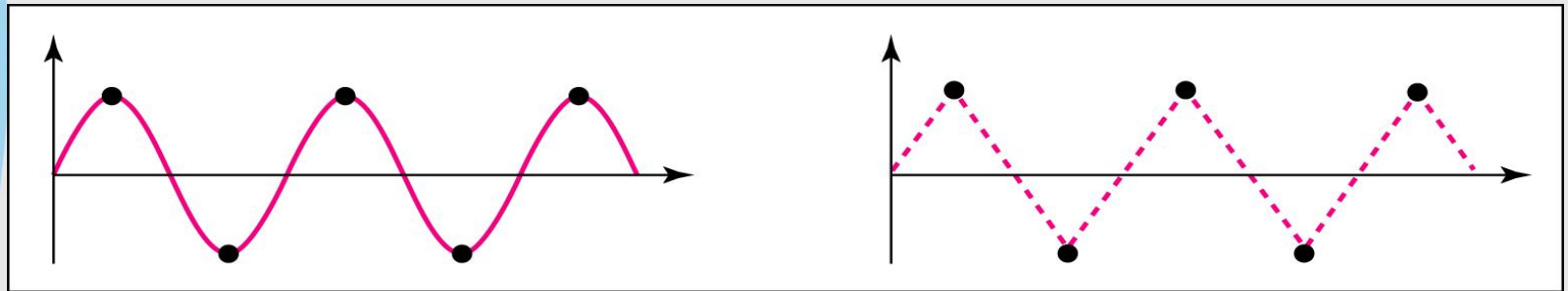

a. Nyquist rate sampling:  $f_s = 2f$

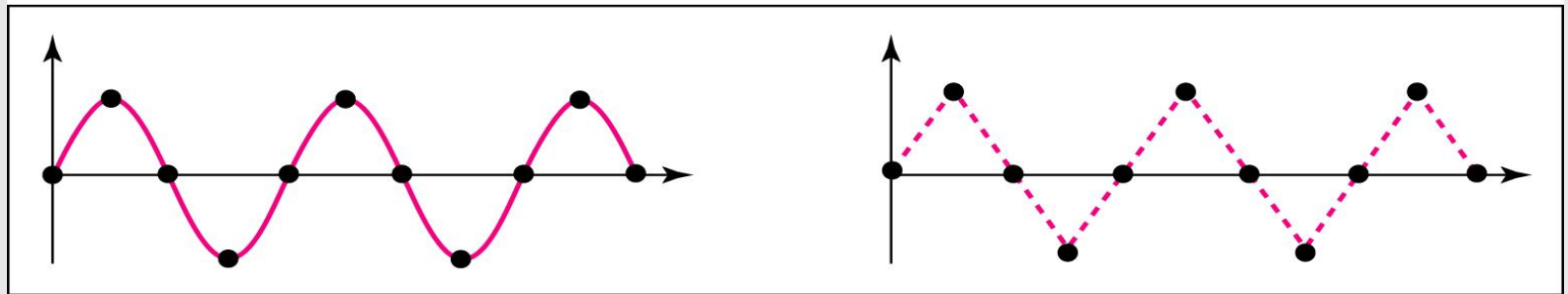

b. Oversampling:  $f_s = 4f$

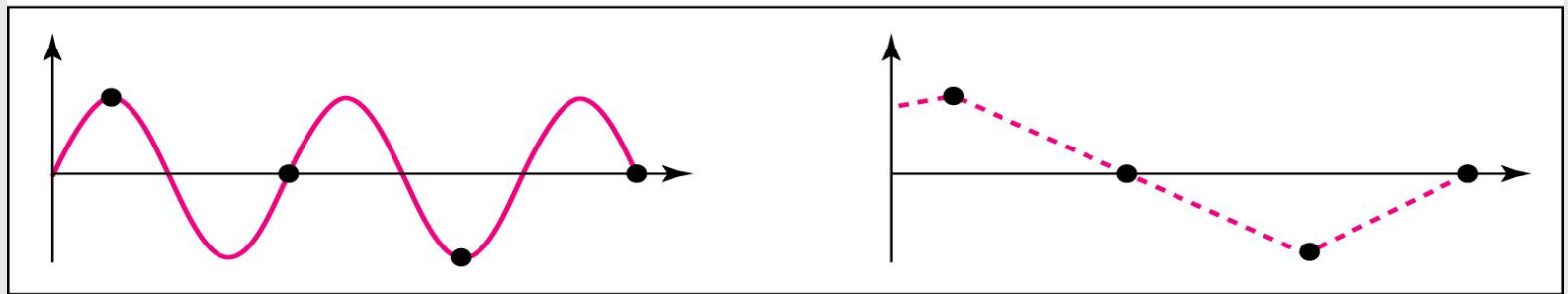

c. Undersampling:  $f_s = f$

# Example

Consider the revolution of a hand of a clock. The second hand of a clock has a period of 60 s. According to the Nyquist theorem, we need to sample the hand every 30 s ( $T_s = T$  or  $f_s = 2f$ ). In Figure 4.25a, the sample points, in order, are 12, 6, 12, 6, 12, and 6. The receiver of the samples cannot tell if the clock is moving forward or backward. In part b, we sample at double the Nyquist rate (every 15 s). The sample points are 12, 3, 6, 9, and 12. The clock is moving forward. In part c, we sample below the Nyquist rate ( $T_s = T$  or  $f_s = f$ ). The sample points are 12, 9, 6, 3, and 12. Although the clock is moving forward, the receiver thinks that the clock is moving backward.



**Centurion**  
**UNIVERSITY**

Shaping Lives...  
Empowering Communities...

# Sampling of a clock with only one hand

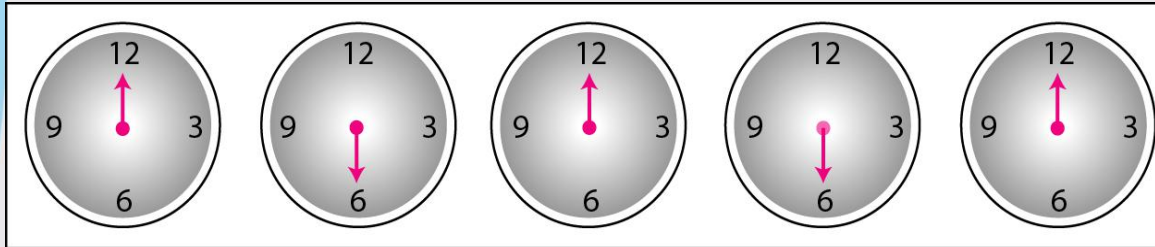

Samples can mean that the clock is moving either forward or backward.  
(12-6-12-6-12)

a. Sampling at Nyquist rate:  $T_s = T \frac{1}{2}$

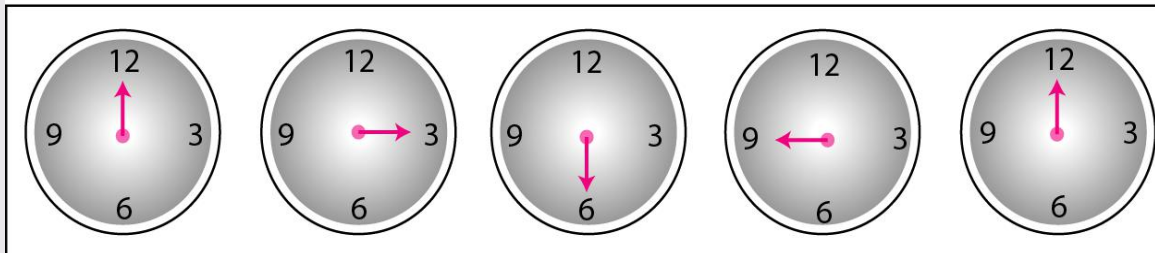

Samples show clock is moving forward.  
(12-3-6-9-12)

b. Oversampling (above Nyquist rate):  $T_s = T \frac{1}{4}$

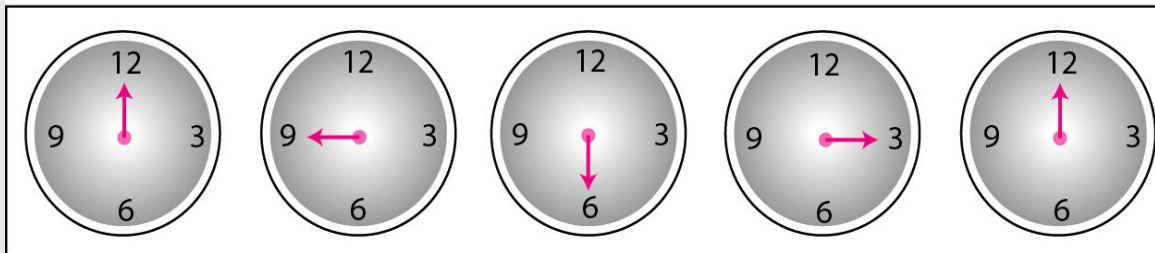

Samples show clock is moving backward.  
(12-9-6-3-12)

c. Undersampling (below Nyquist rate):  $T_s = T \frac{3}{4}$



**Centurion**  
**UNIVERSITY**

*Shaping Lives...  
Empowering Communities...*

# Example

***An example related to previous example is the seemingly backward rotation of the wheels of a forward-moving car in a movie. This can be explained by under-sampling. A movie is filmed at 24 frames per second. If a wheel is rotating more than 12 times per second, the under-sampling creates the impression of a backward rotation.***

# Example



**Centurion**  
**UNIVERSITY**

*Shaping Lives...  
Empowering Communities...*

**Telephone companies digitize voice by assuming a maximum frequency of 4000 Hz. The sampling rate therefore is 8000 samples per second.**



Centurion  
UNIVERSITY

Shaping Lives...  
Empowering Communities...

# Example

***A complex low-pass signal has a bandwidth of 200 kHz. What is the minimum sampling rate for this signal?***

## **Solution**

***The bandwidth of a low-pass signal is between 0 and  $f$ , where  $f$  is the maximum frequency in the signal. Therefore, we can sample this signal at 2 times the highest frequency (200 kHz). The sampling rate is therefore 400,000 samples per second.***

# Example



Centurion  
UNIVERSITY

Shaping Lives...  
Empowering Communities...

***A complex bandpass signal has a bandwidth of 200 kHz. What is the minimum sampling rate for this signal?***

## **Solution**

**We cannot find the minimum sampling rate in this case because we do not know where the bandwidth starts or ends. We do not know the maximum frequency in the signal.**



# Quantization

Sampling results in a series of pulses of varying amplitude values ranging between two limits: a min and a max.

The amplitude values are infinite between the two limits.

We need to map the *infinite* amplitude values onto a finite set of known values.

This is achieved by dividing the distance between min and max into  $L$  zones, each of height  $\Delta$ .

$$\Delta = (\max - \min)/L$$



**Centurion**  
**UNIVERSITY**

*Shaping Lives...  
Empowering Communities...*

# Quantization Levels

The midpoint of each zone is assigned a value from 0 to  $L-1$  (resulting in  $L$  values)

Each sample falling in a zone is then approximated to the value of the midpoint.



Centurion  
UNIVERSITY

Shaping Lives...  
Empowering Communities...

# Quantization Zones

Assume we have a voltage signal with amplitudes  $V_{\min} = -20V$  and  $V_{\max} = +20V$ .

We want to use  $L=8$  quantization levels.

Zone width  $\Delta = (20 - -20)/8 = 5$

The 8 zones are: -20 to -15, -15 to -10, -10 to -5, -5 to 0, 0 to +5, +5 to +10, +10 to +15, +15 to +20

The midpoints are: -17.5, -12.5, -7.5, -2.5, 2.5, 7.5, 12.5, 17.5



Centurion  
UNIVERSITY

Shaping Lives...  
Empowering Communities...

# Assigning Codes to Zones

Each zone is then assigned a binary code.

The number of bits required to encode the zones, or the number of bits per sample as it is commonly referred to, is obtained as follows:  $n_b = \log_2 L$

Given our example,  $n_b = 3$

The 8 zone (or level) codes are therefore: 000, 001, 010, 011, 100, 101, 110, and 111

Assigning codes to zones:

000 will refer to zone -20 to -15

001 to zone -15 to -10, etc.



**Centurion  
UNIVERSITY**

Shaping Lives...  
Empowering Communities...

# Quantization and encoding of a sampled signal

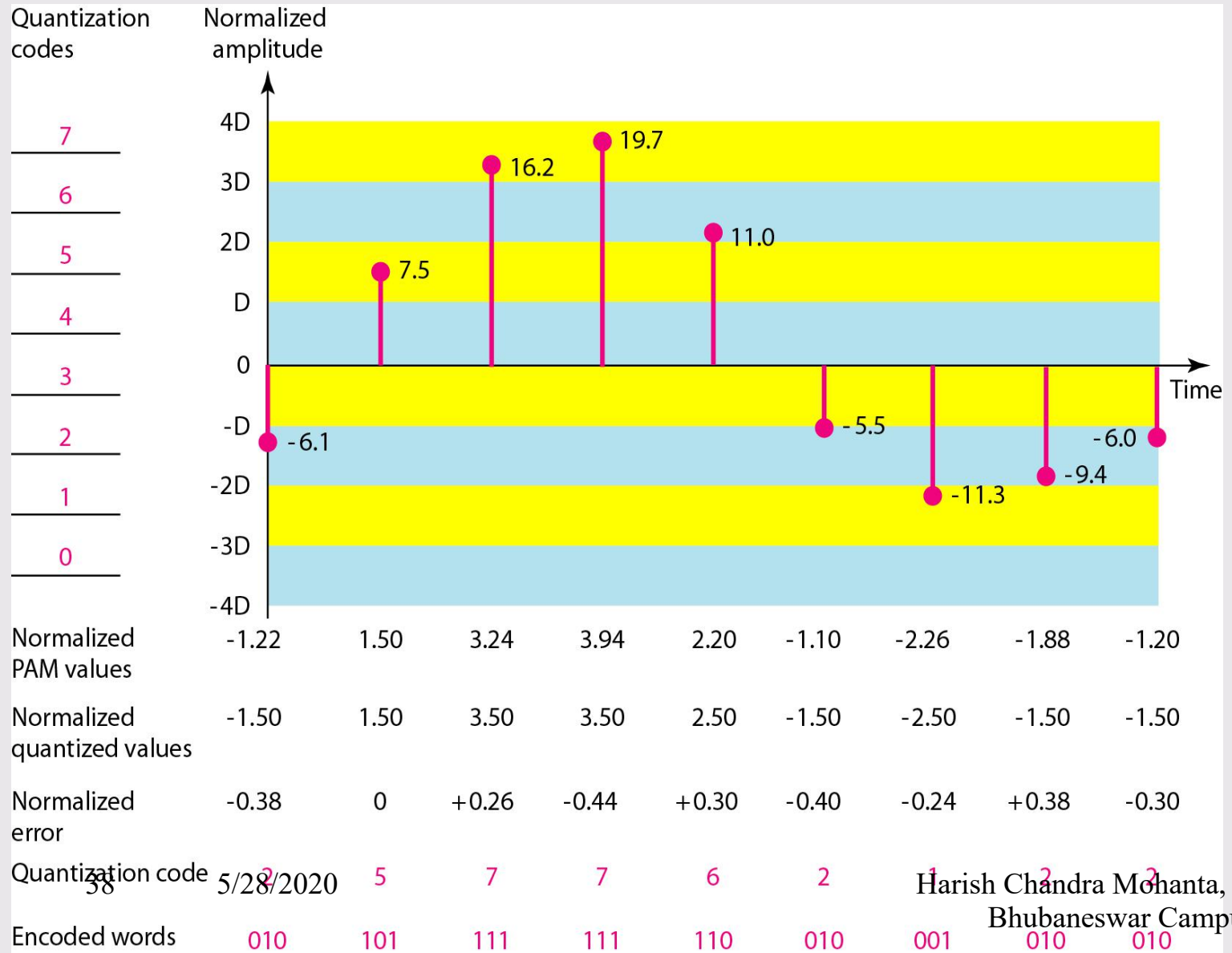



Centurion  
UNIVERSITY

Shaping Lives...  
Empowering Communities...

# Quantization Error

When a signal is quantized, we introduce an error - the coded signal is an approximation of the actual amplitude value.

The difference between actual and coded value (midpoint) is referred to as the quantization error.

The more zones, the smaller  $\Delta$  which results in smaller errors.

BUT, the more zones the more bits required to encode the samples -> higher bit rate



**Centurion**  
**UNIVERSITY**

*Shaping Lives...  
Empowering Communities...*

# Quantization Error and SNQR

Signals with lower amplitude values will suffer more from quantization error as the error range:  $\Delta/2$ , is fixed for all signal levels.

Non linear quantization is used to alleviate this problem. Goal is to keep  $SN_QR$  fixed for all sample values.

Two approaches:

The quantization levels follow a logarithmic curve. Smaller  $\Delta$ 's at lower amplitudes and larger  $\Delta$ 's at higher amplitudes.

Componding: The sample values are compressed at the sender into logarithmic zones, and then expanded at the receiver. The zones are fixed in height.



Centurion  
UNIVERSITY

Shaping Lives...  
Empowering Communities...

# Bit rate and bandwidth requirements of PCM

The bit rate of a PCM signal can be calculated from the number of bits per sample  $\times$  the sampling rate

$$\text{Bit rate} = n_b \times f_s$$

The bandwidth required to transmit this signal depends on the type of line encoding used. Refer to previous section for discussion and formulas.

A digitized signal will always need more bandwidth than the original analog signal. Price we pay for robustness and other features of digital transmission.



**Centurion**  
**UNIVERSITY**  
*Shaping Lives...  
Empowering Communities...*

# Example

***We want to digitize the human voice.  
What is the bit rate, assuming 8 bits  
per sample?***

## ***Solution***

***The human voice normally contains  
frequencies from 0 to 4000 Hz. So the  
sampling rate and bit rate are calculated as  
follows:***

$$\text{Sampling rate} = 4000 \times 2 = 8000 \text{ samples/s}$$

$$\text{Bit rate} = 8000 \times 8 = 64,000 \text{ bps} = 64 \text{ kbps}$$



Centurion  
UNIVERSITY

Shaping Lives...  
Empowering Communities...

# PCM Decoder

To recover an analog signal from a digitized signal we follow the following steps:

We use a hold circuit that holds the amplitude value of a pulse till the next pulse arrives.

We pass this signal through a low pass filter with a cutoff frequency that is equal to the highest frequency in the pre-sampled signal.

The higher the value of  $L$ , the less distorted a signal is recovered.



**Centurion**  
**UNIVERSITY**

Shaping Lives...  
Empowering Communities...

# Components of a PCM decoder

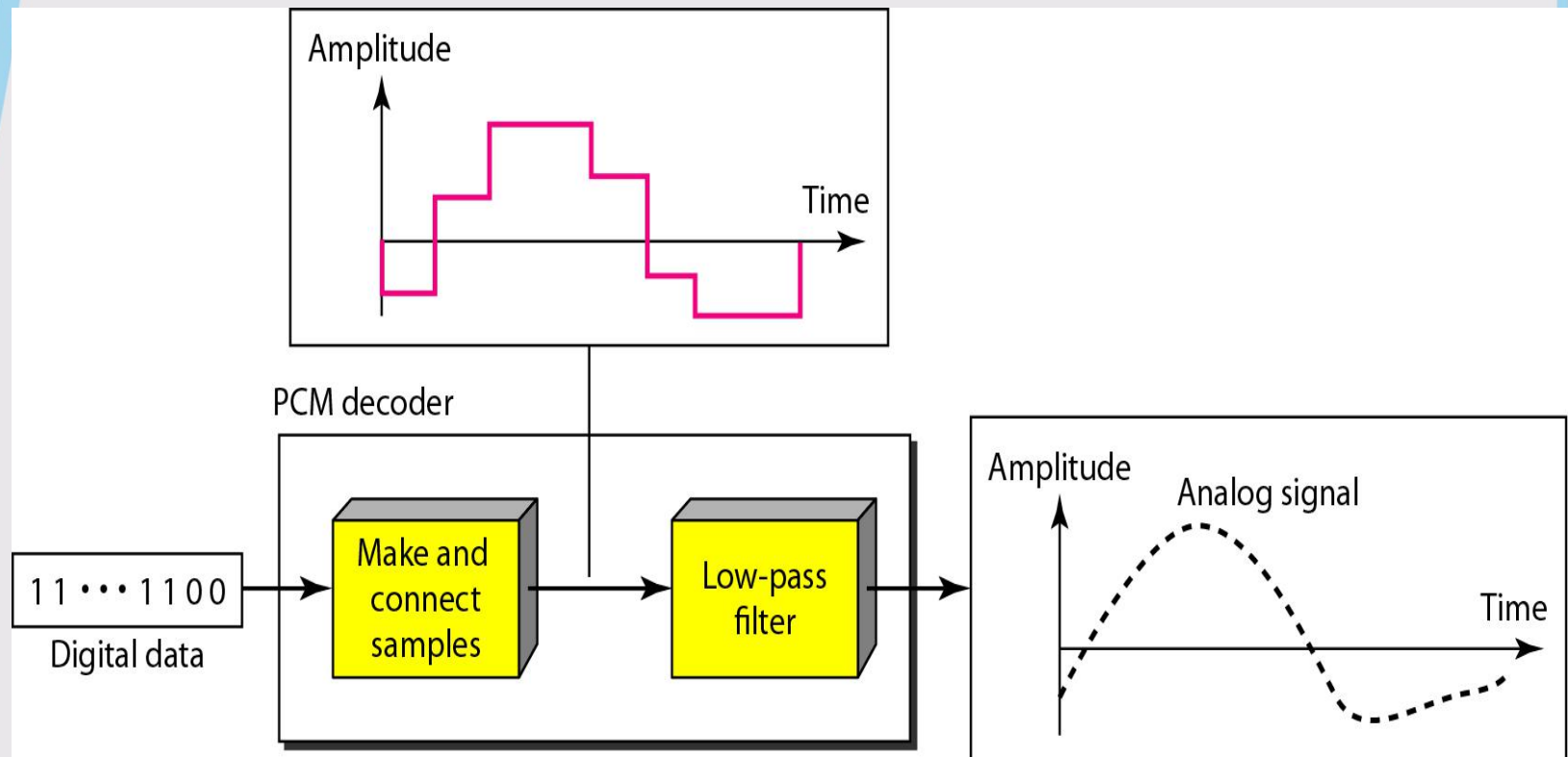



**Centurion**  
**UNIVERSITY**

*Shaping Lives...  
Empowering Communities...*

# Example

**We have a low-pass analog signal of 4 kHz. If we send the analog signal, we need a channel with a minimum bandwidth of 4 kHz. If we digitize the signal and send 8 bits per sample, we need a channel with a minimum bandwidth of  $8 \times 4 \text{ kHz} = 32 \text{ kHz}$ .**



Centurion  
UNIVERSITY

Shaping Lives...  
Empowering Communities...

# Delta Modulation

This scheme sends only the difference between pulses, if the pulse at time  $t_{n+1}$  is higher in amplitude value than the pulse at time  $t_n$ , then a single bit, say a “1”, is used to indicate the positive value.

If the pulse is lower in value, resulting in a negative value, a “0” is used.

This scheme works well for small changes in signal values between samples.

If changes in amplitude are large, this will result in large errors.



**Centurion**  
**UNIVERSITY**

Shaping Lives...  
Empowering Communities...

# The process of delta modulation

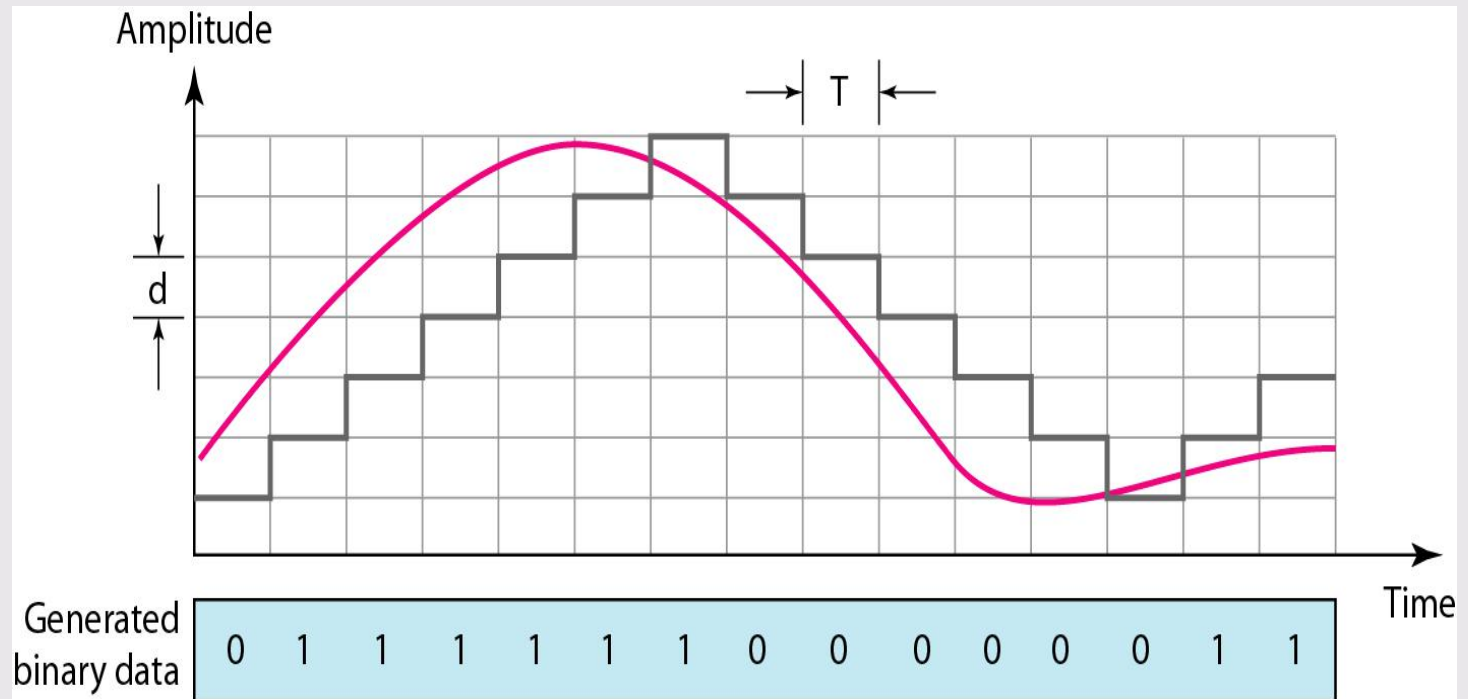



**Centurion**  
**UNIVERSITY**

*Shaping Lives...  
Empowering Communities...*

# Delta modulation components

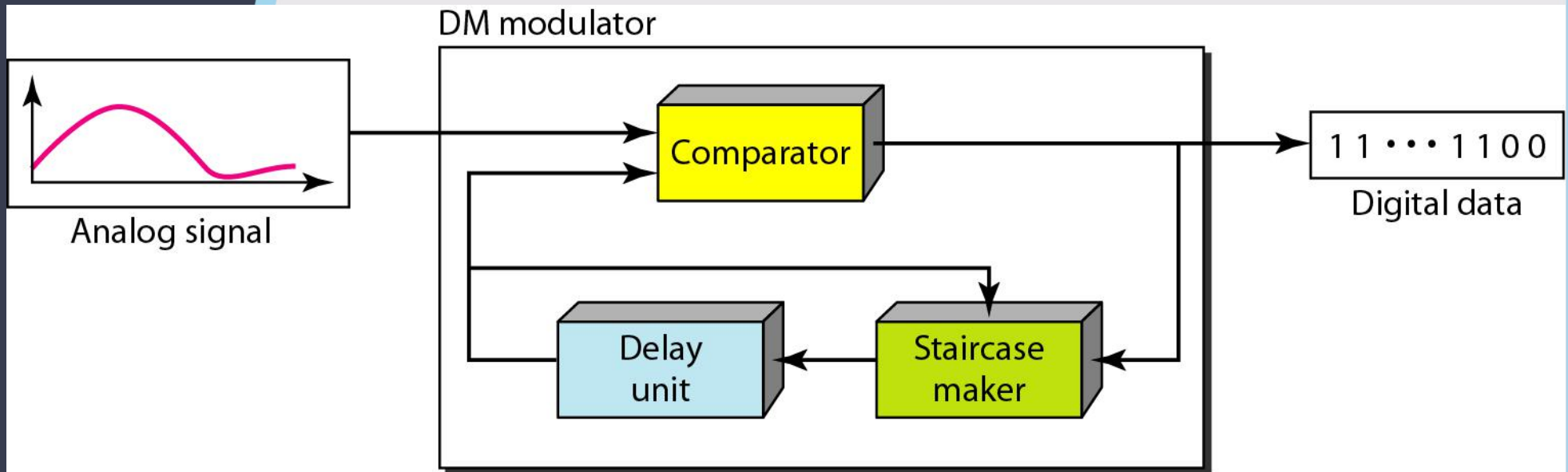



**Centurion**  
**UNIVERSITY**

*Shaping Lives...  
Empowering Communities...*

# Delta demodulation components

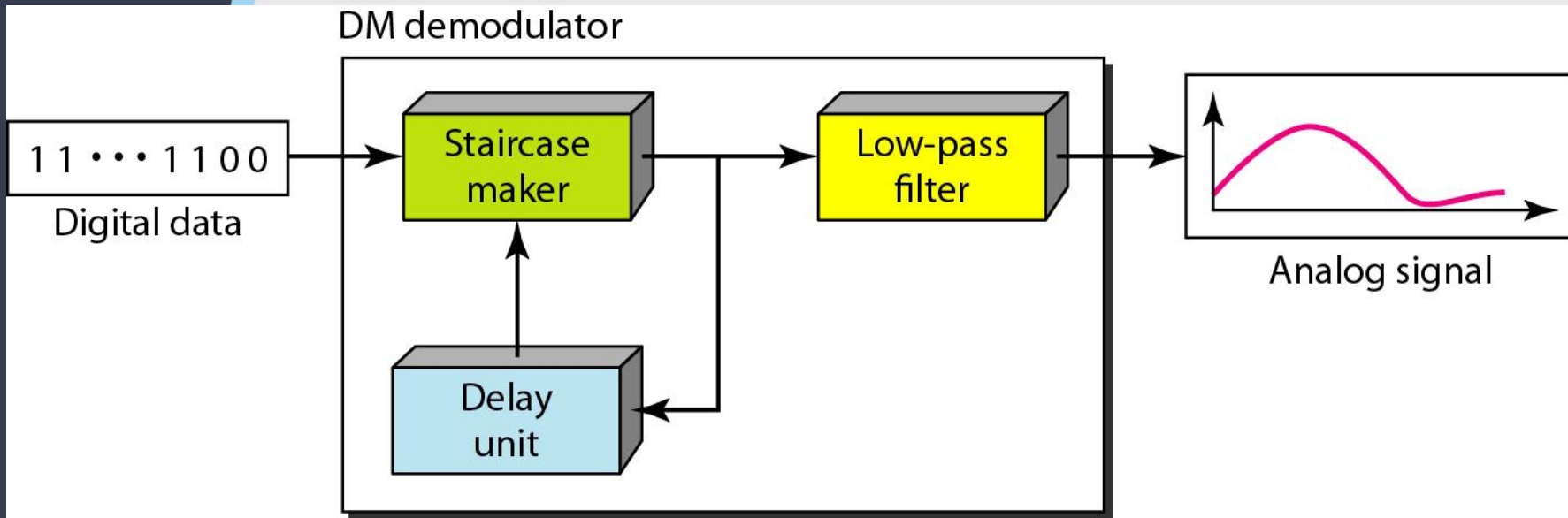



Centurion  
UNIVERSITY

Shaping Lives...  
Empowering Communities...

# Delta PCM (DPCM)

Instead of using one bit to indicate positive and negative differences, we can use more bits -> quantization of the difference.

Each bit code is used to represent the value of the difference.

The more bits the more levels -> the higher the accuracy.



**Centurion**  
**UNIVERSITY**

*Shaping Lives...  
Empowering Communities...*

# TRANSMISSION MODES

**The transmission of binary data across a link can be accomplished in either parallel or serial mode. In parallel mode, multiple bits are sent with each clock tick. In serial mode, 1 bit is sent with each clock tick. While there is only one way to send parallel data, there are three subclasses of serial transmission: asynchronous, synchronous, and isochronous.**

## **Topics discussed in this section:**

- **Parallel Transmission**
- **Serial Transmission**



# ***Data transmission and modes***

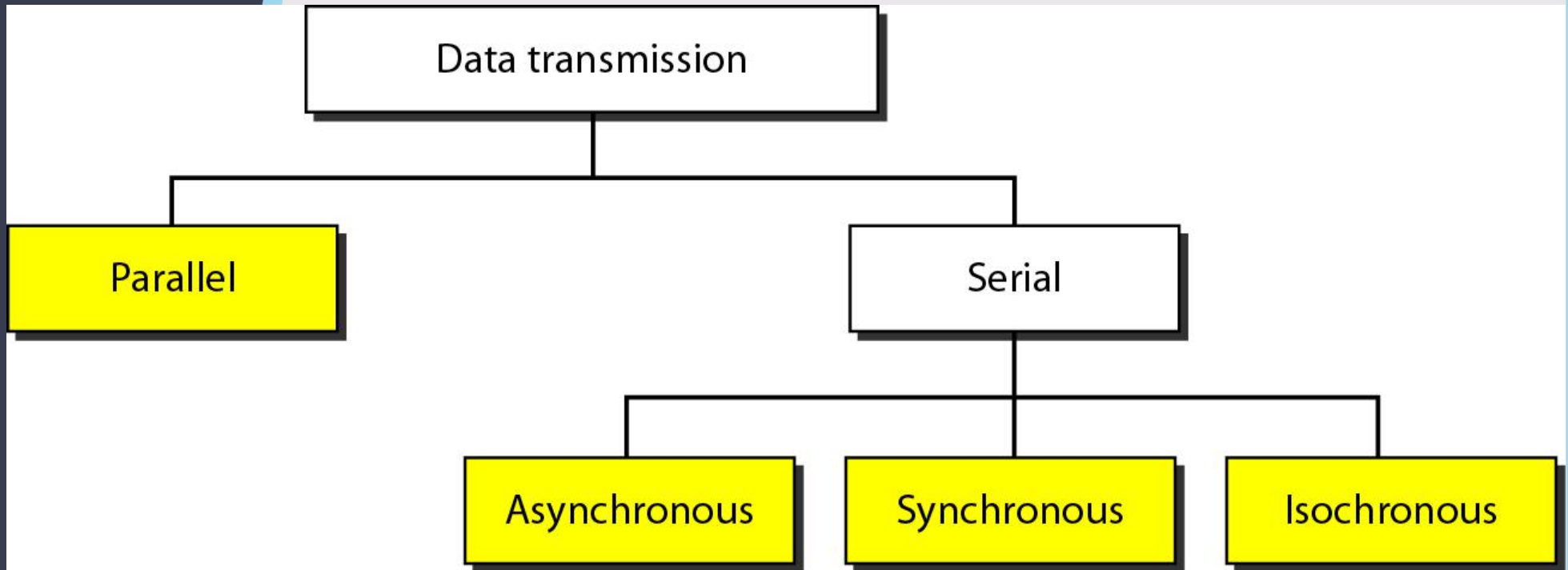



**Centurion**  
**UNIVERSITY**

*Shaping Lives...  
Empowering Communities...*

# Parallel transmission

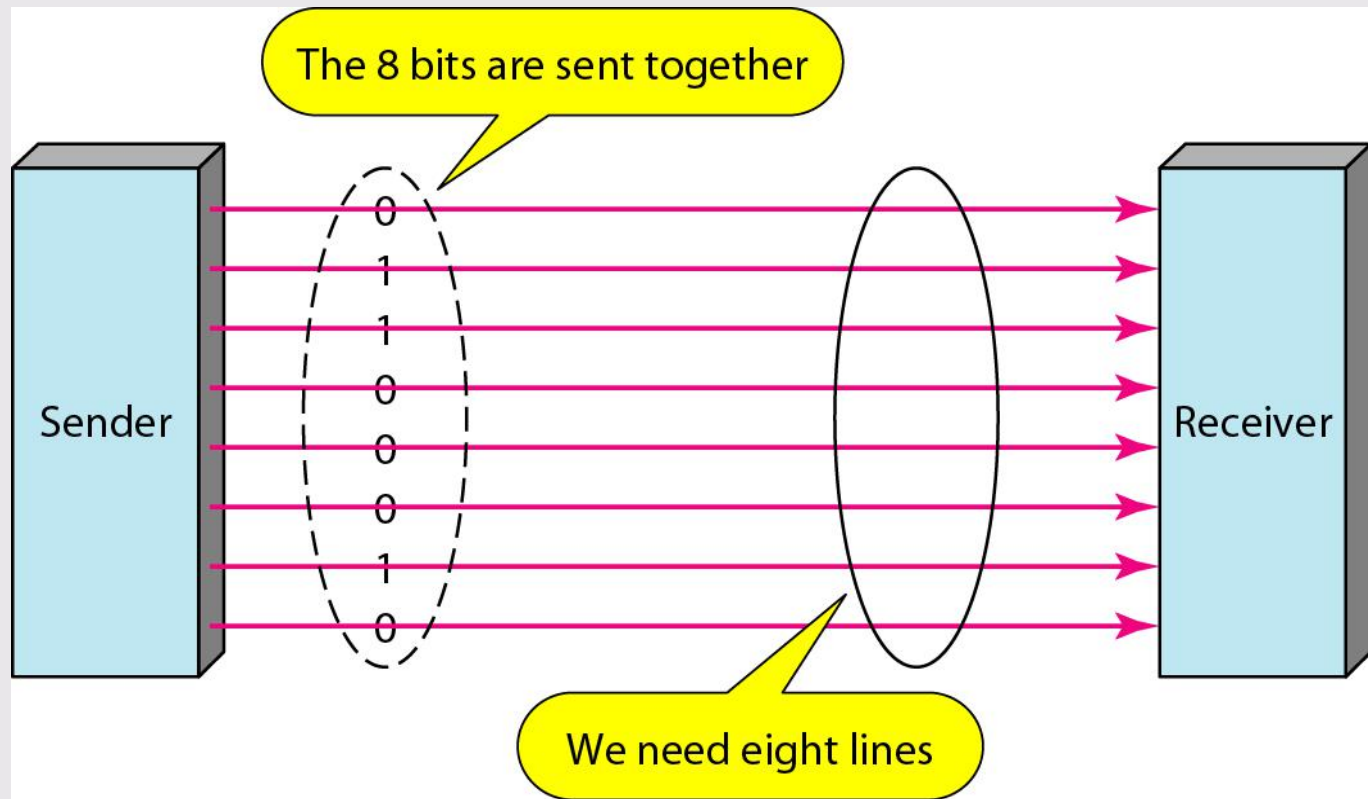



**Centurion**  
**UNIVERSITY**

Shaping Lives...  
Empowering Communities...

# Serial transmission

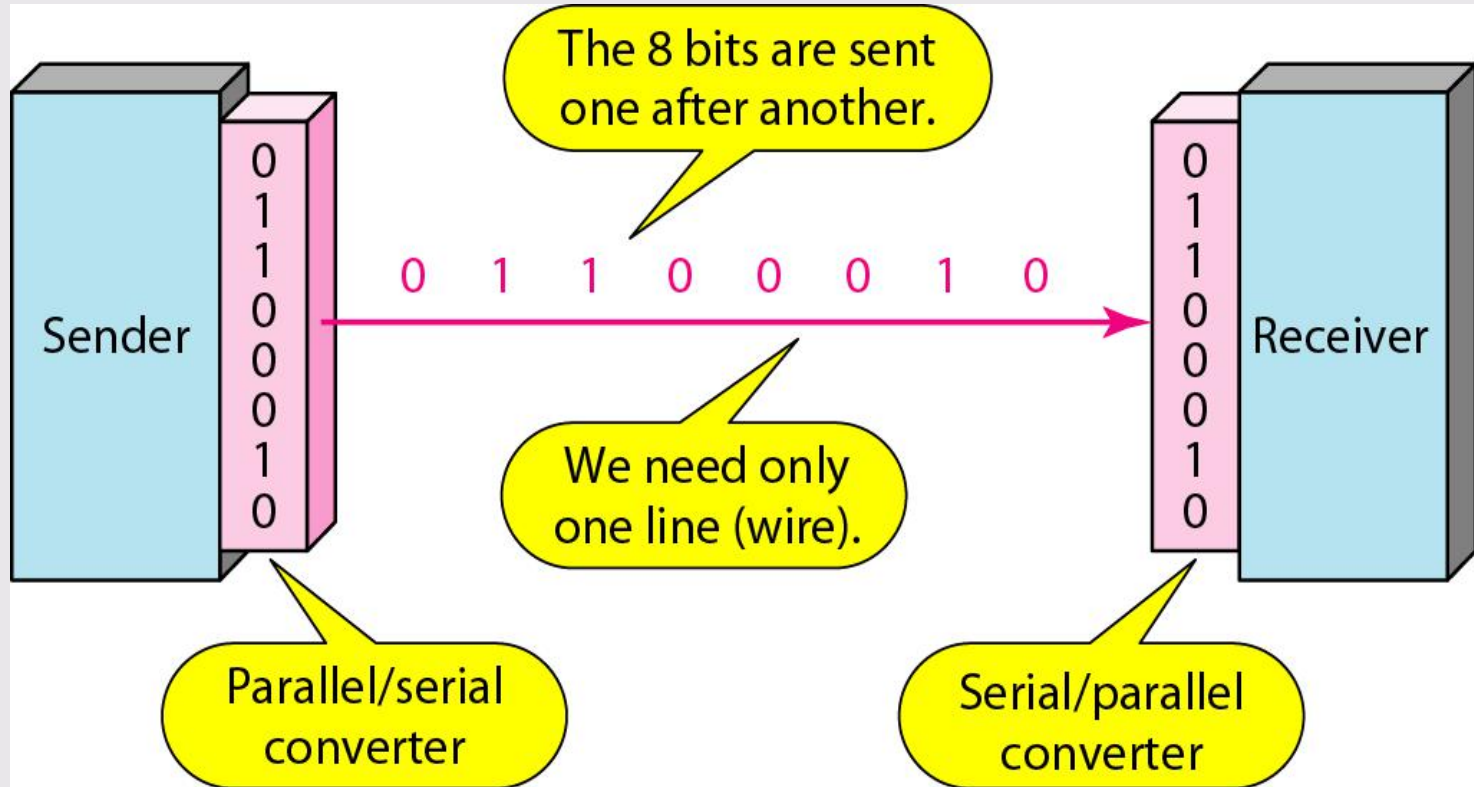

**In asynchronous transmission, we send 1 start bit (0) at the beginning and 1 or more stop bits (1s) at the end of each byte. There may be a gap between each byte.**



**Centurion**  
**UNIVERSITY**

*Shaping Lives...*  
*Empowering Communities...*

**Asynchronous here means  
“asynchronous at the byte level,”  
but the bits are still synchronized;  
their durations are the same.**



Centurion  
UNIVERSITY

Shaping Lives...  
Empowering Communities...

# Asynchronous transmission

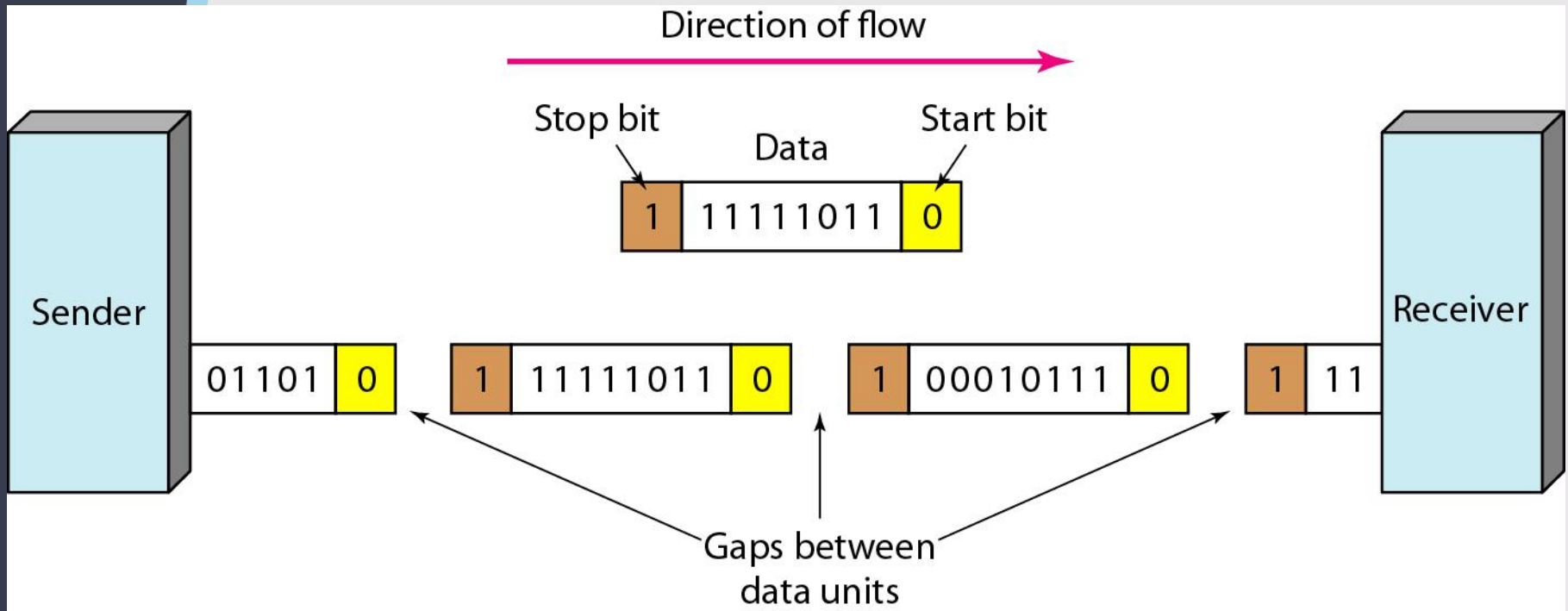



## **Note**

**In synchronous transmission, we send bits one after another without start or stop bits or gaps. It is the responsibility of the receiver to group the bits. The bits are usually sent as bytes and many bytes are grouped in a frame. A frame is identified with a start and an end byte.**



Centurion  
UNIVERSITY

Shaping Lives...  
Empowering Communities...

# Synchronous transmission

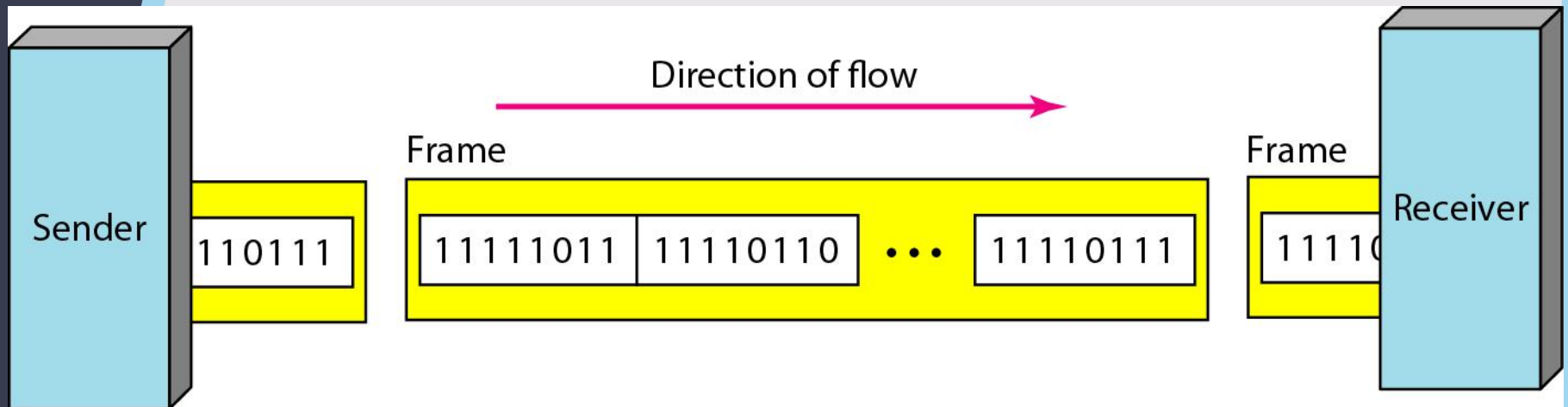



**Centurion**  
**UNIVERSITY**

*Shaping Lives...  
Empowering Communities...*

# Isochronous

In isochronous transmission we cannot have uneven gaps between frames.

Transmission of bits is fixed with equal gaps.



**Centurion**  
**UNIVERSITY**

*Shaping Lives...  
Empowering Communities...*

# **PULSE CODE MODULATION (PCM) NOISE ANALYSIS**

Harish Chandra Mohanta, CUTM, Bhubaneswar Campus



Centurion  
UNIVERSITY

Shaping Lives...  
Empowering Communities...

# WHAT IS PCM ....??

**Pulse-code modulation (PCM)** is a method used to digitally represent sampled analog signals.

In a PCM , the amplitude of the analog signal is sampled regularly at uniform intervals, and each sample is quantized to the nearest value within a range of digital steps.

The sampling rate must be greater than twice the highest frequency in the analog signal i.e.  $f_s \geq 2f_m$ .



Centurion  
UNIVERSITY

Shaping Lives...  
Empowering Communities...

# WHAT IS QUANTIZATION..?

It is the process of converting sampled version of analog signal into discrete time and discrete amplitude signal.

## WHAT IS QUANTIZATION ERROR...?

Quantization error is the difference between the analog signal and the closest available digital value at each sampling instant from the A/D converter. Quantization error also introduces noise, called quantization noise.

## WHAT IS QUANTIZATION LEVEL..?

Approximating amplitude of signal to the nearest value from the set of discrete amplitude level is called quantization level.

$$\text{Quantizer level (L)} = 2^n$$

$$Q_e(\text{max}) = \Delta/2$$

$$Q_e(\text{min}) = -\Delta/2$$



Centurion  
UNIVERSITY

Shaping Lives...  
Empowering Communities...

# PARAMETERS OF PCM

$$\text{Step size } (\Delta) = \frac{v_{\max} - v_{\min}}{L}$$

$$\text{Bit Duration } (T_b) = Ts/n \quad , T_s = \text{sampling interval}$$

$$\text{Bit rate } (R_b) = n/T_s$$

$$\text{Sampling Rate } (f_s) = 1/T_s$$

$$(B.W)_{\max} = 1/T_b \text{ Hz}$$

$$(B.W)_{\min} = R_b/2$$

When  $f_s = 2f_m$ , then it is called Nyquist Rate



Centurion  
UNIVERSITY

Shaping Lives...  
Empowering Communities...

# QUANTIZATION NOISE ( $N_q$ )

$$F(Q_e) = 1/\Delta, \text{ where } -\Delta/2 \leq Q_e \leq \Delta/2$$
$$= 0, \text{ otherwise}$$

$N_q$  = quantization noise power = mean square value of  $Q_e$

$$N_q = \int_{-\infty}^{\infty} x^2 f(x) dx$$
$$= \int_{-\Delta/2}^{\Delta/2} Q_e^2 f(Q_e) dQ_e$$
$$= \int_{-\Delta/2}^{\Delta/2} Q_e^2 \frac{1}{\Delta} dQ_e$$



Centurion  
UNIVERSITY

Shaping Lives...  
Empowering Communities...

$$\begin{aligned} &= \frac{1}{\Delta} \left[ \frac{Qe^3}{3} \frac{\Delta}{2} \right] \\ &= \frac{1}{\Delta} \times \frac{1}{3} \left[ \frac{\Delta^3}{8} + \frac{\Delta^3}{8} \right] \\ &= \frac{1}{\Delta} * \frac{2\Delta^3}{24} \\ N_q &= \frac{\Delta^2}{12} \end{aligned}$$



Centurion  
UNIVERSITY

Shaping Lives...  
Empowering Communities...

# Quantization Noise Power

If the sampled quantization error waveform is represented as

$$e_s(t) = e(t)I \sum_{k=-\infty}^{k=\infty} \delta(t - kT_s)$$

When  $t = kT_s$

$$e_s(t) = I \sum_{k=-\infty}^{k=\infty} e(kT_s) \delta(t - kT_s)$$

The power spectral density  $G_{e_s}(f) = \frac{I^2}{T_s} \overline{e^2(kT_s)}$

$$\text{Quantization error} = \overline{e^2(t)} = \frac{\Delta^2}{12}$$

$$\text{Quantization noise power} = N_q = \frac{I^2}{T_s} \left( \frac{\Delta^2}{12} \right)$$



Centurion  
UNIVERSITY

Shaping Lives...  
Empowering Communities...

# Thermal Noise Power

The thermal noise is white and Gaussian, the probability of an error depends on the ratio  $E_b/N_0$ . Where  $E_b$  is the signal energy transmitted during a bit and  $N_0/2$  is the two sided power spectral density of the noise.

$$\text{Thermal noise power} = N_{th} = \frac{2^{2n} \Delta^2 p_e I^2}{3T_s} .$$

Where  $p_e$  is probability error,  $I$ =impulse strength,  $T_s$ = sampling interval and  $\Delta$  = quantization step size

$$\text{Probability error of PSK} = (P_e)_{psk} = \frac{1}{2} \operatorname{erfc} \sqrt{\frac{E_b}{N_0}}$$

$$\text{Probability error of FSK} = (P_e)_{fsk} = \frac{1}{2} \operatorname{erfc} \sqrt{\frac{E_b}{2N_0}}$$



Centurion  
UNIVERSITY

Shaping Lives...  
Empowering Communities...

# Output Signal Power

The sampled signal which appears at the input to the baseband filter is given by  $m_s(t)$ .

$$m_s(t) = m(t)I \sum_{k=-\infty}^{k=\infty} \delta(t - KT_s)$$

Impulse train is periodic it can be represented by a Fourier series. The impulse trains have a strength (area)  $I$  and are separated by a time  $T_s$ .

$$m_0(t) = \frac{I}{T_s} m(t).$$

Hence the signal  $m_0(t)$  at the output of the baseband filter

Output signal power= 
$$S_0 = \frac{I^2}{T_s^2} \overline{m^2(t)}$$



# Output Signal Power

In order to calculate the value of  $\overline{m^2(t)}$ , let us assume the number of quantization levels= $L=l$  and step size= $\Delta$

We assume that the signal can vary from  $-\frac{l\Delta}{2}$  to  $\frac{l\Delta}{2}$ .

The instantaneous value of  $m(t)$  may fall anywhere in its allowable range of  $l\Delta$  volts with equal likelihood.

The probability density function of the instantaneous value of  $s$  is  $f(s)$ .

$$f(s) = \frac{1}{l\Delta}$$

The variance of  $m(t)$  is  $\overline{m^2(t)}$ .

$$\overline{m^2(t)} = \int_{-\frac{l\Delta}{2}}^{\frac{l\Delta}{2}} s^2 f(s) ds = \frac{1}{l\Delta} \int_{-\frac{l\Delta}{2}}^{\frac{l\Delta}{2}} s^2 ds$$



# Output Signal Noise Power Ratio

So, the variance of  $m(t)$  is  $\overline{m^2(t)} = \frac{L^2 \Delta^2}{12}$

$$(SNR)_{\frac{o}{p}} = \frac{S_0}{N_q + N_{th}} = \frac{S_0}{N_0} = \frac{\left(\frac{I^2}{T_s^2}\right)(L^2 \Delta^2)}{\left(\frac{I^2}{T_s^2}\right)\left(\frac{\Delta^2}{12}\right)}$$

The output signal power =  $S_0 = \frac{I^2}{T_s^2} \frac{L^2 \Delta^2}{12}$

The output signal to noise ratio (SNR) of PCM =

$$(SNR)_{\frac{o}{p}} = \frac{S_0}{N_q + N_{th}}$$

Where  $N_q$  is quantization noise power and  $N_{th}$  is thermal noise power

$$(SNR)_{\frac{o}{p}} = \frac{S_0}{N_q + N_{th}} = \frac{S_0}{N_0} = \frac{\left(\frac{I^2}{T_s^2}\right)\left(\frac{L^2 \Delta^2}{12}\right)}{\left(\frac{I^2}{T_s^2}\right)\left(\frac{\Delta^2}{12}\right) + \left(\frac{I^2}{T_s^2}\right)\left(\frac{p_e 2^{2n} \Delta^2}{3}\right)}$$



Centurion  
UNIVERSITY

Shaping Lives...  
Empowering Communities...

# OUTPUT SNR of PCM

General formula of SNR output is 
$$\frac{S_o}{N_0} = \frac{2^{2n}}{1 + 4p_e 2^{2n}}$$

Probability error of PSK = 
$$(P_e)_{psk} = \frac{1}{2} \operatorname{erfc} \sqrt{\frac{E_b}{N_0}}$$

Probability error of FSK = 
$$(P_e)_{fsk} = \frac{1}{2} \operatorname{erfc} \sqrt{\frac{E_b}{2N_0}}$$

If the received signal power is  $S_i$ . The energy per bit  $E_b = S_i \times (T_s/n) = S_i \times (1/2f_m n)$

If  $\eta$  is the thermal – noise spectral density

$$\left(\frac{S_o}{N_0}\right)_{psk} = \frac{2^{2n}}{1 + 2^{2N+1} \operatorname{erfc} \sqrt{\left(\frac{1}{2n}\right) \left(\frac{S_i}{\eta f_m}\right)}}$$

$\eta$



**Centurion**  
**UNIVERSITY**

Shaping Lives...  
Empowering Communities...

# Comparison of PCM Transmission Systems

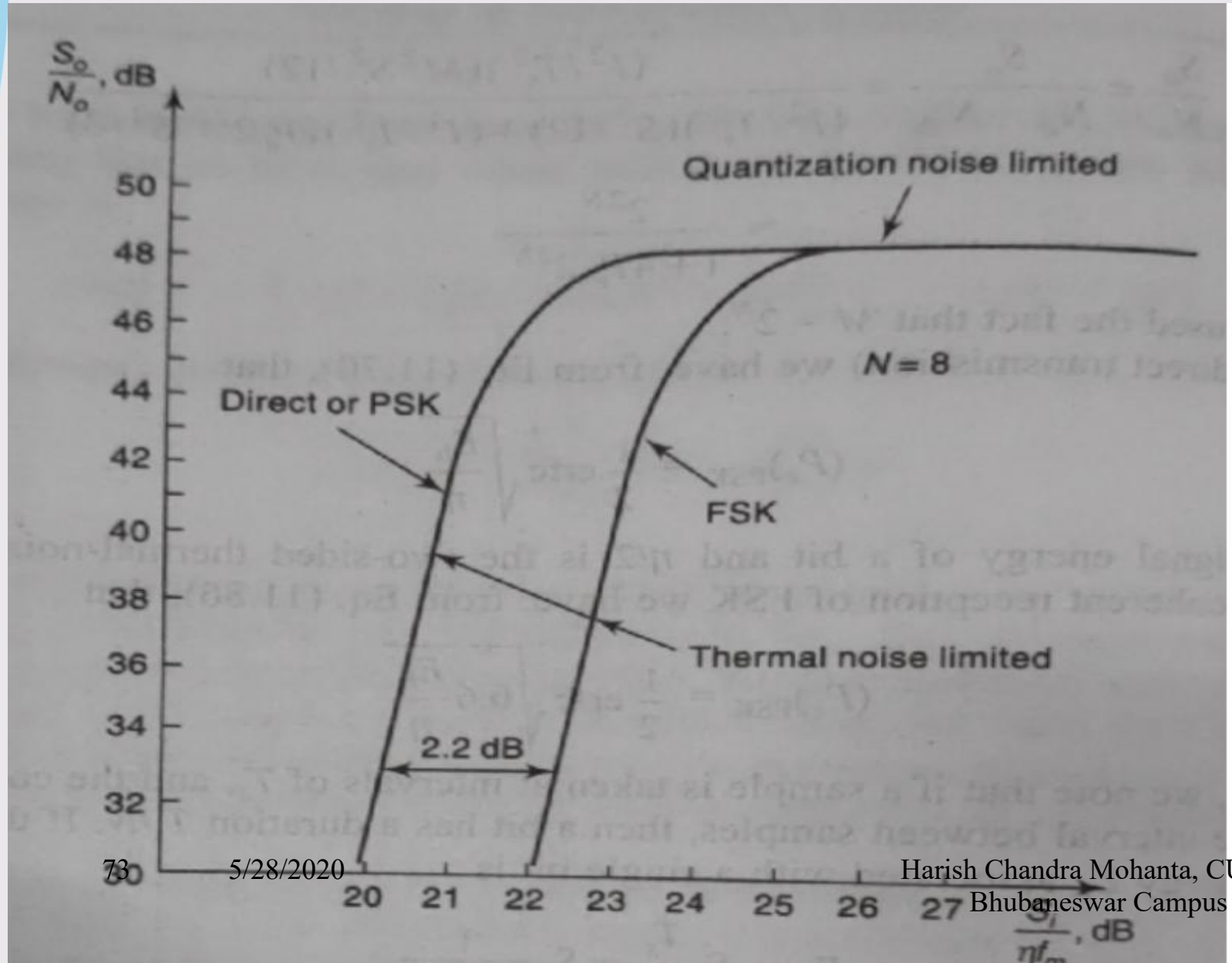



**Centurion**  
**UNIVERSITY**

*Shaping Lives...*  
*Empowering Communities...*

**THANK YOU..**



**Centurion**  
**UNIVERSITY**  
*Shaping Lives...  
Empowering Communities...*

# OUTLINE

- **Overview of PCM**
- **DPCM**
- **DM**
- **ADM**



# PCM

- Pulse digital base band data transmission techniques are PCM, DPCM, DM and ADM.
- PCM stands for Pulse Code Modulation.
- In n- bit PCM, step size =  $\Delta = \frac{V_{\max} - V_{\min}}{2^n}$

Where  $2^n$  = no. of quantization levels.

- The quantization noise power in PCM =  $N_q = \frac{\Delta^2}{12}$
- In order to decrease the quantization error, either we have to increase the value of n or decrease the value of  $V_{\max} - V_{\min}$ .
- $V_{\max} - V_{\min}$  is known as dynamic range of the input message signal.



**Centurion**  
**UNIVERSITY**

*Shaping Lives...  
Empowering Communities...*

# DPCM

- Differential Pulse Code Modulation (DPCM) is the process of converting an analog to digital signal in which the difference between the successive samples are applied to the quantizer.
- Block diagram of DPCM transmitter is shown here.

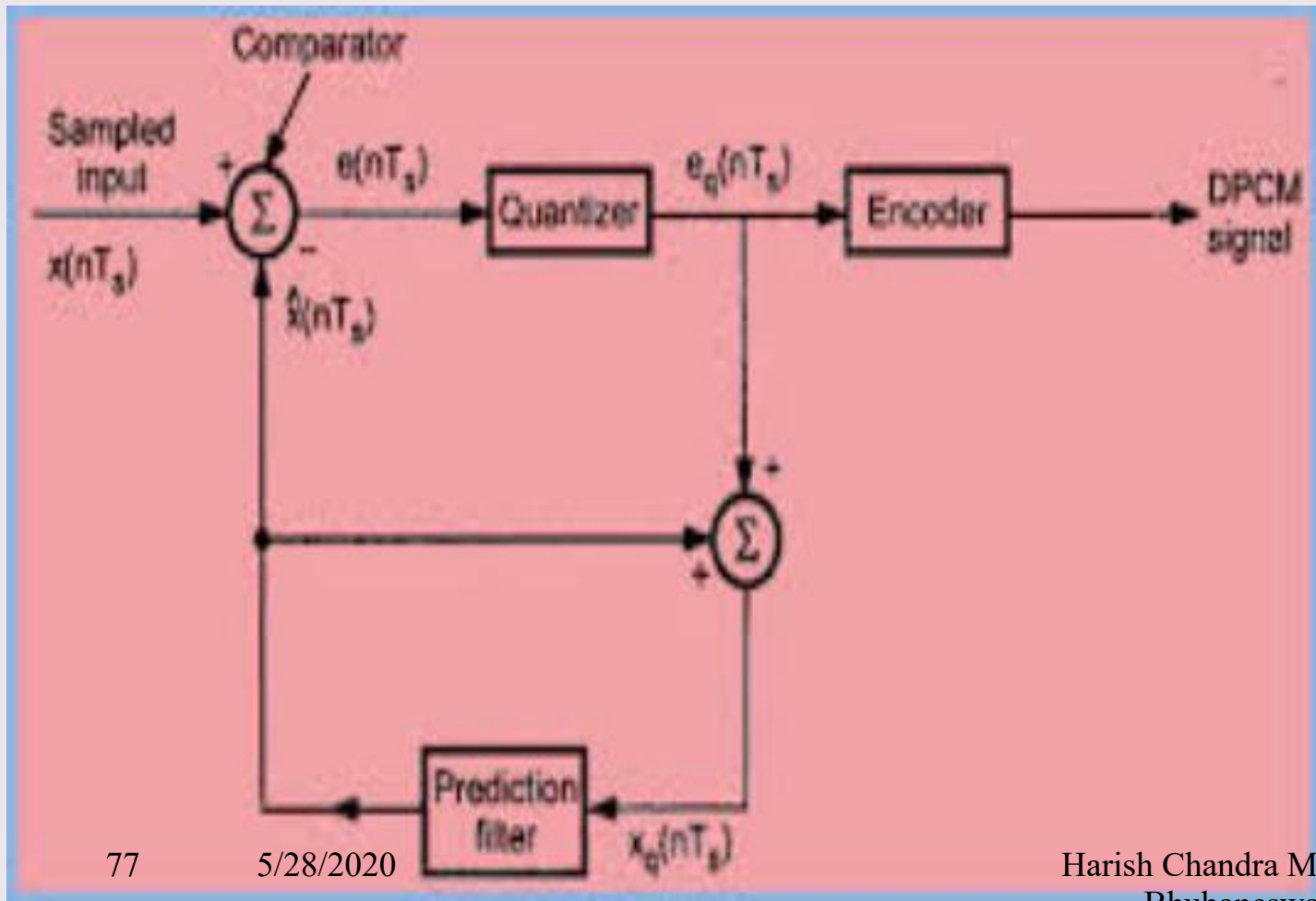



**Centurion**  
**UNIVERSITY**  
*Shaping Lives...  
Empowering Communities...*

# DPCM RECEIVER

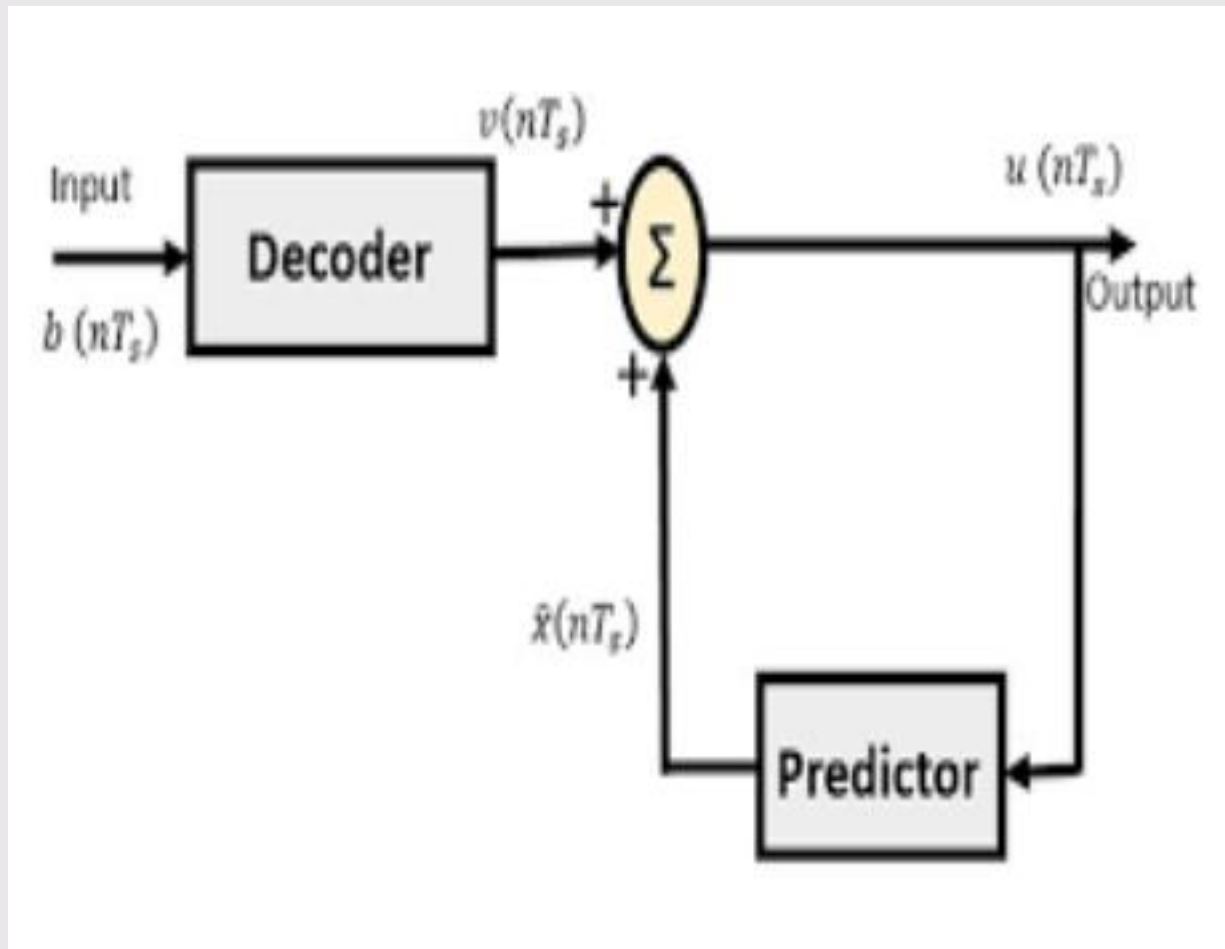



# Why DPCM?

- Reduces the quantisation error without increasing the no. of bits of  $n$ .
- Dynamic range of the quantizer can be minimised.
- For the dynamic range, the difference between two successive samples are applied.
- Bit rate is same as PCM
- *Bit rate:*  $R_b = \frac{n}{T_s}$
- Quantisation noise is reduced
- **DISADVANTAGE:** Hardware complexity.



Centurion  
UNIVERSITY

Shaping Lives...  
Empowering Communities...

# DM

- It is used to reduce the bandwidth of the signal
- It has 1-bit encoder.
- It is always considered as 1-bit DPCM.

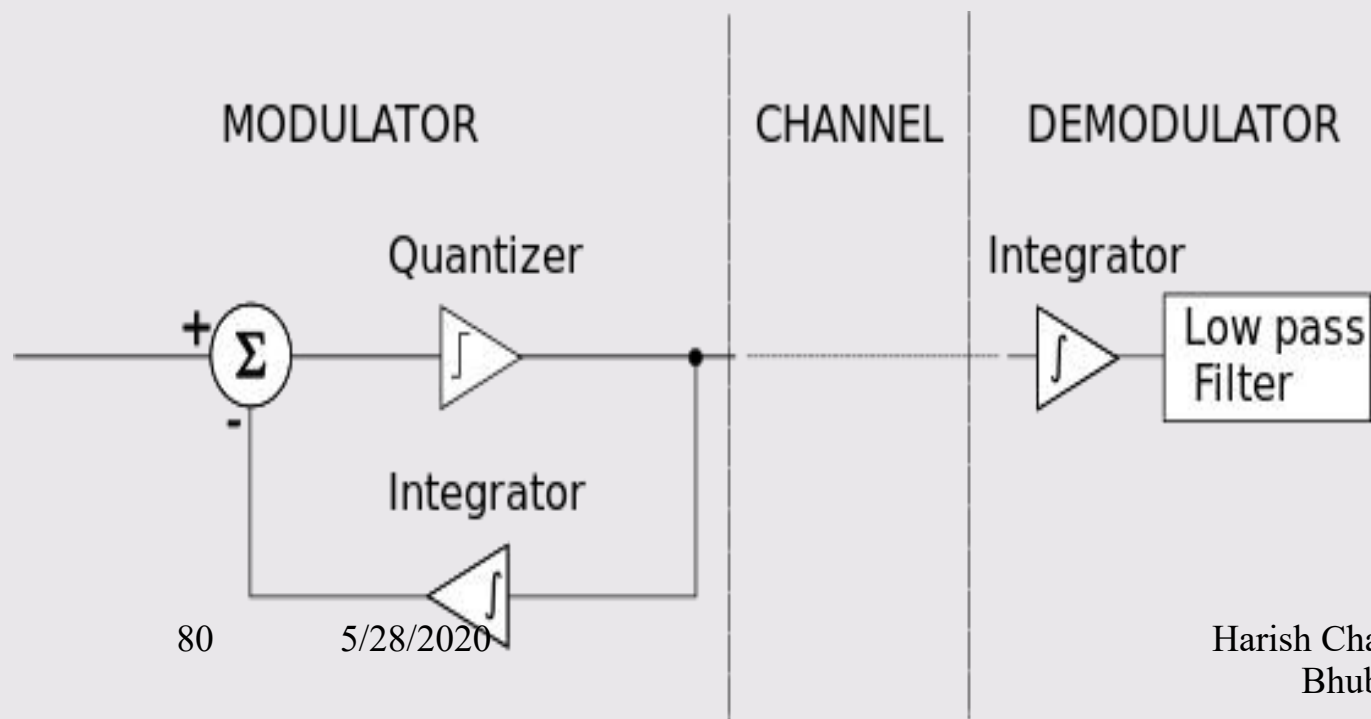

80

5/28/2020

Harish Chandra Mohanta, CUTM,  
Bhubaneswar Campus



**Centurion  
UNIVERSITY**

*Shaping Lives...  
Empowering Communities...*

# DM TRANSMITTER

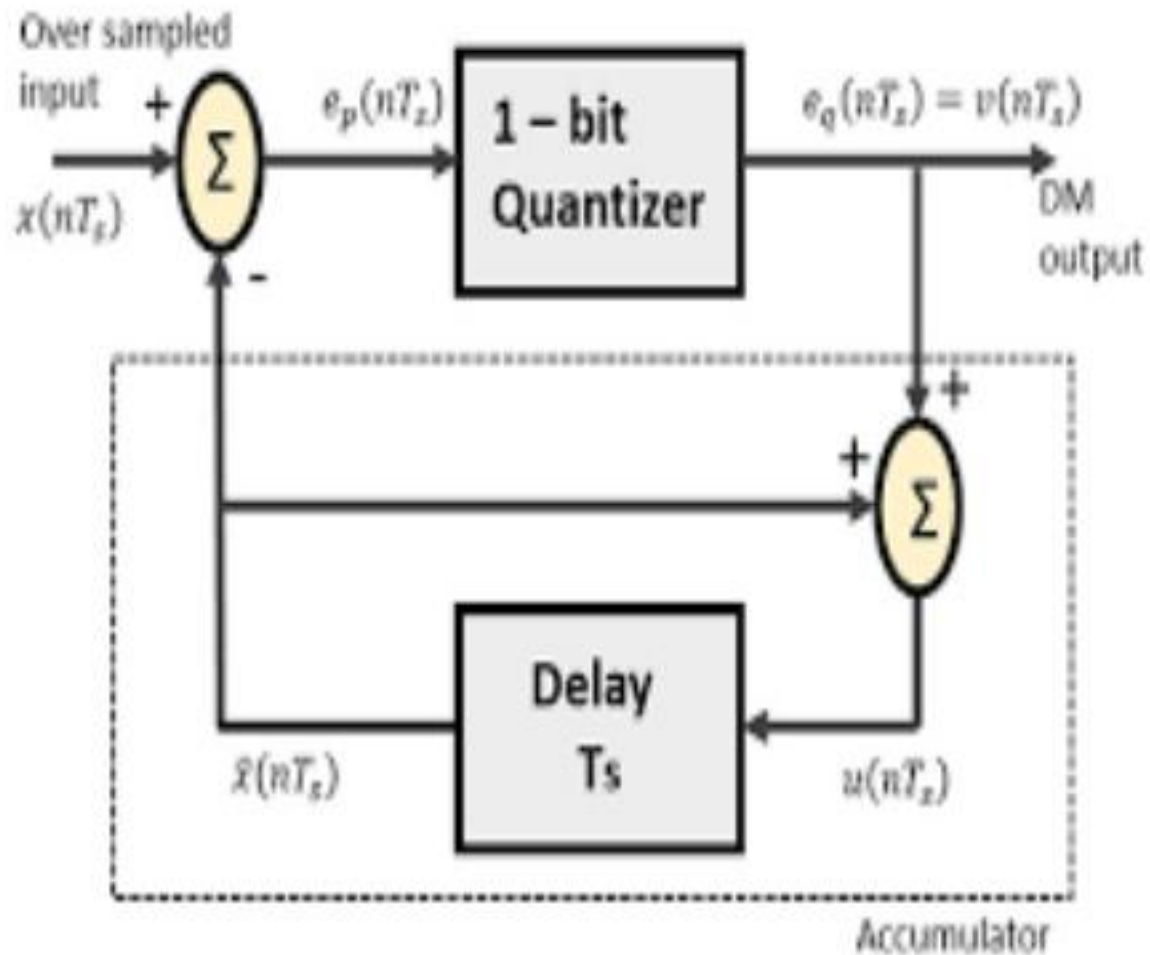



Centurion  
UNIVERSITY

Shaping Lives...  
Empowering Communities...

# DM RECEIVER

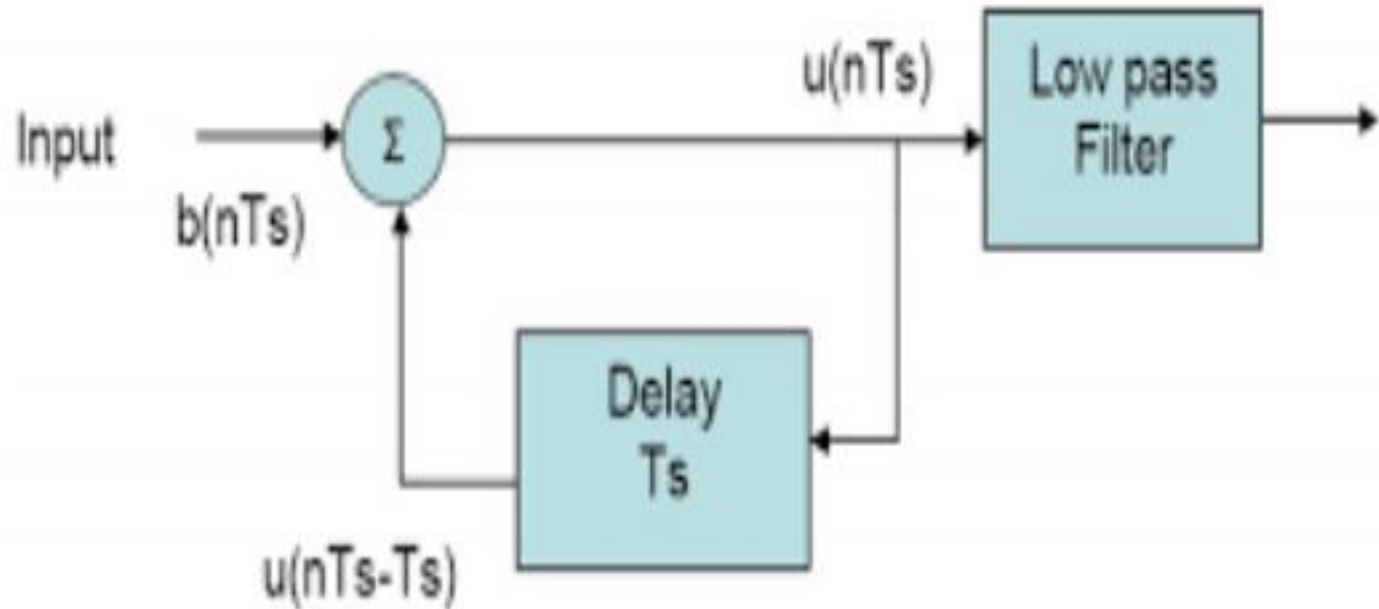

*Block diagram for Receiver of a DM system*



**Centurion**  
**UNIVERSITY**

*Shaping Lives...  
Empowering Communities...*

# Transfer characteristics of Quantizer in DM in terms of step size

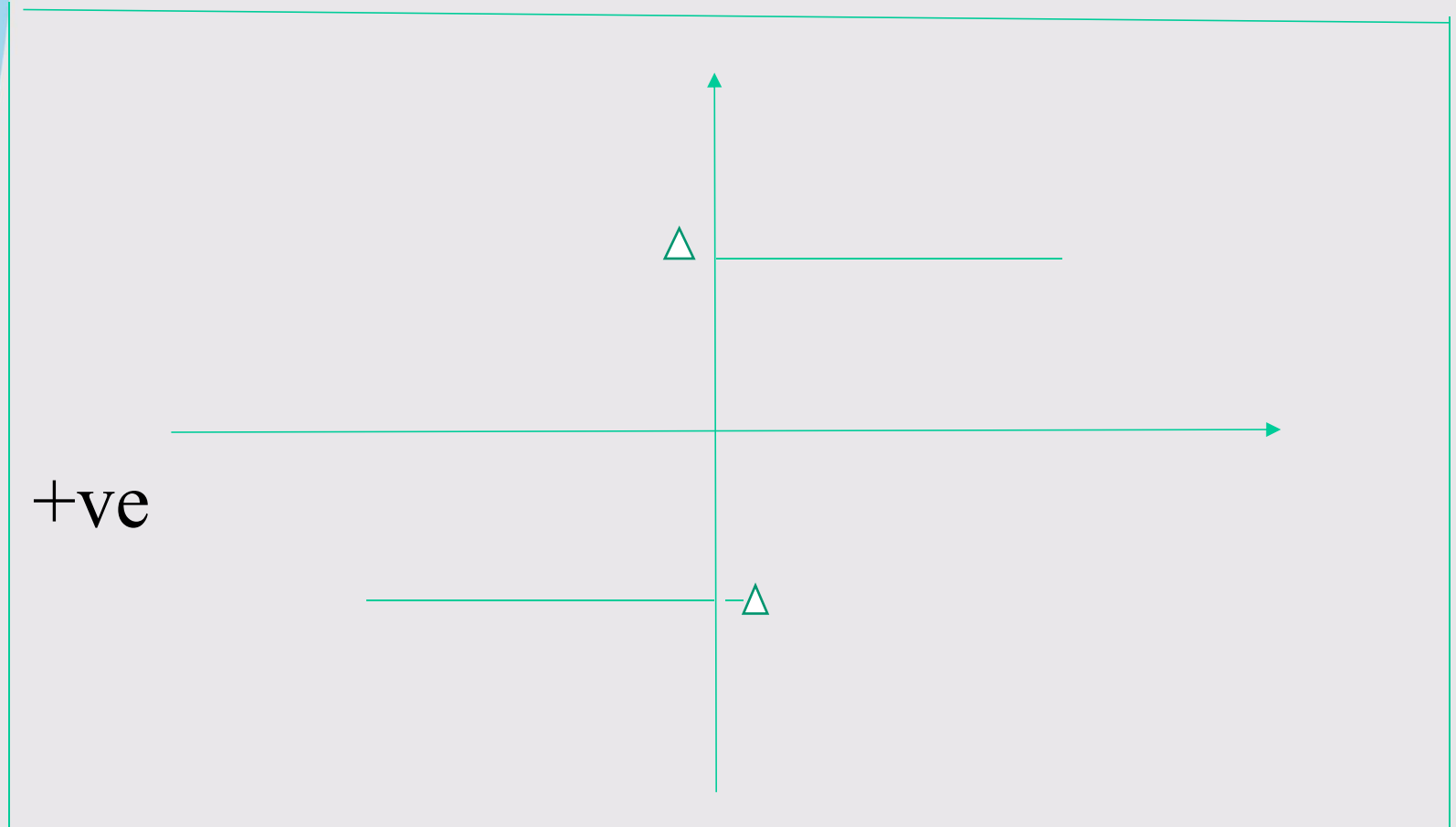



Centurion  
UNIVERSITY

Shaping Lives...  
Empowering Communities...

- In PCM, DPCM:-  $R_b = (1/T_s) * n$
- In DM:-  $n=1$

$$R_b = 1/T_s = \text{pulse rate}$$

- At the receiver '1' is decoded as  $+\Delta$  and '0' is decoded as  $-\Delta$ .
- So, the input to the LPF increases or decreases in terms of  $\Delta$ . The signal reconstruction depends on the value of  $\Delta$ .

Types of DM:-

### 1. Slope overload error:

- When the step size is very low; slope overload error occurs.

$$\frac{\Delta}{T_s} < \frac{d}{dt}m(t)$$



**Centurion**  
**UNIVERSITY**

Shaping Lives...  
Empowering Communities...

## 2. Granular Noise :

- When the slope of reconstructed signal is high as compared to  $\frac{d}{dt}m(t)$  ; then Granular noise occurs.

$$\frac{\Delta}{T_s} > \frac{d}{dt}m(t)$$

### NOTE:

- When the slope of transmitted waveform and slope of reconstructed waveform are same; there will be no error.

$$\frac{\Delta}{T_s} = \frac{d}{dt}m(t)$$

Here;  $\Delta = T_s \frac{d}{dt}m(t)$

$$\Delta = \frac{\text{Slope of the signal}}{\text{sampling rate}} = \frac{\frac{d}{dt}m(t)}{1/T_s}$$



**Centurion**  
**UNIVERSITY**

*Shaping Lives...  
Empowering Communities...*

## CASE 1:

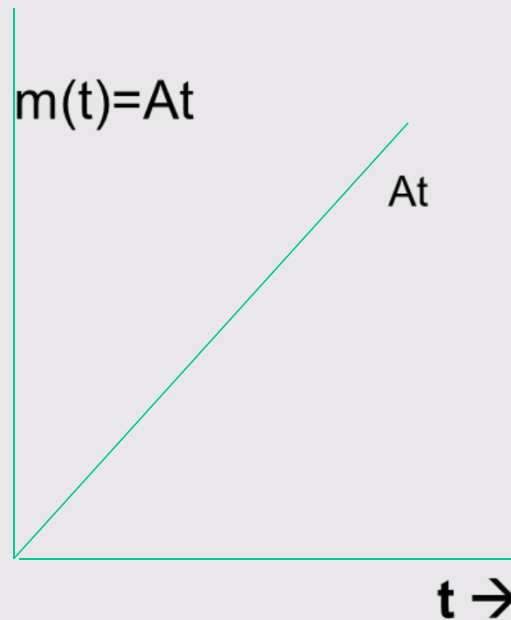

$$\frac{d}{dt} m(t) = \frac{d}{dt} (At) = A$$

$$\Delta = \frac{A}{1/T_s} = TsA$$



**Centurion**  
**UNIVERSITY**

Shaping Lives...  
Empowering Communities...

## CASE 2 :

$$\text{If } m(t) = A_m \cos 2\pi f_m t$$

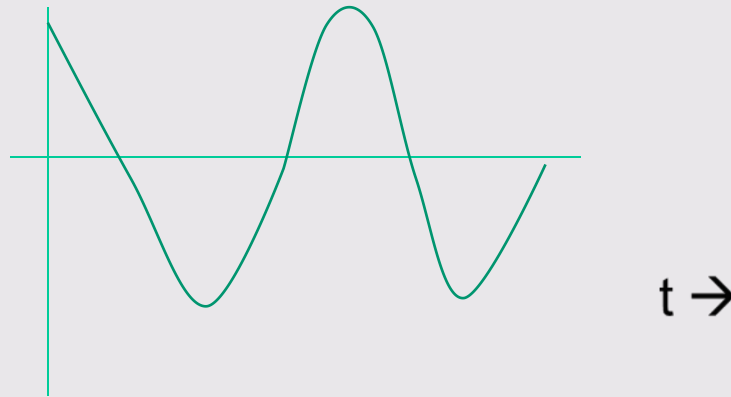

$$\text{Slope: } \frac{d}{dt} m(t) = \frac{d}{dt} A_m \cos 2\pi f_m t = -A_m \sin 2\pi f_m t \cdot 2\pi f_m$$

$$\frac{d}{dt} m(t) = -A_m 2\pi f_m \sin 2\pi f_m t$$

$$\frac{d}{dt} m(t) = A_m 2\pi f_m$$

$$\triangle_{\max} = \frac{A_m 2\pi f_m}{1/T_S}$$



Centurion  
UNIVERSITY

Shaping Lives...  
Empowering Communities...

# PROBLEMS

**Q1.** The i/p to the delta modulator is  $m(t)=5t$  and sampling rate is 5000 samples/sec. Determine the step size.

Ans- Here,  $m(t)=5t$ . So,  $dm(t)/dt=5$ .

Step size= $5/5000=5mV$ .

**Q2.** The i/p to the delta modulator is  $m(t)=5\cos 2\pi 1000t$  and the pulse rate is 56000 pulses/sec. Determine the step size.

Ans- Here  $A_m=5$  V,  $f_m=1000$ , pulse rate=bit rate=sampling rate=56000.

Step size=  $\Delta = \frac{5 \times 2\pi \times 1000}{56000}$  V (volt).



Centurion  
UNIVERSITY

Shaping Lives...  
Empowering Communities...

## ADM :

- Stands for adaptive delta modulation
- In ADM additional hardware is designed to provide **variable step size** .
- Thereby reducing slope overload effects without increasing the granular noise .



**Centurion**  
**UNIVERSITY**  
*Shaping Lives...  
Empowering Communities...*

# ADM TRANSMITTER

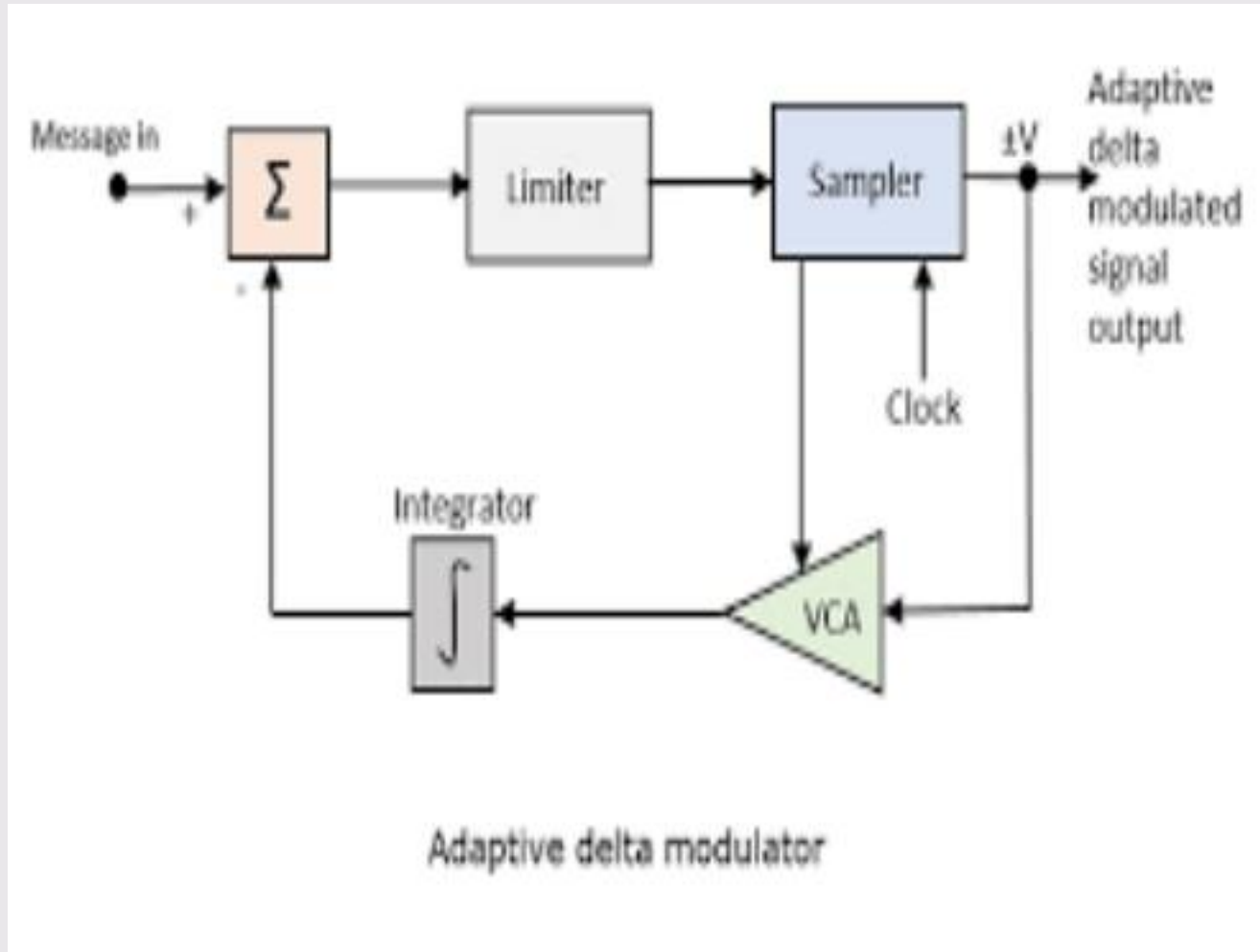



**Centurion**  
**UNIVERSITY**

*Shaping Lives...  
Empowering Communities...*

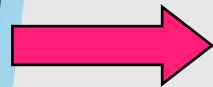

# Something More about the practical Approach

Delta Modulation De-merits

SNR Calculation for DM

Comparison of DM, DPCM and PCM

Adaptive delta Modulation



Centurion  
UNIVERSITY

Shaping Lives...  
Empowering Communities...

# Integrator

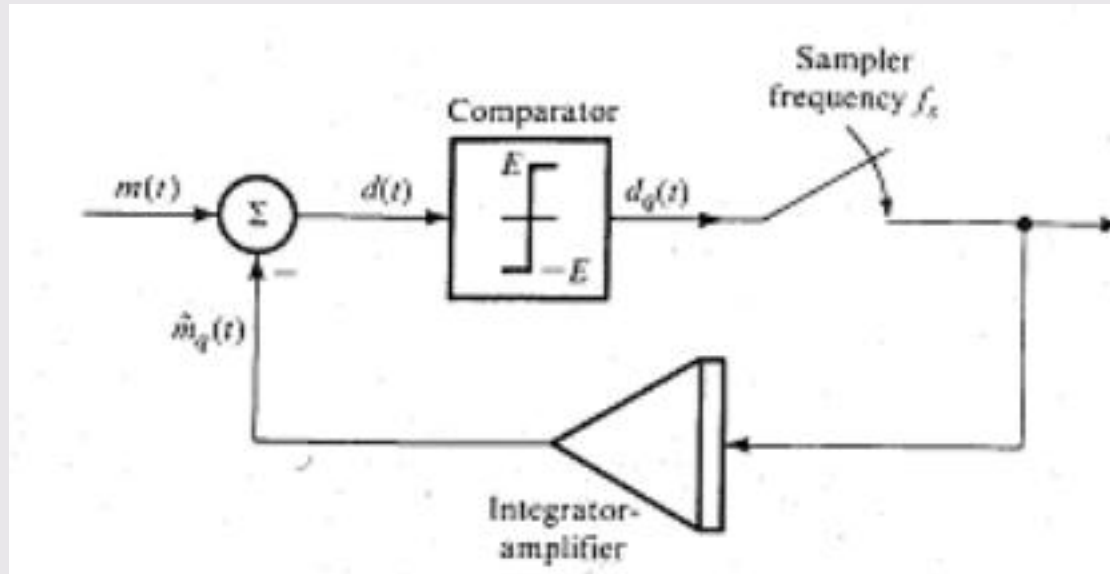

Integrator is nothing but a RC Low Pass filter.



Centurion  
UNIVERSITY

Shaping Lives...  
Empowering Communities...

# Characteristic of Quantizer

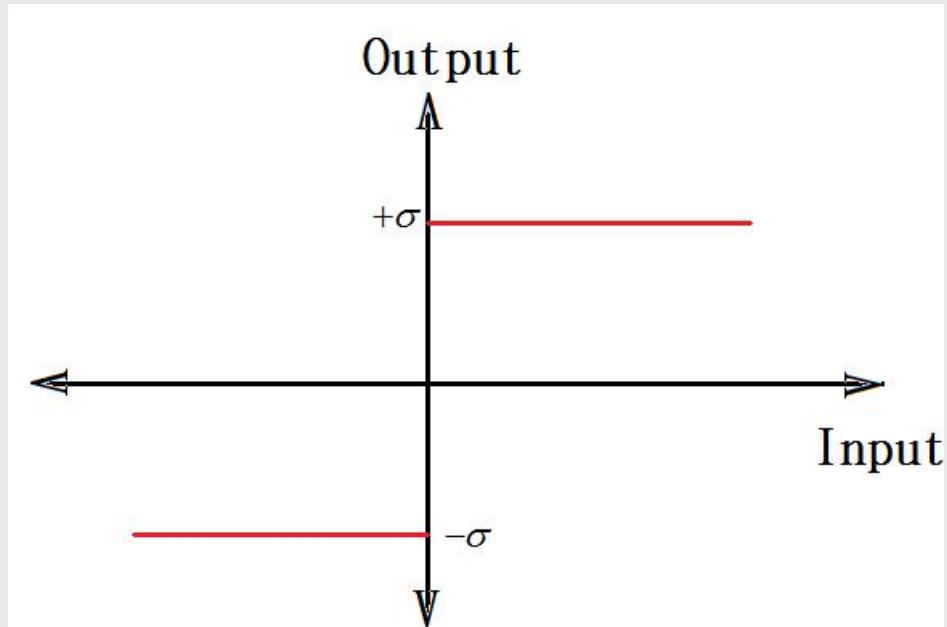

If the Difference is positive increase the Voltage by step-size  $\sigma$ , Vice-Versa.

Quantizer is 1 bit Quantizer.

Its simply a Voltage Comparator.



Centurion  
UNIVERSITY

Shaping Lives...  
Empowering Communities...

# Noise in DM

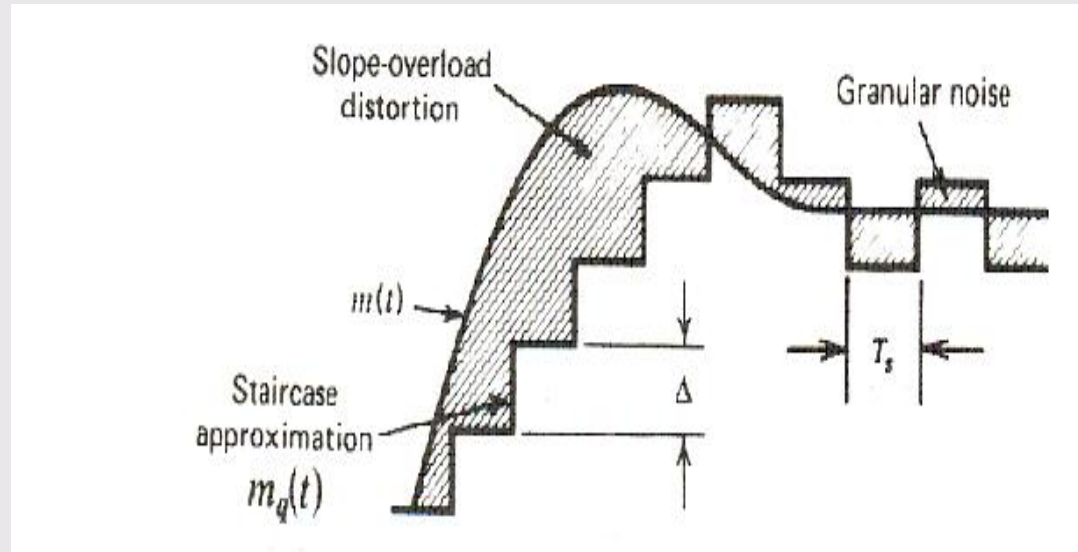

The key to effective use of DM is proper selection of step size  $\sigma$  and sampling Freq/Sampling Time.

They must be chosen in a such a way that stair-case approximation is close to message signal.

We can know the max frequency at which the signal is changing



Centurion  
UNIVERSITY

Shaping Lives...  
Empowering Communities...

# Noise in DM

To account fastest possible change we have to increase the sampling frequency as well as step size.

But Sampling Freq → Bandwidth



&

Larger the step Size → Quantization error





# Noise in DM

Ideally the slope of both Quantized signal and Message signal must match.

It requires that

$$\max \left| \frac{dm(t)}{dt} \right| \leq \frac{\sigma}{T_s} \quad \dots\dots\dots(7)$$

Suppose

$$m(t) = A \cos \omega t$$

Hence,

$$\left| \dot{m}(t) \right|_{\max} = A\omega \leq \sigma f_s \quad \dots\dots\dots(8)$$

So

$$A_{\max} = \frac{\sigma f_s}{\omega} \quad \dots\dots\dots(9)$$



Centurion  
UNIVERSITY

Shaping Lives...  
Empowering Communities...

# Noise in DM

The maximum Amplitude that we can follow for message signal can be given by

$$\left| A_{\max} \right|_{\text{Voice}} = \frac{\sigma f_s}{\omega_r} \quad \dots\dots\dots(10)$$

Where,

$$\omega_r = 2\pi \times 800$$

This equation is proved by de Jagger.

\* U may see, F. De. Jagger, “ Delta Modulation, a method of PCM transmission by 1 bit code”, Phillips Res. Rep. No 7 pp 442-466, 1952



Centurion  
UNIVERSITY

Shaping Lives...  
Empowering Communities...

# Noise in DM

Thus the maximum Amplitude that we can use without causing the slope overload can be found at frequency 800Hz.

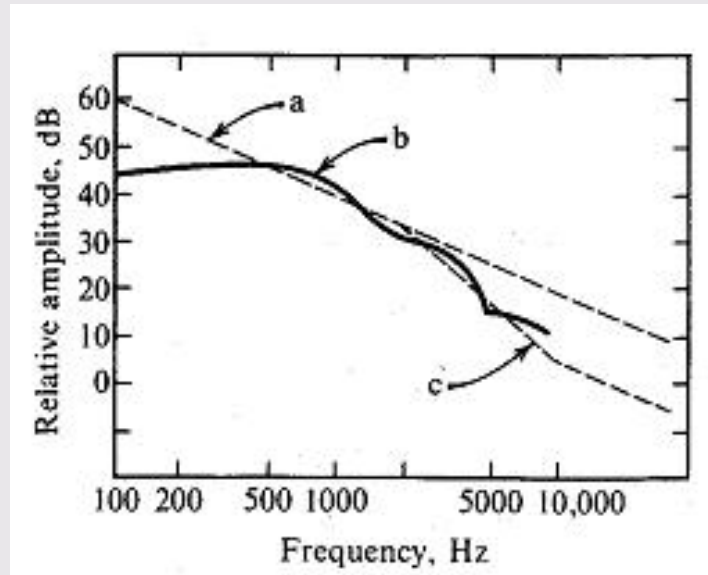

- Fortunately, Voice signal spectrum decays with frequency.
- Decreases as  $1/\omega$  up to 2000 Hz and beyond that by  $1/\omega^2$
- Hence Single Integration up to 2000Hz and Double for Beyond it
- Double Integrator Can be Built By 2 Cascade RC with time constant  $1/200\pi$  (100 Hz to 2KHz) and  $1/4000\pi$  ( $>2$ KHz) respectively.



Centurion  
UNIVERSITY

Shaping Lives...  
Empowering Communities...

# Noise in DM

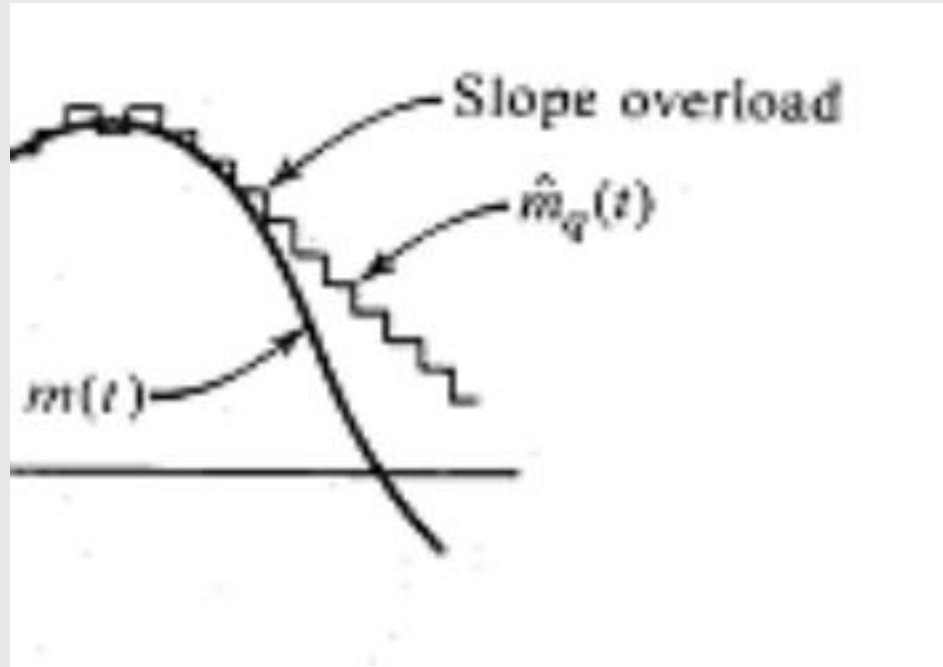

Slope overload

The name slope overload comes due to quantized signals fails to follow the slop of message signal.

The DM With Fixed step size is Linear Delta Modulation (LDM)



Centurion  
UNIVERSITY

Shaping Lives...  
Empowering Communities...

# Noise in DM

What would happen if we keep the step size larger?

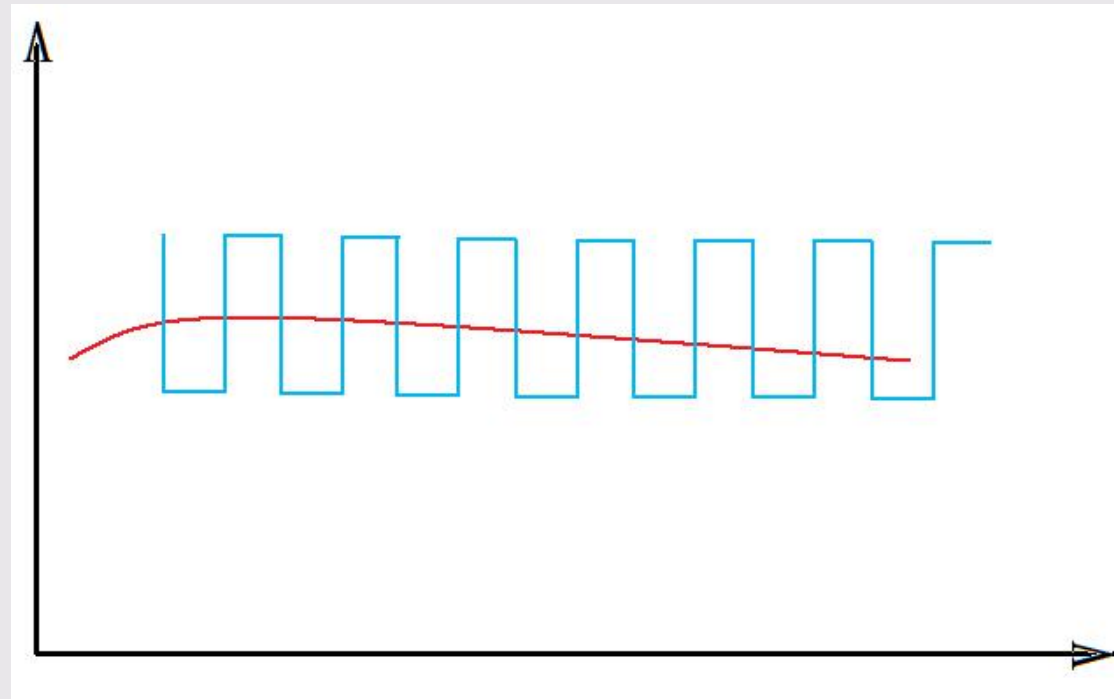

This would result into considerable Overshoot. This is Known as Hunting or Granular Noise.



Centurion  
UNIVERSITY

Shaping Lives...  
Empowering Communities...

# Signal To Noise Ratio

Granular Noise has Power Spectral Density in the range of well-beyond the  $f_s$ .

Band-limiting LPF can remove it.

Ideally Noise Power will be well-below the above equation.

To Compute Noise power we assume that PSD is uniform and in the range of 0 to  $f_s$  Hz. (Experimentally Proved)

$\sigma^2/3$  is total noise power, which is uniformly distributed over the range of  $f_s$ , the Power within Signal Bandwidth  $B$  is,

$$N_o = \left( \frac{\sigma^2}{3} \right) \bullet \left( \frac{B}{f_s} \right)$$

And

$$S_o = \overline{m^2(t)}$$

Harish Chandra Mohanta, CUTM,  
Bhubaneswar Campus



# Signal To Noise Ratio

Suppose  $m_p$  is the Signal Peak

$$m_p = \frac{\sigma f_s}{\omega_r} \dots\dots\dots(11)$$

Hence,

$$\sigma = \frac{\omega_r m_p}{f_s} \dots\dots\dots(12)$$

So SNR becomes

$$\frac{S_o}{N_o} = \frac{3 f_s m^2(t)}{\sigma^2 B} \dots\dots\dots(13)$$

Manipulating all equations

$$\frac{S_o}{N_o} = \frac{150}{\pi^2} \left( \frac{B_T}{B} \right)^3 \frac{\overline{m^2(t)}}{m_p^2}$$

$$\frac{S_o}{N_o} = 5.34 \left( \frac{B_T}{B} \right)^5 \frac{\overline{m^2(t)}}{m_p^2} *$$

For Single Integration 5/28/2020

For Double Integration

Where,  $B_T = f_s / 2$



# Signal To Noise Ratio (PCM)

In General,

$$\frac{S_o}{N_o} = c(2)^{2n} \dots\dots\dots(14)$$

Where,

$$c = \begin{cases} \frac{\overline{3m^2(t)}}{m_p^2} & \text{Uncompressed} \\ \frac{3}{[\ln(1 + \mu)]^2} & \text{Compressed} \end{cases} \dots\dots\dots(15)$$

But  $B_T = f_s / 2$       &       $B_T = n.B$        $\dots\dots\dots(16)$

Finally  $\frac{S_o}{N_o} = c(2)^{2BT/B}$



**Centurion**  
**UNIVERSITY**

*Shaping Lives...  
Empowering Communities...*

# Comparison Between DM and PCM

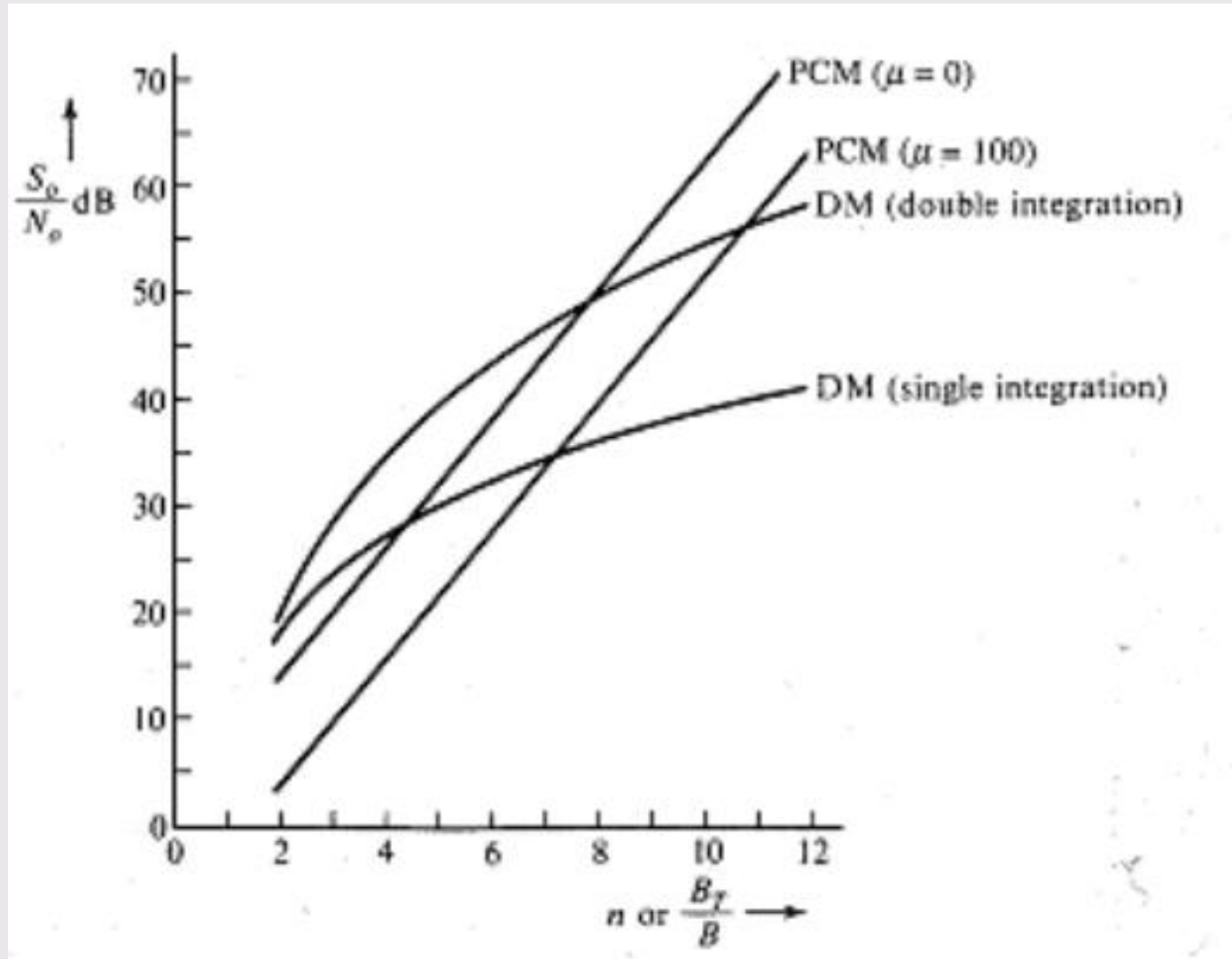



**Centurion**  
**UNIVERSITY**  
*Shaping Lives...*  
*Empowering Communities...*

# Thank You



**Centurion**  
**UNIVERSITY**  
*Shaping Lives...  
Empowering Communities...*

# DPSK

Harish Chandra Mohanta, CUTM, Bhubaneswar Campus



**Centurion**  
**UNIVERSITY**

*Shaping Lives...  
Empowering Communities...*

# INTRODUCTION

- Phase shift keying is a digital modulation scheme that conveys data by changing (modulating) the phase of a reference signal (the carrier wave).
- PSK uses a finite number of phases, each assigned a unique pattern of binary digits. Usually, each phase encodes an equal number of bits. Each pattern of bits forms the symbol that is represented by the particular phase.
- The demodulator, which is designed specially for the symbol set used by the modulator, determines the phase of received signal and maps it back to the symbol it represents, thus recovering the original data.
- **Differential phase shift keying (DPSK)** is a common form of phase modulation that conveys data by changing the phase of the carrier wave.



**Centurion**  
**UNIVERSITY**

Shaping Lives...  
Empowering Communities...

# DPSK

Differential phase shift keying (DPSK) is a common form of phase modulation that conveys data by changing the phase of the carrier wave. DPSK is similar to BPSK with the only addition of differential encoder, i.e., in differentially encoded BPSK a binary '1' may be transmitted by adding  $180^\circ$  to the current phase and a binary '0' by adding  $0^\circ$  to the current phase.

DPSK Transmitter :-

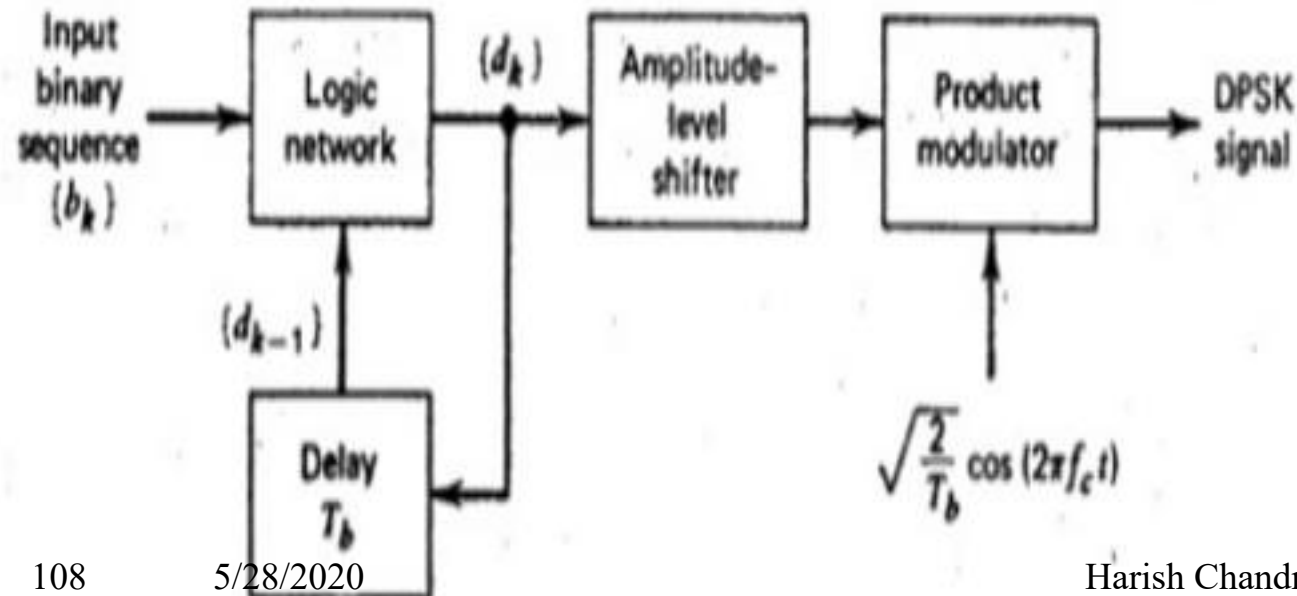



Centurion  
UNIVERSITY

Shaping Lives...  
Empowering Communities...

# DPSK

The logic network and the delay circuit together form the differential encoder and can be realized using a X-NOR gate and D-F/F to generate a delay as shown below.

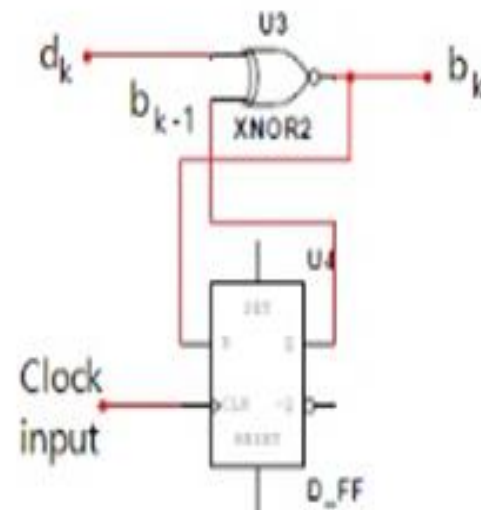

The main transmitting section is realized as follows using two carriers with 180 degree phase shift which are then multiplexed by the following circuit such that the carrier sine wave with 180 degree phase shift is passed on '1' and carrier sine wave with 0 degree phase shift is passed on '0'.



Centurion  
UNIVERSITY

Shaping Lives...  
Empowering Communities...

# DPSK RECEIVER

## DPSK Receiver

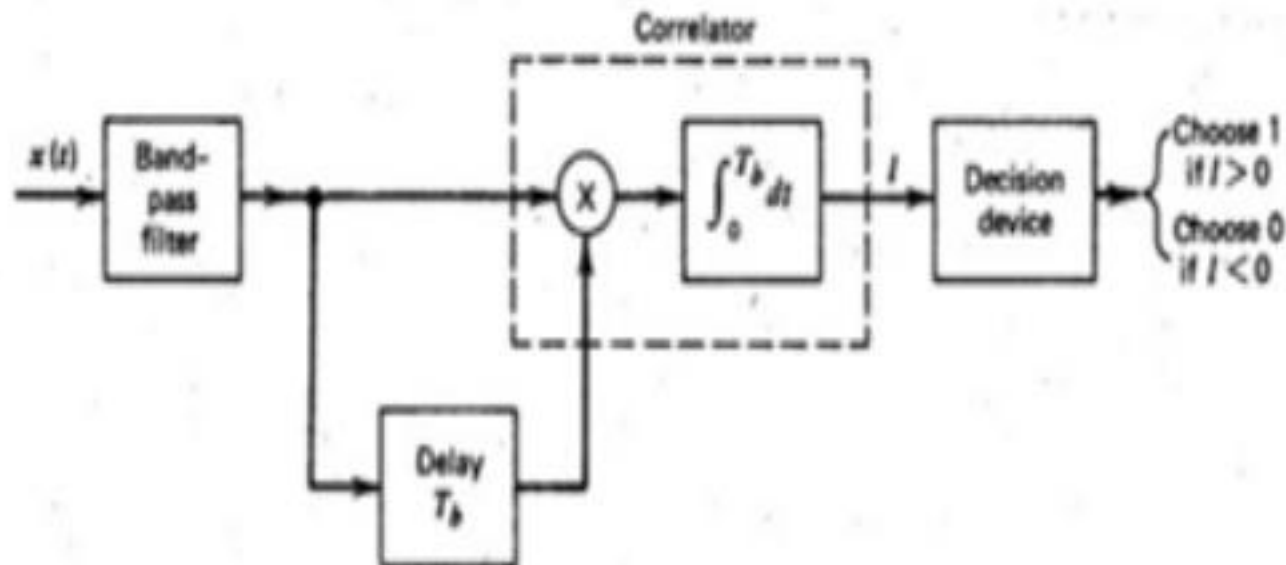

The receiver block diagram is as shown above. The band pass filter is used to remove noise from the received signal. It is followed by a comparator, decision device, i.e., Schmitt Trigger and finally a differential decoder.



**Centurion**  
**UNIVERSITY**

*Shaping Lives...  
Empowering Communities...*

## PROGRAM

### DPSK transmitter

```
nS=1000;
nSym=2000; %Number of samples
M=2;
Tb=1e-6; %Bit rate
fc=1e6; %Carrier frequency

s=randi([0 M-1],nSym,1); %Information signal

s_mod=pskmod(s,M,pi); %NRZ Polar encoder
s_mod=rectpulse(s_mod,nS);

h1=scatterplot(s_mod);

t=0:(Tb/nS):nSym*Tb-(Tb/nS); %Time domain
t=transpose(t);

figure(2);plot(t,s_mod)
axis([0 (10*Tb-(Tb/(nS))) -1.2 1.2]); %plot only first 10 bits
title('Input bit stream after NRZ Encoder');
xlabel('Time(seconds)');
ylabel('amplitude');

s_tx_nn=s_mod.*cos(2*pi*fc*t)
```

### Channel with AWGN Noise

```
%Additive Channel Noise
att=1;
SNR=1;
s_tx_noise=awgn(s_tx_nn,SNR,'measured');
h2=scatterplot(s_tx_noise,nS,nS/2);

%Additive Channel attenuation(10dB)
s_tx_noise_att=s_tx_noise/att;
```



**Centurion**  
**UNIVERSITY**

*Shaping Lives...  
Empowering Communities...*

### DPSK Receiver

```
s_tx=s_tx_noise_att;  
s_rx=s_tx.*cos(2*pi*fc*t);  
figure;plot(t,s_rx);  
axis([0 (10*Tb-(Tb/(nS))) -2/att 2/att]);  
title('Recieved Signal Before Integration')  
xlabel('Time(Seconds)')  
ylabel('Amplitude')  
  
figure;stem(0:nS*nSym-1, s_mod(1 :nS*nSym))  
plot(t,s_tx_noise_att,'g')  
hold on  
plot(t,s_tx_nn/att,'LineWidth',1); %DPSK madulated signal+Noise  
axis([0 (10*Tb-(Tb/(nS))) -2/att 2/att]);  
title('Tx vs. Rx (Normalized)')  
xlabel('Time (Seconds) ')  
ylabel('Amplitude')  
  
h3=scatterplot(s_rx,nS,nS/2);%Scatter Plot in presence of Noise  
y=intdump(s_rx,nS);  
y_mod=rectpulse(y,nS);  
h4=scatterplot(y_mod, nS, nS/2);%Scatter Plot when Noise is removed  
r_mod=pskdemod(y_mod,M,pi);%DPSK Demodulation  
figure; plot(t,r_mod)  
axis([0 (10*Tb-(Tb/(nS))) -0.2 1.2]);  
title('Demodulated output')  
xlabel('Time (seconds) ')  
ylabel('Amplitude')
```



**Centurion**  
**UNIVERSITY**

*Shaping Lives...  
Empowering Communities...*

### DPSK Receiver

```
s_tx=s_tx_noise_att;
s_rx=s_tx.*cos(2*pi*fc*t);
figure;plot(t,s_rx);
axis([0 (10*Tb-(Tb/(nS))) -2/att 2/att]);
title('Recieved Signal Before Integration')
xlabel('Time(Seconds)')
ylabel('Amplitude')

figure;stem(0:nS*nSym-1, s_mod(1 :nS*nSym))
plot(t,s_tx_noise_att,'g')
hold on
plot(t,s_tx_nn/att,'LineWidth',1); %DPSK madulated signal+Noise
axis([0 (10*Tb-(Tb/(nS))) -2/att 2/att]);
title('Tx vs. Rx (Normalized)')
xlabel('Time (Seconds) ')
ylabel('Amplitude')

h3=scatterplot(s_rx,nS,nS/2);%Scatter Plot in presence of Noise
y=intdump(s_rx,nS);
y_mod=rectpulse(y,nS);
h4=scatterplot(y_mod, nS, nS/2);%Scatter Plot when Noise is removed
r_mod=pskdemod(y_mod,M,pi);%DPSK Demodulation
figure; plot(t,r_mod)
axis([0 (10*Tb-(Tb/(nS))) -0.2 1.2]);
title('Demodulated output')
xlabel('Time (seconds) ')
ylabel('Amplitude')
```



**Centurion**  
**UNIVERSITY**  
*Shaping Lives...  
Empowering Communities...*

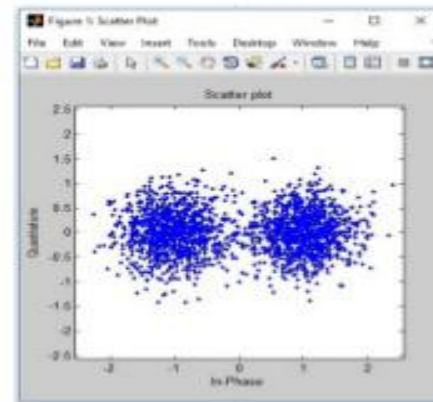
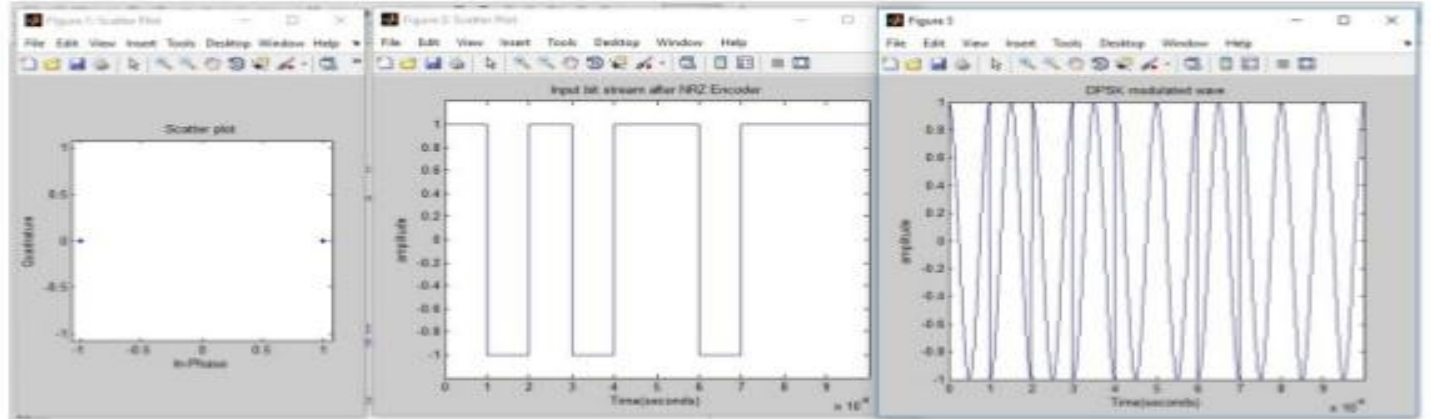



**Centurion**  
**UNIVERSITY**  
*Shaping Lives...  
Empowering Communities...*

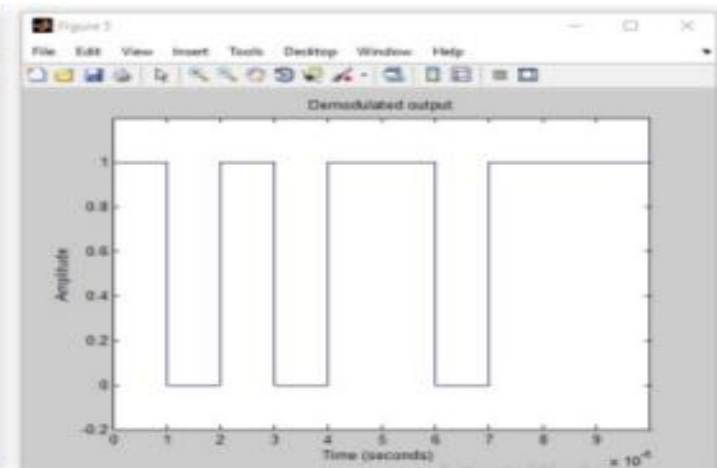
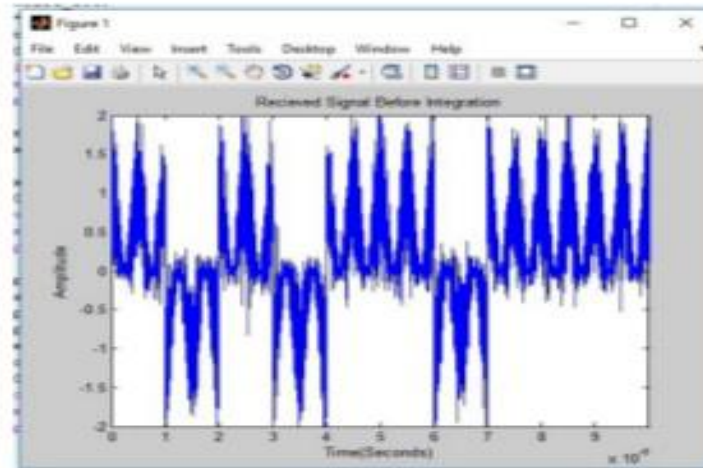
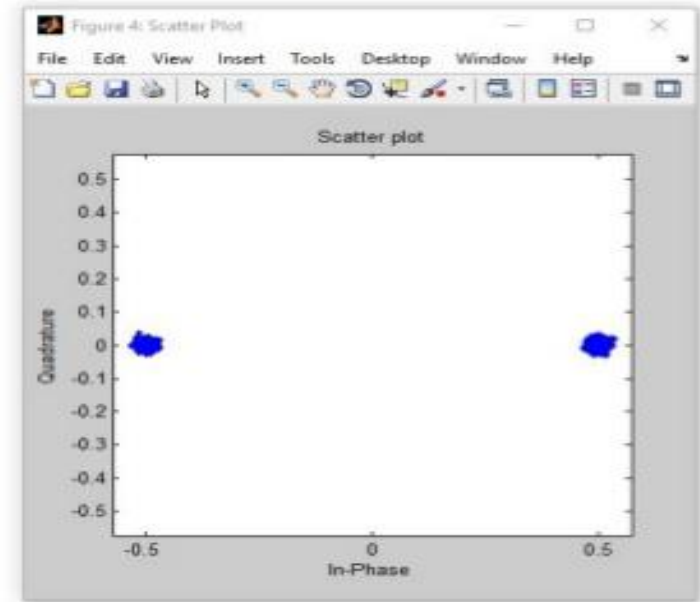
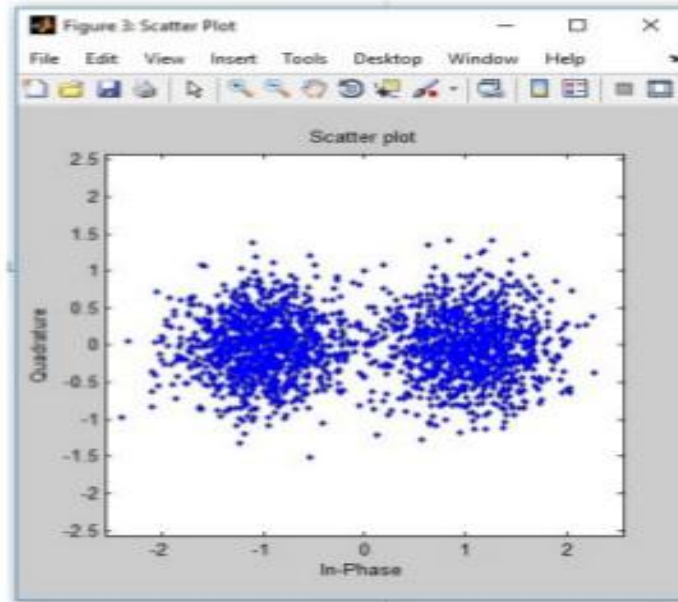



**Centurion**  
**UNIVERSITY**

*Shaping Lives...*  
*Empowering Communities...*

# Digital Modulation



Centurion  
UNIVERSITY

Shaping Lives...  
Empowering Communities...

# Change which part of the Carrier?

Carrier:  $A \sin[\omega t + \varphi]$

$$A = \text{const}$$

$$\omega = \text{const}$$

$$\varphi = \text{const}$$

Amplitude modulation (AM)

$A = A(t)$  – carries information

$$\omega = \text{const}$$

$$\varphi = \text{const}$$

Frequency modulation (FM)

$$A = \text{const}$$

$\omega = \omega(t)$  – carries information

$$\varphi = \text{const}$$

Phase modulation (PM)

$$A = \text{const}$$

$$\omega = \text{const}$$

$\varphi = \varphi(t)$  – carries information



Centurion  
UNIVERSITY

Shaping Lives...  
Empowering Communities...

# Amplitude Shift Keying (ASK)

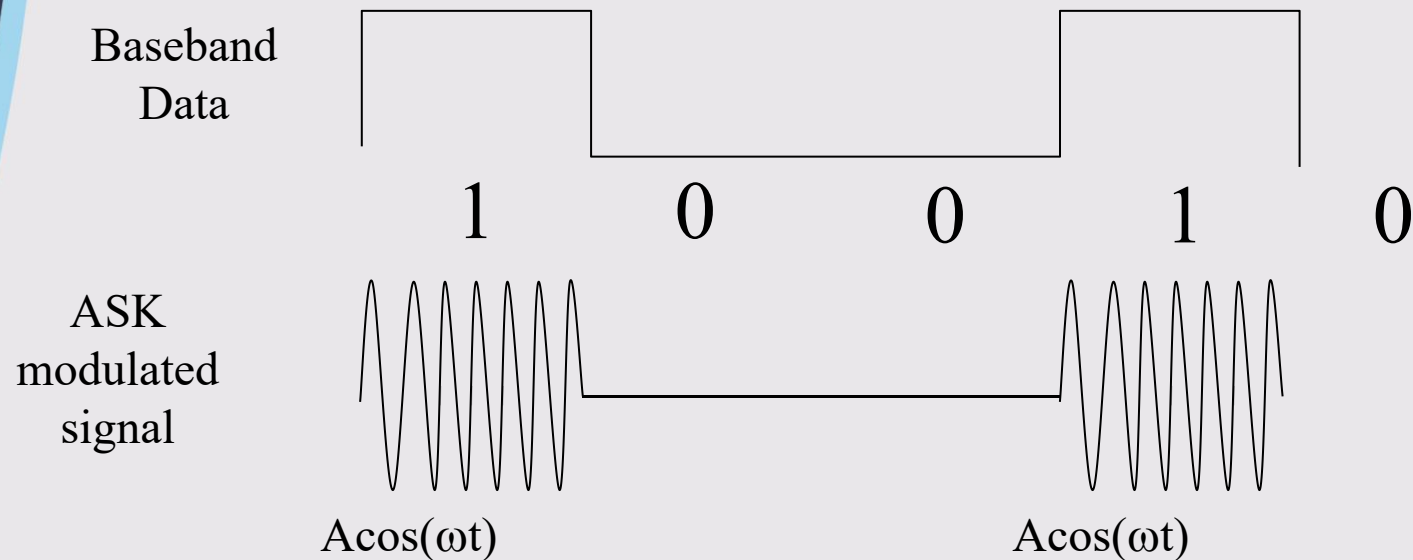

Pulse shaping can be employed to remove spectral spreading  
ASK demonstrates poor performance, as it is heavily affected  
by noise, fading, and interference



Centurion  
UNIVERSITY

Shaping Lives...  
Empowering Communities...

# Frequency Shift Keying (FSK)

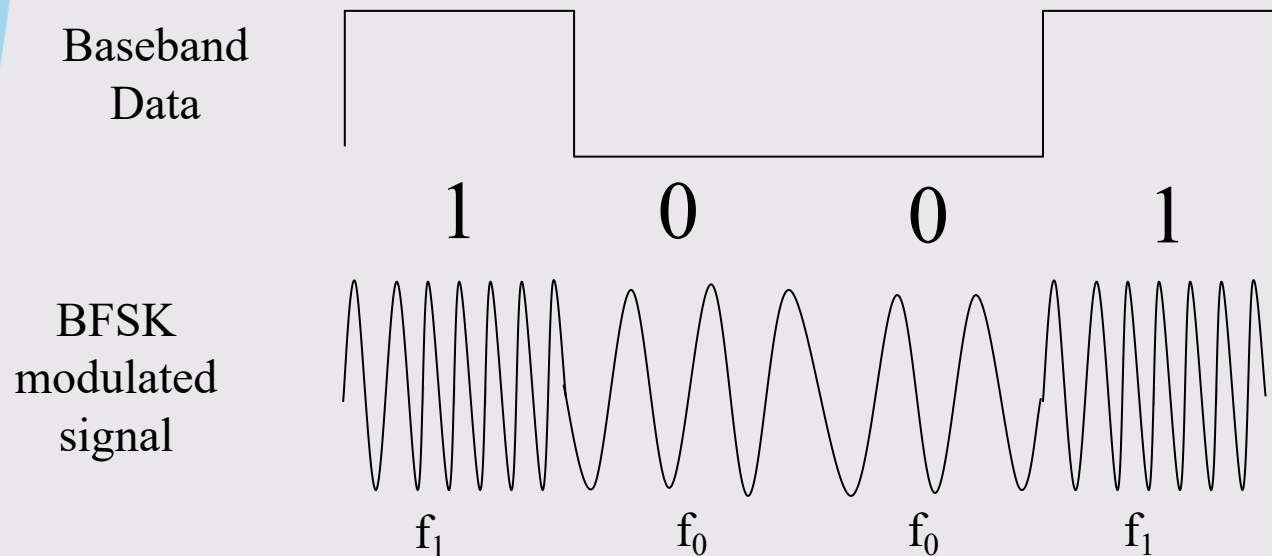

where  $f_0 = A\cos(\omega_c - \Delta\omega)t$  and  $f_1 = A\cos(\omega_c + \Delta\omega)t$

Example: The ITU-T V.21 modem standard uses FSK  
FSK can be expanded to a M-ary scheme, employing multiple frequencies as different states



Centurion  
UNIVERSITY

Shaping Lives...  
Empowering Communities...

# Phase Shift Keying (PSK)

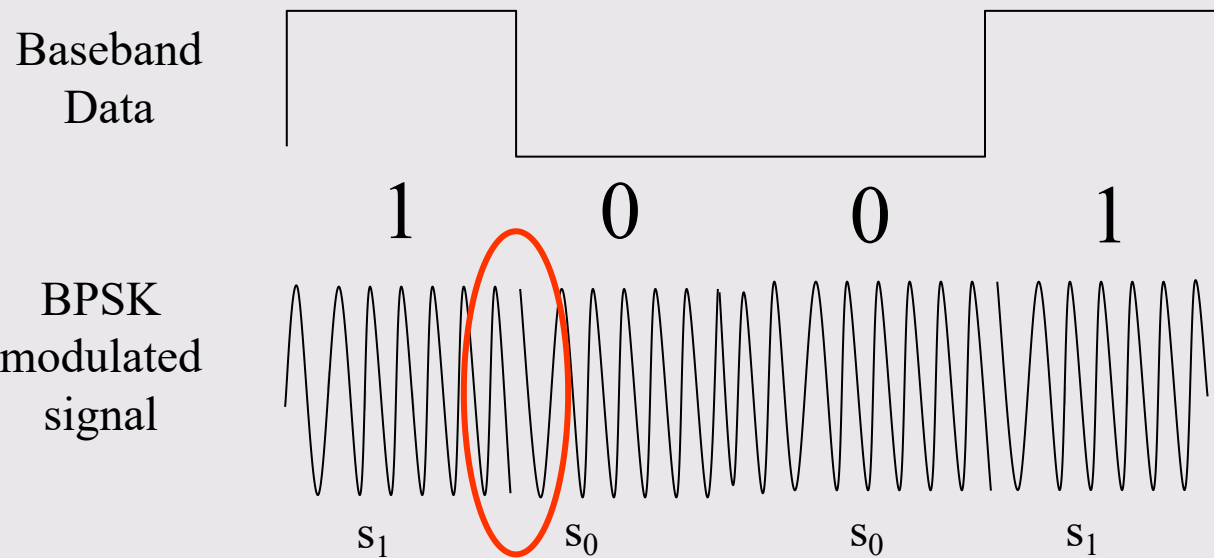

where  $s_0 = -A\cos(\omega_c t)$  and  $s_1 = A\cos(\omega_c t)$

Major drawback – rapid amplitude change between symbols due to phase discontinuity, which requires infinite bandwidth. Binary Phase Shift Keying (BPSK) demonstrates better performance than ASK and BFSK. BPSK can be expanded to a M-ary scheme, employing multiple phases and amplitudes as different states.



**Centurion**  
**UNIVERSITY**

Shaping Lives...  
Empowering Communities...

## Binary Phase Shift Keying (BPSK)

If the sinusoidal carrier has an amplitude  $A_c$  and energy per bit  $E_b$

Then the transmitted BPSK signal is either:

$$S_{\text{BPSK}}(t) = \sqrt{\frac{2E_b}{T_b}} \cos(2\pi f_c t + \theta_c) \quad 0 \leq t \leq T_b \text{ (binary 1)}$$

$$\begin{aligned} S_{\text{BPSK}}(t) &= \sqrt{\frac{2E_b}{T_b}} \cos(2\pi f_c t + \pi + \theta_c) \\ &= -\sqrt{\frac{2E_b}{T_b}} \cos(2\pi f_c t + \theta_c) \quad 0 \leq t \leq T_b \text{ (binary 0)} \end{aligned}$$



**Centurion**  
**UNIVERSITY**

*Shaping Lives...  
Empowering Communities...*

## **Linear Modulation Techniques:**

Digital modulation can be broadly classified as:

1. Linear (change Amplitude or phase)
2. Non linear modulation techniques (change frequency).

Linear Modulation Techniques:

- The amplitude /phase of the transmitted signal  $s(t)$ , varies linearly with the modulating digital signal,  $m(t)$ .
- These are bandwidth efficient (because it doesn't change frequency) and hence are very attractive for use in wireless communication systems where there is an increasing demand to accommodate more and more users within a limited spectrum.



**Centurion**  
**UNIVERSITY**

*Shaping Lives...  
Empowering Communities...*

- Linear Modulation schemes have very good spectral efficiency,
- However, they must be transmitted using linear RF amplifiers which have poor power efficiency.



Centurion  
UNIVERSITY

Shaping Lives...  
Empowering Communities...

# Note

“Phase modulation” can be regarded as “amplitude” modulation because it can really change “envelope”;

Thus both of them belong to “linear modulation”!



Centurion  
UNIVERSITY

Shaping Lives...  
Empowering Communities...

# Differential Modulation

- In the transmitter, **each symbol is modulated relative to the previous symbol and modulating signal**, for instance in BPSK  $0 = \text{no change}$ ,  $1 = +180^\circ$
- In the receiver, the current symbol is demodulated **using the previous symbol as a reference**. The previous symbol serves as an estimate of the channel. A no-change condition causes the modulated signal to remain at the same 0 or 1 state of the previous symbol.

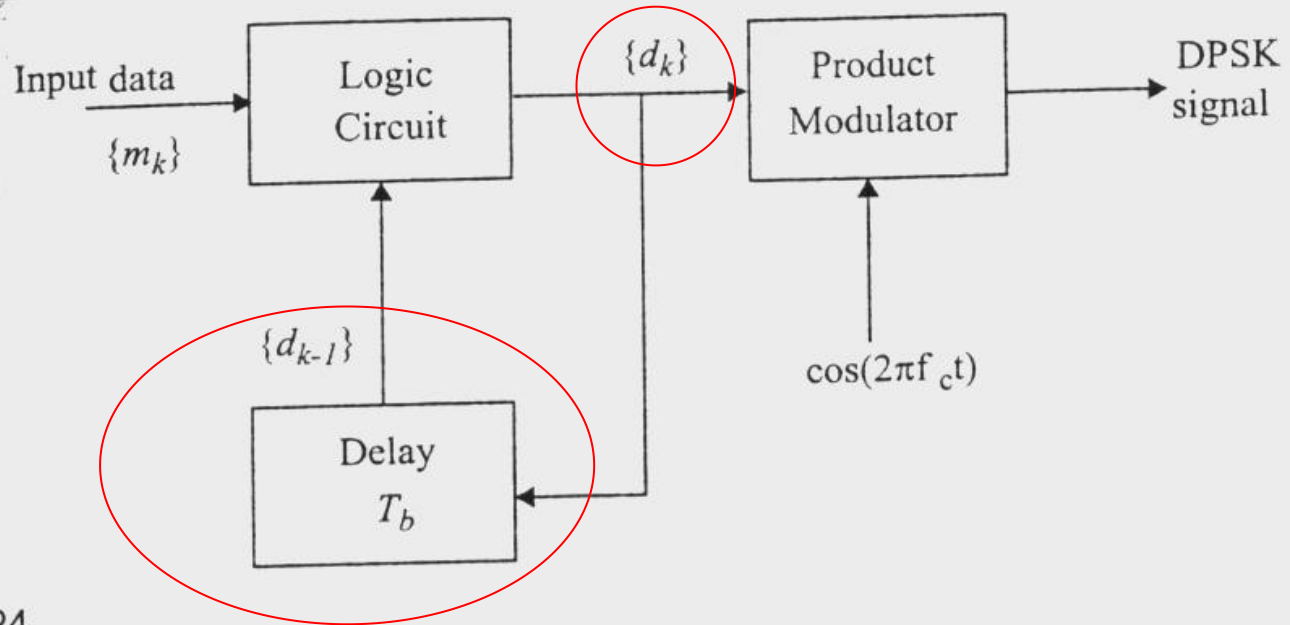

Figure 5.24  
Block diagram of a DPSK transmitter.

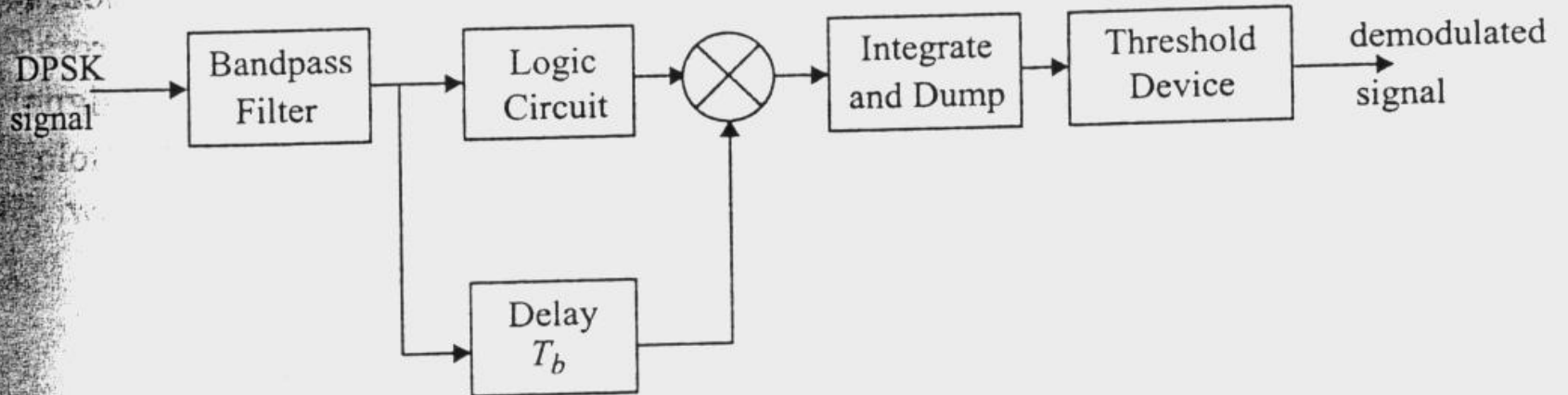

Figure 5.25  
Block diagram of DPSK receiver.



**Centurion**  
**UNIVERSITY**

Shaping Lives...  
Empowering Communities...

Table 5.1 Illustration of the Differential Encoding Process

$\{m_k\}$		1	0	0	1	0	1	1	0
$\{d_{k-1}\}$		1	1	0	1	1	0	0	0
$\{d_k\}$	1	1	0	1	1	0	0	0	1



Centurion  
UNIVERSITY

Shaping Lives...  
Empowering Communities...

# DPSK

Let  $\{d_k\}$  denote the differentially encoded sequence with this added reference bit. We now introduce the following definitions in the generation of this sequence:

- If the incoming binary symbol  $b_k$  is 1, leave the symbol  $d_k$  unchanged with respect to the previous bit.
- If the incoming binary symbol  $b_k$  is 0, change the symbol  $d_k$  with respect to the previous bit.



**Centurion**  
**UNIVERSITY**

Shaping Lives...  
Empowering Communities...

# DPSK

- to send symbol 0, we advance the phase of the current signal waveform by 180 degrees,
- to send symbol 1, we leave the phase of the current signal waveform unchanged.

## *Generation of DPSK:*

- The differential encoding process at the transmitter input starts with an arbitrary first bit, serving as reference.



Centurion  
UNIVERSITY

Shaping Lives...  
Empowering Communities...

## Differential Phase Shift Keying (DPSK):

- DPSK is a non coherent form of phase shift keying which avoids the need for a coherent reference signal at the receiver.

### Advantage:

- Non coherent receivers are easy and cheap to build, hence widely used in wireless communications.
- DPSK eliminates the need for a coherent reference signal at the receiver by combining two basic operations at the transmitter:



**Centurion**  
**UNIVERSITY**  
*Shaping Lives...*  
*Empowering Communities...*

# Pulse Carrier

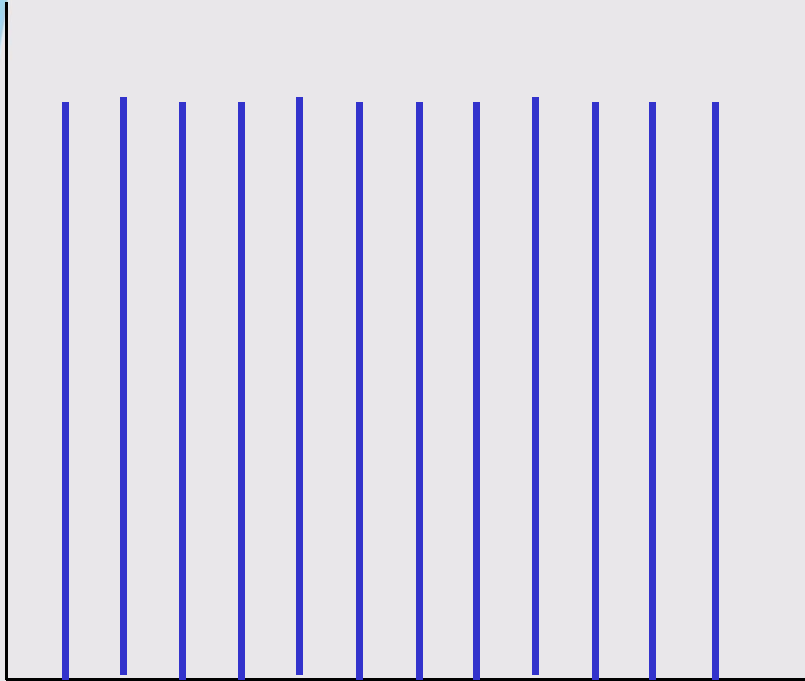

**Carrier:**  
A train of  
identical pulses  
regularly  
spaced in time



Centurion  
UNIVERSITY

Shaping Lives...  
Empowering Communities...

# Pulse-Amplitude Modulation (PAM)

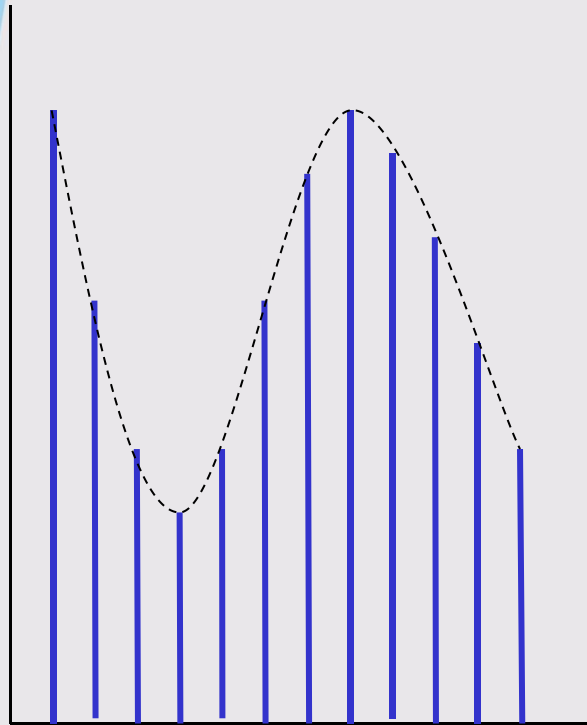

Modulation in which the amplitude of pulses is varied in accordance with the modulating signal.

Used e.g. in telephone switching equipment such as a private branch exchange (PBX)



Centurion  
UNIVERSITY

Shaping Lives...  
Empowering Communities...

# Pulse-Duration Modulation (PDM)

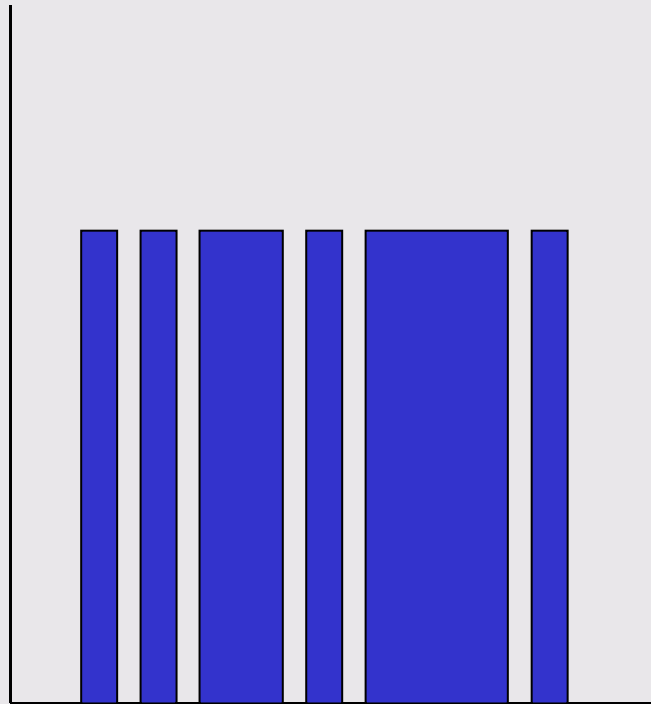

Used e.g. in telephone switching equipment such as a private branch exchange (PBX)

Modulation in which **the duration of pulses** is varied in accordance with the modulating signal.

*Deprecated synonyms:*  
pulse-length modulation,  
pulse-width modulation.



Centurion  
UNIVERSITY

Shaping Lives...  
Empowering Communities...

# Demodulation & Detection

## Demodulation

Is process of removing the carrier signal to obtain the original signal waveform

Detection – extracts the symbols from the waveform

Coherent detection

Non-coherent detection



Centurion  
UNIVERSITY

Shaping Lives...  
Empowering Communities...

# Coherent Detection

An estimate of the channel phase and attenuation is recovered. It is then possible to reproduce the transmitted signal and demodulate.

Requires a **replica carrier wave** of the same frequency and phase at the receiver.

Also known as synchronous detection (I.e. carrier recovery)



**Centurion**  
**UNIVERSITY**

*Shaping Lives...  
Empowering Communities...*

# Coherent Detection 2

Carrier recovery methods include

Pilot Tone (such as Transparent Tone in Band)

Less power in the information bearing signal, High peak-to-mean power ratio

Carrier recovery from the information signal

E.g. Costas loop

Applicable to

Phase Shift Keying (PSK)

Frequency Shift Keying (FSK)

Amplitude Shift Keying (ASK)



**Centurion**  
**UNIVERSITY**

*Shaping Lives...  
Empowering Communities...*

# Non-Coherent Detection

- Requires no reference wave; does not exploit phase reference information (envelope detection)
  - Differential Phase Shift Keying (DPSK)
  - Frequency Shift Keying (FSK)
  - Amplitude Shift Keying (ASK)
  - Non coherent detection is less complex than coherent detection (easier to implement), but has worse performance.



**Centurion**  
**UNIVERSITY**

*Shaping Lives...  
Empowering Communities...*

# QPSK

Quadrature Phase Shift Keying (QPSK) can be interpreted as two independent BPSK systems (one on the I-channel and one on Q-channel), and thus the same performance but twice the bandwidth (spectrum) efficiency.



Centurion  
UNIVERSITY

Shaping Lives...  
Empowering Communities...

# QPSK Constellation Diagram

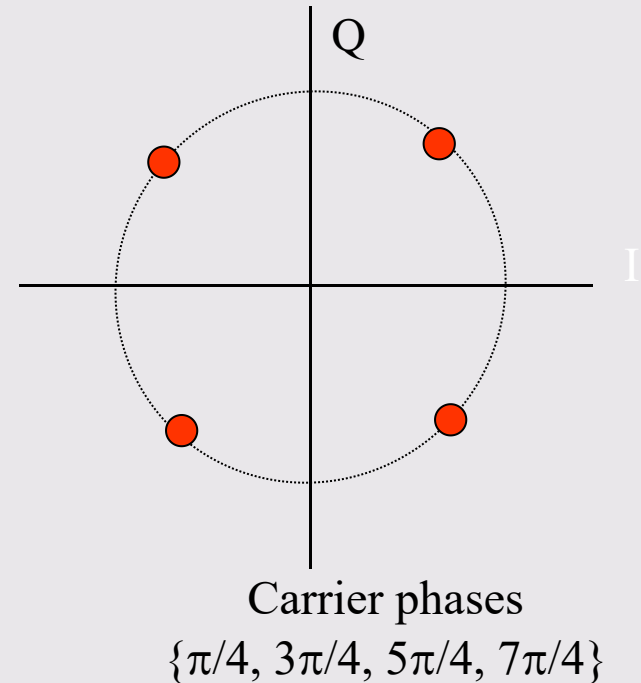
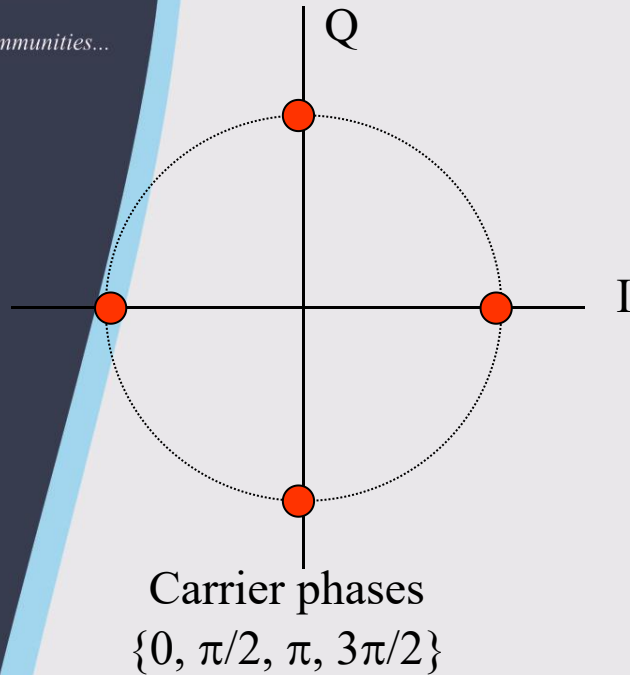

Quadrature Phase Shift Keying has **twice the bandwidth efficiency of BPSK** since 2 bits are transmitted in a single modulation symbol



Centurion  
UNIVERSITY

Shaping Lives...  
Empowering Communities...

# Types of QPSK

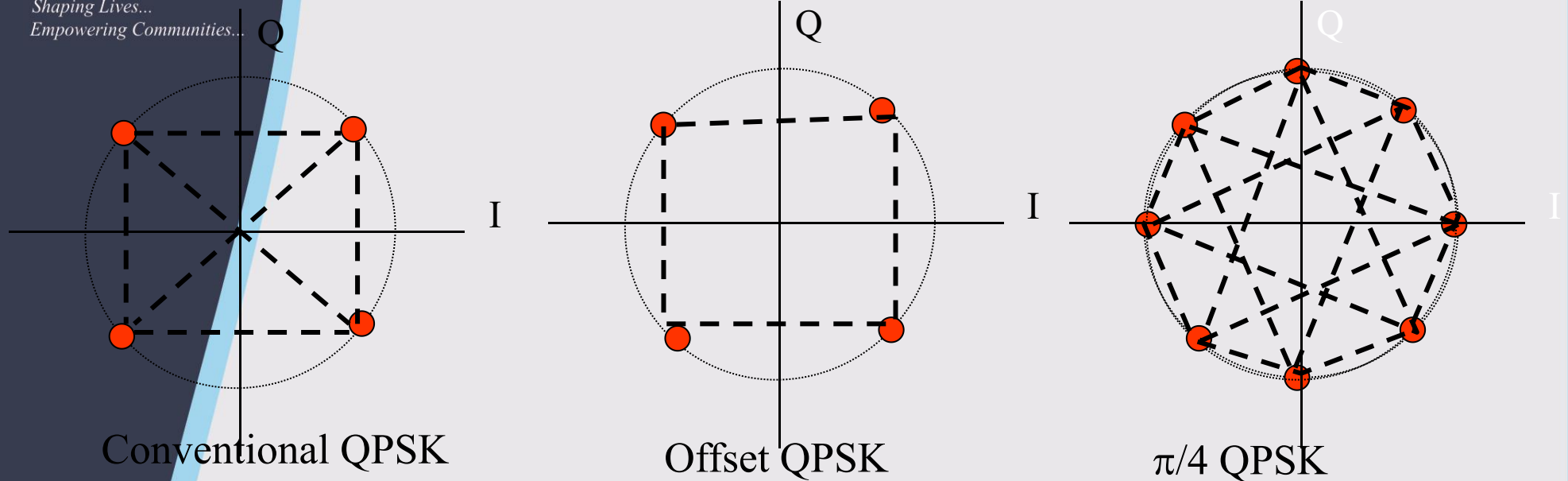

**Conventional QPSK** has transitions **through zero** (i.e.  $180^\circ$  phase transition). Highly linear amplifiers required.

In **Offset QPSK**, the phase transitions are limited to  $90^\circ$ , the transitions on the I and Q channels are staggered.

In  **$\pi/4$  QPSK** the set of constellation points are toggled each symbol, so transitions through zero cannot occur. This scheme produces **the lowest envelope variations**.

**All QPSK schemes require** linear power amplifiers



## Quadrature Phase Shift Keying (QPSK):

- Also a type of linear modulation scheme
- Quadrature Phase Shift Keying (QPSK) has twice the bandwidth efficiency of BPSK, since 2 bits are transmitted in a single modulation symbol.
- The phase of the carrier takes on 1 of 4 equally spaced values, such as  $0, \pi/2, \pi, \text{ and } 3\pi/2$  where each value of phase corresponds to a unique pair of message bits.
- The QPSK signal for this set of symbol states may be defined as:

$0, \pi/2, \pi, \text{ and } 3\pi/2,$

$$S_{\text{QPSK}}(t) = \sqrt{\frac{2E_s}{T_s}} \cos \left[ 2\pi f_c t + (i-1) \frac{\pi}{2} \right] \quad 0 \leq t \leq T_s \quad i = 1, 2, 3, 4.$$



Centurion  
UNIVERSITY

Shaping Lives...  
Empowering Communities...

# QPSK

$$S_{\text{QPSK}} = \left\{ \sqrt{E_s} \cos \left[ (i-1) \frac{\pi}{2} \right] \phi_1(t) - \sqrt{E_s} \sin \left[ (i-1) \frac{\pi}{2} \right] \phi_2(t) \right\} \quad i = 1, 2, 3, 4$$

- The striking result is that the bit error probability of QPSK is identical to BPSK, but twice as much data can be sent in the same bandwidth. Thus, when compared to BPSK, QPSK provides **twice the spectral efficiency** with exactly the same energy efficiency.
- Similar to BPSK, QPSK can also be differentially encoded to allow non-coherent detection.



**Centurion**  
**UNIVERSITY**

*Shaping Lives...  
Empowering Communities...*

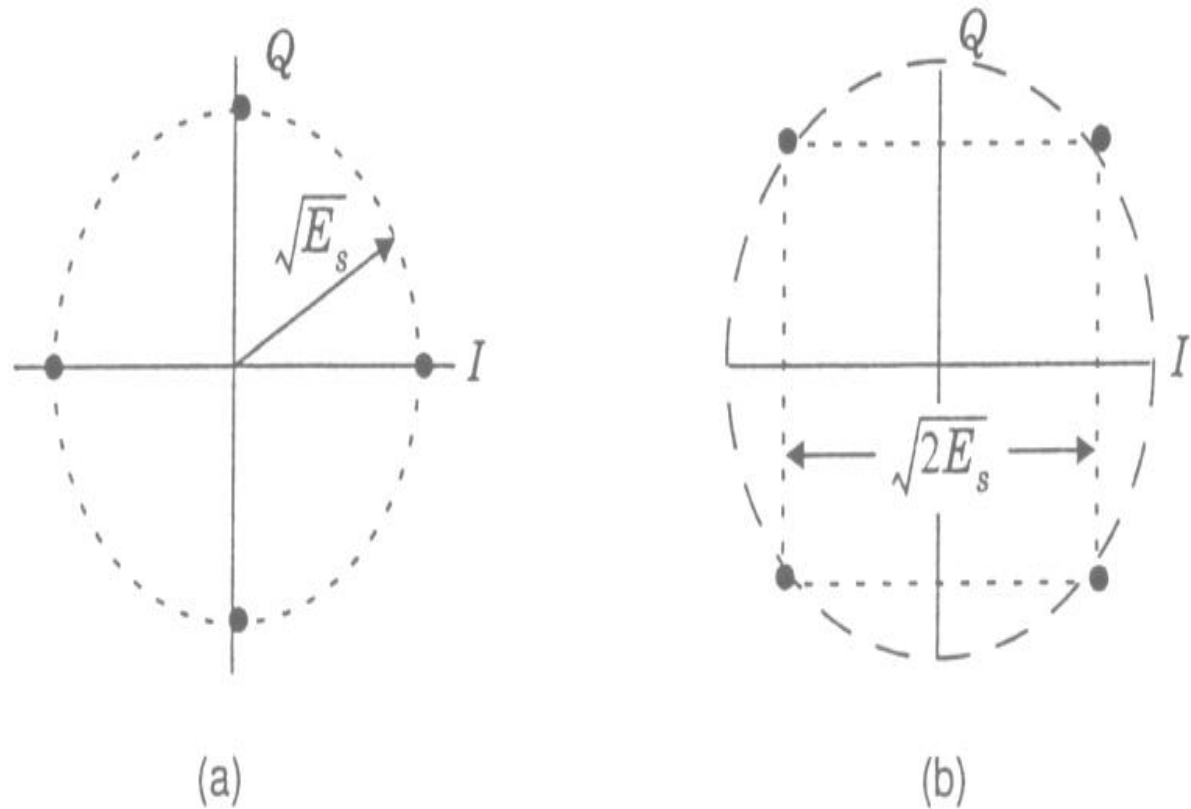

Figure 5.26

(a) QPSK constellation where the carrier phases are  $0, \pi/2, \pi, 3\pi/2$ .

(b) QPSK constellation where the carrier phases are  $\pi/4, 3\pi/4, 5\pi/4, 7\pi/4$ .



Centurion  
UNIVERSITY

Shaping Lives...  
Empowering Communities...

# Multi-level (M-ary) Phase and Amplitude Modulation

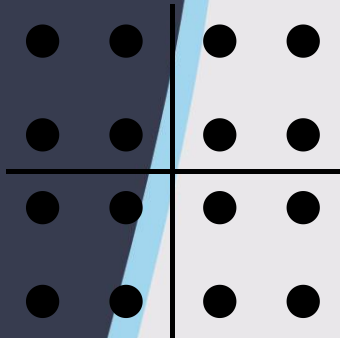

16 QAM

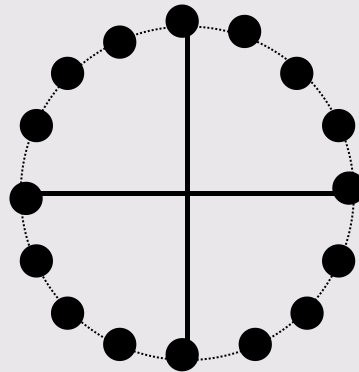

16 PSK

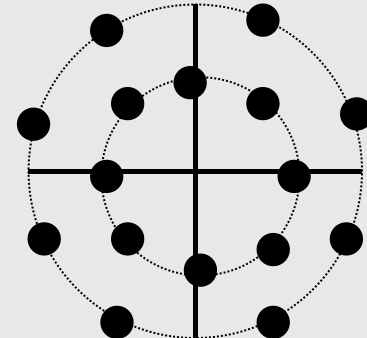

16 APSK

**Amplitude and phase shift keying** can be combined to transmit several bits per symbol.

Often referred to as *linear* as they require linear amplification.

More bandwidth-efficient, but more susceptible to noise.

For  $M=4$ , **16QAM has the largest distance between points**, but requires **very linear amplification**. **16PSK** has less stringent linearity requirements, but has **less spacing between constellation points**, and is therefore more affected by noise.



**Centurion**  
**UNIVERSITY**  
*Shaping Lives...  
Empowering Communities...*

# Distortions

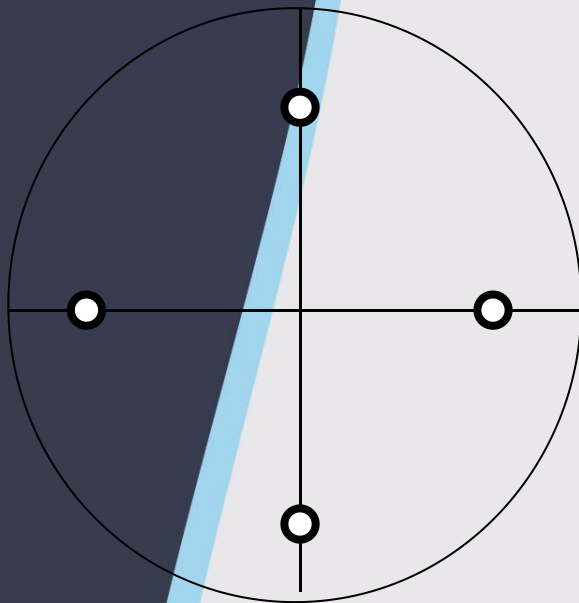

Perfect channel

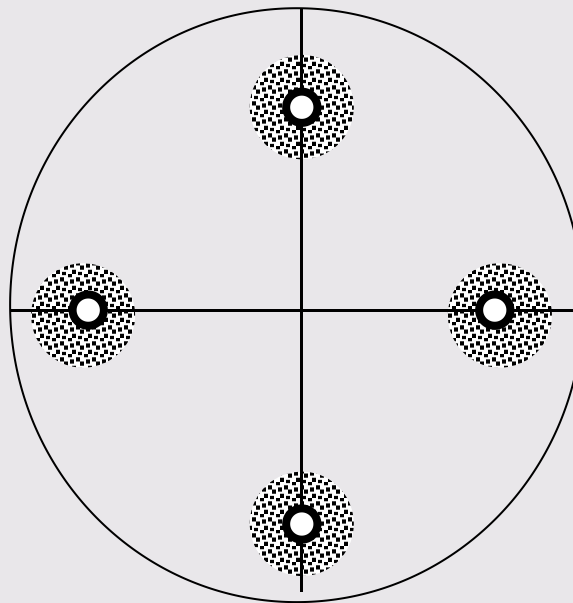

White noise

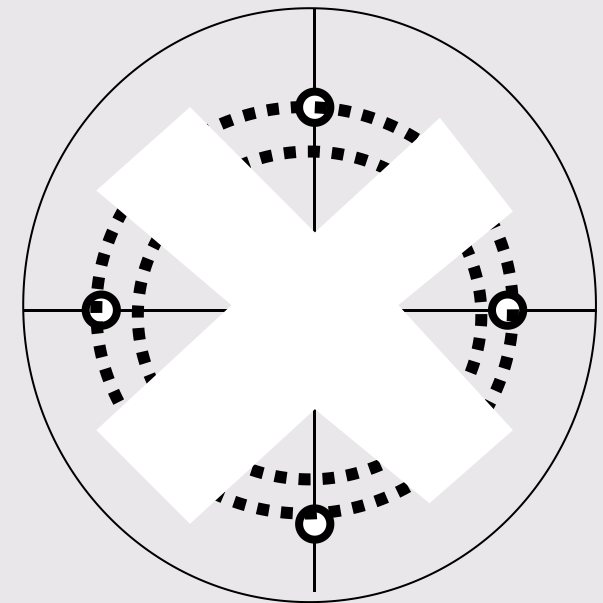

Phase jitter



# Bandwidth Efficiency

$$\frac{f_b}{W} = \log_2 \left( 1 + \frac{E_b f_b}{\eta W} \right)$$

$f_b$  = capacity (bits per second)

$W$  = bandwidth of the modulating baseband signal (Hz)

$E_b$  = energy per bit

$\eta$  = noise power density (watts/Hz)

Thus

$E_b f_b$  = total signal power

$\eta W$  = total noise power

$\frac{f_b}{W}$  = bandwidth use efficiency

= bits per second per Hz



**Centurion**  
**UNIVERSITY**

*Shaping Lives...  
Empowering Communities...*

# Comparison of Modulation Types

Modulation Format	Bandwidth efficiency C/B	Log <sub>2</sub> (C/B)	Error-free Eb/N <sub>0</sub>
16 PSK	4	2	18dB
16 QAM	4	2	15dB
8 PSK	3	1.6	14.5dB
4 PSK	2	1	10dB
4 QAM	2	1	10dB
BFSK	1	0	13dB
BPSK	1	0	10.5dB



Centurion  
UNIVERSITY

Shaping Lives...  
Empowering Communities...

# Spectral Efficiencies - Examples

## GSM Europe Digital Cellular

Data Rate = 270kb/s; Bandwidth = 200kHz

Bandwidth efficiency =  $270/200 =$   
 $1.35\text{bits/sec/Hz}$

## IS-95 North American Digital Cellular

Data Rate = 48kb/s; Bandwidth = 30kHz

Bandwidth efficiency =  $48/30 =$   
 $1.6\text{bits/sec/Hz}$



**Centurion**  
**UNIVERSITY**

Shaping Lives...  
Empowering Communities...

# BFSK Transmitter

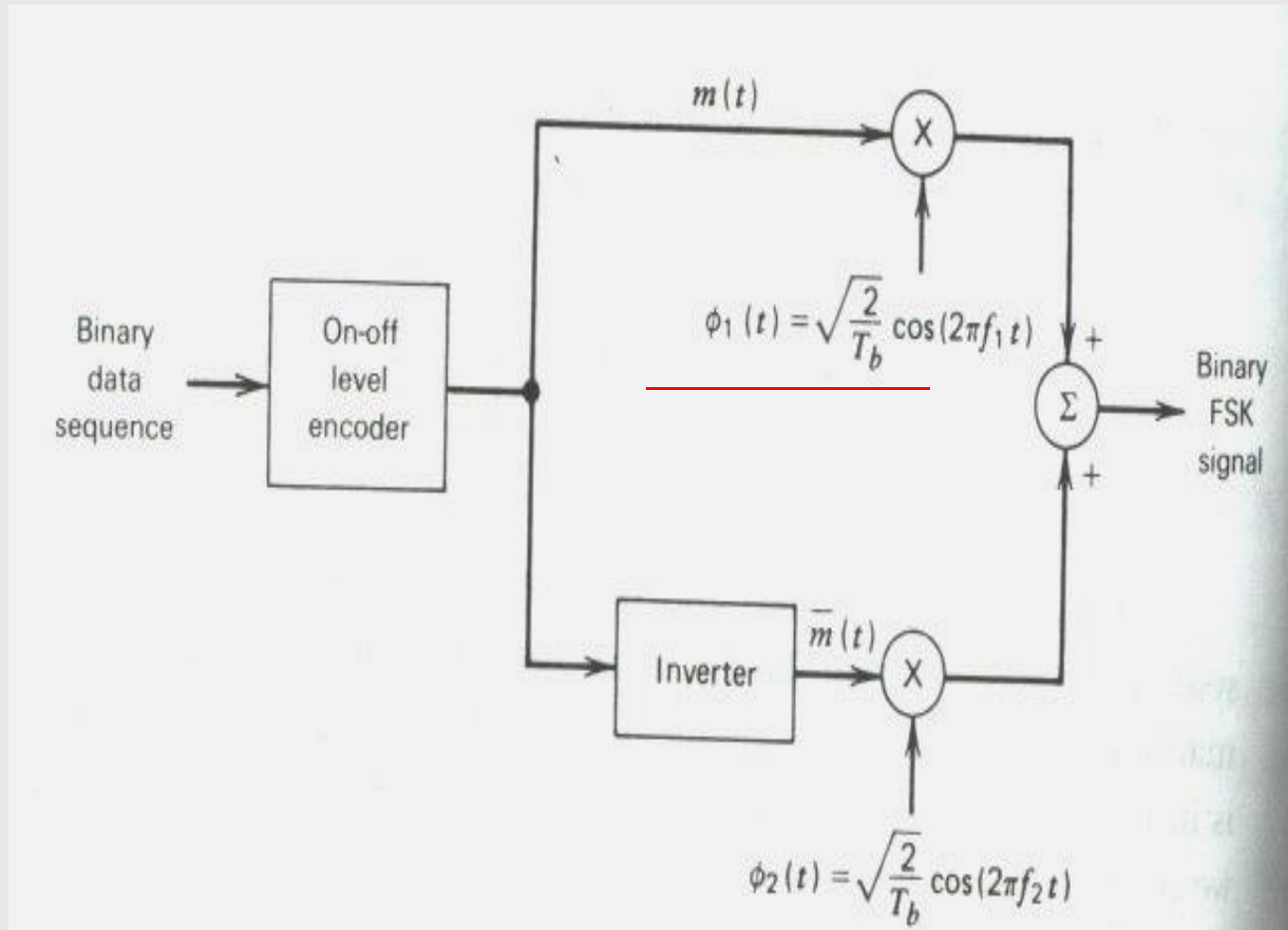



Centurion  
UNIVERSITY

Shaping Lives...  
Empowering Communities...

# Coherent Detection Of BFSK

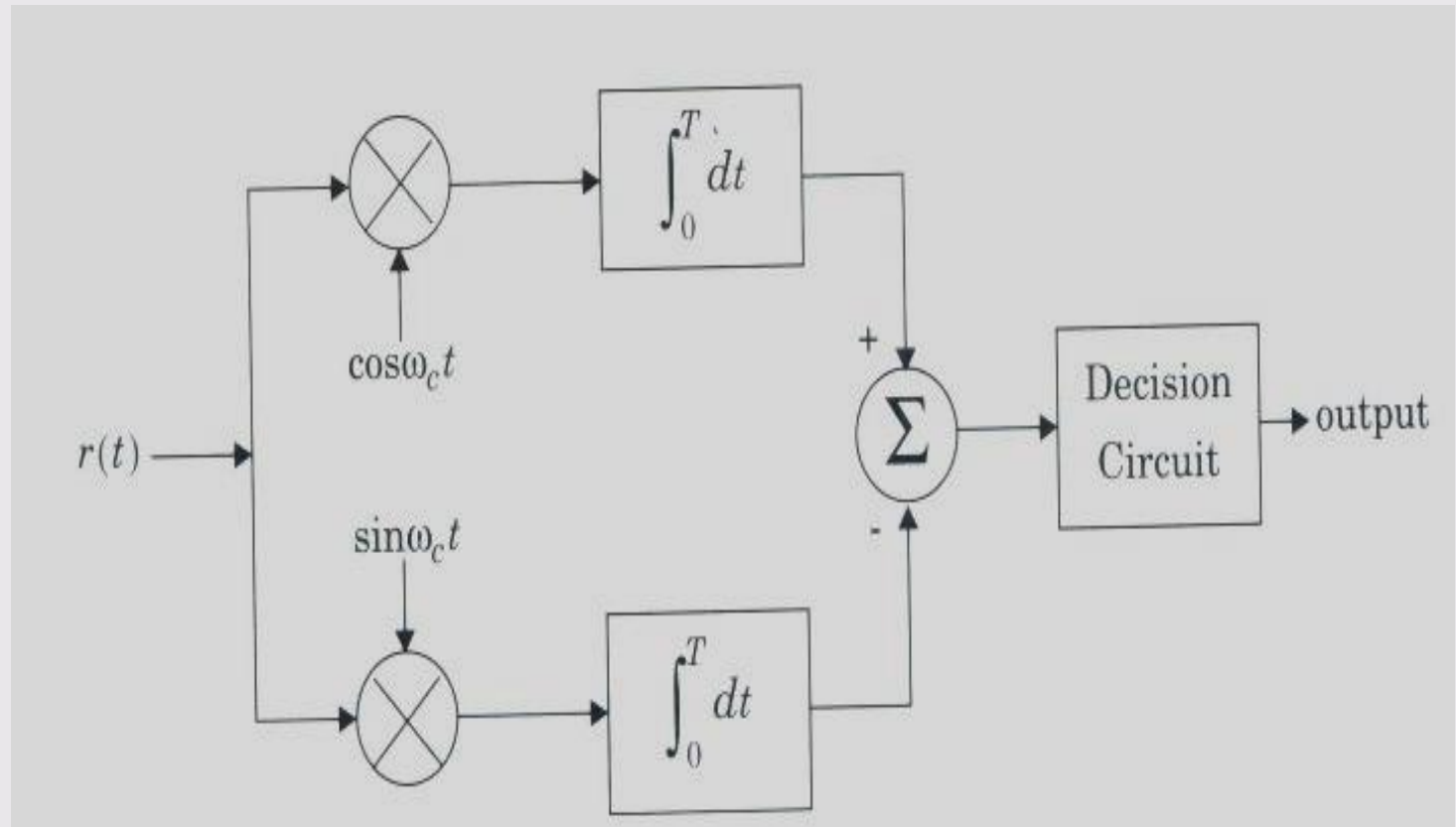



Centurion

# FSK Spectrum

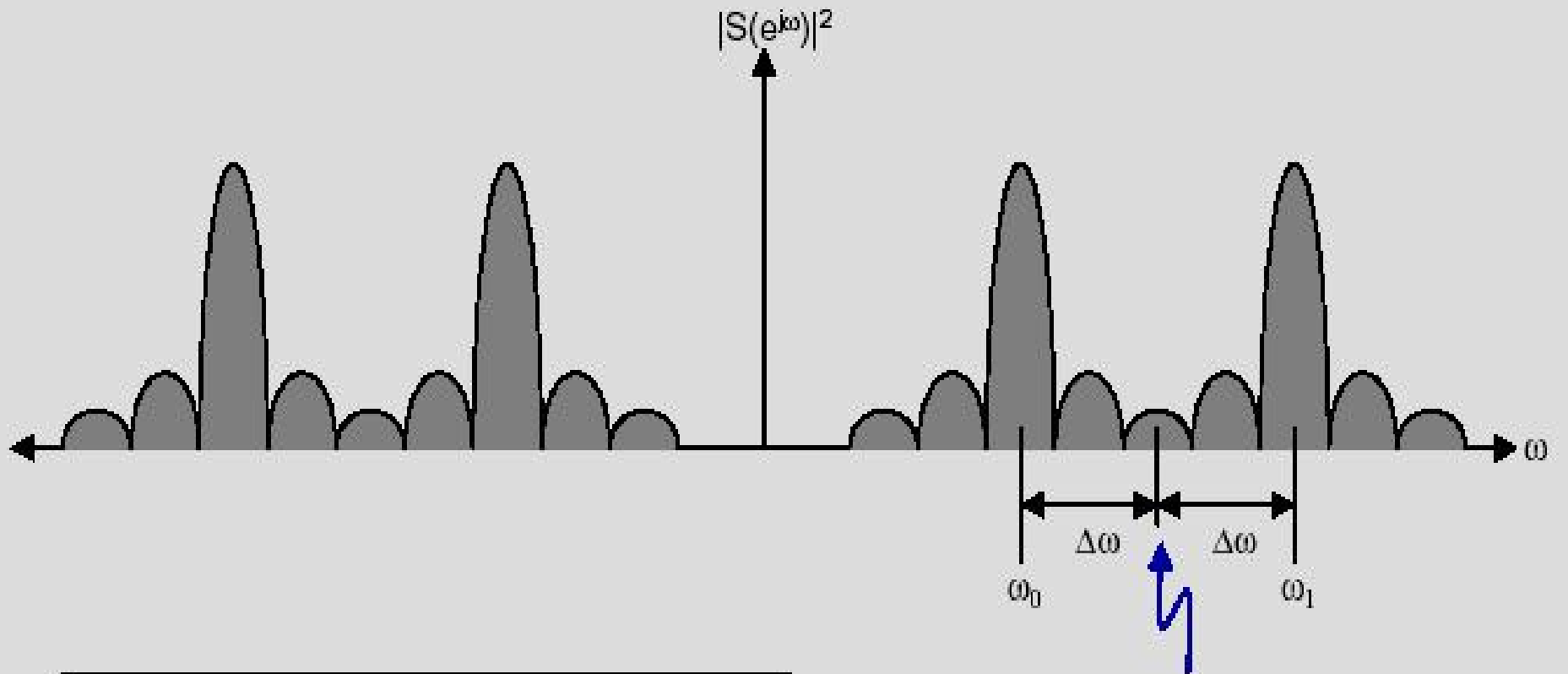

$$\omega_1 - \omega_0 = 2 \Delta\omega$$

where

$\Delta\omega$  = frequency shift from apparent carrier

apparent carrier frequency



**Centurion**  
**UNIVERSITY**

*Shaping Lives...  
Empowering Communities...*

# Minimum Shift Keying (MSK)

MSK is a continuous phase-frequency shift keying;

## Why MSK?

-- Exploitation of Phase Information besides frequency.



Centurion  
UNIVERSITY

Shaping Lives...  
Empowering Communities...

## Representation of a MSK signal

$$s(t) = s_1\phi_1(t) + s_2\phi_2(t) \quad 0 \leq t \leq T_b$$

the appropriate form for the orthonormal basis functions  $\phi_1(t)$  and  $\phi_2(t)$  is as follows:

$$\phi_1(t) = \sqrt{\frac{2}{T_b}} \cos\left(\frac{\pi}{2T_b} t\right) \cos(2\pi f_c t) \quad -T_b \leq t \leq T_b \quad (7.59)$$

and

$$\phi_2(t) = \sqrt{\frac{2}{T_b}} \sin\left(\frac{\pi}{2T_b} t\right) \sin(2\pi f_c t) \quad 0 \leq t \leq 2T_b \quad (7.60)$$

Input binary sequence

1 1 0 1 0 0 0

time scale



(a)

$\theta(kT_b)$   
Polarity of  $s_1$

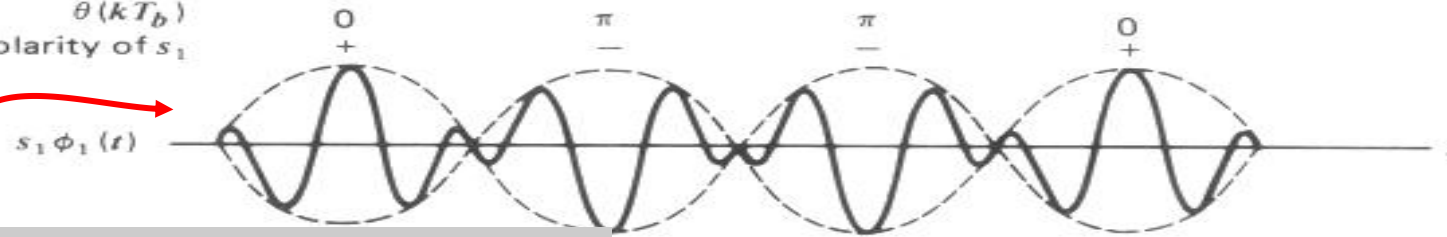

(b)

$$s(t) = s_1 \phi_1(t) + s_2 \phi_2(t) \quad 0 \leq t \leq T_b$$

$\theta(kT_b)$   
Polarity of  $s_2$

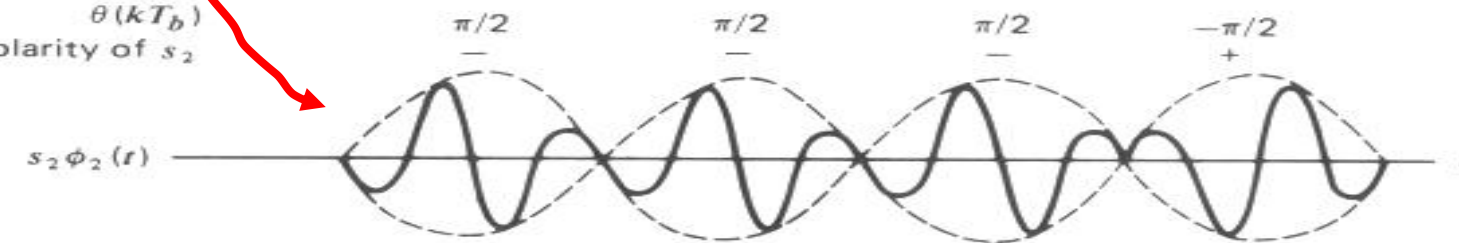

(c)

$s(t)$

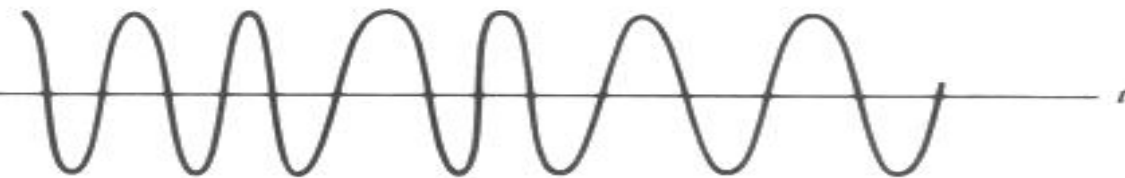

(d)

**Figure 7.13** Sequence and waveforms for MSK signal. (a) Input binary sequence. (b) Scaled time function  $s_1 \phi_1(t)$ . (c) Scaled time function  $s_2 \phi_2(t)$ . (d) MSK signal  $s(t)$  obtained by adding  $s_1 \phi_1(t)$  and  $s_2 \phi_2(t)$  on a bit-by-bit basis.



# MSK Transmitter

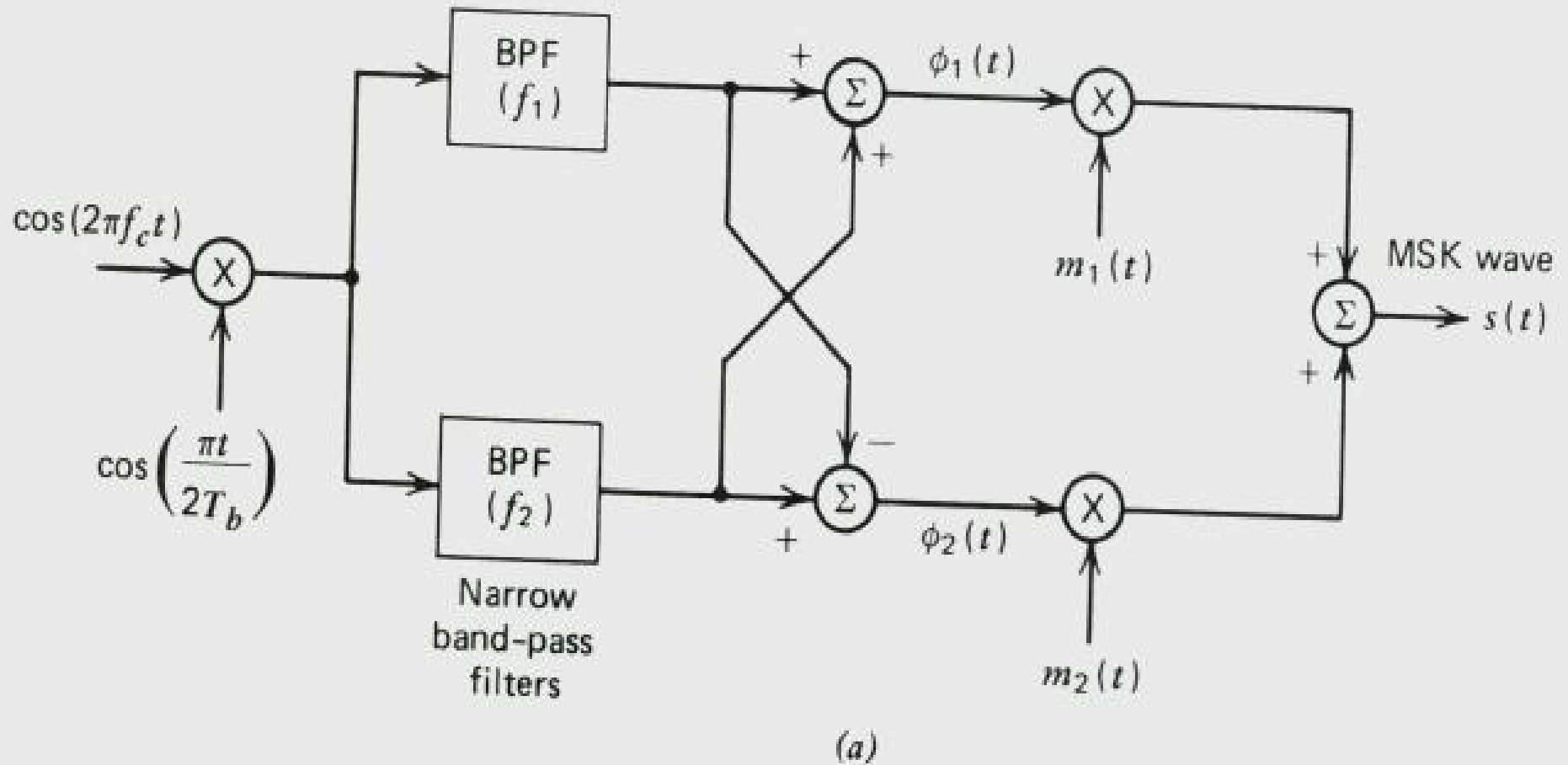



# MSK Receiver

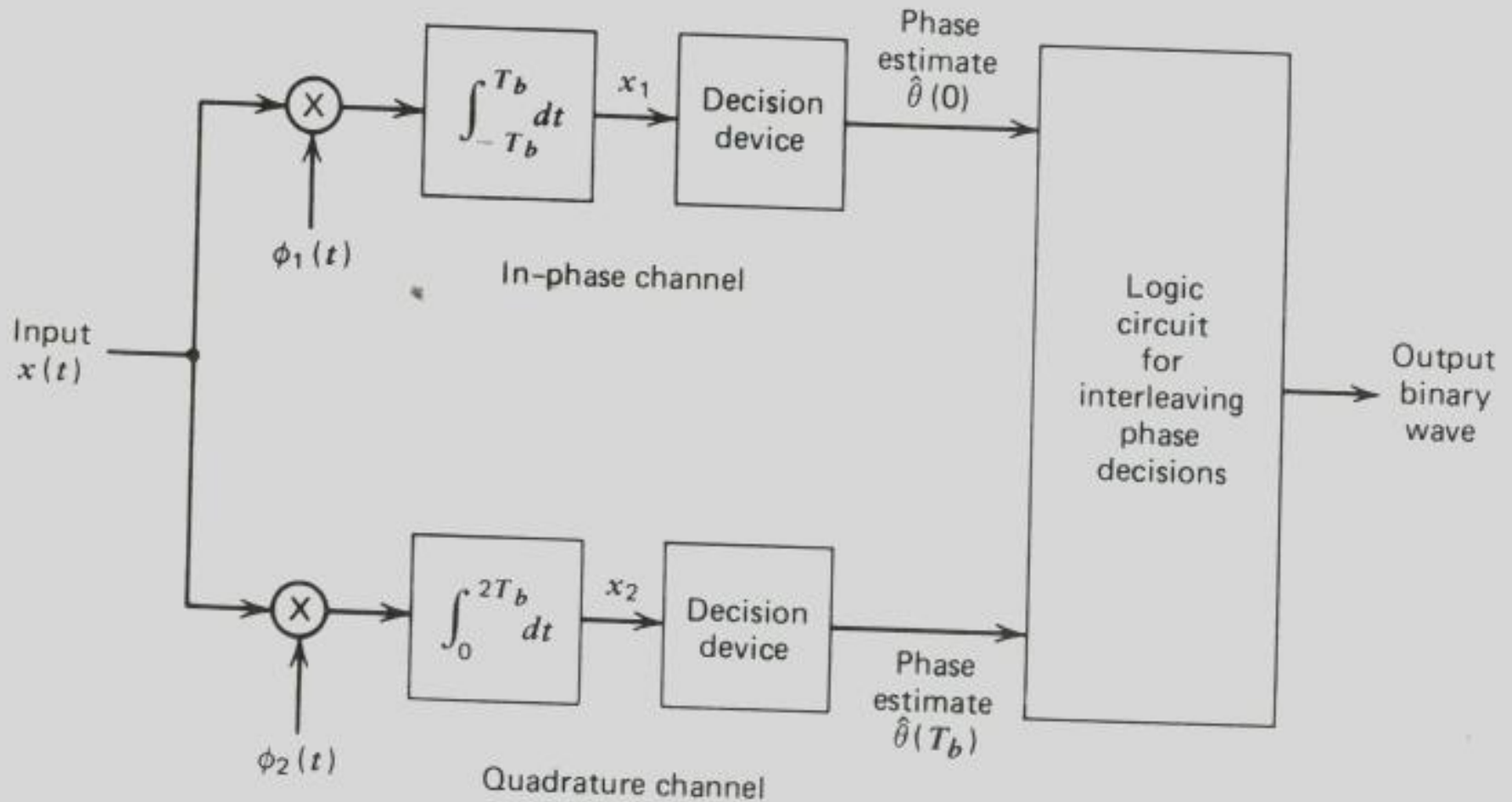



**Centurion**  
**UNIVERSITY**

*Shaping Lives...  
Empowering Communities...*

# M-ary

## Combined Linear and nonlinear (Constant Envelope)

## Modulation Techniques



Centurion  
UNIVERSITY

Shaping Lives...  
Empowering Communities...

## Topics :

What is M-ary modulation?

Various M-ary modulation Techniques:

M-ary Phase Shift Keying (MPSK)

M-ary Quadrature Amplitude  
Modulation

(QAM)

M-ary Frequency Shift Keying (MFSK)



**Centurion**  
**UNIVERSITY**

*Shaping Lives...  
Empowering Communities...*

## Definition:

In this modulation Technique the digital data is sent by varying both the **envelope and phase(or frequency) of an RF carrier**.

These modulation techniques map base band data into **four or more possible RF carrier signals**. Hence, these modulation techniques are called **M-ary modulation**.



**Centurion**  
**UNIVERSITY**

*Shaping Lives...  
Empowering Communities...*

### **M-ary signaling scheme:**

- In this signaling scheme 2 or more bits are grouped together to form a symbol.
- One of the M possible signals  $s_1(t), s_2(t), s_3(t), \dots, s_M(t)$  is transmitted during each symbol period of duration  $T_s$ .
- The number of possible signals =  $M = 2^n$ , where n is an integer.



Centurion  
UNIVERSITY

Shaping Lives...  
Empowering Communities...

The symbol values of M for a given value of n:

n	$M = 2^n$	Symbol
1	2	0, 1
2	4	00, 01, 10, 11
3	8	000, 001, 010, 011, ...
4	16	0000, 0001, 0010, 0011, ....
....	.....	.....



**Centurion**  
**UNIVERSITY**

Shaping Lives...  
Empowering Communities...

- Depending on the variation of amplitude, phase or frequency of the carrier, the modulation scheme is called as M-ary ASK, M-ary PSK and M-ary FSK.

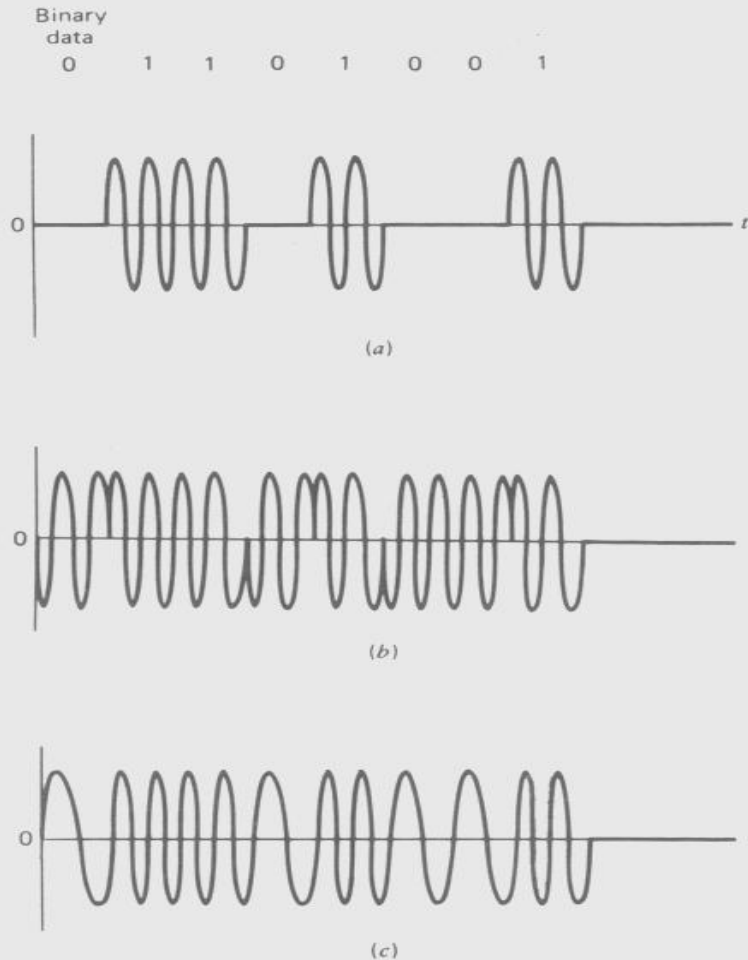

**Fig: waveforms of (a) ASK (b) PSK (c)FSK**



**Centurion**  
**UNIVERSITY**  
*Shaping Lives...  
Empowering Communities...*

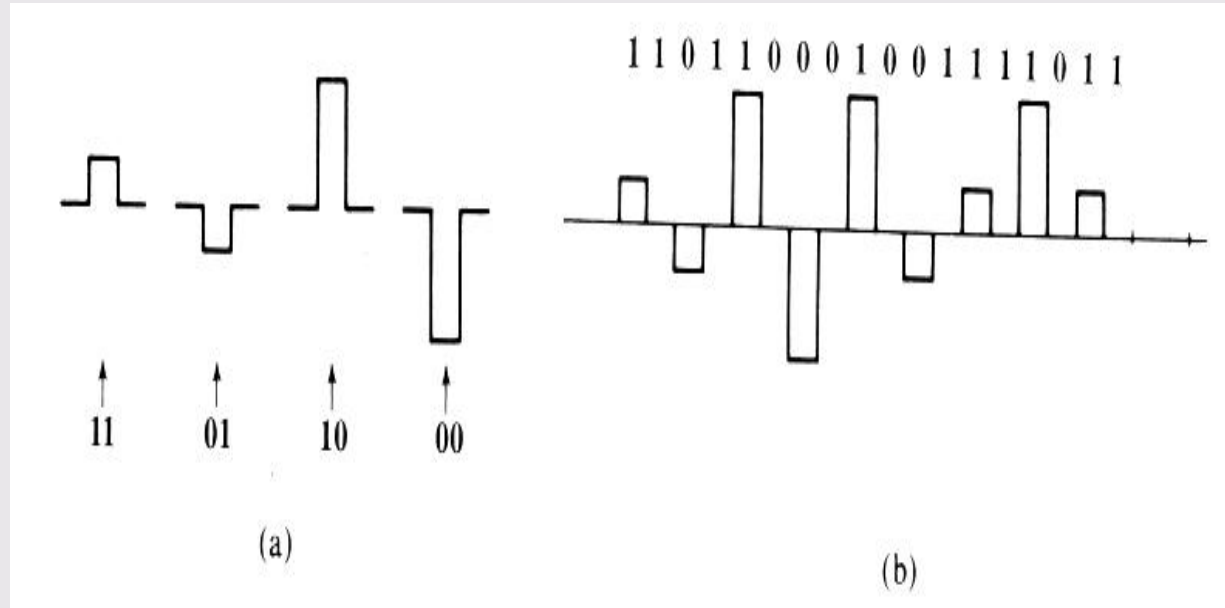

Fig: 4-ary Multi-amplitude signal



# M-ary Phase Shift Keying(MPSK)

In M-ary PSK, the carrier phase takes on one of the M possible values, namely  $\theta_i = 2 * (i - 1)\pi / M$  where  $i = 1, 2, 3, \dots, M$ .

The modulated waveform can be expressed as

$$S_i(t) = \sqrt{\frac{2E_s}{T_s}} \cos\left(2\pi f_c t + \frac{2\pi}{M}(i-1)\right), 0 \leq t \leq T_s \quad i = 1, 2, \dots, M$$

where  $E_s$  is energy per symbol =  $(\log_2 M) E_b$

$T_s$  is symbol period =  $(\log_2 M) T_b$ .



Centurion  
UNIVERSITY

Shaping Lives...  
Empowering Communities...

The above equation in the Quadrature form is

$$S_i(t) = \sqrt{\frac{2E_s}{T_s}} \cos \left[ (i-1) \frac{2\pi}{M} \right] \cos(2\pi f_c t) \quad i = 1, 2, \dots, M$$
$$- \sqrt{\frac{2E_s}{T_s}} \sin \left[ (i-1) \frac{2\pi}{M} \right] \sin(2\pi f_c t)$$

By choosing orthogonal basis signals

$$\phi_1(t) = \sqrt{\frac{2}{T_s}} \cos(2\pi f_c t),$$

$$\phi_2(t) = \sqrt{\frac{2}{T_s}} \sin(2\pi f_c t)$$

defined over the interval  $0 \leq t \leq T_s$



Centurion  
UNIVERSITY

Shaping Lives...  
Empowering Communities...

M-ary signal set can be expressed as

$$S_{M\text{-PSK}}(t) = \{ \sqrt{E_s} \cos \left[ (i-1) \frac{\pi}{2} \right] \phi_1(t) - \sqrt{E_s} \sin \left[ (i-1) \frac{\pi}{2} \right] \phi_2(t) \}$$
$$i = 1, 2, \dots, M$$

Since there are only two basis signals, the constellation of M-ary PSK is two dimensional.

The M-ary message points are equally spaced on a circle of radius  $\sqrt{E_s}$ , centered at the origin.

The constellation diagram of an 8-ary PSK signal set is shown in fig.



**Centurion**  
**UNIVERSITY**

*Shaping Lives...  
Empowering Communities...*

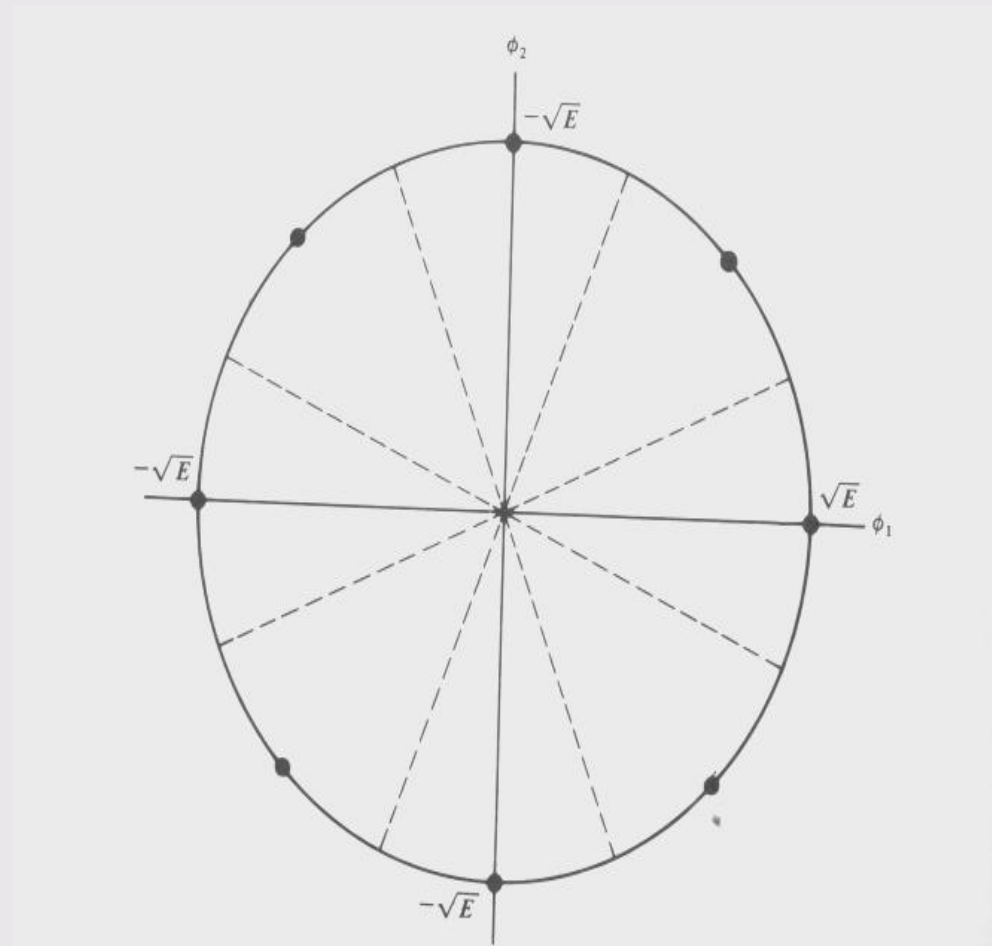

Fig: Constellation diagram of an M-ary PSK system( $m=8$ )



Centurion  
UNIVERSITY

Shaping Lives...  
Empowering Communities...

# Derivation of symbol error probability:

## Decision Rule:

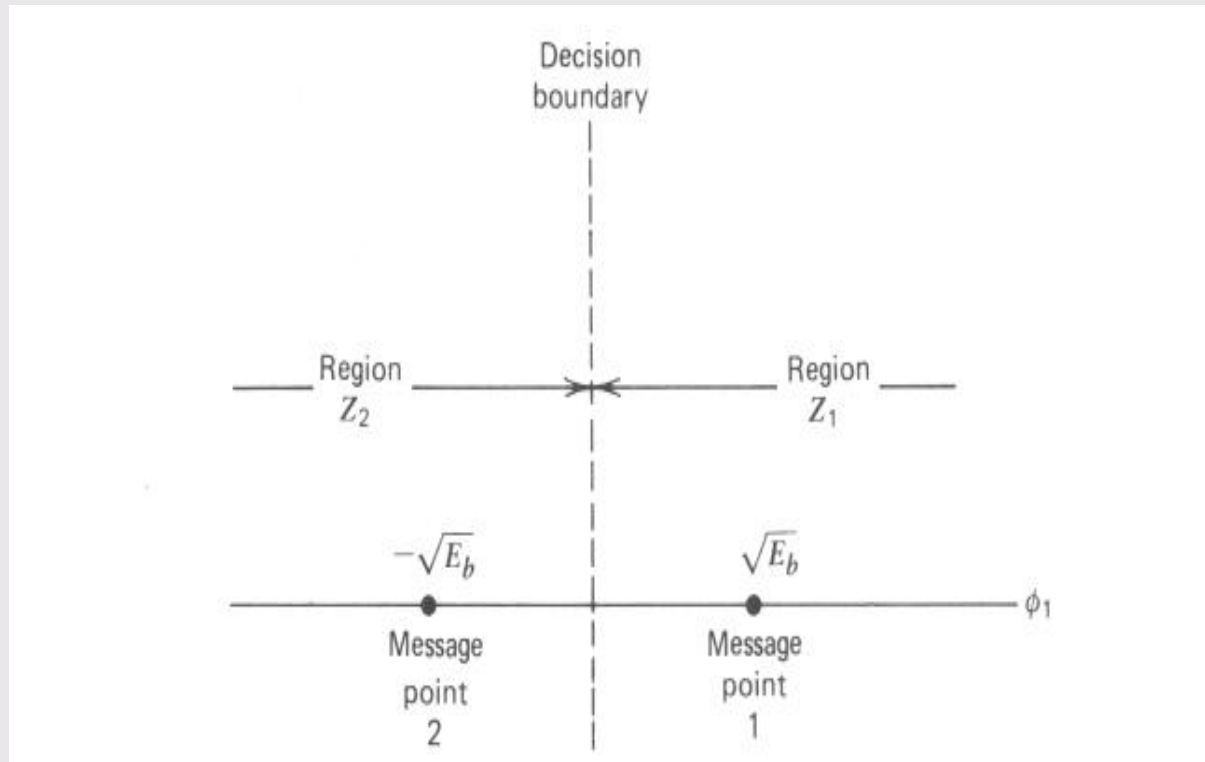

Fig: Constellation diagram for M=2 (Binary PSK)



Centurion  
UNIVERSITY

Shaping Lives...  
Empowering Communities...

If a symbol  $(0,0,0)$  is transmitted, it is clear that if an error occurs, the transmitted signal is most likely to be mistaken for  $(0,0,1)$  and  $(1,1,1)$  and the signal being mistaken for  $(1,1,0)$  is remote.

The decision pertaining to  $(0,0,0)$  is bounded by  $\theta = -$

$\pi/8$  (below  $\phi_1(t)$ - axis) to  $\theta = + \pi/8$  (above  $\phi_2(t)$ - axis)

The probability of correct reception is...



**Centurion**  
**UNIVERSITY**  
*Shaping Lives...  
Empowering Communities...*

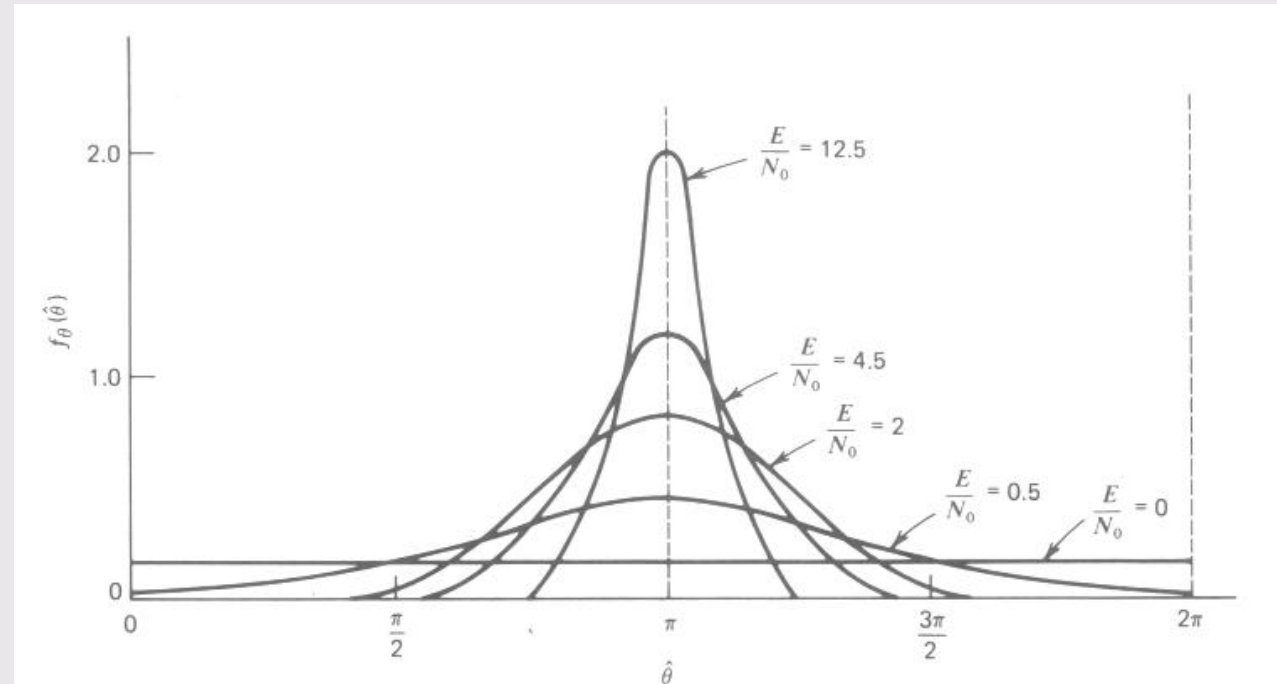

Fig: Probability density function of Phase  $\theta$ .



**Centurion**  
**UNIVERSITY**

*Shaping Lives...  
Empowering Communities...*

The average symbol error probability of an coherent M-ary PSK system in AWGN channel is given by

$$P_e \leq 2Q\left(\sqrt{\frac{2E_b \log_2 M}{N_0}} \sin\left(\frac{\pi}{M}\right)\right)$$

Similarly, The symbol error Probability of a differential M-ary PSK system in AWGN

$$P_e \approx 2Q\left(\sqrt{\frac{4E_s}{N_0}} \sin\left(\frac{\pi}{2M}\right)\right)$$



**Centurion**  
**UNIVERSITY**

*Shaping Lives...  
Empowering Communities...*

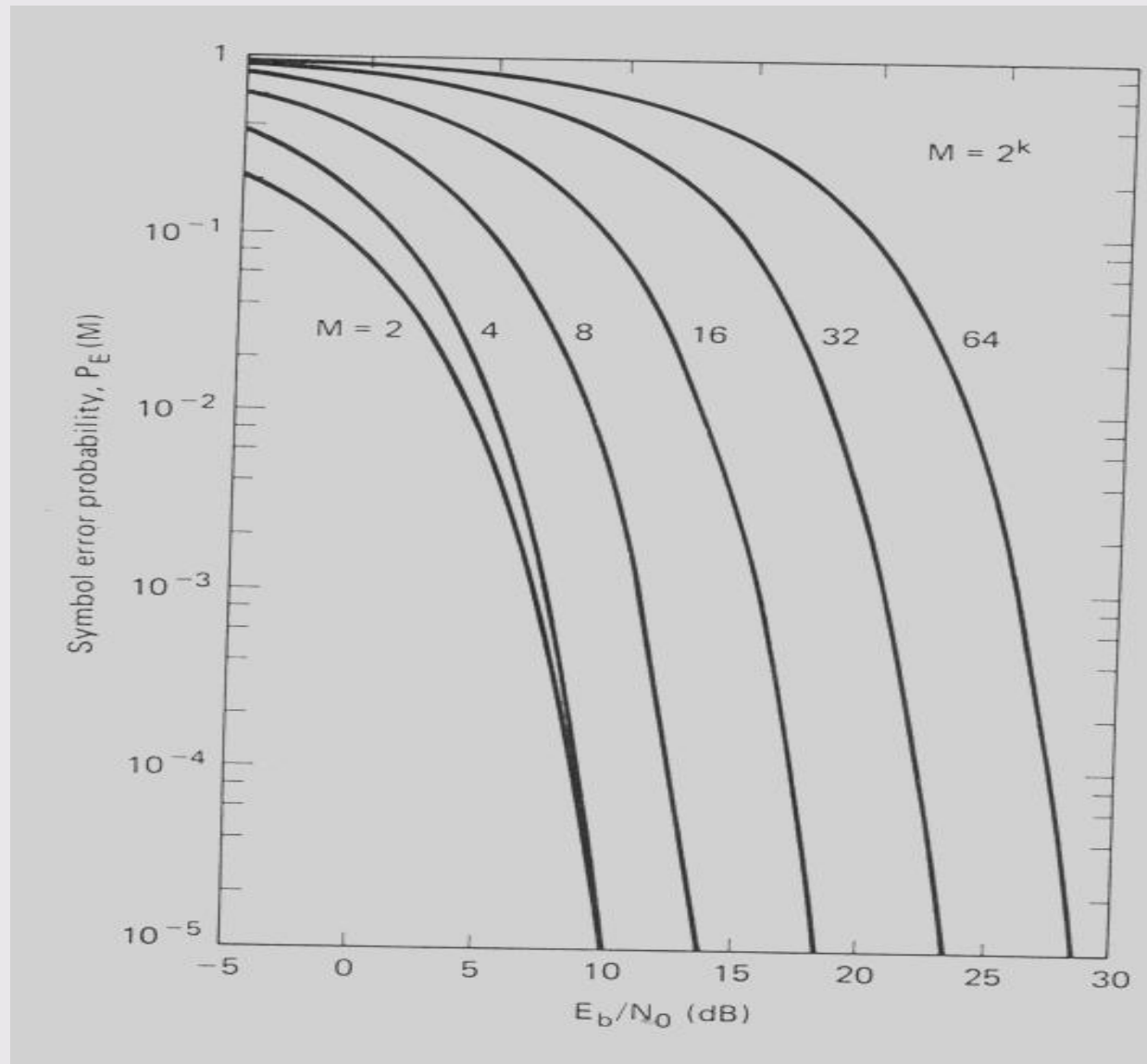

Fig: The performance of symbol error probability for  
-different values of M



**Centurion**  
**UNIVERSITY**

Shaping Lives...  
Empowering Communities...

## Power Efficiency and Bandwidth :

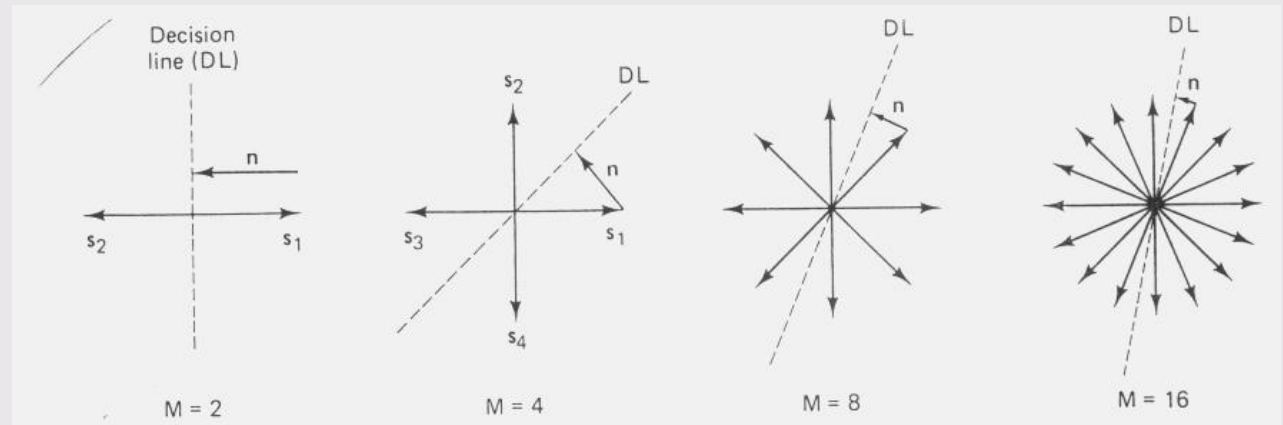

Fig: MPSK signal sets for M=2,4,8,16

Table 5.4 Bandwidth and Power Efficiency of M-ary PSK Signals

$M$	2	4	8	16	32	64
$\eta_B = R_b/B^*$	0.5	1	1.5	2	2.5	3
$E_b/N_o$ for BER= $10^{-6}$	10.5	10.5	14	18.5	23.4	28.5

\*  $B$ : First null bandwidth of M-ary PSK signals



Centurion  
UNIVERSITY

Shaping Lives...  
Empowering Communities...

Power efficiency:

Increasing  $M$  implies that the constellation is more densely packed, and hence the power efficiency (noise tolerance) is increased.

Bandwidth Efficiency:

The first null bandwidth of  $M$ -ary PSK signals decrease as  $M$  increases while  $R_b$  is held constant.

Therefore, as the value of  $M$  increases, the bandwidth efficiency also increases.



Centurion  
UNIVERSITY

Shaping Lives...  
Empowering Communities...

# M-ary Quadrature Amplitude Modulation (QAM)

It's a Hybrid modulation

- As we allow the amplitude to also vary with the phase, a new modulation scheme called quadrature amplitude modulation (QAM) is obtained.

The constellation diagram of 16-ary QAM consists of a square lattice of signal points.



**Centurion**  
**UNIVERSITY**  
*Shaping Lives...  
Empowering Communities...*

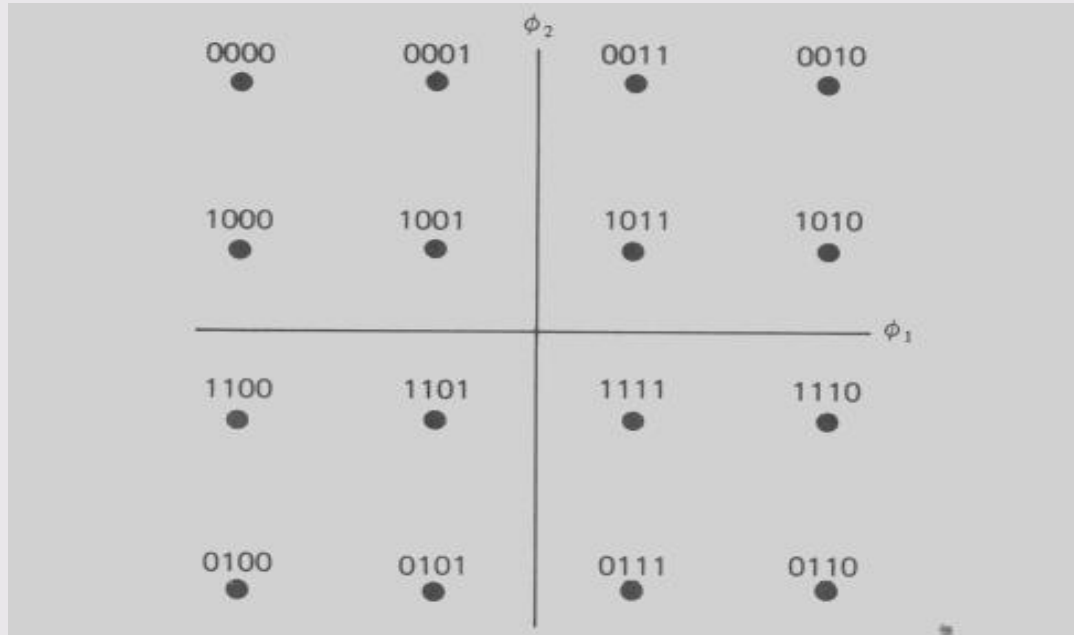

Fig: signal Constellation of M-ary QAM for M=16



**Centurion**  
**UNIVERSITY**

*Shaping Lives...  
Empowering Communities...*

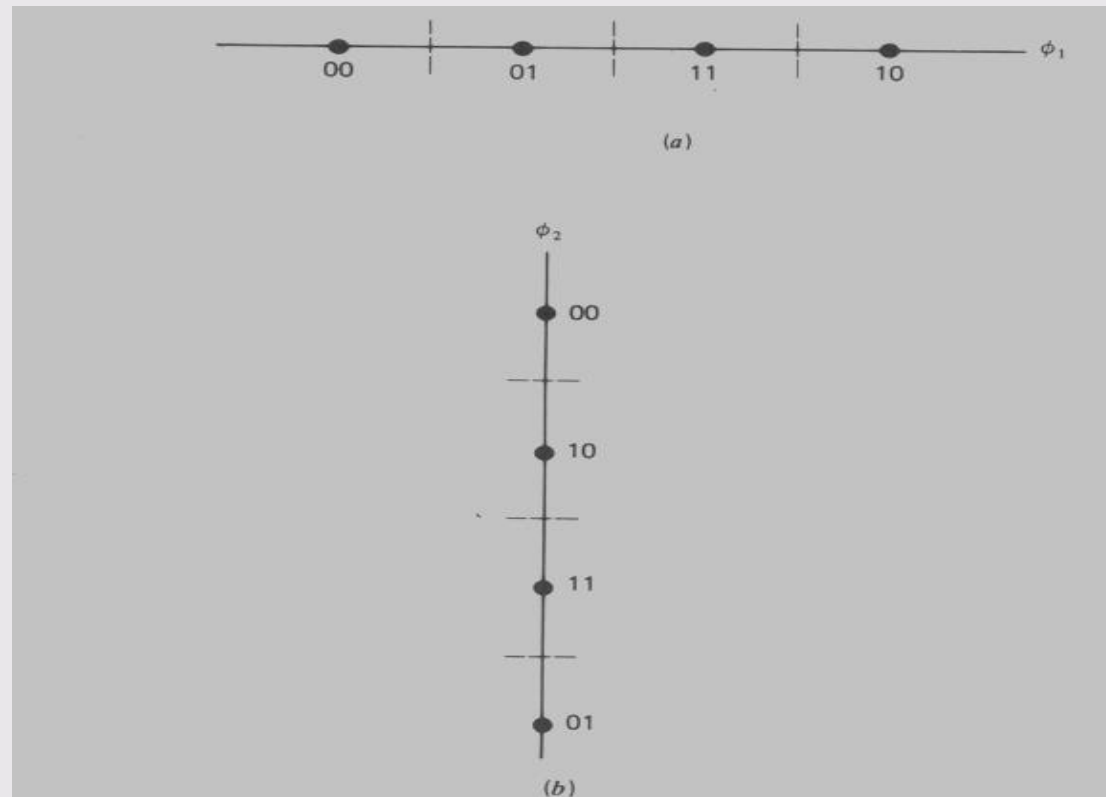

Fig: Decomposition of signal Constellation of M-ary QAM



Centurion  
UNIVERSITY

Shaping Lives...  
Empowering Communities...

The general form of an M-ary QAM signal can be defined as

$$S_i(t) = \sqrt{\frac{2E_{min}}{T_s}} a_i \cos(2\pi f_c t) + \sqrt{\frac{2E_{min}}{T_s}} b_i \sin(2\pi f_c t)$$
$$0 \leq t \leq T \quad i = 1, 2, \dots, M$$

where

$E_{min}$  is the energy of the signal with the lowest amplitude and

$a_i$  and  $b_i$  are a pair of independent integers chosen according to the location of the particular signal point.

In M-ary QAM energy per symbol and also distance between possible symbol states is not a constant.



**Centurion**  
**UNIVERSITY**

Shaping Lives...  
Empowering Communities...

It reasons that particular values of  $S_i(t)$  will be detected with higher probability than others.

The signal  $S_i(t)$  may be expanded in terms of a pair of basis functions defined as

$$\phi_1(t) = \sqrt{\frac{2}{T_s}} \cos(2\pi f_c t) \quad 0 \leq t \leq T_s$$

$$\phi_2(t) = \sqrt{\frac{2}{T_s}} \sin(2\pi f_c t) \quad 0 \leq t \leq T_s$$

The coordinates of the  $i$ th message point are  $a_i \sqrt{E_{\text{min}}}$  and  $b_i \sqrt{E_{\text{min}}}$  where  $(a_i, b_i)$  is an element of the  $L$  by  $L$  matrix given by

$$\{a_i, b_i\} = \begin{bmatrix} (-L+1, L-1) & (-L+3, L-1) & \dots & (L-1, L-1) \\ (-L+1, L-3) & (-L+3, L-3) & \dots & (L-1, L-3) \\ \vdots & \vdots & \ddots & \vdots \\ (-L+1, -L+1) & (-L+3, -L+1) & \dots & (L-1, -L+1) \end{bmatrix}$$

Where  $L = \sqrt{M}$ .



**Centurion**  
**UNIVERSITY**

Shaping Lives...  
Empowering Communities...

For the example M=16- QAM the L by L matrix is

$$\{a_i, b_i\} = \begin{bmatrix} (-3, 3) & (-1, 3) & (1, 3) & (3, 3) \\ (-3, 1) & (-1, 1) & (1, 1) & (3, 1) \\ (-3, -1) & (-1, -1) & (1, -1) & (3, -1) \\ (-3, -3) & (-1, -3) & (1, -3) & (3, -3) \end{bmatrix}$$

## Derivation of symbol error probability:

The average probability of error in an AWGN channel is given by

$$P_e \cong 4 \left( 1 - \frac{1}{\sqrt{M}} \right) Q \left( \sqrt{\frac{2E_{min}}{N_0}} \right)$$



Centurion  
UNIVERSITY

Shaping Lives...  
Empowering Communities...

In terms of average signal energy,  $E_{avg}$

$$P_e \approx 4 \left( 1 - \frac{1}{\sqrt{M}} \right) Q \left( \sqrt{\frac{3E_{av}}{(M-1)N_0}} \right)$$

## Power Efficiency and Bandwidth :

Power efficiency of **QAM** is superior to M-ary PSK.

Bandwidth efficiency of QAM is identical to M-ary PSK.



**Centurion**  
**UNIVERSITY**

Shaping Lives...  
Empowering Communities...

**Table 5.5 Bandwidth and Power Efficiency of QAM [Zie92]**

$M$	4	16	64	256	1024	4096
$\eta_B$	1	2	3	4	5	6
$E_b/N_0$ for BER= $10^{-6}$	10.5	15	18.5	24	28	33.5

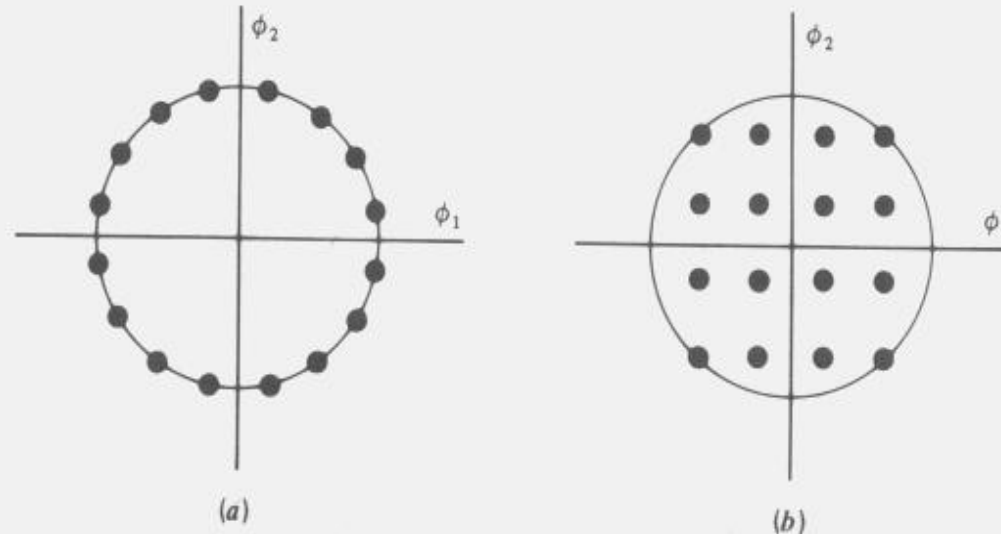

Fig: signal constellation of M-ary QPSK and M-ary QAM(M=16)



**Centurion  
UNIVERSITY**

*Shaping Lives...  
Empowering Communities...*

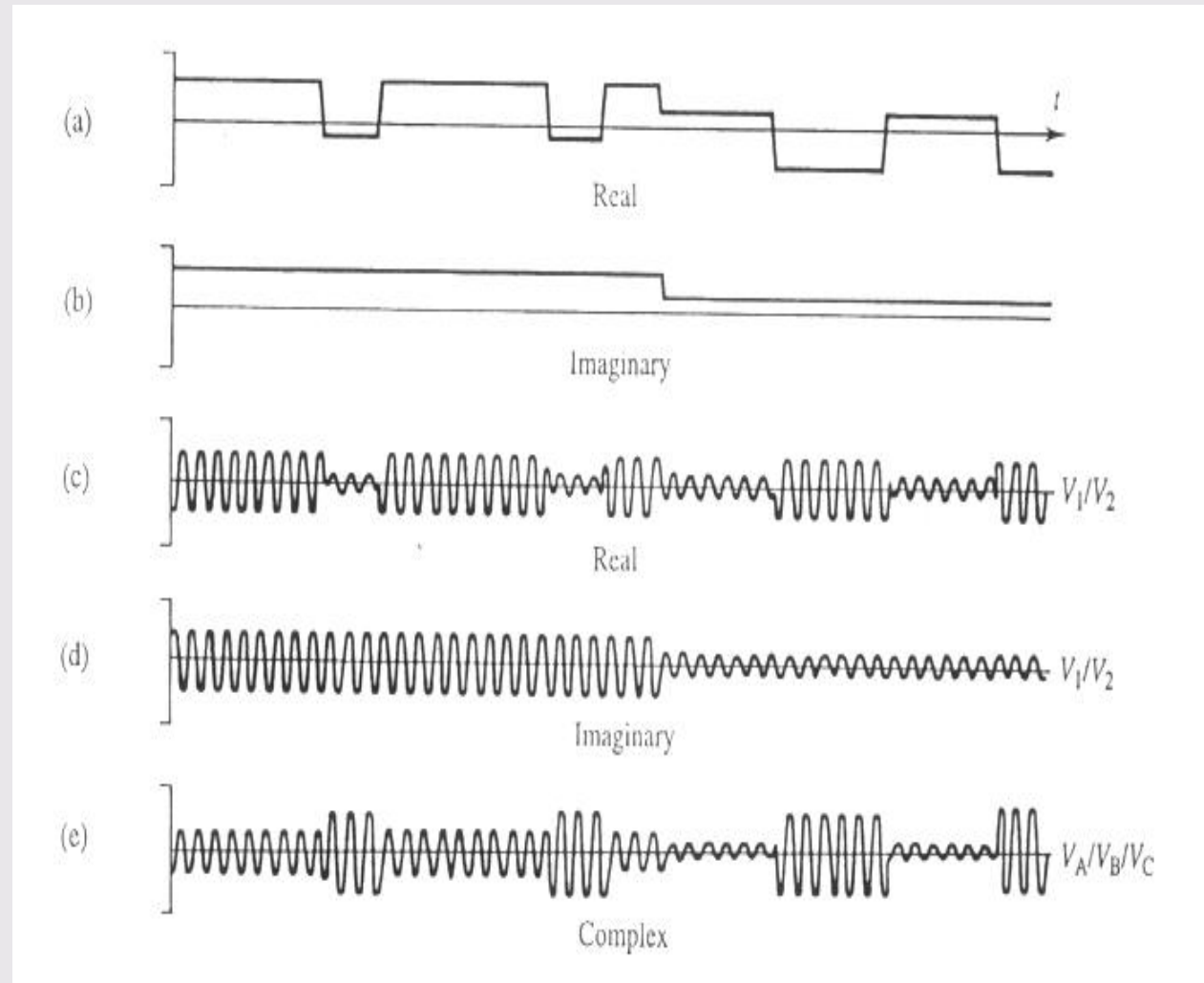

Fig: QAM for  $M = 16$



Centurion  
UNIVERSITY

Shaping Lives...  
Empowering Communities...

# M-ary Frequency Shift Keying(MFSK)

In M-ary FSK modulation the transmitted signals are defined by:

$$S_i(t) = \sqrt{\frac{2E_s}{T_s}} \cos \left[ \frac{\pi}{T_s} (n_c + i)t \right] \quad 0 \leq t \leq T_s \quad i = 1, 2, \dots, M$$

where  $f_c = n_c/2T_s$ , for some fixed integer n.

The M transmitted signals are of equal energy and equal duration, and the signal frequencies are separated by  $1/2T_s$  Hertz, making the signals orthogonal to one another.



**Centurion**  
**UNIVERSITY**

*Shaping Lives...  
Empowering Communities...*

The average probability of error based on the union bound is given by

$$P_e \leq (M-1) Q\left(\sqrt{\frac{E_b \log_2 M}{N_0}}\right)$$

Using only the leading terms of the binomial expansion:

$$P_e = \sum_{k=1}^{M-1} \left( \frac{(-1)^{k+1}}{k+1} \right) \binom{M-1}{k} \exp\left(\frac{-kE_s}{(k+1)N_0}\right)$$



Centurion  
UNIVERSITY

Shaping Lives...  
Empowering Communities...

# Power Efficiency and Bandwidth :

## Bandwidth:

Table 5.6 Bandwidth and Power Efficiency of Coherent M-ary FSK [Zie92]

$M$	2	4	8	16	32	64
$\eta_B$	0.4	0.57	0.55	0.42	0.29	0.18
$E_b/N_o$ for BER= $10^{-6}$	13.5	10.8	9.3	8.2	7.5	6.9

The channel bandwidth of a M-ary FSK signal is :

$$B = \frac{R_b (M + 3)}{2 \log_2 M}$$



Centurion  
UNIVERSITY

Shaping Lives...  
Empowering Communities...

- The channel bandwidth of a noncoherent MFSK is :

$$B = \frac{R_b M}{2 \log_2 M}$$

- This implies that the bandwidth efficiency of an M-ary FSK signal decreases with increasing M. Therefore, unlike M-PSK signals, M-FSK signals are bandwidth inefficient.



Centurion  
UNIVERSITY

Shaping Lives...  
Empowering Communities...

# Noise in DM

The error  $d(t)$  caused by Hunting Lies in the range of  $(-\sigma, +\sigma)$ .

where,

$\sigma$ =Step-Size.

So Finding the Granular Noise Power,

$$\overline{\varepsilon^2} = \frac{1}{2\sigma} \int_{-\sigma}^{+\sigma} \sigma^2 d\sigma$$

$$\overline{\varepsilon^2} = \frac{\sigma^2}{3}$$



**Centurion**  
**UNIVERSITY**  
*Shaping Lives...  
Empowering Communities...*

# Different Codes

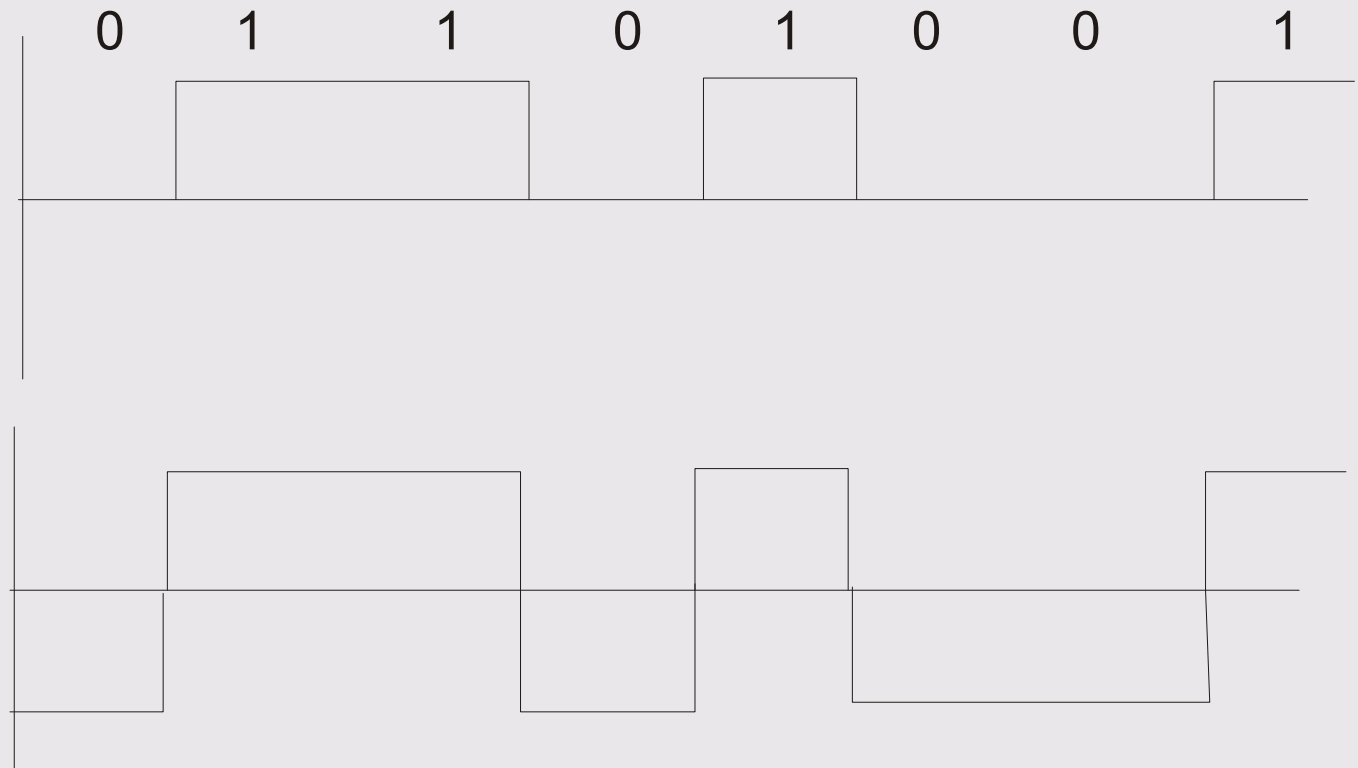



# Performance Metrics

In analog communications we want,

$$\hat{m}(t) \cong m(t)$$

Digital communication systems:

Data rate (R bps) (Limited) Channel Capacity

Probability of error  $P_e$

Without noise, we don't make bit errors

Bit Error Rate (BER): Number of bit errors that occur for a given number of bits transmitted.

What's BER if  $P_e = 10^{-6}$  and  $10^7$  bits are transmitted?



Centurion  
UNIVERSITY

Shaping Lives...  
Empowering Communities...

# Baseband Data Transmission

**Figure 7-2**  
System model and waveforms for synchronous baseband digital data transmission.  
(a) Baseband digital data communication system.  
(b) Typical transmitted sequence.  
(c) Received sequence plus noise.

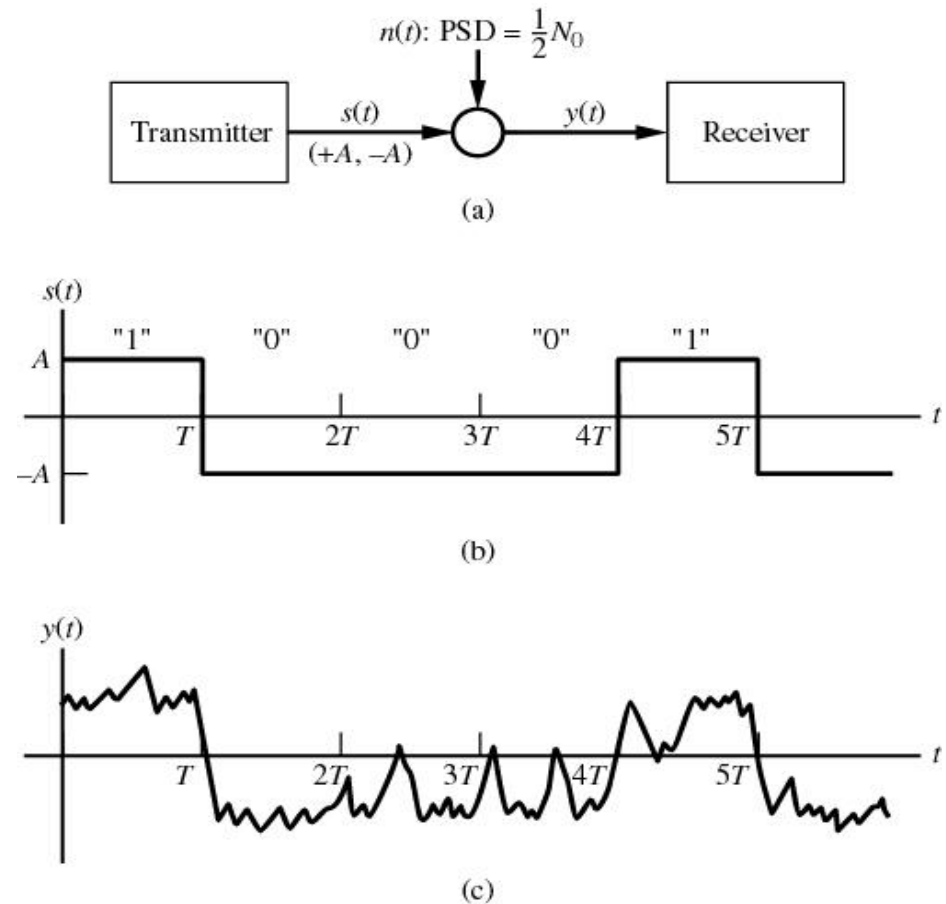



**Centurion**  
**UNIVERSITY**

*Shaping Lives...  
Empowering Communities...*

Each T-second pulse is a bit.

Receiver has to decide whether it's a 1 or  
0

(  $A$  or  $-A$  )

Integrate-and-dump detector

Possible different signaling schemes?



**Centurion**  
**UNIVERSITY**

*Shaping Lives...  
Empowering Communities...*

# DIGITAL-TO-DIGITAL CONVERSION

**In this section, we see how we can represent digital data by using digital signals. The conversion involves three techniques: line coding, block coding, and scrambling. Line coding is always needed; block coding and scrambling may or may not be needed.**

## **Topics discussed in this section:**

- **Line Coding**
- **Line Coding Schemes**
- **Block Coding**
- **Scrambling**



Centurion  
UNIVERSITY

Shaping Lives...  
Empowering Communities...

# Line Coding

Converting a string of 1's and 0's (digital data) into a sequence of signals that denote the 1's and 0's.

For example a high voltage level (+V) could represent a "1" and a low voltage level (0 or -V) could represent a "0".



Centurion  
UNIVERSITY

Shaping Lives...  
Empowering Communities...

# Line coding and decoding

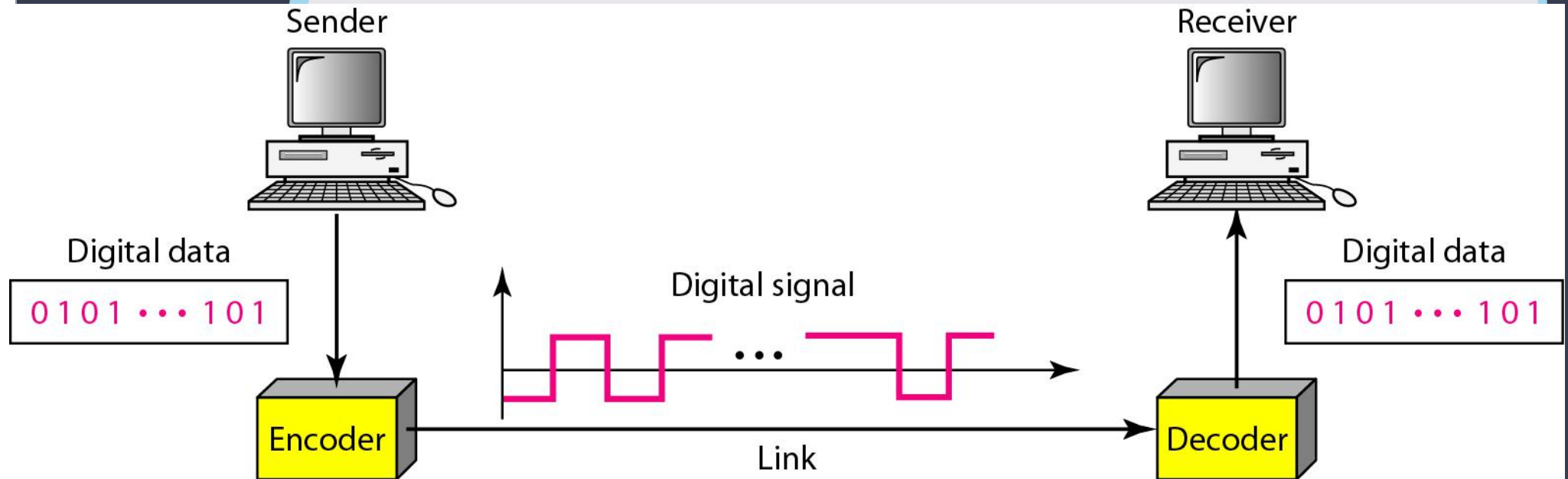



Centurion  
UNIVERSITY

Shaping Lives...  
Empowering Communities...

# Mapping Data symbols onto Signal levels

A data symbol (or element) can consist of a number of data bits:

1 , 0 or

11, 10, 01, .....

A data symbol can be coded into a single signal element or multiple signal elements

1  $\rightarrow$  +V, 0  $\rightarrow$  -V

1  $\rightarrow$  +V and -V, 0  $\rightarrow$  -V and +V

The ratio 'r' is the number of data elements carried by a signal element.



Centurion  
UNIVERSITY

Shaping Lives...  
Empowering Communities...

# Relationship between data rate and signal rate

The data rate defines the number of bits sent per sec - bps. It is often referred to the bit rate.

The signal rate is the number of signal elements sent in a second and is measured in bauds. It is also referred to as the modulation rate.

Goal is to increase the data rate whilst reducing the baud rate.



**Centurion**  
**UNIVERSITY**

*Shaping Lives...  
Empowering Communities...*

# Signal element versus data element

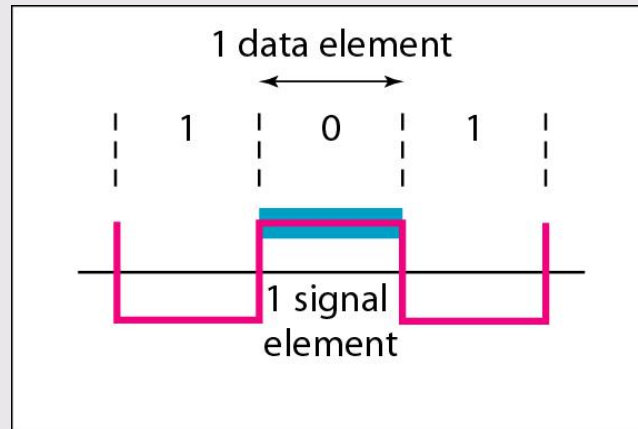

a. One data element per one signal element ( $r = 1$ )

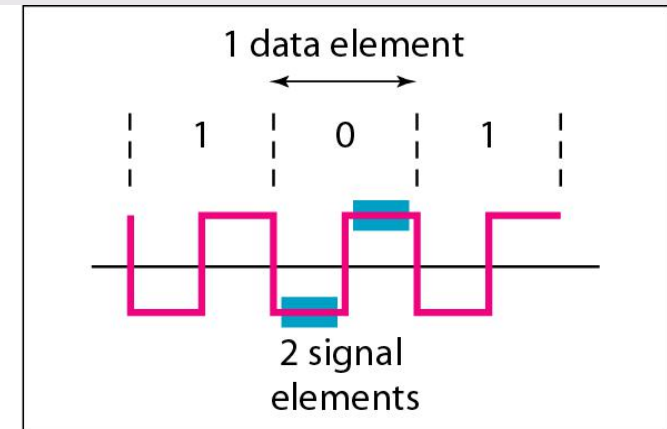

b. One data element per two signal elements ( $r = \frac{1}{2}$ )

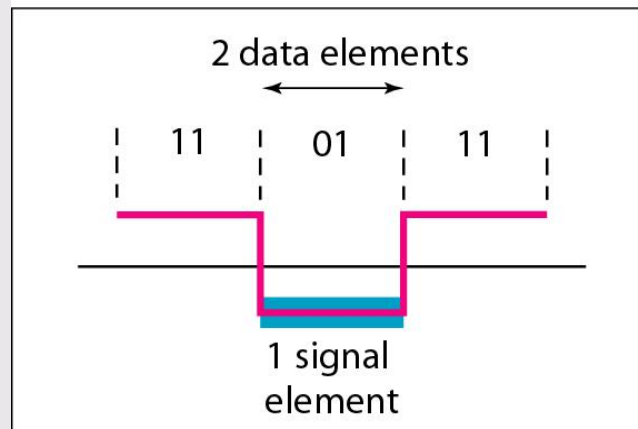

c. Two data elements per one signal element ( $r = 2$ )

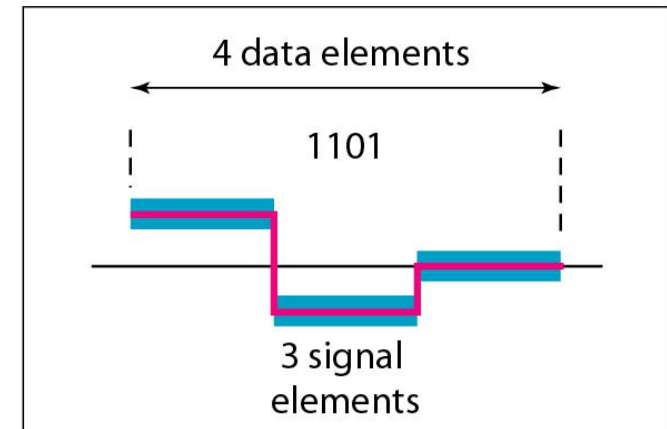

d. Four data elements per three signal elements ( $r = \frac{4}{3}$ )



**Centurion**  
**UNIVERSITY**

*Shaping Lives...  
Empowering Communities...*

# Data rate and Baud rate

The baud or signal rate can be expressed as:

$$S = c \times N \times 1/r \text{ bauds}$$

where N is data rate

c is the case factor (worst, best & avg.)

r is the ratio between data element & signal element

# Example

*A signal is carrying data in which one data element is encoded as one signal element ( $r = 1$ ). If the bit rate is 100 kbps, what is the average value of the baud rate if  $c$  is between 0 and 1?*

## **Solution**

*We assume that the average value of  $c$  is  $1/2$ . The baud rate is then*

$$S = c \times N \times \frac{1}{r} = \frac{1}{2} \times 100,000 \times \frac{1}{1} = 50,000 = 50 \text{ kbaud}$$



**Centurion**  
**UNIVERSITY**

*Shaping Lives...  
Empowering Communities...*

**Note**

**Although the actual bandwidth of a digital signal is infinite, the effective bandwidth is finite.**



# Example

*The maximum data rate of a channel (see Chapter 3) is  $N_{\max} = 2 \times B \times \log_2 L$  (defined by the Nyquist formula). Does this agree with the previous formula for  $N_{\max}$ ?*

## Solution

*A signal with  $L$  levels actually can carry  $\log_2 L$  bits per level. If each level corresponds to one signal element and we assume the average case ( $c = 1/2$ ), then we have*

$$N_{\max} = \frac{1}{c} \times B \times r = 2 \times B \times \log_2 L$$



**Centurion**  
**UNIVERSITY**

*Shaping Lives...  
Empowering Communities...*

# Considerations for choosing a good signal element referred to as line encoding

Baseline wandering - a receiver will evaluate the average power of the received signal (called the baseline) and use that to determine the value of the incoming data elements. If the incoming signal does not vary over a long period of time, the baseline will drift and thus cause errors in detection of incoming data elements.

A good line encoding scheme will prevent long runs of fixed amplitude.



Centurion  
UNIVERSITY

Shaping Lives...  
Empowering Communities...

# Line encoding C/Cs

DC components - when the voltage level remains constant for long periods of time, there is an increase in the low frequencies of the signal. Most channels are bandpass and may not support the low frequencies.

This will require the removal of the dc component of a transmitted signal.



Centurion  
UNIVERSITY

Shaping Lives...  
Empowering Communities...

# Line encoding C/Cs

Self synchronization - the clocks at the sender and the receiver must have the same bit interval.

If the receiver clock is faster or slower it will misinterpret the incoming bit stream.



**Centurion**  
**UNIVERSITY**

*Shaping Lives...  
Empowering Communities...*

# Effect of lack of synchronization

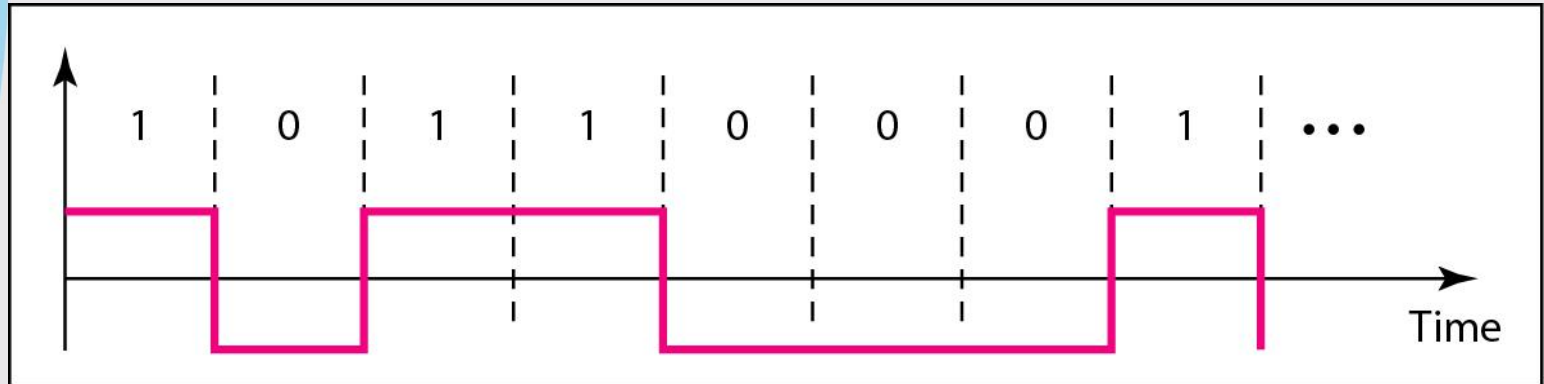

a. Sent

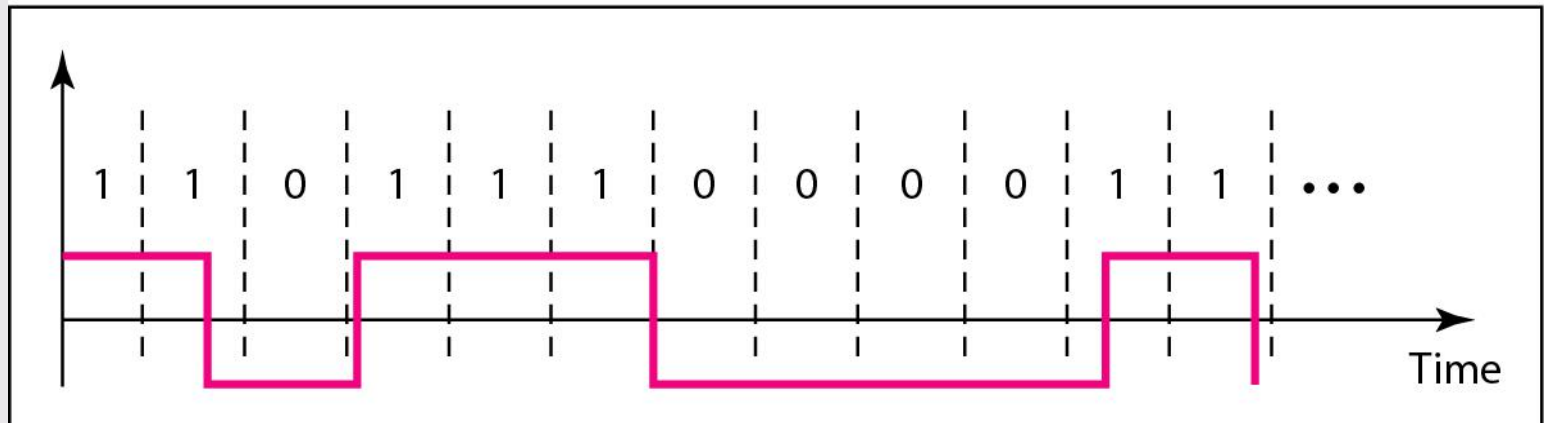

b. Received

# Example



Centurion  
UNIVERSITY

Shaping Lives...  
Empowering Communities...

***In a digital transmission, the receiver clock is 0.1 percent faster than the sender clock. How many extra bits per second does the receiver receive if the data rate is 1 kbps? How many if the data rate is 1 Mbps?***

## ***Solution***

***At 1 kbps, the receiver receives 1001 bps instead of 1000 bps.***

1000 bits sent

1001 bits received

1 extra bps

***At 1 Mbps, the receiver receives 1,001,000 bps instead of 1,000,000 bps.***

1,000,000 bits sent

1,001,000 bits received

1000 extra bps



Centurion  
UNIVERSITY

Shaping Lives...  
Empowering Communities...

# Line encoding C/Cs

Error detection - errors occur during transmission due to line impairments.

Some codes are constructed such that when an error occurs it can be detected. For example: a particular signal transition is not part of the code. When it occurs, the receiver will know that a symbol error has occurred.



**Centurion**  
**UNIVERSITY**

*Shaping Lives...  
Empowering Communities...*

# Line encoding C/Cs

Noise and interference - there are line encoding techniques that make the transmitted signal “immune” to noise and interference.

This means that the signal cannot be corrupted, it is stronger than error detection.



Centurion  
UNIVERSITY

*Shaping Lives...  
Empowering Communities...*

# Line encoding C/Cs

Complexity - the more robust and resilient the code, the more complex it is to implement and the price is often paid in baud rate or required bandwidth.



# Line coding schemes

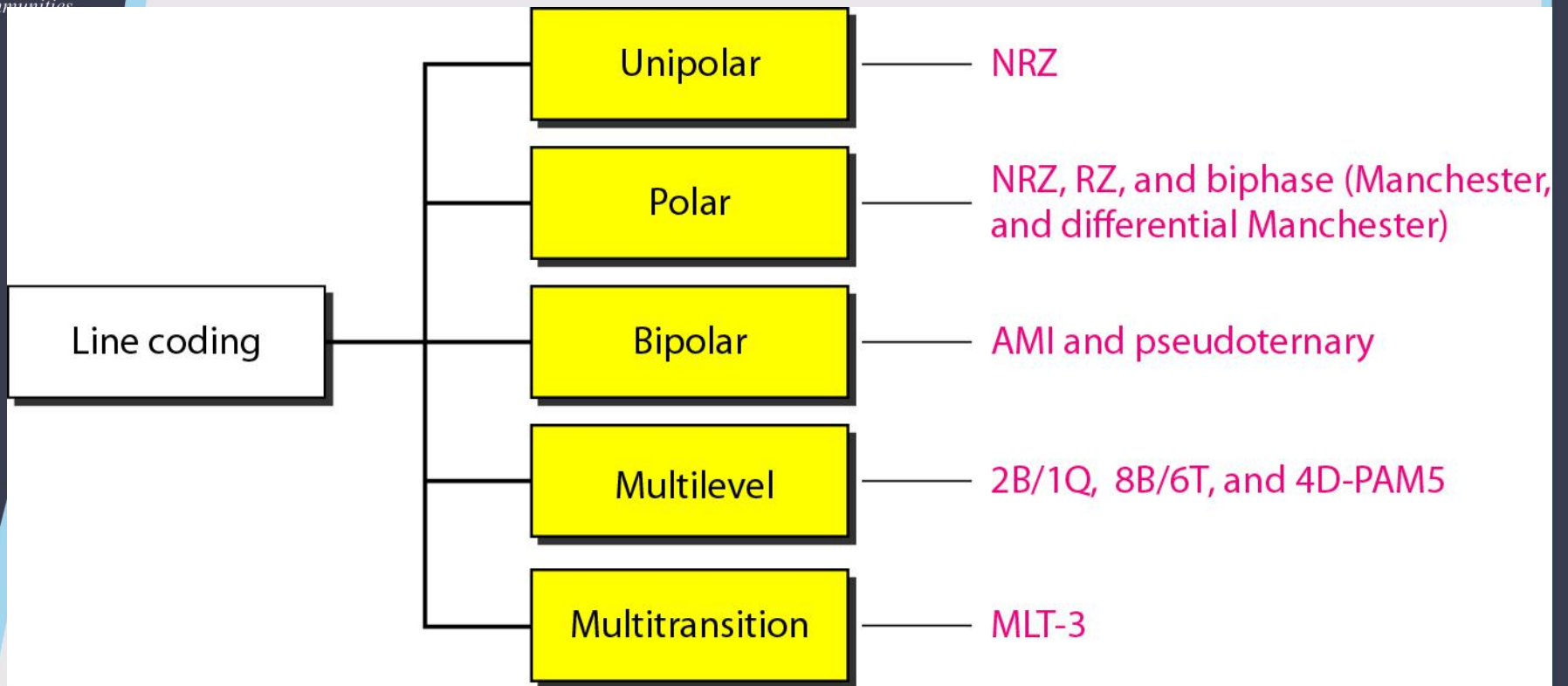



**Centurion**  
**UNIVERSITY**

*Shaping Lives...  
Empowering Communities...*

# Unipolar

- All signal levels are on one side of the time axis - either above or below
- NRZ - Non Return to Zero scheme is an example of this code. The signal level does not return to zero during a symbol transmission.
- Scheme is prone to baseline wandering and DC components. It has no synchronization or any error detection. It is simple but costly in power consumption.



Centurion  
UNIVERSITY

Shaping Lives...  
Empowering Communities...

# Unipolar NRZ scheme

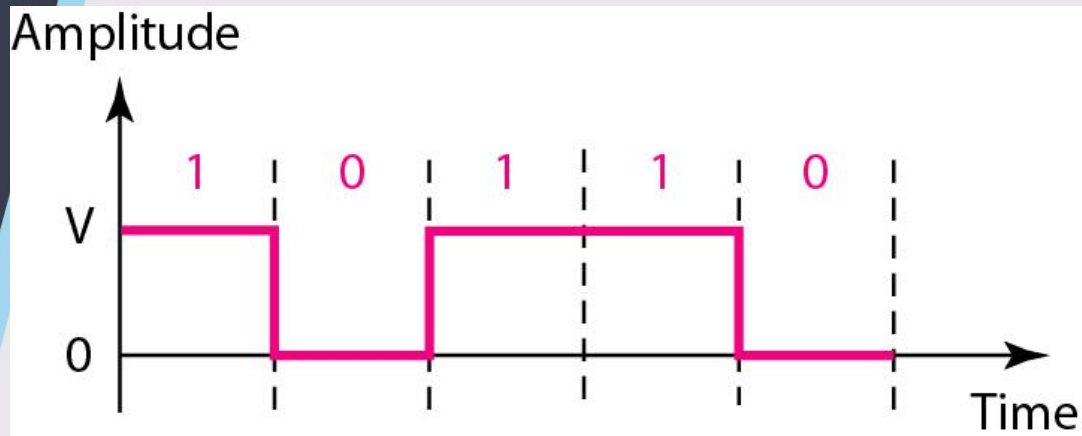

$$\frac{1}{2}V^2 + \frac{1}{2}(0)^2 = \frac{1}{2}V^2$$

Normalized power



Centurion  
UNIVERSITY

Shaping Lives...  
Empowering Communities...

# Polar - NRZ

- The voltages are on both sides of the time axis.
- Polar NRZ scheme can be implemented with two voltages. E.g.  $+V$  for 1 and  $-V$  for 0.
- There are two versions:
  - NRZ - Level (NRZ-L) - positive voltage for one symbol and negative for the other
  - NRZ - Inversion (NRZ-I) - the change or lack of change in polarity determines the value of a symbol. E.g. a “1” symbol inverts the polarity a “0” does not.



**Centurion**  
**UNIVERSITY**  
*Shaping Lives...  
Empowering Communities...*

# Polar NRZ-L and NRZ-I schemes

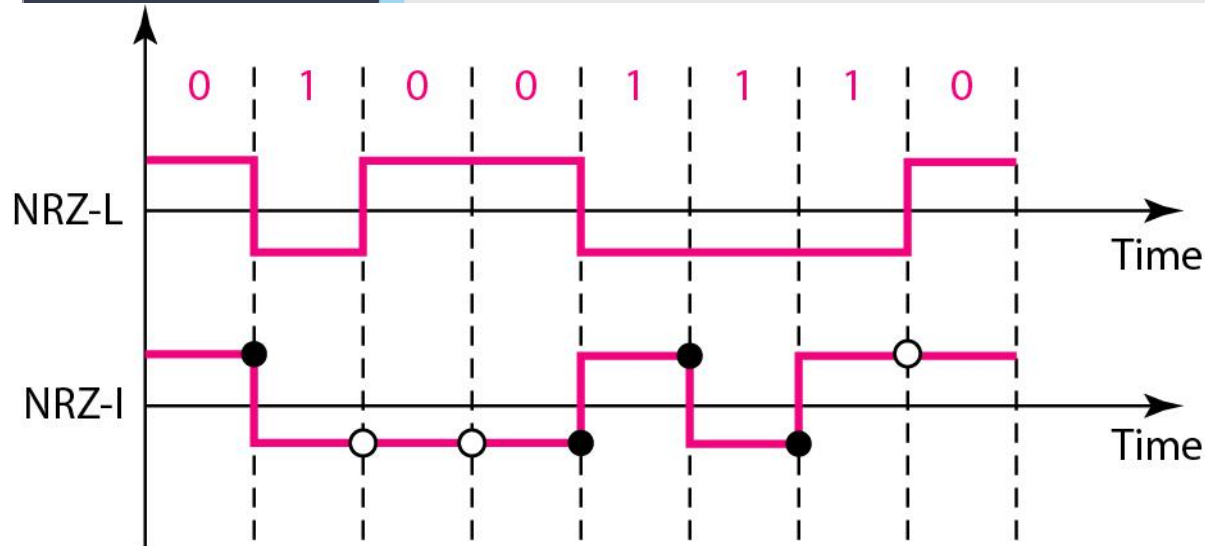

○ No inversion: Next bit is 0      ● Inversion: Next bit is 1

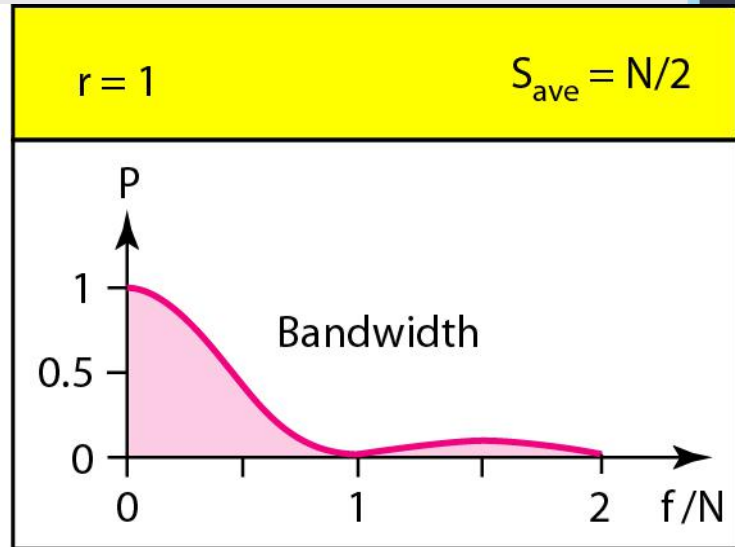



Centurion  
UNIVERSITY

Shaping Lives...  
Empowering Communities...

## Note

**In NRZ-L the level of the voltage determines the value of the bit.**

**In NRZ-I the inversion or the lack of inversion determines the value of the bit.**



**Centurion**  
**UNIVERSITY**

*Shaping Lives...  
Empowering Communities...*

## **Note**

**NRZ-L and NRZ-I both have an average signal rate of  $N/2$  Bd.**



Centurion  
UNIVERSITY

Shaping Lives...  
Empowering Communities...

## Note

**NRZ-L and NRZ-I both have a DC component problem and baseline wandering, it is worse for NRZ-L. Both have no self synchronization & no error detection. Both are relatively simple to implement.**



Centurion  
UNIVERSITY

Shaping Lives...  
Empowering Communities...

# Example

***A system is using NRZ-I to transfer 1-Mbps data. What are the average signal rate and minimum bandwidth?***

## ***Solution***

***The average signal rate is  $S = c \times N \times R = 1/2 \times N \times 1 = 500$  kbaud. The minimum bandwidth for this average baud rate is  $B_{min} = S = 500$  kHz.***

***Note  $c = 1/2$  for the avg. case as worst case is 1 and best case is 0***



Centurion  
UNIVERSITY

Shaping Lives...  
Empowering Communities...

# Polar - RZ

- The Return to Zero (RZ) scheme uses three voltage values. +, 0, -.
- Each symbol has a transition in the middle. Either from high to zero or from low to zero.
- This scheme has more signal transitions (two per symbol) and therefore requires a wider bandwidth.
- No DC components or baseline wandering.
- Self synchronization - transition indicates symbol value.
- More complex as it uses three voltage level. It has no error detection capability.



Centurion  
UNIVERSITY

Shaping Lives...  
Empowering Communities...

# Polar RZ scheme

Amplitude

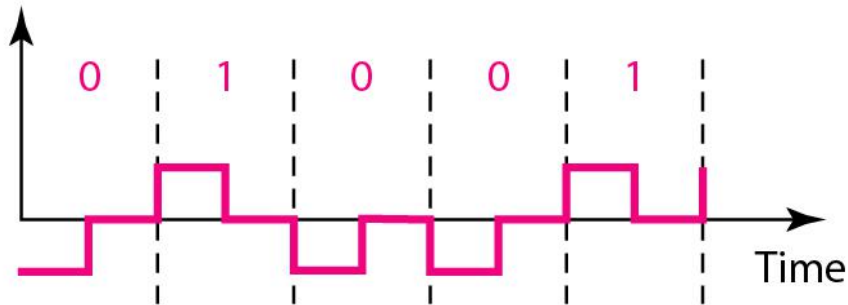

$$r = \frac{1}{2}$$

$$S_{\text{ave}} = N$$

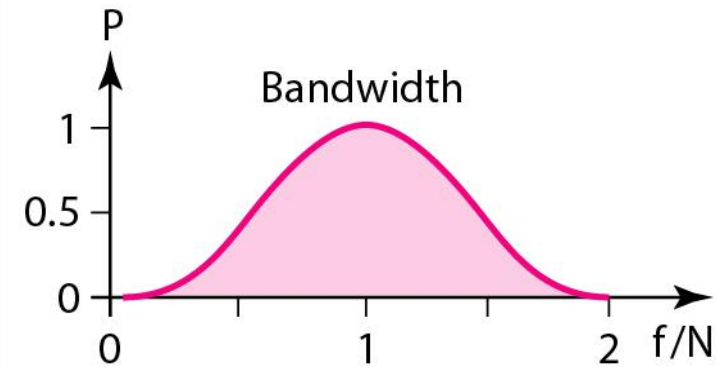



Centurion  
UNIVERSITY

Shaping Lives...  
Empowering Communities...

# Polar - Biphasic: Manchester and Differential Manchester

- Manchester coding consists of combining the NRZ-L and RZ schemes.

Every symbol has a level transition in the middle: from high to low or low to high. Uses only two voltage levels.

- Differential Manchester coding consists of combining the NRZ-I and RZ schemes.

Every symbol has a level transition in the middle. But the level at the beginning of the symbol is determined by the symbol value. One symbol causes a level change the other does not.



**Centurion**  
**UNIVERSITY**

Shaping Lives...  
Empowering Communities...

# Polar biphasic: Manchester and differential Manchester schemes

0 is 1 is

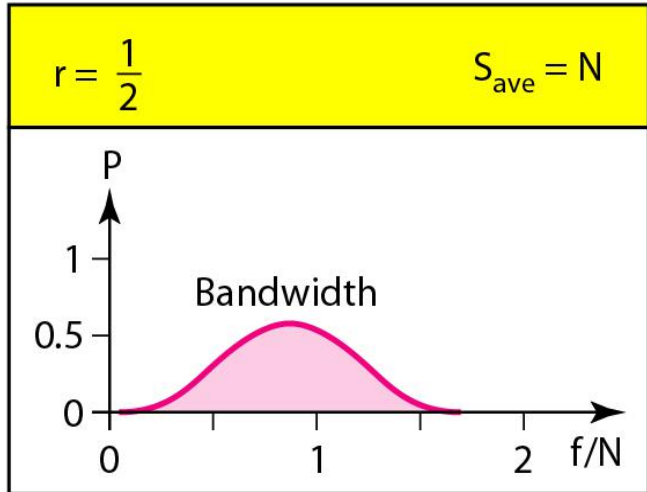
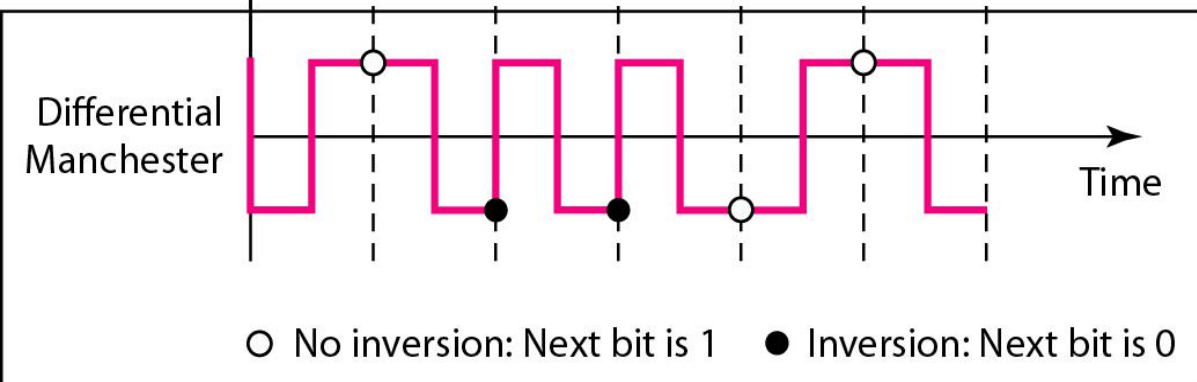
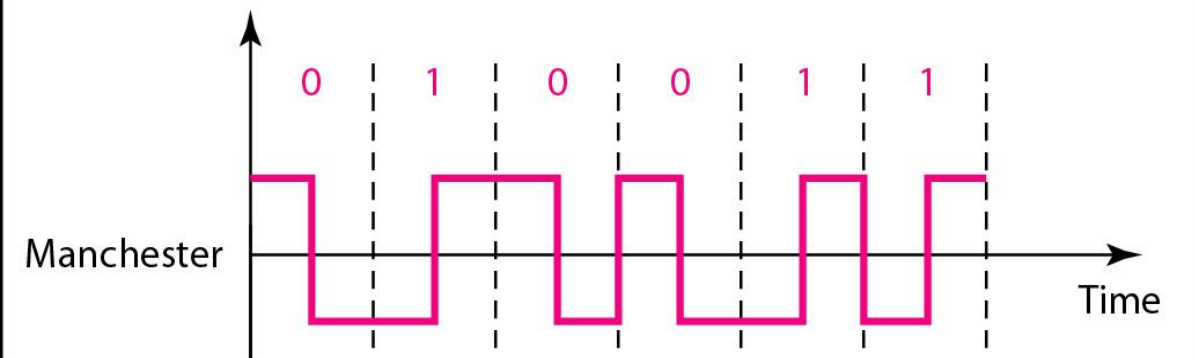



**Centurion**  
**UNIVERSITY**

*Shaping Lives...  
Empowering Communities...*

## **Note**

**In Manchester and differential Manchester encoding, the transition at the middle of the bit is used for synchronization.**



**Centurion**  
**UNIVERSITY**

*Shaping Lives...  
Empowering Communities...*

## **Note**

**The minimum bandwidth of Manchester and differential Manchester is 2 times that of NRZ. There is no DC component and no baseline wandering. None of these codes has error detection.**



Centurion  
UNIVERSITY  
*Shaping Lives...  
Empowering Communities...*

# Bipolar - AMI and Pseudoternary

- Code uses 3 voltage levels:  $+$ ,  $0$ ,  $-$ , to represent the symbols (note not transitions to zero as in RZ).
- Voltage level for one symbol is at “0” and the other alternates between  $+$  &  $-$ .
- Bipolar Alternate Mark Inversion (AMI) - the “0” symbol is represented by zero voltage and the “1” symbol alternates between  $+V$  and  $-V$ .
- Pseudoternary is the reverse of AMI.



**Centurion**  
**UNIVERSITY**

*Shaping Lives...  
Empowering Communities...*

# Bipolar schemes: AMI and pseudoternary

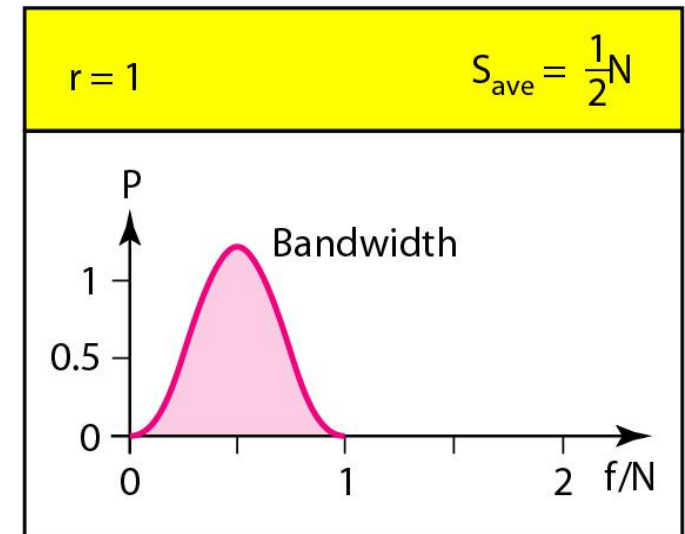
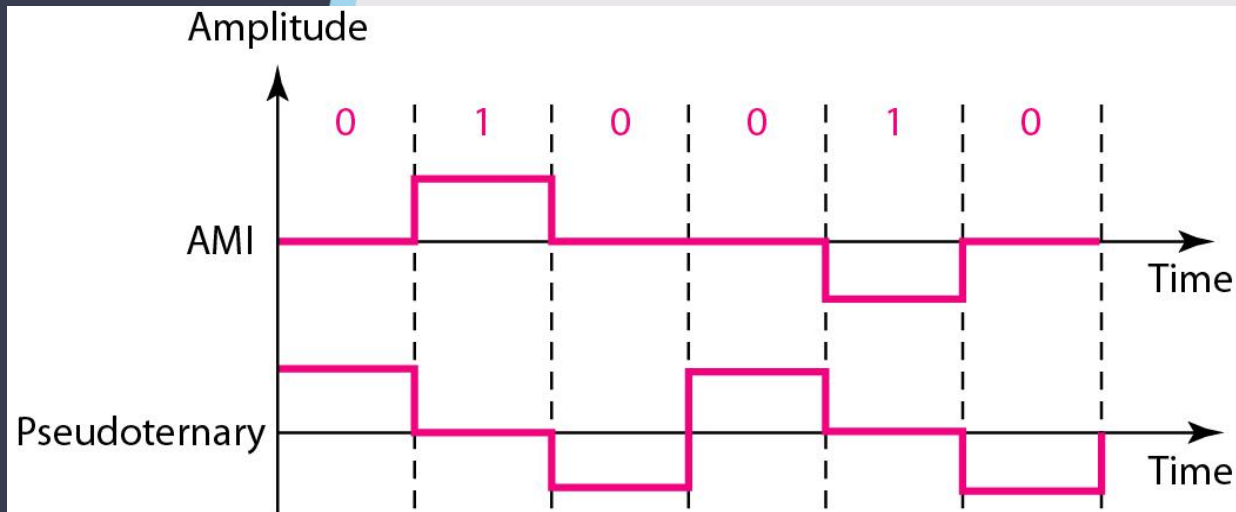



**Centurion**  
**UNIVERSITY**

*Shaping Lives...  
Empowering Communities...*

# Bipolar C/Cs

- It is a better alternative to NRZ.
- Has no DC component or baseline wandering.
- Has no self synchronization because long runs of “0”s results in no signal transitions.
- No error detection.



**Centurion**  
**UNIVERSITY**

*Shaping Lives...  
Empowering Communities...*

# Multilevel Schemes

- In these schemes we increase the number of data bits per symbol thereby increasing the bit rate.
- Since we are dealing with binary data we only have 2 types of data element a 1 or a 0.
- We can combine the 2 data elements into a pattern of “m” elements to create “ $2^m$ ” symbols.
- If we have L signal levels, we can use “n” signal elements to create  $L^n$  signal elements.

# Code C/Cs



**Centurion**  
**UNIVERSITY**  
*Shaping Lives...  
Empowering Communities...*

- Now we have  $2^m$  symbols and  $L^n$  signals.
- If  $2^m > L^n$  then we cannot represent the data elements, we don't have enough signals.
- If  $2^m = L^n$  then we have an exact mapping of one symbol on one signal.
- If  $2^m < L^n$  then we have more signals than symbols and we can choose the signals that are more distinct to represent the symbols and therefore have better noise immunity and error detection as some signals are not valid.



Centurion  
UNIVERSITY

Shaping Lives...  
Empowering Communities...

## Note

**In  $mBnL$  schemes, a pattern of  $m$  data elements is encoded as a pattern of  $n$  signal elements in which  $2^m \leq L^n$ .**



**Centurion**  
**UNIVERSITY**

*Shaping Lives...  
Empowering Communities...*

# Representing Multilevel Codes

- We use the notation  $mBnL$ , where  $m$  is the length of the binary pattern,  $B$  represents binary data,  $n$  represents the length of the signal pattern and  $L$  the number of levels.
- $L = B$  binary,  $L = T$  for 3 ternary,  $L = Q$  for 4 quaternary.



**Centurion**  
**UNIVERSITY**

Shaping Lives...  
Empowering Communities...

# Multilevel: 2B1Q scheme

Previous level: positive      Previous level: negative

Next bits	Next level	Next level
00	+1	-1
01	+3	-3
10	-1	+1
11	-3	+3

Transition table

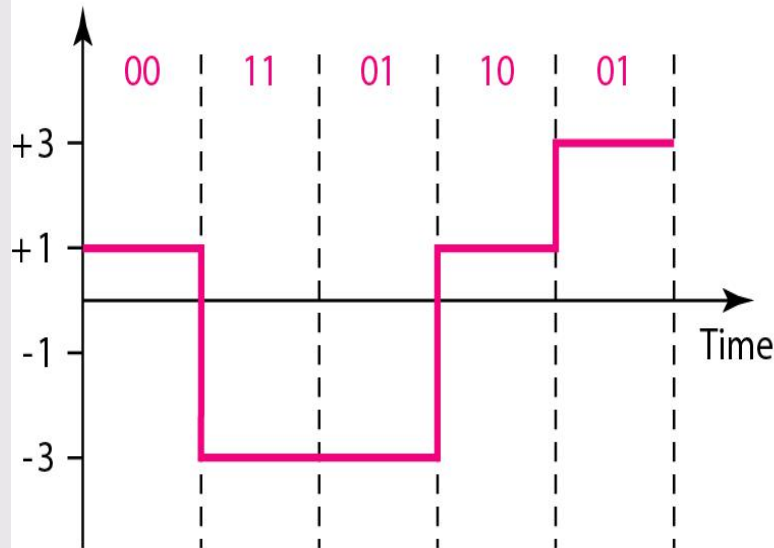

Assuming positive original level

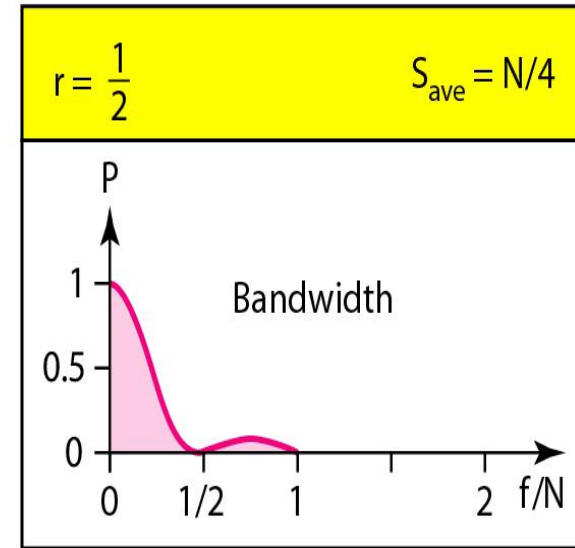



Centurion  
UNIVERSITY

Shaping Lives...  
Empowering Communities...

# Redundancy

- In the 2B1Q scheme we have no redundancy and we see that a DC component is present.
- If we use a code with redundancy we can decide to use only “0” or “+” weighted codes (more +’s than -’s in the signal element) and invert any code that would create a DC component. E.g. ‘+00++-’  $\rightarrow$  ‘-00--+’
- Receiver will know when it receives a “-” weighted code that it should invert it as it doesn’t represent any valid symbol.



**Centurion**  
**UNIVERSITY**  
*Shaping Lives...  
Empowering Communities...*

# Multilevel: 8B6T scheme

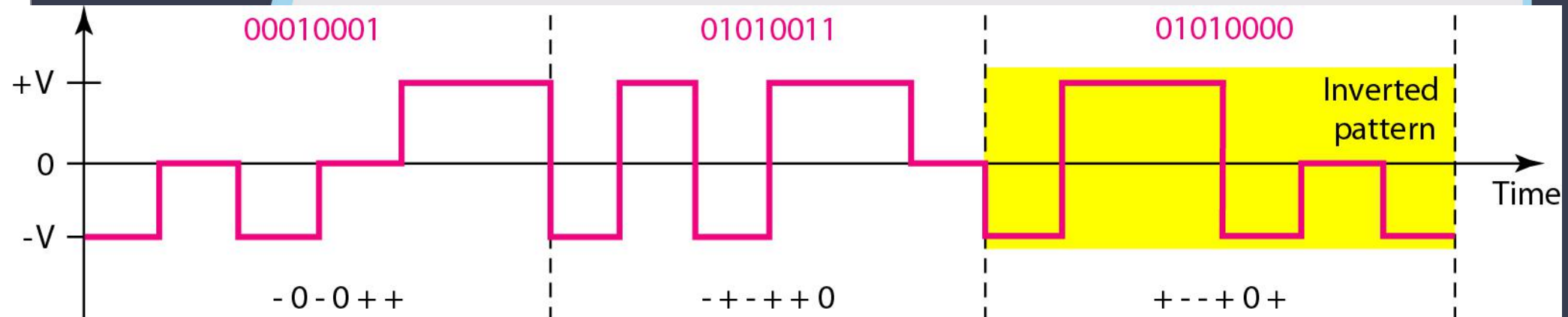



**Centurion**  
**UNIVERSITY**

*Shaping Lives...  
Empowering Communities...*

# Multilevel using multiple channels

- In some cases, we split the signal transmission up and distribute it over several links.
- The separate segments are transmitted simultaneously. This reduces the signalling rate per link -> lower bandwidth.
- This requires all bits for a code to be stored.
- xD: means that we use 'x' links
- YYYz: We use 'z' levels of modulation where YYY represents the type of modulation (e.g. pulse ampl. mod. PAM).
- Codes are represented as: xD-YYYz



**Centurion**  
**UNIVERSITY**  
*Shaping Lives...  
Empowering Communities...*

# Multilevel: 4D-PAM5 scheme

00011110

1 Gbps

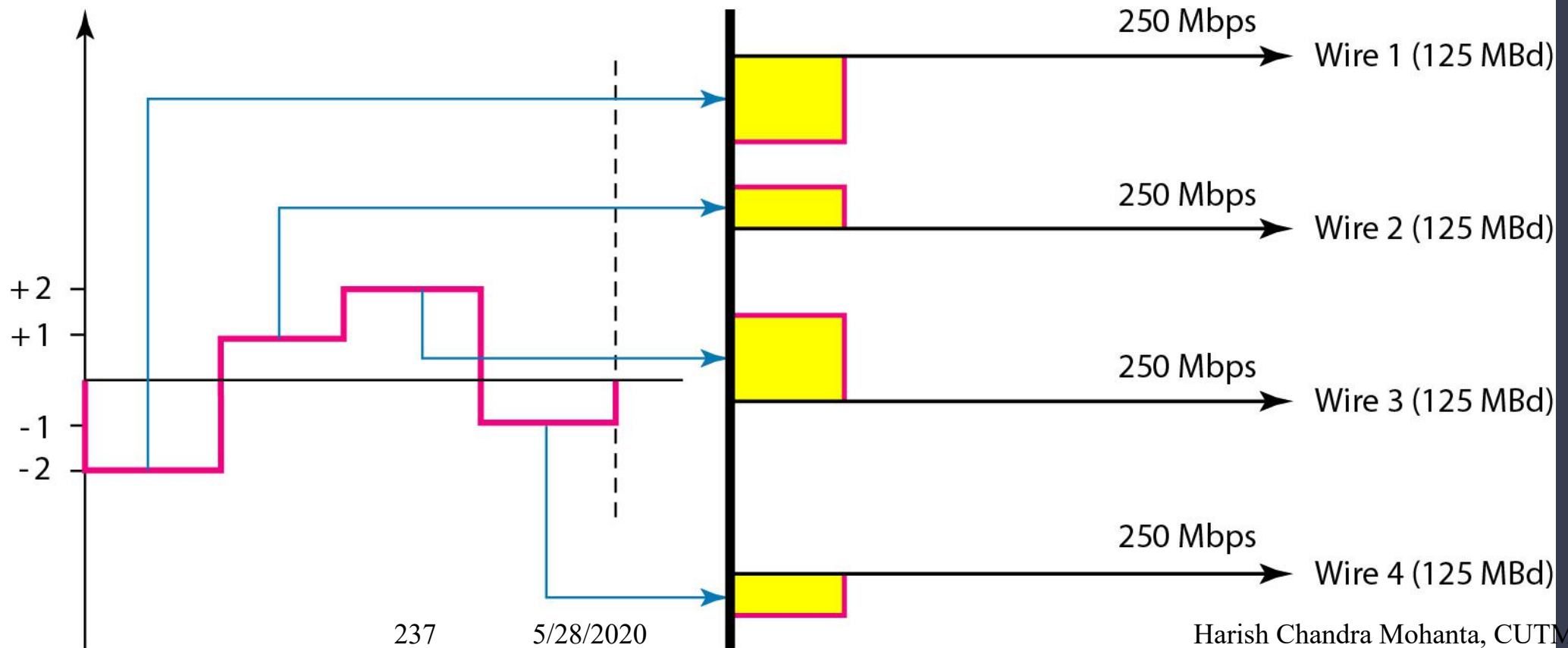

237

5/28/2020

Harish Chandra Mohanta, CUTM,  
Bhubaneswar Campus



Centurion  
UNIVERSITY

Shaping Lives...  
Empowering Communities...

# Multitransition Coding

- Because of synchronization requirements we force transitions. This can result in very high bandwidth requirements -> more transitions than are bits (e.g. mid bit transition with inversion).
- Codes can be created that are differential at the bit level forcing transitions at bit boundaries. This results in a bandwidth requirement that is equivalent to the bit rate.
- In some instances, the bandwidth requirement may even be lower, due to repetitive patterns resulting in a periodic signal.



**Centurion**  
**UNIVERSITY**

*Shaping Lives...  
Empowering Communities...*

# Multitransition: MLT-3 scheme

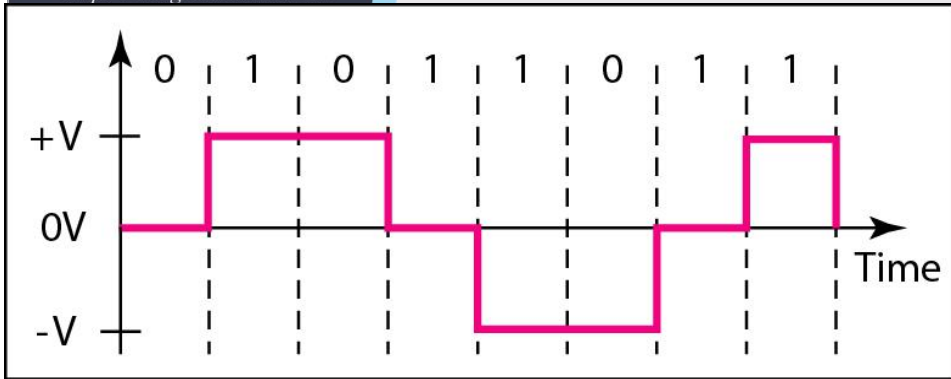

a. Typical case

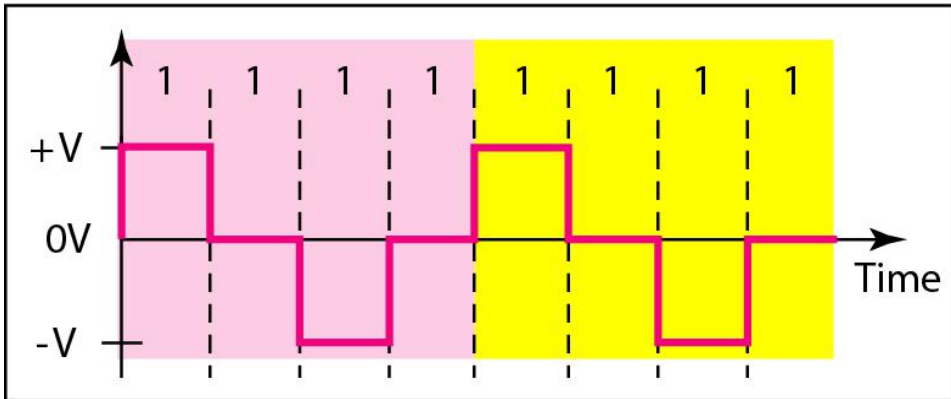

b. Worse case

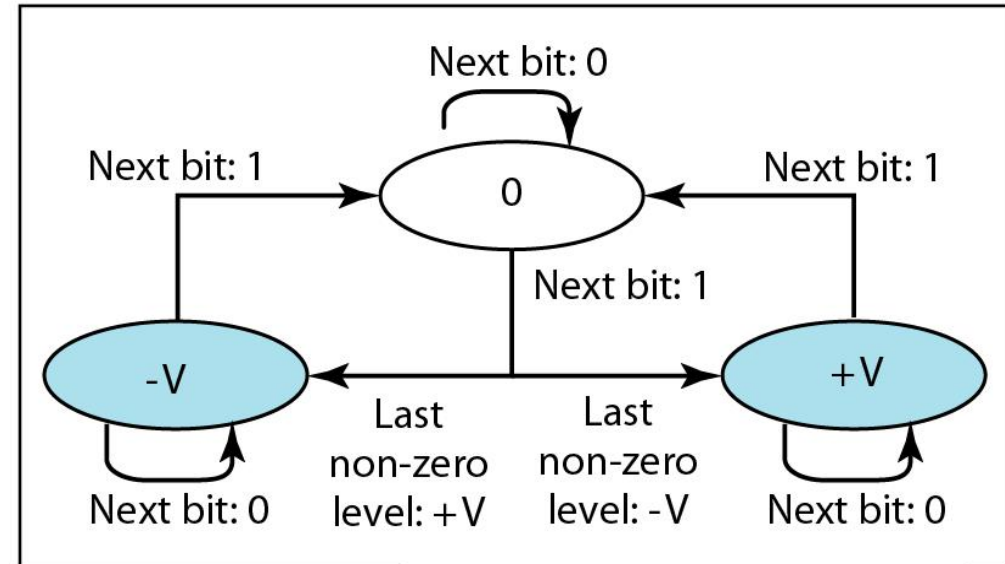

c. Transition states

# MLT-3



**Centurion**  
**UNIVERSITY**

*Shaping Lives...  
Empowering Communities...*

- Signal rate is same as NRZ-I
- But because of the resulting bit pattern, we have a periodic signal for worst case bit pattern: 1111
- This can be approximated as an analog signal a frequency  $1/4$  the bit rate!



**Centurion**  
**UNIVERSITY**

*Shaping Lives...  
Empowering Communities...*

# Summary of line coding schemes

<i>Category</i>	<i>Scheme</i>	<i>Bandwidth (average)</i>	<i>Characteristics</i>
Unipolar	NRZ	$B = N/2$	Costly, no self-synchronization if long 0s or 1s, DC
Unipolar	NRZ-L	$B = N/2$	No self-synchronization if long 0s or 1s, DC
	NRZ-I	$B = N/2$	No self-synchronization for long 0s, DC
	Biphase	$B = N$	Self-synchronization, no DC, high bandwidth
Bipolar	AMI	$B = N/2$	No self-synchronization for long 0s, DC
Multilevel	2B1Q	$B = N/4$	No self-synchronization for long same double bits
	8B6T	$B = 3N/4$	Self-synchronization, no DC
	4D-PAM5	$B = N/8$	Self-synchronization, no DC
Multiline	MLT-3	$B = N/3$	No self-synchronization for long 0s



# Block Coding

- For a code to be capable of error detection, we need to add redundancy, i.e., extra bits to the data bits.
- Synchronization also requires redundancy - transitions are important in the signal flow and must occur frequently.
- Block coding is done in three steps: division, substitution and combination.
- It is distinguished from multilevel coding by use of the slash -  $x\text{B}/y\text{B}$ .
- The resulting bit stream prevents certain bit combinations that when used with line encoding would result in DC components or poor sync. quality.



Centurion  
UNIVERSITY

Shaping Lives...  
Empowering Communities...

*Note*

**Block coding is normally referred to as  $mB/nB$  coding;  
it replaces each  $m$ -bit group with an  $n$ -bit group.**



Centurion  
UNIVERSITY

Shaping Lives...  
Empowering Communities...

# Block coding concept

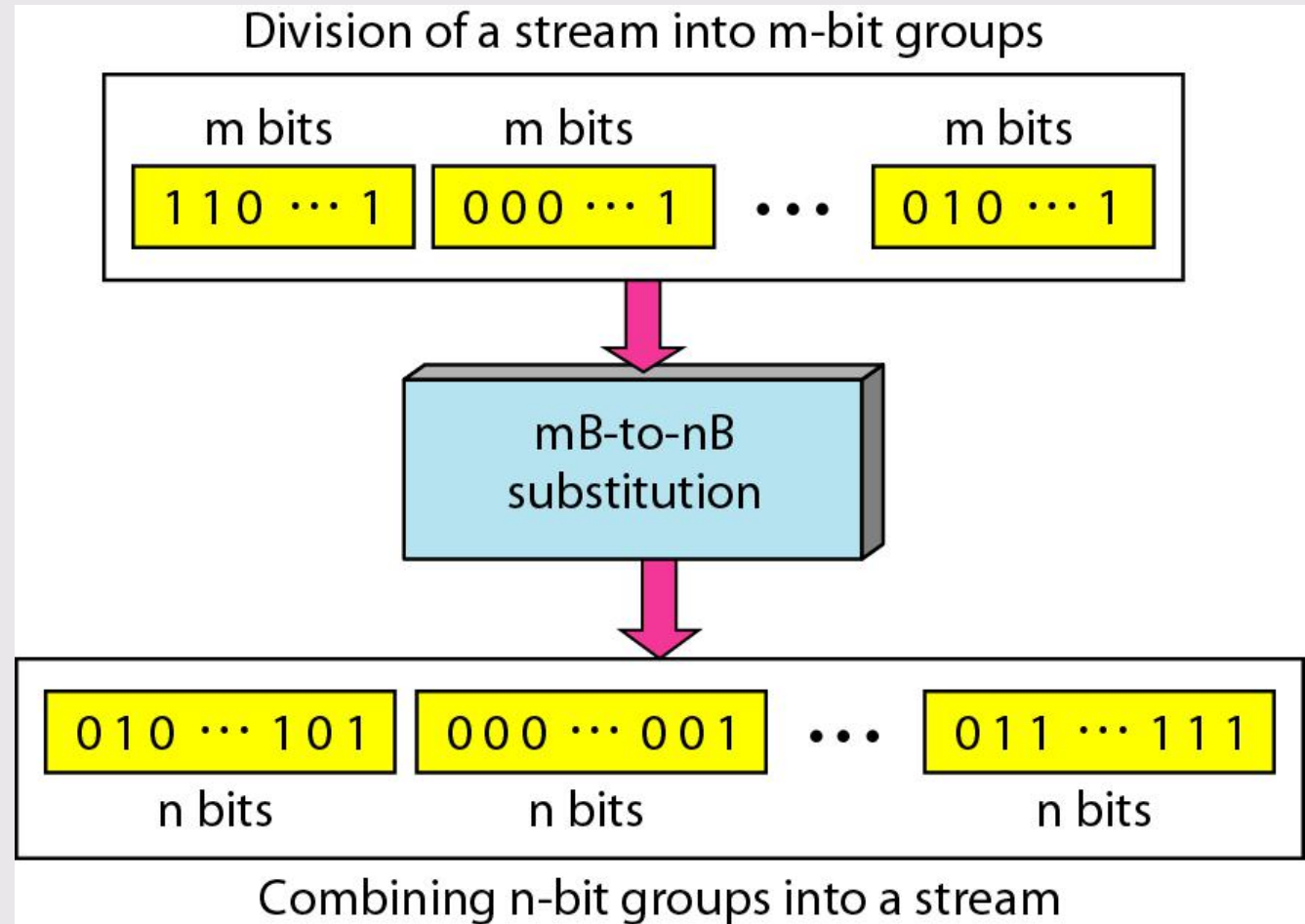



**Centurion**  
**UNIVERSITY**

*Shaping Lives...  
Empowering Communities...*

# Using block coding 4B/5B with NRZ-I line coding scheme

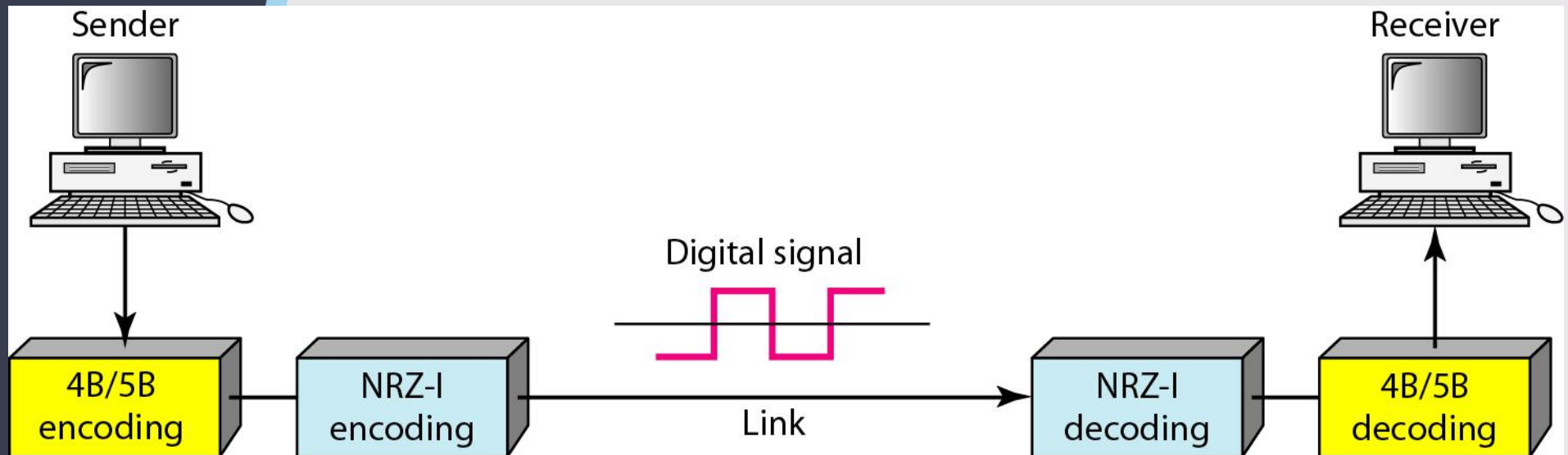



**Centurion**  
**UNIVERSITY**

Shaping Lives...  
Empowering Communities...

# 4B/5B mapping codes

<i>Data Sequence</i>	<i>Encoded Sequence</i>	<i>Control Sequence</i>	<i>Encoded Sequence</i>
0000	11110	Q (Quiet)	00000
0001	01001	I (Idle)	11111
0010	10100	H (Halt)	00100
0011	10101	J (Start delimiter)	11000
0100	01010	K (Start delimiter)	10001
0101	01011	T (End delimiter)	01101
0110	01110	S (Set)	11001
0111	01111	R (Reset)	00111
1000	10010		
1001	10011		
1010	10110		
1011	10111		
1100	11010		
1101	11011		
1110	11100		
1111	11101		

246 5/28/2020

Harish Chandra Mohanta, CUTM,  
Bhubaneswar Campus



# Substitution in 4B/5B block coding

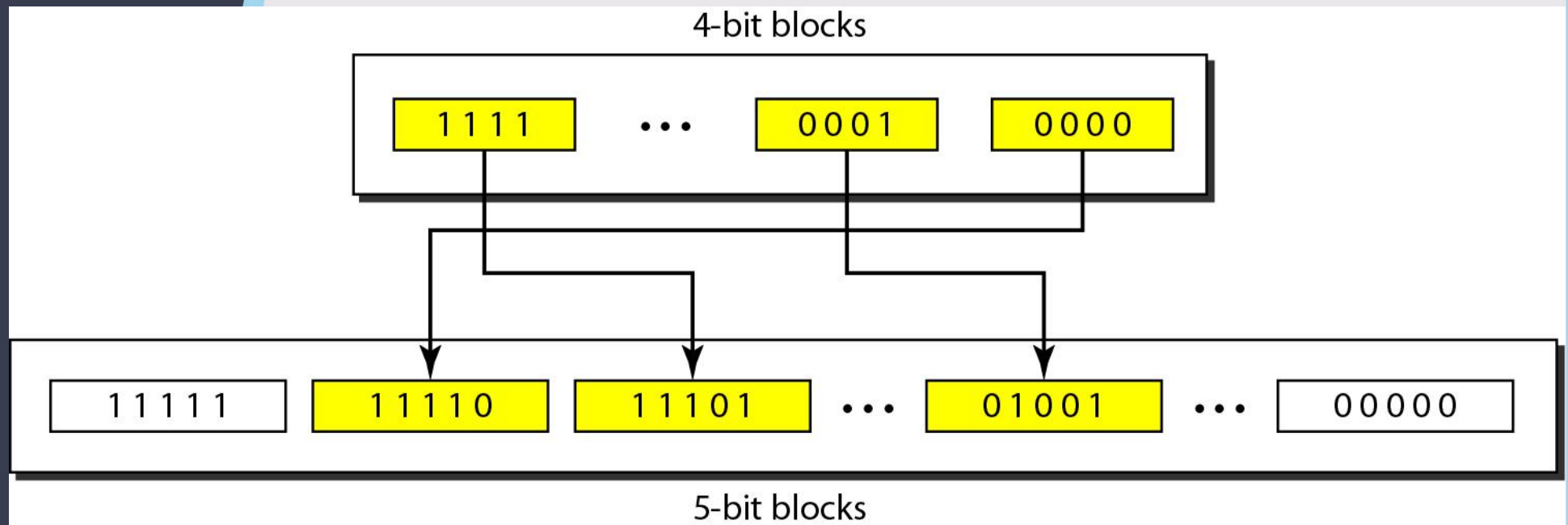



Centurion  
UNIVERSITY

Shaping Lives...  
Empowering Communities...

# Redundancy

- A 4 bit data word can have 24 combinations.
- A 5 bit word can have  $2^5=32$  combinations.
- We therefore have  $32 - 2^6 = 16$  extra words.
- Some of the extra words are used for control/signalling purposes.

# Example



Centurion  
UNIVERSITY

Shaping Lives...  
Empowering Communities...

**We need to send data at a 1-Mbps rate. What is the minimum required bandwidth, using a combination of 4B/5B and NRZ-I or Manchester coding?**

## Solution

First 4B/5B block coding increases the bit rate to 1.25 Mbps. The minimum bandwidth using NRZ-I is  $N/2$  or 625 kHz. The Manchester scheme needs a minimum bandwidth of 1.25 MHz. The first choice needs a lower bandwidth, but has a DC component problem; the second choice needs a higher bandwidth, but does not have a DC component problem.



# 8B/10B block encoding

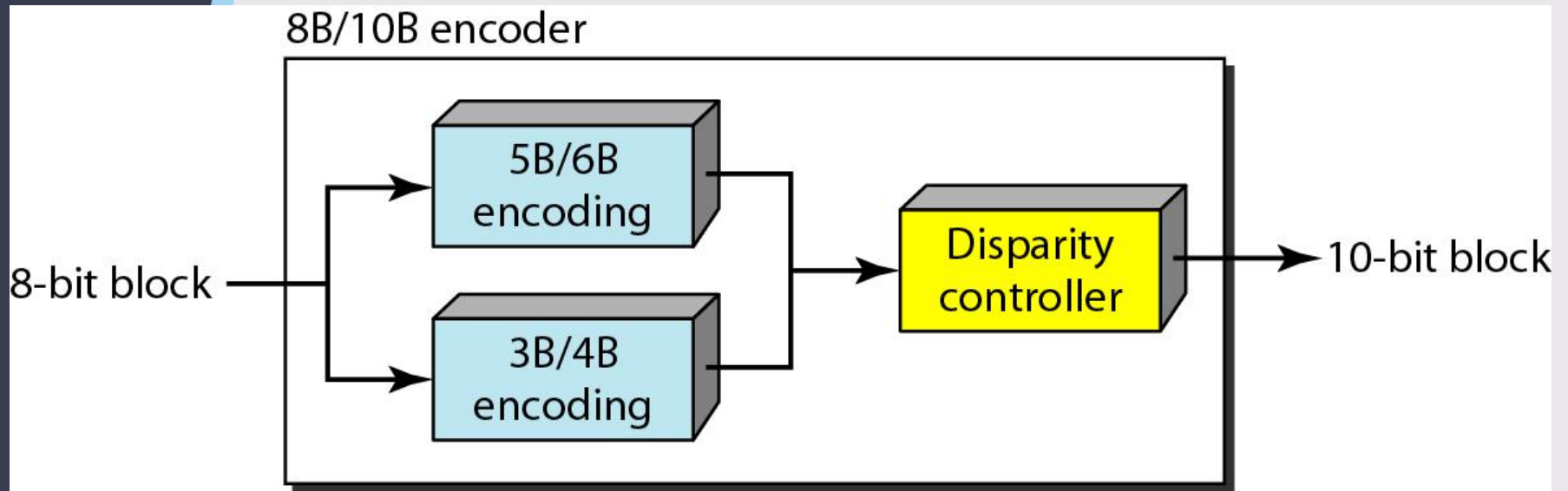



**Centurion**  
**UNIVERSITY**

*Shaping Lives...  
Empowering Communities...*

# More bits - better error detection

- The 8B10B block code adds more redundant bits and can thereby choose code words that would prevent a long run of a voltage level that would cause DC components.



**Centurion**  
**UNIVERSITY**

*Shaping Lives...  
Empowering Communities...*

# Scrambling

- The best code is one that does not increase the bandwidth for synchronization and has no DC components.
- Scrambling is a technique used to create a sequence of bits that has the required c/c's for transmission - self clocking, no low frequencies, no wide bandwidth.
- It is implemented at the same time as encoding, the bit stream is created on the fly.
- It replaces 'unfriendly' runs of bits with a violation code that is easy to recognize and removes the unfriendly c/c.



Centurion  
UNIVERSITY

Shaping Lives...  
Empowering Communities...

# AMI used with scrambling

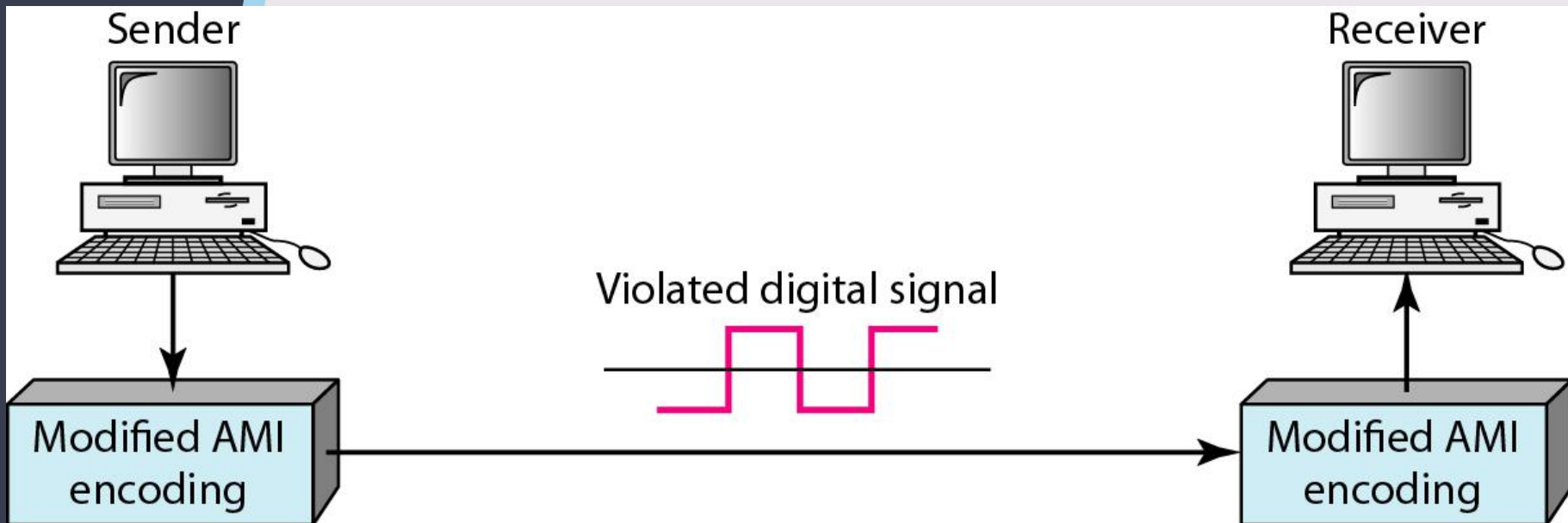



**Centurion**  
**UNIVERSITY**

*Shaping Lives...  
Empowering Communities...*

**For example: B8ZS substitutes eight consecutive zeros with 000VB0VB. The V stands for violation, it violates the line encoding rule**

**B stands for bipolar, it implements the bipolar line encoding rule**



Centurion  
UNIVERSITY

Shaping Lives...  
Empowering Communities...

# Two cases of B8ZS scrambling technique

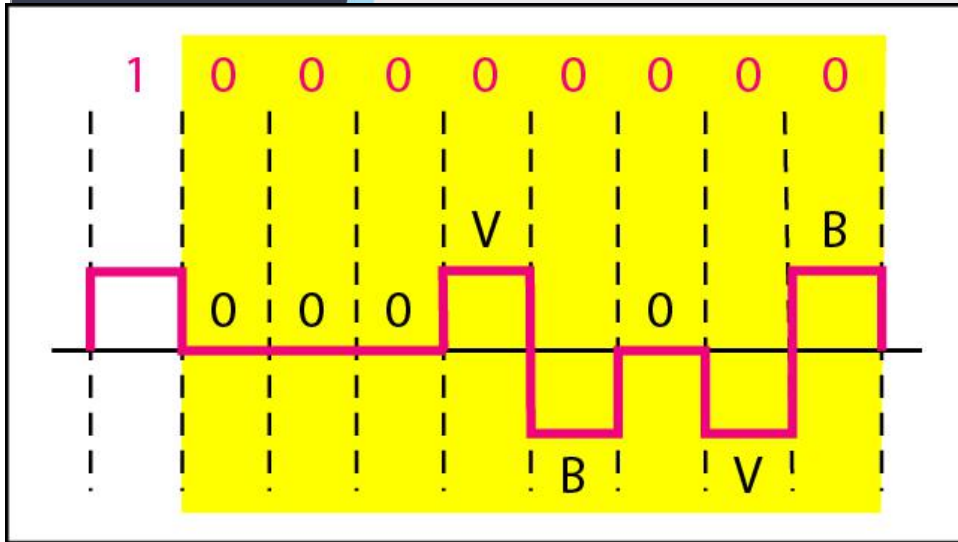

a. Previous level is positive.

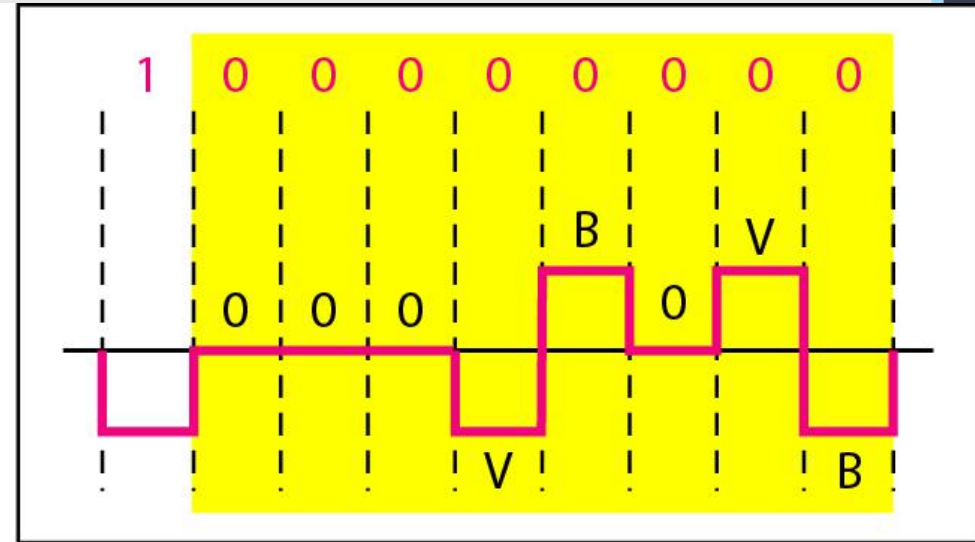

b. Previous level is negative.



**Centurion**  
**UNIVERSITY**

*Shaping Lives...  
Empowering Communities...*

**HDB3 substitutes four consecutive zeros with 000V or B00V depending on the number of nonzero pulses after the last substitution. If # of non zero pulses is even the substitution is B00V to make total # of non zero pulse even. If # of non zero pulses is odd the substitution is 000V to make total # of non zero pulses even.**



Centurion  
UNIVERSITY

Shaping Lives...  
Empowering Communities...

# Different situations in HDB3 scrambling technique

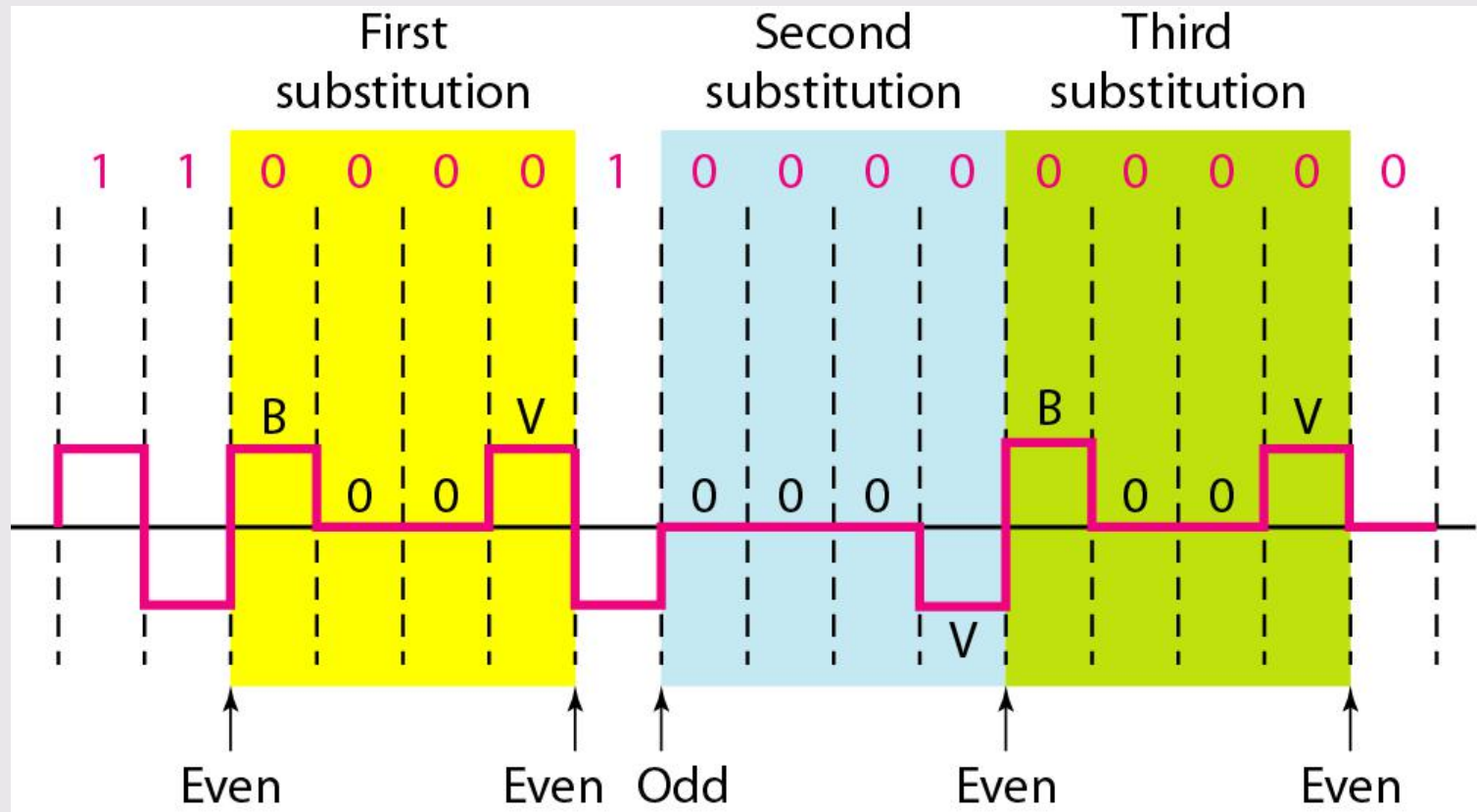



Centurion  
UNIVERSITY

Shaping Lives...  
Empowering Communities...

# Receiver Structure

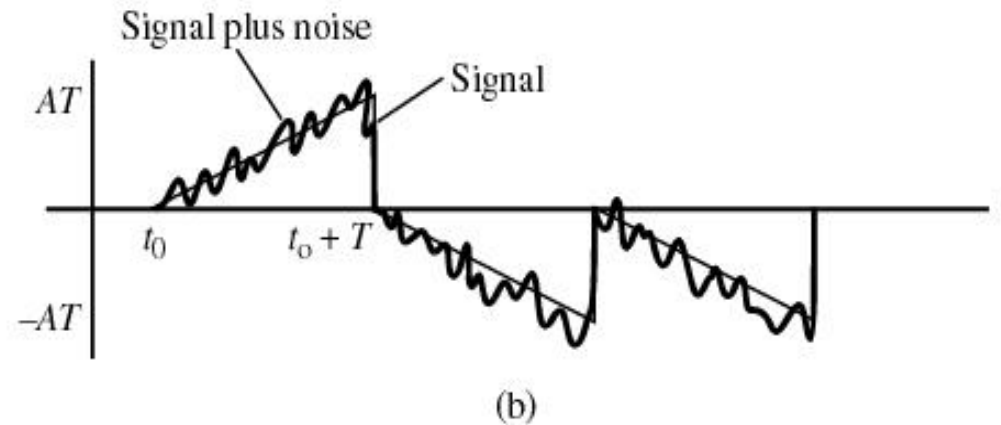
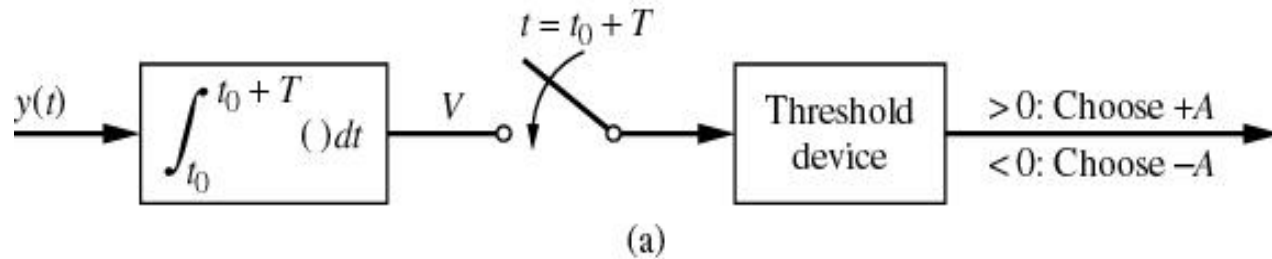

Figure 7-3 Receiver structure and integrator output. (a) Integrate-and-dump receiver. (b) Output from the integrator.



Centurion  
UNIVERSITY

Shaping Lives...  
Empowering Communities...

# Receiver Performance

The output of the integrator:

$$V = \int_{t_0}^{t_0+T} [s(t) + n(t)] dt$$
$$= \begin{cases} AT + N & A \text{ is sent} \\ -AT + N & -A \text{ is sent} \end{cases}$$

$$N = \int_{t_0}^{t_0+T} n(t) dt \quad \text{is a random variable.}$$

**N is Gaussian. Why?**



Centurion  
UNIVERSITY

Shaping Lives...  
Empowering Communities...

# Analysis

$$E[N] = E\left[\int_{t_0}^{t_0+T} n(t)dt\right] = \int_{t_0}^{t_0+T} E[n(t)]dt = 0$$

$$\begin{aligned} \text{Var}[N] &= E[N^2] - E^2[N] \\ &= E[N^2] \quad \text{Why?} \end{aligned}$$

$$= E\left\{\left[\int_{t_0}^{t_0+T} n(t)dt\right]^2\right\}$$

$$= \int_{t_0}^{t_0+T} \int_{t_0}^{t_0+T} E[n(t)n(s)]dtds$$

$$= \int_{t_0}^{t_0+T} \int_{t_0}^{t_0+T} \frac{N_0}{2} \delta(t-s)dtds \quad \text{Why? (White noise is uncorrelated!)}$$

$$= \frac{N_0 T}{2}$$

Key Point 260 5/28/2020

White noise is uncorrelated

Harish Chandra Mohanta, CUTM,  
Bhubaneswar Campus



Centurion  
UNIVERSITY

Shaping Lives...  
Empowering Communities...

# Error Analysis

Therefore, the pdf of N is:

$$f_N(n) = \frac{e^{-n^2/(N_0T)}}{\sqrt{\pi N_0T}}$$

In how many different ways, can an error occur?



Centurion  
UNIVERSITY

Shaping Lives...  
Empowering Communities...

# Error Analysis

Two ways in which errors occur:

A is transmitted,  $AT+N<0$  (0 received, 1 sent)

-A is transmitted,  $-AT+N>0$  (1 received, 0 sent)

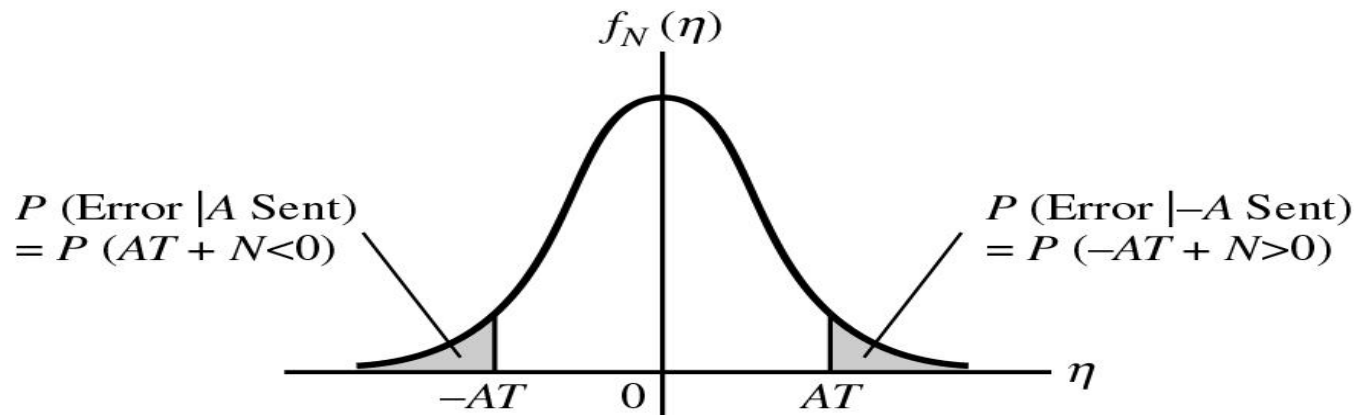

Figure 7-4 Illustration of error probabilities for binary signaling.



Centurion  
UNIVERSITY

Shaping Lives...  
Empowering Communities...

$$P(\text{Error} | A) = \int_{-\infty}^{-AT} \frac{e^{-n^2 / N_0 T}}{\sqrt{\pi N_0 T}} dn = Q\left(\sqrt{\frac{2A^2 T}{N_0}}\right)$$

Similarly,

$$P(\text{Error} | -A) = \int_{AT}^{\infty} \frac{e^{-n^2 / N_0 T}}{\sqrt{\pi N_0 T}} dn = Q\left(\sqrt{\frac{2A^2 T}{N_0}}\right)$$

The average probability of error:

$$\begin{aligned} P_E &= P(E | A)P(A) + P(E | -A)P(-A) \\ &= Q\left(\sqrt{\frac{2A^2 T}{N_0}}\right) \end{aligned}$$



Centurion  
UNIVERSITY

Shaping Lives...  
Empowering Communities...

Energy per bit:

$$E_b = \int_{t_0}^{t_0+T} A^2 dt = A^2 T$$

Therefore, the error can be written in terms of the energy.

Define

$$z = \frac{A^2 T}{N_0} = \frac{E_b}{N_0}$$



Centurion  
UNIVERSITY

Shaping Lives...  
Empowering Communities...

Recall: Rectangular pulse of duration  $T$  seconds has magnitude spectrum

$$AT \operatorname{sinc}(Tf)$$

Effective Bandwidth:  $B_p = 1/T$

Therefore,  $z = \frac{A^2}{N_0 B_p}$

What's the physical meaning of this quantity?



Centurion  
UNIVERSITY

Shaping Lives...  
Empowering Communities...

# Probability of Error vs. SNR

Figure 7-5  
 $P_E$  for antipodal baseband  
digital signaling.

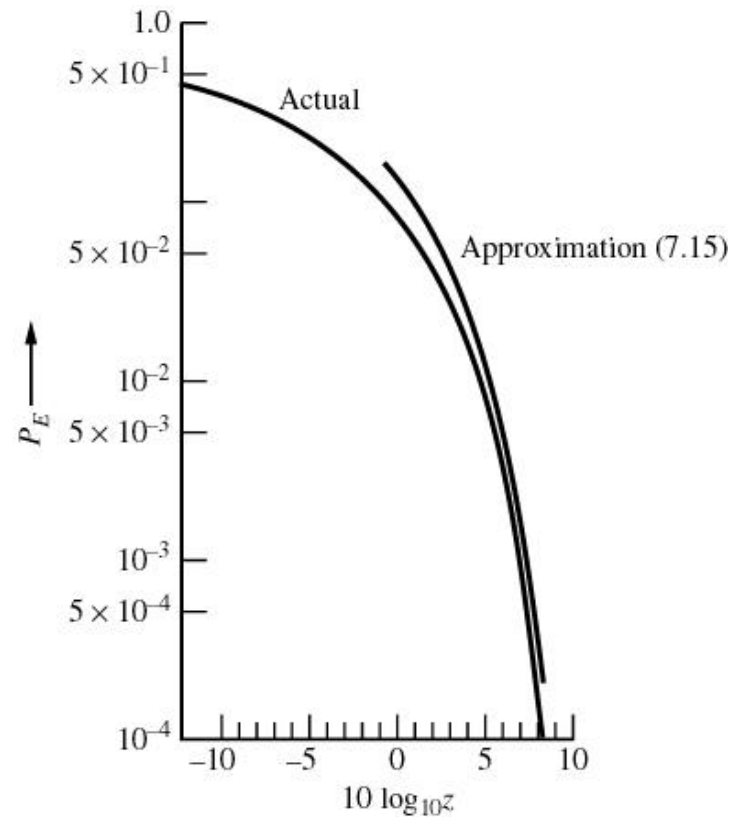

*Principles of Communications, 5/E* by Rodger Ziemer and William Tranter  
Copyright © 2002 John Wiley & Sons, Inc. All rights reserved.



Centurion  
UNIVERSITY

Shaping Lives...  
Empowering Communities...

# Error Approximation

Use the approximation

$$Q(u) \cong \frac{e^{-u^2/2}}{u\sqrt{2\pi}}, u \gg 1$$

$$P_E = Q\left(\sqrt{\frac{2A^2T}{N_0}}\right) \cong \frac{e^{-z}}{2\sqrt{\pi z}}, z \gg 1$$



# Example

Digital data is transmitted through a baseband system with  $N_0 = 10^{-7} \text{ W/Hz}$ , the received pulse amplitude  $A = 20 \text{ mV}$ .

a) If 1 kbps is the transmission rate, what is probability of error?

$$B_p = \frac{1}{T} = \frac{1}{10^{-3}} = 10^3$$

$$SNR = z = \frac{A^2}{N_0 B_p} = \frac{400 \times 10^{-6}}{10^{-7} \times 10^3} = 400 \times 10^{-2} = 4$$

$$P_E \cong \frac{e^{-z}}{2\sqrt{\pi z}} = 2.58 \times 10^{-3}$$



Centurion  
UNIVERSITY

Shaping Lives...  
Empowering Communities...

b) If 10 kbps are transmitted, what must be the value of  $A$  to attain the same probability of error?

$$z = \frac{A^2}{N_0 B_p} = \frac{A^2}{10^{-7} \times 10^4} = 4 \Rightarrow A^2 = 4 \times 10^{-3} \Rightarrow A = 63.2 \text{ mV}$$

Conclusion:

Transmission power vs. Bit rate



**Centurion  
UNIVERSITY**

*Shaping Lives...  
Empowering Communities...*

# Binary Signaling Techniques

Figure 7-13  
Waveforms for ASK, PSK, and  
FSK modulation.

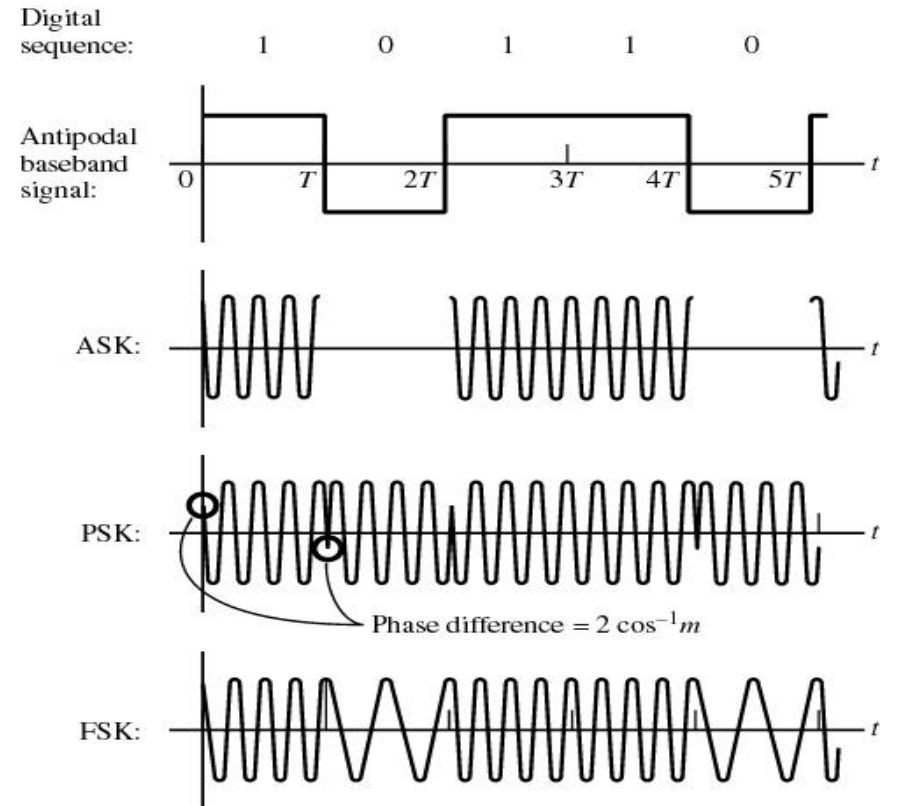

*Principles of Communications, 5/E* by Rodger Ziemer and William Tranter  
Copyright © 2002 John Wiley & Sons, Inc. All rights reserved.



# ASK, PSK, and FSK

## ● Amplitude Shift Keying (ASK)

$$s(t) = m(t)A_c \cos(2\pi f_c t) = \begin{cases} A_c \cos(2\pi f_c t) & m(nT_b) = 1 \\ 0 & m(nT_b) = 0 \end{cases}$$

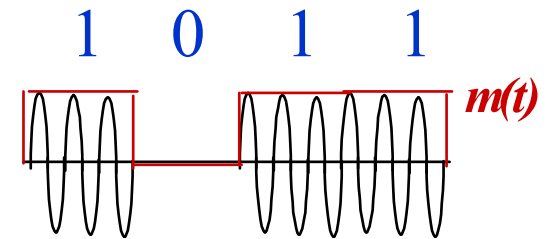

AM Modulation

## ● Phase Shift Keying (PSK)

$$s(t) = A_c m(t) \cos(2\pi f_c t) = \begin{cases} A_c \cos(2\pi f_c t) & m(nT_b) = 1 \\ A_c \cos(2\pi f_c t + \pi) & m(nT_b) = -1 \end{cases}$$

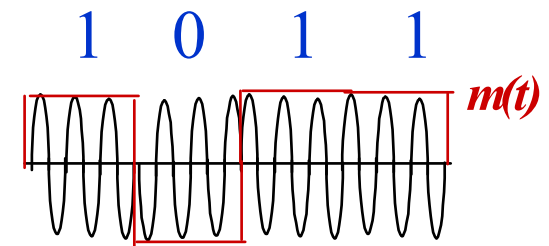

PM Modulation

## ● Frequency Shift Keying

$$s(t) = \begin{cases} A_c \cos(2\pi f_1 t) & m(nT_b) = 1 \\ A_c \cos(2\pi f_2 t) & m(nT_b) = -1 \end{cases}$$

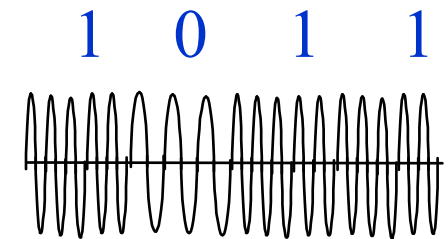

FSK Modulation



Centurion  
UNIVERSITY

Shaping Lives...  
Empowering Communities...

# Amplitude Shift Keying (ASK)

$0 \rightarrow 0$

$1 \rightarrow A \cos(\omega_c t)$

What is the structure of the optimum receiver?



Centurion  
UNIVERSITY

Shaping Lives...  
Empowering Communities...

# Receiver for binary signals in noise

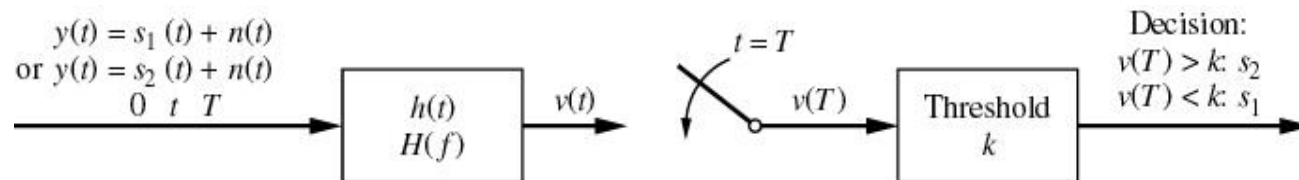

Figure 7-6 A possible receiver structure for detecting binary signals in white Gaussian noise.



Centurion  
UNIVERSITY

Shaping Lives...  
Empowering Communities...

# Error Analysis

$0 \rightarrow s_1(t)$ ,  $1 \rightarrow s_2(t)$  in general.

The received signal:

$$y(t) = s_1(t) + n(t), t_0 \leq t \leq t_0 + T$$

OR

$$y(t) = s_2(t) + n(t), t_0 \leq t \leq t_0 + T$$

Noise is white and Gaussian.

Find  $P_E$

In how many different ways can an error occur?



Centurion  
UNIVERSITY

Shaping Lives...  
Empowering Communities...

# Error Analysis (general case)

## Two ways for error:

Receive 1 → Send 0

Receive 0 → Send 1

## Decision:

The received signal is filtered. (How does this compare to baseband transmission?)

Filter output is sampled every T seconds

Threshold k

Error occurs when:

$$v(T) = s_{01}(T) + n_0(T) > k$$

OR

$$v(T) = s_{02}(T) + n_0(T) < k$$



Centurion  
UNIVERSITY

Shaping Lives...  
Empowering Communities...

$s_{01}, s_{02}, n_0$  are filtered signal and noise terms.

Noise term:  $n_0(t)$  is the filtered white Gaussian noise.

Therefore, it's Gaussian (why?)

Has PSD:  $S_{n_0}(f) = \frac{N_0}{2} |H(f)|^2$

Mean zero, variance?

Recall: Variance is equal to average power of the noise process

$$\sigma^2 = \int_{-\infty}^{\infty} \frac{N_0}{2} |H(f)|^2 df$$



The pdf of noise term is:

$$f_N(n) = \frac{e^{-n^2/2\sigma^2_0}}{\sqrt{2\pi\sigma^2}}$$

Note that we still don't know what the filter is.

Will any filter work? Or is there an optimal one?

Recall that in baseband case (no modulation), we had the integrator which is equivalent to filtering with

$$H(f) = \frac{1}{j2\pi f}$$



Centurion  
UNIVERSITY

Shaping Lives...  
Empowering Communities...

The input to the thresholder is:

$$V = v(T) = s_{01}(T) + N$$

OR

$$V = v(T) = s_{02}(T) + N$$

These are also Gaussian random variables; why?

Mean:  $s_{01}(T)$  OR  $s_{02}(T)$

Variance: Same as the variance of N



Centurion  
UNIVERSITY

Shaping Lives...  
Empowering Communities...

# Distribution of $V$

The distribution of  $V$ , the input to the threshold device is:

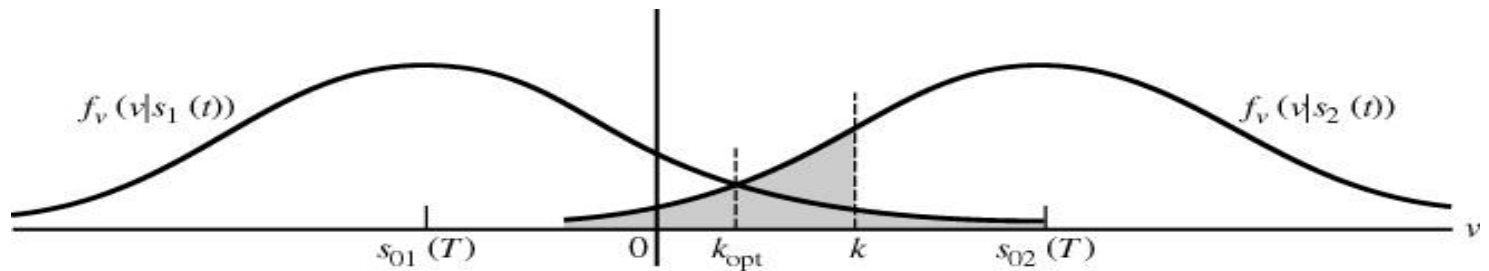

Figure 7-7 Conditional probability density functions of the filter output at time  $t = T$ .



Centurion  
UNIVERSITY

Shaping Lives...  
Empowering Communities...

# Probability of Error

Two types of errors:

$$P(E | s_1(t)) = \int_k^{\infty} \frac{e^{-[v-s_{01}(T)]^2/2\sigma^2}}{\sqrt{2\pi\sigma^2}} dv = Q\left(\frac{k-s_{01}(T)}{\sigma}\right)$$

$$P(E | s_2(t)) = \int_{-\infty}^k \frac{e^{-[v-s_{02}(T)]^2/2\sigma^2}}{\sqrt{2\pi\sigma^2}} dv = 1 - Q\left(\frac{k-s_{02}(T)}{\sigma}\right)$$

The average probability of error:

$$P_E = \frac{1}{2} P[E | s_1(t)] + \frac{1}{2} P[E | s_2(t)]$$



Centurion  
UNIVERSITY

Shaping Lives...  
Empowering Communities...

Goal: Minimize the average probability of error

Choose the optimal threshold

What should the optimal threshold,  $k_{\text{opt}}$  be?

$$K_{\text{opt}} = 0.5[s_{01}(T) + s_{02}(T)]$$

$$P_E = Q\left(\frac{s_{02}(T) - s_{01}(T)}{2\sigma}\right)$$



Centurion  
UNIVERSITY

Shaping Lives...  
Empowering Communities...

# Observations

$P_E$  is a function of the difference between the two signals.

Recall: Q-function decreases with increasing argument. (Why?)

Therefore,  $P_E$  will decrease with increasing distance between the two output signals

Should choose the filter  $h(t)$  such that  $P_E$  is a minimum  $\rightarrow$  maximize the difference between the two signals at the output of the filter



Centurion  
UNIVERSITY

Shaping Lives...  
Empowering Communities...

# Matched Filter

Goal: Given  $s_1(t), s_2(t)$ , choose  $H(f)$  such that  $d = \frac{s_{02}(T) - s_{01}(T)}{\sigma}$  is maximized.

The solution to this problem is known as the matched filter and is given by:

$$h_0(t) = s_2(T-t) - s_1(T-t)$$

Therefore, the optimum filter depends on the input signals.



Centurion  
UNIVERSITY

Shaping Lives...  
Empowering Communities...

# Matched filter receiver

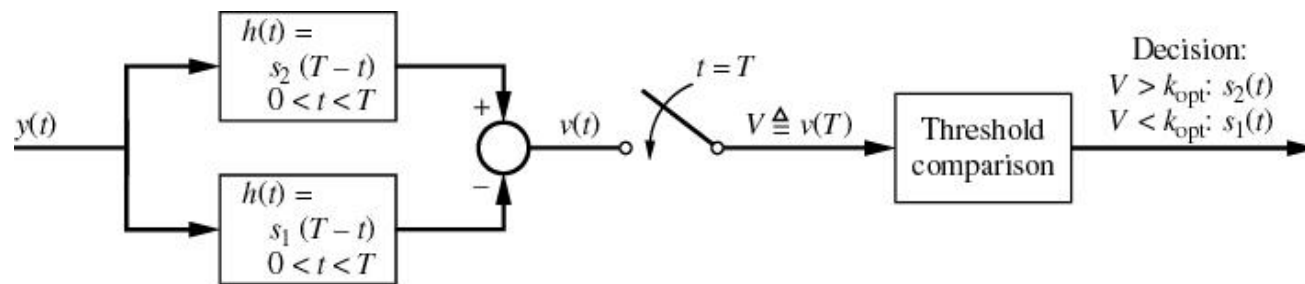

Figure 7-9 Matched filter receiver for binary signaling in white Gaussian noise.



Centurion  
UNIVERSITY

Shaping Lives...  
Empowering Communities...

# Error Probability for Matched Filter Receiver

Recall 
$$P_E = Q\left(\frac{d}{2}\right)$$

The maximum value of the distance,

$$d_{\max}^2 = \frac{2}{N_0} (E_1 + E_2 - 2\sqrt{E_1 E_2} \rho_{12})$$

$E_1$  is the energy of the first signal.

$E_2$  is the energy of the second signal.

$$E_1 = \int_{t_0}^{t_0 + T} s_1^2(t) dt$$

$$E_2 = \int_{t_0}^{t_0 + T} s_2^2(t) dt$$

$$\rho_{12} = \frac{1}{\sqrt{E_1 E_2}} \int_{-\infty}^{\infty} s_1(t) s_2(t) dt$$



**Centurion**  
**UNIVERSITY**

*Shaping Lives...  
Empowering Communities...*

Therefore,

$$P_E = Q \left[ \left( \frac{E_1 + E_2 - 2\sqrt{E_1 E_2} \rho_{12}}{2N_0} \right)^{1/2} \right]$$

- Probability of error depends on the signal energies (just as in baseband case), noise power, and the similarity between the signals.
- If we make the transmitted signals as dissimilar as possible, then the probability of error will decrease (  $\rho_{12} = -1$  )



Centurion  
UNIVERSITY

Shaping Lives...  
Empowering Communities...

# ASK

$$s_1(t) = 0, s_2(t) = A \cos(2\pi f_c t)$$

- The matched filter:  $A \cos(2\pi f_c t)$
- Optimum Threshold  $\frac{1}{4} A^2 T$
- Similarity between signals?
- Therefore  $P_E = Q\left(\sqrt{\frac{A^2 T}{4 N_0}}\right) = Q(\sqrt{z})$
- 3dB worse than baseband.



Centurion  
UNIVERSITY

Shaping Lives...  
Empowering Communities...

# PSK

$$s_1(t) = A \sin(2\pi f_c t + \cos^{-1} m), s_2(t) = A \sin(2\pi f_c t - \cos^{-1} m)$$

Modulation index:  $m$  (determines the phase jump)

Matched Filter:  $-2A\sqrt{1-m^2} \cos(2\pi f_c t)$

Threshold: 0

Therefore,  $P_E = Q(\sqrt{2(1-m^2)}z)$

For  $m=0$ , 3dB better than ASK.



Centurion  
UNIVERSITY

Shaping Lives...  
Empowering Communities...

# Matched Filter for PSK

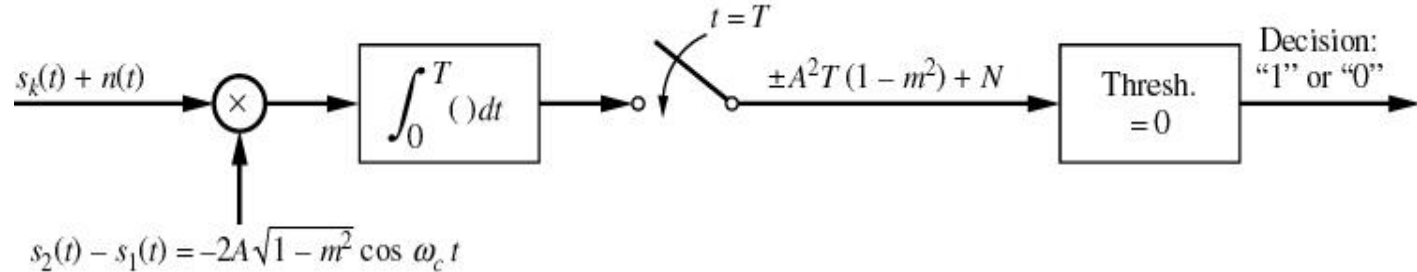

Figure 7-14 Correlator realization of optimum receiver for PSK.



Centurion  
UNIVERSITY

Shaping Lives...  
Empowering Communities...

# FSK

$$s_1(t) = A \cos(2\pi f_c t), s_2(t) = A \cos(2\pi(f_c + \Delta f)t)$$

$$\Delta f = \frac{m}{T}$$

Probability of Error:  $Q(\sqrt{z})$

Same as ASK



**Centurion**  
**UNIVERSITY**

*Shaping Lives...  
Empowering Communities...*

# Applications

Modems: FSK

RF based security and access control systems

Cellular phones



**Centurion**  
**UNIVERSITY**

*Shaping Lives...  
Empowering Communities...*

# **INTER SYMBOL INTERFERENCE (ISI)**

**Harish Chandra Mohanta, CUTM, Bhubaneswar Campus**



Centurion  
UNIVERSITY

Shaping Lives...  
Empowering Communities...

# INTERSYMBOL INTERFERENCE (ISI)

- Intersymbol Interference
- ISI on Eye Patterns
- Combatting ISI
- Nyquist's First Method for zero ISI
- Raised Cosine-Rolloff Pulse Shape
- Nyquist Filter



Centurion  
UNIVERSITY

Shaping Lives...  
Empowering Communities...

# Inter-symbol Interference

**Inter symbol interference (ISI)** occurs when a pulse spreads out in such a way that it interferes with adjacent pulses *at the sample instant*.

Example: assume polar NRZ line code. The channel outputs are shown as spreaded (width  $T_b$  becomes  $2T_b$ ) pulses shown (Spreading due to band limited channel characteristics).

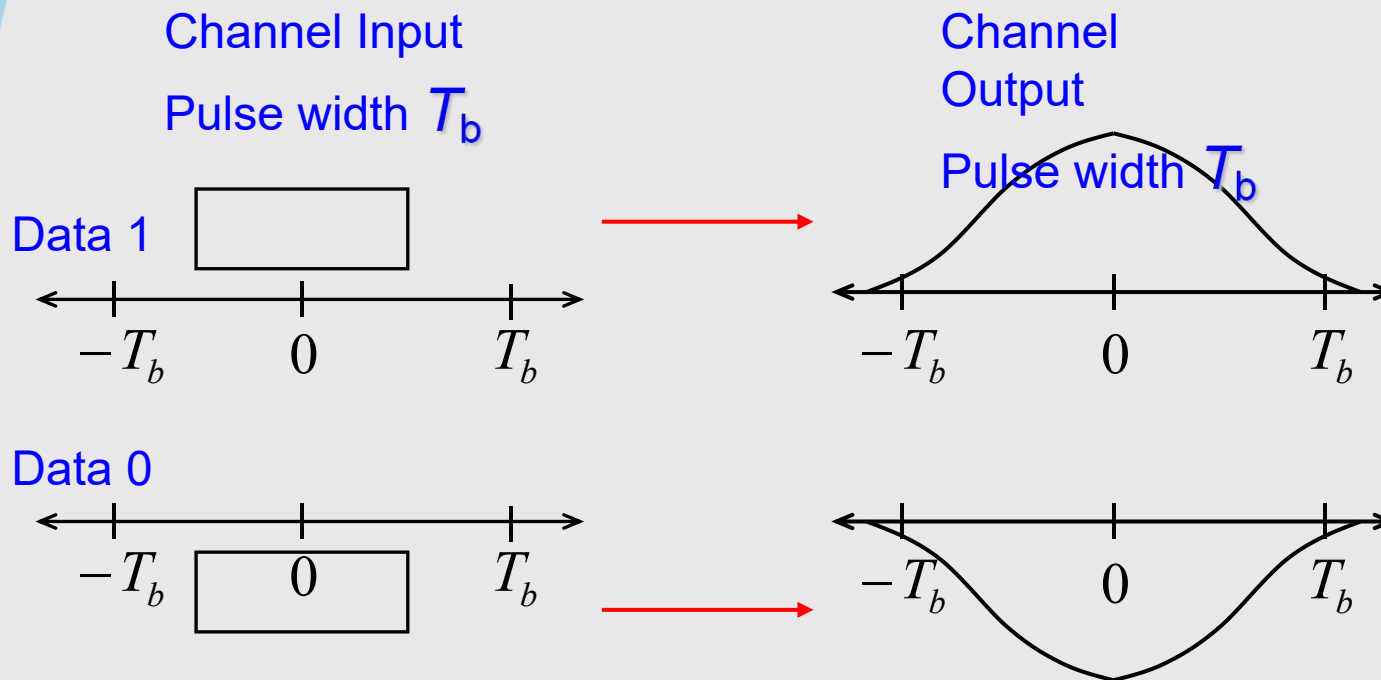



Centurion  
UNIVERSITY

Shaping Lives...  
Empowering Communities...

# Intersymbol Interference

For the input data stream:

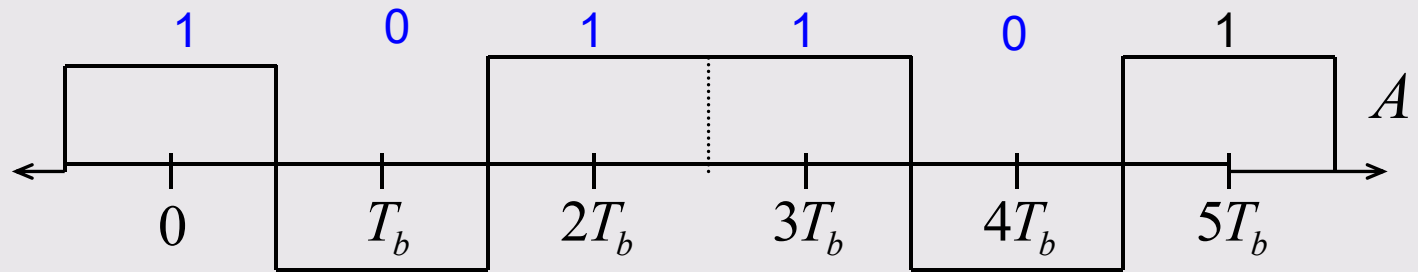

The channel output is the superposition of each bit's output:

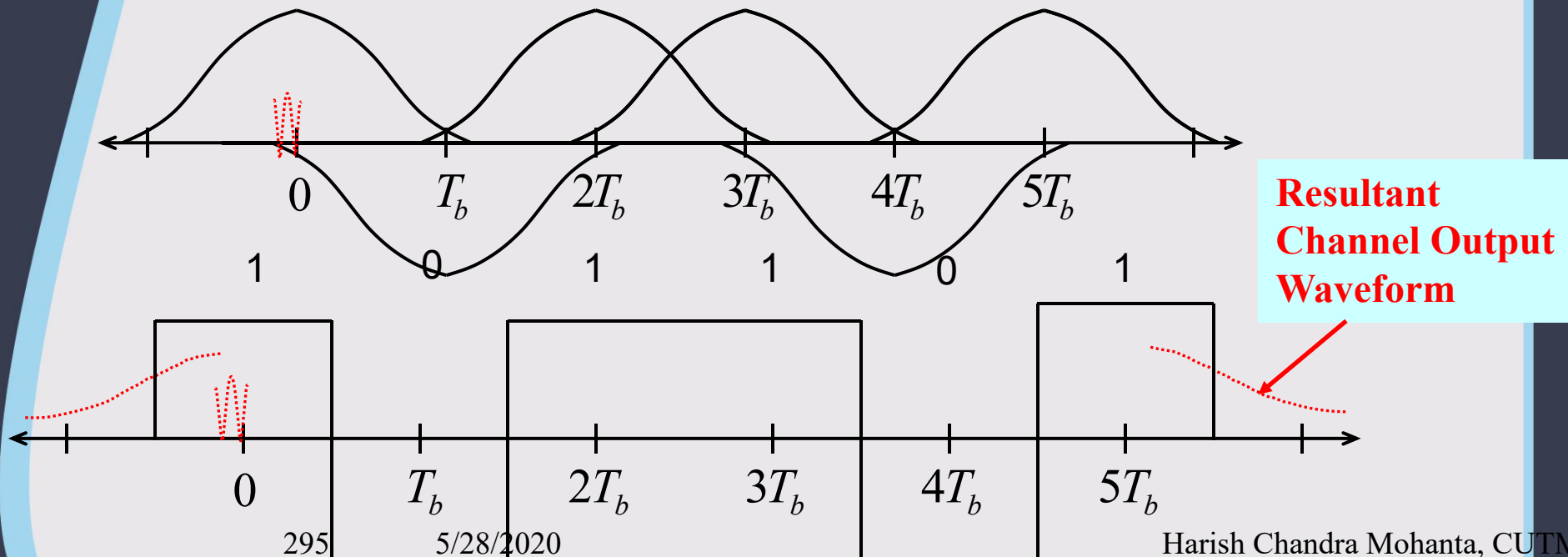



Centurion  
UNIVERSITY

Shaping Lives...  
Empowering Communities...

# ISI on Eye Patterns

The amount of ISI can be seen on an oscilloscope using an **Eye Diagram** or **Eye pattern**.

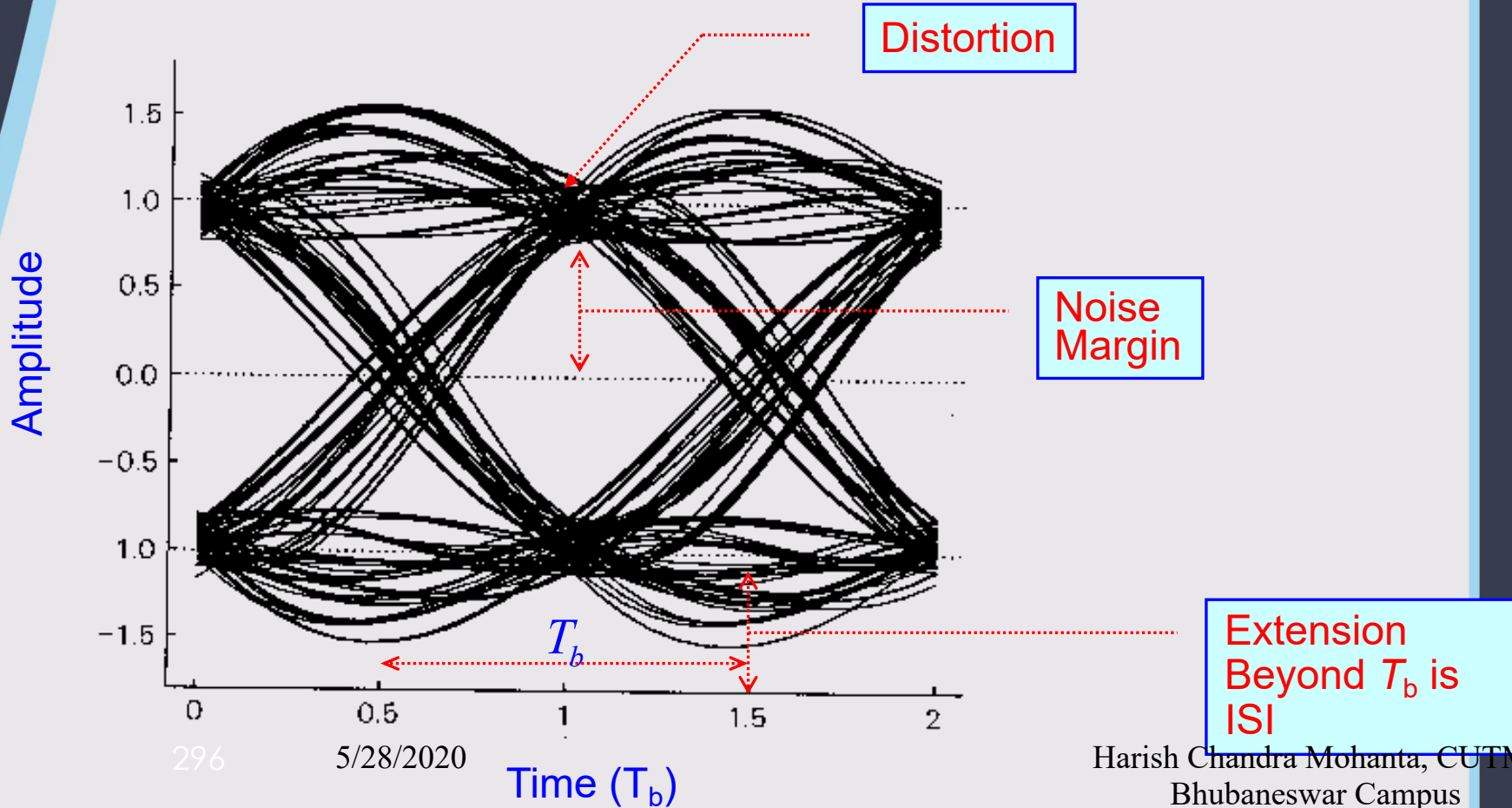



Centurion  
UNIVERSITY

Shaping Lives...  
Empowering Communities...

# Intersymbol Interference

- If the rectangular multilevel pulses are filtered improperly as they pass through a communications system, they will spread in time, and the pulse for each symbol may be smeared into adjacent time slots and cause *Intersymbol Interference*.

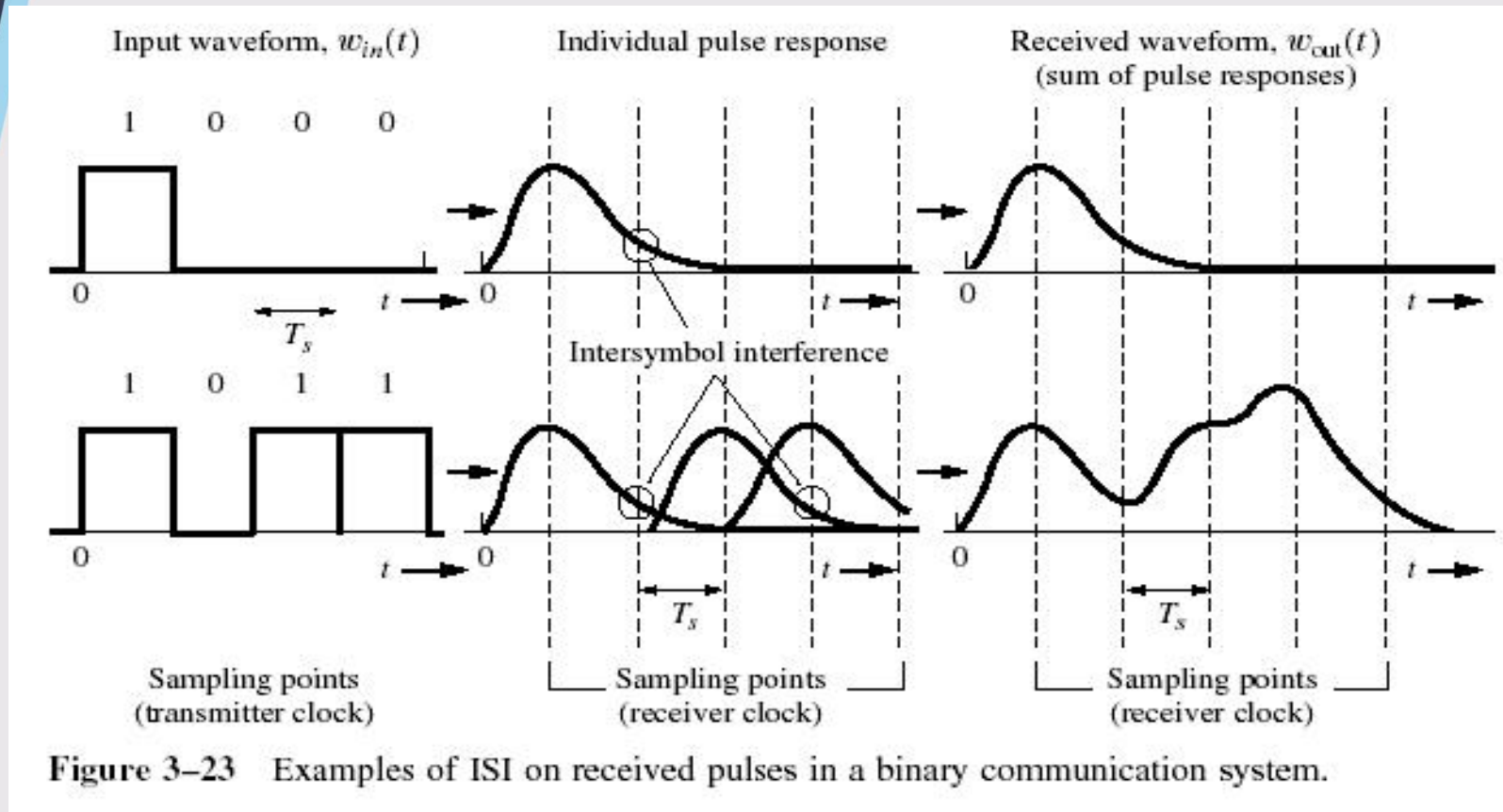

➤ How can we restrict BW and at the same time not introduce ISI? 3 Techniques



# Intersymbol Interference

- Flat-topped multilevel input signal having pulse shape  $h(t)$  and values  $a_k$ :

$$w_{in}(t) = \sum_n a_n h(t - nT_s) = \sum_n a_n h(t) * \delta(t - nT_s) = \left[ \sum_n a_n \delta(t - nT_s) \right] * h(t)$$

Where  $h(t) = \text{rect}\left(\frac{t}{T_s}\right)$  Where  $D = \frac{1}{T_s}$  pulses/s

$$w_{out}(t) = \left[ \sum_n a_n \delta(t - nT_s) \right] * h_e(t) = \sum_n a_n h_e(t - nT_s)$$

Equivalent impulse response:  $h_e(t) = h(t) * h_T(t) * h_C(t) * h_R(t)$

- $h_e(t)$  is the pulse shape that will appear at the output of the receiver filter.

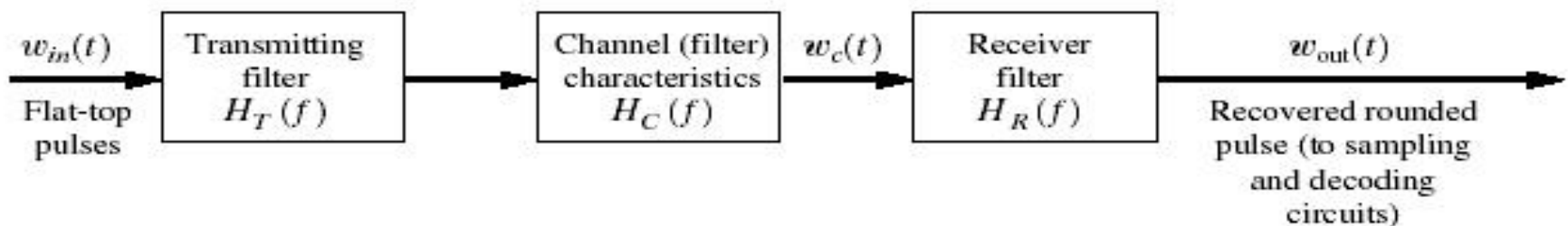

Figure 3-24 Baseband pulse-transmission system.



Centurion  
UNIVERSITY

Shaping Lives...  
Empowering Communities...

# Intersymbol Interference

- Equivalent Impulse Response

$h_e(t)$  :

$$h_e(t) = h(t) * h_T(t) * h_C(t) * h_R(t)$$

- Equivalent transfer function:

$$H_e(f) = H(f)H_T(f)H_C(f)H_R(f) \quad \text{Where} \quad H(f) = F \left[ \prod \left( \frac{t}{T_s} \right) \right] = T_s \left( \frac{\sin \pi T_s f}{\pi T_s f} \right)$$

- Receiving filter can be designed to produce a needed  $H_e(f)$  in terms of  $H_T(f)$  and  $H_C(f)$ :

$$H_R(f) = \frac{H_e(f)}{H(f)H_T(f)H_C(f)}$$

- Output signal can be rewritten as:

$$w_{out}(t) = \sum_n a_n h_e(t - nT_s)$$

- $H_e(f)$ , chosen such to minimize ISI is called **EQUALIZING FILTER**)



**Centurion**  
**UNIVERSITY**

*Shaping Lives...  
Empowering Communities...*

# Combating ISI

- ▶ Three strategies for eliminating ISI:
  - ▶ Use a line code that is absolutely band limited.
    - ▶ Would require Sinc pulse shape.
    - ▶ Can't actually do this (but can approximate).
  - ▶ Use a line code that is zero during adjacent sample instants.
    - ▶ It's okay for pulses to overlap somewhat, as long as there is no overlap at the sample instants.
    - ▶ Can come up with pulse shapes that don't overlap during adjacent sample instants.
      - Raised-Cosine Roll-off pulse shaping
  - ▶ Use a filter at the receiver to “undo” the distortion introduced by the channel.
    - ▶ Equalizer.



**Centurion**  
**UNIVERSITY**

Shaping Lives...  
Empowering Communities...

# Nyquist's First Method for Zero ISI

➤ ISI can be eliminated by using an equivalent transfer function,  $H_e(f)$ , such that the impulse response satisfies the condition:

$$h_e(kT_s + \tau) = \begin{cases} C, & k = 0 \\ 0, & k \neq 0 \end{cases}$$

$k$  is an integer,  $T_s$  is the symbol (sample) period

$\tau$  is the offset in the receiver sampling clock times

$C$  is a nonzero constant

Now choose the  $\frac{\sin x}{x}$  function for  $h_e(t)$

$$w_{out}(t) = \sum_n a_n h_e(t - nT_s)$$

$h_e$  is a Sa function

$$h_e(t) = \frac{\sin \pi f_s t}{\pi f_s t}$$

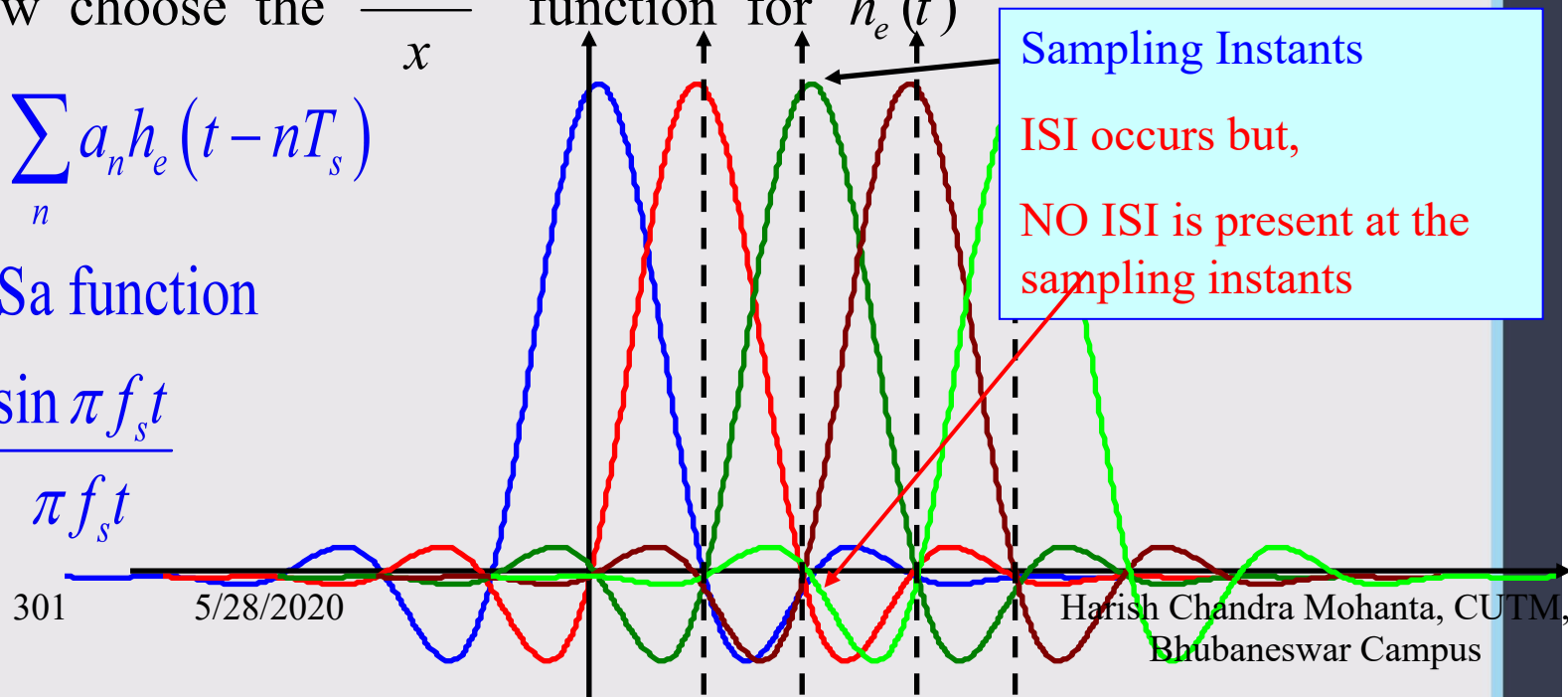

Sampling Instants  
ISI occurs but,  
NO ISI is present at the  
sampling instants



# Nyquist's First Method for Zero ISI

- There will be **NO ISI and the bandwidth requirement will be minimum (Optimum Filtering)** if the transmit and receive filters are designed so that the overall transfer function  $H_e(f)$  is:

$$H_e(f) = \frac{1}{f_s} \prod \left( \frac{f}{f_s} \right) \quad h_e(t) = \frac{\sin \pi f_s t}{\pi f_s t} \quad \text{Where } f_s = \frac{1}{T_s}$$

- This type of pulse will allow signalling at a baud rate of  $D=1/T_s=2B$  (for Binary  $R=1/T_s=2B$ ) where  $B$  is the absolute bandwidth of the system.

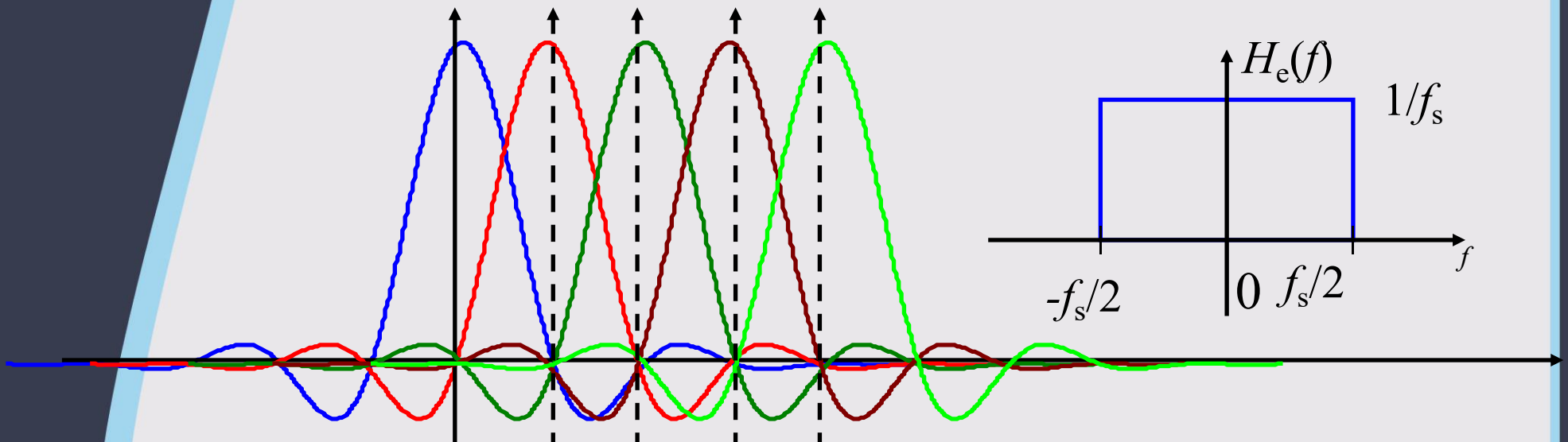

Absolute bandwidth is:  $B = \frac{f_s}{2}$  **MINIMUM BANDWIDTH**

Signalling Rate is  $D=1/T_s = 2B$  Pulses/sec



# Nyquist's First Method for Zero ISI

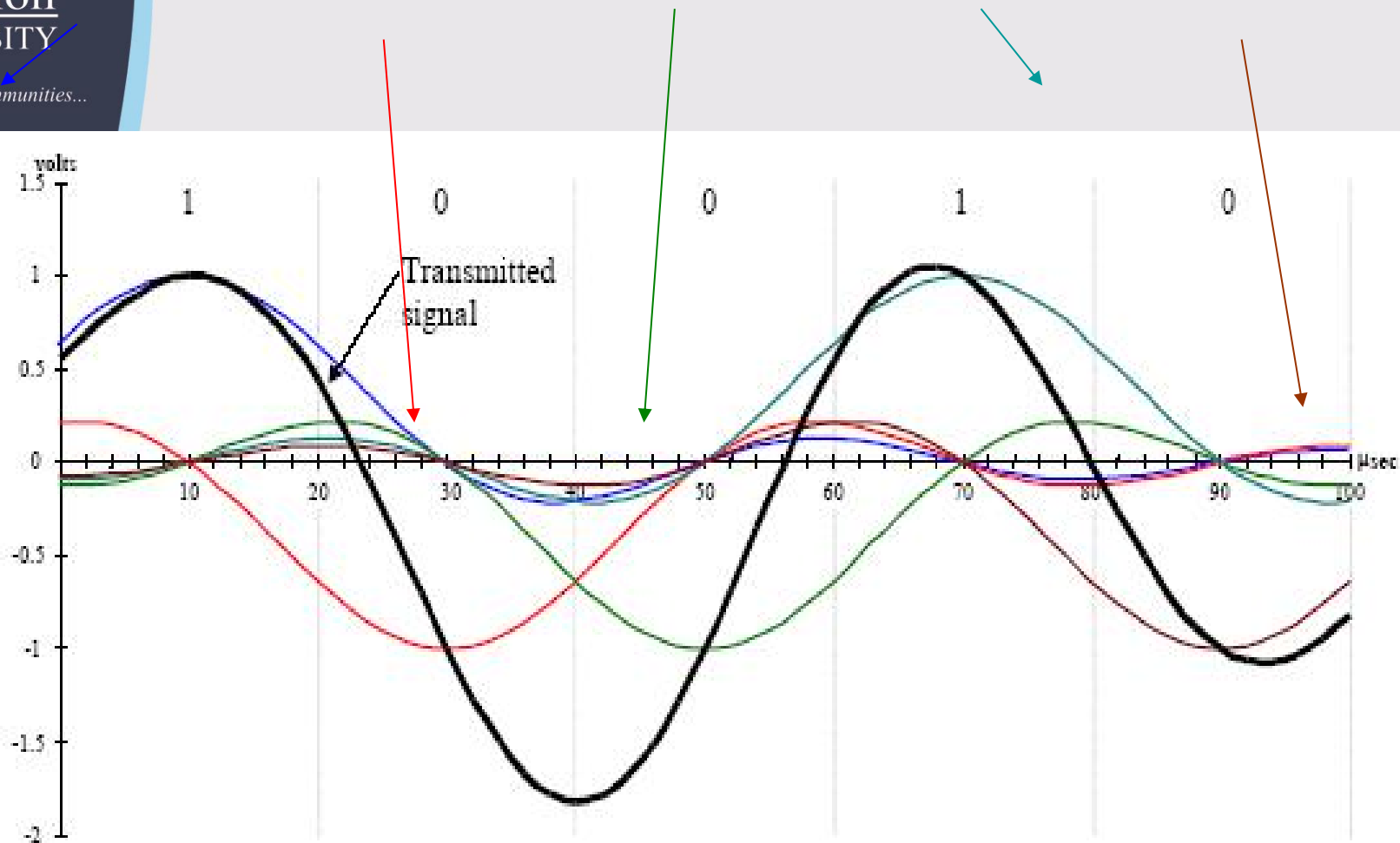

Figure 3.28 Transmitted binary PAM waveform for the data sequence “10010” using sinc-shaped pulses (raised cosine pulse shaping,  $\alpha = 0$ ) at a transmission speed of 50,000 bits/sec. Note that this is the same plot as Figure 3.20a.



Centurion  
UNIVERSITY

Shaping Lives...  
Empowering Communities...

# Nyquist's First Method for Zero ISI

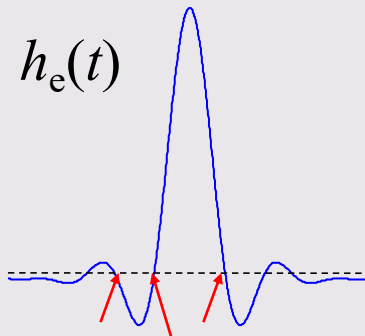

Zero crossings at non-zero integer multiples of the bit period

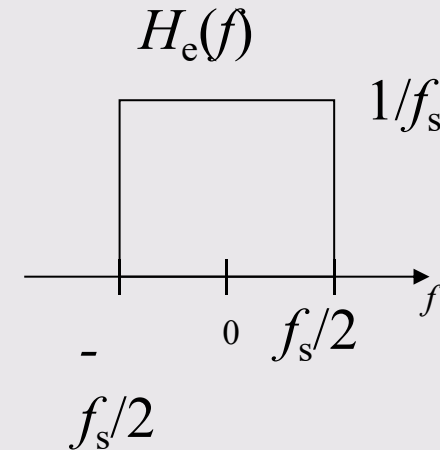

- ▶ Since pulses are not possible to create due to:
  - ▶ Infinite time duration.
  - ▶ Sharp transition band in the frequency domain.
- ▶ The Sinc pulse shape can cause significant ISI in the presence of timing errors.
  - ▶ If the received signal is not sampled at *exactly* the bit instant (Synchronization Errors), then ISI will occur.
- ▶ We seek a pulse shape that:
  - ▶ Has a more gradual transition in the frequency domain.
  - ▶ Is more robust to timing errors.
  - ▶ Yet still satisfies Nyquist's first method for zero ISI.



Centurion  
UNIVERSITY

Shaping Lives...  
Empowering Communities...

# Raised Cosine-Rolloff Nyquist Filtering

- Because of the difficulties caused by the Sa type pulse shape, consider other pulse shapes **which require more bandwidth** such as the Raised Cosine-rolloff Nyquist filter but **they are less affected by synchrononization errors.**
- The Raised Cosine Nyquist filter is defined by its rolloff factor number  $r=f_{\Delta}/f_0$ .

$$H_e(f) = \begin{cases} 1, & |f| < f_1 \\ \frac{1}{2} \left\{ 1 + \cos \left[ \frac{\pi (|f| - f_1)}{2f_{\Delta}} \right] \right\}, & f_1 < |f| < B \\ 0, & |f| > B \end{cases} \quad \text{B is the Absolute Bandwidth}$$

$f_{\Delta} = B - f_0$     $f_1 \equiv f_0 - f_{\Delta}$    Where  $f_0$  is the 6-dB bandwidth of the filter

Rolloff factor:  $r = \frac{f_{\Delta}}{f_0}$    Bandwidth:  $B = \frac{R_b}{2}(1+r)$

$$h_e(t) = F^{-1} [H_e(f)] = 2f_0 \left( \frac{\sin 2\pi f_0 t}{2\pi f_0 t} \right) \left[ \frac{\cos 2\pi f_{\Delta} t}{1 - (4f_{\Delta} t)^2} \right]$$

305   5/28/2020

Rolloff factor:  $r = \frac{f_{\Delta}}{f_0}$    Bandwidth:  $B = \frac{R_b}{2}(1+r)$



**Centurion**  
**UNIVERSITY**

Shaping Lives...  
Empowering Communities...

# Raised Cosine-Rolloff Nyquist Filtering

- Now filtering requirements are relaxed because absolute bandwidth is increased.
- Clock timing requirements are also relaxed.
- The  $r=0$  case corresponds to the previous Minimum bandwidth case.

$$H_e(f) = \frac{1}{2} \left\{ 1 + \cos \left[ \frac{\pi (|f| - f_1)}{2f_\Delta} \right] \right\}$$

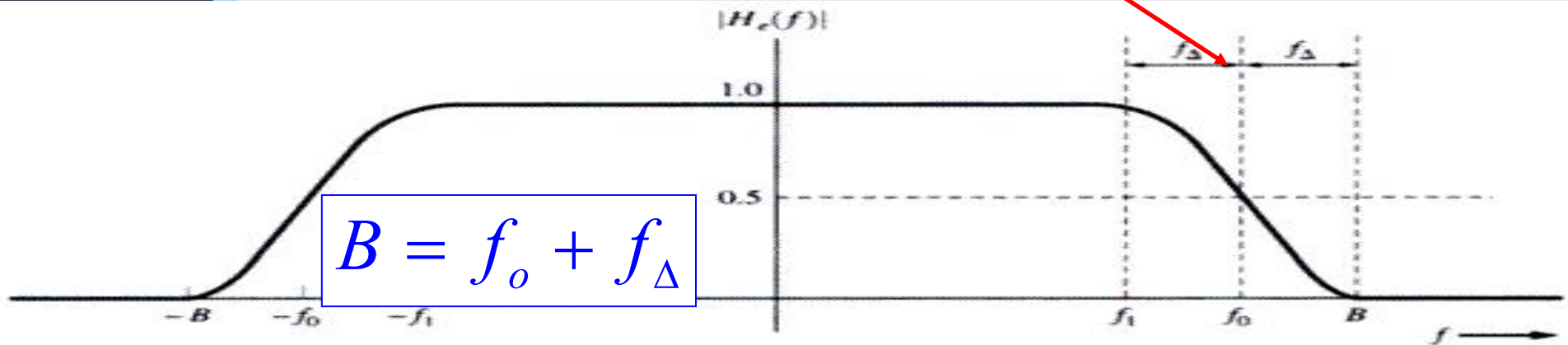

Figure 3-25 Raised cosine-rolloff Nyquist filter characteristics.

Rolloff factor:  $r = \frac{f_\Delta}{f_0}$       Bandwidth:  $B = \frac{R}{2}(1+r) = \frac{D}{2}(1+r)$



Centurion  
UNIVERSITY

Shaping Lives...  
Empowering Communities...

# Raised Cosine-Rolloff Nyquist Filtering

- Impulse response is given by:

$$h_e(t) = F^{-1} [H_e(f)] = 2f_0 \left( \frac{\sin 2\pi f_0 t}{2\pi f_0 t} \right) \left[ \frac{\cos 2\pi f_{\Delta} t}{1 - (4f_{\Delta} t)^2} \right]$$

- The tails of  $h_e(t)$  are now decreasing much faster than the Sa function (As a function of  $t^2$ ).
- ISI due to synchronization errors will be much lower.

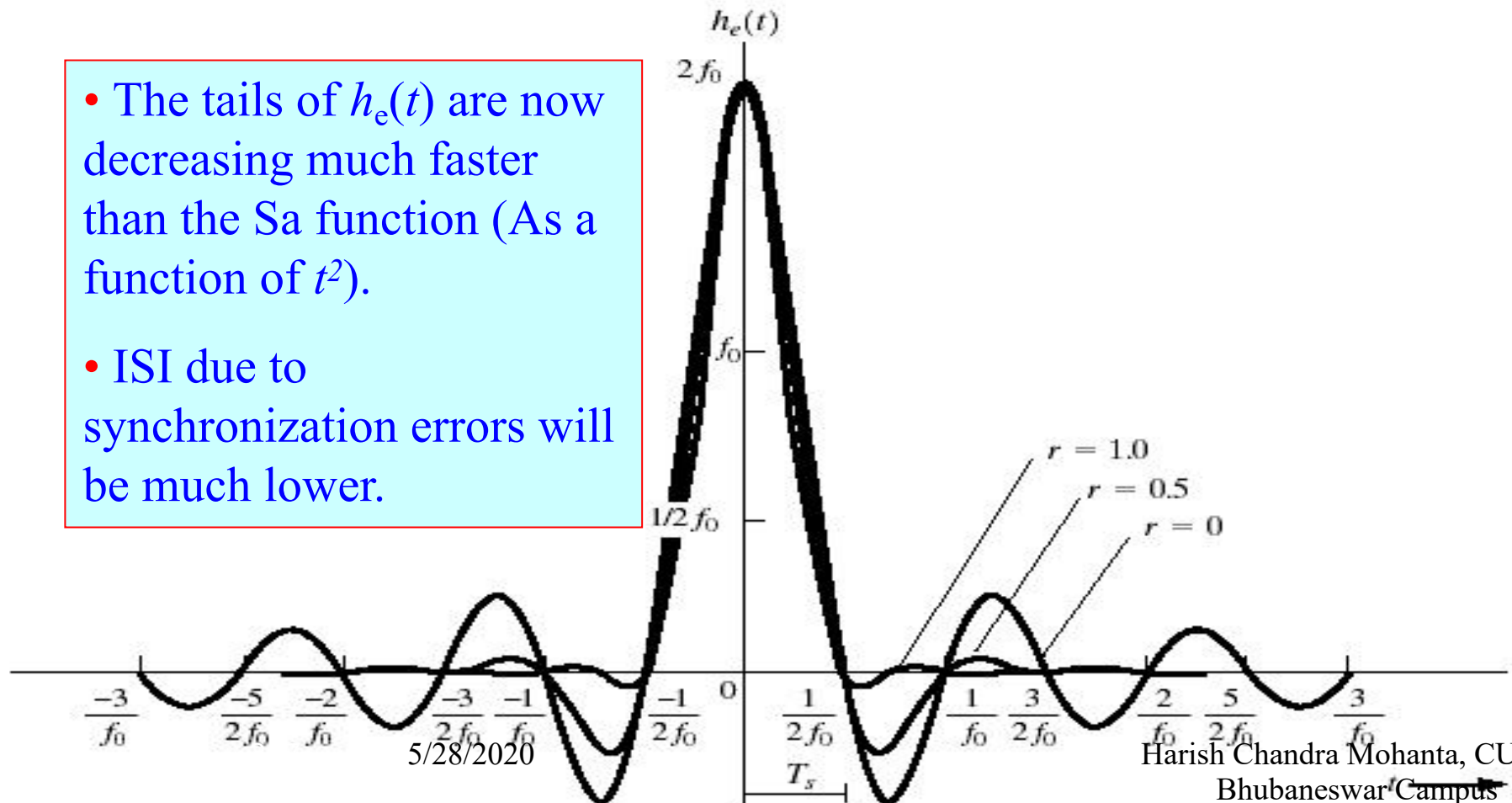

5/28/2020



**Centurion**  
**UNIVERSITY**

Shaping Lives...  
Empowering Communities...

# Raised Cosine-Rolloff Nyquist Filtering

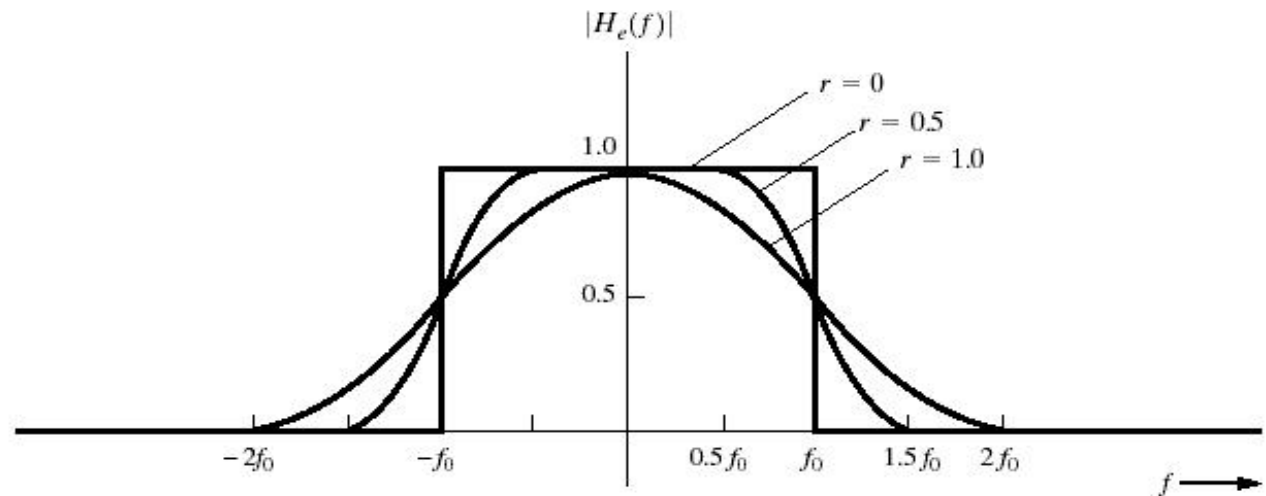

(a) Magnitude Frequency Response

**Frequency response and impulse responses of Raised Cosine pulses for various values of the roll off parameter.**

$$r \uparrow \rightarrow B \uparrow$$

$$r \uparrow \rightarrow ISI \downarrow$$

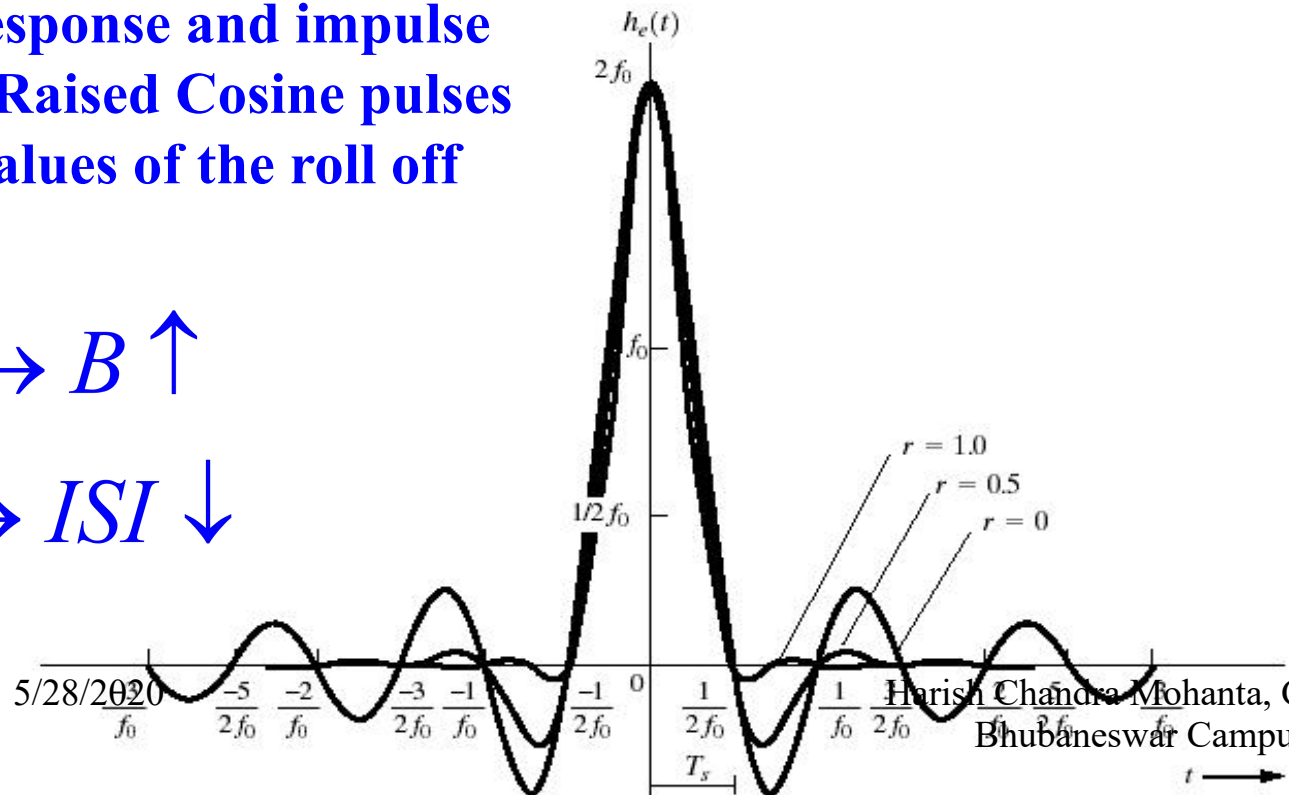



Centurion  
UNIVERSITY

Shaping Lives...  
Empowering

# Raised Cosine-Rolloff Nyquist Filtering

- Illustrating the received bit stream of Raised Cosine pulse shaped transmission corresponding to the binary stream of 1 0 0 1 0 for 3 different values of  $r=0, 0.5, 1$ .

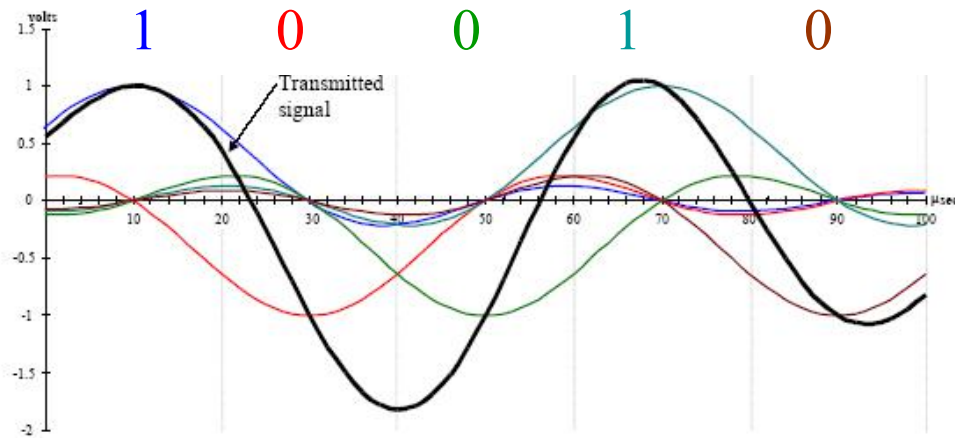

Figure 3.28 Transmitted binary PAM waveform for the data sequence "10010" using sinc-shaped pulses (raised cosine pulse shaping,  $\alpha = 0$ ) at a transmission speed of 50,000 bits/sec. Note that this is the same plot as Figure 3.20a.

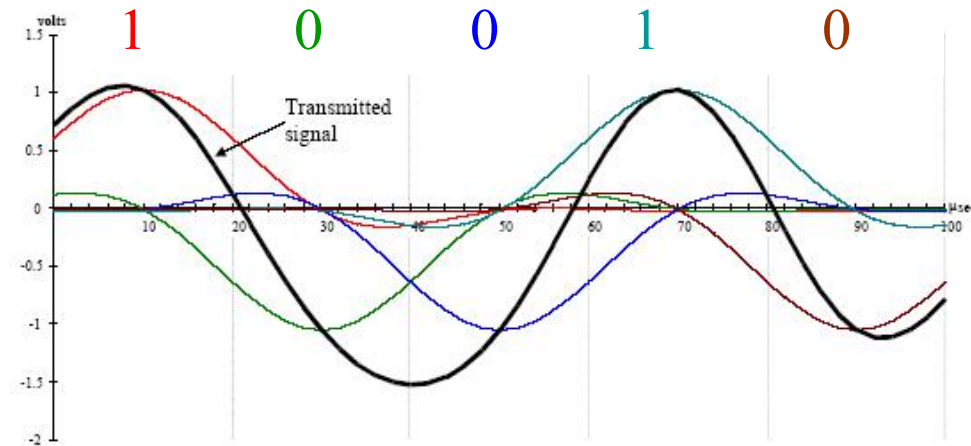
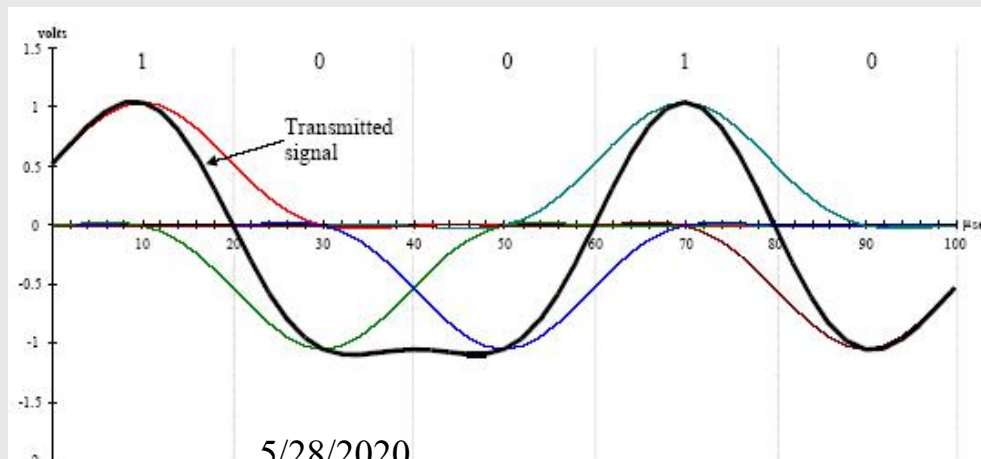

Figure 3.30 "10010" with raised cosine pulse shaping,  $\alpha = 0.5$



5/28/2020  
Figure 3.32 "10010" with raised cosine pulse shaping,  $\alpha = 1$



Centurion  
UNIVERSITY

Shaping Lives...  
Empowering Communities...

# Bandwidth for Raised Cosine Nyquist Filtering

- The bandwidth of a Raised-cosine (RC) rolloff pulse shape is a function of the bit rate and the rolloff factor:

$$B = f_o + f_{\Delta} = f_o \left( 1 + \frac{f_{\Delta}}{f_o} \right) = f_o (1 + r)$$

$$B = \frac{R}{2} (1 + r)$$

$$B = \frac{D}{2} (1 + r) \quad \text{Multilevel Signalling}$$

Or solving for bit rate yields the expression:

$$R = \frac{2B}{1 + r}$$

- This is the maximum transmitted bit rate when a RC-rolloff pulse shape with Rolloff factor  $r$  is transmitted over a baseband channel with bandwidth  $B$ .



# Nyquist Filter

- **Raised Cosine Filter is also called a NYQUIST FILTER.**
- **NYQUIST FILTERS refer to a general class of filters that satisfy the NYQUIST's First Criterion.**

- **Theorem:** A filter is said to be a **Nyquist filter** if the effective transfer function is :

$$H_e(f) = \begin{cases} \Pi\left(\frac{f}{2f_0}\right) + Y(f), & |f| < f_0 \\ 0, & f \text{ Elsewhere} \end{cases}$$

$Y(f)$  is a real function and even symmetric about  $f = 0$ :

$$Y(-f) = Y(f), \quad |f| < 2f_0$$

$Y$  is odd symmetric about  $f = f_0$ :

$$Y(-f + f_0) = -Y(f + f_0), \quad |f| < f_0$$

- There will be no intersymbol interference at the system output if the symbol rate is



**Centurion  
UNIVERSITY**

Shaping Lives...  
Empowering Communities...

# Nyquist Filter Characteristics

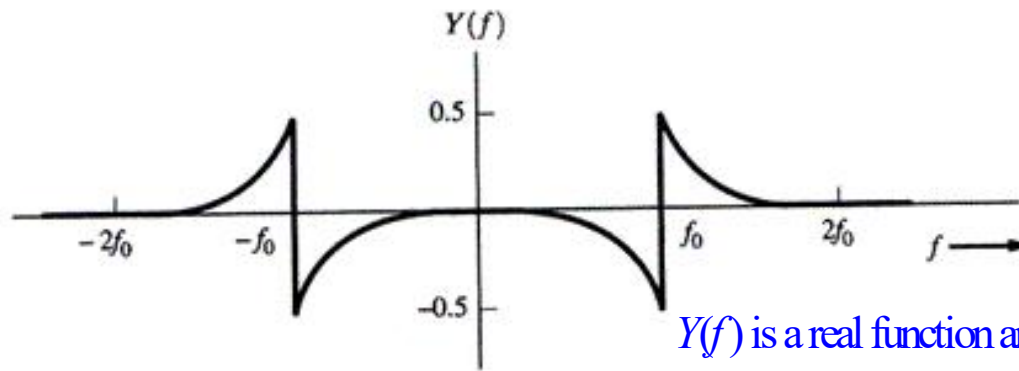

$Y(f)$  is a real function and even symmetric about  $f = 0$ :

$$Y(-f) = Y(f), \quad |f| < 2f_0$$

$Y$  is odd symmetric about  $f = f_0$ :

$$Y(-f + f_0) = -Y(f + f_0), \quad |f| < f_0$$

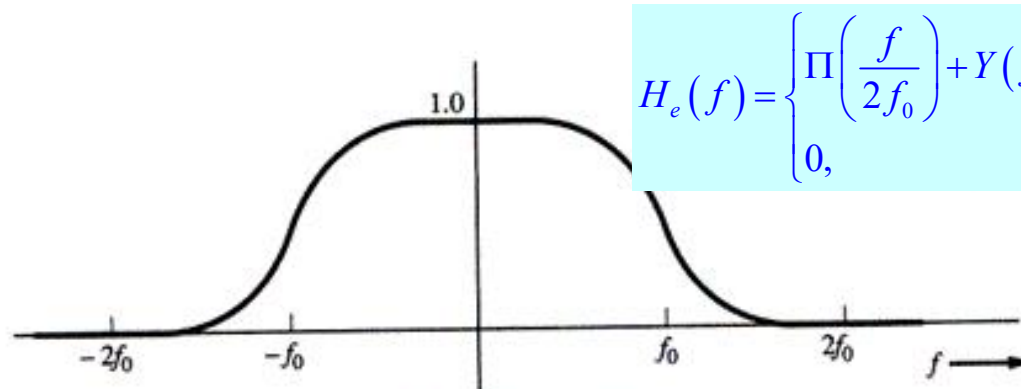
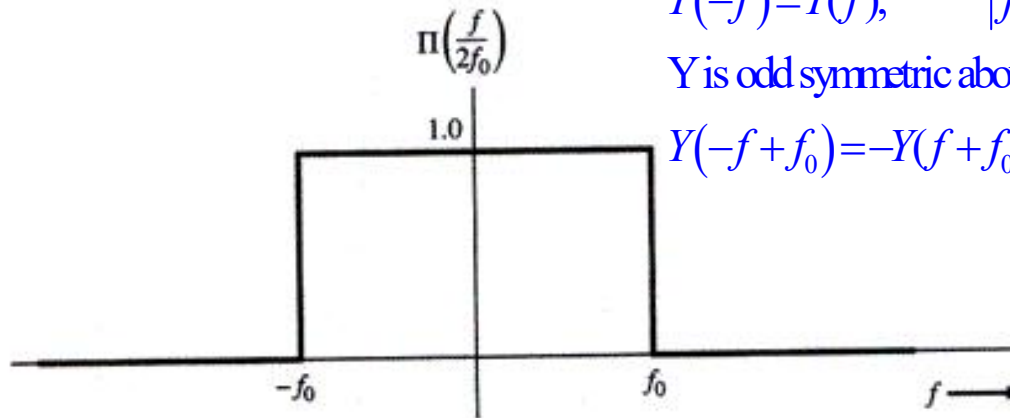

$$H_e(f) = \begin{cases} \Pi\left(\frac{f}{2f_0}\right) + Y(f), & |f| < f_0 \\ 0, & \text{Elsewhere} \end{cases}$$

5/28/2020 **Figure 3-27** Nyquist filter characteristic.



**Centurion**  
**UNIVERSITY**  
*Shaping Lives...*  
*Empowering Communities...*

# EYE DIADRAM



**Centurion**  
**UNIVERSITY**

*Shaping Lives...  
Empowering Communities...*

# INTRODUCTION

- Eye diagram is an operation tool for evaluating the effects of inter symbol interference (ISI) in an insightful manner.
- It carries lot of information about the quality of the incoming pulse and state of the channel which is useful for the detection of the digital input.
- The eye diagram is defined as the synchronized superposition of all possible realizations of the signal of interest (e.g. received signal, receiver output) viewed within a particular signalling interval.
- The eye pattern/diagram derives its name from the fact that it resembles the human eye for binary waves.



Centurion  
UNIVERSITY

# EYE Diagram Test setup

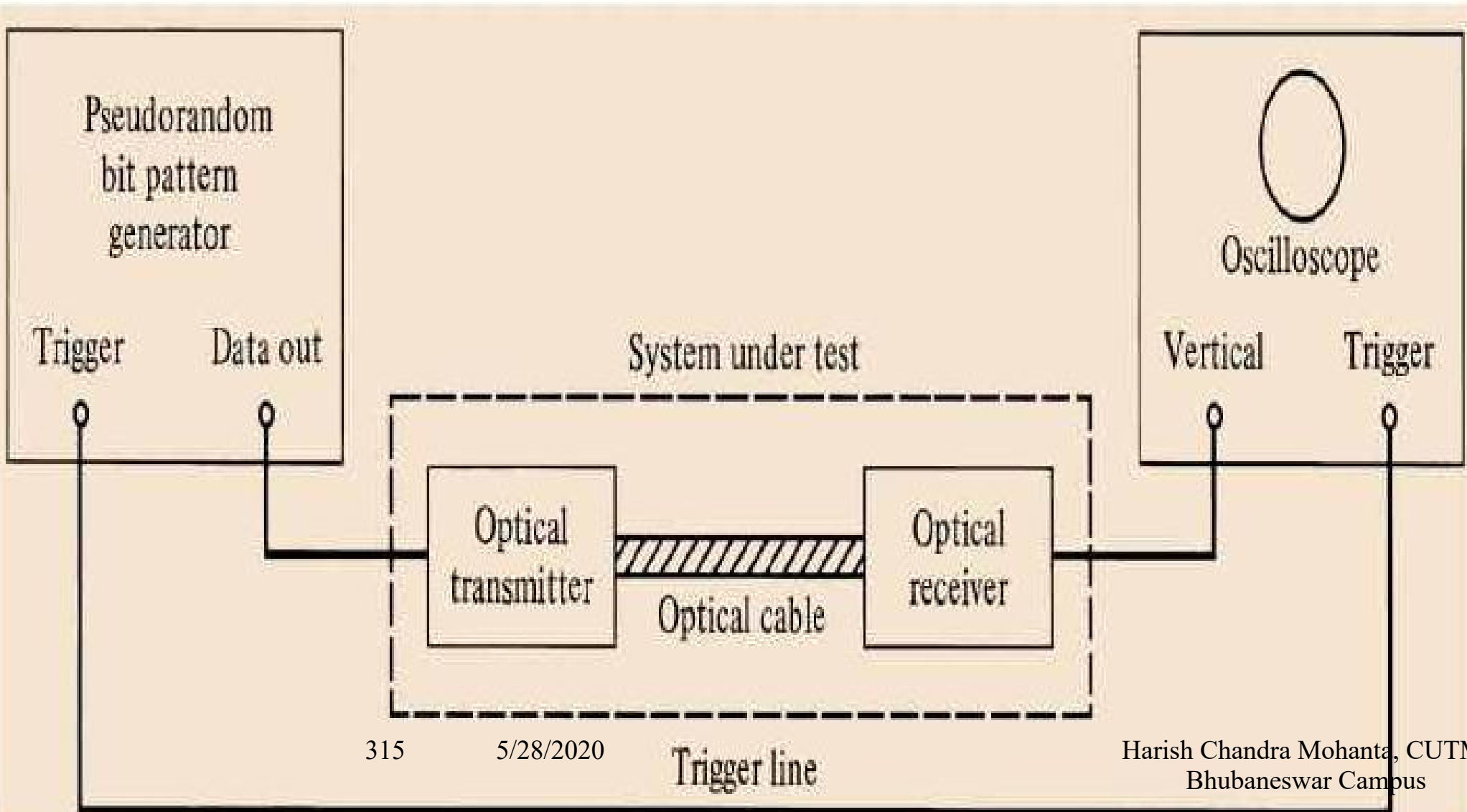



**Centurion**  
**UNIVERSITY**

*Shaping Lives...  
Empowering Communities...*

# EYE Pattern

An oscilloscope display that allows several system performances measurements. The "openness" of the eye relates to the BER that can be achieved.

The vertical eye opening indicates the noise level in the system: the more it is opened the less noise level. The horizontal eye opening is related to the amount of jitter in the signal: the wider the opening, the less jitter.

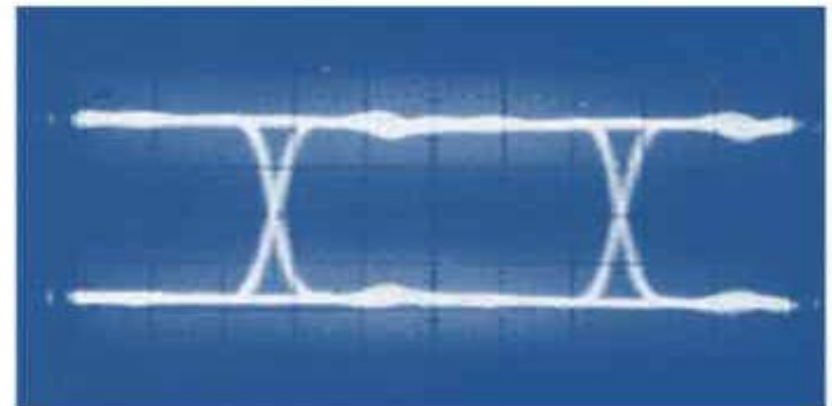
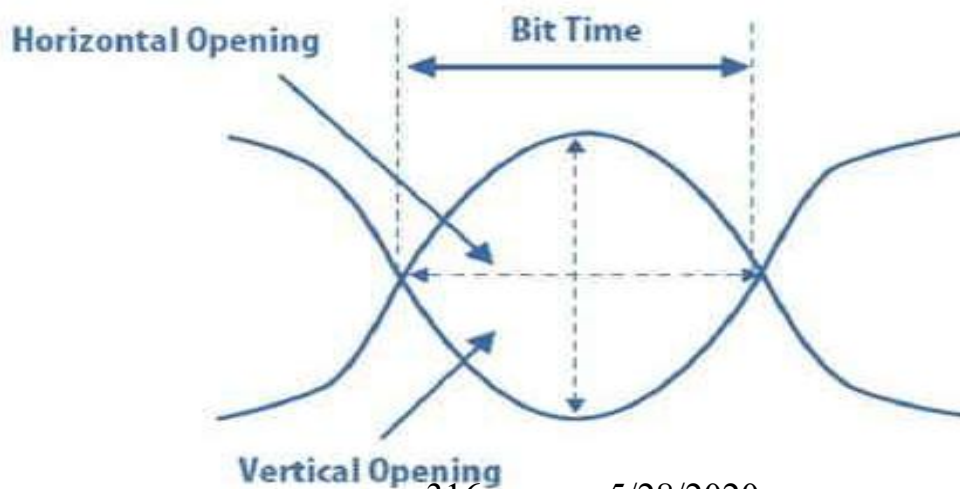



# Simplified EYE Diagram

## SIMPLIFIED EYE DIAGRAM

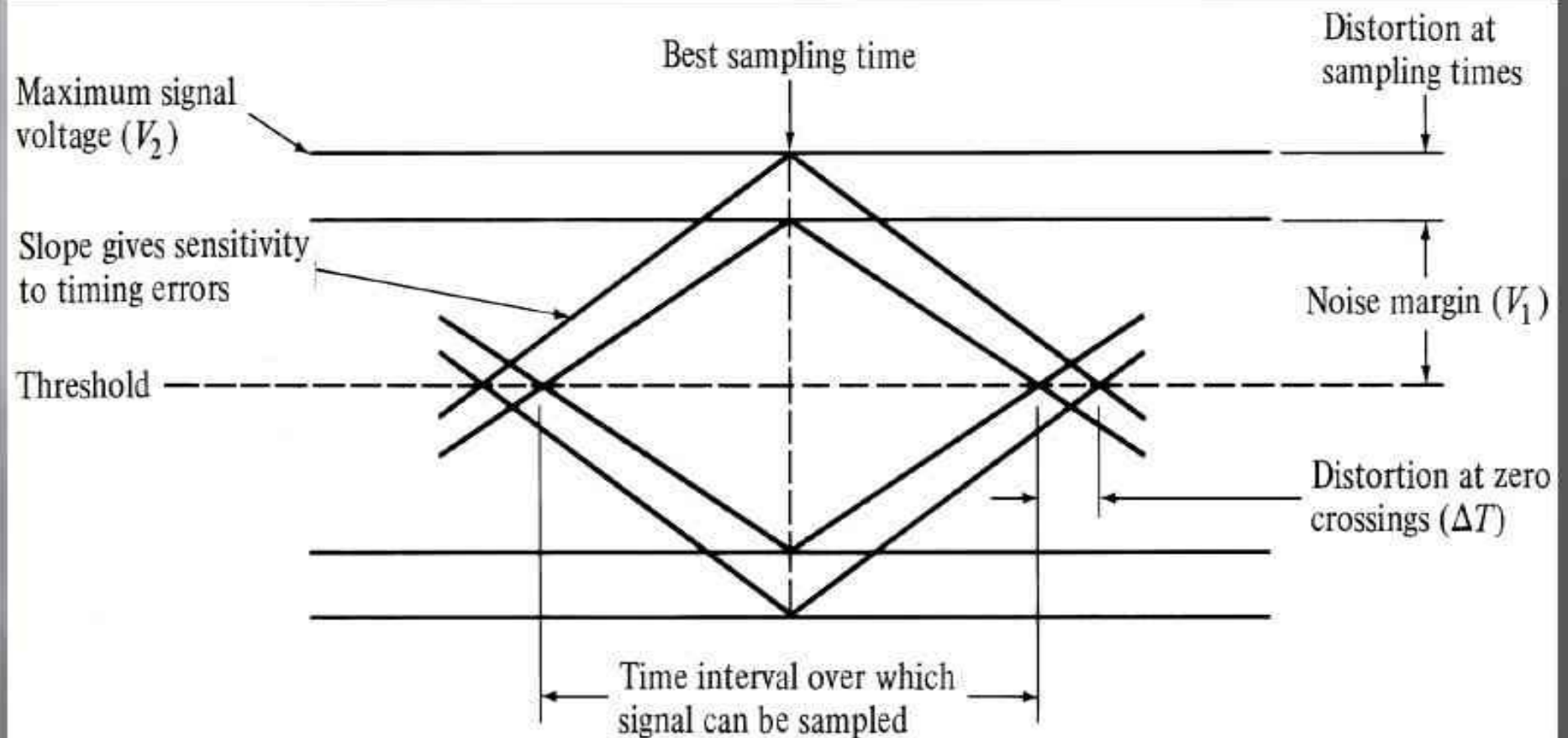



# EYE Diagram

- The eye diagram is a composite view of a very long data stream.
- It allows you to see all data patterns and combinations in a single display.
- It is achieved by using a clock signal to trigger the oscilloscope.

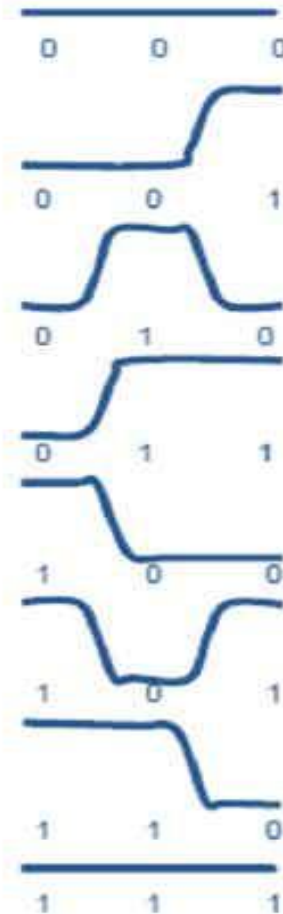



**Centurion**  
**UNIVERSITY**  
*Shaping Lives...  
Empowering Communities...*

# EYE Diagram is a statistical representation

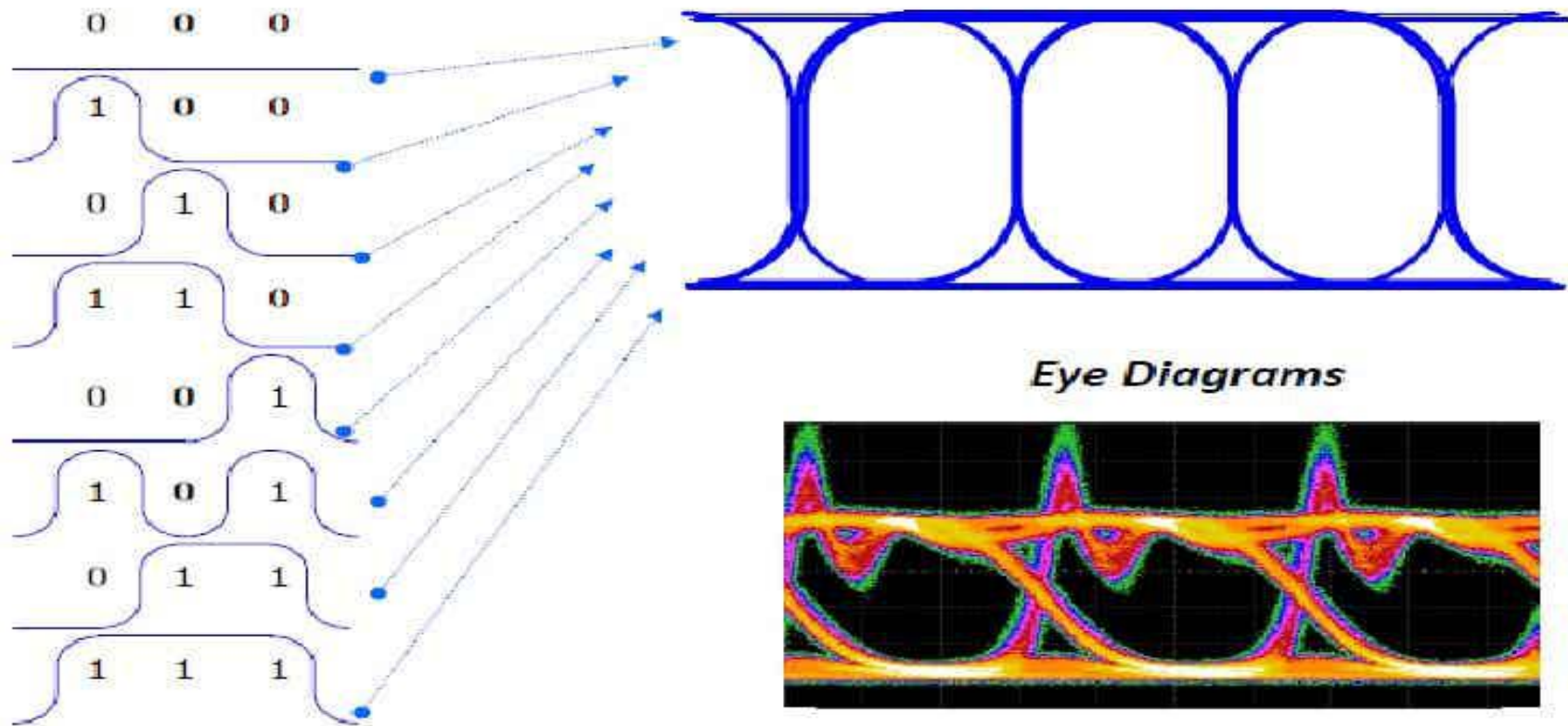

An eye diagram is a statistical representation of a bit stream, based on the contribution of randomly selected bits



Centurion  
UNIVERSITY

Shaping Lives...  
Empowering Communities...

# Jitter

The short-term, ( $>10\text{Hz}$ ), variations in the time base of a signal

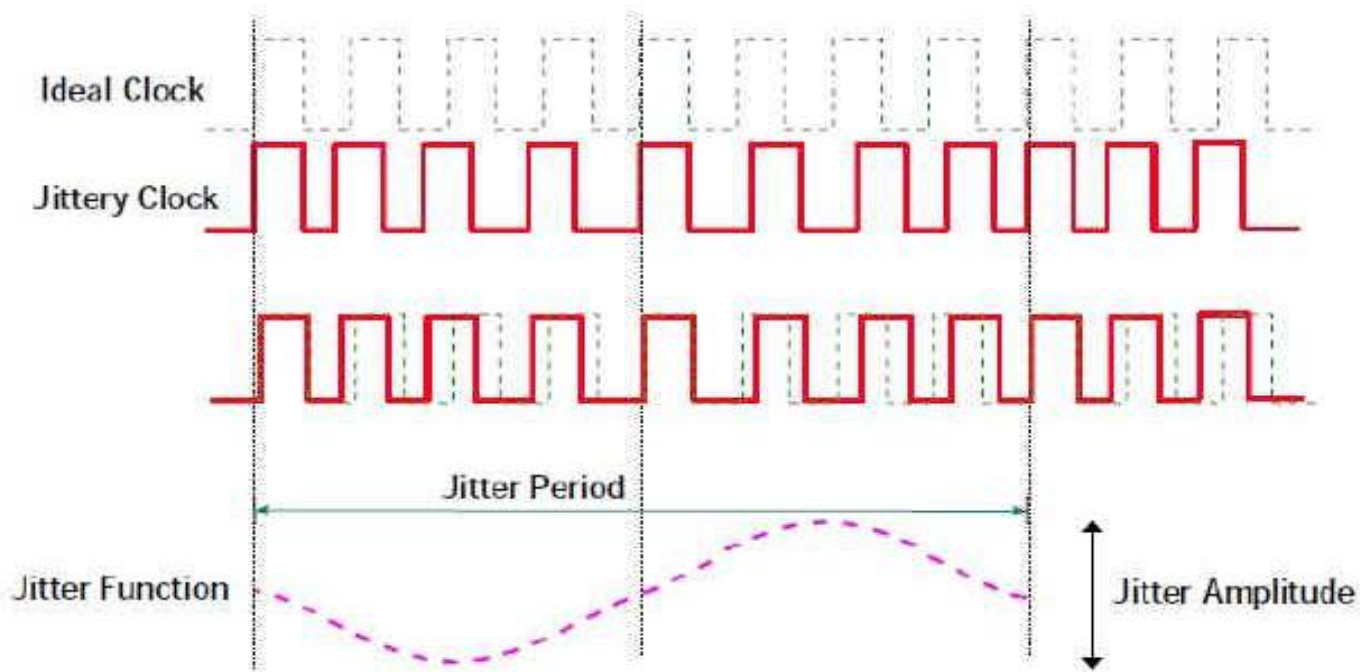



# EYE JITTER

## EYE DIAGRAM

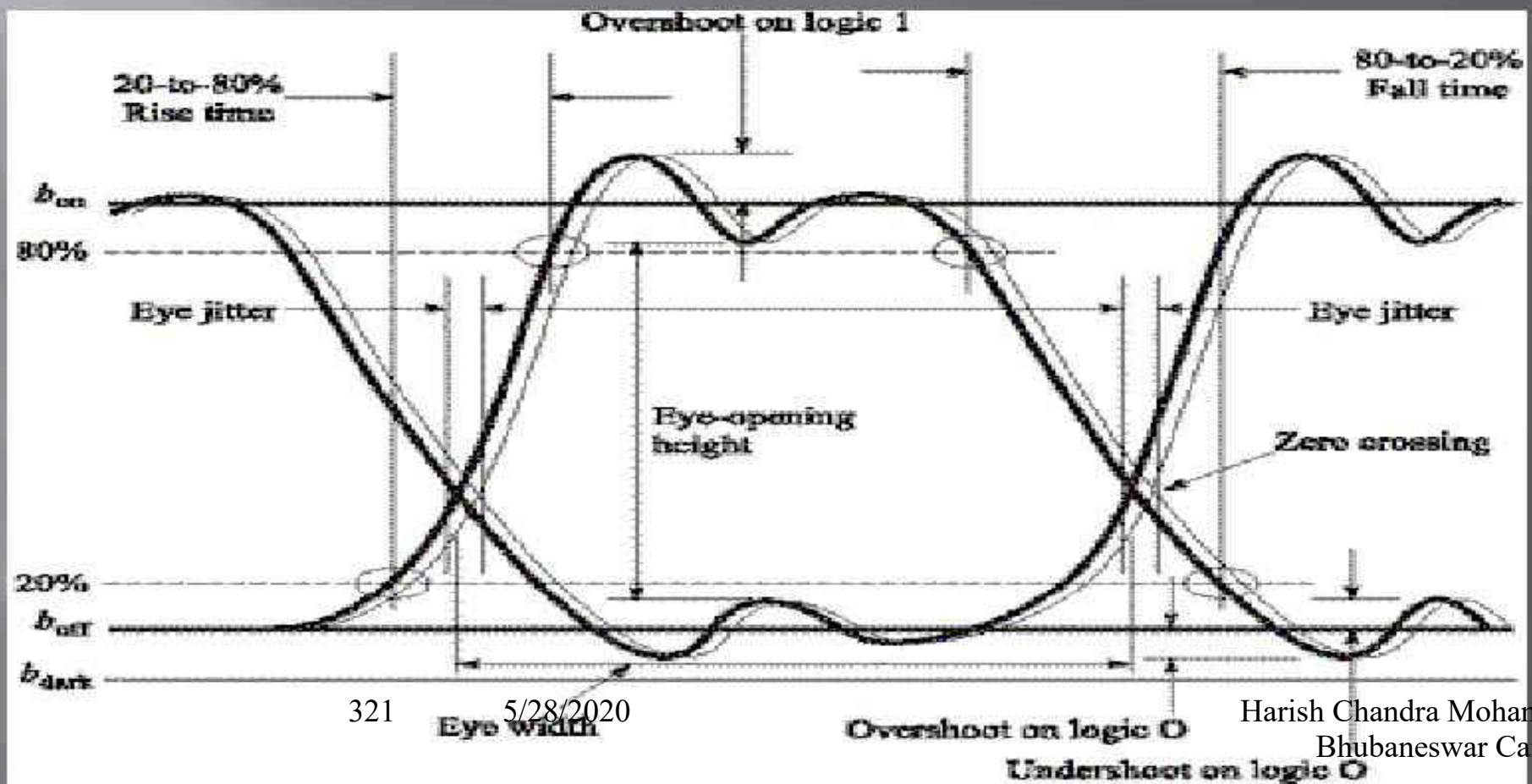



# Comparison

## EYE DIAGRAM

A bad eye with a lot of distortion due to dispersion

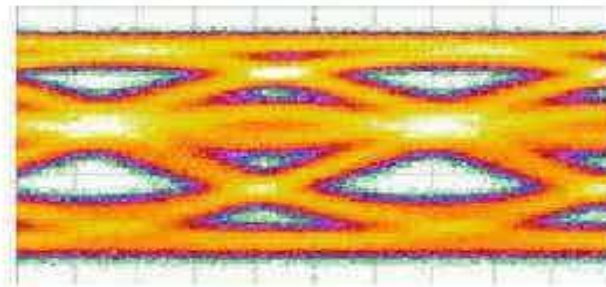

An OK eye

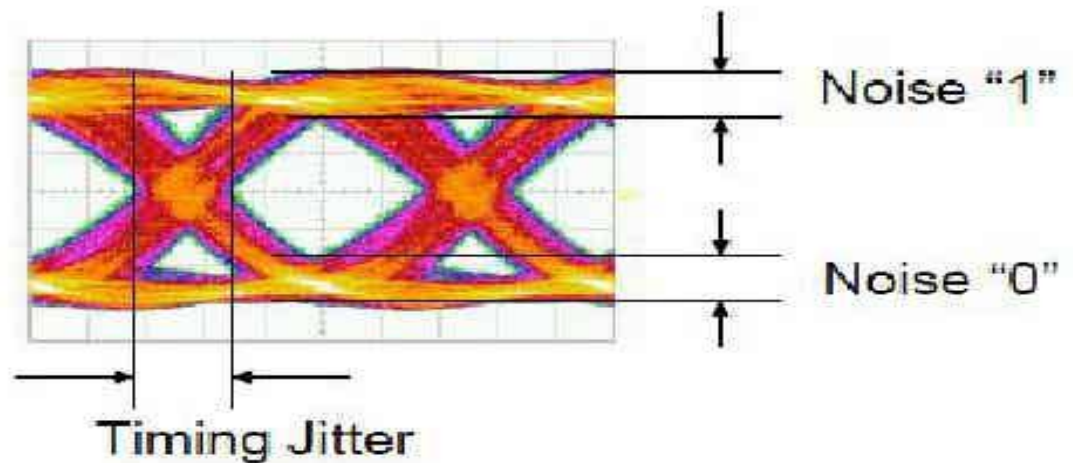



Centurion

# Unfiltered

## EYE

Higher Order Effects –  
The bandwidth of the  
oscilloscope captures  
fast transients and  
harmonics

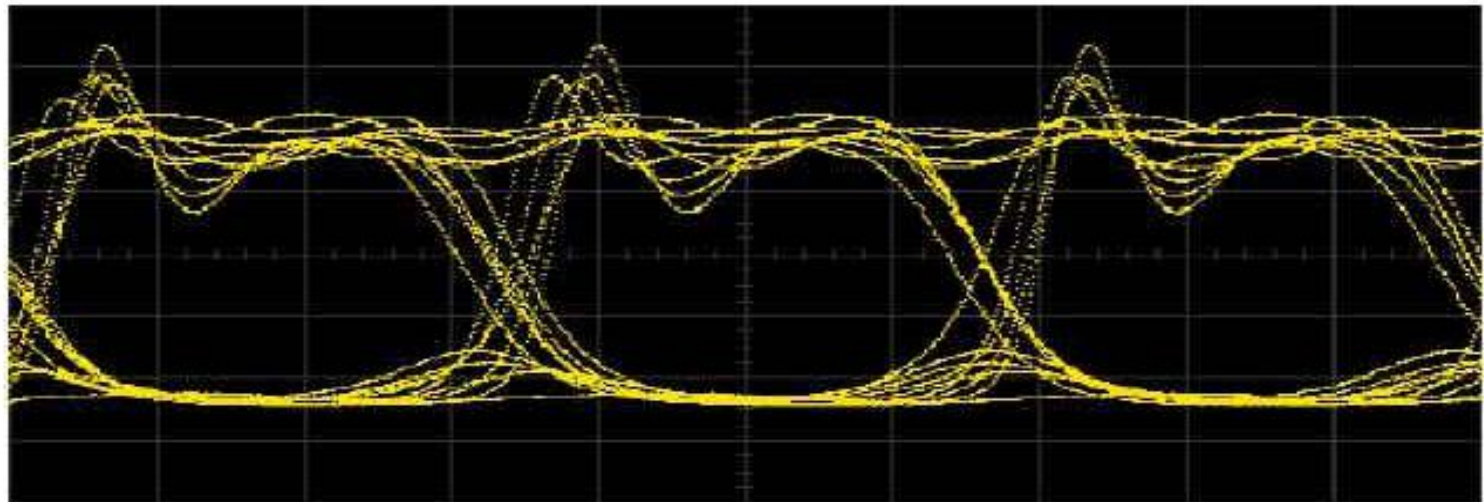
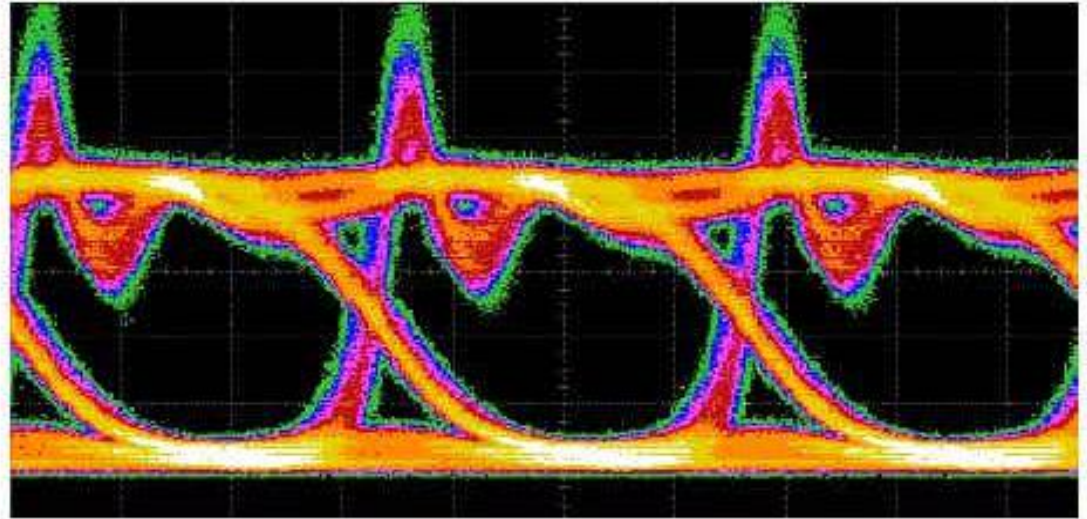



Centurion

# Filtered EYE

The filter limits higher order effects for compliance measurements.

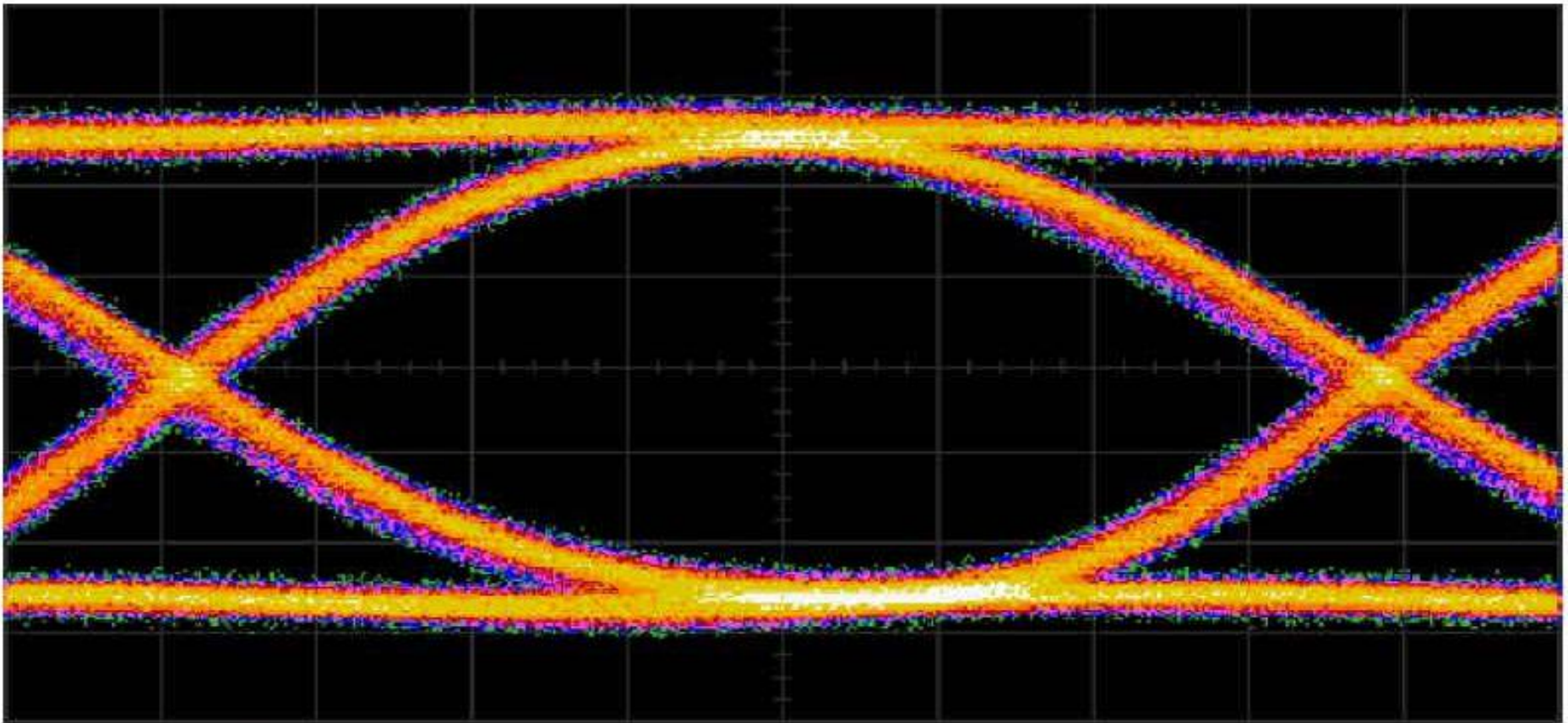

4<sup>th</sup>-order Bessel Thompson low-pass filter bandwidth =  $0.75 * \text{bit rate}$



**Centurion**  
**UNIVERSITY**  
*Shaping Lives...*  
*Empowering Communities...*

# THANK YOU



**Centurion**  
**UNIVERSITY**

*Shaping Lives...*  
*Empowering Communities...*

# Huffman Coding



**Centurion**  
**UNIVERSITY**

*Shaping Lives...  
Empowering Communities...*

# Contents

A simple example

Definitions

Huffman Coding Algorithm

Image Compression



Centurion  
UNIVERSITY

Shaping Lives...  
Empowering Communities...

# A simple example

Suppose we have a message consisting of 5 symbols, e.g. [▶♣♣♠😊▶♣☀▶😊]

How can we code this message using 0/1 so the coded message will have minimum length (for transmission or saving!)

5 symbols → at least 3 bits

For a simple encoding,

length of code is  $10 \times 3 = 30$  bits

▶	000
♣	001
😊	010
♠	011
☀	100



Centurion  
UNIVERSITY

Shaping Lives...  
Empowering Communities...

# A simple example – cont.

Intuition: Those symbols that are more frequent should have smaller codes, yet since their length is not the same, there must be a way of distinguishing each code

For Huffman code,  
length of encoded message

will be ▶♣♣♠😊▶♣☀▶😊

$$=3*2 +3*2+2*2+3+3=24\text{bits}$$

Symbol	Freq.	Code
▶	3	00
♣	3	01
😊	2	10
♠	1	110
☀	1	111



Centurion  
UNIVERSITY

Shaping Lives...  
Empowering Communities...

# Definitions

- An ensemble  $X$  is a triple  $(x, A_x, P_x)$

$x$ : value of a random variable

$A_x$ : set of possible values for  $x$  ,  $A_x = \{a_1, a_2, \dots, a_l\}$

$P_x$ : probability for each value ,  $P_x = \{p_1, p_2, \dots, p_l\}$

where  $P(x) = P(x = a_i) = p_i$ ,  $p_i \geq 0$ ,

$$\sum p_i = 1$$

## Shannon information content of $x$

$$h(x) = \log_2(1/P(x))$$

## Entropy of $x$

$$H(x) = \sum_{x \in A_x} P(x) \cdot \log \frac{1}{P(x)}$$

i	$a_i$	$p_i$	$h(p_i)$
1	a	.0575	4.1
2	b	.0128	6.3
3	c	.0263	5.2
..	..	..	..
26	z	.0007	10.4



Centurion  
UNIVERSITY

Shaping Lives...  
Empowering Communities...

# Source Coding Theorem

- There exists a variable-length encoding  $C$  of an ensemble  $X$  such that the average length of an encoded symbol,  $L(C, X)$ , satisfies
$$L(C, X) \in [H(X), H(X) + 1)$$
- The Huffman coding algorithm produces optimal symbol codes



Centurion  
UNIVERSITY

Shaping Lives...  
Empowering Communities...

# Symbol Codes

- Notations:
  - $A^N$ : all strings of length  $N$
  - $A^+$ : all strings of finite length
  - $\{0,1\}^3 = \{000,001,010,\dots,111\}$
  - $\{0,1\}^+ = \{0,1,00,01,10,11,000,001,\dots\}$
- A symbol code  $C$  for an ensemble  $X$  is a mapping from  $A_x$  (range of  $x$  values) to  $\{0,1\}^+$
- $c(x)$ : codeword for  $x$ ,  $l(x)$ : length of codeword



Centurion  
UNIVERSITY

Shaping Lives...  
Empowering Communities...

# Example

Ensemble X:

$$A_x = \{ a, b, c, d \}$$

$$P_x = \{ 1/2, 1/4, 1/8, 1/8 \}$$

$$c(a) = 1000$$

$$c^+(acd) =$$

$$100000100001$$

(called the extended code)

$C_0$ :

$a_i$	$c(a_i)$	$l_i$
a	1000	4
b	0100	4
c	0010	4
d	0001	4



**Centurion**  
**UNIVERSITY**

*Shaping Lives...  
Empowering Communities...*

# Any encoded string must have a unique decoding

A code  $C(X)$  is uniquely decodable if, under the extended code  $C^+$ , no two distinct strings have the same encoding, i.e.

$$\forall x, y \in A_X^+, x \neq y \Rightarrow c^+(x) \neq c^+(y)$$



**Centurion**  
**UNIVERSITY**

*Shaping Lives...  
Empowering Communities...*

# The symbol code must be easy to decode

If possible to identify end of a codeword as soon as it arrives

→no codeword can be a prefix of another codeword

A symbol code is called a prefix code if no code word is a prefix of any other codeword

(also called prefix-free code, instantaneous code or self-punctuating code)



Centurion  
UNIVERSITY

Shaping Lives...  
Empowering Communities...

# The code should achieve as much compression as possible

- The expected length  $L(C, X)$  of symbol code  $C$  for  $X$  is

$$L(C, X) = \sum_{x \in A_x} P(x)l(x) = \sum_{i=1}^{|A_x|} p_i l_i$$



Centurion  
UNIVERSITY

Shaping Lives...  
Empowering Communities...

# Example

Ensemble X:

$$A_x = \{ a, b, c, d \}$$

$$P_x = \{ 1/2, 1/4, 1/8, 1/8 \}$$

$c^+(acd) =$

0110111

(9 bits compared with 12)

$C_1:$

$a_i$	$c(a_i)$	$l_i$
a	0	1
b	10	2
c	110	3
d	111	3

prefix code?



**Centurion**  
**UNIVERSITY**

*Shaping Lives...  
Empowering Communities...*

# The Huffman Coding algorithm- History

- In 1951, David Huffman and his MIT information theory classmates given the choice of a term paper or a final exam
- Huffman hit upon the idea of using a frequency-sorted binary tree and quickly proved this method the most efficient.
- In doing so, the student outdid his professor, who had worked with information theory inventor Claude Shannon to develop a similar code.
- Huffman built the tree from the bottom up instead of from the top down



**Centurion**  
**UNIVERSITY**  
*Shaping Lives...  
Empowering Communities...*

# Huffman Coding Algorithm

1. Take the two least probable symbols in the alphabet  
(longest codewords, equal length, differing in last digit)
2. Combine these two symbols into a single symbol, and repeat.



**Centurion**  
**UNIVERSITY**

Shaping Lives...  
Empowering Communities...

# Example

$$A_x = \{ a, b, c, d, e \}$$

$$P_x = \{ 0.25, 0.25, 0.2, 0.15, 0.15 \}$$

$a_i$	$p_i$	$h(p_i)$	$l_i$	$c(a_i)$
a	0.25	2.0	2	00
b	0.25	2.0	2	10
c	0.2	2.3	2	11
d	0.15	2.7	3	010
e	0.15	2.7	3	011

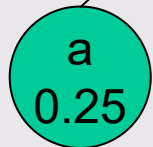
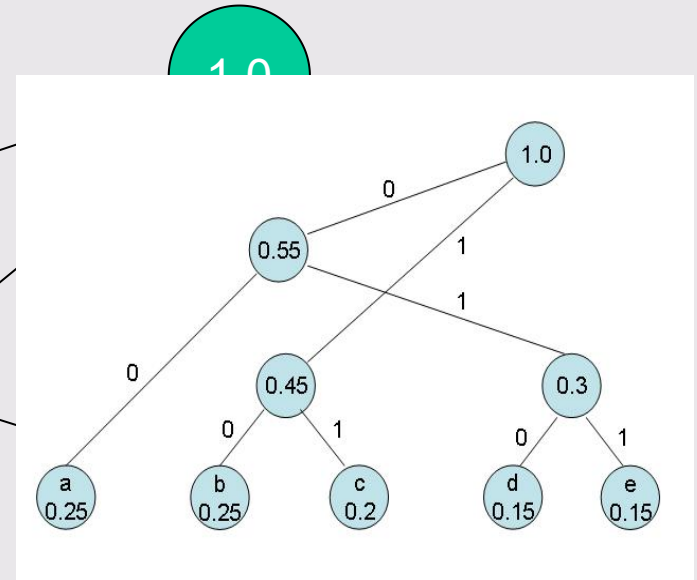

00

340

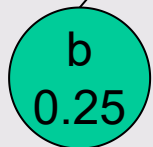

10

10/8/2020

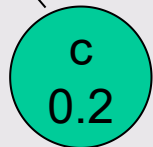

11



010

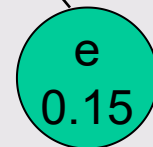

011



Centurion  
UNIVERSITY

Shaping Lives...  
Empowering Communities...

# Statements

- Lower bound on expected length is  $H(X)$
- There is no better symbol code for a source than the Huffman code
- Constructing a binary tree top-down is suboptimal



**Centurion**  
**UNIVERSITY**

*Shaping Lives...  
Empowering Communities...*

# Disadvantages of the Huffman Code

- Changing ensemble
  - If the ensemble changes → the frequencies and probabilities change → the optimal coding changes
  - e.g. in text compression symbol frequencies vary with context
  - Re-computing the Huffman code by running through the entire file in advance?!
  - Saving/ transmitting the code too?!
- Does not consider ‘blocks of symbols’
  - ‘strings\_of\_ch’ → the next nine symbols are predictable ‘aracters\_’, but bits are used without conveying any new information



Centurion  
UNIVERSITY

Shaping Lives...  
Empowering Communities...

# Variations

- $n$ -ary Huffman coding
  - Uses  $\{0, 1, \dots, n-1\}$  (not just  $\{0,1\}$ )
- Adaptive Huffman coding
  - Calculates frequencies dynamically based on recent actual frequencies
- Huffman template algorithm
  - Generalizing
    - probabilities  $\rightarrow$  any weight
    - Combining methods (addition)  $\rightarrow$  any function
  - Can solve other min. problems e.g.  $max$

343  $[w_i + length(c_i)]$   
5/28/2020



Centurion  
UNIVERSITY

Shaping Lives...  
Empowering Communities...

# Image Compression

## 2-stage Coding technique

1. A linear predictor such as DPCM, or some linear predicting function → Decorrelate the raw image data
2. A standard coding technique, such as Huffman coding, arithmetic coding, ...

### Lossless JPEG:

- version 1: DPCM with arithmetic coding
- version 2: DPCM with Huffman coding



Centurion  
UNIVERSITY

Shaping Lives...  
Empowering Communities...

# DPCM

## Differential Pulse Code Modulation

- DPCM is an efficient way to encode highly correlated analog signals into binary form suitable for digital transmission, storage, or input to a digital computer
- Patent by Cutler (1952)



Centurion  
UNIVERSITY

Shaping Lives...  
Empowering Communities...

# DPCM

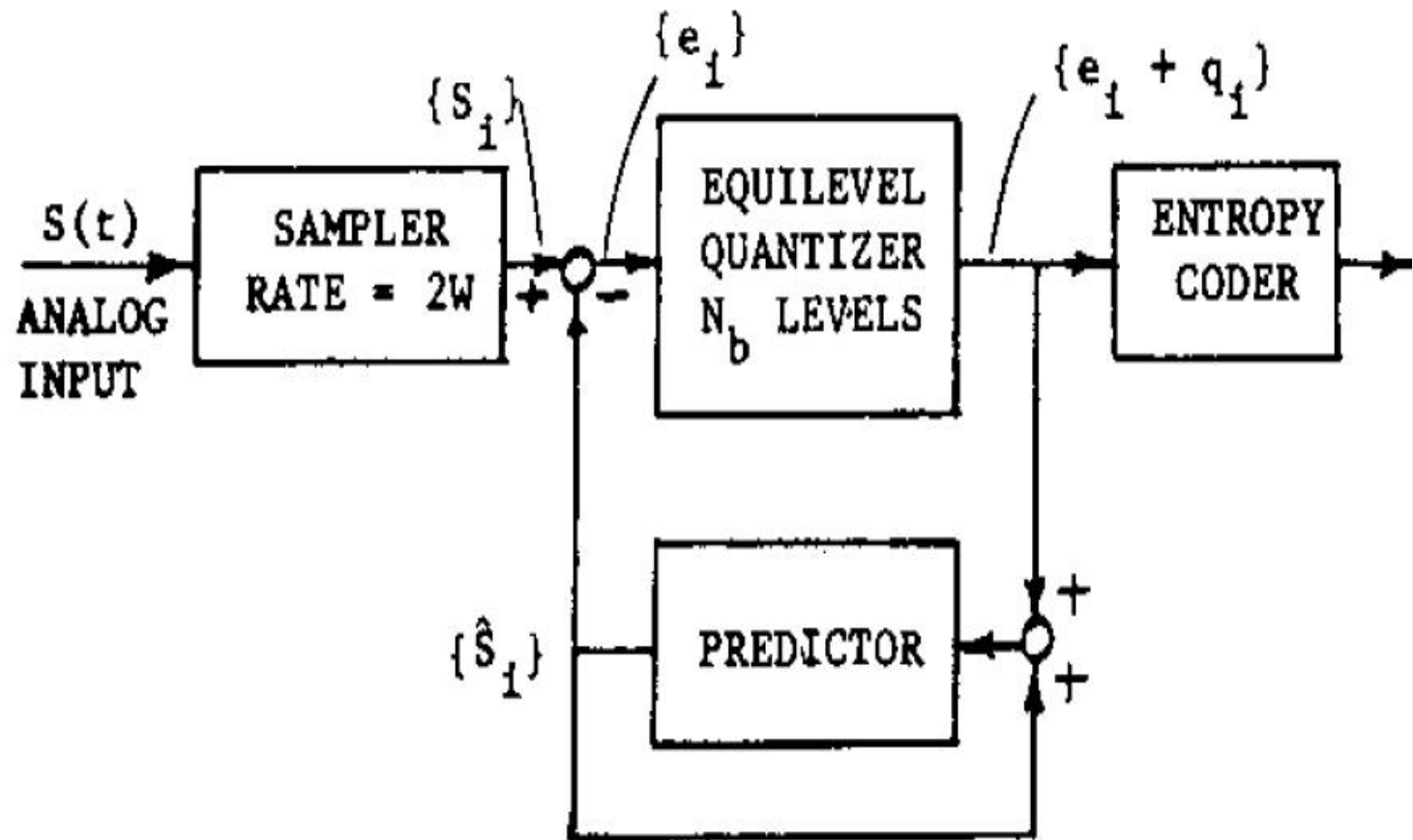



**Centurion**  
**UNIVERSITY**

*Shaping Lives...  
Empowering Communities...*

# Huffman Coding Algorithm for Image Compression

- Step 1. Build a Huffman tree by sorting the histogram and successively combine the two bins of the lowest value until only one bin remains.
- Step 2. Encode the Huffman tree and save the Huffman tree with the coded value.
- Step 3. Encode the residual image.



Centurion  
UNIVERSITY

Shaping Lives...  
Empowering Communities...

# Huffman Coding of the most-likely magnitude MLM Method

1. Compute the residual histogram H

$H(x) = \#$  of pixels having residual magnitude x

2. Compute the symmetry histogram S

$S(y) = H(y) + H(-y), y \geq 0$

3. Find the range threshold R

for N: # of pixels , P: desired proportion of most-likely magnitudes

$$\sum_{j=0}^{R-1} S(j) \leq P \times N < \sum_{j=0}^R S(j)$$



**Centurion**  
**UNIVERSITY**

*Shaping Lives...  
Empowering Communities...*

# Shannon – Fano Coding

- Arrange the messages in order of decreasing probability.
- In column 1, divide the messages into two partitions such that the sum of the probabilities of each group are the same.
- Assign the bit 0 to the message in one partition and assign the bit 1 to all the messages in the other partition.
- This process of dividing groups in the same partition into two groups partitions each with equal sums of probabilities is continued, until each message finds itself alone in a partition.



# Hamming CODE

Harish Chandra Mohanta, CUTM, Bhubaneswar CaMPUS



**Centurion**  
**UNIVERSITY**

*Shaping Lives...  
Empowering Communities...*

# INTRODUCTION

- A code is said to be linear if any two code words in the code can be added in modulo-2 arithmetic to produce a third codeword in the code.
- A codeword is divided into two parts, one of which occupied by the message bits and other by the parity bits.
- For an  $(n, k)$  linear block code,  $k$  bits of the  $n$  bits are message bits and  $n-k$  bits are parity bits.

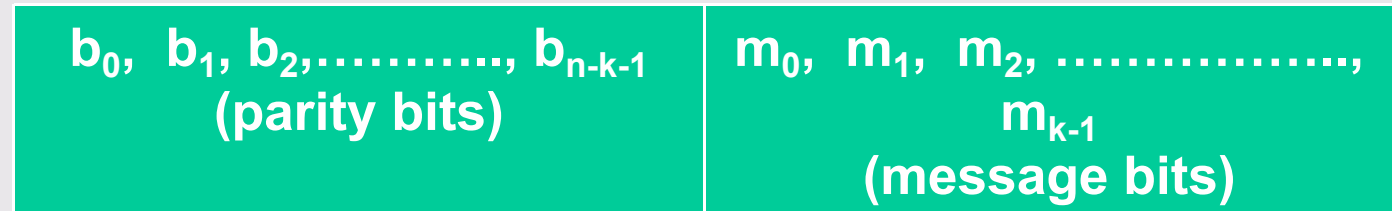

Structure of codeword



Centurion  
UNIVERSITY

Shaping Lives...  
Empowering Communities...

# Hamming distance and hamming weight

- Consider a pair of code vectors  $c_1$  and  $c_2$  that have the same number of elements.
- The **Hamming distance**  $d(c_1, c_2)$  between such a pair of code vectors is defined as the number of locations in which their respective elements differ.
- The **Hamming weight**  $w(c)$  of a code vector  $c$  is defined as the number of nonzero elements in the code vector. We may state that the Hamming weight of a code vector is the distance between the code vector and the all-zero code vector.
- The minimum distance  $d_{\min}$  of a linear block code is defined as the smallest Hamming distance between any pair of code vectors in the code.
- We may state that the minimum distance of a linear block code is the smallest Hamming weight of the nonzero code vectors in the code.



**Centurion**  
**UNIVERSITY**

*Shaping Lives...  
Empowering Communities...*

# Hamming Codes

- Hamming code is a set of error-correction codes that can be used to **detect and correct the errors** that can occur when the data is moved or stored from the transmitter to the receiver.
- This technique was developed by **R.W. Hamming** for error correction.
- **Parity bits** are extra binary bits that are generated and added to the information-carrying (message) bits of data transfer to ensure that no bits were lost during the data transfer.
- The number of parity bits can be calculated using the following formula:

$$2^p \geq p + m + 1$$

Where  $p$  is the no. of parity bits and  $m$  is the no. of message bits

Here,  $P \geq 3$ , block length= $n=2^p-1$ , no. of message bits= $m=k=2^p-p-1$ , no. of parity bits= $p=n-k$  for block code of  $(n, k)$ .



# Hamming Codes

- Hamming codes are single-error correcting binary perfect codes.
- No. of parity bits calculation formula
$$2^p \geq p + m + 1$$
- Where  $p$  is the no. of parity bits and  $m$  is the no. of message bits
- All bit positions that are power of 2 are marked as parity bits (1, 2, 4, 8,.....,  $2^n$ ), other bits are message bits.
- So block code  $C(7,4)$  means total no. of bits in the codeword is 7. The no. of message bits=4 and no. of parity bits=7-4=3. message= $m_1m_2m_3m_4$  and parity bits are  $p_1, p_2, p_3$ .

Hamming code format is  $p_1 p_2 m_1 p_3 m_2 m_3 m_4$ .

Bit positions are <sup>354</sup> 1, 2, 3, 4, 5, 6, 7. <sup>5/28/2020</sup>



Centurion  
UNIVERSITY

Shaping Lives...  
Empowering Communities...

# Generation of Hamming Code

- Generate the hamming code for the message 1110.

Here, message bits= $m=4$ .

- To calculate no. of parity bits  $p$ , we have to use the formula  $2^p \geq p + m + 1$
- To satisfy above condition, the minimum value of  $p$  is 3.  
So, the no. of parity bits= $p=3$

Parity bits are  $p_1, p_2, p_3$ .

- Hamming code is  $p_1 p_2 m_1 p_3 m_2 m_3 m_4$ . i.e.  $p_1 p_2 1 p_3 1 1 0$ .
- Now we have to find the value of parity bits i.e.  $p_1$  value,  $p_2$  value and  $p_3$  value.
- $p_1$  value,  $p_2$  value and  $p_3$  value must satisfy even parity or odd parity.



Centurion  
UNIVERSITY

Shaping Lives...  
Empowering Communities...

# Hamming code generation

$P_1 \rightarrow 1, 3, 5, 7 \rightarrow P_1 = 1 \oplus 1 \oplus 0$ . To make even parity  $P_1 = 0$ . Because for even parity, the total of 1's present must be even.

$P_2 \rightarrow 2, 3, 6, 7 \rightarrow P_2 = 1 \oplus 1 \oplus 0$ . To make even parity  $P_2 = 0$ . Because for even parity, the total of 1's present must be even.

$P_3 \rightarrow 4, 5, 6, 7 \rightarrow P_3 = 1 \oplus 1 \oplus 0$ . To make even parity  $P_3 = 0$ . Because for even parity, the total of 1's present must be even.

So, all parity bits are 0.

Hence, Hamming code is 0 0 1 0 1 1 0 for even parity transmission.

For odd parity transmission, Hamming code is 1111110.

Since 3 parity bits are there, so total combination values, we have 000, 001, 010, 011, 100, 101, 110, 111.

For  $P_1$ , we have taken which have 1 in 1<sup>st</sup> place in above combinations i.e. 1, 3, 5, 7.

For  $P_2$ , we have taken which have 1 in 2<sup>nd</sup> place in above combinations i.e. 2, 3, 6, 7.

For  $P_3$ , we have taken which have 1 in 3<sup>rd</sup> place in above combinations i.e. 4, 5, 6, 7.



Centurion  
UNIVERSITY

Shaping Lives...  
Empowering Communities...

# ERROR CORRECTION IN HAMMING CODING

C(7,4) hamming code is received as 1010111. Determine the correct code when even parity is there.

Here, no. message bits=4, no. of parity bits=7-4=3.

1	0	1	1	0	0	1	1	1	0	1
---	---	---	---	---	---	---	---	---	---	---

- Error place depends on the no. of parity bits. So , here error place= $E_3 E_2 E_1$ .
- $E_1 \rightarrow 1, 3, 5, 7 \rightarrow 1 1 1 1$ , To make even parity, here  $E_1=0$  , as four 1's are present.
- $E_2 \rightarrow 2, 3, 6, 7 \rightarrow 0 1 1 1$ , To make even parity, here  $E_2=1$  , as three 1's are present.
- $E_3 \rightarrow 4, 5, 6, 7 \rightarrow 0 1 1 1$ , To make even parity, here  $E_3=1$  , as three 1's are present.



Centurion  
UNIVERSITY

Shaping Lives...  
Empowering Communities...

# CORRECT HAMMING CODE

- Here, error place can be defined as  $E_3$   $E_2$   $E_1$  i.e. 1 1 0 whose decimal equivalent is 6.
- So, in 6<sup>th</sup> bit there is an error. Since '1' is received in 6<sup>th</sup> bit, the corrected bit value in 6<sup>th</sup> bit is 0.
- Hence, the corrected Hamming code is 1 0 1 0 1 0 1.



**Centurion**  
**UNIVERSITY**

*Shaping Lives...*  
*Empowering Communities...*

# THANK YOU