

FUEL CELLS

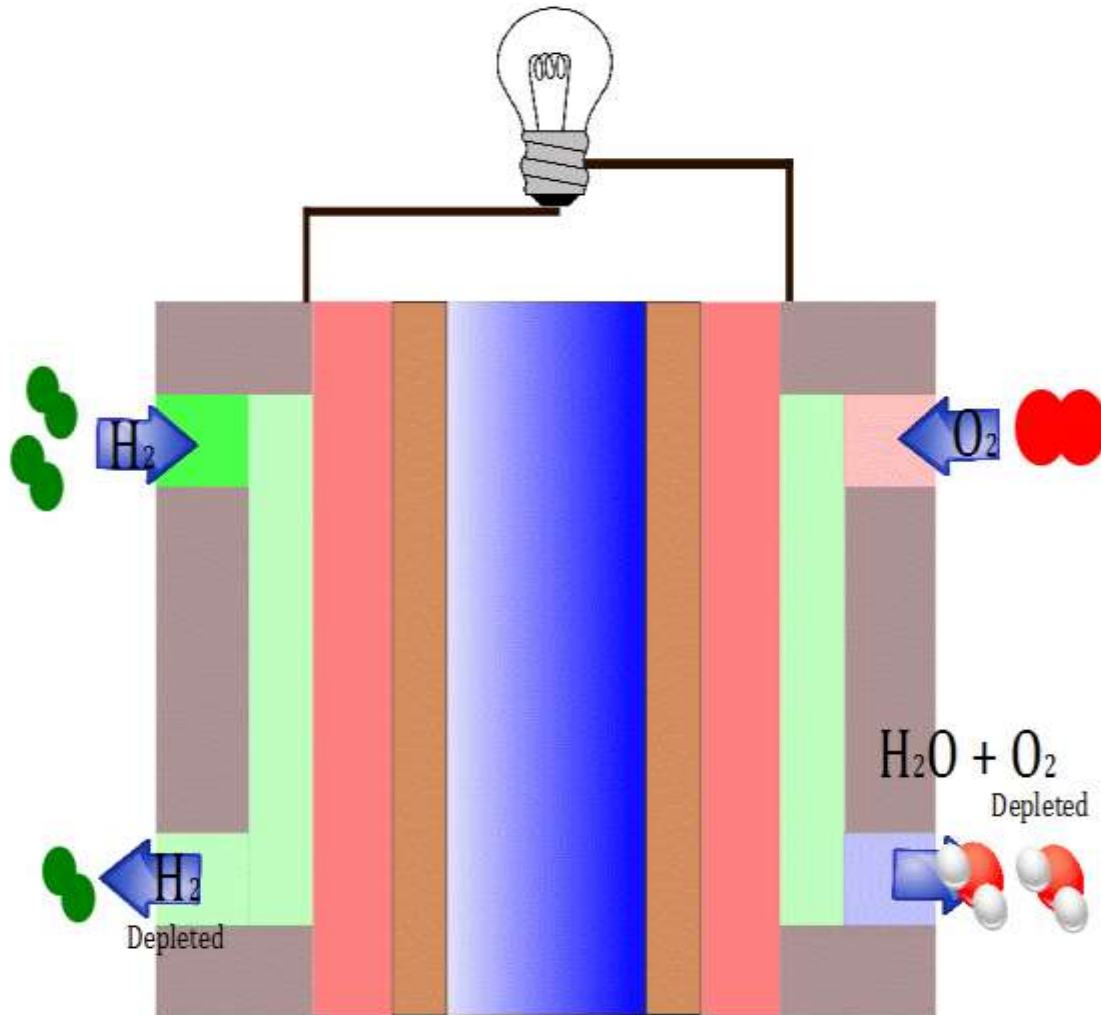

BY: Sumedha Bhat
Siddarth K
Achar
Siddhant Gupta
Megha
Rajasekhar

What is a Fuel CELL?

- Basically fuel cell in common language, is a device which converts chemical energy from a fuel into electrical energy .
- It happens by undergoing a chemical reaction where positively charged hydrogen ions reacts with oxygen or any other oxidizing agent.
- The fuel cell consists of two electrodes where the reaction takes place,one is positively charged called anode and the negatively charged called cathode.
- Every fuel cell comprises of an electrolyte and a catalyst to fasten the reaction rate and to mobilise the ions to one electrode to the other.
- A single fuel cell generates a tiny amount of direct current (DC) electricity.
- Many fuel cells are usually assembled into a stack. Cell or stack, the principles are the same.

Why use a fuel cell?

- Pollution free.
- Pure hydrogen is used as a fuel and the only by products are water and heat
- Does work of both a combustion engine (chemical energy to electrical energy to mechanical energy) and a battery (chemical to electrical) but with more efficiency and longer life span.
- Longer life span as no moving parts, therefore no wear and tear
- Efficiency can be increased if fuel cell incorporates thermal cogeneration (harnessing thermal output to run turbines. Therefore additional electricity produced)

Working of a Fuel Cell

- At anode- catalyst oxidizes the fuel-usually hydrogen-turning the fuel into positively charged ion and negatively charged electron.
- Electrolyte-substance specifically designed so ions can pass through it-electrons cannot.
- Freed electrons travel through wire-creating electric current. Ions travel through the electrolyte to the cathode.
- Once reaching cathode-ions reunited with electrons-react with third chemical-usually oxygen,-create water or carbon dioxide.

BLOCK

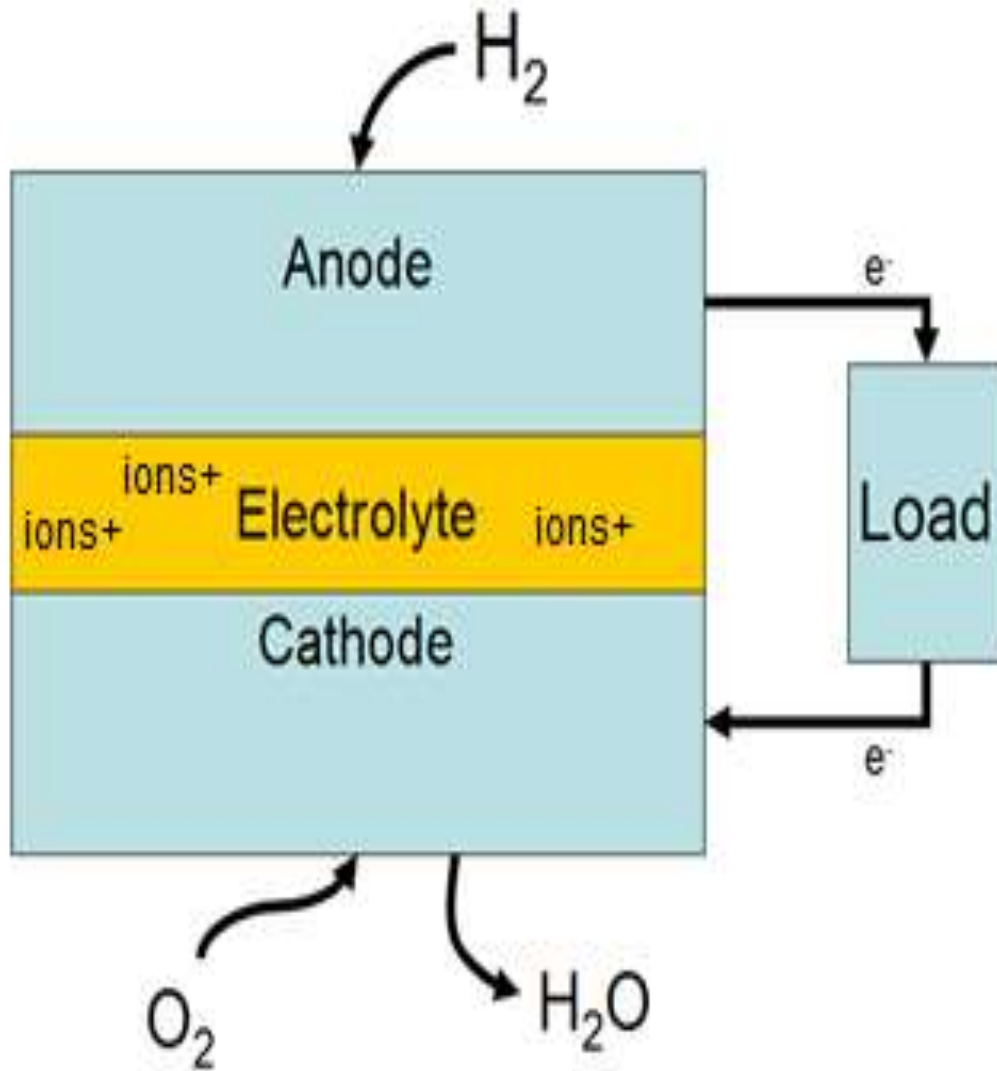

GENERALIZED CHEMICAL REACTION

Anode side (an oxidation reaction)



Cathode side (a reduction reaction)

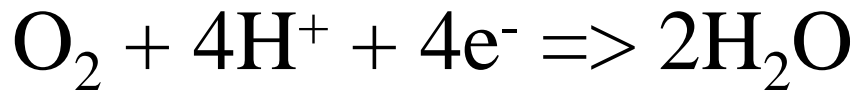

Net reaction (the "redox" reaction)

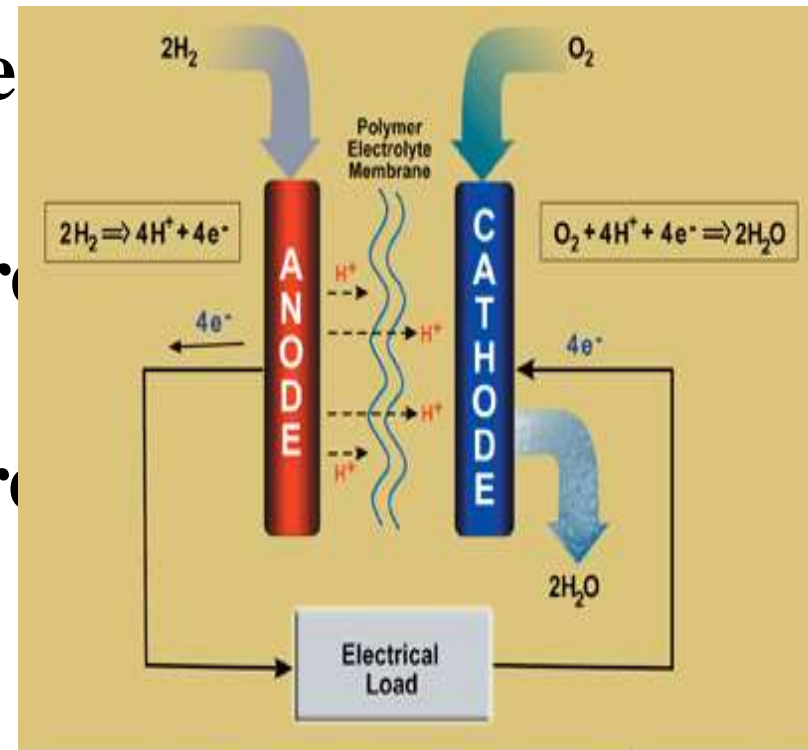
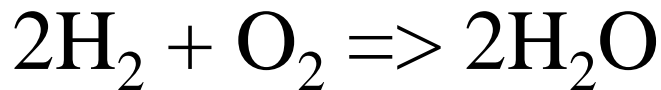

engsoc.queensu.ca

TYPES OF FUEL CELL

On the basis of the electrolyte used the fuels cell can be classified as follows:-

1. Alkaline Fuel Cell-alkaline solution electrolyte such as KOH.
2. Phosphoric Acid Fuel Cells(PAFC)-electrolyte is phosphoric acid.
3. Solid Proton Exchange Membrane Fuel Cell-electrolyte is polymer electrolyte membrane fuel cells and their electrolyte consist of the proton exchange membrane.
4. Molten Carbonate Fuel Cells-electrolyte as molten carbonate.
5. Solid Oxide Fuel Cells(SOFC)-electrolyte is ceramic ion conducting electrolyte in solid oxide form.
6. Regenerative Fuel Cell



ALKALINE FUEL CELL

- This is one of the oldest designs for fuel cells; the United States space program has used them since the 1960s.
- The AFC is very susceptible to contamination, so it requires pure hydrogen and oxygen. It is also very expensive, so this type of fuel cell is unlikely to be commercialized.
- They are among the most efficient fuel cells, having the potential to reach 70%.
- The electrolyte used is aqueous potassium hydroxide(KOH). The electrolyte acts as a medium for conduction of ions in between the electrodes.
- Porous (and catalyzed) graphite electrodes
- Semi-permeable, Teflon coated carbon material
- Heavily catalyzed

WORKING

The chemistry behind the AFC is:-

The fuel cell produces power through a redox reaction between hydrogen and oxygen.

At the anode, hydrogen is oxidized according to the reaction:



producing water and releasing two electrons.

The electrons flow through an external circuit and return to the cathode, reducing oxygen in the reaction:



producing hydroxide ions.

The net reaction consumes one oxygen atom and two hydrogen atoms in the production of each water molecule.

Electricity and heat are formed as by-products of this reaction.

DIAGRAM

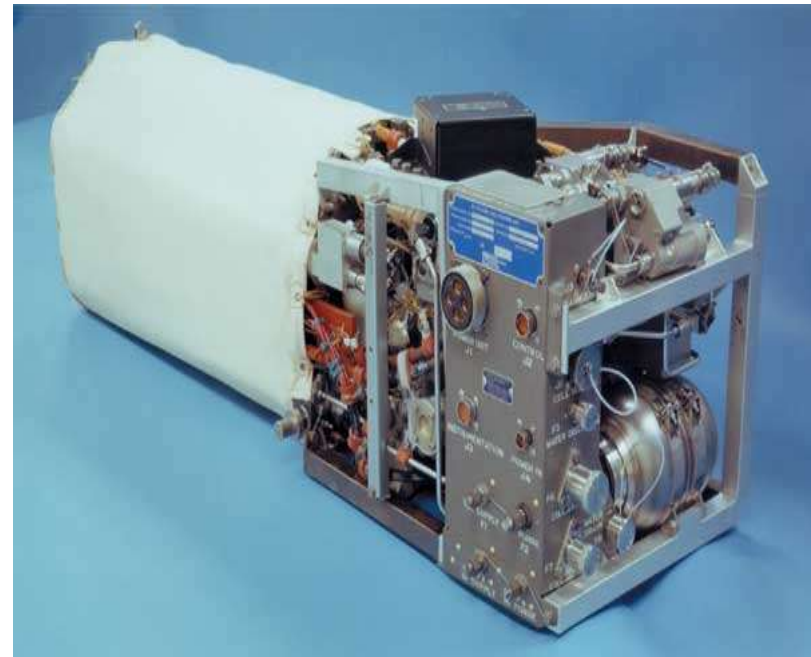
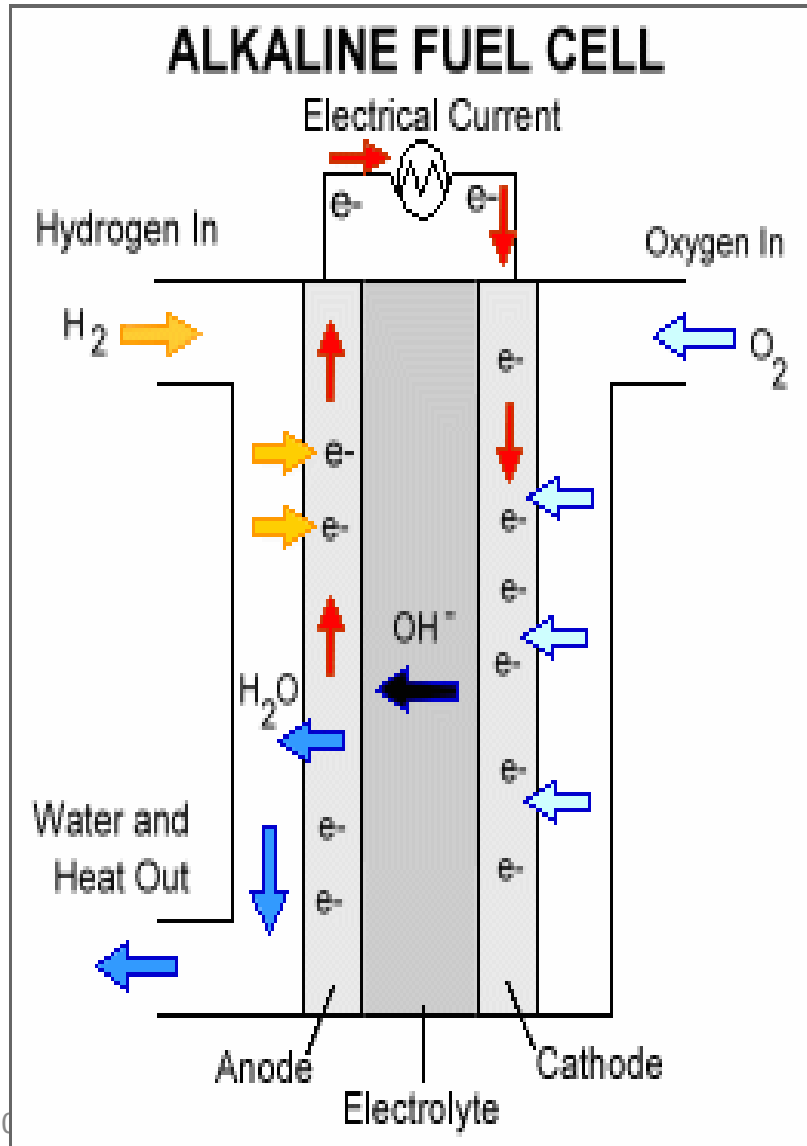

Alkaline Fuel Cell
used for Apollo
Missions

APPLICATIONS OF AFC

- The alkaline fuel cells are the most used as they are the most efficient and are cheap to manufacture.
- The first alkaline fuel cells were used by NASA in the Apollo missions to provide power as well as provide with potable water for the astronauts.
- The alkaline fuel cell is commercially incubated into a 22 seated hydrogen ship ,power-assisted by an electric motor that gets its electricity from a fuel cell.
- The ship is known as HYDRA,it was used as a ferry boat in GHENT,Belgium.

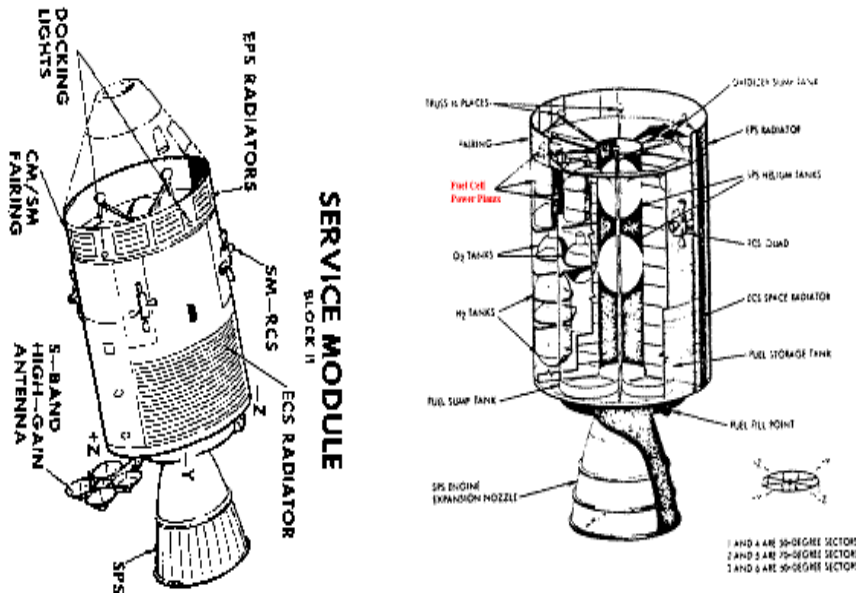

PHOSPHORIC ACID FUEL CELL(PAFC)

- The phosphoric-acid fuel cell has potential for use in small stationary power-generation systems.
- It operates at a higher temperature than polymer exchange membrane fuel cells, so it has a longer warm-up time.
- This makes it unsuitable for use in cars.
- Electrodes: porous carbon containing Pt or its alloys as catalysts.
- Electrolyte: liquid phosphoric acid in Teflon-bonded silicon carbide matrix.
- Operating range is about 150 to 210 °C.

WORKING

Anode reaction: $2\text{H}_2 \rightarrow 4\text{H}^+ + 4\text{e}^-$

Cathode reaction: $\text{O}_2(\text{g}) + 4\text{H}^+ + 4\text{e}^- \rightarrow 2\text{H}_2\text{O}$

Overall cell reaction: $2\text{H}_2 + \text{O}_2 \rightarrow 2\text{H}_2\text{O}$

PAFCs are CO_2 -tolerant and even can tolerate a CO concentration of about 1.5 percent, which broadens the choice of fuels they can use.

They have an efficiency of about 70%.

DIAGRAM

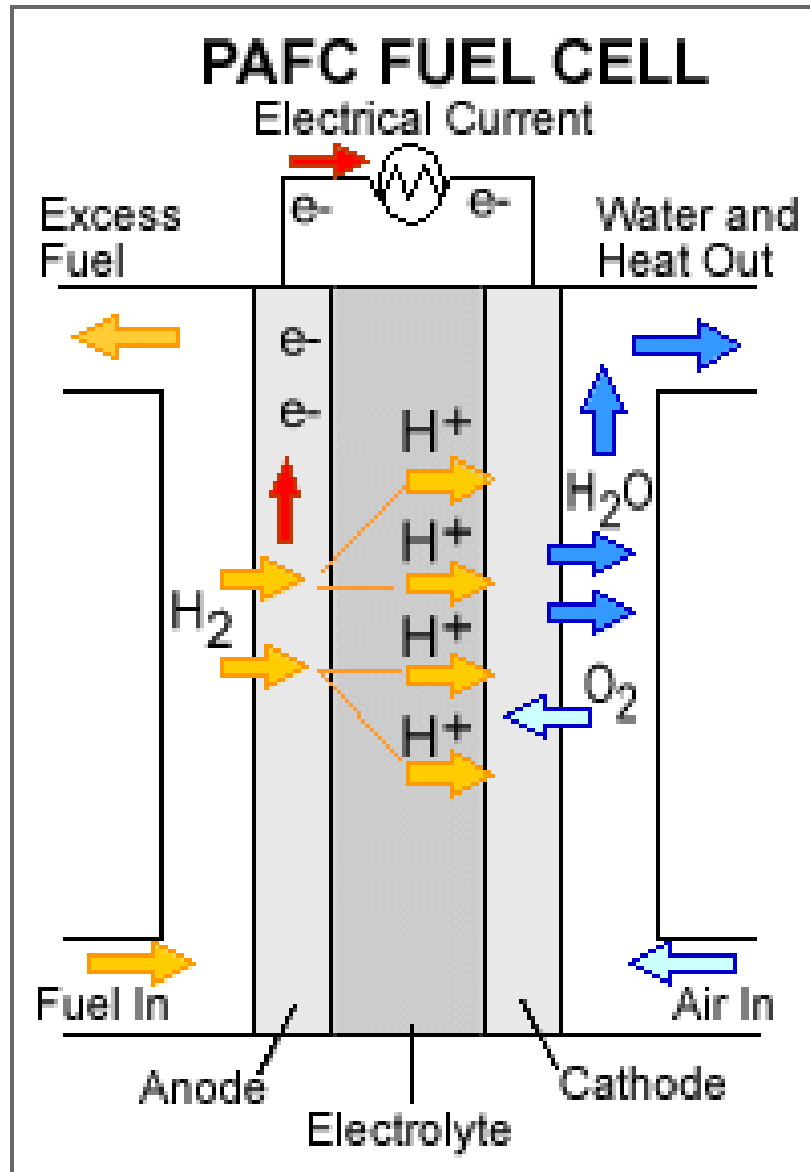

APPLICATIONS

- PAFC have been used for stationary power generators with output in the 100 kW to 400 kW range and they are also finding application in large vehicles such as buses.
- India's DRDO is developing PAFC for air independent propulsion



bm:
red

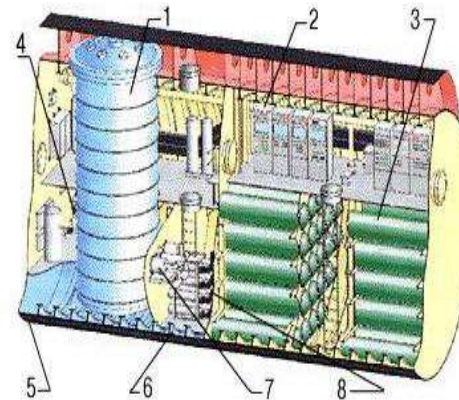

Javy have

1. Liquid oxygen tank
2. Monitoring panels
3. Hydrogen accumulators
4. Heat exchangers
- 5,6. Technical water tanks
7. Ventilation and burning system
8. Fuel cells

Fig. 5. Power plant module with electro-chemical generators

Solid Proton Exchange Membrane Fuel Cell

- High power density
- Relatively low operating temperature (ranging from 60 to 80 degrees Celsius, or 140 to 176 degrees Fahrenheit).
- The low operating temperature means that it doesn't take very long for the fuel cell to warm up and begin generating electricity.
- PEMFCs are built out of membrane electrode assemblies (MEA) which include the electrodes, electrolyte, catalyst, and gas diffusion layers
- . An ink of catalyst, carbon, and electrode are sprayed or painted onto the solid electrolyte and carbon paper is hot pressed on either side to protect the inside of the cell and also act as electrodes.
- The pivotal part of the cell is the triple phase boundary (TPB) where the electrolyte, catalyst, and reactants mix and thus where the cell reactions actually occur. Importantly, the membrane must not be electrically conductive so the half reactions do not mix.

WORKING

- To function, the membrane must conduct hydrogen ions (protons) but not electrons as this would in effect "short circuit" the fuel cell.
- The membrane must also not allow either gas to pass to the other side of the cell, a problem known as gas crossover. Finally, the membrane must be resistant to the reducing environment at the cathode as well as the harsh oxidative environment at the anode.
- Splitting of the hydrogen molecule is relatively easy by using a platinum catalyst. Unfortunately however, splitting the oxygen molecule is more difficult, and this causes significant electric losses.
- An appropriate catalyst material for this process has not been discovered, and platinum is the best option.
- A cheaper alternative to platinum is Cerium(IV) oxide

DIAGRAM

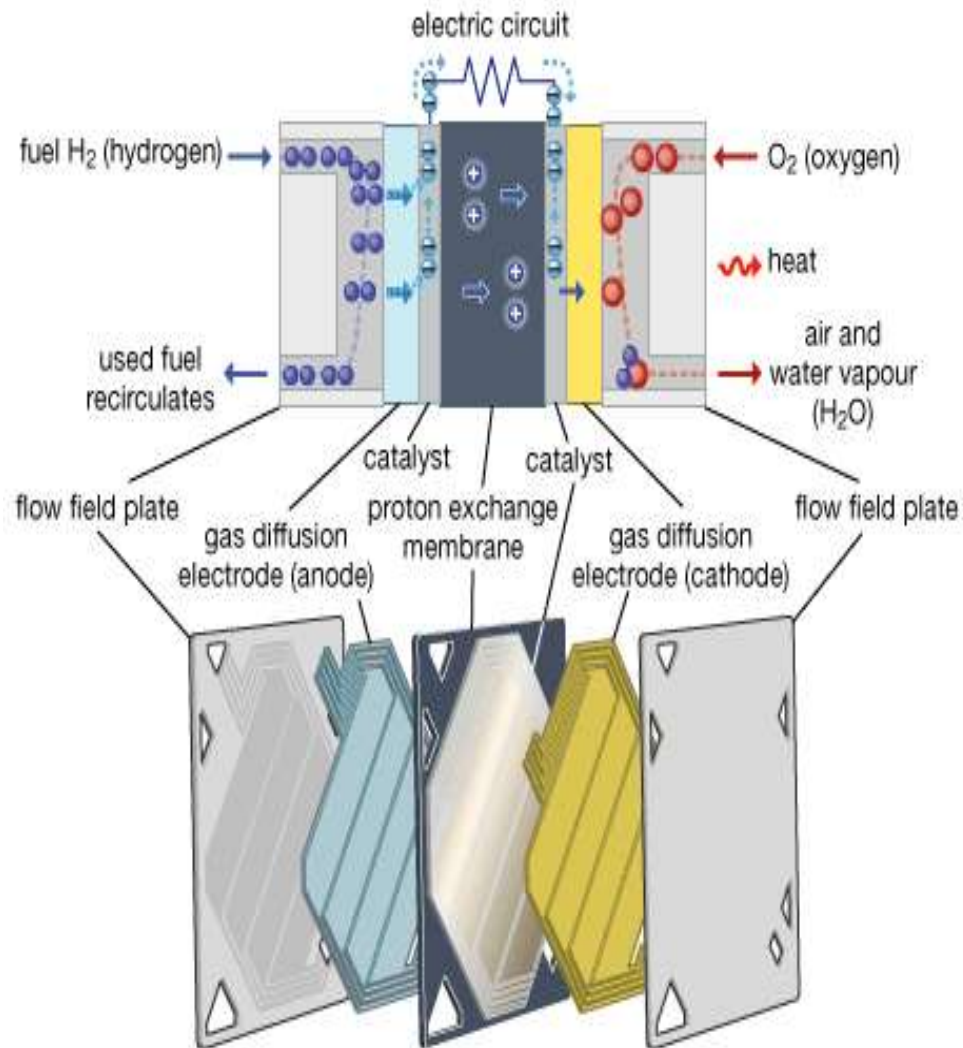

© 2007 Encyclopædia Britannica, Inc.

APPLICATIONS

- Due to their light weight, PEMFCs are most suited for transportation applications. PEMFCs for busses, which use compressed hydrogen for fuel, can operate at up to 40% efficiency.
- Generally PEMFCs are implemented on busses over smaller cars because of the available volume to host

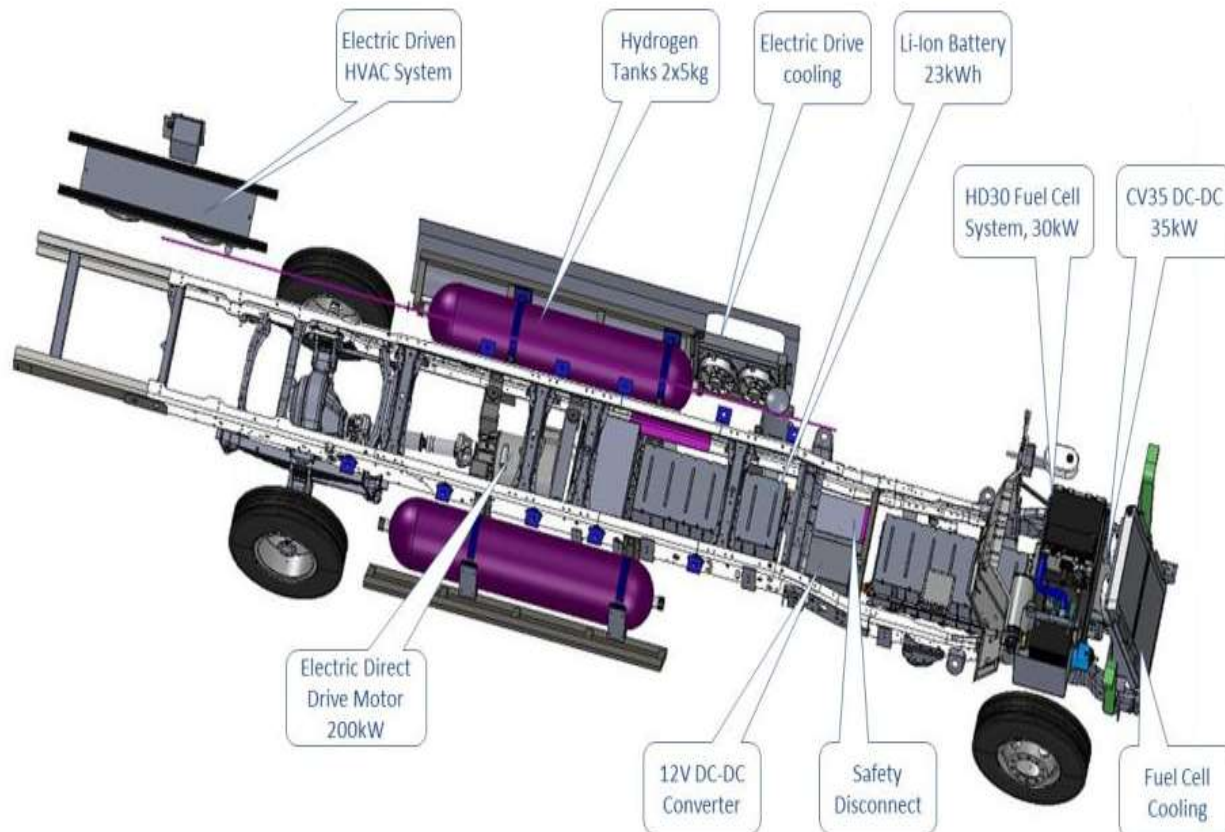

Molten Carbonate Fuel Cell

- These fuel cells are also best suited for large stationary power generators.
- They operate at 600 degrees Celsius, so they can generate steam that can be used to generate more power.
- They have a lower operating temperature than solid oxide fuel cells, which means they don't need such exotic materials.
- This makes the design a little less expensive.
- An electrolyte composed of a molten carbonate salt mixture suspended in a porous, chemically inert ceramic matrix of beta-alumina solid electrolyte (BASE).
- The anode is made from Ni while the cathode is made from nickel oxide.

WORKING

The electrochemical reactions occurring in the cell are:

At the anode:



At the cathode:

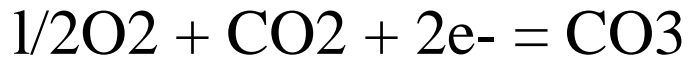

With the overall cell reaction:



CO is not directly used by the electrochemical oxidation, but produces additional H₂ by the water gas shift reaction:

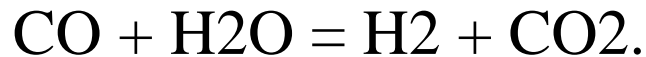

DIAGRAM

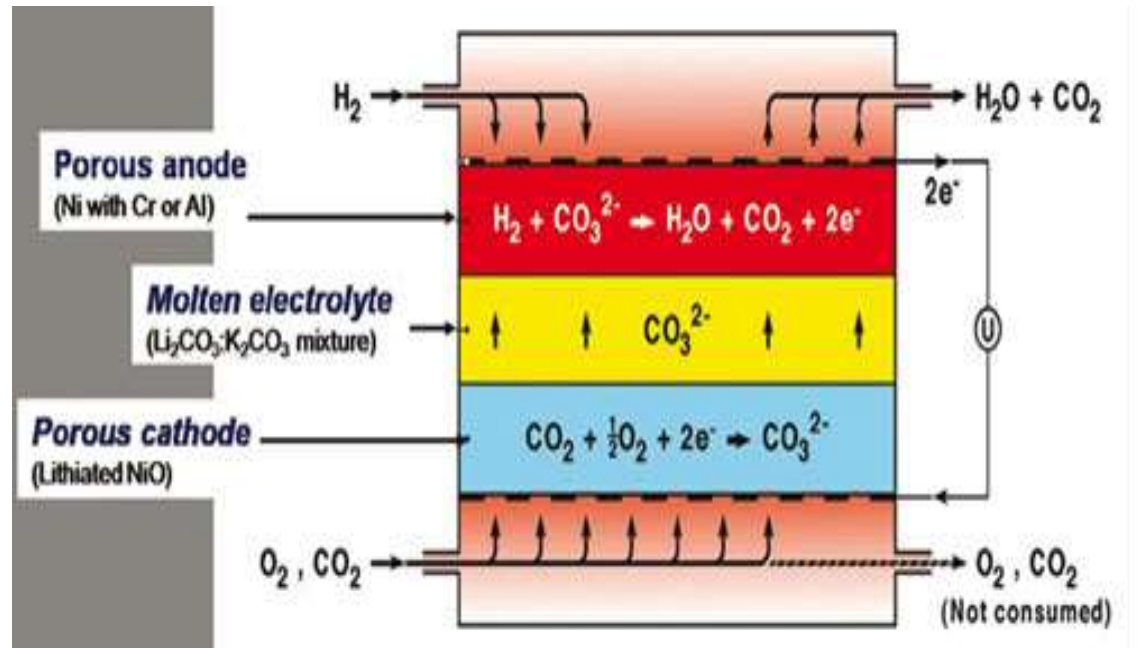
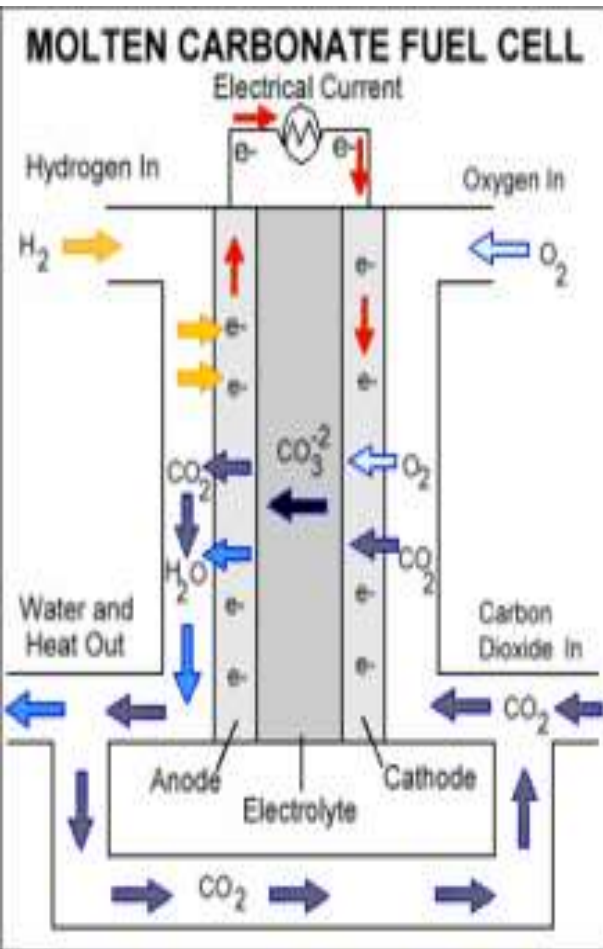

APPLICATI ONS

- Application of Molten Carbonate Fuel Cell (MCFC) has been developed by the European-funded MC WAP research project to be eventually used as an alternative power supply for ships.
- This will be cleaner and avoid the pollution of the marine diesel engines which currently provide the power in the vast majority of



SOLID OXIDE FUEL CELLS

- These fuel cells are best suited for large-scale stationary power generators that could provide electricity for factories or towns.
- This type of fuel cell operates at very high temperatures (between 700 and 1,000 degrees Celsius).
- This high temperature makes reliability a problem, because parts of the fuel cell can break down after cycling on and off repeatedly.
- However, solid oxide fuel cells are very stable when in continuous use.
- In fact, the SOFC has demonstrated the longest operating life of any fuel cell under certain operating conditions.
- The high temperature also has an advantage: the steam produced by the fuel cell can be channeled into turbines to generate more electricity.

This process is called co-generation of heat and power (CHP) and it improves the overall efficiency of the system

- The ceramic anode layer must be very porous to allow the fuel to flow towards the electrolyte.
- The most common material used is a cermet made up of nickel mixed with the ceramic material that is used for the electrolyte in that particular cell, typically YSZ (yttria stabilized zirconia) nanomaterial-based catalysts, this YSZ part helps stop the grain growth of nickel.
- The electrolyte is a dense layer of ceramic that conducts oxygen ions. Its electronic conductivity must be kept as low as possible to prevent losses from leakage currents.
- Popular electrolyte materials include yttria-stabilized zirconia (YSZ) (often the 8% form Y8SZ), scandia stabilized zirconia (ScSZ) (usually 9 mol% Sc₂O₃ – 9ScSZ) and gadolinium doped ceria (GDC).
- Lanthanum strontium manganite (LSM) is the cathode material of choice for commercial use because of its compatibility with doped zirconia electrolytes.

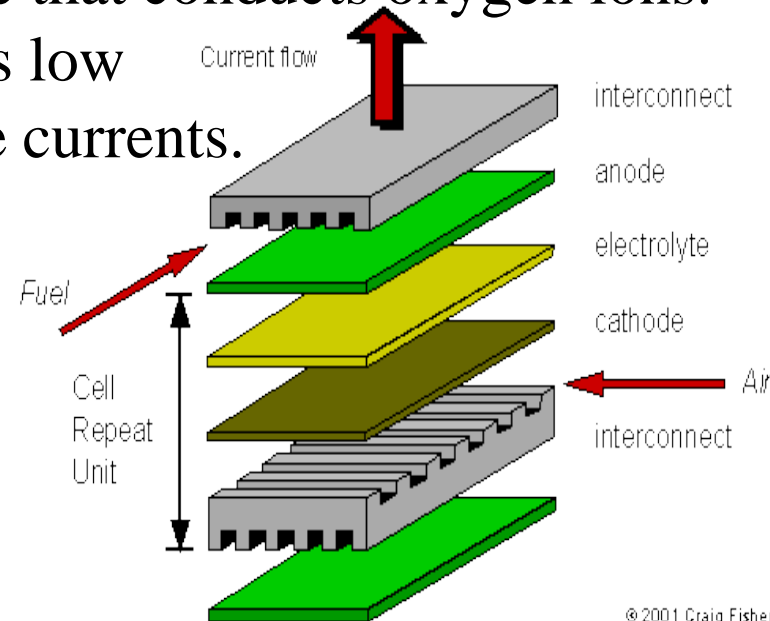

FORMATION OF CERAMIC LAYER

- The ceramic layer used for the SOFC is prepared by a method called thin film deposition or slurry or suspension deposition.
- Thin Film Deposition is the technology of applying a very thin film of material – between a few nanometers to about 100 micrometers, or the thickness of a few atoms – onto a “substrate” surface to be coated, or onto a previously deposited coating to form layers.
- Thin Film Deposition manufacturing processes are at the heart of today’s semiconductor industry, solar panels, CDs, disk drives, and optical devices industries.
- Thin Film Deposition is usually divided into two broad categories: Chemical Deposition and Physical Deposition.

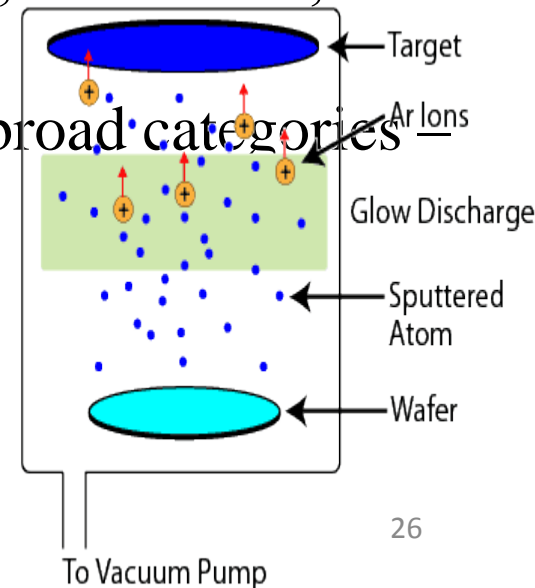

CHEMICAL DEPOSITION

- Chemical Deposition is when a volatile fluid precursor produces a chemical change on a surface leaving a chemically deposited coating.
- One example is Chemical Vapor Deposition or CVD used to produce the highest-purity, highest-performance solid materials in the semiconductor industry today.

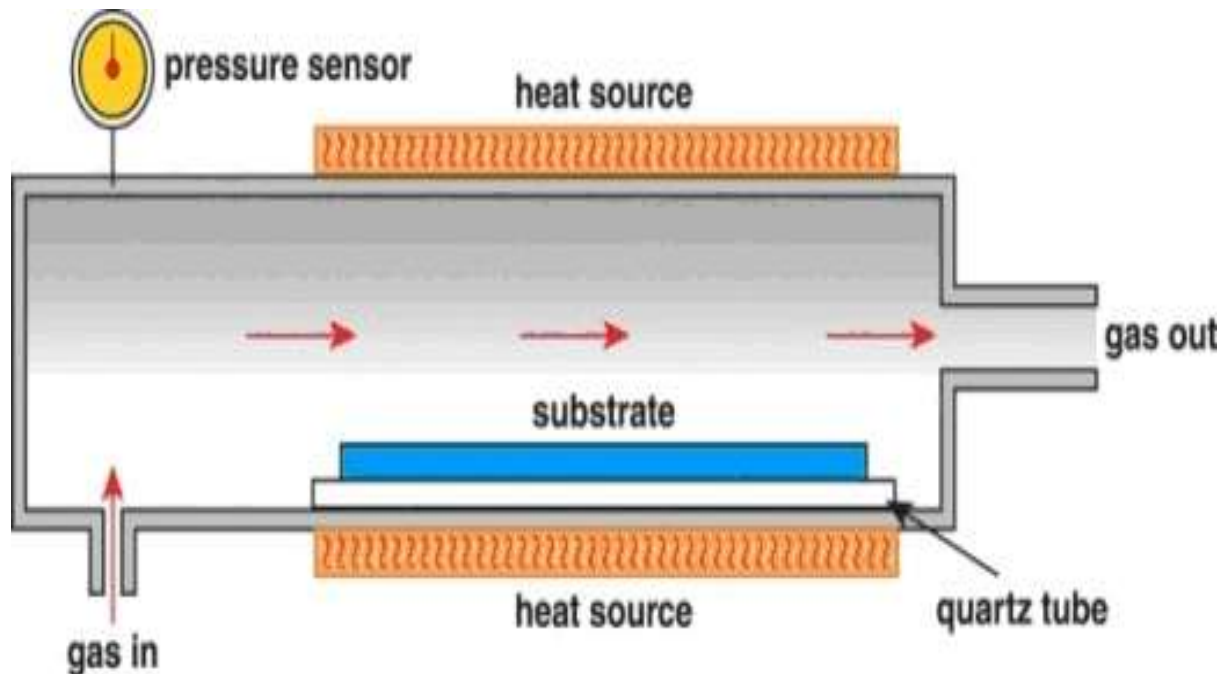

PHYSICAL DEPOSITION

- Physical Deposition refers to a wide range of technologies where a material is released from a source and deposited on a substrate using mechanical, electromechanical or thermodynamic processes.
- The two most common techniques of Physical Vapor Deposition or PVD are Evaporation and Sputtering.
- Thermal Evaporation involves heating a solid material that will be used to coat a substrate inside a high vacuum chamber until it starts to boil and evaporates producing vapor pressure.
- Inside the vacuum chamber, even a relatively low vapor pressure is sufficient to raise a vapor cloud. This evaporated material now constitutes a vapor stream which the vacuum allows to travel without reacting or scattering against other atoms.
- It traverses the chamber and hits the substrate, sticking to it as a coating or thin film.

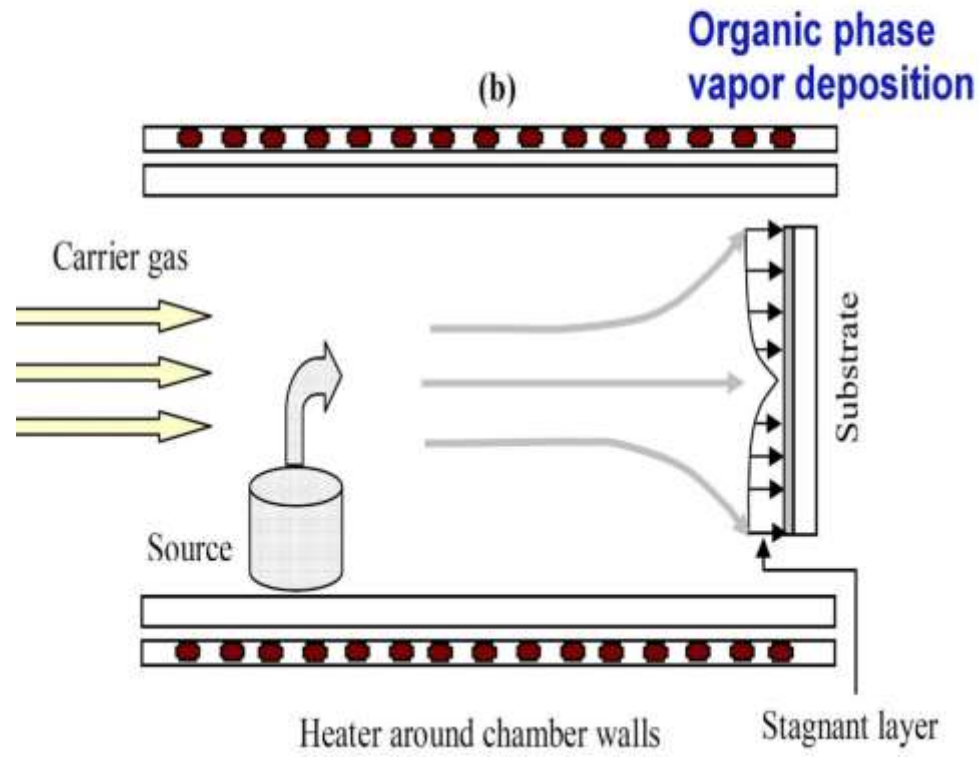
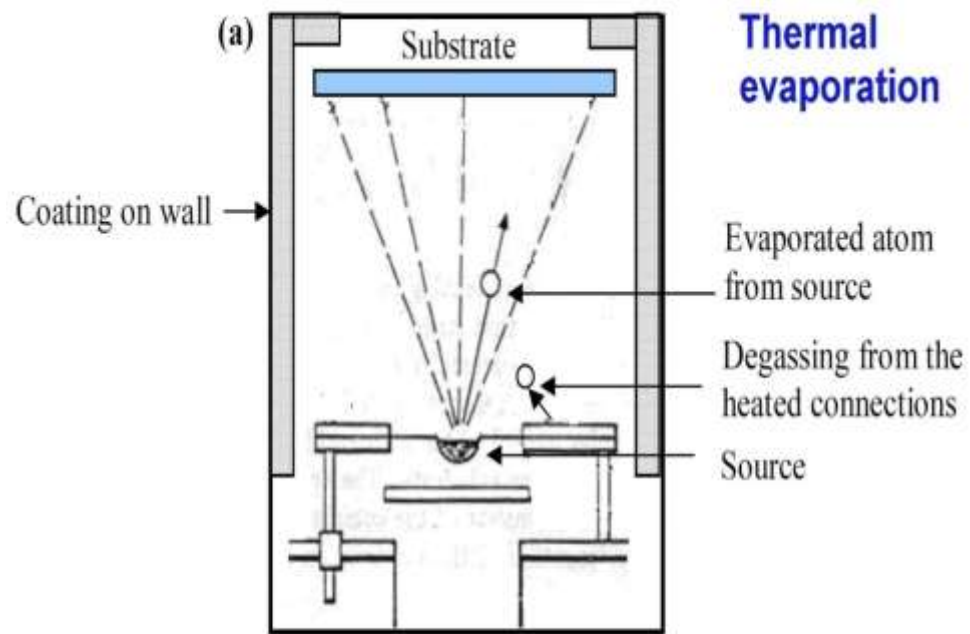

- Sputtering involves the bombardment of a target material with high energy particles that are to be deposited on a substrate like a silicon wafer or solar panel. \
- The substrates to be coated are placed in a vacuum chamber containing an inert gas – usually Argon – and a negative electric charge is placed on the target

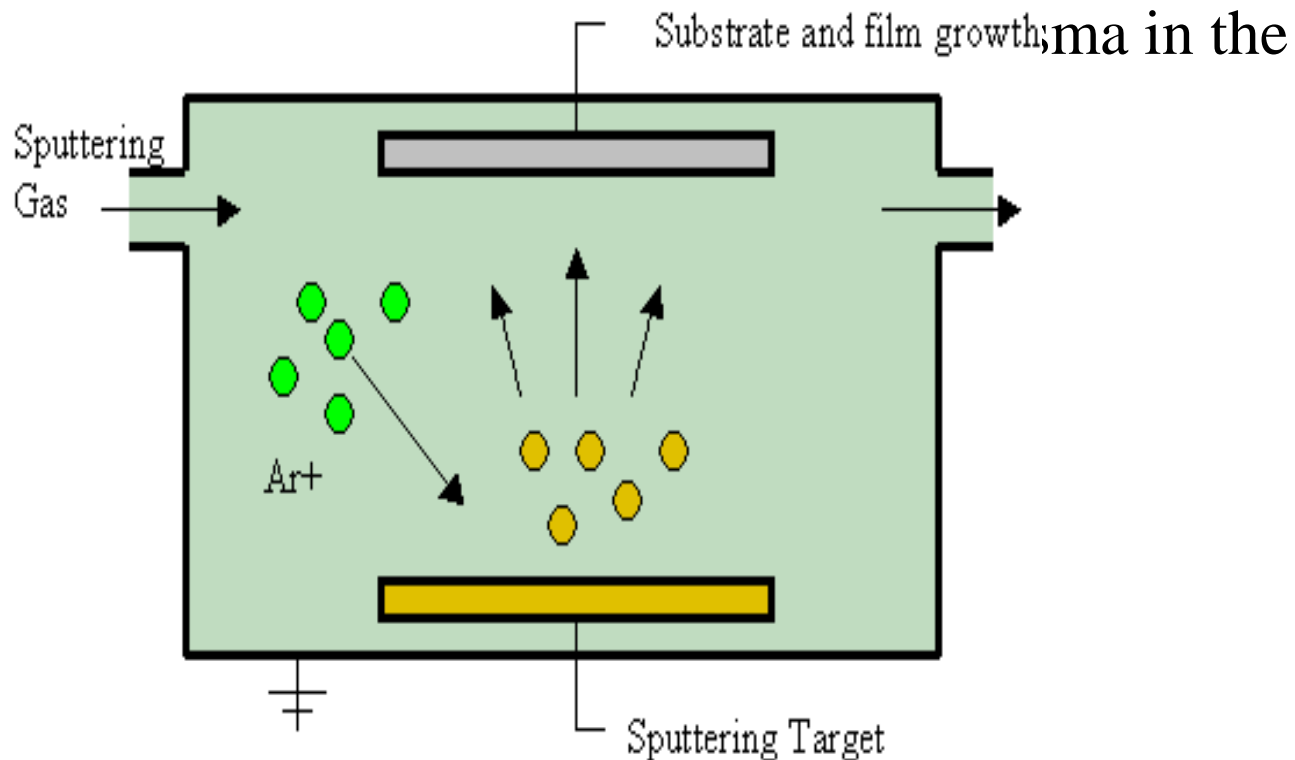

- Certain processing technique such as thin film deposition can help solve this problem with existing material by:
 - – reducing the traveling distance of oxygen ions and electrolyte resistance as resistance is inversely proportional to conductor length;
 - – producing grain structures that are less resistive such as columnar grain structure;
 - – controlling the micro-structural nano-crystalline fine grains to achieve "fine-tuning" of electrical properties;
 - – building composite with large interfacial areas as interfaces have shown to have extraordinary electrical properties.

APPLICATIONS

- It is used as a power generator for residential as well as commercial purpose.
- It is used to power heavy vehicles like trucks and buses.



REGENERATIVE FUEL CELL

- If a fuel cell is a device that takes a chemical fuel and consumes it to produce electricity and a waste product, an RFC can be thought of as a device that takes that waste product and electricity to return the original chemical fuel
- . Indeed any fuel cell chemistry can be run in reverse, as is the nature of oxidation reduction reactions.
- When you run a fuel cell in reverse, the anode becomes the cathode and the cathode becomes the anode. The mechanics of an electrolyser are best understood using the hydrogen fuel cell as an example.

- In a hydrogen fuel cell, the goal is to consume hydrogen and oxygen to generate water and an electric current that can be used to perform work.
- The oxidation reaction occurs at the anode, breaking down hydrogen H_2 gas into positive hydrogen ions and negative electrons.
- The reduction reaction occurs at the cathode combining hydrogen and oxygen and electrons into water.
- An external wire between the anode and the cathode completes the circuit, allowing electrons to flow from the anode to the cathode. This current can be used to supply useful work.

- By contrast, supplying a current and reversing the polarities of the electrodes in the hydrogen fuel cell results in a regenerative hydrogen fuel cell.
- The electrode that was once the cathode is now the anode, it oxidizes water decomposing it into oxygen gas O_2 , hydrogen ions and electrons.
- The electrode that was once the anode is now the cathode, it reduces hydrogen and electrons into hydrogen gas.
- The external current will have to be supplied from a power source, like a solar cell.

CELL VOLTAGE

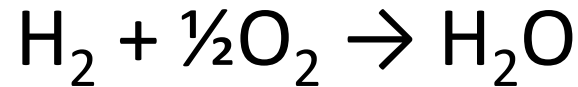

- Conversion of hydrogen and oxygen to water is thermodynamically favorable as Gibbs free energy of products is less than that of reactants.
- Using the equation $\Delta G^\circ = -nFE^\circ$, cell potential of fuel is found to be 1.18V, considering water in liquid phase, and 1.229V considering gaseous phase.
- Cell voltage is also calculated using Nernst Equation.
$$E = E^\circ + \frac{RT}{nF} \ln[\text{oxidised}]/[\text{reduced}]$$
- The cell voltage changes with temperature as Gibbs free energy also changes.

EFFICIENCY OF A FUEL CELL

	H ₂	0.5O ₂	H ₂ O	Change
Enthalpy	0	0	-285.83kJ	$\Delta H = -285.83\text{kJ}$
Entropy	130.68J/K	$0.5 \cdot 205.14\text{J/K} = 102.57\text{J/K}$	69.91J/K	$T\Delta S = -48.7\text{kJ}$
Gibbs Free Energy	0	0	-237.14kJ	$\Delta G = -237.1\text{kJ}$

- For a battery or fuel cell, the maximum work done or work output, is equal to the Gibbs free energy.
- $\eta = \frac{\text{useful output energy}}{\Delta H} = \frac{\Delta G}{\Delta H} = 0.83$, where $\Delta G = \Delta H - T\Delta S = -285.83 + 48.7 = -237.13\text{kJ}$
- The maximum efficiency of a fuel cell can be 83%

EFFICIENCY OF FUEL CELL

- Though maximum efficiency is 83% for a fuel cell, the efficiency of an actual fuel cell is much lesser.
- This can be attributed to three types of losses-
 - Activation polarization – Energy lost in overcoming the activation energy of reaction due to some defects in catalyst.
 - Ohmic polarization – Energy loss due to resistance of the electrolyte.
 - Gas concentration / mass transfer polarization – Energy loss due to inability of reactants to reach the catalyst quickly or efficiently

EFFICIENCY OF FUEL CELL

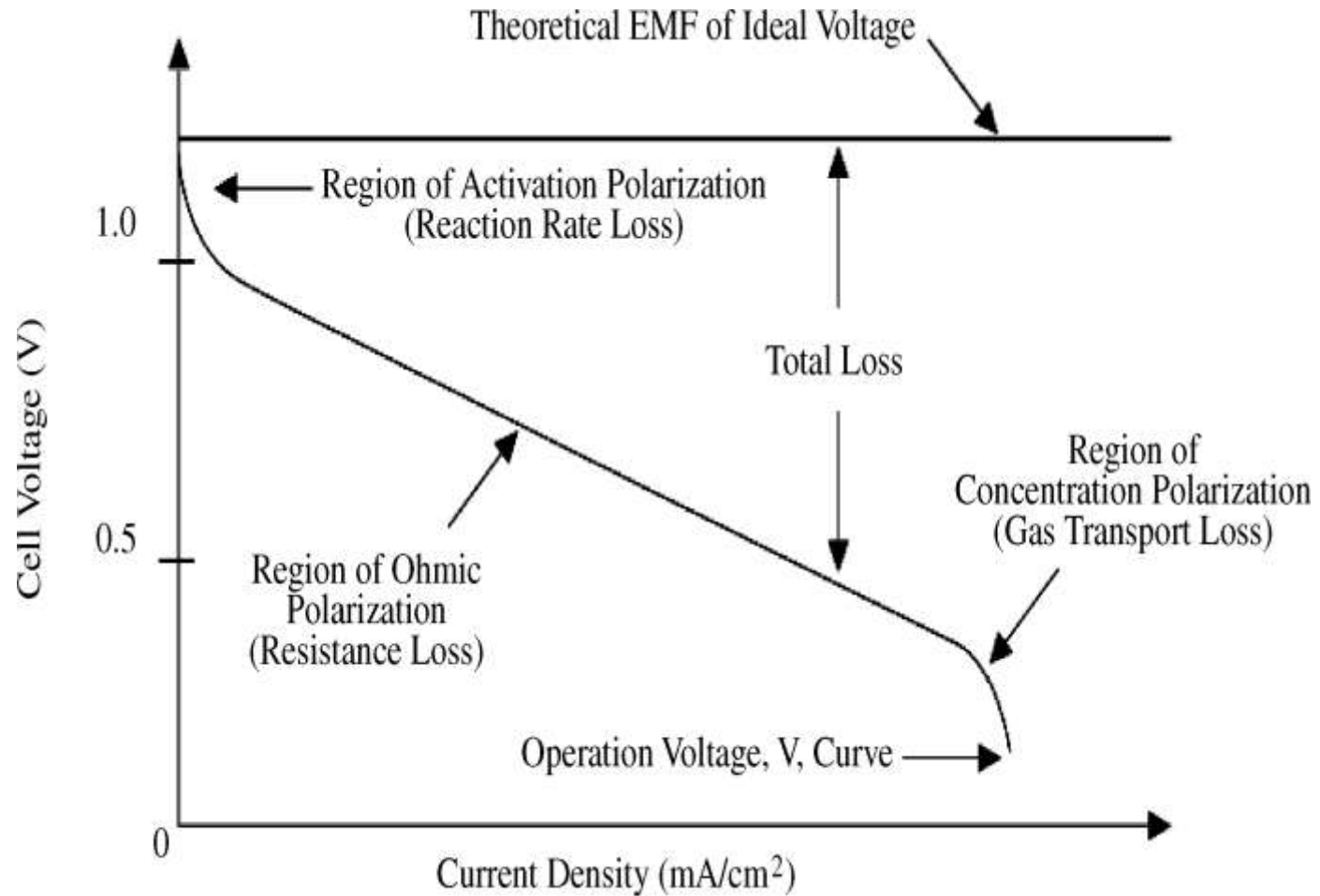

APPLICATIONS

- Solar planes, spacecraft, military UAVs, and cars are just some examples of potential applications of RFC's.
- The NASA All Terrain Hex Limbed Extra Terrestrial Explorer (ATHLETE) is a six legged concept rover designed to be able to navigate the surface of an asteroid and perform analysis and experiments.
- To test the feasibility of using fuel cells for RAPS, the ATHLETE was outfitted with an PEMFC system that could recharge its batteries while the rover was standing still to perform diagnostics, and supply support power during locomotion.
- When the rover needs to recharge, it returns to a hydrogen fueling station that converts solar energy into hydrogen via a regenerative fuel cell.

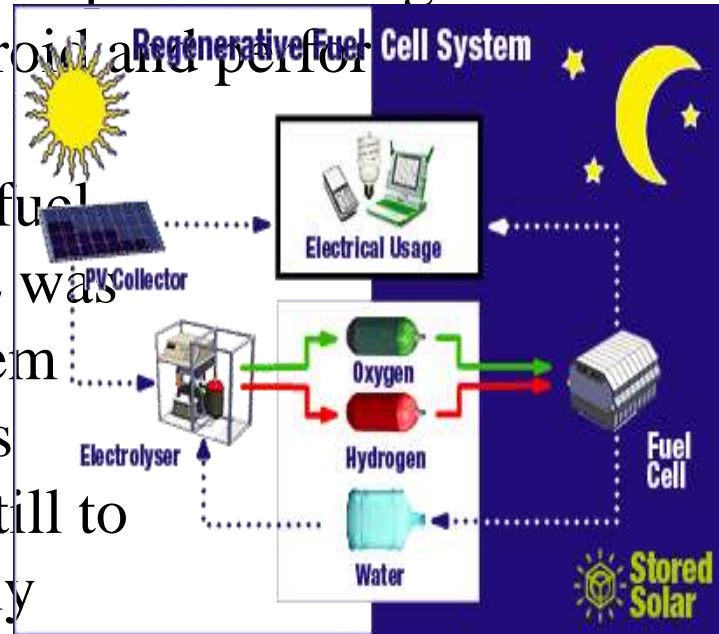

Hydrogen Cars

- One potential application for the URFC is to incorporate it into a hydrogen vehicle. Normally a hydrogen fuel cell car would have to refuel at a hydrogen fueling station.
- The disadvantage here would be providing the infrastructure for hydrogen to be transported to fueling stations.
- A URFC could be incorporated into an electric vehicle and serve as a battery. The car could recharge the URFC by plugging into the electrical power grid at a charging station or personal garage.
- A highly efficient URFC vehicle would probably still need to be refueled at a hydrogen fueling station periodically, but not as often as a conventional fuel cell car or gas powered vehicle.

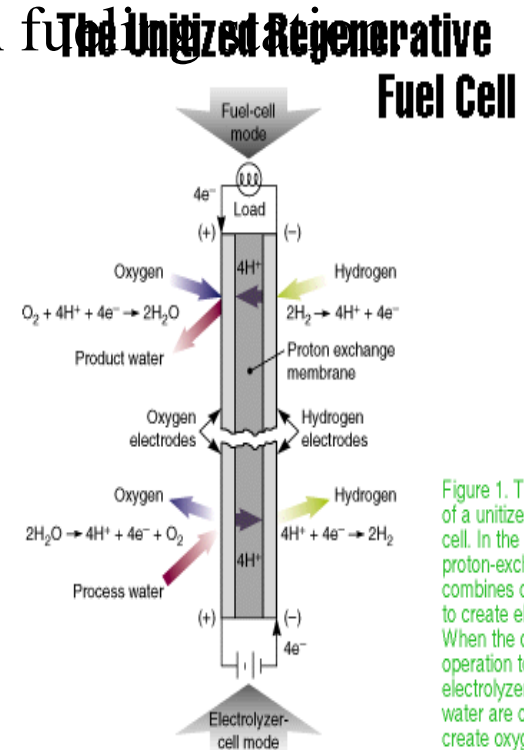

Figure 1. The electrochemistry of a utilized regenerative fuel cell. In the fuel-cell mode, a proton-exchange membrane combines oxygen and hydrogen to create electricity and water. When the cell reverses operation to act as an electrolyzer, electricity and water are combined to create oxygen and hydrogen.

TOYOTA MIRAI

- The Toyota Mirai is a hydrogen fuel cell vehicle, one of the first hydrogen fuel-cell vehicles to be sold commercially.
- The Mirai is based on the Toyota FCV (Fuel Cell Vehicle) concept car.
- The unveiled FCV concept was a bright blue sedan shaped like a drop of water "to emphasize that water is the only substance that hydrogen-powered cars emit from their tailpipes."
- The FCV has a large front grille and oxygen intake for the fuel cell.
- Retail sales in the U.S. began in August 2014 at a price of US\$57,000.
- More about it in phase 2.





DISADVANTAGE OF FUEL CELL

- There is no hydrogen infrastructure to supply coast-to-coast delivery of hydrogen fuel.
- Technologies are being developed to provide alternative fuel storage and delivery methods. SOFCs, MCFCs and PAFCs can internally reform natural gas, providing the perfect solution for industrial use but MCFCs and PAFCs are too large for home and transportation use and SOFCs still have years in development.
- PEMs and AFCs can use fuel reformers to convert hydrocarbons, such as gasoline and natural gas, into hydrogen, but this technology can lower the overall efficiency of the fuel cell by 1/4 and can release small amounts of pollutants
- . Onboard fuel storage and conversion solutions are being developed but they are still years from being perfected.

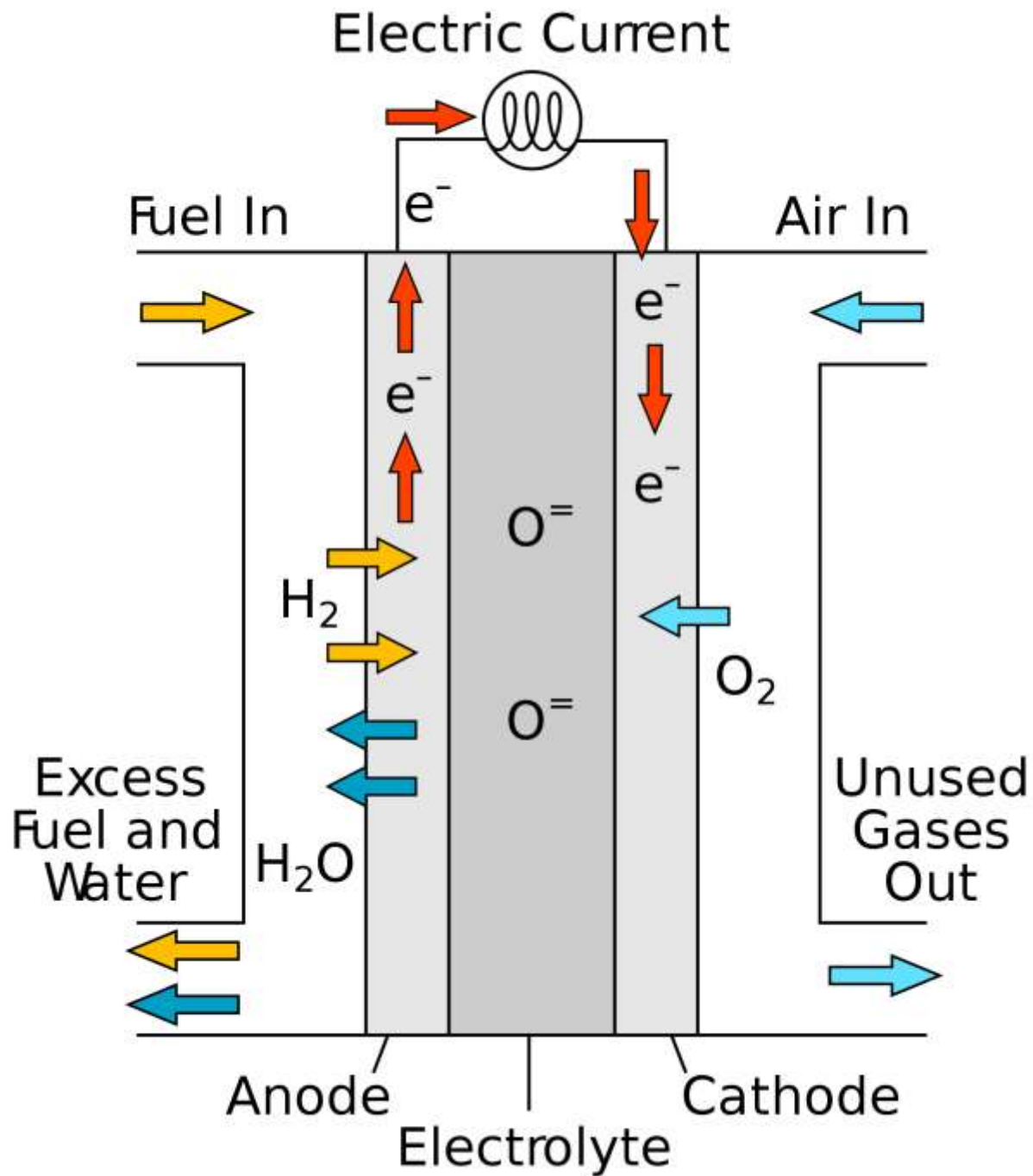

RESEARCH ON HOW TO MAKE FUEL CELLS MORE EFFICIENT

- Renewable energy sources or Co-Ni-Fe catalyst must give hydrogen.
- Ceramic oxide as fuel cell catalyst (reduces temperature)
- 2 way traffic pattern
- For oxidation look at systems used for aerobic oxidation of organic molecules
- Cheaper catalysts like Prussian blue, Ni-Fe or graphene instead of platinum

Temperature

- Low temperature required but with high efficiency.
- Start with high temperature then lower it by recycling exothermic energy
- Low temperature expands choice of materials
- Oxygen- bottleneck
- Bumpy membrane like sandpaper
- Coat membrane with catalyst to usher in ions

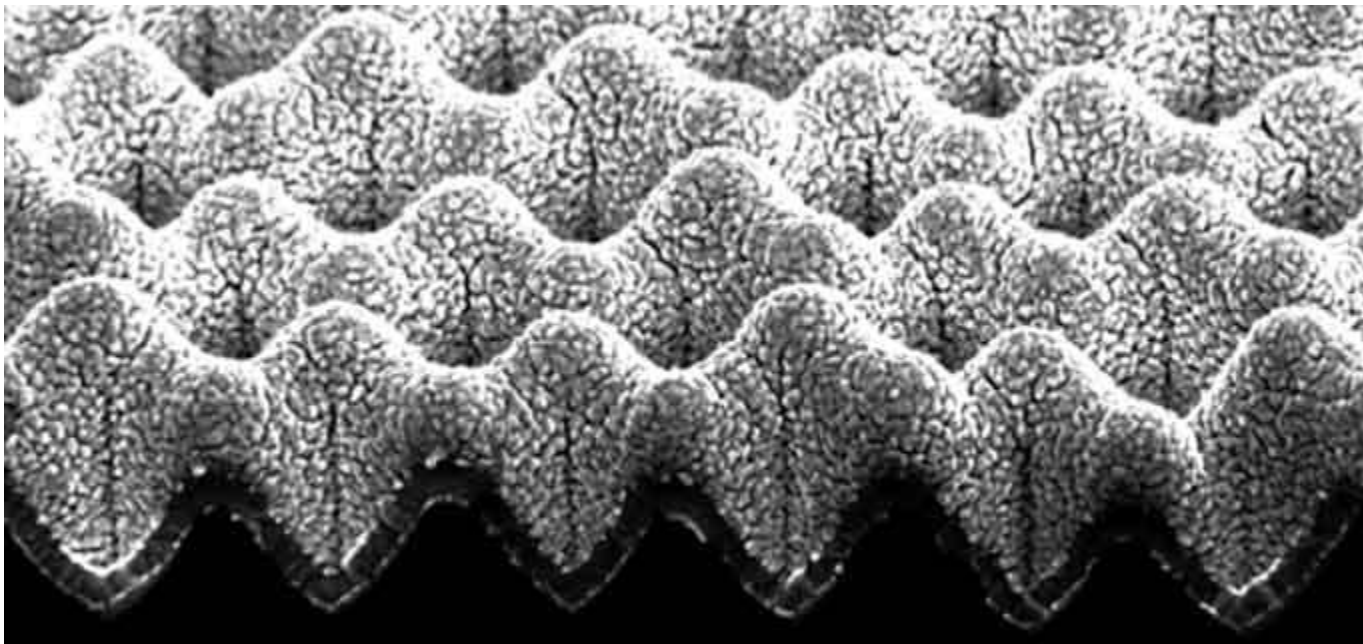

Research on catalyst material

- Atomic scale snapshots using synchrotron
- Visuals of ions flowing through catalytic material.
- Fabrication of better materials can be done
- Route taken within catalyst known
- Observation- more the defects (like missing oxygen atoms), better.
- More vacancies more reactivity, transport and power

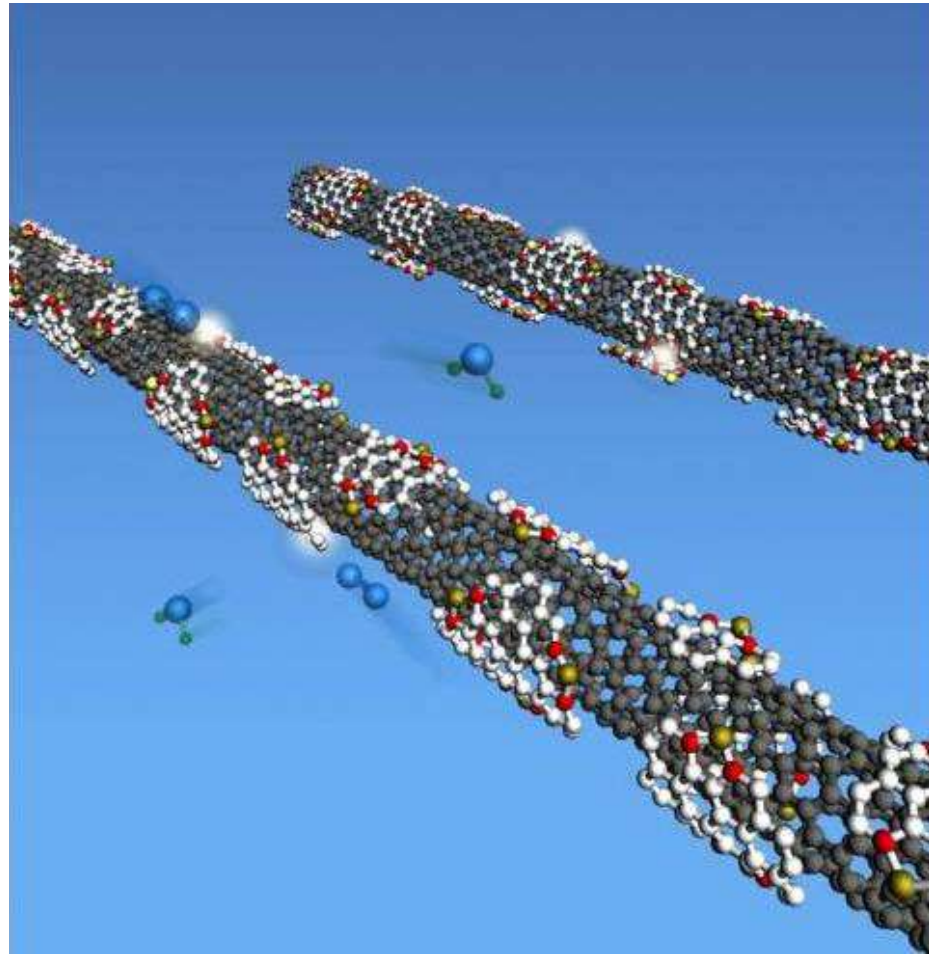

Nano scale

- Atomic layer deposition and nanopatterning to engineer desired properties in electrolytes and electrodes.
- Carbon nanotubes (multi walled) with defects and impurities on outside will replace Pt catalysts
- Clinging outer reaction site and inner has electrical properties
- Fe-Ni (atomic scale imaging and spectroscopy)
- All this possible as graphene is 1 atom thick
- As good as Pt.

SOLAR FUEL CELLS

- Photo catalysis
- Artificial photosynthesis using photosensitive electrode.
- Electrodes - GaP - gallium phosphide nanotubes - 500nm long and 90 nm thick.
- Aqueous solution.
- An attractive visible-light absorber that can generate hydrogen photocatalytically is synthesized by condensation of cyanamide, dicyandiamide, or melamine
- Protons in water are reduced photocatalytically.

Proton (H^+) exchange type

Anion (OH^-) exchange type

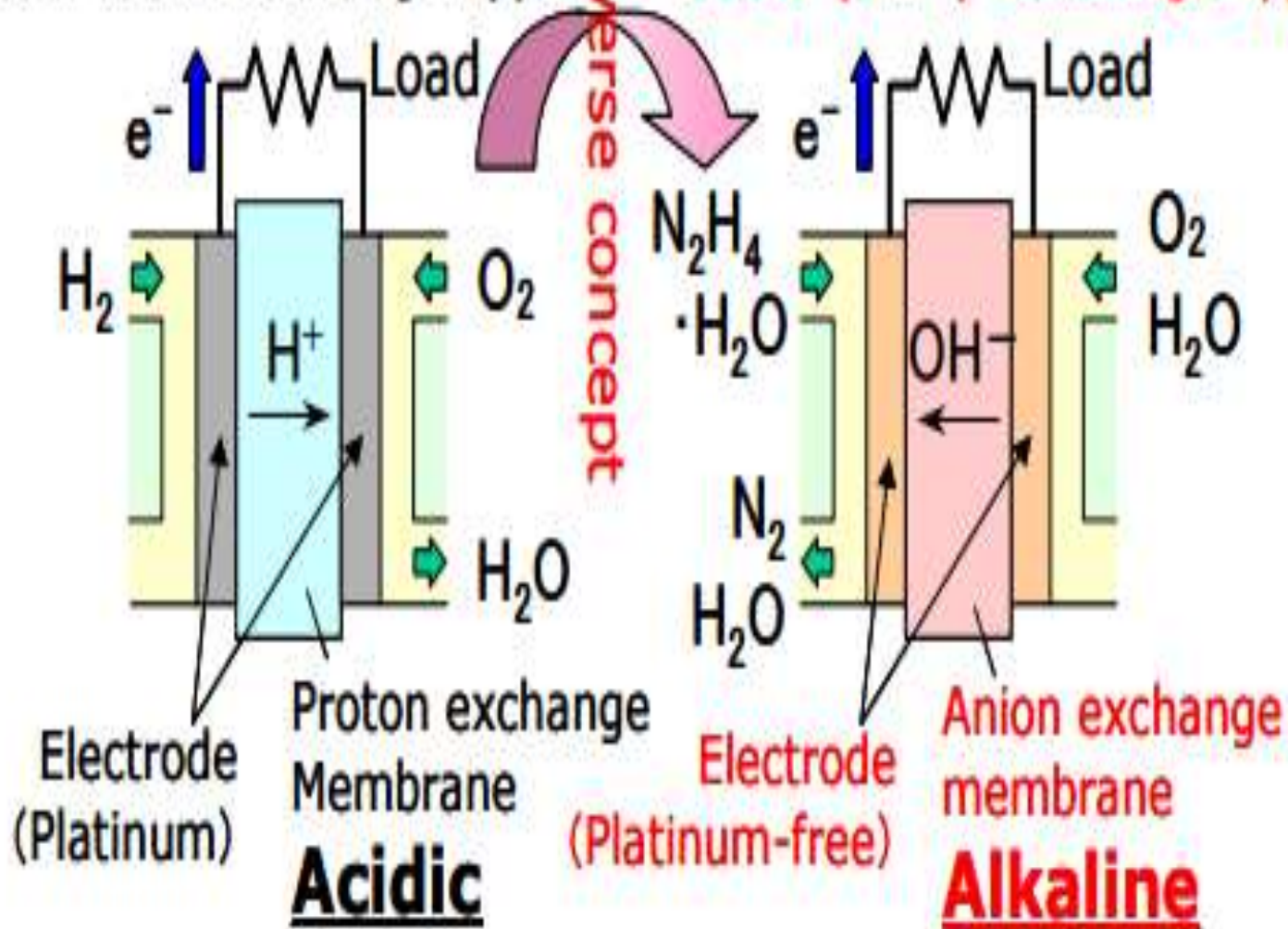

HYDRAZINE FUEL CELL

- Methanol - direct and indirect usage.
- Gives lower voltage though.
- Theoretical voltage- 1.56 volts. But decomposes.
- Carbon monoxide gives high voltage but poisons catalyst.
- Most membranes transport protons, acidic, thus need high quality corrosion resistant membrane - platinum.
- But if hydroxyl ions transported instead, no need of corrosion resistance
- Hydrazine spontaneously explodes upon contact with calcium oxide, barium oxide, iron oxides, copper oxide, chromate salts, and many others.
- Special coatings applied to counteract like nitrates, permanganates.

Continued

- Less reactive hydrogen hydrate - 64% solution of hydrazine.
- Stored in tank filled with granulated polymer embedded with carbonyl group.
- Reacts to form hydrazone relatively safer.
- Adding warm water produced hydrazine hydrate
- Produces a cell voltage of 1.56V compared to that of 1.23V of hydrogen
- The electrochemical properties of hydrazine in alkaline solutions have been studied over the last three decades.

Continued

- Electro-oxidation of hydrazine (and hydrazine derivatives) with the nickel and cobalt showed the highest catalytic activity.
- However, in that study, copper was found not to be a good catalyst.
- Nickel boride Ni₂B also an active catalyst.
- Silver catalyst used for oxygen.
- Reaction $\text{NH}_2\text{-NH}_2 + 4\text{OH}^- \rightarrow \text{N}_2 + 4\text{H}_2\text{O} + 4\text{e}^-$
- $\text{O}_2 + 4\text{e}^- + 2\text{H}_2\text{O} \rightarrow 4\text{OH}^-$
- Electrolyte - different concentrations of KOH solution

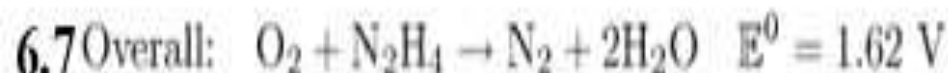
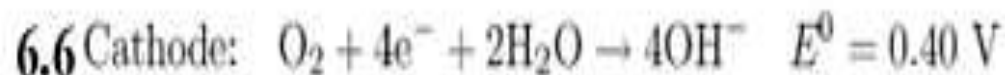
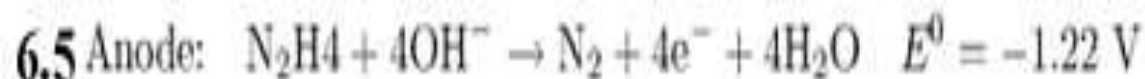

$\Delta G^0 = 623.5 \text{ kJ/mol} = 1.62 \text{ eV}$ $-\Delta H^0 = 534.2 \text{ kJ/mol} = 1.39 \text{ eV}$

DAIHATSU fuel cell development

- FC ShoCase, designed specifically to show-off the possibilities of the fuel-cell power plant.
- Since conventional fuel cells (proton-exchange type) use strongly acidic electrolyte membranes, platinum, which possesses excellent corrosion resistance, is the only material that can be used as the electrode catalyst.
- By reversing this conventional model and utilizing an alkaline anion exchange fuel cell Daihatsu succeeded in eliminating platinum from the electrode catalyst, replacing it with an inexpensive metal (cobalt, nickel, etc.), which could not be used before due to low corrosion resistance.

Continued

- By using hydrazine hydrate, which consists of only hydrogen and nitrogen, as the fuel
- and developing new materials for the electrode catalyst
- Daihatsu achieved both an output density of 0.50 W/cm², which is comparable to the output of a hydrogen fuel cell, and zero emissions, with water and nitrogen being the only substances emitted.
- Hydrazine hydrate is a liquid fuel, easy to handle during filling and its energy density is high.
- Furthermore, as an environmentally friendly synthetic fuel, hydrazine hydrate results in no CO₂ emissions at all.

Continued

- At the same time, high-concentration hydrazine hydrate is designated as a poisonous substance (over 30% concentration) and it must be handled under the same safety standards applicable to gasoline and most industrial chemicals.
- With the objective of ensuring safe use, Daihatsu developed a technology that fixes the hydrazine hydrate inside the fuel tank through the use of a polymer, minimizing the adverse effects that any dispersed fuel could have on humans or the environment should the fuel tank be damaged during a collision, for example, but that makes the required amount of liquid hydrazine hydrate available in a timely manner for electricity generation in the fuel cell.

THANKYOU