



Indian Roads Congress
Special Publication 50

**GUIDELINES ON URBAN
DRAINAGE**

New Delhi 1999

**Indian Roads Congress
Special Publication 50**

**GUIDELINES ON URBAN
DRAINAGE**

**Published by
THE INDIAN ROADS CONGRESS**

*Copies can be had from
The Secretary, Indian Roads Congress,
Jamnagar House, Shahjahan Road,
New Delhi-110011*

NEW DELHI 1999

**Price Rs.160/-
(plus packing and
postage)**

IRC:SP:50-1999

First published : August, 1999

(Rights of Publication and of Translation are reserved)

Printed at Dot Security Press Pvt. Ltd., Naraina Indl. Area Phase I,
New Delhi-110028 (1000 copies)

CONTENTS

	<i>Page No.</i>
Composition of Highway Specifications & Standards Committee	(i) to (iii)
Background	1
1. Introduction	2
2. Scope	4
3. Road Drainage	4
4. Storm Water Drainage Design	11
5. Drainage System and Appurtenances	23
6. Drainage of Special Locations	32
7. Maintenance of Drains	43
8. Sub Surface Drainage	51

**MEMBERS OF THE HIGHWAY SPECIFICATIONS AND
STANDARDS COMMITTEE
(As on 4.11.97)**

- | | | |
|-----|---|--|
| 1. | Shri A.D. Narain
(Convenor) | Director General (Road Dev.) & Addl. Secy. to the Govt. of India, Ministry of Surface Transport (Roads Wing), Transport Bhavan, NEW DELHI-110001 |
| 2. | Shri Indu Prakash
(Member-Secretary) | Chief Engineer (R), S&R
Ministry of Surface Transport (Roads Wing), Transport Bhavan, NEW DELHI-110001 |
| 3. | Shri J.B. Mathur | Chief Engineer (Planning)
Ministry of Surface Transport (Roads Wing), Transport Bhavan, NEW DELHI-110001 |
| 4. | Shri Nirmal Jit Singh | Chief Engineer (T&T)
Ministry of Surface Transport, (Roads Wing), Transport Bhavan, NEW DELHI-110001 |
| 5. | Prof. Gopal Ranjan | Pro Vice Chancellor & Prof. of Civil Engg.,
University of Roorkee, ROORKEE-247667 |
| 6. | Dr. A.K. Gupta | Director, Central Road Res. Institute, P.O. CRR I,
Delhi-Mathura Road, NEW DELHI-110020 |
| 7. | Dr. L.R. Kadiyali | Chief Consultant, Dr.L.R. Kadiyali & Associates,
S-487, IIInd Floor, Greater Kailash-I, NEW DELHI-48 |
| 8. | Maj.Gen. C.T. Chari | Director General (Works), Engineer-in-Chief's
Branch, Army Hqrs., Kashmir House, DHQ P.O.,
NEW DELHI-110011 |
| 9. | Shri H.P. Jamdar | Secretary to the Govt. of Gujarat, R&B Department,
Sardar Bhavan, Block No. 14, Sachivalaya,
GANDHINAGAR-382010 |
| 10. | Shri P.D. Wani | Secretary (Works), Public Works Department,
Mantralaya, MUMBAI-400032 |
| 11. | Shri S.C. Sharma | Chief Engineer,
Ministry of Surface Transport (Roads Wing),
Transport Bhavan, NEW DELHI-110001 |
| 12. | Shri. M.V. Patil | Secretary, P.W.D., Mantralaya, MUMBAI-400032 |
| 13. | Maj. C.R. Ramesh | Secretary to the Govt. of Karnataka P.W.D.,
Room No. 610, 6th Floor, Multistoried Building,
Dr. Ambedkar Road, BANGALORE-560001 |
| 14. | Shri J.C. Bhandari | Chief Engineer (Mech.)
Ministry of Surface Transport (Roads Wing),
Transport Bhavan NEW DELHI-110001 |

IRC:SP:50-1999

15. Shri P.K. Sah Dy. Director General (Design & Specification Cell)
Directorate General Border Roads, Kashmir House,
DHQ P.O. NEW DELHI-110011
16. Prof. A.K. Sharma Head of Deptt. of Transport Planning,
School of Planning & Architecture, 4, Block B,
I.P. Estate, NEW DELHI-110002
17. Shri O.P. Agarwala Chief Engineer (B) S&R
Ministry of Surface Transport, (Roads Wing),
Transport Bhavan, NEW DELHI-110001
18. Shri V. Murahari Reddy Engineer-in-Chief, R&B Department, A&E,
Errum Manzil, HYDERABAD-500082
19. Shri K.B.Lal Singhal Engineer-in-Chief, Haryana Public Works Deptt.,
B&R, Sector 19-B, CHANDIGARH-160019
20. Shri S.C. Pandey Chief Engineer (NH), M.P. Public Works
Department, 'D' Wing, 1st Floor, Satpura Bhavan,
BHOPAL-462004 (Madhya Pradesh)
21. Shri P.D. Agarwal Chief Engineer (National Highways), U.P. Public
Works Department, 3, PWD Quarters, Kabir Marg,
Clay Square, LUCKNOW-226001
22. Shri R.K. Sharma Engineer-in-Chief, Public Works Department,
U.S. Club, SHIMLA-171001
23. Shri D.N. Banerjee The Engineer-in-Chief & Ex-Officio Secy.,
Public Works Department, G Block (2nd Floor),
Writers' Buildings, CALCUTTA-700001
24. Shri R.L. Koul Member National Highway Authority of India,
1, Eastern Avenue, Maharani Bagh,
NEW DELHI-110065
25. Shri K.B. Rajoria Engineer-in-Chief, PWD, Govt. of Delhi
K.G. Marg, NEW DELHI-110001
26. Shri Vinod Kumar Director & Head, Civil Engg. Department,
Bureau of Indian Standards, Manak Bhavan,
9, Bahadur Shah Zafar Marg, NEW DELHI-110002
27. Prof. G.V. Rao Deptt. of Civil Engg., I.I.T., Delhi Hauz Khas,
NEW DELHI-110016
28. Dr. O.P. Bhatia Dy. Director & Head, Civil Engg. Department,
G.S.I.T.S., H-55, M.I.G., INDORE-452008
29. Shri D.P. Gupta DG(RD), MOST (Retd.) E-44,
Greater Kailash (Part I) Enclave, NEW DELHI-110048

- | | | | |
|-----|---|---|--------------|
| 30. | Shri K.K. Sarin | DG(RD), MOST (Retd.), S-108, Panchshila Park,
NEW DELHI-110017 | |
| 31. | Prof. C.G. Swaminathan | 'Badri', 50, Thiruvangadam Street, R. A. Puram,
CHENNAI-600028 | |
| 32. | Prof. C.E.G. Justo | Emeritus Fellow 334, 25th Cross, 14th Main,
Banashankari 2nd Stage, BANGALORE-560070 | |
| 33. | Prof. N. Ranganathan | Head of Deptt. of Transportation Plg., SPA(Retd.)
Consultant, 458/C/SFS, Shaikh Sarai I,
NEW DELHI-110017 | |
| 34. | Shri M.K. Agarwal | Engineer-in-Chief (Retd.), House No. 40, Sector 16,
PANCHKULA-134109 | |
| 35. | Dr. A.K. Bhatnagar | Executive Director, Indian Oil Corporation Ltd.,
(R&D Centre), Sector-13, FARIDABAD-121007 | |
| 36. | The Chief Engineer | National Highway, Assam Public Works Department,
Dispur, GUWAHATI-781006 | |
| 37. | The Director | Highways Research Station, 76, Sarthat Patel Road,
CHENNAI-600025 | |
| 38. | The President
Indian Roads Congress | H.P. Jamdar,
Secretary to the Govt. of Gujarat,
R&B Department, Gandhinagar | - Ex-Officio |
| 39. | The Director General
(Road Development), | Ministry of Surface Transport
(Roads Wing), New Delhi
(A.D. Narain), | - Ex-Officio |
| 40. | The Secretary
Indian Roads Congress | (S.C. Sharma),
Chief Engineer, MOST | - Ex-Officio |

CORRESPONDING MEMBERS

- | | | | |
|----|----------------------|--|--|
| 1. | Dr. Yudhbir | House No. 642, IIT Campus, P.O. IIT, KANPUR-208016 | |
| 2. | Dr. V.M. Sharma | Consultant, AIMIL, A-8, Mohan Cooperative Industrial
Estate, Naimex House, Mathura Road, NEW DELHI-44 | |
| 3. | Dr. S. Raghava Chari | Emeritus Professor JNTU, H.No. 16-11-20/5/5,
Dilsukhnagar-3, HYDERABAD-500036 | |
| 4. | Shri N.V. Merani | Past President, IRC, A-47/1344, Adarshnagar,
Worli, Mumbai-400025 | |

GUIDELINES ON URBAN DRAINAGE

BACKGROUND

0.1. The Drainage Committee (H-4) was constituted by the Indian Roads Congress to look into various aspects of the Drainage System. The newly constituted Committee decided to prepare Guidelines/Manual on Road Drainage, Airfield Pavement Drainage, Urban Road Drainage and Cross Drainage Works. During the first meeting of the Committee (Personnel given below), held on 18.10.94, the Committee constituted a Subgroup headed by Shri H.K. Srivastava as Convenor of the Subgroup to prepare Draft Guidelines on Urban Road Drainage.

DRAINAGE COMMITTEE (H-4)

S.C. Sharma
Kamlesh Kumar

Convenor
Member-Secretary

MEMBERS

Dr. K.L. Bhanot
P.K. Nanda
P.J. Rao
S.I. Patel
D.K. Rastogi
R.C. Gupta
H.K. Srivastava
K.K. Gupta
U.C. Borthakur

Devendra Sharma
Rep. of C.W.C.(Rajesh Kumar)
Rep. of Meteorological Deptt.
(B. Ray)
Rep. of BRDS (S.K. Soni)
Rep. of MCD (P.K. Jain)
The Director, HRS, Madras
Rep. Civil Engg.
Deptt., IIT, New Delhi

The draft prepared by Convenor, Sub-group (members given below) was discussed in various meetings of the Drainage Committee. The draft guidelines finalised by the Convenor, Sub-group incorporating all the points discussed during the meetings were submitted to the Convenor, Drainage Committee (H-4) for further necessary action. The Drainage

Committee authorised Convenor and Member-Secretary during its last meeting held on 30.12.96 to send the draft Guidelines to Highway Specifications & Standards Committee for its approval. Accordingly, the Convenor, Drainage Committee had approved the draft Guidelines on Urban Drainage on 8.9.97 for circulation to HSS Committee.

Shri H.K. Srivastava CE., CPWD	-	Convenor
Shri K.K. Gupta EE, PWD, Haryana	-	Member
Shri D.K. Gupta Rep. of India Meterological Deptt.	-	Member
Shri P.K. Jain CE, M.C.D.	-	Member

The guidelines were discussed and approved by HSS Committee in its meeting held on 4.11.97, the Executive Committee and the Council in their meetings held on 18.4.98 and on 22.5. 1998 respectively.

1. INTRODUCTION

1.1. The importance of adequate and efficient drainage to the structural integrity of a road is well recognised. A drainage problem is caused by an excess of water either on the surface of the pavement or below the surface of the pavement. Thus the road drainage falls into two distinct categories.

- a) Surface water run off - to remove water from areas of carriageway or footpath where its presence would be harmful or dangerous to users or lead to deterioration. The flowing water has capacity to damage the road while flowing down the shoulders and side slopes. In this process, the water causes erosion and again deposits the material causing siltation at other point, both requiring provision of measures to reduce the damage due to each. If the road profile is not correct and conducive to quick drainage, pools of water may form, weakening the pavement course and leading to skidding, hydroplaning or splashing of water, which is a nuisance to other vehicles and may lead to accidents.
- b) Subsoil Drainage - to sustain the stability of pavement support within design tolerances. In many instances, the soil surface may appear dry, although waterlogged soil below subgrade may cause serious damage to the road crust. The water may enter subgrade from groundwater and by infiltration of surface water through the pavement, shoulder and verges. This water is required to be collected by subsurface drainage systems which in turn discharge into a drainage system clear of the road formation. Methods of

investigation for estimating rates of surface water infiltration, ground water levels and flows form an important part of the engineering of a drainage system. The study of pavement drainage for both flexible and rigid pavement has resulted in conclusion that the construction should be treated as a series of permeable layers and added precautions are necessary to protect the subgrade. Use of self draining materials and introduction of membrane has helped to control the migration of fine materials from subgrade (pumping) - as relatively small migration of fines from subgrade into voids in the sub-base can seriously reduce the capacity of the sub-base to act as a lateral drain.

1.2. The urban roads usually are in flat terrain. Urbanisation of the area and intense density of construction needs well planned drainage. Roads and Highways do not have a distinctly separate drainage system. Water from the road joins the road side drain through inlets or gratings. For effective drainage this should join the peripheral drains which in turn should join the main or trunk drain for ultimate discharge to the natural drain. It would be necessary to have division of urban area into drainage basins. Storm water drainage, thus has to take into account alignments, levels on ground and outfall levels. Existing drains pass through highly developed and thickly populated areas. As such there may be a problem of availability of land for increasing the capacity of drains further. Besides, these drains should be able to cater to the increased discharge due to new colonies and urbanisation. An important aspect of such drain is to ensure a good velocity in the drain not only when the drain is flowing full but also when the drain is partially full. Usually silt and other materials collect in the bed in large quantities. The design need to be made to ensure self cleaning velocity during dominant and lean flow conditions also.

1.3. In most of the urban areas, responsibility for design and construction of peripheral and trunk drainage system rests with local bodies, e.g. Municipal Corporation, while that of road side drain with the road construction agency like PWD. For an effective system proper coordination between all concerned agencies is a must.

1.4. Poor drainage results into losses - direct and indirect in the form of damaged roads and reduced serviceability. In spite of this, adequate priority for drainage system is rarely accorded, whether it be in the matter of planning, organisation, fund allocation or monitoring. Funds required for a drainage system are small as compared to the development of infrastructure and the recurring losses which the society and the Government have to suffer from year to year. It is necessary that due priority is given to this area of development and satisfactory arrangements ensured by way of proper design and planning.

1.5. Considering the importance of drainage, the IRC have already brought out **Guidelines on Road Drainage (IRC - Special Publication 42)** in 1994 which primarily deals with guidelines on drainage of non-urban (rural section) roads. Drainage of urban roads requires to deal with many different situation and parameters and as such it was felt necessary to bring out detailed guidelines dealing with drainage of urban roads.

2. SCOPE

The guidelines covered under this publication deal with drainage of Urban roads running though plain and rolling areas. The aspects covered are influence of road features, ground level, out fall level on the drainage system, internal drainage of pavement structure, drainage of subgrade, surface and subsurface drains. Details of premonsoon drill for desilting of drains, readiness or pumping stations have also been given. The drainage of rural section of roads, hill roads, airfield pavements and cross drainage have not been covered under these guidelines since separate guidelines on these subjects have either been published or are being brought out.

3. ROAD DRAINAGE

3.1. Minimum Longitudinal Gradient

For better internal drainage of pavement layers, especially of granular material, a slight longitudinal gradient is preferable. A minimum longitudinal gradient of 0.3 per cent is adequate for satisfactory drainage (Ref. IRC:SP:42).

3.2. Pavement Cross Slope/Camber

For quick dispersal of precipitation on the road surface it would be necessary that water has to travel least distance through reasonably steep cross slope. However, from the consideration of comfort to the traffic, steep cross slope is objectionable. As such a judicious balance is required to be kept between the two requirements. For urban roads having divided carriageway the camber is unidirectional away from the median. Typical cross section is shown in Figs. 3.1 & 3.2(a) & (b). In case of super elevated sections, either gap in the central verge with suitable adjustment in the levels of the two carriageway or in extreme cases, central drainage arrangement is resorted to. Schematic arrangement is shown in Fig. 3.2 (c).

5

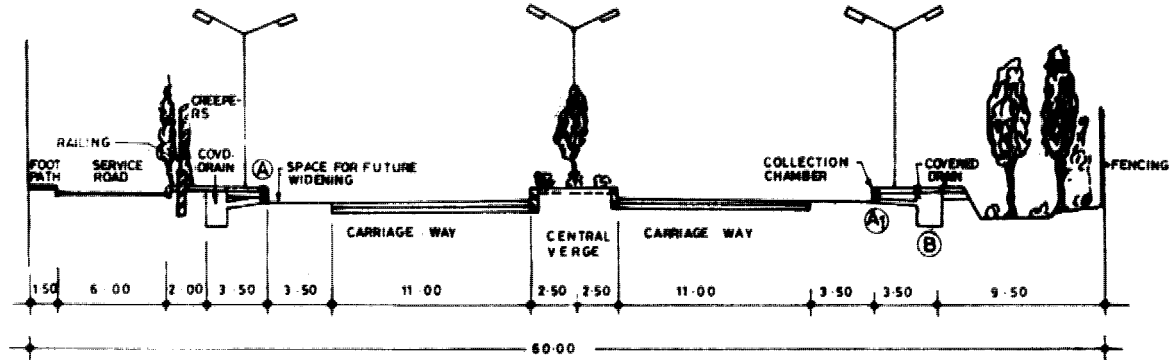

NOTES :-

- a) COLLECTION OF WATER AT (A)
 ALTERNATIVE 1. BELL MOUTH PIPE 250 MM Ø
 ALTERNATIVE 2. COLLECTION CHAMBER A₁ REFER DETAIL FIG. 5-4.
- b) COVERED DRAIN AT LOCATION B MAY BE HUME PIPE / CAST IN SITU / PRECAST CHANNEL

Fig. 3.1. Typical Cross Section of Urban Road
 (Note : All Di.mensions are in Metres)

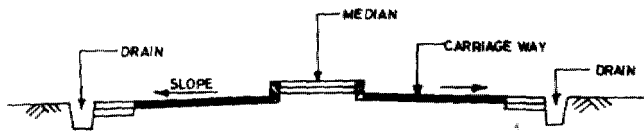

a) SCHEMATIC ARRANGEMENT IN STRAIGHT REACH

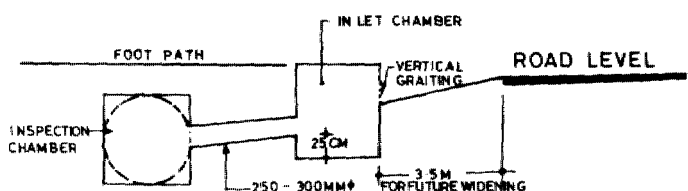

b) SCHEMATIC ARRANGEMENT OF CATCHPIT AND COVERED DRAIN

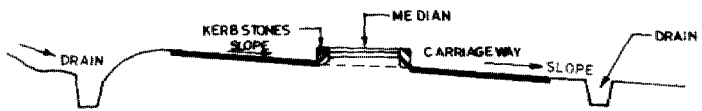

c) SCHEMATIC ARRANGEMENT AT SUPPER ELEVATION THE OPENING IN THE MEDIAN SHOULD BE (PAVED) 60 CM WIDE SPACED AT 2 TO 3 M

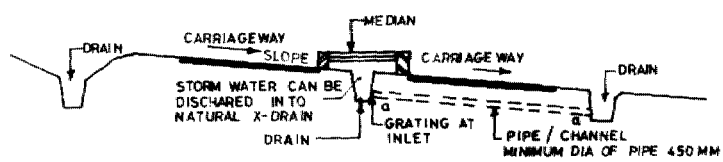

d) SCHEMATIC ARRANGEMENT AT SUPPER ELEVATION WITH CENTRAL DRAINAGE ARRANGEMENT

Fig. 3.2. Schematic Arrangement for Water Collection and Disposal (Contd.)

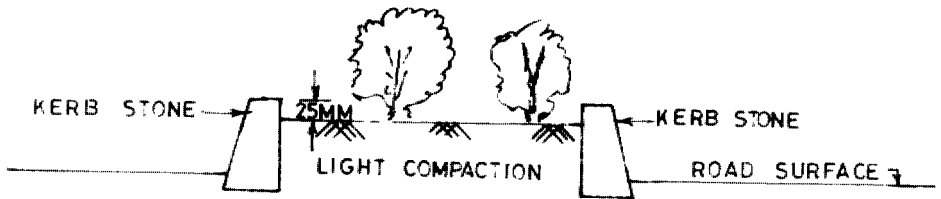

e) EARTH WORK IN MEDIAN

THE SPACING OF PIPE BELOW THE CARRIAGE WAY MARKED a-a
MAY BE BETWEEN 5M. TO 7M.

NOTE :- THE SIZE AND SPACING INDICATED ABOVE ARE TYPICAL
AND COULD BE VARIED AS PER LOCAL CONDITION.

Fig. 3.2. Schematic Arrangement for Water Collection and Disposal

When the road is on gradient, the flow is governed by the resultant slope produced by longitudinal and cross slope. In such case, in order that water travels the least distance on road surface (more the distance more is the quantity of sheet flow causing hydroplaning), the camber should be 0.7 of the longitudinal gradient or the camber values specified in the following table for a particular road surface whichever is higher. In other words, on steep gradients on long length of road, the camber should be increased to get satisfactory drainage conditions.

Special care is also required in detailing the valley curves so that such locations do not collect water.

IRC:86 "Geometric Design Standards for Urban Roads in Plains" recommends the camber or cross slope on straight sections of roads as given in Table 3.1.

Table 3.1. Crossfall/camber values for different road surface types

Surface Type	Cross fall/Camber
Gravelled or WBM surface	2.5 to 3 per cent
Thin bituminous surfacing	2 to 2.5 per cent
High type bituminous surfacing or cement concrete surfacing	1.7 to 2 per cent

Note : Higher value of camber should be adopted in areas with high intensity of rainfall and where ponding is expected due to any reason. Steeper camber should also be provided on kerbed pavements to minimise the spread of surface water.

3.3. Shoulders and Footpath Drainage

For shoulders along unkerbed pavement the cross fall should be atleast 0.5 per cent steeper than that of the pavement subject to the minimum values given below.

WBM surface	3 per cent
Gravel surface	4 per cent
Earth surface	5 per cent

In addition, it is necessary that shoulders are not higher than adjoining pavement surface for quick drainage.

For paved footpaths a cross-fall of 3 to 4 per cent should be adopted. For verges and unpaved areas cross-fall should be 4 to 6 per cent.

Precipitation from the road surface flows towards outer edge of carriageway (except where central drainage arrangement has been provided) into kerb channel where kerb and footpath are provided. The kerb channel should be 30 cm wide with smooth finish and should have a minimum transverse slope of 1 in 6. The longitudinal slope of kerb channel is guided by the road gradient. In reaches where there is no longitudinal gradient in the road, kerb channel should slope towards kerb inlets or bell mouths. The kerb channel discharges its flow into pipes through bell mouth (named after shape) which should be 300 mm dia non pressure RCC pipe placed under footpath at about 10-15 m interval. These pipes discharge into road side drain. The spacing may require to be adjusted depending upon the longitudinal gradient of the road. Refer Fig. 5.5.

3.4. Median Drainage

In urban areas medians are usually less than 5 m width and kerbed except in cases where wider medians are provided as part of future widening. As such medians should be crowned wherever paved or turfed for drainage across the pavement. Care should be taken that earth surface in the median are not sloped to drain on the road as washed away soil may deposit on road pavement making it slippery and accident prone. Earth in median should be 2.5 cm below the kerb.

In locations where carriageway is sloping towards the median, as may be the case where road is in curvature, there are two alternatives for the disposal of rain water.

- a) Water is collected in the manholes within the median provided at an distance of about 15 m by giving a longitudinal slope in the channel on either side of the manhole. The water collected in the manhole is then taken to the main drain on the side of the road through a 450 mm dia RCC pipe across the carriageway on any one side depending upon the site condition. The cover on the pipe should be atleast 300 mm.
- b) The rain water is collected in the median drain through inlets at suitable interval. At intervals rain water could be removed from the median through a drain or pipe across the carriageway to road side drain. Typical arrangement is shown in Fig. 3.2(d).

The system (a) suffers from the disadvantage that every 15 m, a 450 mm diameter pipe drain is provided below the carriageway. In system (b), where large number of cattle cross the road it would be preferable to have either a covered drain or a pipe drain to avoid any cattle getting trapped in the median drain. A 450 mm dia pipe at 5 to 7 m spacing provided below the carriageway is likely to get choked very often.

3.5. Drainage of High Embankment

In high embankments and approaches to bridges/over bridge if the water is allowed to leave the carriageway at undefined spots, it may cause serious damages to the embankment and eventually undermines the pavement. In each location rain water is collected in small manageable quantities through longitudinal kerb channel and brought down through chutes without damage. The chutes may be lined with cement concrete on stable supports and may be located at 10 to 15m intervals depending upon the rainfall and width of carriageway. Stepped outfall may be used in place of chutes. Typical drainage arrangement and typical chute sections and energy dissipation basin have been shown in Fig. 3.3. If the collected water has erosive potential construction of steps or simple energy dissipation structures may need to be provided. For protection of slopes between chutes Ref. IRC:SP:42 "Guidelines on Road Drainage".

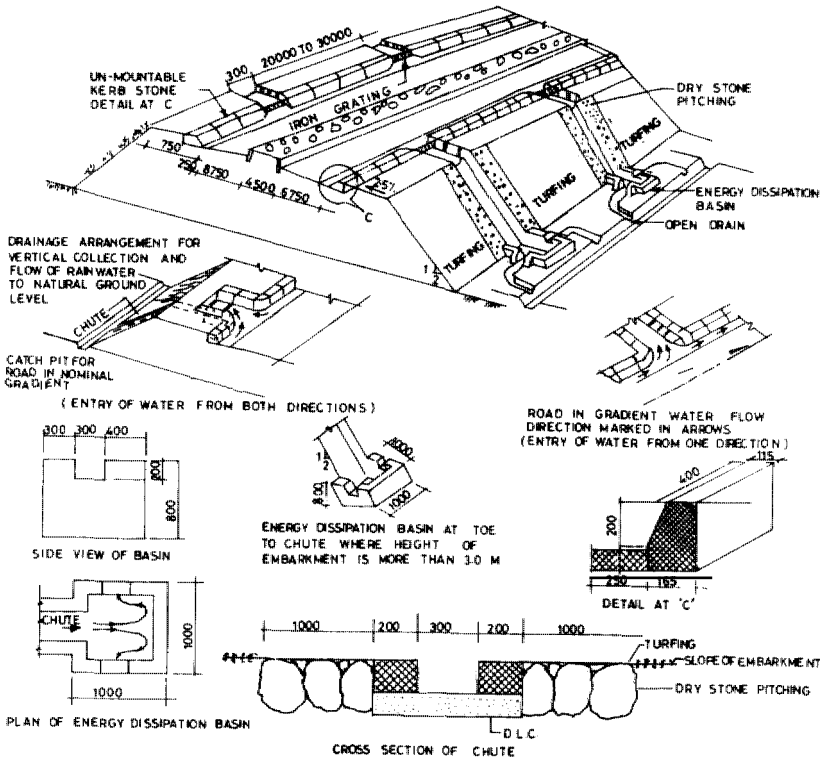

Fig. 3.3. Perspective view of standard dual carriageway pavement with paved shoulder showing drainage arrangement for collection and flow of surface water to natural ground level

3.6. Longitudinal Gradient

The minimum longitudinal gradient is governed by drainage consideration. On uncurbed pavements near level longitudinal gradients may not be objectionable, when the pavement has sufficient crossfall/camber to drain rain water laterally. But for better internal drainage of pavement layers, especially of granular material, a slight longitudinal gradient is preferable. Also, in cut sections and medians a slight gradient is desirable to facilitate the removal of water. A minimum longitudinal gradient of 0.3 per cent is considered desirable in most conditions to secure satisfactory drainage.

A minimum longitudinal gradient of 0.3 per cent is also preferable to facilitate flow of water in side drains, with outlets provided at required interval to restrict the depth of drains.

4. STORM WATER DRAINAGE DESIGN

4.1. The design of the drainage system involves (i) calculating the total discharge that the system will require to drain off and (ii) fixing the slope and dimensions of the drain to have adequate capacity to carry the discharge and afford proper maintenance. These two aspects are dealt separately.

4.2. The discharge is dependent upon intensity and duration of precipitation characteristics of the area and the time required for such flow to reach the drain. The storm water flow for this purpose may be determined by using the rational method, hydrograph method, rainfall run off correlation studies, digital computer models and empirical formulae. The empirical formulae that are available for estimating the storm water run off can be used only when comparable conditions to those for which the equations are derived initially can be assured. Of the different methods available, the rational method is most commonly used and serves the purpose for design of road side drains satisfactorily.

4.3. Any method requires that existing rain fall data of the concerned area is analysed to permit a suitable forecast. Road side drains are not designed for the peak flow of rare occurrences such as once in 100 years or 50 years - as is the case with design of important structures such as bridges or weirs. However, it is necessary to provide sufficient capacity to prevent too frequent a flooding of the drainage area. There may be some water accumulation on the roads when the rain fall exceeds the design value which has to be permitted. The frequency of occurrence which can be permitted varies from place to place, depending upon the importance of the place and

expectancy of the public. Flooding at any time, however, causes inconvenience to people but they may accept it once in a while considering the savings affected in drainage costs. The areas such as important junctions, areas having basement, substations etc. should be considered as important areas and higher frequency of flooding should be adopted in the design. Based on the practice being followed in metropolitan cities in our country and, cost considerations in mind, it is recommended that a return period of 1 to 2 years be adopted in estimation of run off.

4.4. Time of concentration: It is the time required for the maximum run off rate to develop. It is equal to the time required for a drop of water to run off from the most remote point of the road surface to the point for which the run off is being estimated. Empirical formula (IRC:SP:13) may be used to determine the time of concentration :

$$I_c = (0.87) (L^3)^{0.385} \\ \text{(H)}$$

Where

- I_c = time of concentration in hours
- L = Distance of critical point to the drain in km
- H = Fall in level from the critical point to the drain level in meters.

For a critical area, the time of concentration is made up of two components. These components are inlet time i.e. the time required for the rain water to flow over the road surface and enter the drain at various inlets into the drain and the time of flow. The time of flow is the time required for water to flow through the drain from the starting point upto the critical section under examination. It is to be remembered that flow time would be different for different points in the drainage system. This is illustrated through an example. Referring to Fig. 4.1, water from area A enters the drainage system at 2, and water from area B enters at 3. The time of concentration in this case is made up of inlet time, which is concentration for area A in which the drain starts and the time of flow in the drain from 2 to 3. If the inlet time is 5 minutes and the flow time is 3 minutes, the time of concentration at 3 is 8 minutes. Time of concentration for water at 4 to reach inlet at 3 is 9 minutes. If the rainfall duration is less than 8 minutes, not all of the area A and B would be contributing because water from more remote points of A fail to arrive to point 3.

4.4.1 The method described above can be used for each storm line to the outlet for arriving at the time of concentration. At every point under consideration, the inlet time at the most remote end of the drain is added to the total flow time in the drain. Inlet time used in actual practice may vary from 5 to 10 minutes. Experience or investigation will be needed in arriving

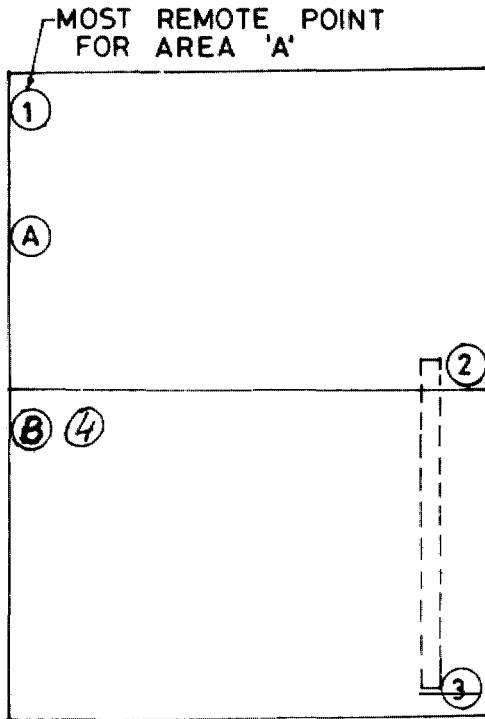

Fig. 4.1. Time of concentration

at the proper value, though this factor decreases in importance as the area or the length of the drain increases, and inlet time becomes a small proportion of the time of concentration.

4.5. Rain fall intensity: It has been observed that shorter the duration of critical rainfall, the greater would be the expected average intensity during that period. For example, during a 30 minute rainfall, some 5 minute period, or any period less than 30 minutes in length, will have an average rainfall intensity greater than that of the whole storm. The critical duration of rainfall will be which produces maximum runoff. This duration is equal to the time of concentration, since shorter periods do not allow the whole area to contribute water, and longer duration will give a smaller average rainfall intensity. The problem, thus reduces to one of establishing a

relationship between time of rainfall duration and probable or expected rainfall intensity. For the design purpose high intensities are of importance.

4.5.1 Current practice being followed in some of the metropolitan cities is as follows:-

i) **Bombay:**

The run off coefficient adopted in fully developed area is 1.0. In less developed areas the coefficient is worked out which may range between 0.58 to 1.0. The critical intensity of rainfall is considered 50 mm per hour and the frequency of the storm 2 times a year.

The criteria for design depth is not to allow flooding over 15 cm above G.L.

ii) **Madras:**

The intensity of rainfall adopted is 25 mm per hour. This roughly corresponds to rainfall intensity of 60 minutes duration with a frequency of 1 in 1.25 years.

iii) **Delhi:**

The average value of run off which is adopted for different category of drains is as follows:-

a)	Internal drains (0.177 m ³ /ha)	1 cft/acre
b)	Intercepting drains (0.132m ³ /ha)	0.75 cusec/acre
c)	Main drain (0.088 m ³ /ha)	0.5 cusec/acre

4.5.2. The above values have been worked out on following assumptions. Rainfall intensity of 30 minutes duration at the rate of 2.5" (62.5 mm) per hour occurs once in two years. Time of concentration 30 minutes and the average run off coefficient adopted is 0.60.

This gives average run off for internal drains as 0.088 m³/ha. Considering that flooding of streets for an hour or so may be allowed and the drains are designed for a run off of 1 cusec/acre.

For intercepting drains time of concentration considered is 30 minutes and the average run off coefficient adopted is 0.4. The average run off is taken as 0.13 m³/ha cusec/acre as against calculated value of 0.177 m³/ha. In case of main drains, time of concentration considered is one hour and the corresponding intensity of rainfall as 42 mm (1.65") per hour occurring once in 2 years. The average run off coefficient adopted is 0.30 which gives run off of 0.5 cusec/acre.

4.5.3. Intensities to be expected vary in different parts of the country. Though the rainfall gauges installed by the Meteorological Department and other Government Organisations are not numerous enough to give entirely satisfactory data, but sufficient information is available to allow adoption of rainfall intensity and the designer is not required to make guesses. Smaller cities that do not have a rainfall gauge station should install their own gauge and begin accumulating rainfall records for future use in design. While obtaining data from the Indian Meteorological Department (IMD) an important fact to be born in mind is that the processing of data by IMD is mainly for arriving at the design flood of a specific return period - usually 50 years, for fixing water ways, design HfL etc. for important streams and the data is not ready made for the specific purpose of design of road side drains.

4.6. For the estimation of flood discharge, Central Water Commission (CWC), jointly with Indian Meteorological Department (IMD), RDSO, Ministry of Railways and Ministry of Surface Transport has compiled very useful data. The entire country has been divided into 26 hydrometeorological homogeneous subzones as can be seen in Fig. 4.2. 20 flood estimation reports covering hydrometeorological studies for 23 subzones have already been published. The report includes the detailed rainfall studies of various stations having Ordinary Rain Gauge (ORG) and Self Recording Rain Gauge (SRRG) installed by the IMD and the State Governments. In case of ORG locations, the data available is in terms of daily rainfall i.e. highest one day station rainfall (24 hours rainfall ending 0830 hrs of date) alongwith date of occurrence. In case of SRRG stations, data available is the heaviest storm rainfall in durations of 24, 12, 6, 3 & 1 hour alongwith date and time of occurrence. For some selected locations data for half an hour rainfall is also available. In locatins where only 24 hour rainfall data is available, the same can be converted into short duration rainfall (shortest duration 1 hour) by adopting conversion factor in the report. The conversion factor varies from zone to zone and the one applicable for the design zone should be adopted. As an example, the graph showing duration vs. conversion ratio applicable for Western Himalayas (zone-7) is reproduced in Fig. 4.3. Due to their specific requirement, the data available with CWC, IMD etc. is limited to minimum period of one hour, whereas, for the design of storm water drains, depending upon the time of concentration, periods may be less than 1 hour.

4.7. The best possible estimation is possible where the gauge records at the interval of 5, 10, 15, 20, 30, 40, 50, 60 and 90 minutes are available. Method using such a data for obtaining intensity of rainfall for a particular duration of any duration is given in *Appendix A-1*. Alternatively, one hour

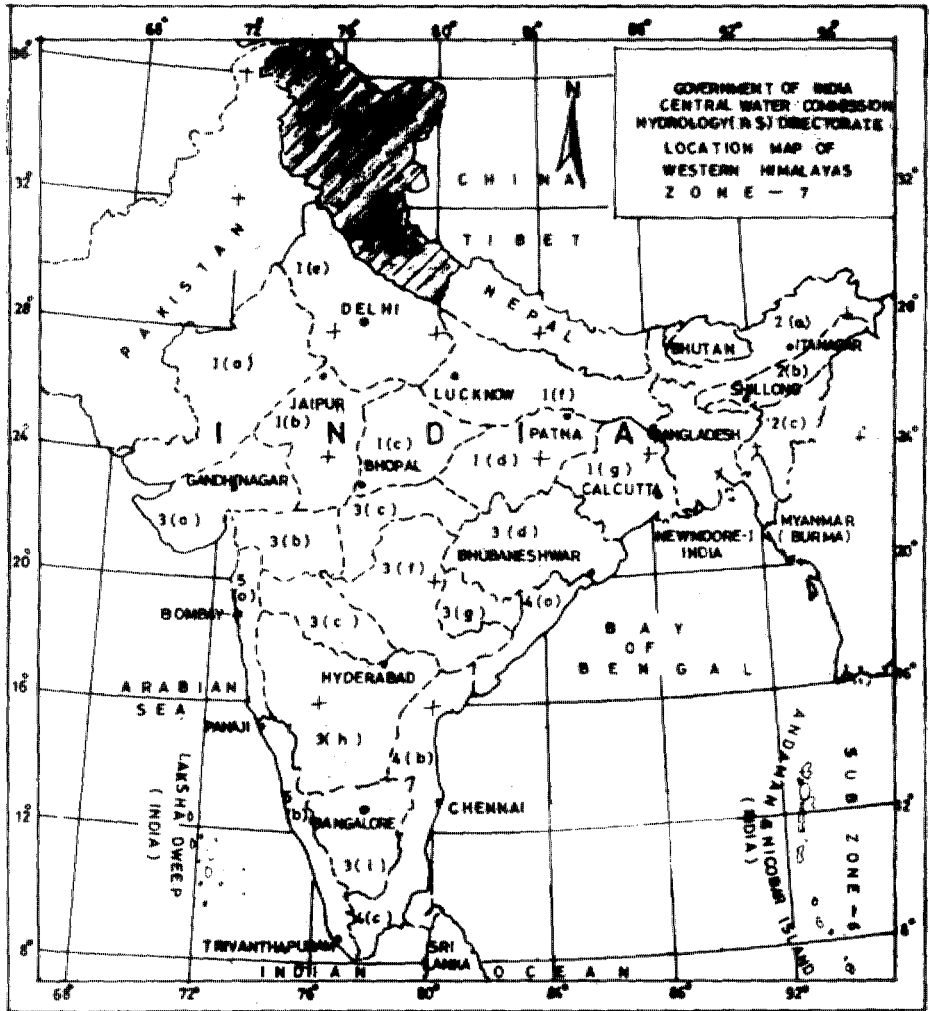

© GOVT. OF INDIA COPYRIGHT - 1994

Fig. 4.2.

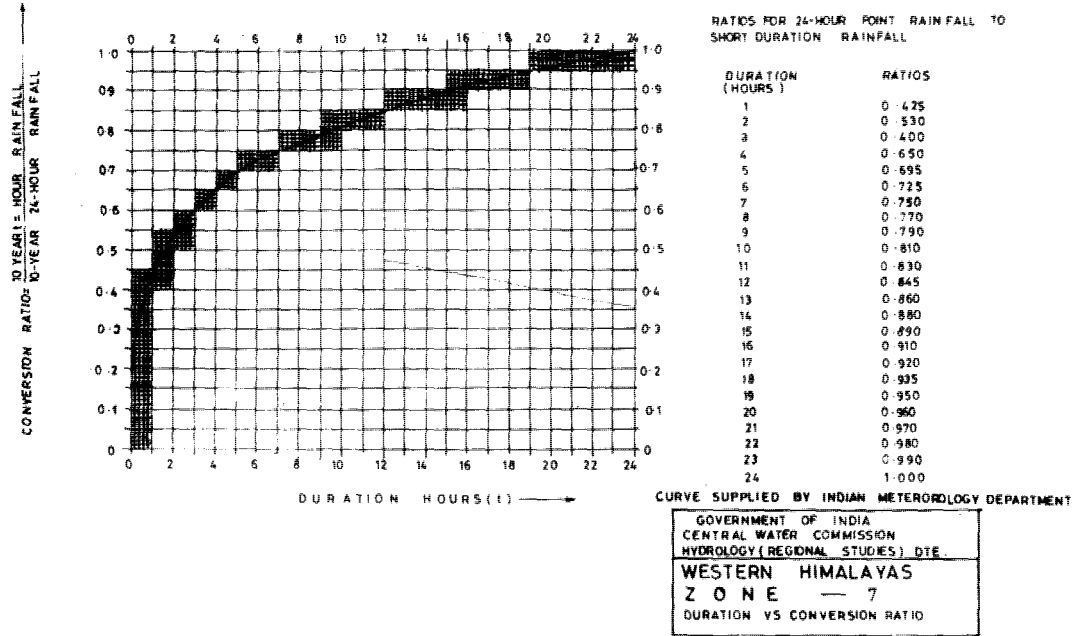

Fig. 4.3. Conversion of short duration rainfall to 24 hour rainfall

duration storm intensity may be converted into any duration intensity using the following formulae given in IRC:SP:13.

$$i = \frac{F}{T} \frac{(T+1)}{(t+1)} \dots \text{Eqn. 1}$$

Where

- i = Intensity of rainfall within a shorter period of 't' hours within a storm.
- F = Total rainfall in a storm in cm. falling in duration of storm of 'T' hours.
- t = Smaller time interval in hours within the storm duration of 'T' hours.

4.7.1. It is also added that as per practice being followed in most of the metropolitan cities, the calculation of runoff is being carried out using hourly rainfall intensity for a return period of one to two years. This is primarily for simplicity of calculations. However, for a large drainage system, it is recommended that calculations be carried out on the basis of detailed analysis as the efforts may be worth the savings in cost.

4.8. Rational Formula for Estimating Peak Run-Off Rates

For small water sheds not exceeding 50 km², as is the usual case for urban drainage system, the Rational method is widely used for estimating the peak run-off rates. The formula is

$$Q = 0.028 PAI_C \dots \text{Eqn. 2}$$

Where,

- Q = Design peak run off rate in cum/sec.
- P = Coefficient of run-off for catchment characteristics.
- A = Area of catchment in hectares.
- I_C = Critical intensity of rainfall in cm per hour for the selected frequency and the duration.

4.8.1. The coefficient of run-off (P) is the portion of precipitation that makes its way to the drain. Its value depends on a large number of factors such as permeability of the surface, type of ground cover, shape and size of catchment area, the topography, the geology, initial state of wetness and duration of storm. The value of 'P' commonly adopted for used in Rational Formula is given in Table 4.1 :-

Table 4.1. Values of Co-efficient of Run-off

Sl.No.	Description of surface	Coefficient of Run-off (P)
1.	Watertight pavement surface (concrete or bitumen), steep bare rock.	0.90
2.	Green area (Loamy)	0.30
3.	Green area (Sandy)	0.20
4.	Unpaved area along roads	0.30
5.	Lawns and parks	0.15
6.	Flat built up area with about 60 per cent area impervious	0.55
7.	Moderately steep built up area with about 70 per cent area impervious	0.80

4.8.2. If any change is expected in the land use pattern in the contributing area during the life time of the drainage system, consideration for same should also be taken in the design. It is a common practice that the run-off coefficient for the whole area is derived after estimating or ascertaining the proportion of the various surfaces to the whole area. Some common figures adopted for coefficient of run-off are given in Table 4.2. It is also to be remembered that run-off coefficient tends to become larger as rain fall continues due to filling of depressions in impervious surfaces and soaking of the upper layers of exposed soil.

Table 4.2. Co-efficient of Run-off for Various Surfaces

Sl.No.	Description of surface	Coefficient of Run off
1.	Most densely built up areas	0.7 to 0.9
2.	For adjoining area to built up areas	0.5 to 0.7
3.	Residential areas	0.25 to 0.5
4.	Sub-urban areas with few building	0.10 to 0.25

4.9. **Hydraulic Design**4.9.1. **Design of Drain Section**

Capacity of the drain is normally designed using Manning's formula

$$Q = \left(\frac{1}{n}\right) A R^{2/3} S^{1/2}$$

and

$$V = \frac{1}{n} R^{2/3} S^{1/2}$$

Where

Q = discharge in cum/sec

V = Mean velocity in m/sec

n = Manning's regosity coefficient

R = Hydraulic mean radius which is area of flow cross section divided by wetted perimeter.

S = Gradient of drain bed

A = Area of flow cross section in m²

4.9.2. The coefficient of regosity for various surfaces is given in IRC:SP:42 may be referred to. Some average values are, however, indicated in Table 4.3 for general guidance.

Table 4.3. Coefficient of regosity for type of surfaces

Type of surface	Value of n
i) Brick pitched drain	0.017
ii) Plastered brick surface	0.015
iii) Plastered brick surface with neat cement finish	0.013
iv) Concrete pipes upto 600 mm dia	0.015
v) -do- above 600 mm dia	0.013
vi) Dry rubble masonry	0.033
vii) Dressed ashler surface	0.015
viii) Dry stone pitching	0.020
ix) Kutcha drain	0.025

4.9.3. While deciding the drain sections it is not sufficient that they are sufficient to carry the required discharge. Following guidelines are also required to be kept in view.

a) **Minimum and maximum velocities**

	Minimum m/Sec.	Max. m/Sec.
i) Internal drain (brick pitched or plastered)	0.45	1.5
ii) Intercepting and main drains (brick pitched or plastered)	0.75	1.5
iii) Pipe drain (running full)	0.75	1.8

* To ensure self cleaning of the drain, a minimum velocity of 1.5 m per second may be desirable. However, this may require installation of concrete drains or paved drains.

b) **Minimum free board**

	Drain size	Free board
i)	Beyond 300 mm bed width	10 cm
ii)	Beyond 300 mm & upto 900 mm bed width	15 cm
iii)	Beyond 900 mm & upto 1500 mm bed width	30 cm

For larger drains the free board shall be higher upto 90 cm depending upon the discharge.

c) **Minimum section of drain**

It should be possible to clean the drains periodically using a spade. Accordingly, it is recommended that minimum width of a drain should not be less than 250 mm. In case of pipes the minimum diameter should not be less than 450 mm.

- d) **The effective section of the drain carrying design discharge should be considered below the bell mouth pipe so that there is no back flow of water on to the road.**

4.9.4. **Channel shapes**

The usual channel shapes are:

- i) Parabolic
- ii) Trapezoidal
- iii) Rectangular
- iv) Triangular or V shaped

The parabolic profile is considered to be the best for hydraulic flow but its actual construction and maintenance is difficult. The V shaped drain is not very popular in urban areas as its desilting is difficult. The trapezoidal and rectangular sections are easy to construct and are considered most suitable. In urban areas all drains passing through built up area and near to bus stand, crossing etc. should preferably be covered so that the drains are not used as dust-bins. Even if the drains cannot be covered in the initial stage due to economy reasons provision should be available for covering it at a later stage. However, it should be kept in mind that pipe drains are difficult to desilt and maintain. (Chapter 5 may be seen).

4.9.5. **Economical sections (for lined drains)**

As far as possible, for obtaining economical sections the relation between bed width and depth shall be as follows;

- i) Rectangular drain $b = 2d$
- ii) Trapezoidal $b = 0.82d$ (1:1 side slope)
 $b = 1.24d$ (1/2:1 side slope)

For main or trunk drains the side slopes should be 1:1 or 1/2:1 depending upon nature of soil and availability of land.

4.9.6. **Cunetts and cross slope in bed**

All main drains wider than 3 m shall be provided with a central cunnett for dry weather flow. If the dry weather flow can be estimated it should provide for the same. Some municipal authorities, based on experience, provide for 6 to 7 per cent of peak flow. A cross slope of 1 in 20 to 1 in 30 shall be provided in the bed towards the centre of the cunnett. Weep holes shall be provided in the bed of all main drains where the height of water table is expected to be above the bed level of the drain.

4.9.7. **Silt pit**

A silt pit shall be constructed at all the inlet points of every covered drain and also provided with vertical grating in order to avert entry of floating material into the drain.

5. **DRAINAGE SYSTEM AND APPURTENANCES**

5.1 The rain water from the right of way of the road is ultimately required to be transported away before it can cause nuisance or damage. The water can be transported away in any of the following manner.

- a) Over the surface
- b) In open channels
- c) In covered drains or pipes

5.1.1. **Drainage over surface**

All surface water is initially drained over the surface before it is collected in the drainage system. The drains are located along road side and the water is let into the drain through gulleys, bell mouths or other such water entrances.

Minor roads in residential areas are narrow and it may be difficult to provide separate space for drains. In such cases the water can be allowed to flow in the kerb channel which can be led into the main drainage system where the minor street meets the main road. Besides saving in the cost of drain, the water is kept at higher level which may help either in reducing the depth of drain at downstream or provide a better gradient and reduce silting and other maintenance problems. Another advantage is that the water takes longer to enter the drain and reduces the peak flow.

5.1.2. **Drainage through open channel**

The open drain along the road side definitely have to be away from the shoulders or the berm and require additional space. They are easier to maintain and allow removal of silt and other solids easily. Also, for a given cross section open drains can carry much larger discharge particularly in flood conditions when the drain is surcharged. However, open drains have their inherent disadvantage of being used as a dust-bin . Due to this reason their hydraulic capacity for most part of the year remains poor.

5.1.3. **Covered drains or pipe**

Covered drains i.e. rectangular drains with cover slabs are free from garbage dumping problems. Also, they can be located below the

footpath or in extreme cases below the carriageway where space is restricted. The closed system, in many cases, is demanded by residents of the adjoining area. Pipe drains also have the above advantages but they should be used for small lengths as cleaning of such drains is not possible by ordinary method and they need special equipments. Also, due to minimum size requirement and cushion requirement, such drains tend to become deep and increase the depth of drain at the downstream end.

5.2. Selecting the type of drain, cost should not be the only consideration. Cost of maintaining the system and requirement of the area should also be considered. For effective drainage and facility of inspection and maintenance it is desirable to have open drains. Fencing or boundary wall may be considered to guard against throwing of garbage and to avoid accidents. When boundary wall is provided, care shall be taken to ensure that wall does not obstruct the surface drainage. A drain along the boundary wall with suitable inlets into the main drain is one solution in such cases. Access to houses should be provided by means of properly designed slabs/covers whenever situation so warrants. Such access, if provided by the residents, more often creates an hindrance to the free flow. However, keeping other limitations of availability of land in Urban Areas, possibility of ingress of garbage, risk to the population living near the drain, it may be necessary to have covered drains at certain places. For the purpose of desilting removable slabs, preferably cast under controlled conditions for durability, should be provided. In case of pipe drain, at junction points and other locations size of manhole should be adequate so as to act as inspection chamber and facilitate proper cleaning.

5.3. It is very essential that ultimate disposal of the rain water is into one of the following.

- a) River system
- b) Coastal waters
- c) Flood Plains
- d) Underground strata.

a) River System : Disposal of storm water into river system can be considered at locations if water is not being taken for water supply from its down stream side. Discharge of rain water into rivers needs to be allowed provided the environmental considerations are satisfied.

b) In coastal areas, problems arising due to high tide should be clearly understood. Similar would be the case when the ultimate discharge is into the river system. In most of such systems, during high floods sluice gates, which are controlled by the Flood Deptt.

are closed resulting in back flow. In such cases, where such a situation is likely to create critical conditions during heavy downpour, pumping may have to be resorted to which discharges above HFL.

- c) Possibility of demarcating some low lying areas where surplus water from the drains can be temporarily allowed to impound for some time may exist. Such systems shall be well designed not only for entry of the storm water but also exit of the storm water after the storm is over and the drains are no longer discharging their peak flows. Desilting of such ponds and maintaining of the environment shall be well designed.
- d) **Underground Strata:** In cases of road passing through the built up areas drainage of storm water into underground permeable strata has been tried. Such disposal of rainwater may not be acceptable in situations where such discharge is likely to contaminate the subsurface water. Arrangement for underground drainage system is given in Fig. 8.1. This drainage system may therefore be used cautiously. A brief description of improving storm water drainage in built-up areas using vertical drains is given in *Appendix A-2*.

5.4. General Considerations in Design of Storm Water Drain :

- a) Drains should be planned taking into consideration the ground levels, slope of the ground, valley and ridges and also the land uses planned for urban development.
- b) Drains should be planned to get good longitudinal slope, considering the nature of soil and subsoil water level. Drainage of large area can be better achieved by subdividing it into small grids to avoid a long main drain. Aim should be to get a high velocity for the dominant flow.
- c) Efficiency in maintenance of drainage system should be an important consideration in selecting the size, (covered or open) shape and the location. The specification of the drain should also aim at preventing the possibility of ingress of other extraneous materials, debris, rubbish, vegetation etc. where gratings are provided on drains, they should be so located as to attract attention of maintenance staff, easy to approach inspect and clean it.
- d) An attempt shall be made in the design to provide higher starting and higher outfall bed levels in drains. A free outfall shall be attempted as far as possible.
- e) Design of the main drain shall be so made as to allow use of the normal methods for desilting operation.

5.5. Manholes

5.5.1. Ordinary Manholes

A manhole is an opening constructed on the alignment of a covered or pipe drain for facilitating a person access to it for the purpose of inspection, testing, cleaning and removal of obstructions from the drain.

5.5.2. Spacing

The spacing of manholes depends upon the nature of drain and the cleaning device likely to be used. Generally manholes in straight reaches are at a spacing of 10 to 20m.

Manholes are also provided at the start, junctions, at points of change of alignment and at points of change of gradient. When twin or multiple box/pipe sections are used, separate manhole for each conduit should be provided.

Manholes are generally circular, square or rectangular in shape. The inside dimension should be adequate to permit inspection and cleaning operation without difficulty. A minimum inside dimension of 120 cm x 90 cm is sufficient. In case of shallow manholes upto depth of 1.40 m, minimum allowable width could be reduced to 75 cm.

The opening for entry into the manhole should not be less than 50 cm clear. A circular opening is generally preferred.

5.5.3. Cover and Frame

Precast concrete manhole covers and frames are preferable compared to cast iron covers and frames as these are less prone to theft. Now in many cities factory made fibre reinforced covers and frames are available which can be used. They are available in following grades:

- a) LD-2.5 - Suitable for use with pedestrian load and occasionally LMV traffic. Can be used where no vehicular traffic is involved.
- b) MD-10. These are suitable for use in service lanes/roads, car parking areas etc.
- c) MD-20. These are suitable for use in carriageways with heavy duty vehicular traffic.
- d) EHD-35. These are suitable for use on carriageway in commercial/industrial/port areas.

The suffix on above type indicates the ultimate breaking load in MT using 300 mm dia block, as per method described in IS:12592 (Part 1). The precast manhole covers are suitably marked on the operative surface with the details like name of the department, grade, date of manufacture trade name, sewer or SWD. They should have edge protection of covers and lifting facility for proper serviceability.

5.6. Gratings and Curb Inlets

These are devices meant to admit the surface run off to the drain and form a very important part of the system. Their locations and design should, therefore, be given careful consideration.

Storm water inlets may be categories under three major groups viz. curb inlets, gutter inlets and combination inlets, each being either pressed or flush depending upon their elevation with reference to the pavement surface.

Curb Inlets

Curb inlets are vertical openings in the road curbs through which the storm water flows and is preferred where heavy traffic is anticipated. They are termed as deflector inlets when equipped with diagonal notches cast into the drain inlet along the curb opening to form a series of ridges or deflectors. This type of drain inlet does not interfere with the flow of traffic as the top level of these deflectors lie in the plane of the pavement.

Gutter Inlets

These consist of horizontal openings in the drain which is covered by one or more gratings through which the flow passes. Missing gratings in this type of arrangement may cause accidents particularly for two wheelers and light vehicles.

Combination Inlets

In some locations, due to vertical or horizontal space restrictions, combination of the two may be adopted to act as a single unit.

Fig. 5.1 shows schematic arrangement of the above kind of inlets. Fig. 5.2 shows typical detail of a RCC grating (gutter inlet type) whereas Fig. 5.3 shows the photograph of such gratings made of fibre reinforced concrete. Fig. 5.4 shows typical example of curb inlet, gutter inlet and the combined inlet for typical situations and should not be taken as standard dimension for all locations. The actual structure of an inlet is made of brickwork or concrete. Earlier practice is to provide cast iron gratings conforming to IS:961. In coastal areas, where there is corrosion probability these are galvanised. Presently, precast, fibre reinforced gratings are also available which is less prone to theft and has relatively less maintenance requirement.



(a) UNDEPRESSED



(b) DEPRESSED

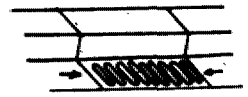

(c) DEFLECTING
INLET

CURB INLETS

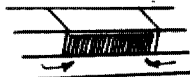

(d) UNDEPRESSED



(e) DEPRESSED

GUTTER INLETS



(f) GRATE PLACED DIRECTLY
IN FRONT
(DEPRESSED)



(g) GRATE PLACED IN
END TO END POSITION
(UNDEPRESSED)



(h) GRATE PLACED IN
OVERLAPPING
POSITION
(UNDEPRESSED)

COMBINATION INLETS

Fig. 5.1. Various types of curb inlets

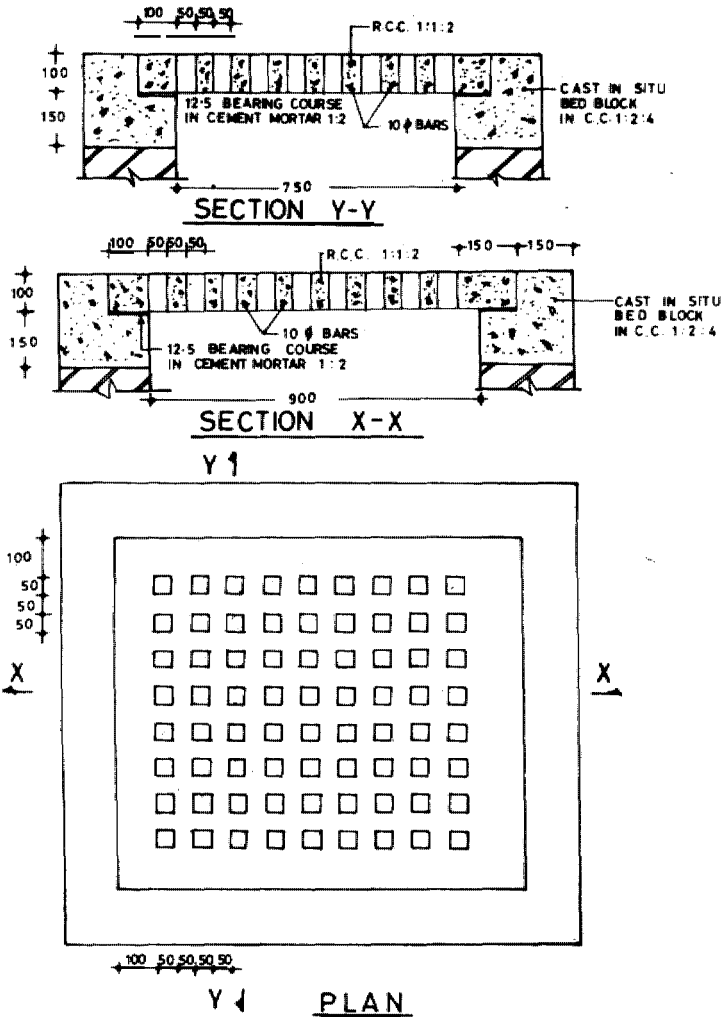

NOTE :-

- 1 DRAWING NOT TO SCALE
- 2 ALL DIMENSIONS ARE IN MM & TYPICAL

Fig. 5.2. R.C.C. road grating

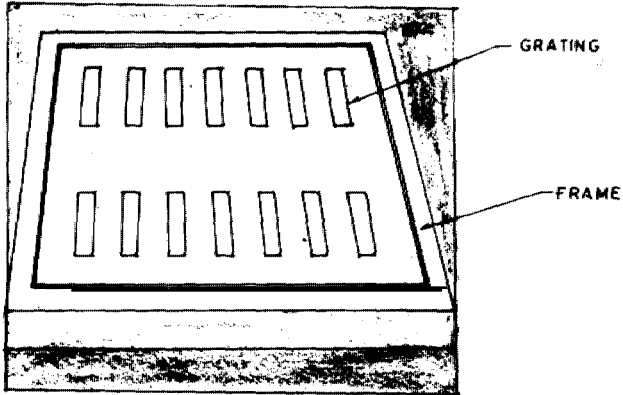

(a) RECTANGULAR OPENING

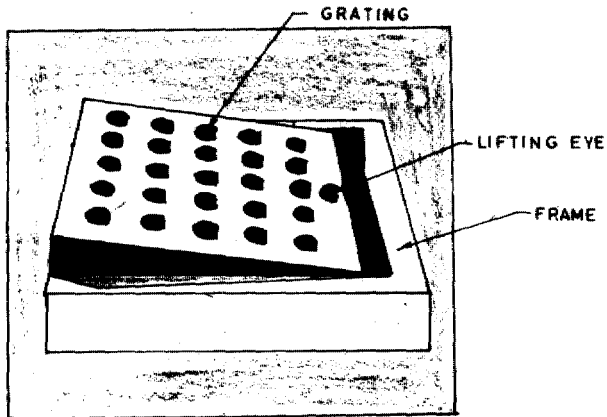

(b) CIRCULAR OPENING

Fig. 5.3. Grating and frame made of fibre reinforced concrete

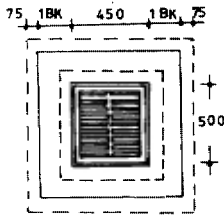
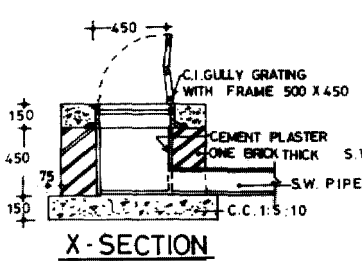

WITH HORIZONTAL GRATING

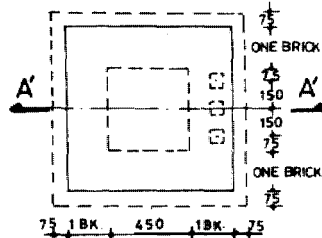
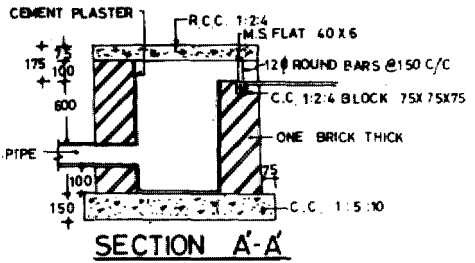

WITH VERTICAL GRATING

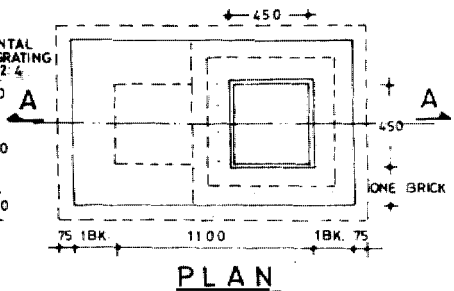
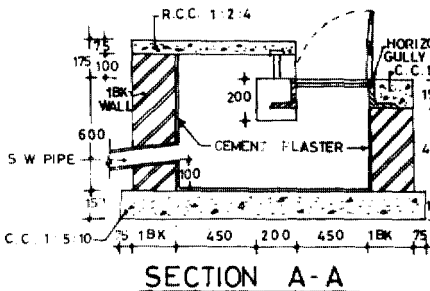

WITH HORIZONTAL AND VERTICAL GRATING

DRAWING NOT TO SCALE.
ALL DIMENSIONS ARE IN MM & TYPICAL

Fig. 5.4. Road gully chamber

The minimum spacing of inlets would depend upon various conditions of road surface, size and type of inlet and rainfall. At junctions or near the valley curves, it may be necessary to provide them at very close intervals. The maximum spacings should not exceed 30 M.

5.7. Bell Mouth Inlet

In urban areas, where footpath is made and the location of the drain is adjacent to it, water inlet in many cases, is through a RCC pipe. This is 250 mm dia NP class pipe. The spacing is depending upon the area to be drained and the longitudinal slope of the road. Schematic arrangement is shown in Fig. 5.5.

6. DRAINAGE OF SPECIAL LOCATIONS

6.1. In urban situations many locations require different and elaborate arrangement for their drainage. While in most cases, it would be possible to drain out the water using gravity flow, in some locations pumping may be necessary. Some of the important locations could be

- a) Underpasses and subways
- b) Rotaries
- c) Flyovers and bridges
- d) Medians

6.2. Drainage Through Pumping

6.2.1. Pumping becomes essential where rain water cannot flow into the drainage system by gravity. Roads below a Railway line or a flyover are examples of such location where the road is required to be depressed to get minimum headroom. The water accumulating on the road is channelised to a sump tank and then pumped to the nearest drain from where it can flow under gravity. Adequate capacity of the sump, pump and the reliability of the pumping system are essential to avoid disruption of traffic through such location. Pumping may also be required at the tail end of a drainage system to discharge the outflow above HFL or any such designated level as brought out in para 5.3.

6.2.2. Availability of land, type of equipment and structure external appearance and aesthetics are some of basic considerations in design of pumping stations. The pumping station shall be located and constructed in such a manner that it would not be flooded at any time. Isolated pumping station particularly unmanned should be protected against vandalism. In some parts of the country, particularly in arid western regions, the water contains high proportion of sulphates leached from the soil. In such locations, sulphate resistant cement should be used. Provision should be made to facilitate easy removal of pumps and motors for periodical repairs and maintenance.

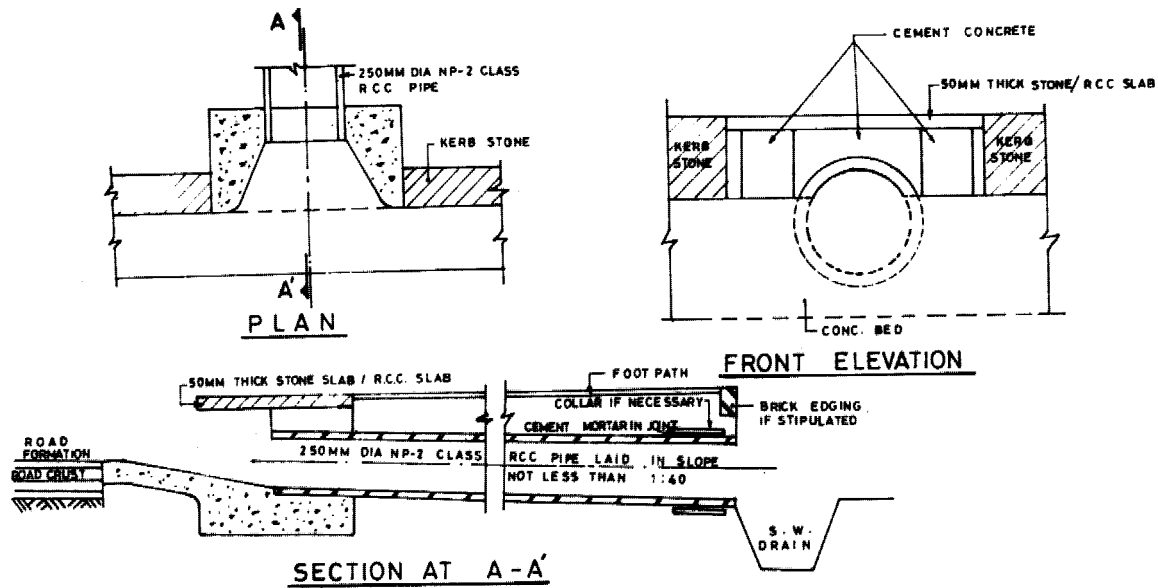

Fig. 5.5. Schematic arrangement showing bell mouth drain

6.2.3. While deciding the capacity of the sump future increase in flow due to change in use of area should be kept in mind. Usually, series of pumps are used for catering to varying rate of flow in such a manner that the total capacity of all the installed pumps is sufficient to cater to peak flow. The size of sump should be kept such that with combination of inflow and pumping, the cycle of operation for any pump is not less than five minutes. It may be remembered that the capacity of the sump is reckoned between the level at which air affects the suction line of minimum duty pump and the invert level of incoming pipes. It is now common to provide pumps with automatic control so that, depending upon the inflow (or the level in the sump) required capacity pump start automatically when the rate of inflow decreases the pump stop automatically. In some cases as an alternative, pump with variable speed drives with automatic control are used to match pumping rate exactly with inflow rates. Some other important considerations are listed below.

- i) Power requirement is available from two feeders.
- ii) Dia of bell mouth (d) shall be 1.5 to 2 times the dia of suction pipe. A minimum side clearance and bottom clearance above the floor of the sump shall be kept which should not be less than d.
- iii) Distance between two suction pipes within the same sump should be far apart and should not be close than two times the diameter of suction pipe.
- iv) The flow into the sump should reach the pump suction in uniform manner and with a flow velocity. Suggested velocity is 0.7 m per sec.
- v) Only C.I. pipes should be used for pumping main. The minimum and maximum velocity should be kept 0.8 m/sec. and 1.2 m/sec. respectively.

6.2.4. Maintenance of pumps

The pumps shall be checked and thoroughly serviced before monsoon. The defective and worn out parts shall be replaced. It is very necessary to check the foot value for proper functioning. In case water is available the sump pump shall be given a trial run on load otherwise pump shall be run and no load current checked. Similar exercise shall be done for stand by diesel generator and diesel pumps. Stocking of diesel and arrangement for filling into the diesel pump or the generator shall also be tested. The joints of suction pipe and discharge pipes shall also be checked for its proper serviceability.

6.3 Drainage of Rotaries

In urban situations, many intersections, particularly low traffic volume intersections are provided in the form of a rotary. In such locations, due to superelevation requirement, water from a large area flows towards the centre of the rotary. It is very essential to collect this water and drain it out to the main drainage system. A typical schematic arrangement has been shown in Fig. 6.1. The dimension of the drain should match the quantity of water it is required to drain off though minimum width should not be less than 60 cm from ease of cleaning considerations. If the site conditions permit, outlet can be more than one. This would reduce the depth of the circular drain.

6.4. Drainage at Intersections

In many mega cities, 6-lane divided carriageway is a common feature. This results in large area to be drained off. Any stagnation of water at intersections would reduce the capacity of the junction resulting in queuing up of traffic. Many times, ponded water affects low height vehicles and any stalled vehicle at an intersection during heavy downpour creates unmanageable traffic jams. As such drainage at the intersection should be well planned. Preferably, the level of junctions should be slightly higher than the roads meeting it so that water can reach the main drainage system which is along the roads. In some locations, piped drain with grating in the intersection area has been attempted but such drain usually gets choked due to sweepings from the road during dry season. In such locations, if the junction is kept higher, it is possible to drain off the water through channels in the traffic island. One schematic arrangement is shown in Fig. 6.2. Depending upon the topography and the geometry of the intersection alternate arrangement should be worked out for important intersections.

6.5. Drainage at Superelevation Portion

This aspect has been covered under para 3.2. Fig. 3.2 (c) refers.

6.6. Drainage of Flyovers and Bridges

In case of bridges across a river, the rain water can discharge into the river bed through drainage spouts as per IRC Standards. In case of flyovers, the water flowing onto the elevated carriageway is required to be disposed off in such a manner that it does not create problem for the traffic on the lower level and the entire rain water is drained ultimately to the drainage system of the area. The area of the flyover, which is above road below, is drained through downtake pipes which discharge into a manhole connected with the drainage system. In such locations care must be taken that the pipes are taken down in such a way that they are aesthetically pleasing. Schematic arrangement is shown in Fig.6.3. Some typical

sketches are added to understand the detailing required in such cases. Fig. 6.4 shows the details in the approaches to a bridge. Fig. 6.5 gives the details of a catch basin along with detail of gutter inlet as the drain is below the kerb channel. The longitudinal drain discharges through RCC pipe at designed intervals. Fig. 6.6 gives details of drainage grating and the downtake pipe from the deck of the bridge. Fig. 6.4 to 6.6 are for a specific project and the dimension and spacings are as per requirement of this particular bridge in Delhi and should not be treated as standard dimension for all bridge/flyovers.

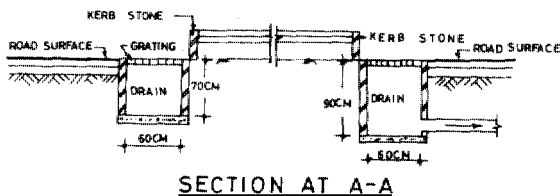
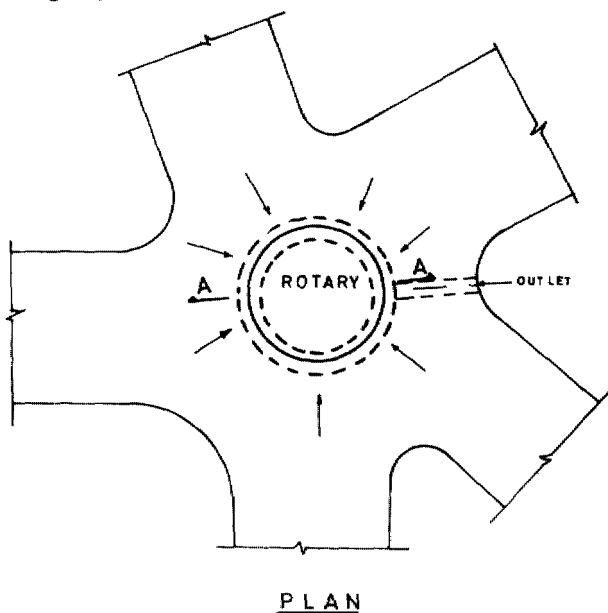

DRAWING NOT SCALE

Fig. 6.1. Typical drainage detail at a round about

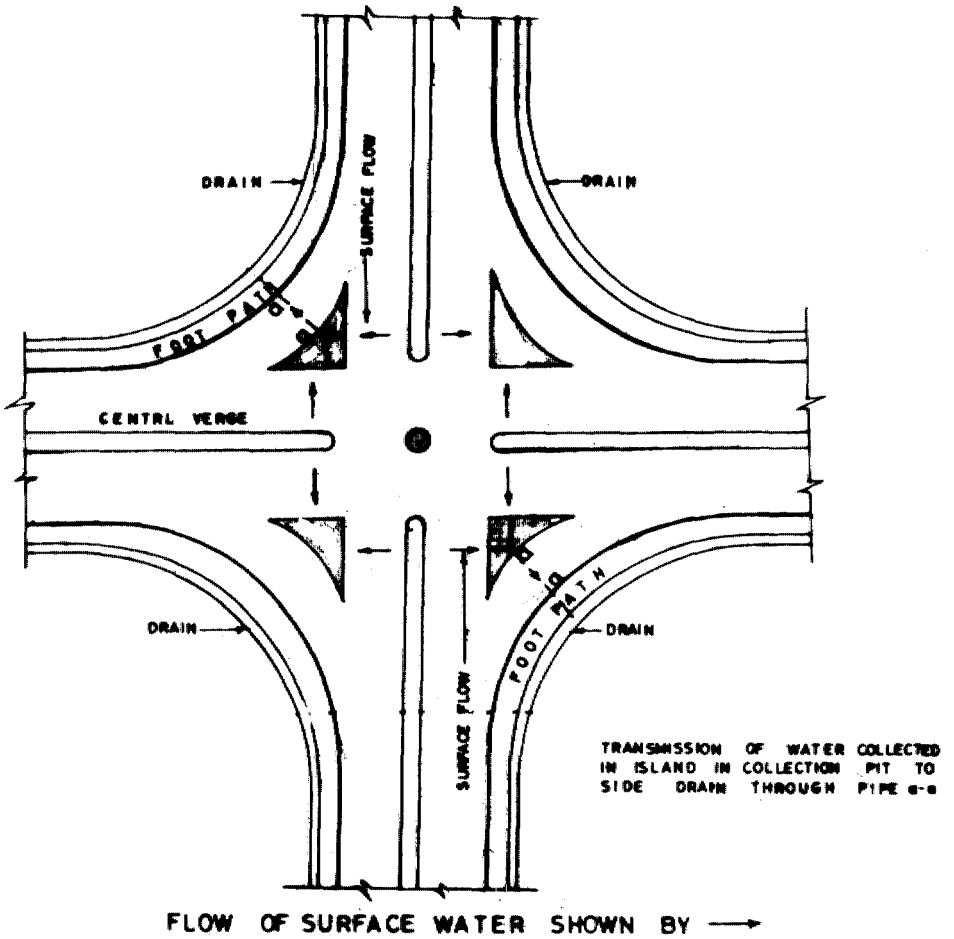

Fig. 6.2. Drainage at intersection

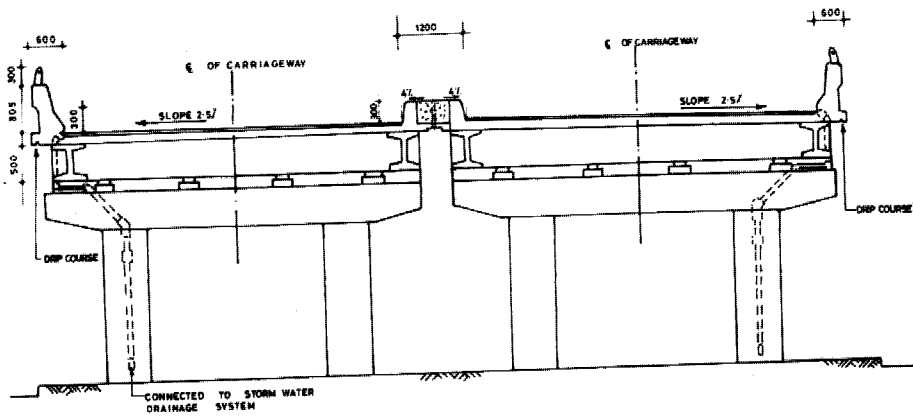
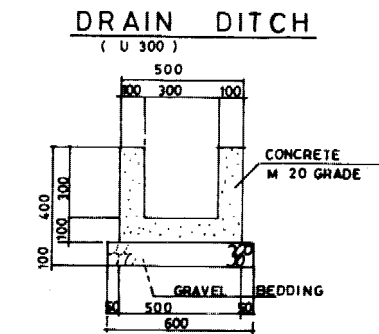
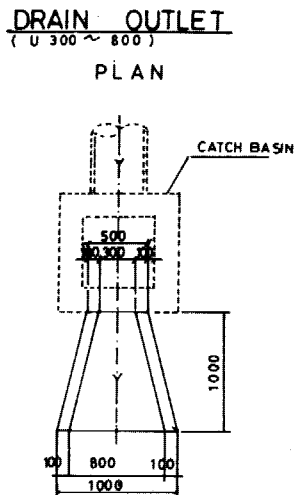

Fig. 6.3. Schematic arrangement of drainage of a flyover



MATERIAL LISTS (PER 10.0m)

ITEM	CLASS	UNIT	QUANTITY	REMARKS
CONCRETE	M 20 GRADE	m ³	1.10	
GRAVEL		m ³	0.60	
FORM		m ²	14.00	
EXCAVATION		m ³	3.00	



MATERIAL LISTS

ITEM	CLASS	UNIT	QUANTITY	REMARKS
CONCRETE	M 20 GRADE	m ³	0.34	
GRAVEL		m ³	0.09	
FORM		m ²	1.00	
EXCAVATION		m ³	0.43	

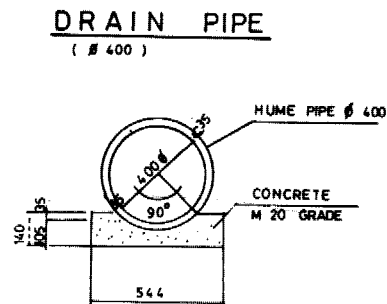

MATERIAL LISTS (PER 10.0 m)

ITEM	CLASS	UNIT	QUANTITY	REMARKS
FUME PIPE	Ø 400	m	10.00	
CONCRETE	M 20 GRADE	m ³	0.60	

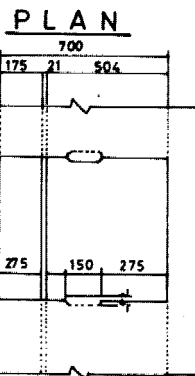
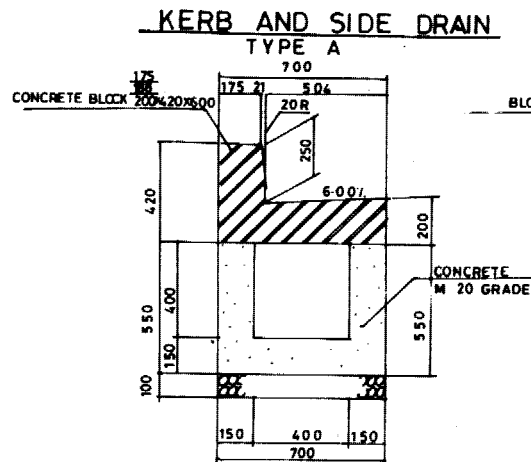

MATERIAL LISTS (PER 10.0m)

ITEM	CLASS	UNIT	QUANTITY	REMARKS
CONCRETE	M 20 GRADE	m ³	2.25	
GRAVEL		m ³	0.70	
FORM		m ²	10.00	

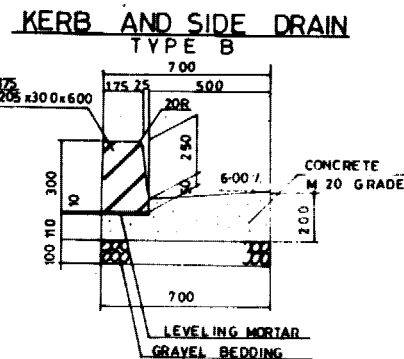

MATERIAL LISTS (PER 10.0m)

ITEM	CLASS	UNIT	QUANTITY	REMARKS
CONCRETE BLOCK	175 x 300 x 600	m	10.00	
CONCRETE	M 20 GRADE	m ³	1.15	
MORTAR		m ³	0.02	
GRAVEL		m ³	0.70	
FORM		m ²	3.10	

Fig. 6.4. Typical drainage structures (I)

NOTE: THE DIMENSIONS SPACING SHOWN IN FIG. 6.3 6.4 & 6.5 ARE FOR A SPECIFIC PROJECT & SHOULD NOT BE TREATED AS STANDARD

CATCH BASIN

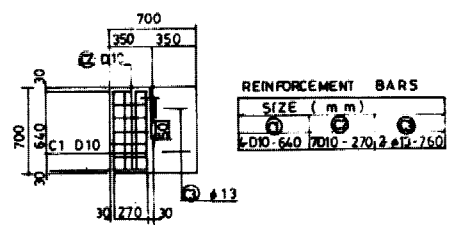
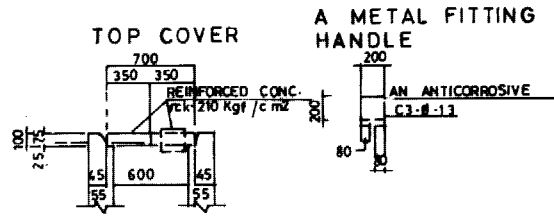
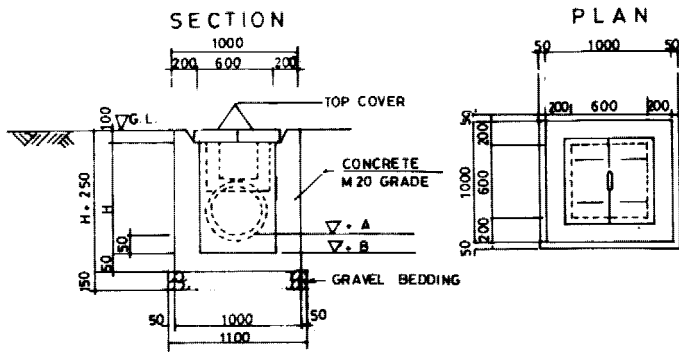

DIMENSION LIST OF CATCH BASINS

NO	H	G L	E L OF PIPE . A			. B	REMARKS
			X	Y	Z		
1	1050	209-640	209-340	208-740	---	208-590	
2	550	207-140	208-740	206-840	---	206-590	
3	550	206-000	205-700	205-600	205-600	205-450	
4	1050	209-070	208-170	208-770	---	208-020	
5	550	209-800	208-300	209-300	209-200	208-050	
6	950	208-640	208-340	207-740	---	207-590	
7	1050	206-500	206-100	205-600	206-200	205-450	
8	450	206-550	206-250	206-250	---	206-100	
9	550	208-900	208-600	208-900	---	208-350	
10	1170	209-500	208-500	208-500	---	208-430	
11	550	207-160	206-860	206-760	---	206-610	
12	750	202-900	202-300	202-600	---	202-150	FOR OUTLET WITH NO TOP COVER
13	750	202-900	202-300	202-600	---	202-150	FOR OUTLET WITH NO TOP COVER
14	750	203-200	202-600	202-900	---	202-450	FOR OUTLET WITH NO TOP COVER
15	750	205-500	204-900	205-200	---	204-750	FOR OUTLET WITH NO TOP COVER

GUTTER INLET

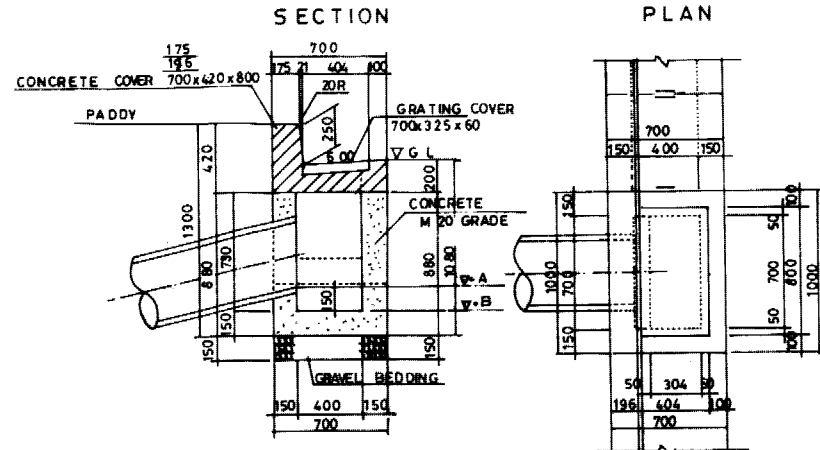

DIMENSION LIST OF GUTTER INLETS

NO	G L	. A	. B	REMARKS
1	208-183	207-433	207-283	
2	210-129	209-379	209-229	
3	210-521	201-771	205-621	
4	209-283	208-533	208-383	
5	209-697	208-287	208-137	
6	207-240	206-490	206-340	

DIRECTION LIST OF GUTTER INLETS

1	φ 400 ↓
2	φ 400 ↓
3	φ 400 ↓
4	φ 400 ↓
5	φ 400 ↓
6	φ 400 ↓

DIRECTION LIST OF CATCH BASINS

1	U 300 X → Y φ 400	6	φ 400 Y → X U 300	11	U 300 Y → φ 400
2	φ 400 X → Y U 300	7	φ 400 Y → Z U 300	12	U 300 → φ 400
3	U 300 X → Y φ 400	8	U 300 X → Y U 300	13	U 300 → φ 400
4	φ 400 X → Y U 300	9	U 300 X → Y φ 400	14	U 300 → φ 400
5	U 300 X → Y φ 400 Z	10	φ 400 X → Y φ 400	15	U 300 → φ 400

Fig. 6.5. Typical drainage structures (II)

6.7 Drainage at the Foot of Flyover

The longitudinal slope of ramp of a flyover is usually between 2.5 to 3 per cent whereas the cross slope (in straight reaches) is between 1.7 to 2 per cent. As such, there is a tendency for the rain water to flow in longitudinal direction rather than in cross direction resulting in very large quantity of water reaching the valley curve area where it meets the ground level road. The size and the spacing of inlet pipe or the grating in such locations should be selected carefully to avoid pondage of water in such locations. It is considered a good practice to provide a set of 2 to 3 inlets at close spacing near the valley curve for efficient and effective drainage rather than depend upon only one inlet.

7. MAINTENANCE OF DRAINS

7.1. The capital cost involved in construction of drains forms a small component of the total expenditure involved in providing the infrastructure in the form of carriageway, footpath, medians, street light and other street furniture. Like any other capital asset, storm water drainage system also needs constant maintenance, if the investment is to serve the purpose it is meant for. The need for a good storm water drainage or absence of it is felt by many only during certain days of the year. However, the adverse effect of weakened or damaged road crust due to ponding of water and saturation of subgrade continues for a fairly long period and has to be clearly understood by the engineer-in-charge of maintenance.

7.2. The drainage system is at its best when it is maintained as properly as designed. For this purpose it is necessary that the drains keep their shape and slope in the designed manner during their life time. It is also necessary to ensure that the drains retain their full cross section, particularly for the monsoon. The system of maintenance can be classified into following three categories.

- a) Continuous regular maintenance
- b) Periodical maintenance
- c) Special maintenance/Repairs for improvement.

The extent of these repairs depend upon size of the drain, location of the drain, nature of habitation nearby and cross drainage structures. The difficulty in maintenance is also caused by a lesser degree of consciousness/civic sense. Malba, garbage, solid waste and road cleanings enter the drain resulting in silting and solid crustation of extraneous material making the maintenance difficult and poor efficiency of drains. A broad check list is given in *Appendix A-3*, which by no means is exhaustive.

7.3. Periodical inspection and maintenance of drains is very necessary as failure of drains may occur more due to deficiency in maintenance rather than defect in design. The principal activities may be

- a) Desilting
- b) Cleaning of weeds
- c) Cleaning of obstruction, debris and blockage
- d) Repairing of lining immediately at the commencement of damage or deterioration

7.4. Continuous action and attention to detail are important aspects pertaining to maintenance programmes. It is very essential that maintenance unit have all the drawings of existing drains showing all technical details on ground. The drain should be identified by suitable numbering with proper chainage. It should be the endeavour to ensure that works are maintained as per details shown in the inventory prepared just after completion of the drainage scheme.

7.5. The cleaning routine should indicate clearly the work to be done, the frequency for that work, the equipment and labour to be used and most important any safety measure and equipment required. The cleaning is required for all the elements namely, the kerb channel, bell mouth, the pipe, grit chamber/inspection chamber and the drain. Though, it is not practicable to assign individual frequencies for each element as a routine for each area, it should be such to ensure that various elements are cleaned before the drain gets blocked. For different localities, it may have to be based on local experience.

7.6. It is a common practice that all drains are desilted thoroughly before onset of monsoon. All kutchra side drains require dressing and deepening before monsoon. It is also essential that all the drains are in a state of repair and the works of regrading, reshaping or profile correction, wherever required is completed well before the onset of monsoon. In case of pipe drains, if it is not possible to desilt it manually, suitable mechanical devices, as described in 7.10 shall be employed. Success of such operation can be ensured only through proper inspection by all field officers rather than leaving it only to maintenance gangs. Outfall structures and the cross drainage structures also require similar treatment.

7.7. During the rains also, a watch should be kept at the exit and entry point for water for the presence of undesirable collection of rubbish, polythene/paper bags blocking the passage of water and in every way ensuring free unobstructed flow of rain water. The condition of road camber also needs to be watched. During rains, specially after heavy showers, all cross drainage structure should be inspected to observe any

blockage due to debris, log of wood and other such materials. A watch on the deficiencies in the drainage system should be kept and problem locations identified and a record kept. Necessary corrective measures should be adopted immediately after rains. A watch on missing manhole covers and broken covers is also required to be kept and replacement/repairs carried out on priority to avoid accidents.

7.8. Some of the common deficiencies encountered in road drains and suggested remedy is as under:

Deficiency	Cause	Remedy
i) Ponding	Inadequate cross-section, formation of depression or settlement in bed, bed erosion.	Deepening the drain, re-filling eroded or depressed area.
ii) Silting	Invert slope inadequate, excess soil entry into the system, less flow compared to design section	Improvement in slope if possible. Check entry points for silt rubbish etc. Measures to concentrate flow to lean season. Provision of jali at entry points.
iii) Blockage due to debris vegetation etc.	Uneven drain bed, absence of maintenance, cleaning.	Desilting and cleaning. Provision of jali at entry points.
iv) Erosion of bed and cross section.	Steep invert slope, caving in of sides because of lack of lateral support.	Provide flatter slope with drops, if needed. Adequate side support, re-alignment, if required.

7.9. Maintenance of Subsoil Drainage

Subsoil drainage uses porous pipes, lateral and vertical layers of granular material and man made fabrics and membrane. Such drainage techniques are largely built in features of the design, and do not lend themselves to routine maintenance. Their presence and the intended mode of operation must be known and understood by the maintenance Engineer. Many of these systems tend to clog over a period of time and may need

replacement. In such cases, obvious surface signs, such as flooding, or instability of pavements may be the first warning of the system failure. The most critical aspect of subsoil drainage is the provision of detailed "as built" information to the maintenance personnel to reduce the risk of inadvertent disruption of the intended operation during subsequent maintenance works.

For the purpose of easy identification it would be necessary that location of various inlets, outlets, intermediate pits along the drainage lines are marked using pegs on the ground. Same numbering should be available on the pegs and the drawings. Following guidelines may be followed for maintaining the expected performance level of subsurface drains.

- a) The drainage system should be inspected at least twice a year out of which at least one should be immediately after heavy rains. The quality and quantity of outflow should be observed and recorded. It is to be noted that pavement drains discharge water after rains only whereas drains installed to lower subsoil water table or intercept underground seepage could carry water even in dry season. Muddy water could indicate non functional filter and no flow could indicate a blocked drain.
- b) Inlets should be inspected for signs of structural damage, vandalism and blockage and corrective action taken.
- c) Outlets should be inspected for scour, structural damage and blockage. The routine maintenance consists of removal of siltation, removal of grass and repair of any minor scour.
- d) A check should be made to ensure that surface runoff does not enter the subsoil drainage system.
- e) A check should be made to ensure that marker pegs are not missing and are visible.
- f) Pit covers and frames should be replaced if damaged and pits relocated if damaged frequently.

7.10. Storm Water Drain Cleaning Equipment and Devices

Covered drains and pipes, though solve other problems do not lend themselves to cleaning easily as their size is small. Many a times, the cleaning is done only at the location of manholes or inspection chambers or near the location of removable slabs. This does not give satisfactory level of service as the pipes or the main channel remains blocked and full design cross section is not available. As such it is necessary that proper attention

is paid to this aspect and available cleaning equipments and devices are used. In some cases it may be necessary to adopt the commonly used sewer cleaning devices for this purpose.

Covered drains and pipes carrying storm water can be cleaned using following equipment and devices. When cleaning after a dry spell, it would be necessary that water is let into the manholes for the deposited silt to get softened for its removal by mechanical devices.

i) Portable pump set

In cases where the drains are blocked completely and water has accumulated in the manhole/road side, the collected water has to be pumped out to tackle the blockage. Such pumps, should preferably be non clogging type on four wheel trailers and should be of self priming type to save time and effort.

ii) Sectional sewer rods

These rods (Fig. 7.1) are used for cleaning small lines. These rods may be of bamboo or teakwood or light metal usually about 1M long. The ends have coupling arrangement which remain intact in the line but can easily be disjoined in the manhole. Sections of the rods are pushed down the line until the obstruction is reached and dislodged. The front or the advancing end of the rod is normally fitted with a cutting edge to cut and dislodge the obstruction.



Fig. 7.1. Jointed sewer rods

iii) Flexible sewer rods

The flexible rod used in manual cleaning is usually made by sand-witching a manila rope between bamboo strips and tying at short intervals. The flexible rod is introduced first from one manhole to the other, its end being connected to a thicker rope which, when dragged down the line draws out deposited material into the down stream manhole from where it can be removed easily.

iv) Ferret used in conjunction with a water jet

This is used for breaking and removing the deposited material. It uses a fire-hose connection and produces a small but high velocity stream of water forward in the upstream direction from the central nozzle and several lower velocity jets in the down stream direction. The forward jet loosens the accumulated debris ahead and the rear jet washes it back down stream. This device must be attached to a fire-hose of sufficient length to reach the next manhole. Also, it must be kept in motion to prevent sand/silt from locking the fire hose in the line. A suitable pump and water arrangement through a water tanker is required to be used along with this device.

v) Bucket machine

The bucket machine (Fig. 7.2) consists of two powered winches with cables in between. The winches are centred over two adjacent manholes. The cable is threaded through the line by using flexible rods. The cable from the drum of each winch is fastened to the barrel on each end of an expansion bucket fitted with closing device, so that the bucket can be pulled in either direction by the machine on the appropriate end. The bucket is pulled into the pipe line until the operator feels that it is loaded with silt. This motor is then disengaged through a clutch system and the opposing winch is put into action. When the opposite pull is started, the bucket automatically closes and the deposited material comes out. This operation is repeated till the entire line is clear. This machine is also used along with other scraping instruments for loosening the deposited material or cutting roots and dislodging obstructions.

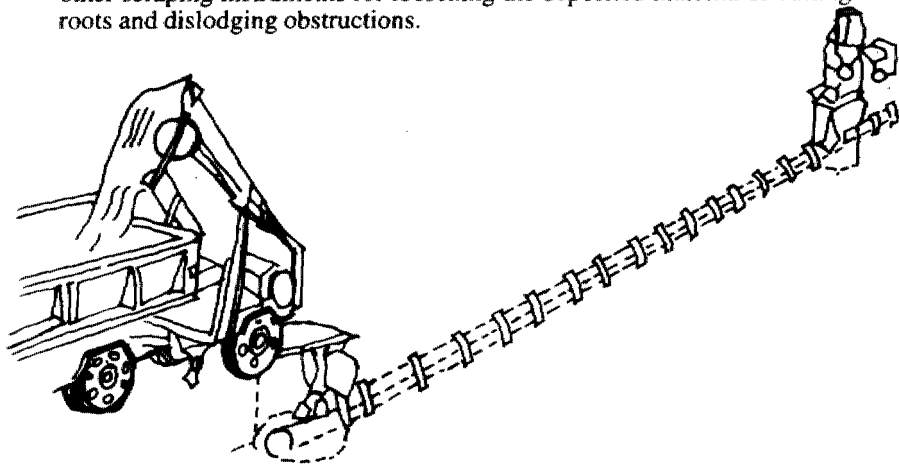

Fig. 7.2. Sewer cleaning bucket machine

vi) Rodding Machine with flexible rods

This consists of a machine which rotates a flexible rod to which a cleaning tool such as auger, corkscrew, sand cups is attached (Fig. 7.3 & 7.4). The flexible rod consists of a series of steel rods with screw couplings. The flexible rod is guided into the manhole through a bent pipe. The machine rotates the rod with cleaning tool (Fig. 7.5) attached to the other end. The rotating rod is pulled in and out in quick succession so as to dislodge or loosen the obstruction. When the obstruction is cleaned, the rod is pulled out by means of clamps.

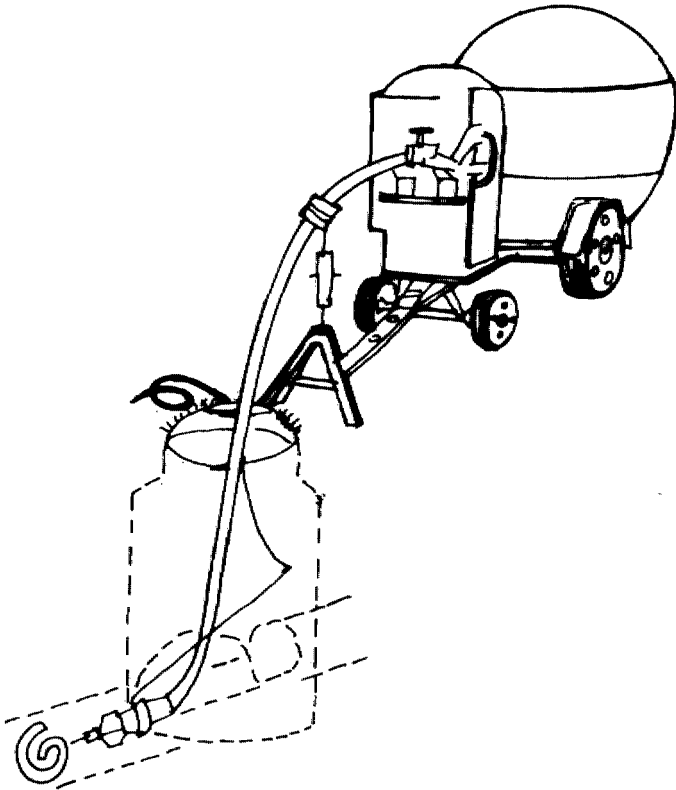

Fig. 7.3. Rodding machine with flexible sewer rods

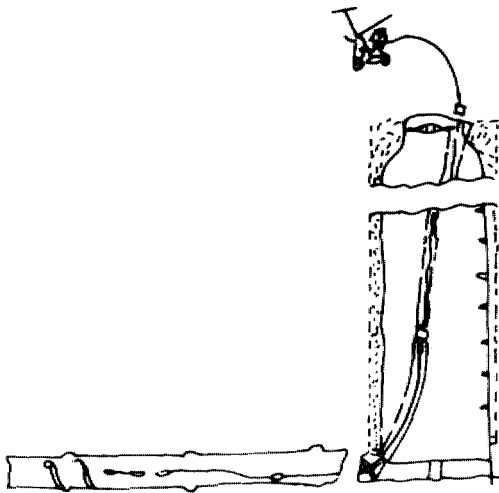
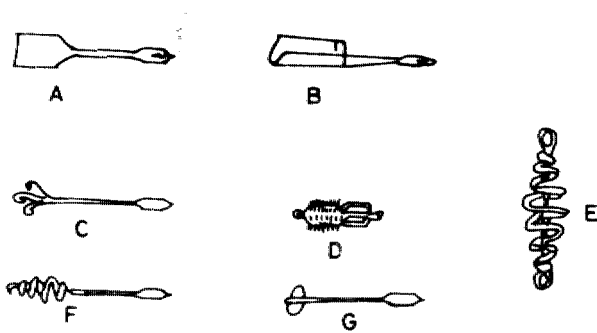

Fig. 7.4. Power operated steel flexible rods



- A GOUGE FOR CUTTING OBSTRUCTIONS
- B SCOOP TO REMOVE SAND AND LOOSE MATERIAL. A FLAGGATE ON THE END IS DESIRABLE
- C CLAW AND SERREW FOR REMOVING PAPER AND RAGS
- D BRUSH FOR REMOVING GREASE
- E ROOT CUTTER
- G SCRAPER

Fig. 7.5. Sewer cleaning tools

vii) Scraper

This method is used for pipes of dia larger than 750 mm. The scraper is an assembly of wooden planks of slightly smaller size than the pipe to be cleaned. The scraper chain, which is attached to the scraper is connected to a winch on the next downstream manhole by means of chain. The winch is then operated to push the debris ahead of the scraper. The heading up of flood behind the scraper will also assist in pushing it in the forward direction.

viii) Hydraulically propelled rubber balls

The ball used is of soft rubber and is inflated to slightly less diameter than the pipe. A rope is attached to the ball and it is allowed, to travel from a manhole downstream in the pipe. The ball adjusts itself to the irregularities in the pipe, but the water held behind it escapes in a strong stream between the ball and the pipe thus flushing the debris. Some of the balls have spiraled ribs which impart a rotary motion to the water on the downstream side. Others are enclosed in a light chain network or a canvas cloth.

7.11 In case of blockage of drain due to settlement, the drain section is required to be repaired after locating the settled portion.

8. SUB SURFACE DRAINAGE

8.1 Subsurface water in the granular layers or in the subgrade of a pavement may harm the road in various ways.

- a) The presence of water reduces subgrade strength. The strength of granular bases/sub-bases are strain dependent and poor strength in subgrade affects the performance of top granular layers also.
- b) Heavy wheel loads may create pulsating water pressure resulting in internal erosion and ejection of materials through cracks and joints. This, coupled with movement of subsoil water, changes the arrangement of fine to coarse material and aggregates in the structure resulting in weakened granular bases, cement treated bases and stabilised layers.
- c) Absorption of water in the filler material, which may not be fully non-plastic, may seriously undermine the load support characteristics of the layer.

- d) Free water in bituminous pavements results in stripping of the binder leading to faster cracking and deterioration.

8.2. For design of subsurface drainage system the source and quantum must be determined, the ingress of water may take place from

- a) Top i.e. surface infiltration of rain water through paved or unpaved areas,
- b) Lateral seepage through shoulders and verges, and
- c) Free water from a high water table or capillary action from a water table.

8.3. In most urban areas the percentage of built up surface area is rather high and as such situations with problems of subsurface water may not be frequent unless the water table is unusually high and the subgrade soil is poor from point of view of drainage. Physical condition of nearby roads, presence of vegetation which usually occur in wet soils and the local experience helps in selecting areas for detailed investigation. During detailed investigation following information is collected:

- i) Rainfall data for the area and the design storm. This aspect has already been covered in Chapter-4.
- ii) Assessment of ground water conditions. This is achieved by making boreholes, trenches and pits. Water levels and inflows should be carefully recorded at the time of excavation. Pumping tools can be used to establish the in-situ permeability of materials, and the rate of recoupment of ground water. For gathering information on water table using piezo - meters, understanding the location of various strata through study of bore log is essential, these are required to be installed in the strata which influences water table level. As such, these should never be installed at a predetermined depth but should be installed in the particular strata.
- iii) Assessment of the soil properties, information in respect of soil classification, Atterberg Limits and moisture content of soil at subgrade level and other levels in areas where water is present is collected.

8.4. Drainage of Surface Infiltration

8.4.1. Road surfaces, medians, shoulders and rainfall on higher adjoining areas are permeable and the precipitation invariably seeps down.

Collection of water in potholes and undulations etc. also contributes to seepage cracks in pavement, particularly due to ageing, defects and joints also permit ingress of water into the road structure. For design purpose, the quantity of water which is required to be drained off is dependent upon the intensity of rainfall and the coefficient of infiltration or the infiltration factor. Commonly adopted ranges are

i)	Earthen shoulders	0.4 to 0.6
ii)	Bituminous pavement	0.2 to 0.4
iii)	Concrete pavements	0.3 to 0.4

8.4.2. The best way of drainage of pavement course is to provide and extend a specially designed sub-base layer upto the embankment slope face. In urban situations this may not always be possible. In such a case, provision of a sub-surface drain is made. The sub-base layer and the sub-surface drain should have sufficient capacity to carry the design discharge. Flow through sub-base layer, which is considered as saturated laminar flow, is calculated using Darcy's Law and the flow through pipes is calculated using Mannings formulae. The Darcy's Law given

$$Q = K i A$$

where,

Q = discharge in $m^3/sec.$

K = Coefficient of permeability in $m/sec.$

i = Hydraulic gradient

A = Cross section area in m^2 perpendicular to the direction of flow

8.4.3. Sub-base and base should have self draining provisions by extending granular drainage layer fully over the road formation width. Ref. Fig. 8.1. In addition, proper cross fall to the drainage layer should be provided to guard against any sluggish flow. Road subgrade should also be provided with a cross fall appropriate to the material with which it is built so that there is no accumulation of water on top of the subgrade due to sluggish flow at that level. As a general rule, the lower pavement layer should be more permeable than the upper one. In case of existing pavements, where such situation may become unavoidable from other considerations, the overlaid layer having larger voids should be drained off laterally to avoid interfacial drainage problems and premature failure of the overlaid layer. Typical arrangement of drainage of pavement is shown in Fig. 8.2. Typical examples to determine permeability requirement of drainage layers and the quantity of flow are given in *Appendix A-4*.

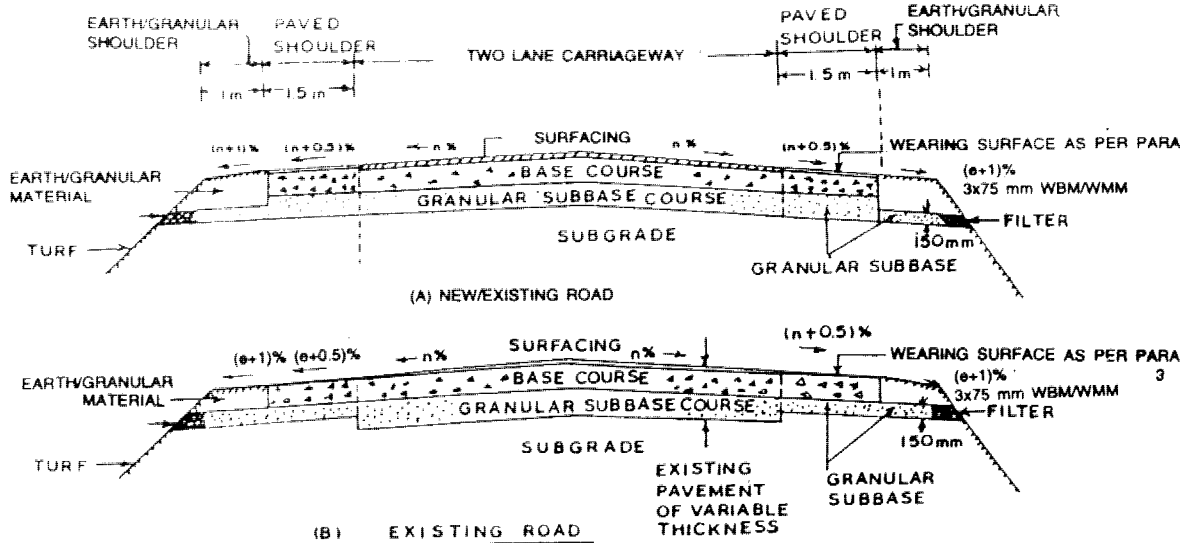

NOTATION

- e = CROSS FALL (CAMBER) OF PAVEMENT
- WBM = WATER BOUND MACADAM.
- WMM = WET MIX MACADAM.

NOTES:

1. (e+1)% CROSSFALL SHALL NOT BE LESS THAN 2.5 TO 3% ON GRANULAR SHOULDER AND 3 TO 4% ON EARTH SHOULDER – STEAPER VALUES SHALL BE USED FOR RAINFALL EXCEEDING 150 CM PER YEAR.
2. ON SUPERELEVATED SECTIONS THE SHOULDER SHOULD HAVE SAME CROSSFALL AS THE PAVEMENT

Fig. 8.1. Typical cross section of paved shoulders

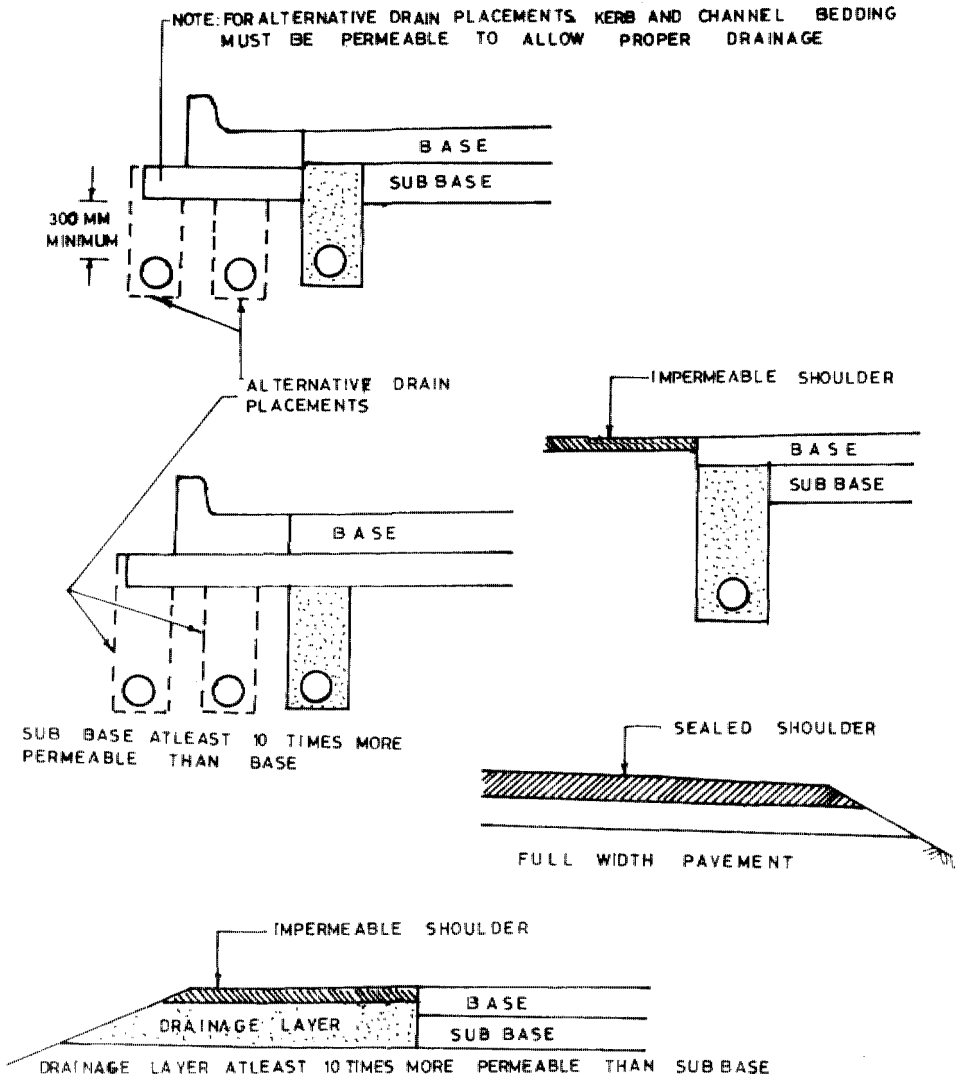

Fig. 8.2. Examples of satisfactory pavement drains

8.5. Drainage of Subsurface Water

8.5.1. Darcy's Law is applicable for subsurface flow of water. However, in actual practice one encounters soil or rock formations which are highly heterogenous and have anisotropic permeabilities. Fissures, joints, faults and bedding planes in soils and rock structures may give quite different properties and misleading ground water conditions. Applications of theoretical models to complex natural situations can lead to errors in estimation of quantity of flow and flow conditions. For these reasons field observations and measurement is the best guide. Also, interpretation of observations should be done by those who have geotechnical skills. In some cases, it may be desirable to arrive at the solution through trial either before or during early construction phase of a project by measuring the flows and water table. The depth of drain is increased or additional provision made at closer spacing. It may also be necessary to have field or laboratory determination of permeability coefficients in the selection of pavement, shoulder, surfacing and drainage materials. As a general guide permeability ranges are given in Fig. 8.3. For a successful design using range of permeability for a given material, the highest permeability value should be used when the material is to act as a barrier and the lowest value used when the material is being used to allow water to pass through.

Some typical arrangements indicating use of formation drains and drainage blanket is shown in Fig. 8.4. The drainage can be effected by installation of solid pipes with open joints, perforated pipes and the like surrounded by free draining material or the filter. The filter material is required to prevent fine soil particles from flowing into the system, at the same time it should have required degree of permeability for drain off the required quantity of water. Also, the filter material must be more permeable than the surrounding material and stable under flow situations so as not to flow into perforations or joints in drainage pipes.

8.6. Aggregate Filters

A properly designed and installed aggregate filter should be able to retain soil and prevent soil particle movement, thus eliminating piping potential. Properly, designed aggregate filters ensure that there are no large voids within the filter and particularly at the soil filter interface of a subsurface drainage structure. A single component aggregate filter may be used to protect relatively coarse soils whereas drainage through fine soils usually require a multi-layered aggregate filter. A multi-layered filter consists of a fine aggregate gradation which retains the natural soil particles at their original positions and a coarser filter aggregate which prevents particles of the fine aggregate filter from migrating into the perforations of a drainage pipe or granular water transport medium. Fig. 8.5 shows, in a

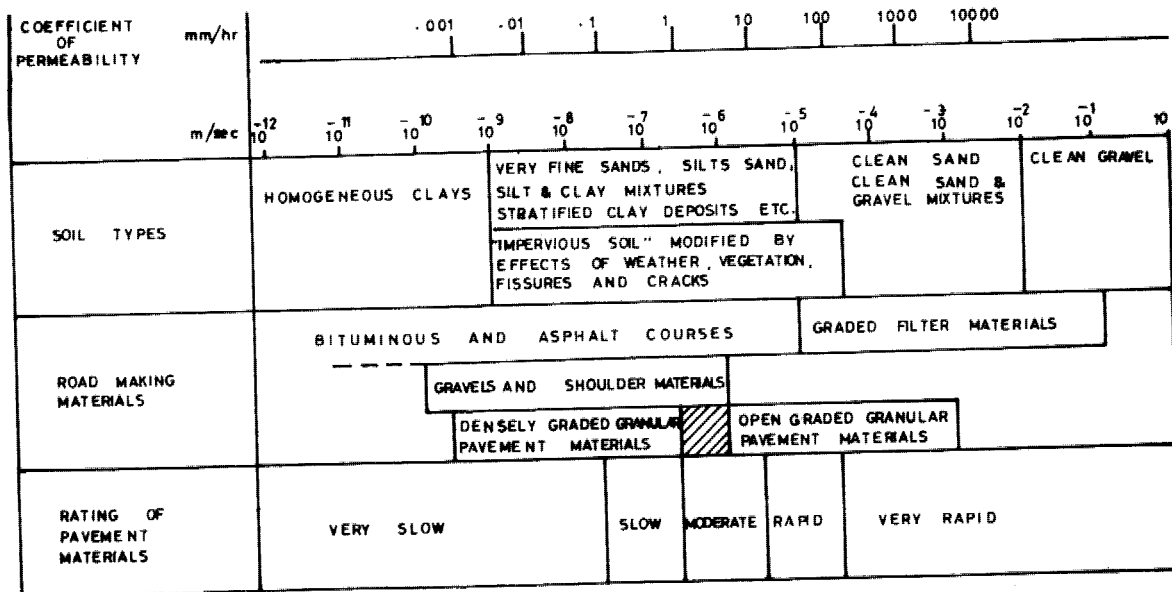
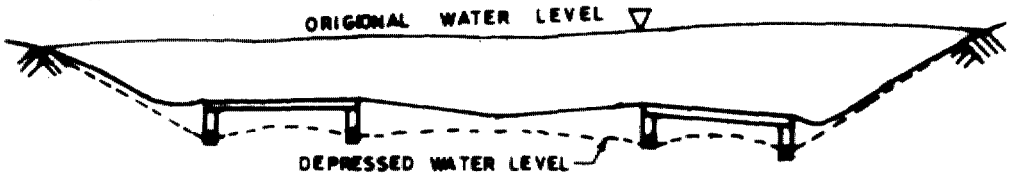
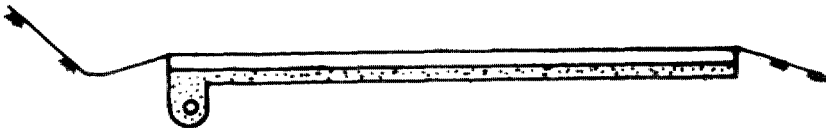

Fig. 8.3. Permeability ranges



DEEP FORMATION DRAINS TO LOWER A WATER TABLE



DRAINAGE BLANKET TO PREVENT WATER TABLE FROM RISING INTO PAVEMENT LAYERS

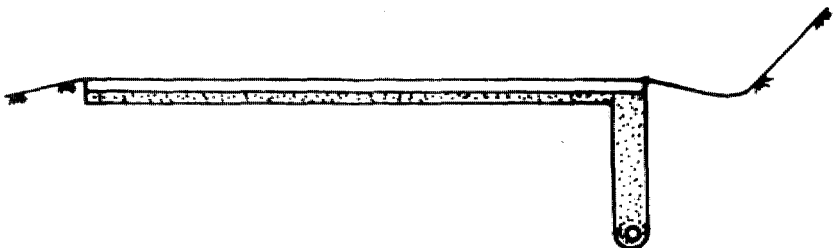

DRAINAGE BLANKET COMBINED WITH DEEP FORMATION DRAIN

Fig. 8.4. Techniques for lowering a water table

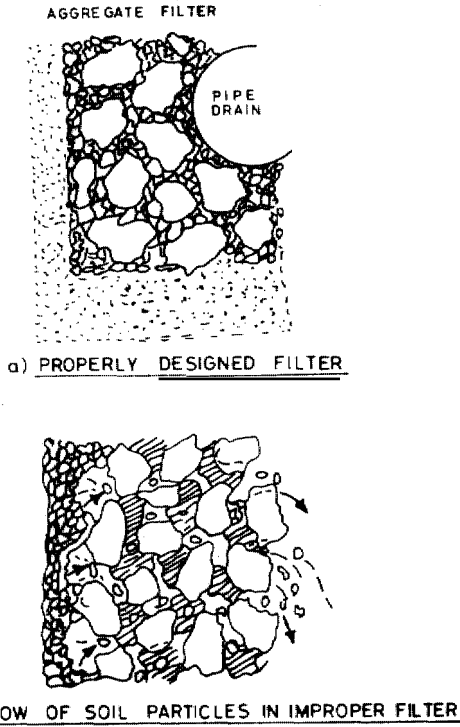

Fig. 8.5. Mechanism of flow through properly designed filter

schematic way, the effect of a properly designed filter and improper filter. MOST Specifications for Road and Bridge Works (Third Revision) gives the grading requirement for filter material and also the grading requirements for aggregate drains. These are reproduced as Tables 8.1 and 8.2 for ready reference. It must be remembered that if the aggregate gradation is too coarse, the gaps and voids at the soil aggregate interface may be so large that the adjacent soil particles will not bridge or be retained. However, if the gradation is too fine, insufficient water flow may result in build-up of hydrostatic pressure. Theoretical gradation of filter material is also possible based on empirical relationships between the particle size of soil and the filter using filtration as well as permeability criterion.

Table 8.1. Grading Requirements for Filter Material

Sieve Designation	Per cent passing by weight		
	Class I	Class II	Class III
53 mm	-	-	100
45 mm	-	-	97-100
26.5 mm	-	100	-
22.4 mm	-	95-100	58-100
11.2 mm	100	48-100	20-60
5.6 mm	92-100	28-54	4-32
2.8 mm	83-100	20-35	0-10
1.4 mm	59-96	-	0-5
710 micron	35-80	6-18	-
355 micron	14-40	2-9	-
180 micron	3-15	-	-
90 micron	0-5	0-4	0-3

- Note: 1. When the soil around the trench is fine grained (fine silt or clay or their mixture) then Class I gradation, when coarse silt to medium sand or sandy soil then Class II grading and when gravelly sand then Class III grading should be adopted.
2. The thickness of backfill material around the pipe should not be less than 150 mm. Considering minimum diameter of the pipe as 150 mm, width of the trench should not be less than 450 mm.

Table 8.2. Grading Requirements for Aggregate Drains

Sieve Size	Per cent passing by weight	
	Type A	Type B
63 mm	-	100
37.5 mm	100	85-100
19 mm	-	0-20
9.5 mm	45-100	0-5
3.35 mm	25-80	-
600 micron	8-45	-
150 micron	0-10	-
75 micron	0-5	-

8.7. Fabric Filters

8.7.1. Filter fabrics or Geotextiles are generally manufactured from polyethylene or polypropylene or similar fibres, either woven or non-woven in variety. Specification of Geotextile has been covered in IRC Specifications for Road & Bridge Works and has not been repeated here. For subsoil drainage system bio-degradable fabric filters are not used as their life span is very short. Geotextiles eliminate the need for aggregate filters. The fine pore size and high permeability of these filters make one filter suitable for protecting a broad range of soil gradations. Also, such filters are available with varying pore sizes and permeability properties so as to meet the need of nearly all subsurface drain designs. Some typical example of use of fabrics as filters is shown in Fig. 8.6.

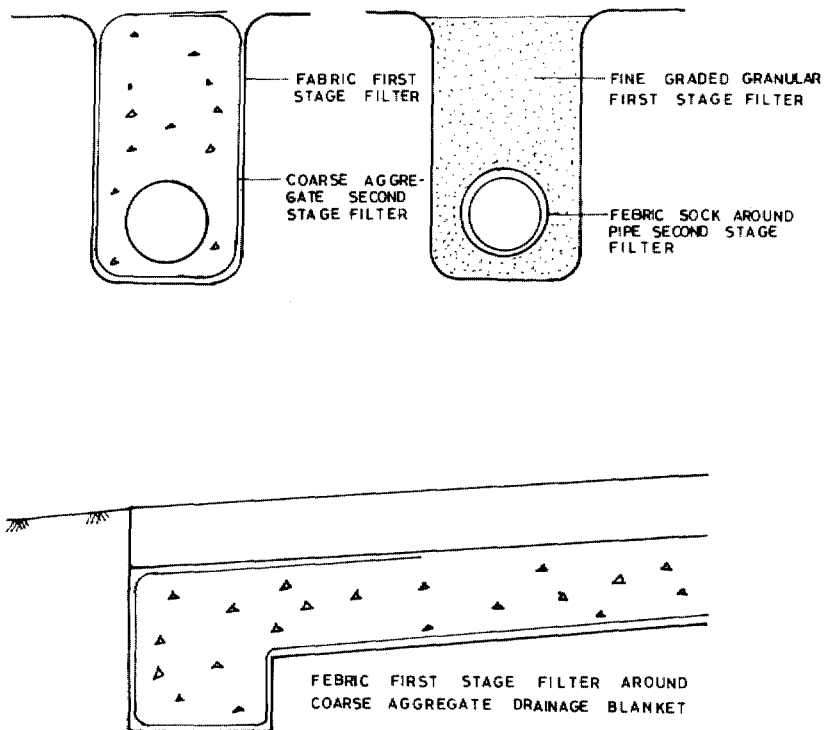

Fig. 8.6. Uses of fabrics as filters

8.7.2. Briefly, there are three basic requirements on the elements of filter criteria for drainage fabrics. These are:

- a) Retention (of interface soil) Ability

$$\text{It is specified by } \frac{\text{EQS}}{D_{85 \text{ soil}}} < 3$$

Where, EQS is the equivalent opening size and is defined as the size of standard sieve having opening closest in size to the filter fabric and is determined by sieving glass beads through the fabric.

D85 soil = nominal diameter of soil particles for which 85 per cent of the soil gradation is finer - determined by grain size distribution analysis.

- b) Permeability: The permeability of the fabric filter should be substantially greater than that of the protected soil. For proper flows:

$$K_{\text{fabric}} > 10 K_{\text{soil}}$$

Where K is the coefficient of permeability

- c) Clogging Resistance: The clogging behaviour of a geotextile should be evaluated in a test that simulates actual use conditions. One such test is to make up a slurry of the soil to be filtered and filter it through a sample of the fabric. If the finest particles pass through without clogging the fabric, and the rate of flow is satisfactory the fabric may be considered to perform adequately as a filter.

8.8. Subsoil Water Drainage System

The purpose of the subsoil drainage is to collect the water from its source and ultimately dispose off to a place where it can do no harm to the road. It consists of the filter, the pipe inlets, intermediate pits and the outlet. Marker pegs are also installed to indicate their location. A schematic diagram of the system is shown in Fig. 8.7.

8.9. Use of Subsoil Drainage for Special Locations

In urban areas utility services usually run parallel to the road and in many cases, due to widening of roads they get burried below the pavement or the footpath. Due to large temperature variations particularly when the season changes and vibrations of the moving traffic, some of the joints of underground water supply pipe may leak leading to subsoil water conditions and damage to road. In such locations, subsoil water drainage arrangement should be made to safeguard the structural soundness of the road.

COMPUTATION OF INTENSITY OF RAINFALL FOR A PARTICULAR STORM DURATION

Following steps are to be followed :

- a) Rainfall data for a particular city is available for 26 years. The analysis of data gives the frequency of storms of stated intensity and durations which is given in Table A.1.1. .

Duration in minutes	Table A.1.1.								
	No. of storms of stated intensity or more for a period of 26 years (mm/hr)								
	30	35	40	45	50	60	75	100	125
5					100	40	18	10	2
10			90	72	41	25	10	5	1
15		82	75	45	20	12	5	1	
20	83	62	51	31	10	9	4	2	
30	73	40	22	10	8	4			
40	34	16	8	4	2	1			
50	18	8	4	3	1				
60	8	4	2	1					
90	4	2							

- b) The stepped line indicates the location of the storm occurring once in two years i.e. 13 times in 26 years. The time intensity values for this frequency, i.e. once in two years are then obtained by interpolation and is as given in Table A.1.2. :

Table A.1.2.

i (mm/hr)	30	35	40	45	50	60	75
t (min)	51.67		36.48		16.50		8.12
		43.75		26.57		14.62	

- c) Any one of the following equations can be used :

$$i = \frac{a}{t^n} \quad \dots (i)$$

or

$$i = \frac{a}{t + b} \quad \dots (ii)$$

Where,

i = intensity of rainfall in mm/hr.

t = duration of storm in minutes.

and a , b & n are constants which are dependent upon rainfall characteristics of a particular area - and will not be same for all parts of the country. It is more convenient to obtain the value of ' i ' for any particular time ' t ' using graphical form. The equation (i) gives a straight line when plotted on a double log paper and equation (ii) gives a straight line when reciprocal of i is plotted against t on an arithmetical graph paper.

In Fig. A-1.1, $1/i$ has been plotted against t for the particular station and best fitting straight line obtained. Now, the value of $1/i$ can be read against given value of t . For example, using the graph :

i for $t = 20$ minutes will be 59.7 mm/hr

i for $t = 10$ minutes will be 52.6 mm/hr

- d) Method is also illustrated for storm frequency of one year using equation (i).

Time intensity values for one year frequency as obtained from Table A.1.1., suitably interpolated as given in Table A.1.3.

Table A.1.3.

i (mm/hr)	30	35	40	45	50	60
t (min)	44	36	28.5	22.5	13.5	9.75

The best fit plot is given in Fig. 4.5 from which for any value of i can be read for a given t using this figure,

for $t = 20$ minutes, $i = 44$ mm/hr. and,

for $t = 10$ minutes, $i = 56$ mm/hr.

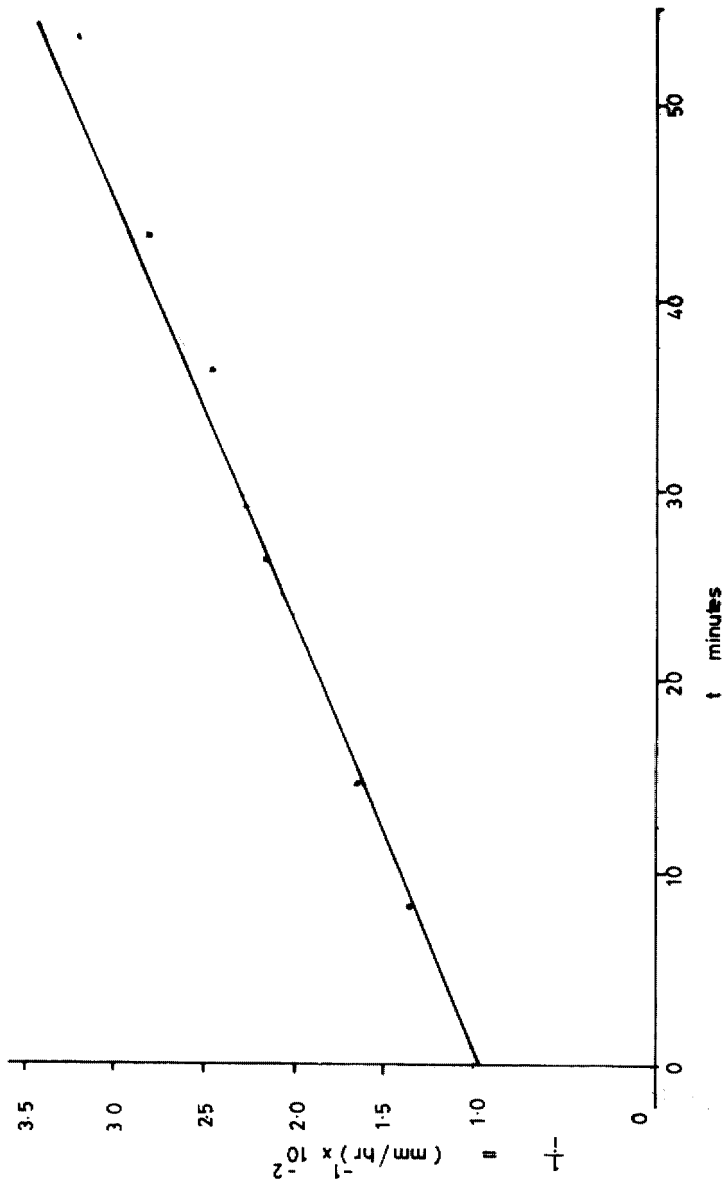

Fig. A-1.1. Graph between reciprocal of intensity of rainfall and time (in minutes)
[i - intensity of rainfall mm/hour : refer Appendix A-1]

IMPROVING STORM WATER DRAINAGE IN BUILT UP AREAS USING VERTICAL DRAINS

The method is designed to dispose the storm water into the permeable strata below the ground level in built up area where there is no side drain functioning. A brief description of the proposal is given below.

A vertical bore-hole of adequate diameter is made, the bottom of which is taken to atleast 50 cm into the permeable layer. The bore-hole is then filled with brick bats or stone aggregates. To prevent clogging of the vertical drains it is wrapped with non-woven geofabric or HDPE woven gofabric without lamination. The top portion of the vertical drain is covered with filter material for a depth of 15 cm. The number and spacing and diameter of the dreains depend upon

- i) The permeability of the strata at which the water is finally to be disposed,
- ii) The rainfall of the area,
- iii) Extent of area to be covered.

The vertical drain proposed may be constructed in conjunction with the horizontal drain to increase the rate of disposal. The vertical drain portion may also be modified by introducing a perforated PVC pipe wrapped with geotextile inside the bore-hole instead of filling it with brick bats. The above method has been tried in some parts of Tamil Nadu and found to perform satisfactory in sandy subsoil. The schematic arrangement for the system is shown in Fig.A-2.1.

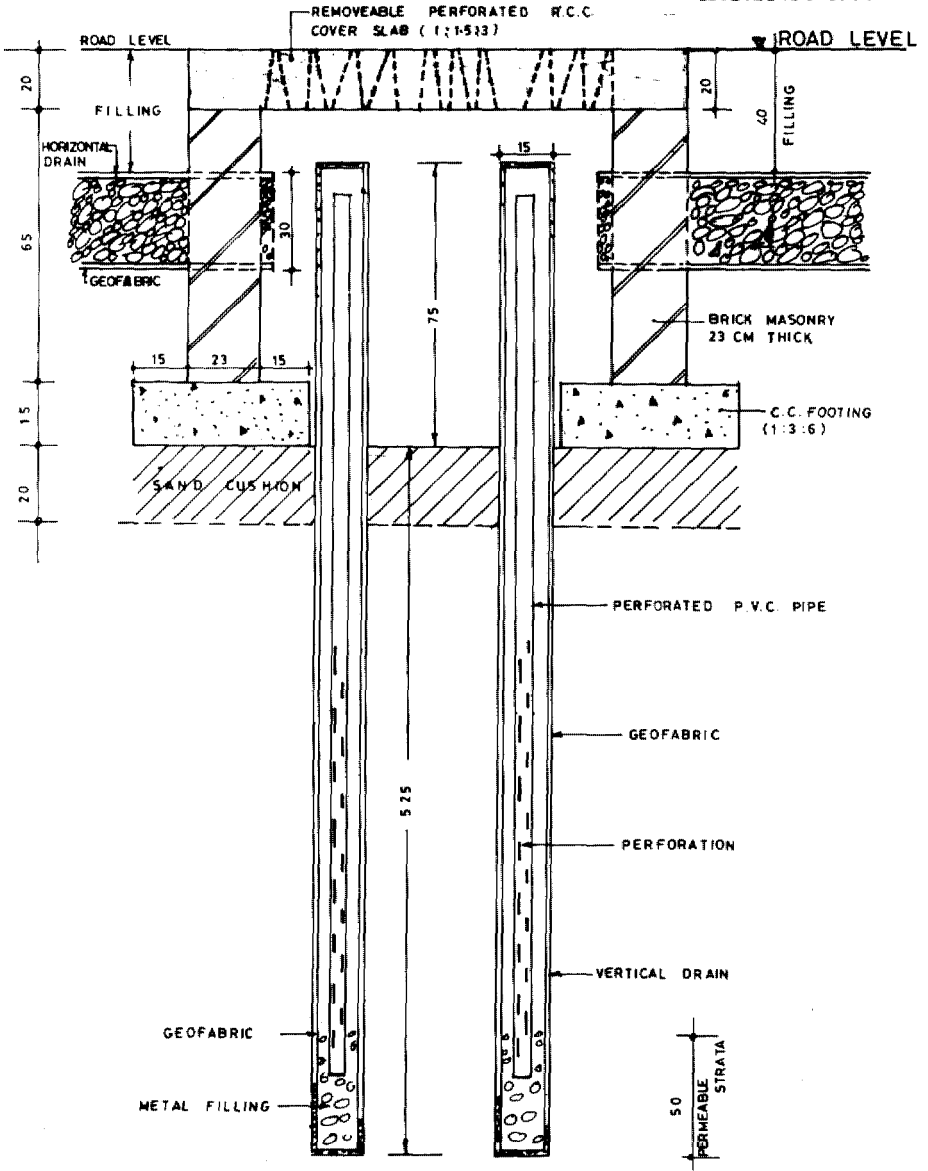

NOTE— ALL DIMENSIONS ARE IN MM

Fig. A-2.1. X-section of vertical drain

Appendix A-3

Check list (Reg.7.2)-

Broad Checklist for Maintenance of Drains

1. Pavement crown or cross slope is maintained in design profile conducive to quick drainage.
2. Road shoulders are clear and dressed for efficient clear off.
3. If there is a need for new side drain chutes in high embankment.
4. If the kerb channel is clean and slopes towards the inlet.
5. If the kerb inlets/bell mouths are clear.
6. The drain is desilted before rainy seasons, all manholes and grit chambers are cleaned.
7. Inspect after heavy rains to know the deficiencies in the system. Report unsatisfactory performance and also frequent repair requirements.
8. Inspect in Oct./Nov. and list defects for summer maintenance.
9. Gratings/metallic covers should be checked for repair or replacement.

Appendix A-4
Refer Para 8.4.3

Typical Examples of Subsoil drainage

1. To determine permeability requirement of drainage layer to dispose off infiltration water.

Given: The design rainfall intensity of a city is 5 cm/hr. The pavement camber is 3 per cent and the longitudinal gradient is 4 per cent, coefficient of infiltration is 0.3. It is proposed to utilise a permeable layer 250 mm thick to carry this water to subsoil drainage trench on the low side of the pavement.

Quantity of water entering the pavement per metre length of carriageway = $0.05 \times 1 \times 1 \times 0.3 = 1.5 \times 10^{-2} \text{ m}^3/\text{hour}$.

The camber of 3 per cent and longitudinal gradient of 4 per cent gives a resultant slope of 5 per cent at an angle of about 37° to the centre line. The width of longitudinal 1 m wide pavement along the line of maximum slope is therefore 0.6 m.

Darcy's equation can be written as:

$$K = \frac{Q}{iA} = \frac{1.5 \times 10^{-2}}{0.05 \times 0.25 \times 0.6} = 2\text{m/hr}$$

Or, required $K = 5.55 \times 10^{-4} \text{ m/sec}$.

2. To determine quantity of water intercepted by a formation drain provided across a water charged permeable layer.

Given: Thickness of permeable layer is 2.0 m and is on a 15 per cent slope. The permeable strata is silty sand having maximum permeability of $1.8 \times 10^{-5} \text{ m/sec}$.

$$\text{or } Q = 1.8 \times 10^{-5} \times 0.15 \times 2$$

$$= 6.4 \times 10^{-6} \text{ m}^3/\text{sec. per m length of the drain}$$

Thus, the formation drain and the pipe should be of sufficient capacity to cater for this discharge and any particular section of the drain should be designed for cumulative discharge upto that point.