

**MANUAL OF  
SPECIFICATIONS & STANDARDS  
FOR FOUR LANING  
OF HIGHWAYS THROUGH  
PUBLIC PRIVATE PARTNERSHIP**

ASC BOOK 54



**INDIAN ROADS CONGRESS  
2009**

Published in October, 2009  
Reprinted : March, 2010

## CONTENTS

Sl. No.	Particulars	Page No.
	Personnel of the General Specifications and Standards Committee	v
1.	General	1
2.	Geometric Design and General Features	9
3.	Intersections and Grade Separators	35
4.	Embankment and Cut Sections	39
5.	Pavement Design	45
6.	Highway Drainage	55
7.	Design of Structures	63
8.	Materials	81
9.	Traffic Control Devices/Road Safety Devices/Road Side Furniture	89
10.	Toll Plazas	111
11.	Landscaping and Tree Plantation	123
12.	Project Facilities	129
13.	Special Requirements for Hill Roads	145
	Appendix -1	151
	Appendix -2	154

*(The Rights of Publication and Translation are reserved)*

Printed at India Offset Press, New Delhi-110 064  
(2000 copies)

**PERSONNEL OF THE GENERAL SPECIFICATIONS  
AND STANDARDS COMMITTEE (GSS)  
(10<sup>th</sup> June, 2009)**

- |    |   |  |
|----|---|--|
| 1. | Shri V.K. Sinha<br>(Convenor)           | The Addl. Director General - I, Ministry of Shipping,<br>Road Transport & Highways, Deptt. of Road Tpt &<br>Highways, Transport Bhavan, New Delhi - 110 001  |
| 2. | Shri Nirmaljit Singh<br>(Co-Convenor)   | The Addl. Director General - II, Ministry of Shipping,<br>Road Transport & Highways, Deptt. of Road Tpt &<br>Highways, Transport Bhavan, New Delhi - 110 001 |
| 3. | Shri C. Kandasamy<br>(Member-Secretary) | The Chief Engineer (R) (S & R), Ministry of<br>Shipping, Road Transport and Highways,<br>Transport Bhavan, New Delhi - 110 001                               |

***Members***

- |     |                         |   |
|-----|-------------------------|---|
| 4.  | Shri R. D. Ram          | Engineer-in-Chief-cum-Addl. Comm. -cum-Spl.<br>Secretary, Rural Construction Deptt.,<br>Vishweshwaraiya Bhawan Campus,<br>Patna - 800 015 |
| 5.  | Shri Shailendra Kumar   | Chief Engineer (NH), M.P. P.W.D.,<br>Satpura Bhawan, 1st Floor, Bhopal - 462 003  |
| 6.  | Shri H.S. Chahal        | Vice Chancellor, Deenbandhu Chotturam<br>University of Science & Technology,<br>Murthal, Sonipat  |
| 7.  | Prof. S. S. Chakraborty | Managing Director, Consulting Engg. Services (I)<br>Pvt. Ltd., 57, Nehru Place, New Delhi - 110 019                                       |
| 8.  | Shri P. K. Datta        | Executive Director, Consulting Engg. Services (I)<br>Pvt. Ltd., 57, Nehru Place, 5th Floor<br>New Delhi - 110 016                         |
| 9.  | Shri H. D. Vala         | Chief Engineer (R & B) Deptt., Govt. of Gujarat,<br>Block No-14, New Sachivalaya,<br>Gandhinagar - 382 010                                |
| 10. | Shri A. N. Dhodapkar    | Chief Engineer, Ministry of Shipping, Road<br>Transport & Highways, Transport Bhavan,<br>New Delhi - 110 001                              |
| 11. | Shri D. P. Gupta        | DG (RD) & AS, MOST (Retd.)<br>D-21, Greater Kailash Part-I Enclave,<br>New Delhi - 110 048  |

12. Shri Vishwas Jain Managing Director, Consulting Engineers Group Ltd., E-12, Moji Colony, Malviya Nagar, Jaipur
13. Shri A. C. Bordoloi Chief Engineer (N. H. Works), Assam, Chandmari, Guwahati - 781 013
14. Shri D. G. Marathe Chief Engineer, Nasik Public Works Region, Trimbak Road, Nasik - 422 002
15. Shri Pinaki Roy Choudhury Managing Director, Lea Associates (SA) Pvt. Ltd. B-1/E27, Mohyan Co-op. Industrial Estate, Mathura Road New Delhi - 110 044
16. Shri A. D. Narain DG (RD) & AS MOST (Retd.), B-186, Sector-26, Noida - 201 301
17. Shri Arun Kumar Mahajan Engineer-in-Chief, H. P. PWD, U. S. Club, Shimla - 171 001
18. Shri B. C. Pradhan Chief Engineer (NH), Sachivalya Marg, Unit-IV, Bhubaneshwar - 751 001 Orissa
19. Shri S. K. Puri Member (Technical), National Highways Authority of India, Plot No. G - 5 & 6, Dwarka, Sector 10, New Delhi - 110 075
20. Shri K. B. Rajoria Engineer-in-Chief, Delhi PWD (Retd.), B-25, Greater Kailash Part II Enclave, New Delhi - 110 048
21. Shri V. Ravindranath Chief Engineer (R & B) & Managing Director, APRDC, Room No. 207, NH Building, Errummanzil, Hyderabad - 500 082
22. Shri S. N. Das Chief Engineer (Mech.), Ministry of Shipping, Road Transport & Highways, Transport Bhawan, New Delhi - 110 001
23. Shri Ramesh Chandra Chief Engineer (Rohini), Delhi Development Authority, Sector-3, Near Deepali Chowk, Rohini, Delhi - 110 085
24. Shri Rama Shankar Sharma Past Secretary General, IRC, C-478, II Floor, Vikas Puri, New Delhi - 110 018
25. Shri N. K. Sharma Chief Engineer, National Highways, Rajasthan PWD, Jaipur - 302 006
26. Shri K. B. Lal Singhal E-in-C Haryana PWD (Retd.), House No. 684, Sector 16, Panchkula - 134 109 (Haryana)

27. Dr. M. G. Tamhankar Director - Grade Scientist (SERC-G) (Retd.) & Former Emeritus Scientist (CSIR), BH-1/44, Kendriya Vihar, Sector-11, Kharghar, Navi Mumbai - 410 210
28. Shri P. S. Tyagi Flat No. A-201, Vasundra Valley Apartment, GH-3, Sector VI, Vasundra, Distt. Ghaziabad-10
29. Maj. V. C. Verma Executive Director-Marketing, Oriental Structural Engrs. Pvt. Ltd., 21, Commercial Complex, Malcha Marg, Diplomatic Encl. New Delhi - 110 021
30. Shri Ghasi Ram Deputy Director General (D & S), HQ DGBR, Seema Sadak Bhavan, Ring Road, Naraina, Delhi Cant., New Delhi - 110 010
31. Col. O. P. Shrivastava Director (Design), E-in-C Branch, Kashmir House, P. O. AHQ, Rajaji Marg, New Delhi - 110 011
32. Shri Krishna Kumar Chief Engineer, UP PWD, 96, M. G. Marg, Lucknow - 226 001
33. Dr. B. C. Roy Executive Director, Consulting Engg. Services (I) Pvt. Ltd., 57, Nehru Place, 5th Floor, New Delhi - 110 019
34. Prof Mahesh Tandon Managing Director, Tandon Consultants (P) Ltd., 17, Link Road, Jangpura Extn., New Delhi - 110 014
35. Shri D. D. Sharma I-1603, Chittaranjan Park, New Delhi - 110 019
36. Shri Anil Banchor Head - Business Expansion, ACC Concrete Limited, Leela Business Park. 3rd Floor, Opp. Hotel Leela, Andheri Kurla Road, Andheri (East) Mumbai - 400 059
37. Col. A. K. Bhasin Senior Joint President, M/s Jaypee Ganga Infrastructure Corpn. Ltd., Sector-128, Noida-201 304
38. Shri Ashok Kumar Chief Engineer, Ministry of Shipping, Road Transport & Highways, Transport Bhawan, New Delhi - 110 001

**Ex-Officio Members**

1. Shri D. B. Deshpande (President, IRC) Secretary to the Govt. of Maharashtra, Sachivalaya, Mumbai
2. The Director General (Road Development) & Special Secretary to the Govt. of India Ministry of Shipping, Road Transport & Highways, Transport Bhawan, New Delhi - 110 001
3. Shri R. P. Indoria Secretary General, Indian Roads Congress, Kama Koti Marg, Sector-6, R. K. Puram, New Delhi - 110 022

**Corresponding Member**

1. Shri N. V. Merani Former Principal Secretary to Govt. of Maharashtra PWD, Flat No. 1344, Building A-47, Adarsh Nagar, Worli, Mumbai - 400 025

**INTRODUCTION**

The Manual of Specifications & Standards for Four laning of Highways through Public Private Partnership has been under the consideration of Project Preparation, Contract Management & Quality Assurance Committee (G-1) since January 2009. The draft was discussed by G-1 Committee in a number of meetings.

The Project Preparation, Contract Management & Quality Assurance Committee (personnel given below) in its meeting held on 25.05.2009 has finalised the Manual and recommended its submission to the General Specifications & Standards Committee (GSS) for their consideration.

Puri, SK	–	Convenor
Datta, P.K.	–	Co-Convenor
Ramana, K. Venkata	–	Member-Secretary

**Members**

Alam, Perwez	Kumar, Mahesh
Bahandur, A.P.	Mahalaha, R.S.
Basu, B.K.	Nirmal, S.K.
Bhasin, Col. A.K.	Panda, K.C.
Chakrapani, R.	Patwardhan, S.V.
Datta, Amitabha	Rao, P.R.
Dave, Kirti	Sarin, A.K.
Gajria, Maj Gen. K.T.	Sharma, M.P.
Ganesan, K.R.S.	Sharma, R.S.
Gupta, D.P.	Sinha, N.K.
Kandasamy, C.	Verma, Maj. V.C.
Kumar, Ashok	

**Ex-Officio Member**

President, IRC (D.B. Deshpande)	DG (RD), MoSRT&H
	Secretary General, IRC (R.P. Indoria)

The draft Manual was approved by the General Specifications and Standards Committee (GSS) in its meeting held on 10.06.2009 and the Executive Committee in its meeting held on 18.06.2009 and authorized the Secretary General, IRC to place the same before Council. The document was approved by the IRC Council in its 188th meeting held on 19.06.2009 and the Secretary General was authorized to incorporate the comments offered by the Council members and thereafter have it printed.

**SECTION - 1**

**GENERAL**

**SECTION - 1****GENERAL**

**1.1** This Manual is applicable for Four Laning of Highways through Public Private Partnership (PPP) mode. The scope of the work shall be as defined in the Concession Agreement. This Manual shall be read harmoniously with the intent of the Concession Agreement.

**1.2** The Project Highway and the project facilities shall conform to the requirements of design and specifications set out in this Manual, which are the minimum prescribed. The project report and other information provided by the Authority<sup>1</sup> shall be used by the Concessionaire only for its own reference and for carrying out further investigations. The Concessionaire shall be solely responsible for undertaking all the necessary surveys, investigations and detailed designs in accordance with good industry practice and due diligence, and shall have no claim against the Authority for any loss, damage, risk, costs, liabilities or obligations arising out of or in relation to the project report and other information provided by the Authority.

**1.3** At least 2 weeks prior to commencement of the work, the Concessionaire shall draw up a Quality Assurance Manual (QAM) covering the Quality System (QS), Quality Assurance Plan (QAP) and documentation for all aspects of the bridge and road works and send three copies each to the Independent Engineer (IE) for review. The class of quality assurance shall not be less than Q-3 (Refer IRC:SP:47 and IRC:SP:57).

**1.4** The Codes, Standards and Technical Specifications applicable for the design and construction of project components are:

- i) Indian Roads Congress (IRC) Codes and Standards; (Refer Appendix-2).
- ii) Specifications for Road and Bridge Works issued by the Ministry of Road Transport & Highways(MORTH) hereinafter referred to as MORTH or Ministry's Specifications.
- iii) Any other standards referred to in the Manual and any supplement issued with the bid document.

**1.5** Latest version of the Codes, Standards, Specifications, etc., notified/published at least 60 days before the last date of bid submission shall be considered applicable.

**1.6** The terms 'Ministry of Surface Transport', 'Ministry of Shipping, Road Transport & Highways' and 'Ministry of Road Transport and Highways' or any successor or substitute thereof shall be considered as synonymous.

---

<sup>1</sup> Authority / Government / Client

**1.7** The terms 'Inspector' and 'Engineer' used in MORTH Specifications shall be deemed to be substituted by the term "Independent Engineer", to the extent it is consistent with the provisions of the Concession Agreement and this Manual. The role of the Independent Engineer shall be as defined in the Concession Agreement.

**1.8** In case of any conflict or inconsistency in the provisions of the applicable IRC Codes, Standards or MORTH Specifications, the provisions contained in this Manual shall apply.

**1.9** In the absence of any specific provision on any particular issue in the aforesaid Codes or Specifications read in conjunction with the Specifications and Standards contained in this Manual, the following standards shall apply in order of priority.

- i) Bureau of Indian Standards (BIS)
- ii) American Association of State Highway and Transportation Officials (AASHTO) Standards or American Society for Testing and Materials (ASTM) Standards or Euro Codes or British Standards or Australian Standards
- iii) Any other specifications/standards proposed by the Concessionaire and reviewed by the IE.

**1.10** All items of building works shall conform to Central Public Works Department (CPWD) Specifications for Class 1 building works<sup>2</sup> and standards given in the National Building Code (NBC). For the Project Highway through the state entity, to the extent specific provisions for building works are made in IRC/MORTH Specifications, the same shall prevail over the CPWD/NBC provisions. For this purpose, building works shall be deemed to include toll plaza complex, road furniture, roadside facilities, landscape elements and/or any other works incidental to the building works.

#### **1.11 Guidelines for Preparing Schedules of the Concession Agreement**

Certain paras (full or part) in Sections 1 to 13 of this Manual refer to the Schedules of the Concession Agreement. While finalizing the feasibility/project report for the Project Highway, and the scope of the project, each of these Paras should be carefully examined and addressed by the Authority with a view to making appropriate provisions in the Schedules of the Concession Agreement. (A list of the Paras that refer to such Schedules has been provided at Appendix-1 for ready reference).

#### **1.12 Alternative Standards and Specifications**

The requirements stated in the Manual are the minimum. The Concessionaire will, however, be free to adopt international practices, alternative specifications, materials and standards to bring in innovation in the design and construction provided they are

<sup>2</sup> The State Government may prescribe concerned State PWD Specifications, if so desired.

better or comparable with the standards prescribed in the Manual. The specifications and techniques which are not included in the MORTH/IRC Specifications shall be supported with authentic standards and specifications mentioned in Para 1.9. Such a proposal shall be submitted by the Concessionaire to the Independent Engineer. In case, the Independent Engineer is of the opinion that the proposal submitted by the Concessionaire is not in conformity with any of the international standards or codes, then he will record his reasons and convey the same to the Concessionaire for compliance. A record shall be kept by the Independent Engineer, of the non-compliance by the Concessionaire of the minimum Specifications and Standards specified in the Manual. Adverse consequences, if any, arising from any such non-compliance, shall be treated as "Concessionaire Default" and shall be dealt in accordance with the provisions of the Concession Agreement.

#### **1.13 General considerations for Planning, Design and Construction**

The Project Highway shall be planned as a "partially access controlled highway" where access to the highway shall be provided only at pre-determined locations. In doing so, the Concessionaire shall take measures to overcome the physical and operational constraints and plan, design and construct the Project Highway using appropriate methods, management techniques and technologies. General considerations shall, without being limited to, be as follows:-

##### a) The constraints

The physical constraints in the existing highway are in the form of limitation of right of way, un-regulated access, inadequate service roads and underpasses, numerous at-grade junctions, lack of physical separation between local and through traffic etc. The operation constraints arise out of the necessity or possibility of closing a portion of the road for construction and/or diverting the traffic to temporary diversions, thereby reducing the capacity and safety of the existing highway. The solutions evolved by the Concessionaire shall be such that these operational constraints are overcome through appropriate planning, design and construction method, techniques and technologies and by adopting suitable traffic management measures.

##### b) Safety of design

All designs shall be safe to ensure that the Project Highway or any part thereof (for example embankment, pavement, retaining structures, bridges, culverts, etc) does not collapse (global stability) nor its serviceability/performance (for example settlement, roughness, undulations, deflections, etc) deteriorates below acceptable level as prescribed in Schedule K of the Concession Agreement.

##### c) Durability

The Project Highway shall not only be safe but also durable. This would mean that the deteriorating effects of climate and environment (for example

wetting and drying, freezing and thawing, if applicable, temperature differences, aggressive environment leading to corrosion, etc) in addition to the traffic shall be duly considered in design and construction to make the Project Highway durable.

d) Mitigating disruptive effects of construction

The planning, design and construction of the highway shall be such that the construction of Project Highway does not have adverse impact on the environment and does not disrupt the lives and business activities of the people living close to the Project Highway.

### 1.14 Safety during Construction and Operation & Maintenance

**1.14.1** The Concessionaire shall develop, implement and administer a surveillance and safety programme for providing a safe environment on or about the Project Highway, and shall comply with the safety requirements set forth in the Concession Agreement.

**1.14.2** Before taking up any construction or maintenance operation/work, the Concessionaire shall prepare a Traffic Management Plan for each work zone and furnish it to the Independent Engineer for comments duly incorporating the following:

- i) Designate a Site Safety Team headed by a qualified Safety Officer.
- ii) Traffic safety devices as per IRC:SP:55 with the following specifications:
  - a) Signages of retro-reflective sheet of high intensity grade.
  - b) Delineators in the form of cones/drums (300 to 500 mm dia and 1000 mm high) made of plastic/rubber having retro reflective red and white band, at a spacing of maximum 5 m along with a reflective tape (red and white band) to be tied in between the gaps of cones/drums. A bulb/flasher using solar energy is to be placed on the top of the cone/drum for night delineation.
  - c) Barricades using iron sheet (plain) with adequate iron railing/frame painted with retro-reflective paint in alternate black and white (or yellow and black) stripes. Warning lights at 5.0 m spacing shall be mounted on the barricades and kept lit in the dark hours and night.
- iii) The arrangement of traffic during construction and maintenance shall conform to the requirements of Clause 112 of MORTH Specifications. Ensure availability of 7 m paved carriageway for traffic without potholes or other defects. At locations where available carriageway is less than 7 m, provide round the clock traffic signals with marshals carrying mobile/walky-talky at both ends to control both directions of traffic.

- iv) Sprinkling of water for dust control at work zones, haul roads and plant/camp sites.
- v) Noise/Pollution suppression measures at work zones, haul roads and plant/camp sites.
- vi) Mechanical, electrical and fire safety practices.
- vii) Safety measures like PPE (Personal Protection Equipment) for workers engaged.
- viii) First Aid and Emergency Response Arrangements i.e. First Aid Box, Ambulance, paramedical staff, alarms, etc.
- ix) Safety training/awareness programmes.
- x) Formats to maintain the accident records/emergency response provided during accidents.
- xi) A penalty scheme for violations in provision of adequate traffic control devices and proper traffic management should be proposed by the Concessionaire. In case of default, the amount of penalty shall be paid by the Concessionaire to the Authority.
- xii) A compensation scheme including insurance cover for third party for workers, road users and road side residents in case of death/injury/damage to the vehicle/property resulting from accidents on the Project Highway, irrespective of the person at fault should be proposed by the Concessionaire.

**1.14.3** The Concessionaire shall also be responsible for ensuring compliance of all labour laws and regulations including those relating to the welfare of workers engaged both directly and indirectly on the Project Highway, besides their occupational safety and health.

**1.15** The Concessionaire shall set up field laboratory for testing of materials and finished products as stipulated in Clause 121 of MORTH Specifications. It shall make necessary arrangements for additional/confirmatory testing of any materials/products at the government accredited laboratory, for which facilities at site laboratory are not available.

### 1.16 Environment Mitigation Measures

The Concessionaire shall carry out tests/monitor various parameters impacting the environment of the Project Highway keeping in view the guidelines of the Ministry of Environment and Forests and submit proposals for mitigation of adverse environment impact including provision of noise barriers, etc. for review and comments of the IE, if any and undertake implementation of the proposals in consultation with the IE.

**1.17 Utilities**

The details of the new utilities which are to be constructed or provided for along or across the Project Highway shall be as specified in Schedule 'B' of the Concession Agreement.

**1.18 Review and comments by the Independent Engineer**

In cases where the Concessionaire is required to send any drawings or documents to the Independent Engineer for review and comments, and in the event such comments are received by the Concessionaire, it shall duly consider such comments in accordance with the Concession Agreement and Good Industry Practice for taking appropriate action thereon. The correspondence between the Concessionaire and the Independent Engineer shall be deemed valid only if a copy thereof is endorsed to and received by the Authority.

**1.19 Definitions and Interpretation**

**1.19.1** Unless specified otherwise in this Manual, the definitions contained in the Model Concession Agreement (MCA) for Public Private Partnership (PPP) in Highways as published by the Planning Commission, Government of India, shall apply.

**1.19.2** Built-up area shall mean sections of the Project Highway that are situated within the limits of a municipal town and shall include sections of 200 m or more in non-municipal areas where dwellings/shops have been built on one or both sides of the Project Highway on at least 50 per cent of the total length comprising such section. The Built up areas shall be as specified in Schedule 'B' of the Concession Agreement.

**1.19.3** The definition of PCU used in this Manual shall be as per IRC Codes and Guidelines.

**1.20** This Manual is for 4-laning of the Project Highway. However, in some stretches, as indicated in Schedule 'B' of the Concession Agreement, 6-lane divided carriageway shall be provided as part of 4-laning of the Project Highway (Refer para 2.18). This shall not be construed as 6-laning of the Project Highway.

**SECTION - 2**  
**GEOMETRIC DESIGN AND**  
**GENERAL FEATURES**

**SECTION - 2****GEOMETRIC DESIGN AND GENERAL FEATURES****2.1 General**

- i) This section lays down the standards for geometric design and general features for four-lane divided carriageway.
- ii)
  - a) In built-up areas, 6-lane divided carriageway along with service roads shall be provided as part of 4-laning of the Project Highway. Such stretches where the requirement of 6-laning is dispensed with and only 4-laning with or without service road and footpath is to be provided will be as indicated in Schedule 'B' of the Concession Agreement.
  - b) Where there is constraint of ROW width, the Authority may specify construction of a bypass. The alignment of the bypasses shall be as specified in Schedule 'B' and in conformity with the site earmarked in Schedule 'A' of the Concession Agreement.
- iii) The geometric design of the Project Highway shall conform to the standards set out in this section as a minimum.
- iv) As far as possible, uniformity of design standards shall be maintained throughout the length of the Project Highway. In case of any change, it shall be effected in a gradual manner.
- v) Where the existing road geometrics are deficient with respect to minimum requirements and its improvements to the prescribed standards is not feasible due to any constraint in acquisition of additional land, such stretches shall be as specified in Schedule 'B' of the Concession Agreement.
- vi) Existing horizontal curves, which are found deficient in radius, layout, transition lengths or super-elevation shall be corrected to the standards specified in this section.
- vii) Any deficiencies in the vertical profile in respect of grades, layout of vertical curves and sight distance shall be corrected to meet the minimum requirements specified in this section.

**2.2 Design Speed**

**2.2.1** The design speeds given in Table 2.1 shall be adopted for various terrain classification (Terrain is classified by the general slope of the ground across the highway alignment).

**Table 2.1 Design Speed**

Nature of Terrain	Cross slope of the ground	Design speed (km/hr)	
		Ruling	Minimum
Plain and Rolling	Up to 25 percent	100	80
Mountainous and Steep	More than 25 percent	60	40

Short stretches (say less than 1 km) of varying terrain met with on the road stretch shall not be taken into consideration while deciding the terrain classification for a given section of Project Highway.

**2.2.2** In general, the ruling design speed shall be adopted for the various geometric design features of the road. Minimum design speed shall be adopted only where site conditions are restrictive and adequate land width is not available. Such stretches shall be as indicated in Schedule 'B' of the Concession Agreement.

**2.3 Right-of-Way**

The ROW available for the Project Highway shall be as given in Schedule 'A' of the Concession Agreement. The Authority would acquire the additional land required, if any. The land to be acquired shall be indicated in Schedule 'B' of the Concession Agreement. The minimum Right of Way for non-urban and urban areas should be as prescribed in IRC:73 and IRC:86 respectively.

**2.4 Lane Width of Carriageway**

The standard lane width of the Project Highway shall be 3.5 m.

**2.5 Median**

**2.5.1** The median shall be either raised or depressed. The width of median is the distance between inside edges of carriageway. The type of median shall depend upon the availability of Right of Way. The minimum width of median, subject to availability of Right of Way, for various locations shall be as in Table 2.2.

**Table 2.2 Width of Median**

Type of Section	Minimum Width of Median (m)		
	Plain and Rolling terrain		Mountainous and Steep terrain
	Raised	Depressed median	Raised
Open country with isolated built up area	4.5	7.0	2.0
Built up area	2.0	Not Applicable	2.0
Approach to grade separated structures	4.5	Not Applicable	2.0

The type and widths of median in various stretches of Project Highway shall be as indicated in Schedule 'B'.

**2.5.2** The median shall have suitably designed drainage system so that water does not stagnate in the median.

**2.5.3** In case of depressed median, a minimum 0.6 m width adjacent to carriageway in either direction shall be paved.

**2.5.4** As far as possible, the median shall be of uniform width in a particular section of the highway. However, where changes are unavoidable, a transition of 1 in 20 shall be provided.

**2.5.5** In the case of depressed median, metal beam type (double beam) crash barriers shall be provided at either side of the median. Suitable shrubs as per Section 11 of this Manual shall be provided.

**2.5.6** Suitable antiglare measures such as metal/plastic screens shall be provided in flat stretches or on horizontal curves to reduce headlight glare from opposite traffic. The total height of screen including the height of the barrier shall be 1.5 m.

**2.6 Shoulders**

**2.6.1 Width of shoulders**

The shoulder width on the outer side (left side of carriageway) shall be as given in Tables 2.3. and 2.4.

**Table 2.3 Width of Shoulders in Plain and Rolling Terrain**

Type of Section	Width of Shoulder (m)		
	Paved	Earthen	Total
Open country with isolated built up area	1.5	2.0	3.5
Built up area	2.0	-	2.0
Approaches to grade separated structures	2.0	-	2.0
Approaches to bridges	1.5	2.0	3.5

**Table 2.4 Width of Shoulders in Mountainous and Steep Terrain (Hilly Area)**

Type of Section	Width of Shoulder, including drain and crash barrier as applicable (m)	
Open country with isolated built up area	1.5 (on hill side) 2.0 (on valley side)	Earthen Shoulder
Built up area and approaches to grade separated structures/bridges	1.5 (on hill side) 2.0 (on valley side)	Raised Footpath along with provision of adequate drainage along and across the footpath

Note :In mountainous and steep terrain, the scope of work defined by the Authority may be two-lane carriageways on different alignments (contours). In that case, IRC:SP:73-2007 Manual of Specifications and Standards for Two-Laning of Highways shall apply to the two-lane carriageways on different alignments (contours).

### 2.6.2 Type of shoulder

The type of shoulder shall be as below:

- i) In the built-up section and approaches to the grade separated structures, the shoulder shall be paved in full width.
- ii) Earthen shoulders shall be covered with 150 mm thick layer of granular material conforming to the requirements given in Clause 401 of MORTH Specifications.
- iii) In embankments with height more than 6.0 m, the granular shoulder may be raised with provision of kerb channel to channelize the drainage as an erosion control device in accordance with Section 6.
- iv) The composition and specification of the paved shoulder shall be same as of the main carriageway.

### 2.7 Roadway Width

**2.7.1** The width of roadway shall depend upon the width of carriageway, shoulders and the median.

**2.7.2** On horizontal curves with radius up to 300 m, width of pavement and roadway in each carriageway shall be increased as per Table 2.5.

**Table 2.5 Extra Width of Pavement and Roadway In Each Carriageway**

Radius of Curve	Extra Width
75-100 m	0.9 m
101-300 m	0.6 m

### 2.8 Crossfall

**2.8.1** The crossfall on straight sections of road carriageway, paved shoulders and paved portion of median shall be 2.5 percent for bituminous surface and 2.0 percent for cement concrete surface.

**2.8.2** The crossfall shall be unidirectional for either side carriageway sloping towards the shoulder in straight reaches and towards the lower edge on horizontal curves. The camber on the existing road shall be modified to unidirectional crossfall.

**2.8.3** The crossfall for granular shoulders on straight portions shall be at least 0.5 percent steeper than the slope of the pavement and paved shoulder subject to a minimum of 3.0 percent. On super elevated sections, the earthen portion of the shoulder on the outer side of the curve would be provided with reverse crossfall of 0.5 percent so that the earth does not drain on the carriageway and the storm water drains out with minimum travel path.

### 2.9 Geometric Design

**2.9.1** Geometric design shall conform to IRC:73, except as otherwise indicated in this Manual.

**2.9.2** All horizontal curves shall consist of circular portion flanked by spiral transitions at both ends.

### 2.9.3 Superelevation

Superelevation shall be limited to 7 percent, if radius of curve is less than desirable minimum radius. It shall be limited to 5 percent, if radius is more than desirable minimum.

### 2.9.4 Radii of horizontal curves

The minimum and absolute minimum radii of horizontal curves for various classes of terrain are given in Table 2.6

**Table 2.6 Minimum Radii of Horizontal Curves**

Nature of terrain	Desirable Minimum	Absolute minimum
Plain and Rolling	400 m	250 m
Mountainous and Steep	150 m	75 m

The radius of horizontal curves for various terrain conditions shall not be less than the desirable minimum values given in Table 2.6 except for Sections as indicated in Schedule 'B'. For such Sections, the radius shall not be less than absolute minimum.

### 2.9.5 Sight distance

The safe stopping sight distance and desirable minimum sight distance for divided carriageway for various design speeds are given in Table 2.7. The desirable values of sight distance shall be adopted unless there are site constraints. A minimum of safe stopping sight distance shall be available throughout.

**Table 2.7 Safe Sight Distance**

Design Speed (km/hr)	Safe Stopping sight distance (m)	Desirable minimum sight distance (m)
100	180	360
80	130	260
60	90	180
40	45	90

### 2.9.6 Vertical alignment

**2.9.6.1** The vertical alignment should provide for a smooth longitudinal profile. Grade changes shall not be too frequent as to cause kinks and visual discontinuities in the profile. In this regard, directions given in IRC : 73 should be kept in view.

#### 2.9.6.2 Gradients

The ruling and limiting gradients are given in Table 2.8.

**Table 2.8 Gradients**

Nature of terrain	Ruling gradient	Limiting gradient
Plain and Rolling	3.3%	5.0%
Mountainous	5.0%	6.0%
Steep	6.0%	7.0%

**2.9.6.3** Long sweeping vertical curves shall be provided at all grade changes. These shall be designed as square parabolas.

**2.9.6.4** Design of vertical curves and its coordination with horizontal curves, shall be in accordance with IRC:SP:23.

### 2.10 Lateral and Vertical Clearance at Underpasses

Wherever a cross road is proposed to be taken below the Project Highway, minimum clearances at underpasses shall be as follows:

#### 2.10.1 Lateral clearance

- i) Full roadway width at the approaches shall be carried through the underpass. This width shall not be less than 12 m (7 m carriageway + 2 x 2.5 m shoulder width on either side) or as indicated in Schedule 'B'.
- ii) Guardrails/crash barriers shall be provided for protection of vehicles from colliding with the abutments and piers and the deck of the structures.
- iii) The width of cattle and/or pedestrian underpass shall not be less than 5 m.

#### 2.10.2 Vertical clearance

Vertical clearance at underpasses shall not be less than the values given below:

i) Vehicular underpass	5.5 m
ii) Pedestrian and Cattle underpass	3.0 m (to be increased to 4.5 m, in case certain categories of animals such as elephant/camel are expected to cross the Project Highway frequently. This will be as specified in Schedule 'B')

Wherever existing slab culverts and minor bridges allow a vertical clearance of more than 2 m, these can be used in dry season for pedestrian and cattle crossing by providing necessary flooring. This will not be a substitute for normal requirements of pedestrian and cattle crossings as per Para 2.13.3.

### 2.11 Lateral and Vertical Clearance at Overpasses

Wherever any structure is provided over the Project Highway; the minimum clearances at overpasses shall be as follows:

#### 2.11.1 Lateral clearance

Full roadway width shall be carried through the overpass structure unless otherwise specified in Schedule 'B'. Provision shall also be made for future widening of the Project Highway to 6-lane with service roads. The abutments and piers shall be provided with suitable protection against collision of vehicles. Crash barriers shall be provided on abutment side and on sides of piers for this purpose. The ends of crash barriers shall be turned away from the line of approaching traffic.

#### 2.11.2 Vertical clearance

A minimum 5.5 m vertical clearance shall be provided at all points of the carriageway of the Project Highway.

**2.12 Access Control**

**2.12.1 Access**

Access to the Project Highway shall be partially controlled. In general, access to the Project Highway shall be provided at the following locations:

- i) Intersection with National Highways
- ii) Intersection with State Highways
- iii) Intersection with Major District Roads
- iv) Intersection with Village Roads/Other District Roads, subject to a minimum distance of 3 km from the nearest intersection.

The locations of intersections shall be specified in Schedule 'B'.

**2.12.2 Service roads**

**2.12.2.1** The location and length of service roads, to be constructed by the Concessionaire shall be specified in Schedule 'B' of the Concession Agreement. The width of the service road shall be 7.0 m.

**2.12.2.2** For the stretches where total length of a bridge is less than 60 m and the service road is required to be provided on both sides of the stream, then the service road, shall continue across the stream and suitably designed 2-lane bridge structure shall be provided. In cases involving bridges of 60 m length or more, separate bridge structures may not be provided and service road shall be merged with the Project Highway at 50 m distance before the bridge structure, unless otherwise specified in Schedule 'B' of the Concession Agreement.

**2.12.2.3** Wherever service roads are provided, provision shall be made for proper entry and exit ramps between the main highway and the service roads, duly keeping in view future widening of main highway to six-lanes. The layout shall be as per Fig. 2.1A to 2.1H.

**2.13 Grade Separated Structures**

**2.13.1** The type, location, length, number and the openings required and approach gradients for various grade separated structures shall be as specified in Schedule 'B' of the Concession Agreement. The approach gradient to the grade separated structure shall not be steeper than 2.5 percent (1 in 40).

**2.13.2 Vehicular underpass/overpass**

The vehicular under/overpass structures shall be provided at the intersection of the Project Highway with all the National Highways and State Highways. Such under/over passes

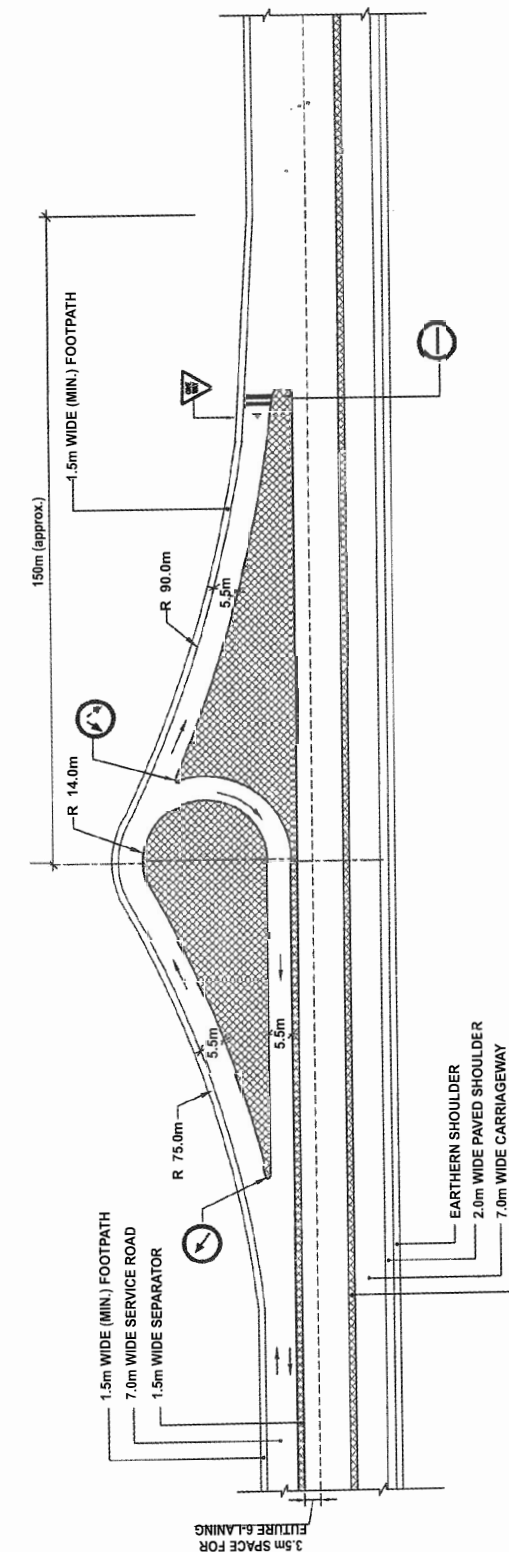

FIG. 2.1A Suggestive Layout for Entry Ramp to Highway (AT THE END OF SERVICE ROAD)

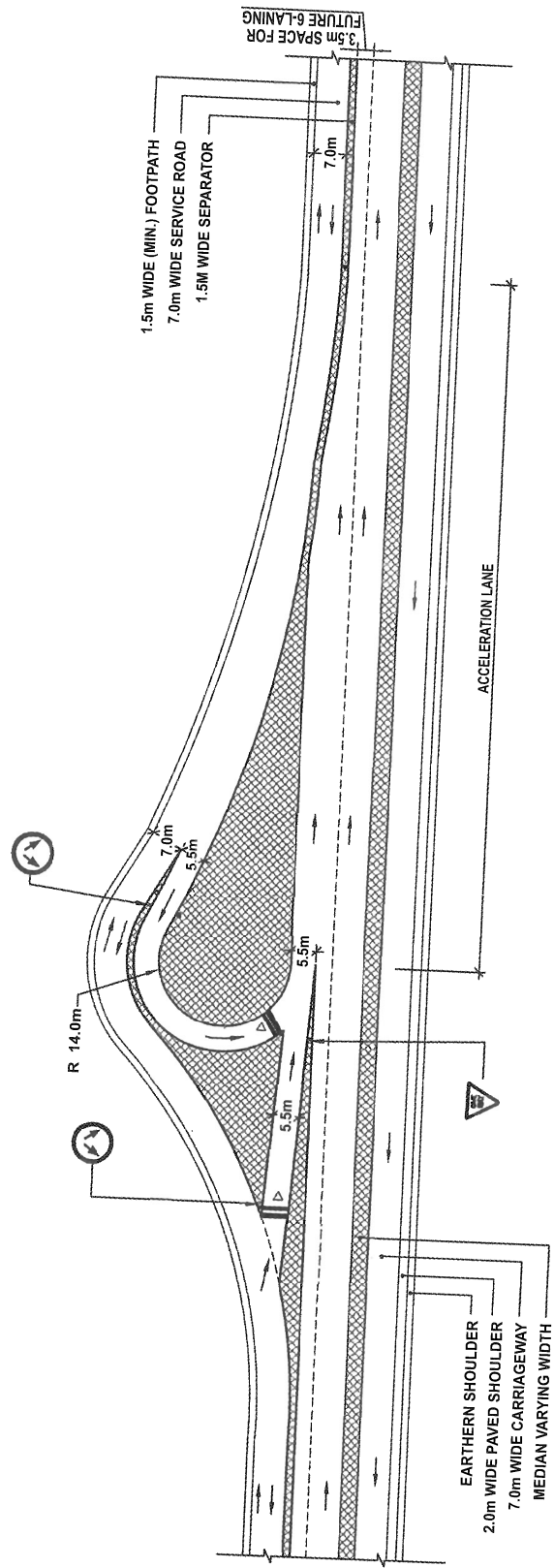

FIG. 2.1B Suggestive Layout for Entry Ramp to Highway  
(SERVICE ROAD ON BOTH SIDES OF  
ENTRY RAMP)

**NOTE:-**

1. DETAILED SYSTEM OF ROAD MARKING AS PER IRC:35
2. DETAILED SYSTEM OF ROAD SIGNS AS PER IRC:67

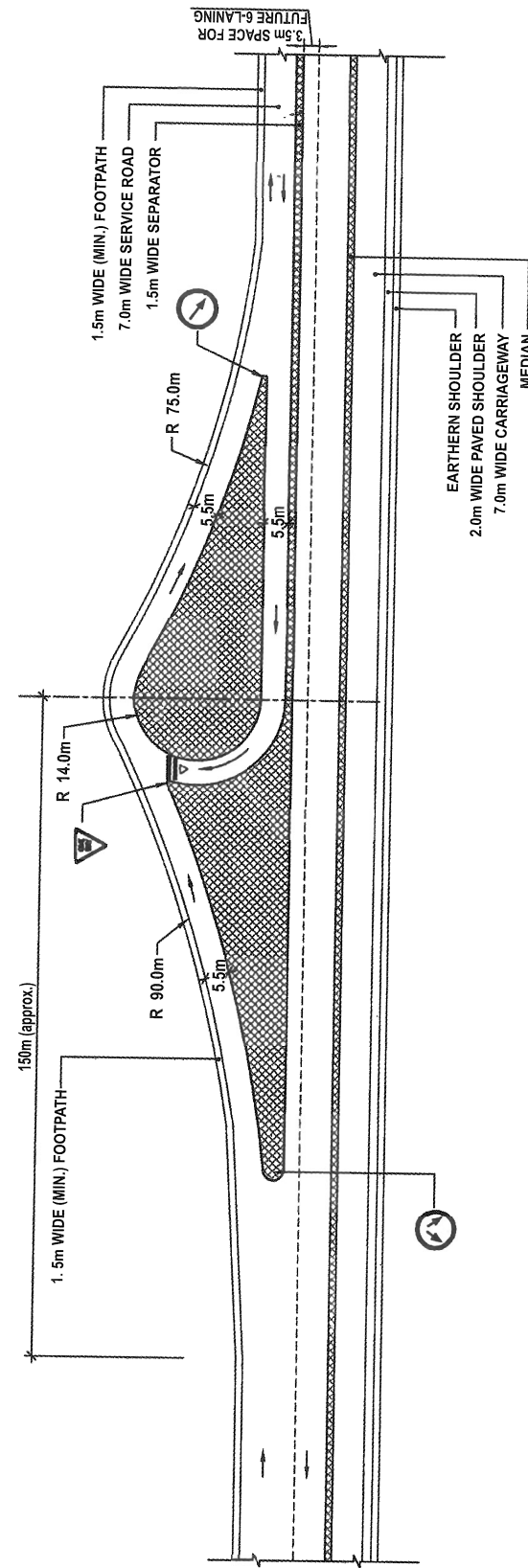

FIG. 2.1C Suggestive Layout for Exit Ramp from Highway  
(AT THE END OF SERVICE ROAD)

**NOTE:-**

1. DETAILED SYSTEM OF ROAD MARKING AS PER IRC:35
2. DETAILED SYSTEM OF ROAD SIGNS AS PER IRC:67

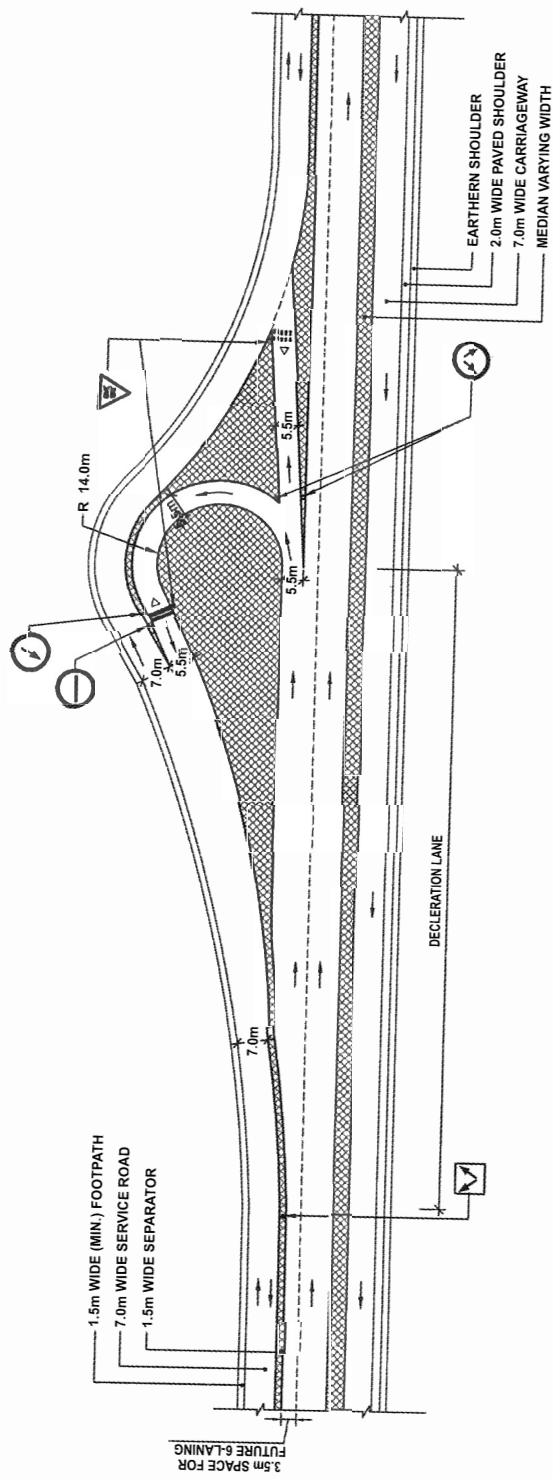

FIG. 2.1D Suggestive Layout for Exit Ramp from Highway  
(SERVICE ROAD ON BOTH SIDES OF  
EXIT RAMP)

**NOTE:-**

1. DETAILED SYSTEM OF ROAD MARKING AS PER IRC:35
2. DETAILED SYSTEM OF ROAD SIGNS AS PER IRC:67

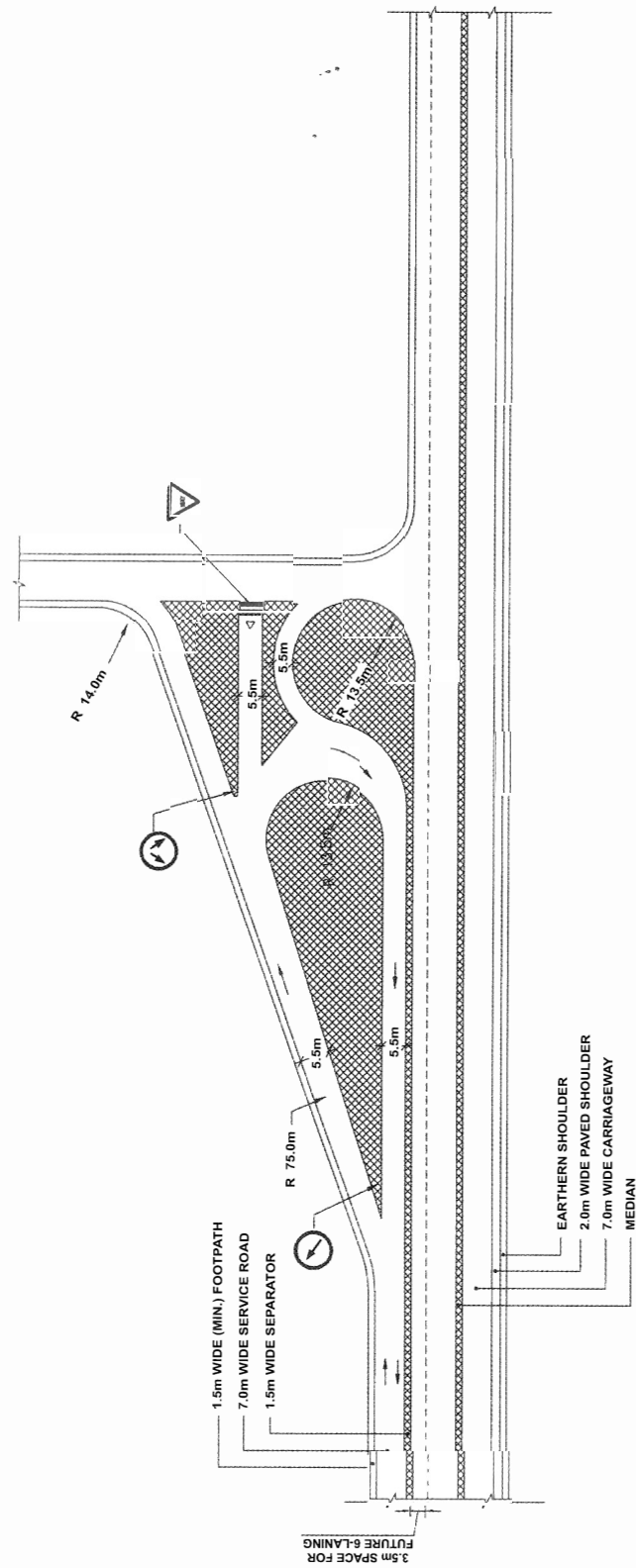
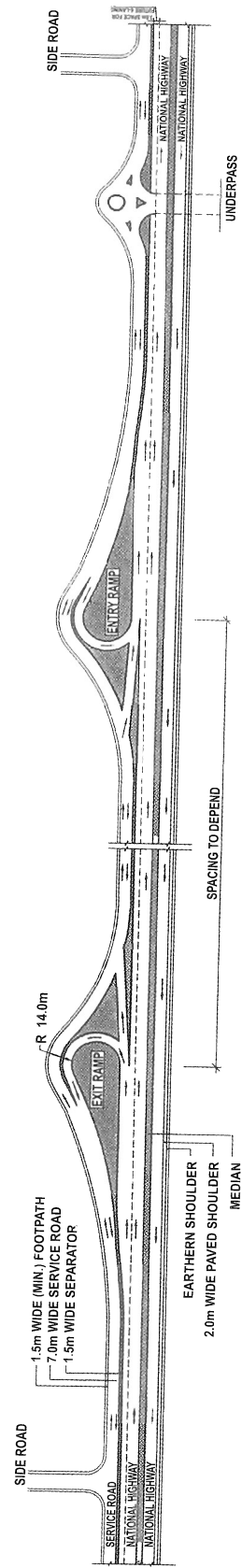

FIG. 2.1E Suggestive Layout of Service Road Ending  
at a Junction with Cross-Road

**NOTE:-**

1. THE SUGGESTIVE LAYOUT SHOWS MEETING OF SERVICE ROAD WITH A CROSS ROAD. THE MOVEMENTS FROM CROSS ROAD ON TO THE MAIN HIGHWAY SHALL BE DEALT IN ACCORDANCE WITH SECTION 2.2.1 (3).
2. THE OTHER END OF SERVICE ROAD SHALL BE PROVIDED WITH END TREATMENT AS PER FIGURE 2.1.B.
3. DETAILED SYSTEM OF ROAD MARKING AS PER IRC:35
4. DETAILED SYSTEM OF ROAD SIGNS AS PER IRC:67



**NOTE:-**  
 1. DETAILED SYSTEM OF ROAD MARKING AS PER IRC.35  
 2. DETAILED SYSTEM OF ROAD SIGNS AS PER IRC.67

Fig. 2.1F Suggestive Layout showing Configuration of Service Road, Entry/Exit Ramps, Side Road and Underpass

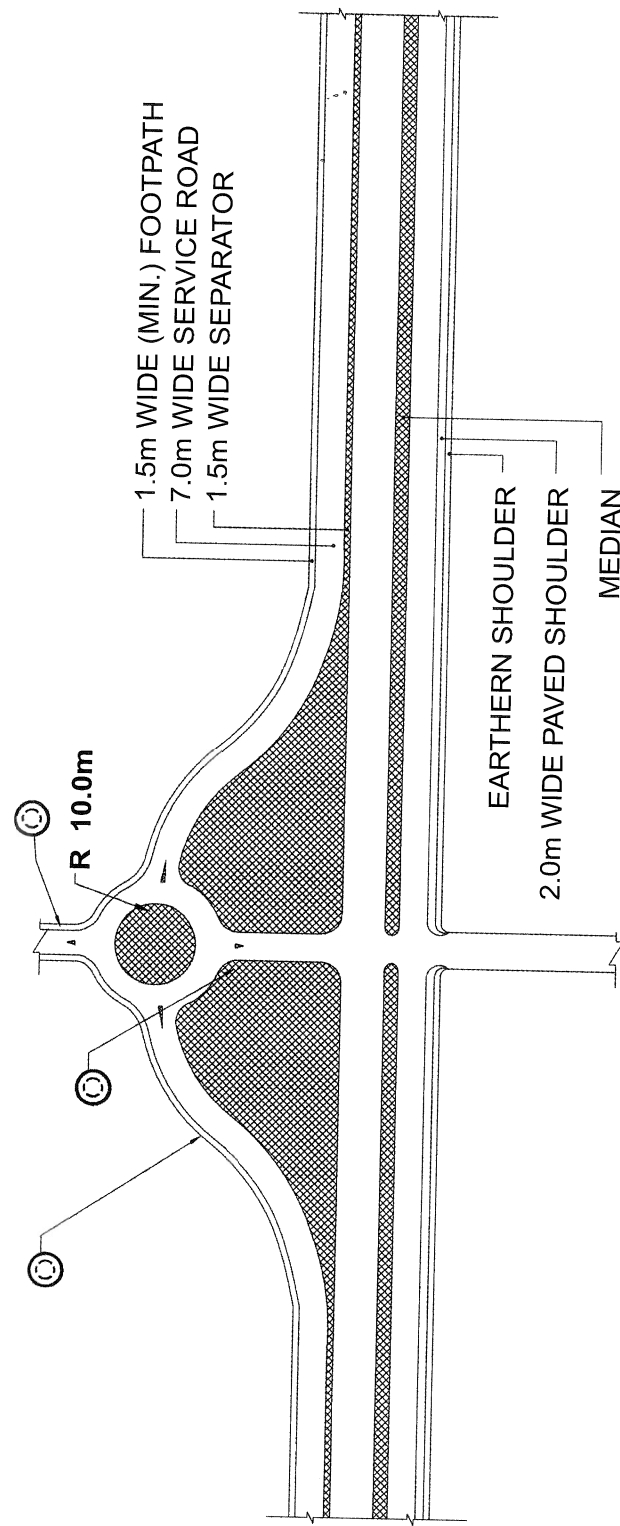

FIG. 2.1G Suggestive Layout of Service Road Continuing at Intersection

**NOTE:-**  
 1. DETAILED SYSTEM OF ROAD MARKINGS AS PER IRC.35

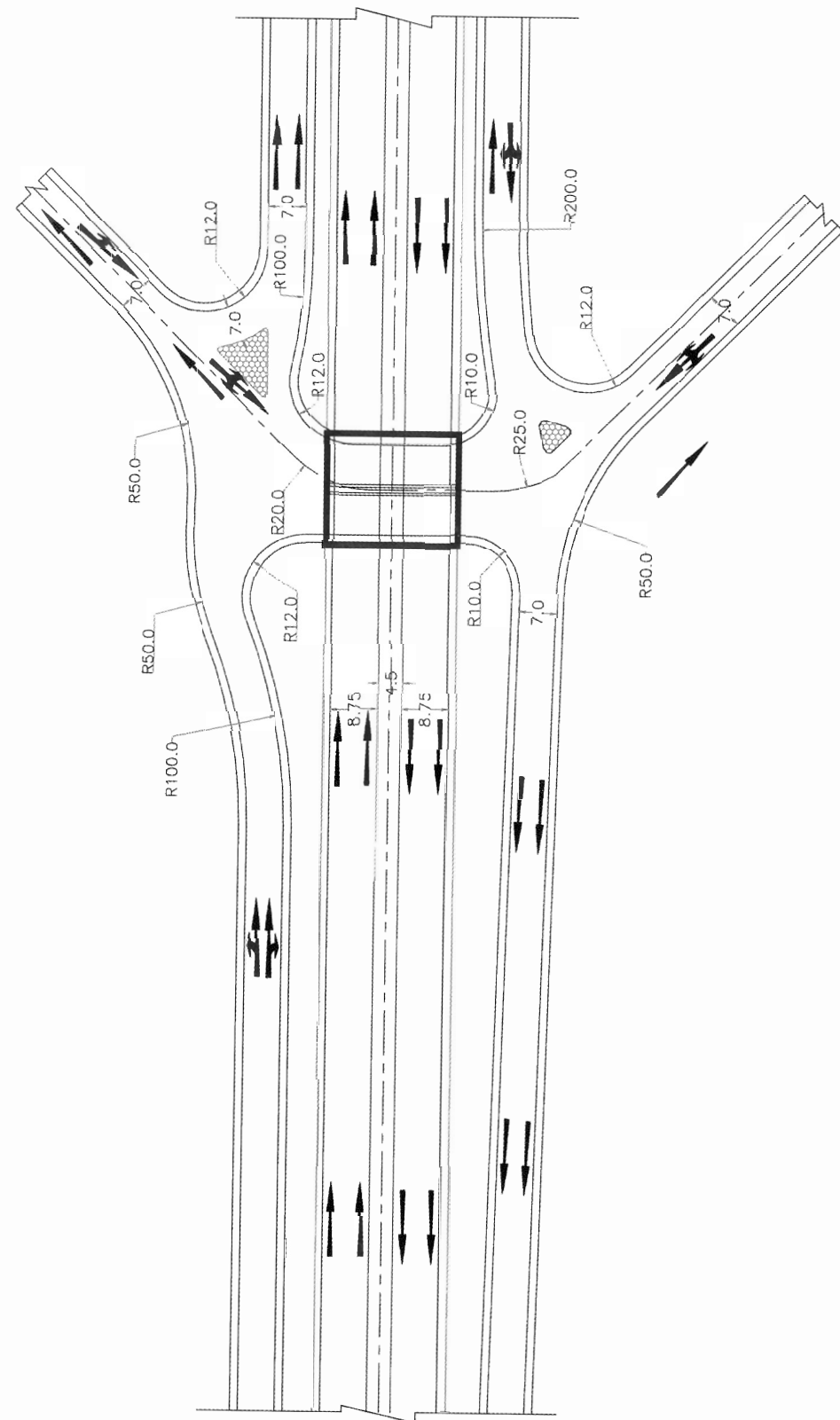

FIG. 2.1H Suggestive Layout for Connecting Service Road to Underpass on Cross Road

shall also be provided across other categories of roads carrying an average daily traffic of more than 5000 Passenger Car Units (PCUs) on the date of inviting bids. The structure may be either an underpass or an overpass depending upon the nature of terrain, vertical profile of road, availability of adequate right of way, etc. Unless otherwise specified in Schedule 'B' of the Concession Agreement, the Project Highway shall be carried at the existing level in rural areas and the cross road would be either an underpass or overpass and the entire cost involved in lowering or raising the existing cross road would be included as part of the cost of the Project Highway. However, in urban areas, the cross road shall be carried at the existing level, unless otherwise specified in Schedule 'B' of the Concession Agreement. Decision whether the cross road or the Project Highway will be carried at the existing level will be taken at the time of preparing the feasibility report and would be based on considerations of drainage, land acquisition, provision of ramps for the grade separated facility, height of embankment and project economy etc.

**2 13.3 Cattle and pedestrian underpass/overpass**

These shall be provided as specified in Schedule 'B' of the Concession Agreement.

- i) An underpass/overpass for crossing of cattle and pedestrians may not be necessary within a distance of 2 km from Vehicular underpasses.
- ii) The width of Pedestrian or Cattle crossing shall not be less than 5 m.
- iii) The pedestrian crossings shall have provision for movement of physically challenged persons.
- iv) Underpasses shall be preferred to overpasses.
- v) Pedestrian underpass/overpass shall also be provided within a distance of 200 m from a school or hospital or factory/industrial area.

**2 13.4** Road Over Bridges (ROBs)/Road Under Bridges (RUBs) shall be provided as per Section-7 of this Manual.

**2 14 Median Openings**

**2 14.1** Median openings shall not be spaced closer than 2 km. Additional controlled openings shall also be provided for inspection, and diversion of traffic during repair and rehabilitation.

**2 14.2** Median opening shall not be provided in front of the service road entry. The distance between the service road entry and the median opening shall be at least equal to the sum of length of acceleration lane, weaving length, and deceleration length. Location of opening shall be so decided as to minimize intraflow. This distance shall however be not less than 150 m.

IRC:SP:84-2009

**2.14.3** All median openings shall be provided with additional 3.5 m wide shelter lane by the side of median in both directions for waiting of vehicles to take U turn. Wherever required, horizontal geometrics of the road shall be suitably adjusted.

**2.14.4** Length of median opening shall not be less than 20 m.

**2.15 Fencing**

Fencing shall be provided between the service road and the Project Highway to prevent the pedestrians, local vehicles and animals entering the highway. The fencing shall be either of metal double beam crash barrier or pedestrian guardrail given in Para 9.10 of this Manual.

**2.16 Typical Cross-sections**

Typical cross-sections of Project Highway are given in Fig. 2.2 to 2.10 for various locations as below:

**Fig. 2.2** shows typical cross section Type-A1 for 4-lane divided highway in open country with isolated built-up area in plain/rolling terrain, without service roads and with depressed median

**Fig. 2.3** gives typical cross section Type-A2 for 4-lane divided highway in open country in plain/rolling terrain with service roads on both sides and with depressed median

**Fig. 2.4** shows typical cross section Type-A3 for 4-lane divided highway in open country with isolated built-up area in plain/rolling terrain, without service roads and with raised median

**Fig. 2.5** gives typical cross section Type-A4 for 4-lane divided highway in open country in plain/rolling terrain with service roads on both sides and with raised median

**Fig. 2.6** shows typical cross section Type-B for 4-lane divided highway in built-up section in plain and rolling terrain with service roads on both sides and with raised median

**Fig. 2.7** shows typical cross section Type-C1 for 4-lane divided highway on different contours in open country with isolated built-up area in mountainous terrain.

**Fig. 2.8** shows typical cross section Type-C2 for 4-lane divided highway on different contours in built up section in mountainous terrain.

**Fig. 2.9** shows typical cross section Type-C3 for 4-lane divided highway at same level in open country with isolated built-up area in mountainous terrain.

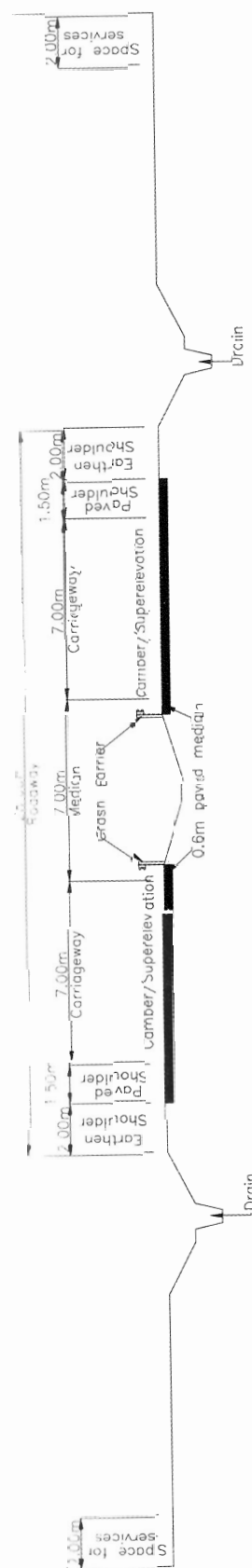

**TYPICAL CROSS SECTION TYPE-A1**  
(Open country—Plain / Rolling terrain)  
Fig : 2.2 4-Lane Divided Highway without Service Roads and with Depressed Median

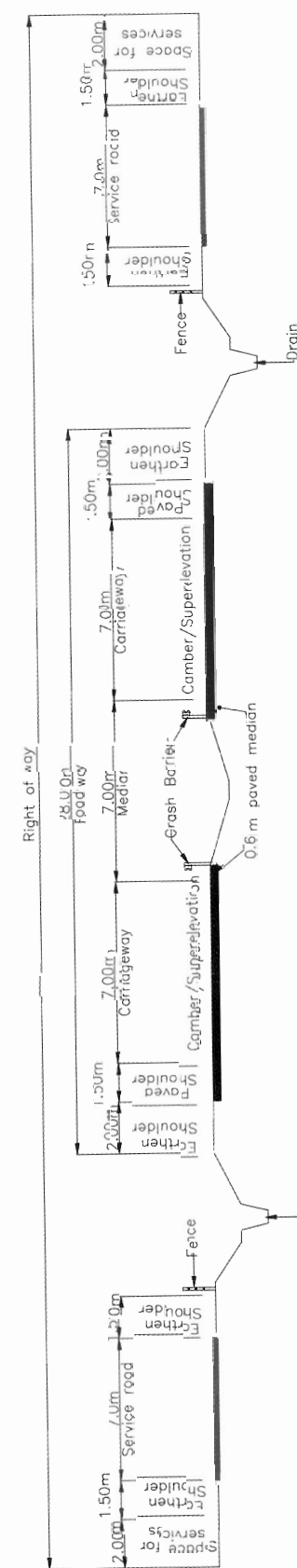

**TYPICAL CROSS SECTION TYPE-A2**  
(Open country—Plain / Rolling terrain)  
Fig : 2.3 4-Lane Divided Highway with Service Roads and with Depressed Median

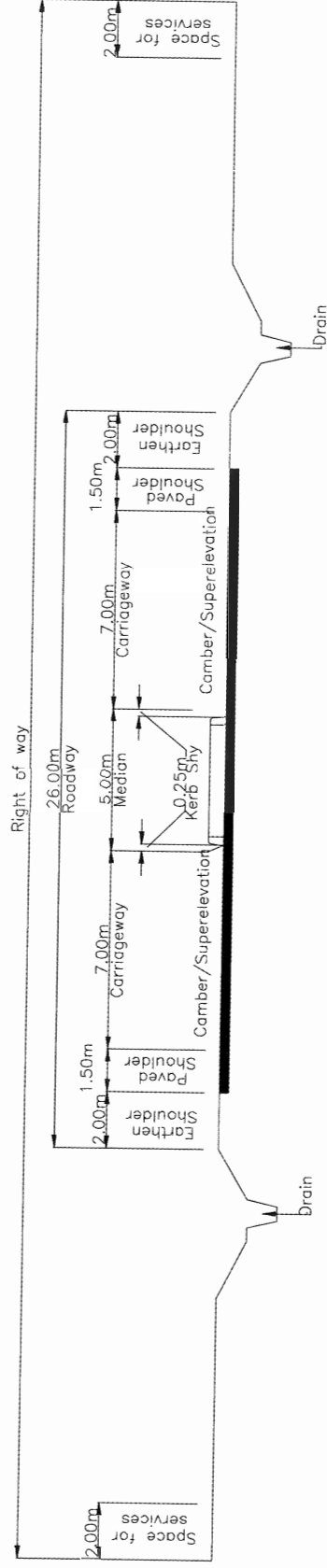

**TYPICAL CROSS SECTION TYPE-A3**  
(Open country-Plain / Rolling terrain)  
Fig : 2.4 4-Lane Divided Highway without Service Roads and with Raised Median

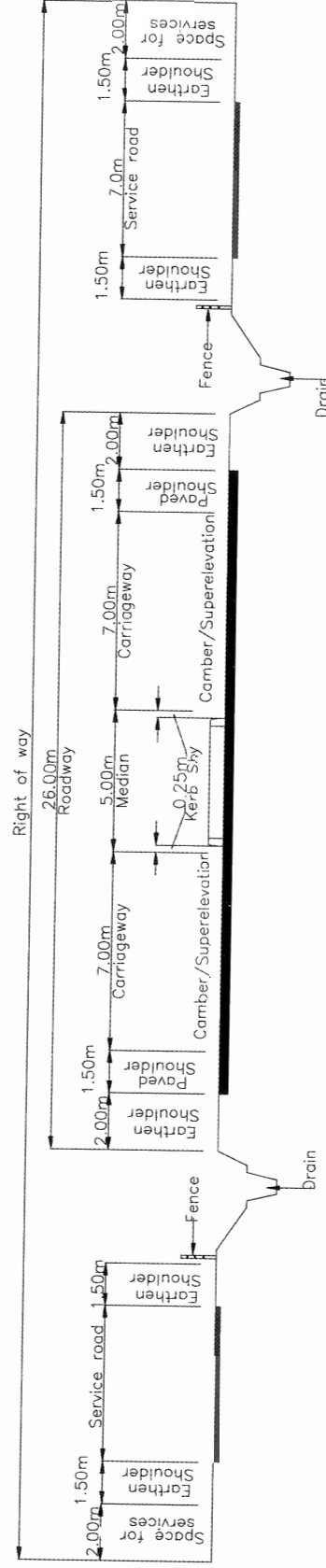

**TYPICAL CROSS SECTION TYPE-A4**  
(Open country-Plain / Rolling terrain)  
Fig : 2.5 4-Lane Divided Highway with Service Roads and with Raised Median

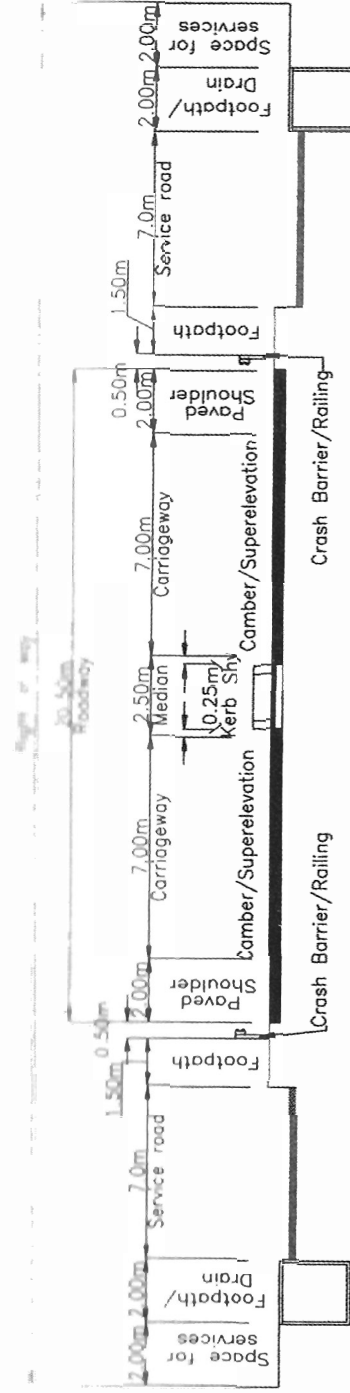

**TYPICAL CROSS SECTION TYPE-B**  
(Built - up Section - Plain/Rolling terrain)  
Fig : 2.6 4-Lane Divided Highway with Service Roads and with Raised Median

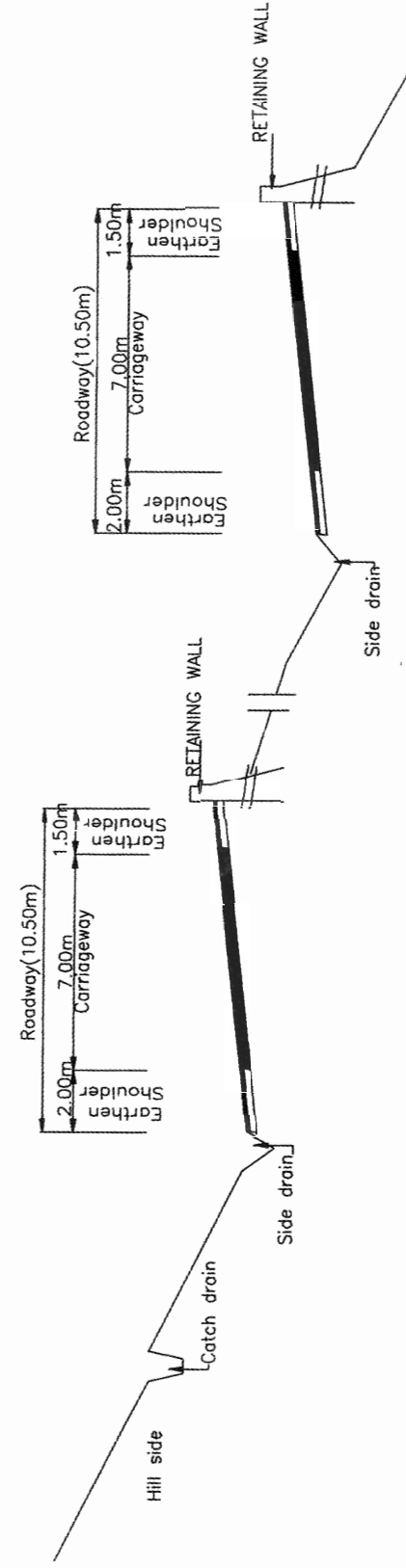

**TYPICAL CROSS SECTION TYPE-C1**  
(Open country - Mountainous terrain)  
Fig : 2.7 4-Lane Divided Highway on Different Contours

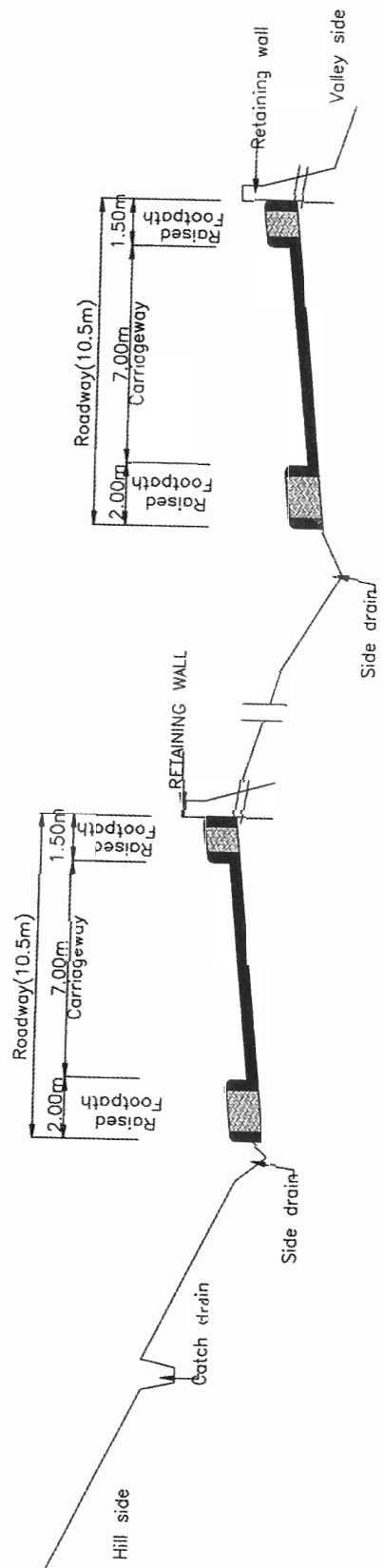

**TYPICAL CROSS SECTION TYPE-C2**  
(Built up section - Mountainous terrain)  
Fig : 2.8 4-Lane Divided Highway on Different Contours

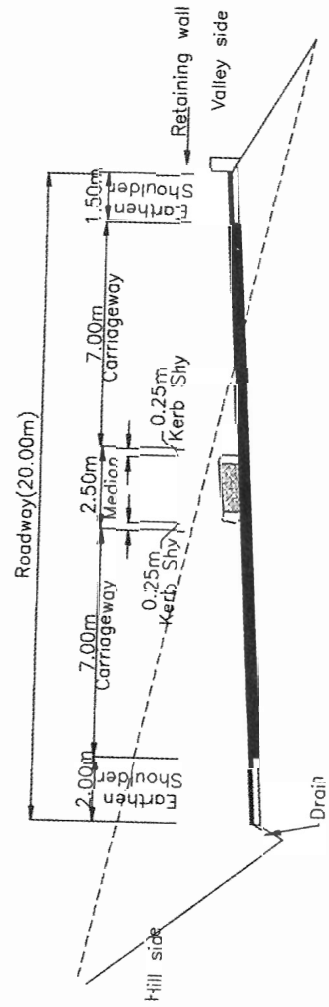

**TYPICAL CROSS SECTION TYPE-C3**  
(Open country - Mountainous terrain)  
Fig : 2.9 4-Lane Divided Highway at same level with Raised Median

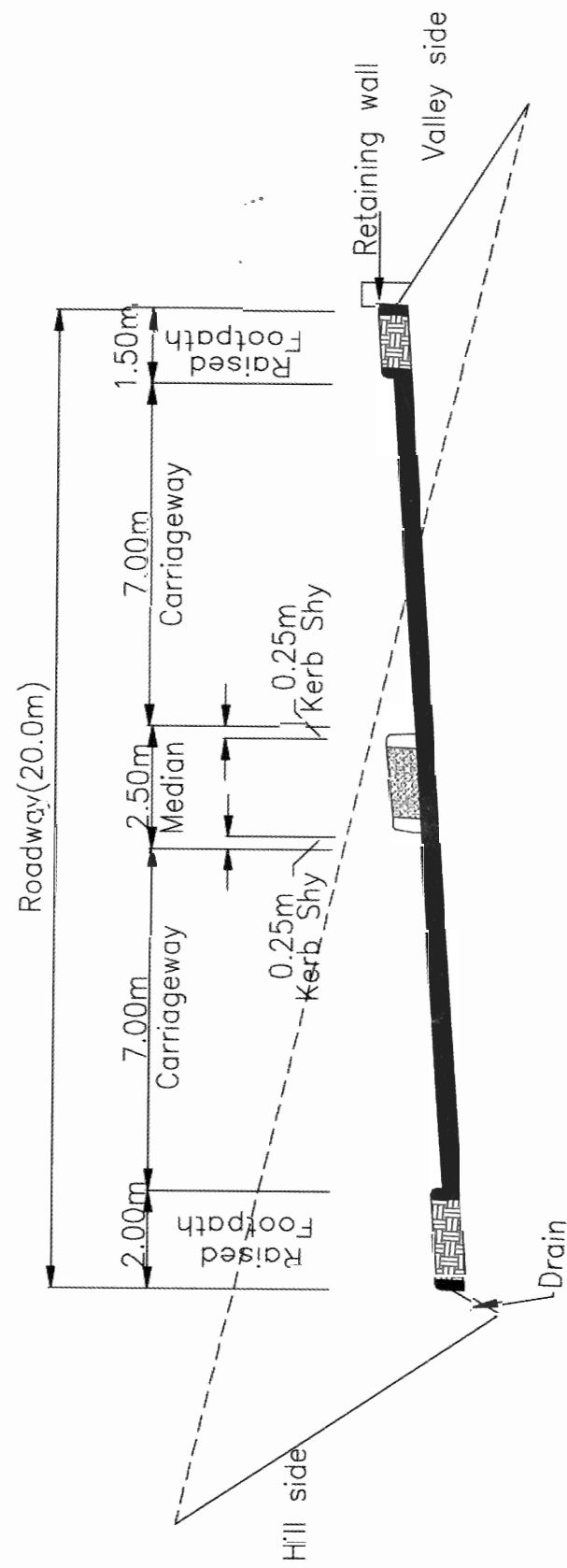

**TYPICAL CROSS SECTION TYPE-C4**  
(Built up section - Mountainous terrain)  
Fig : 2.10 4-Lane Divided Highway at same level with Raised Median

**Fig. 2.10** shows typical cross section Type-C4 for 4-lane divided highway at same level in built up section in mountainous terrain.

**2.17 Capacity of Four-lane highway**

For the purpose of augmentation of the facilities and upgradation of the Project Highway, the design service volume for different terrain conditions and level of service shall be as specified in Table 2.9.

**Table 2.9 Design Service Volume for Four-lane Highways in PCUs per day**

Terrain	Design Service Volume in PCUs per day	
	Level of Service 'B'	Level of Service 'C'
Plain and Rolling	40,000	60,000
Mountainous and Steep	20,000	30,000

*Note* :The definition of PCU here is as per IRC Codes and Guidelines and not the definition given in MCA

**2.18 Warrants for Six-Laning**

Unless otherwise specified in the Concession Agreement, the Project Highway shall be widened to 6-lane when total traffic including the traffic on *service roads*, if any, reaches the design service volume corresponding to Level of Service 'C' for 4-lane highway specified in Table 2.9.

**SECTION - 3**

**INTERSECTIONS AND GRADE SEPARATORS**

## SECTION - 3

## INTERSECTIONS AND GRADE SEPARATORS

## 3.1 Introduction

3.1.1 The intersections to be provided shall be one of the following types:

- i) At-grade Intersections
- ii) Grade separated Intersections without ramps
- iii) Interchanges

The types and locations of Intersections, Interchanges and Grade-separated Intersections without ramps shall be based on requirements stipulated in IRC:SP:41, IRC:5 IRC:92, MORTH Specifications for Road and Bridge works. These shall be specified in Schedule 'B' of the Concession Agreement.

3.1.2 The existing intersections, which are deficient with respect to the minimum requirements shall be improved to the prescribed standards. Additional land, if any, required for improving the existing intersections shall be provided by the Authority.

## 3.2 At-grade Intersections

3.2.1 The type of intersections to be adopted shall be decided on the basis of parameters like number of intersecting legs, traffic volume/speed, type of traffic control etc. Properly designed intersections shall be provided at all at-grade crossings. Rotary shall not be provided.

- 3.2.2 i) The intersections shall be designed having regard to flow, speed, composition, distribution and future growth of traffic. Design shall be specific to each site with due regard to physical conditions of the site available. The design of different elements of intersection shall be done as per IRC:SP:41 "Guidelines on Design of At-grade Intersections in Rural and Urban Areas" including other criteria given in this Manual. MORTH - Type Designs for Intersection on National Highways may also be referred to, wherever required to develop suitable layout and design of At-grade Intersections.
- ii) At multi leg intersections, the points of conflict should be studied carefully and possibilities of realigning one or more of the intersecting legs and combining some movements to reduce the conflicting movements shall be examined. The object shall be to simplify the design and appropriate control devices added to ensure more efficient and safe operation.

- iii) The channelising islands shall start from the edge of the paved shoulder. This principle shall also apply in case of MORTH – Type Designs for Intersections on National Highways.

**3.2.3** Cross roads shall join directly on to service roads and the entry to and exit from the Project Highway shall be through end connections as shown in fig. 2.1A to H.

### **3.3 Grade separated Intersections and Interchanges**

**3.3.1** Grade separated intersections, without ramps, shall be provided at locations where traffic on cross roads is moderate to heavy. Under this type, two cross roads separate at different grades (as Road Under Bridge or Road Over Bridge). The access from Project Highway to the cross roads in case of such grade separated intersections without ramps, shall be through other existing roads/ service roads.

**3.3.2** An interchange is justified at locations where traffic on cross road is heavy and an at grade intersection fails to handle the volume of turning, merging and diverting traffic.

#### **3.3.3 Geometric standards for design**

The geometric design standards for various elements of grade separators shall be as given in IRC:92. Gradient for approaches shall not be steeper than 2.5 percent (1 in 40).

#### **3.3.4 Design of structures**

Design of structures shall conform to Section 7 of this Manual. Minimum length of viaduct required to be provided shall be specified in Schedule 'B'.

#### **3.3.5 Lighting**

Lighting requirement shall be as per Section 12 of this Manual. The top and underside of the grade separated structures and interchange area at the ground level upto 50 m beyond the point from where flaring of the main carriageway takes place shall be provided with lighting.

### **3.4 Detailed Design and Data for Review by the IE**

The Concessionaire shall submit the details of the ground surveys, traffic data, traffic forecast, design and drawings of the intersections and interchanges showing all safety features to the Independent Engineer for review and comments, if any.

## **SECTION - 4**

# **EMBANKMENT & CUT SECTIONS**

## SECTION - 4

### EMBANKMENT & CUT SECTIONS

#### 4.1 General

4.1.1 The design and construction of the road in embankment and in cuttings shall be carried out in accordance with Section 300 of MORTH Specifications and the requirements, and standards and specifications given in this Section. This Section also covers specifications for sub-grade and earthen shoulders.

4.1.2 Efforts should be made to remove the inherent deficiencies in plan and profile of the existing road. The final centre line of the road and the road levels shall be fixed duly considering all the relevant factors covering structural soundness, safety and functional requirements as per relevant IRC Codes and provisions of this Manual.

4.1.3 The existing road embankment shall be widened/modified to the specified cross-sectional details.

#### 4.2 Embankment

4.2.1 The height of the embankment shall be measured with respect to the finished road levels. The following principles shall be kept in view while fixing the road level:

- i) No section of the road is overtopped. The finished road level shall be at least 0.6 m above ground level (except in cutting and transition length).
- ii) The bottom of sub-grade is generally 1.0 m above the high flood level/ high water table. However, in the case of existing old roads where it may be difficult to fulfill this criterion without needing reconstruction or raising in substantial length, the criteria may be relaxed depending on site conditions, ensuring that the bottom of sub-grade is 0.6 m above High Flood Level (HFL). The HFL should be decided by intelligent inspections, local observations, enquiries and studying the past records. If raising of any section(s) of the existing road is required, the same shall be specified in Schedule 'B' of the Concession Agreement.

#### 4.2.2 Materials and physical requirements

4.2.2.1 Sourcing of materials for embankment and subgrade construction, as well as compliance with environmental requirements in respect of excavation and borrow areas under the applicable laws shall be the sole responsibility of the Concessionaire.

4.2.2.2 The material to be used in sub-grade shall satisfy the design California Bearing Ratio (CBR) at the specified density and moisture content.

**4.2.2.3** The embankment and subgrade shall be compacted to satisfy the minimum compaction requirements given in Clause 305 of MORTH Specifications.

#### **4.2.3 Structural features and design of embankment**

**4.2.3.1** Embankment with height 6.0 m or above shall be designed in accordance with IRC:75 taking into account slope stability, bearing capacity, consolidation, settlement and safety considerations based on geotechnical and investigation data. Where the embankment is to be supported on a weak stratum, appropriate remedial/ground improvement measures shall be taken.

**4.2.3.2** Side slopes shall not be steeper than 2H:1V unless soil is retained by suitable soil retaining structures.

**4.2.3.3** The side slopes shall be protected against erosion by providing a suitable vegetative cover, kerb channel, chute, stone/cement concrete block pitching or any other suitable protection measures depending on the height of the embankment and susceptibility of soil to erosion. Drainage arrangement shall be provided as per Section 6 of this Manual.

#### **4.2.4 Use of pond ash for embankment construction**

Where pond ash is used for embankment construction in pursuance of the instructions of the Ministry of Environment and Forests or otherwise, the embankment shall be designed and constructed in accordance with IRC: SP:58.

### **4.3 Roadway in Cutting**

The road level shall be fixed, keeping in view the provisions of relevant IRC Codes.

### **4.4 Soil Investigations and Design Report**

#### **4.4.1 General**

The Concessionaire shall carry out necessary soil surveys, and field and laboratory investigations for selecting appropriate borrow pits, identifying and treating problematic ground locations, if any, and for finalizing structural features and design of the embankment and cut sections and establishing improved ground properties. A report on the soil investigation shall be furnished along with the design.

#### **4.4.2 Soil investigations for embankment**

Soil investigations shall cover the following:

- a) Soil investigations and tests in accordance with the requirements specified in IRC:SP:19 and shall be reported in the Proforma given in Table 1 of

IRC:SP:19. In addition to this, all tests as per the requirements of MORTH Specifications shall be reported.

- b) In respect of embankments with height more than 6 m, additional investigations and soil tests as per IRC:75 and Appendix 10 of IRC:SP:19.
- c) Information regarding the topography, high flood level, natural drainage conditions, highest sub-soil water level, and the nature and extent of inundation, if any.
- d) The characteristics of embankment foundation including the presence of any unsuitable/weak strata, marshy areas, water logged areas, etc.
- e) Along the alignment of the road, where unstable strata, soft material or poor subsoil conditions have been met with at the foundation level, the soil profile shall be drawn after determining through borings, the type of soil at different levels. The borings shall be at maximum interval of 100 m to a depth of 2 m or more below the existing ground as necessary. In the case of high embankments, the borings shall be taken down to a depth equal to twice the height of the embankment.
- f) Any particular construction problems of the area or other important features.
- g) Geotechnical properties of pond ash, covering parameters specified in Table 1 of IRC:SP:58 and Optimum Moisture Content (OMC) – dry density relationship for heavy compaction. This information shall be furnished, in case pond ash is used in embankment construction.

#### **4.4.3 Soil investigations for cut sections**

Soil investigations and tests shall be carried out in accordance with the requirements specified in IRC:SP:19 and information regarding depth of water table, seepage flow, presence of any weak, unstable or problematic strata.

#### **4.4.4 Design Report**

The Concessionaire shall prepare the design report with all relevant details including the following:

- i) Road Embankment
  - a) The detailed design of the embankment, remedial/ground improvement treatment where required. For embankments with height more than 6 m, construction methodology should also be included.
  - b) Design of retaining walls/reinforced earth structures.

- c) Design of protection measures for embankment slope and drainage arrangement.
  - d) Design of pond ash embankment in case use of pond ash is proposed.
  - e) Any additional information relevant to the design of embankment.
- ii) Cut Section
- a) Type of cutting involved and proposed cut slopes shall be provided in accordance with the nature of the soil encountered. Where required, benching including use of slope stability measures like pitching, breast walls, etc. shall be adopted to make the slopes stable and safe
  - b) Design and details of erosion control, slope protection measures, etc.
  - c) In cut sections in hilly terrain, the problem of seepage flow is common. Where such conditions exist, necessary measures shall be taken including provision of deep side drains to intercept the seepage flow and discharge the drained water into suitable outlets to avoid any damage to road and cut slopes. Design and details of drainage arrangement for sub-soil and surface water shall be furnished. It should be ensured that rain water and seepage water is quickly drained out. The gradient of drain shall not be flatter than 1 in 200.
  - d) Any other additional information relevant to the design of cut slopes.
- 

## **SECTION - 5**

### **PAVEMENT DESIGN**

## SECTION - 5

### PAVEMENT DESIGN

#### 5.1 General

**5.1.1** The design and construction of new pavement sections, and of strengthening measures (overlay) for the existing pavement shall be carried out in accordance with the criteria, standards and specifications given in this section. Where alternative specifications or materials are proposed to bring in innovation in design etc., provisions of Para 1.12 of this Manual shall apply.

**5.1.2** The design of new pavement sections or strengthening of existing pavements shall take into account all relevant factors for assuring reliable performance and shall also satisfy the specified minimum performance requirements.

**5.1.3** The Concessionaire shall undertake the necessary soil, material and pavement investigations and traffic volume and axle load studies in accordance with the good industry practice for preparing detailed designs.

**5.1.4** The materials, mixes and construction practice shall meet the requirements prescribed in the MORTH/IRC Specifications.

**5.1.5** Where problematic conditions such as expansive soils, swamps or marshes, flooding, poor drainage, frost susceptible areas etc. are found to exist, adequate measures shall be adopted to deal with such site conditions.

#### 5.2 Type of Pavement

**5.2.1** Unless otherwise specified in Schedule 'B', the Concessionaire may adopt any type (flexible/rigid) of pavement structure for new construction.

**5.2.2** Strengthening of the existing flexible pavement will be carried out by providing appropriate bituminous overlay, unless specified otherwise in Schedule 'B' of the Concession Agreement.

**5.2.3** The Authority may require provision of cement concrete pavement on the new carriageway and/or replacement of existing pavement depending upon specific site conditions. Such requirements shall be as specified in Schedule 'B' of the Concession Agreement. The minimum design, construction, performance and maintenance requirements for cement concrete pavements will be specified by the Authority and Schedule-K of the Concession Agreement will be modified accordingly.

### 5.3 Method of Design – New Pavements

#### 5.3.1 Method of design of flexible pavement

The new pavement shall be designed in accordance with the IRC: 37 Guidelines for the Design of Flexible Pavements.

#### 5.3.2 Method of design of rigid pavement

Rigid pavement shall be designed in accordance with the method prescribed in IRC:58 "Guidelines for the Design of Plain Jointed Rigid Pavements for Highways".

### 5.4 Design Requirements for New Pavement Sections

#### 5.4.1 Flexible pavement - design period and strategy

- i) Flexible pavement shall be designed for a minimum design period of 15 years or operation period, whichever is more. Stage construction will be permissible subject to the requirements specified in para (ii) below.
- ii) Alternative strategies or combination of initial design, strengthening and maintenance can be developed by the Concessionaire to provide the specified level of pavement performance over the operation period subject to satisfying the following minimum design requirements.
  - a) The thickness of sub-base and base of pavement section is designed for a minimum design period of 15 years or the operation period, whichever is more and the initial bituminous surfacing for a minimum design period of 10 years.
  - b) The pavement shall be strengthened by bituminous overlay as and when required to extend the pavement life to full operation period. The thickness of bituminous overlay shall be determined on the basis of IRC:81.

#### 5.4.2 Rigid pavement – design period and strategy

- i) Rigid pavement shall be designed for a minimum design period of 30 years. The stage construction shall not be permitted.
- ii) The Pavement Quality Concrete (PQC) shall rest over Dry Lean Concrete (DLC) subbase of 150 mm thickness.
- iii) The DLC will meet the minimum cement and compressive strength requirement as prescribed in IRC:SP:49. DLC will extend beyond the PQC (including that in shoulder, if any) by 0.5 m on either side.

- iv) Below DLC layer, a properly designed drainage layer Granular Sub Base (GSB) of 150 mm thickness shall be provided throughout the road width. It shall be designed to obtain a drainage coefficient of not less than 20 m per day.

#### 5.4.3 Pavement performance requirements

- i) The pavement structure shall be capable of giving the specified performance over the entire operation period.
- ii) The new pavement surface shall satisfy the following standards,
 

a) Surface Finish	As per requirements of Clauses 902 and 903 of MORTH Specifications
b) Roughness in each lane	Not more than 2000 mm/km for each lane in a km length
c) Rutting	Nil
In wheel path measured by 3 m Straight Edge.	Nil
d) Cracking or any other distress	Nil
- iii) During the operation period, the pavement surface roughness or any structural or functional distress shall not exceed the values specified in Schedule-K of the Concession Agreement. Generally the pavement condition in terms of roughness, cracking and rutting should not deteriorate to the maximum values specified in Schedule-K for rectification, earlier than 5 years from the original level/ from the year of rectification. Any treatment in the form of renewal/ overlay carried out or required to restore/ correct/ improve the riding quality or any distress shall be of such thickness and specification that will restore the riding quality to roughness not exceeding 2000 mm/km.
- iv) During the operation and maintenance period, the pavement strength shall be evaluated periodically through deflection measurements (Refer to para 5.8 (ii) of this Section) and the stretches exhibiting any structural deficiency shall be rectified.

### 5.5 Design Traffic

5.5.1 The design traffic shall be estimated in terms of cumulative number of standard axles (8160 kg) to be carried by the pavement during the design period.

5.5.2 Estimate of the initial daily average traffic flow shall be based on at least 7 days, 24 hr classified traffic counts. IRC:9 may be used as guidance for carrying out the traffic census.

**5.5.3** Any likely change in traffic due to proposed four laning of the facility and/or future development plans, land use, shall be duly considered in estimating the design traffic.

**5.5.4** Traffic growth rate shall be established for each category of commercial vehicles to be considered for design of pavement. For traffic projections, the procedure outlined in IRC:108 may be followed. The Concessionaire shall adopt a realistic value of the rate of traffic growth, provided that annual rate of growth of commercial vehicles shall not be adopted less than 5 percent.

**5.5.5** The design traffic in case of service road shall be five million standard axles. The crust composition shall be provided accordingly.

### **5.6 Sub-grade**

The subgrade, whether in cut or fill, shall meet the requirements stipulated in Clause 305 of MORTH Specifications. The thickness of subgrade shall not be less than 500 mm

### **5.7 Pavement Components and Materials**

- i) The pavement construction materials for sub-base, base and bituminous surfacing shall conform to the requirements prescribed in MORTH Specifications and IRC Standards.
- ii) Where several materials will adequately serve as component within the pavement structure, such as a sub-base or a base course, the Concessionaire shall have the option of using any of the materials/specifications, subject to sound engineering practice and product quality requirements.

### **5.8 Performance Evaluation**

- i) Roughness in each lane for full length shall be measured bi-annually using appropriate approved method and equipment.
- ii) The structural evaluation of the pavement shall be made by taking deflection measurements every 5 years in accordance with the procedure given in IRC:81, unless needed earlier for stretches exhibiting severe distress during the operation and maintenance period.

### **5.9 Strengthening of Existing Pavements**

**5.9.1** Before strengthening treatment is prescribed, a detailed pavement condition survey and evaluation shall be carried out in accordance with IRC:81 to determine

- i) The extent of distress and nature of deficiency in the existing pavement structure, and

- ii) Whether any special treatments e.g. provision for remedying reflection cracking, pavement internal drainage, sub-grade improvement/reconstruction, or rectification of any other deficiencies are warranted.

**5.9.2** Necessary corrective measures to treat the identified deficiency shall be taken along with strengthening of the pavement.

**5.9.3** In stretches where the pavement is damaged/deteriorated to such an extent that the use of Benkelman Beam method may not result in a realistic assessment of the strengthening treatment, pavement shall be designed as new pavement.

**5.9.4** Where an existing pavement is built over an untreated expansive/black cotton soil subgrade, its improvement/ strengthening shall be treated separately. Such stretches shall require reconstruction with provision of necessary measures such as replacement/treatment of expansive subgrade, drainage, etc. as per the prescribed specifications and IRC:37; and shall be designed as new pavement. Stretches to be reconstructed, whether due to expansive subgrade or having grossly deteriorated, etc. shall be specified in Schedule 'B' of the Concession Agreement.

**5.9.5** No granular layer shall be provided over an existing bituminous surfacing. Situations may arise where it is envisaged to strengthen grossly deficient existing road with a granular layer in addition to the bituminous overlay, or where for camber and/or grade correction substantial thickness of profile corrective course is needed. In such cases, the existing bituminous surfacing shall be completely removed by scarifying/milling and then the pavement built up with the granular layer(s) and bituminous overlay. The thickness and composition of bituminous surfacing (Binder course and Wearing course) over the granular layer shall conform to IRC:37.

### **5.9.6 Design of Overlay**

- i) The thickness of the bituminous overlay shall be determined on the basis of Benkelman Beam Deflection Technique and the design traffic as per the procedure outlined in IRC:81 "Guidelines for Strengthening of Flexible Road Pavement using Benkelman Beam Deflection Technique" as also from structural numbers of existing pavement layers.
- ii) The design period will be the same as specified for the new pavement sections vide Para 5.4.1 of this Section. The initial strengthening shall be done for a minimum design period of 10 years. Subsequent strengthening to extend the pavement to full operation period shall be implemented at the end of initial design period or earlier, in case of any structural distress in the pavement or if the surface roughness exceeds the value specified in Schedule 'K' of the Concession Agreement.
- iii) The design traffic will be estimated as per the procedure described for new pavement.

- iv) The thickness of bituminous overlay for pavement strengthening shall not be less than 50 mm bituminous concrete, after attending to the requirements of profile corrective course.

#### 5.9.7 Bituminous mix for overlay

- i) The specifications for the bituminous mixes for the overlay shall be as specified for bituminous surfacing for new pavement sections.
- ii) Design of recycled mix where provided shall conform to the requirements of Clause 517 of MORTH Specifications.

#### 5.9.8 Pavement performance requirements and evaluation

- i) The strengthened pavement shall satisfy the minimum standard and maintenance requirements specified for new pavement sections in this Manual and Schedule-K of the Concession Agreement.
- ii) The performance measurement and evaluation will be done as given in this Manual.

#### 5.10 Paved Shoulders

- i) Paved shoulders shall be provided as specified in this Manual
- ii) If the thickness of the existing paved shoulder, if any, is less than the thickness of the existing pavement, the paved shoulders shall be reconstructed to the pavement thickness in the adjoining carriageway.

#### 5.11 Construction, Workmanship and Quality of Works

All materials, construction operations, workmanship, surface finish and quality of completed construction for all pavement works including sub-grade, sub-base, base course, bituminous surface courses for both new pavement and strengthening of existing pavements, shoulders, service roads, etc. shall conform to the specified requirements and comply with the provisions of Section 900 of the MORTH Specifications.

#### 5.12 Premature Distress

Notwithstanding the minimum design, specifications and standards specified in the preceding paras for new pavements and strengthening of existing pavements, if the pavement shows premature distress in the form of cracking, rutting, patching, loss of camber or any other structural or functional distress, necessary remedial measures by strengthening/resurfacing/recycling shall be undertaken for conforming to the minimum requirements prescribed in Schedule 'K' of the Concession Agreement. In case of repetition of the distress, reconstruction shall be resorted to after proper investigations.

#### 5.13 Detailed Design Report

**5.13.1** The new pavement design and strengthening proposals formulated on the basis of the detailed investigations and studies shall be submitted to the Independent Engineer alongwith Data Collection, Data Evaluation and Design Reports.

#### 5.13.2 Data collection

Following details shall be included in the report:

- i) Soil investigation data for new pavements as per Table 13.2 of IRC:SP:19. Report shall include OMC–dry density relationship with heavy compaction and soaked CBR values in addition to other data and information as per the prescribed Proforma.
- ii) Test values of aggregate for pavement courses as per Tables 13.3 and 13.4 of IRC:SP:19. All tests as per requirements of MORTH Specifications shall be reported in addition to the tests and information included in the above mentioned Tables.
- iii) Classified traffic counts in Proforma 1 of IRC:SP:19.
- iv) Axle load surveys and VDF values for each category of commercial vehicles as per Proforma 4 of IRC:SP:19.
- v) Estimation of traffic growth and traffic projections for pavement design.
- vi) Pavement condition data in the Proforma given in Table 2 of IRC:81.
- vii) Pavement roughness data determined through appropriate method as approved by the Authority.
- viii) Pavement Deflection Data measured by Benkelman Beam as per the procedure detailed in IRC:81. Pavement deflection data shall be recorded in the prescribed Proforma vide Table 3 of IRC:81. The deflection data shall be accompanied with the characteristics of the sub-grade soil covering type of sub-grade soil, field moisture content (at the time of deflection survey), average annual rainfall in the area, and pavement temperature at the time of deflection survey.
- ix) Any other relevant information required by the Independent Engineer for review and comments, if any.

#### 5.13.3 Data evaluation

The report shall inter alia cover:

- i) Data evaluated – soil characteristics and subgrade strength, pavement distress, pavement deflection, riding quality, skid resistance, drainage aspects, etc.

- ii) Pavement deficiencies, drainage and constraints.
- iii) Any other relevant details.

**5.13.4 Detailed design**

The Report shall contain the detailed design of the preferred solution along with any special treatment proposed for adoption. Any departures from the specifications stated herein shall be supported with authentic standards and specifications and accepted practice.

---

**SECTION - 6**  
**HIGHWAY DRAINAGE**

## SECTION - 6

### HIGHWAY DRAINAGE

#### 6.1 General

6.1.1 The design and construction of surface and subsurface drains for highway drainage shall be carried out in accordance with the requirements of this Section.

6.1.2 For efficient drainage system for the entire Project Highway including structures and facilities, directions contained in Clause 309 of MORTH Specifications, IRC:SP:42 and IRC:SP:50 as relevant shall be followed.

6.1.3 In road sections in cuttings and at underpasses where it may not be possible to drain out the water using gravity flow, necessary arrangement for pumping shall be made.

6.1.4 Detailed survey for levels along the proposed longitudinal drains shall be carried out on both sides of the Project Highway. The bottom levels of these drains shall meet the culverts and bridges.

#### 6.2 Surface Drainage

6.2.1 The selection of type of roadside drains shall be based on the magnitude and duration of flow. The roadside drains shall be designed on the principles of flow in open channel.

6.2.2 The road side drains shall not pose any danger to traffic, slopes of cuttings, embankment, pavement or structures.

6.2.3 As far as possible, longitudinal slope shall not be less than 0.5 percent for lined drains and 1.0 percent for unlined drains. Permissible non-erodible flow velocity for corresponding earth surface as mentioned in Clause 9.4 of IRC:SP:42 shall be kept in view.

6.2.4 The side slopes of the unlined drains shall be as flat as possible and shall not be steeper than 2H: 1V.

6.2.5 The drains shall be provided with CC lining in the following situations:

- i) When due to space constraint, the drains are located near the toe of the embankment or near structures.
- ii) Drains located in built-up areas.
- iii) Flow velocity is more than 0.3 m to 1 m/s in silt and sand; and more than 1.5 m/s in stiff clay.

**6.2.6** In built-up areas, covered or piped drains, with manholes at suitable intervals to desilt the pipes, shall be provided.

### **6.3 Median Drainage**

**6.3.1** Proper arrangement for drainage of median shall be provided. The median drain should have adequate longitudinal slope to the nearest culvert to drain off transversely.

**6.3.2** In case the carriageway is sloping towards unkerbed median (wider than 5 m), provision of a central swale shall be made for drainage of the median. The swale shall slope longitudinally for drainage, water intercepted by inlets at intervals and discharged through transverse drains into outlet channel.

**6.3.3** Median of width 7 m or less shall be turfed or paved and could be crowned for drainage across the pavement.

**6.3.4** In superelevated sections, proper arrangement for drainage of raised carriageway and median shall be made without allowing water to drain on the other carriageway.

### **6.4 Drainage of Embankment with Height Above 3 m**

**6.4.1** In embankments with height more than 3 m and approaches to bridges, special arrangement for protection of embankment slopes shall be essential in order to ensure that embankment slopes maintain their shape during the monsoon season. In this respect, directions contained in Clause 7 of IRC:SP:42 may be followed as appropriate for the climatic conditions of the area of the Project Highway.

**6.4.2** Drainage arrangement shall include provision of kerb channel at the edges of the roadway to channelise the water, and Cement Concrete (CC) lined chutes along the slopes at designed intervals to discharge the water into side channels at the bottom along with appropriate protection of the slope. The slope protection material and chutes shall be kept well maintained at all times.

**6.4.3** The chute drains and drains at toe of the embankment shall be of Plain Cement Concrete (M 15 grade), over proper bedding.

### **6.5 Catch Water Drains**

**6.5.1** Suitable catch water drains shall be provided on the hill slope above cutting to collect and remove surface water run-off from upper reaches. These drains shall be of trapezoidal shape and stone lined and cement pointed.

**6.5.2** The catch water drains shall be designed to carry the intercepted water to the nearest culvert or natural drainage channel.

**6.5.3** It shall be ensured that the catch water drains are provided in stable hill slopes outside the periphery of slide/unstable areas.

**6.5.4** Where required, lined chutes shall be provided to lead the discharge to the catch pit of culvert or to a natural drainage channel.

### **6.6 Sub-surface Drains**

**6.6.1** The sub-surface drainage shall be provided

- i) for lowering the level of water table for drainage of sub-grade;
- ii) to intercept or drain out free water in cut slopes; and
- iii) for drainage of pervious subbase in situations where it may not be practicable to extend the subbase across the shoulder.

**6.6.2** Sub-surface drains shall not be used for surface drainage.

**6.6.3** The sub-surface drains shall be:

- i) Close jointed perforated pipes or open jointed unperforated pipes in trenches with backfill material around pipes.
- ii) Aggregate drains consisting of free draining material in the trench without any pipe.

**6.6.4** Perforated pipes and unperforated pipes shall meet the requirements of Clause 309.2 of the MORTH Specifications.

**6.6.5** The internal diameter of the pipe shall not be less than 150 mm.

**6.6.6** The sub-surface drains shall be located not less than 0.5 m below the sub-grade.

**6.6.7** **Backfill material:**

- i) Backfill material shall be free draining sand, gravel or crushed stone designed on inverted filter criteria for filtration and permeability, or of an appropriate grading conforming to the requirements of Table 300.3 of the MORTH Specifications.
- ii) Thickness of backfill material around the pipe shall not be less than 150 mm. The minimum thickness of material above the top of the pipe shall be 300 mm.

**6.6.8** Sub-surface drains outside the road pavement shall be sealed at the top to avoid percolation of surface water into these drains.

**6.6.9 Use of Geo-textile**

- i) The sub-surface drains may be designed using appropriate geotextile to serve the functions of filtration and separation.
- ii) The sub-surface drains can be provided with geotextile either along the trench or around the pipe or both.
- iii) The geotextile shall satisfy the requirements of Clause 702 of the MORTH Specifications.

**6.6.10** Trench excavation, laying of pipe, backfilling, and use of geosynthetics shall conform to the requirements of Clause 309.3 of the MORTH Specifications.

**6.6.11** The drain outlet shall be a free outlet and shall be provided as per Clause 309.3 of the MORTH Specifications.

**6.6.12 Aggregate drains**

- i) The trench for aggregate drain shall be of minimum 300 mm width and cut to a depth to expose the granular pavement courses to be drained.
- ii) Aggregate for the drain shall be gravel, stone aggregate or slag of grading as per Table 8 of IRC:SP:42.
- iii) The aggregate drain shall be provided with a geo-textile wrap to act as filtration and separation layer.

**6.6.13** Design of subsoil drainage shall be based on a rational basis. Reference may be made to IRC:SP:42.

**6.7 Internal Drainage of Pavement Structure**

- i) Boxed type construction in which pavement is housed in earthen shoulders shall not be provided.
- ii) The sub-base shall be extended across the shoulders for efficient drainage of pavement.
- iii) The granular sub-base shall be of proper design and grading to perform satisfactorily as a drainage layer. The drainage layer shall not have material finer than 75 micron size.
- iv) A suitable filter of granular material or geotextile to act as filtration and separation layer shall be incorporated, where necessary, between the sub-grade and sub-base to prevent clogging.

**6.8 Survey, Investigation and Design Report**

The Concessionaire shall carry out proper surveys and investigations for detailed design of the drainage system. The proposal for drainage system supported with survey investigation report and detailed design report shall be submitted to the Independent Engineer for review and comments, if any.

**6.8.1 Drainage studies**

The survey and investigation and drainage studies shall include:

- i) Alignment plan, longitudinal and cross sections, contour map.
- ii) Hydrological data  
Drainage area, water shed delineation, direction of flow, location of outfalls, existing surface drains, ground surface condition, rainfall, flood frequency, etc.
- iii) Data for hydraulic design of drains
- iv) Geo-technical investigations for sub surface strata, level of water table, seepage flow etc.
- v) Identification of areas requiring sub-surface drainage.
- vi) Any other relevant information  
IRC:SP:19, IRC:SP:42, IRC:SP:48 and IRC:SP:50 may be referred to.

**6.8.2 Design details**

The report shall include:

- i) Estimation of design discharge.
- ii) Design of surface drains.
- iii) Design of sub-surface drains.
- iv) Drainage arrangement plan along with cross section of drains with longitudinal levels, cross drainage works and a strip chart.
- v) Specifications of drains.
- vi) Any additional information as required by the IE for review of the drainage system.

**6.8.3 Responsibility for design and adequacy**

The Concessionaire shall be fully responsible for design and adequacy of the drainage system throughout the operation period as per the requirements of the Concession Agreement.

**SECTION - 7**  
**DESIGN OF STRUCTURES**

**SECTION - 7**  
**DESIGN OF STRUCTURES**

**7.1 General**

- i) All bridges shall be designed in accordance with the relevant Codes, Standards and Specifications and Special Publications and Guidelines of the IRC. All construction of bridges shall conform to MORTH Specifications for Road and Bridge Works.
- ii) All bridges shall have independent superstructure for each direction of travel unless specified otherwise in Schedule 'B'. Culverts may have single or independent superstructure.
- iii) All bridges shall be high level bridges unless specified otherwise in Schedule 'B' of the Concession Agreement.
- iv) Viaduct spans shall be provided if the height of solid embankment in built-up sections is more than 5 m.
- v) The width of median in the culvert and bridge portion shall, as far as possible, be kept same as that in the approaches. In case width of median is different from that of approach section due to site constraints, suitable transition shall be provided near approaches for guiding vehicular traffic.
- vi) The median in the portion of structures shall be treated as below:
  - a) A suitably designed catch pit shall be provided to collect and carry discharge from median drain.
  - b) For bridges, where the median is more than 1.2 m wide, the median shall be open to sky. The safety barrier on the median side shall be provided at a clear distance of 0.5 m from the edge of carriageway.
- vii) Suitable provision shall be made for retaining the earth in the median portion either by extending the abutment wall or constructing a new retaining wall. The abutment wall shall have provision for taking the discharge from the median. Care shall also be taken to merge the wing wall /return wall and flooring of the old bridge with those of the new bridge.
- viii) Any utility service to be carried by the structures shall be specified in Schedule 'B' of the Concession Agreement.

**7.2 Design Loads and Stresses**

- i) The design loads and stresses shall be as per IRC:6 appropriate for the width of carriageway, velocity of stream, location, altitude, environment, etc.

- ii) All new structures shall be designed for the condition when footpath is used as carriageway. The footpath portion may be provided at the same level as the bridge carriageway and separated by crash barrier in non built-up areas. In built-up areas, raised footpaths shall be provided.
- iii) All the components of structures shall be designed for a service life of 100 years except appurtenances like crash barriers, wearing surface and rubberized components in expansion joints and elastomeric bearings. All the requirements to achieve durability and serviceability shall be implemented.

**7.3 Width of Structures**

Width of the culverts and bridges shall be adopted as below:

- i) New culverts

Overall width of all new culverts shall be equal to roadway width of the approaches. The outer most face of railing/parapet shall be in line with the outer most edge of shoulder. Typical cross section of the new culverts for a 4-lane project highway is given in Fig. 7.1.

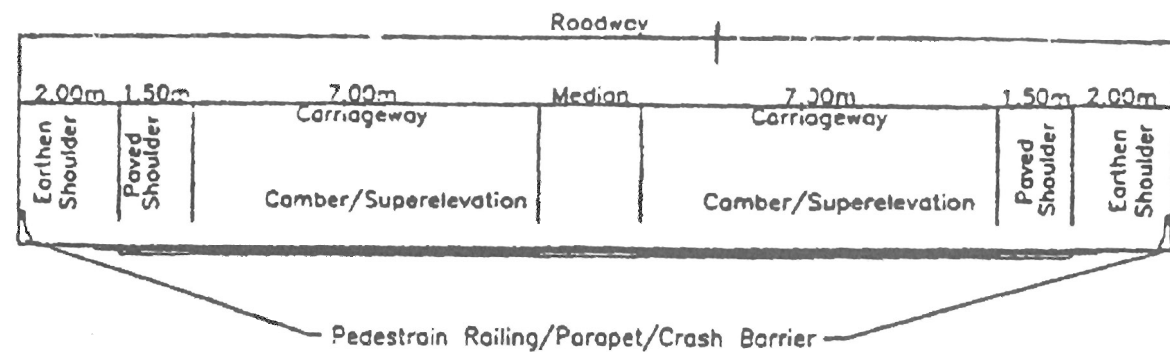

Fig: 7.1 Cross Section of Pipe Culverts at Road Level 4-Lane Divided Highway

- ii) New bridges

- a) The overall width of new bridges shall be same as the roadway width of the approaches. All new bridges shall have a footpath on left side of the traffic. Typical cross section of such type of new bridge with footpath for a 4-lane project highway is given in Fig. 7.2.
- b) Where the daily traffic in PCUs exceeds 30,000 at the time of feasibility study/ bidding, the width of new bridge shall be as per Six-lane standards vide details given in Fig. 7.3 with footpath. Such bridges shall be indicated in Schedule 'B'.

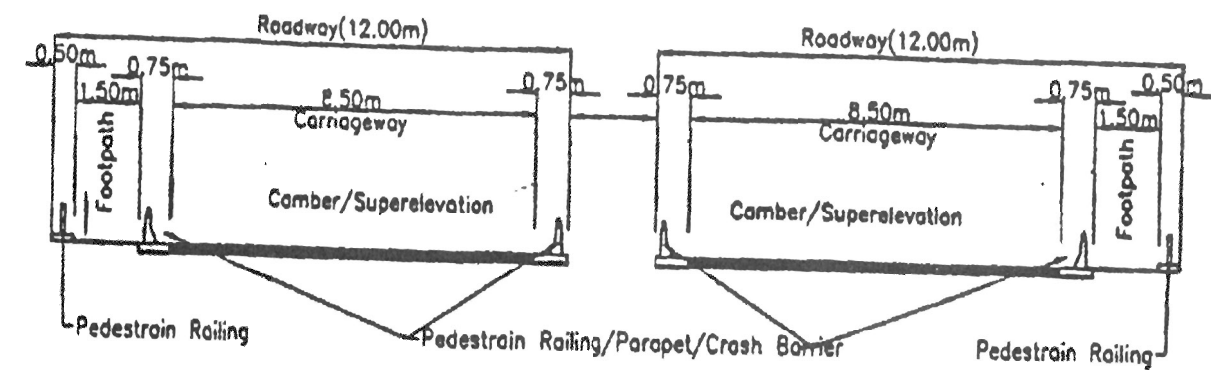

Fig. 7.2 Cross Section of Bridge at Deck Level - with Footpath 4-Lane Divided Highway

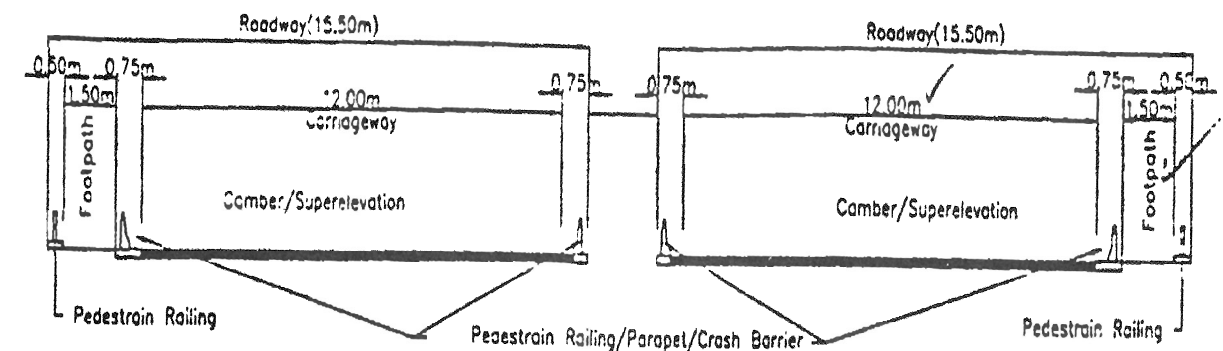

Fig. 7.3 Cross Section of Bridge at Deck Level - with Footpath 4-Lane Divided Highway (Both sides new Bridges for 6-Lane Standards)

- c) Where the length of bridge structure including grade separated structures exceeds one km, provision shall be made for passing place at the rate of one passing place for every one km (or part thereof). These shall be indicated in Schedule 'B' of the Concession Agreement. However, no passing place would be provided where structures are six-lane wide.
- iii) Existing culverts
  - a) All culverts which are structurally distressed or not having sufficient vent/ size shall be reconstructed as new structures of width as per Sub Para 7.3 (i) of this Section.
  - b) All existing culverts which are not to be reconstructed shall be widened equal to the roadway width of the approaches.

- c) The culverts and Hume pipe structures shall be widened so as to make the deck width same as specified in Sub Para 7.3 (i) of this Section. If the width of additional widening is less than 0.5 m on either side, the widening of the structure may be dispensed with and traffic shall be guided with the help of crash barriers in a transition of 1 in 20 on either side approaches.
- d) List of culverts to be reconstructed and/or widened shall be specified in Schedule 'B' of the Concession Agreement.

iv) Existing bridges

- a) All bridges which are structurally distressed shall be reconstructed as new bridges of width as per Sub Para 7.3 (ii)
- b) Components like bearings, expansion joints, railings, crash barriers, wearing surface, etc., which are not in sound condition, shall be replaced. Minor non-structural works shall be suitably repaired.
- c) If the width of additional widening is 1.0 m (0.5 m on each side) or less, the widening of the structure may be dispensed with and traffic shall be guided with the help of crash barriers in a transition of 1 in 20 on either side approaches.
- d) The bridges having 2-lane carriageway particularly those with T-beam/Box type superstructure with well/pile foundation, which are in sound condition, may be retained and proper transition between approach and bridge shall be provided. Typical cross sections at deck level for bridges with and without footpaths showing new bridge on one side and existing 2-lane bridge on the other side are given in Fig. 7.4 A and 7.4 B respectively.
- e) The width of the new structures constructed on the other side of the existing bridge shall be as specified in Sub Para 7.3 (ii) of this Section.
- f) List of bridge structures to be reconstructed and/or widened shall be specified in Schedule 'B' of the Concession Agreement.

7.4 Structure Types

- i) The bridge structure should aesthetically blend with the environment.
- ii) The type and span arrangement may be fixed so as to provide riding comfort.
- iii) Wherever box girders are proposed for superstructure, the minimum clear depth inside the box shall be 1.50 m with suitable openings in the

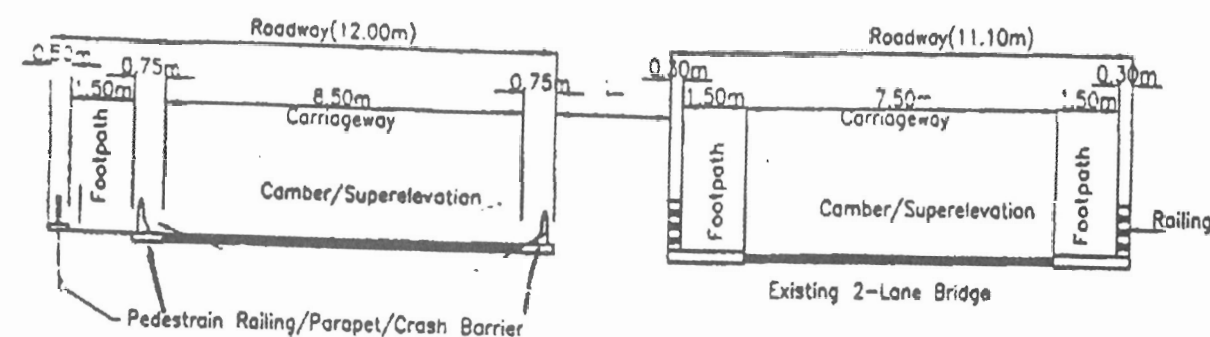

Fig. 7.4A Cross Section of Bridge at Deck Level - With Footpath (T-Beam/Box Girder Type / Well / Pile Foundation) 4-Lane Divided Highway (One side new Bridge and other sides Existing for 2-Lane Bridge)

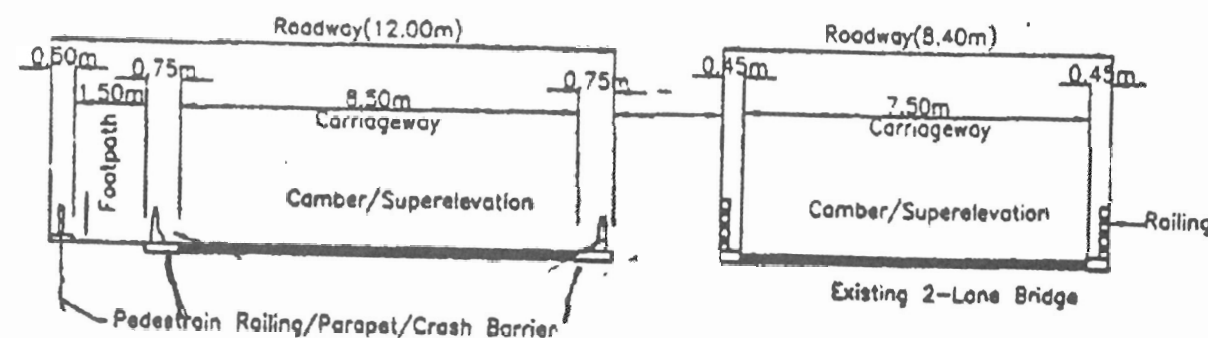

Fig. 7.4B Cross Section of Bridge at Deck Level - Without Footpath (T-Beam/Box Girder Type / Well / Pile Foundation) 4-Lane Divided Highway (One side new Bridge and other sides Existing for 2-Lane Bridge)

diaphragms and box to facilitate inspection. Haunches of minimum size of 300 mm (horizontal) and 150 mm (vertical) shall be provided at the extreme corners of the box section. Suitable arrangements for lighting shall be made to enable inspection of the box.

- iv) The following types of structures shall not be accepted.
  - a) Drop in spans with halved joints (articulations)
  - b) Trestle type frames for substructures
- v) If construction of structures like cable stayed/ suspension bridge or with special techniques is envisaged, it shall be specified in Schedule 'B' of the Concession Agreement.

## 7.5 Hydrology

All the structures shall have adequate waterway, which shall in any case be not less than that of existing bridge (except when such waterways can be reduced in cases like clogging or silting of spans, etc.). The design discharge shall be evaluated for flood of 100-year return period.

## 7.6 Sub-Soil Investigations

Independent sub-soil investigations shall be carried out to establish the soil parameters required for detailed design of foundations in accordance with relevant provisions of IRC:78 and MORTH Specifications.

## 7.7 Culverts and Bridges using Pipes

- i) Reinforced concrete pipes for culverts and bridge structures shall be of Non Pressure (NP) - 4 type conforming to the requirements of IS: 458. Minimum diameter of pipes for new pipe culverts shall be 1200 mm.
- ii) Existing culverts of diameter 900 mm and above, which are in sound condition and functioning satisfactorily, may be extended, using pipes of same diameter. All culverts having pipe diameter less than 900 mm shall be replaced with pipes of minimum 1200 mm diameter under both the carriageways. Minimum depth of earth cushion over pipe including road crust shall not be less than 1000 mm for new/reconstructed culverts. In case of existing sound and safe culverts, a minimum cushion of 600 mm may be acceptable. In case the cushion is insufficient, encasing of pipe in concrete shall be ensured. Floor protection shall be as specified in the relevant IRC Codes and Specifications.

## 7.8 Temporary Works

### 7.8.1 Form work

The Concessionaire shall be responsible for the safe, workable design and methodology for all temporary or permanent forms, staging and centering required for supporting and forming the concrete of shape, dimensions and surface finish as shown on the drawings (Refer IRC:87). Adequate foundation for the staging shall be ensured. Redundancy in support system shall also be ensured by providing diagonals and additional members. The following guidelines shall be adopted:

- i) Formwork shall be of steel, marine ply or laminated plywood.
- ii) Only such shuttering oil (release agent) shall be used, which permits easy removal of shutters without leaving stains or other marks on the surface of the concrete. Requirements given under Clause 3.5 of IRC:87 shall also be complied with.

- iii) In case of tubular staging of heights more than 10 m, special attention shall be paid to the structural adequacy of the system, efficacy of the connections (clamps etc), and foundations. Foundation blocks of adequate thickness in M15 cement concrete shall be provided under the base plates to prevent differential settlements. All bent tubular props shall be straightened before re-use and the member with deviation from straightness more than 1 in 600 of its length shall not be re-used. For re-used props, suitable reduction in the permissible loads shall be made depending upon their condition in accordance with recommendations of the manufacturer and as reviewed by the IE.
- iv) In case of prestressed concrete members, the side forms shall be removed as early as possible and the soffit forms shall permit movement of member without restraint, when prestress is applied. Form supports and forms for cast-in-situ members shall not be removed until sufficient prestress has been applied to carry all anticipated loads during construction stage.
- v) Adequate foundations for formwork shall be ensured.

### 7.8.2 Special temporary and enabling works

Designs, drawings and methodology proposed by the Concessionaire in the use of special temporary and enabling works like Launching Girders, Cantilever Construction Equipment, Tall Formwork, Shoring for Earth Retention, Lifting and Handling Equipments and the like shall be submitted to the Independent Engineer (IE) for his review and comments if any. The Concessionaire shall be fully responsible for the design and structural adequacy of all temporary and enabling works. Review by IE shall not relieve the Concessionaire of this responsibility

## 7.9 Foundations and sub-structures

**7.9.1** The design of foundations and sub-structures shall conform to IRC:78.

### 7.9.2 Open foundations

The design of open foundations shall conform to IRC:78. Floor protection shall be provided as per Section 2500 of MORTH Specifications.

### 7.9.3 Pile foundations

- i) The design of pile foundations shall be done as per IRC:78. The Concessionaire shall submit a method statement supported by the following:-

- a) Bore-log details for each foundation;
  - b) Design assumptions;
  - c) Design calculations both for single pile or group of piles and for pile type;
  - d) Type of piles-Bored cast-in-situ piles and driven piles;
  - e) Procedure adopted for installation of piles;
  - f) Arrangements for load testing of piles;
  - g) Format for reporting of test results.
- ii) The Concessionaire shall submit the following information regarding proposed proprietary system of piling:
- a) General features of the process/system alongwith specifications and standards;
  - b) Authenticated copies of license/agreement, if any;
  - c) Details of plant and equipment to be used along with the names of manufacturers and name of process/system;
  - d) Details of projects where the process/system has been successfully used;
  - e) Limitations, if any;
  - f) Acceptance tests and criteria;
  - g) Installation and maintenance procedure and schedule; and
  - h) Performance warranty.

#### 7.9.4 Well foundations

- i) For conventional method of well sinking, the Concessionaire shall submit a method statement including the following:
  - a) Design calculations and drawings,
  - b) Procedure for sinking and plugging of well,
  - c) Format for reporting of test results.
- ii) If proprietary system of well sinking like jack down method is proposed to be used, the Concessionaire shall submit relevant information covering inter-alia the following:

- a) General features of the system along with specifications and standards and justification for the thickness of steining proposed to be adopted;
  - b) Authenticated copies of license/agreement, if any;
  - c) Details of plant and equipment to be used along with the names of manufacturers and name of process/system;
  - d) Details of projects where the process/system has been successfully used;
  - e) Limitations, if any;
  - f) Acceptance tests and criteria;
  - g) Installation and maintenance procedure and schedule; and
  - h) Performance warranty.
- iii) The Concessionaire in his Methods Statement shall include the procedure for sinking by special methods, carrying out tests, if any, of wells including design criteria/calculations, drawings and formats for reporting test results.

#### 7.10 Approach Slabs

Approach slabs shall be provided as per Clause 217 of IRC:6 and Section 2700 of MORTH Specifications.

#### 7.11 Superstructures

**7.11.1** The design of reinforced and pre-stressed concrete superstructures shall be as per IRC:21 and IRC:18 respectively. The design of steel and steel-concrete composite super structures shall conform to IRC:24 and IRC:22 respectively.

**7.11.2** The Concessionaire shall submit Method Statement indicating interalia the following:

- i) Sources of materials,
- ii) Design, erection and removal of formwork,
- iii) Layout of casting yard together with necessary details,
- iv) Production, transportation, laying, compacting and curing of concrete,
- v) Sequence of concreting in cast-in-situ construction, side shifting of girders, if applicable and placing of girders on the bearings,

- vi) Details of construction joints,
- vii) Prestressing system, if required,
- viii) Methodology and equipment for side shifting and launching of pre-cast girders,
- ix) Key personnel for execution and supervision,
- x) Testing and sampling procedure,
- xi) Equipment details.

## 7.12 Bearings

**7.12.1** All bearings shall be easily accessible for inspection, maintenance and replacement. Suitable permanent arrangements shall be made for inspection of bearings from bridge deck. Design and specifications of bearings shall be as per IRC:83 (Part I, II and III). Spherical bearings shall conform to the requirements of BS:5400. The materials of bearings may however conform to the relevant BIS codes nearest to the specifications given in BS:5400. The drawing of bearings shall include the layout plan showing exact location on top of pier and abutment cap and the type of bearings i.e. fixed/free/rotational at each location along with notes for proper installation. The bearing should cater for movement in both longitudinal and lateral direction in respect of bridge structures more than 12 m wide.

**7.12.2** The Concessionaire shall procure bearings only from the manufacturers approved by MORTH.

**7.12.3** The Concessionaire, shall submit detailed specifications, designs and drawings including installation drawings and maintenance manual incorporating the replacement procedure.

**7.12.4** The Concessionaire shall obtain and submit a complete Quality Assurance Programme (QAP) from the manufacturer. The QAP shall give the full details of the process of quality control, raw material testing, various stages of manufacture, testing of bearing components as well as testing of complete bearing in conformity with relevant part of IRC:83, prior to the commencement of manufacture of the bearings.

**7.12.5** In addition to the routine testing of the materials and bearings at the manufacturer's premises, the Concessionaire shall arrange testing of random samples of one percent (minimum one number of each type) of bearings from independent agency approved by the IE.

**7.12.6** The Concessionaire shall submit a certificate of confirmation regarding quality control measures taken during manufacture of the bearings and the material conforming

to the prescribed standards and specifications. Full lot of bearings of the sample found to have inferior specifications to those certified by the manufacturer or to have major discrepancy in material specifications or which fail to meet the acceptance criteria, shall be rejected.

## 7.13 Expansion Joints

- i) Structures shall have minimum number of expansion joints. This may be achieved by adopting longer spans, making the superstructure continuous or by adopting integrated structures. Expansion joints shall conform to IRC:SP: 69. The Concessionaire shall furnish guarantee/proprietary indemnity bonds from the manufacturers/suppliers of expansion joints for a period of 10 years.
- ii) For existing bridges all expansion joints, which are older than 15 years shall be replaced.
- iii) The Concessionaire shall procure expansion joints only from manufacturers approved by MORTH.
- iv) The expansion joints should cater for movement in both longitudinal and lateral direction in respect of bridge structures more than 12 m wide.

## 7.14 Wearing Coat

- i) The wearing coat may be either bituminous concrete or cement concrete. For new bridges and culverts, the wearing coat shall have unidirectional camber and shall be in conformity with Section 2700 of MORTH Specifications. For existing bridges, the camber as existing may be retained.
- ii) Wearing coat older than 15 years or in damaged/distressed condition shall be replaced.

## 7.15 Reinforced Earth Retaining Structures

**7.15.1** Reinforced earth retaining structures shall not be provided for height more than 6 m unless otherwise specified, and near water bodies. Such structures should be given special attention in design, construction, ground improvement where necessary, maintenance and selection of System/System design. Local and global stability of the structure shall be ensured.

**7.15.2** Design Accreditation and warranty for life of the structure from the approved supplier/manufacturer shall be obtained and furnished. A qualified and experienced technical representative of the approved supplier/manufacturer shall be present on site throughout during the casting and erection phases to ensure that the quality of the works executed by the Concessionaire is in accordance with good industry practice.

IRC:SP:84-2009

**7.15.3** The Concessionaire shall submit relevant information on the system covering inter-alia the following:

- i) General features of the system along with specifications and standards;
- ii) Authenticated copies of license/agreement, if any;
- iii) Details of plant and equipment to be used along with the names of manufacturers and name of process/system;
- iv) Details of projects where the process/system has been successfully used;
- v) Limitations, if any;
- vi) Acceptance tests and criteria;
- vii) Installation and maintenance procedure and schedule; and
- viii) Performance warranty.

**7.15.4** The Concessionaire shall submit a method statement including the following:

- i) Design assumptions calculations and drawings,
- ii) Construction Procedure,
- iii) Tests to be conducted including frequency and the formats for reporting the test results.

**7.15.5** The packaging of reinforcing elements shall clearly indicate the name of the manufacturer/supplier and brand name, date of production, expiry, if any and batch identification number along with the manufacturers test certificates.

### **7.16 River Training and Protective Works**

River training and protective works shall be provided wherever required for ensuring the safety of bridges and their approaches on either side. The special features and design of various types of river training and protective works shall be in accordance with IRC:89.

### **7.17 Safety Barriers**

- i) For bridges without foot paths, concrete crash barriers shall be provided at the edge of the carriageway on all new bridges.
- ii) The type design for the crash barriers may be adopted as per IRC:5. The design loading for the crash barriers shall be as per Clause 209.7 of IRC:6.
- iii) For bridges with foot paths, pedestrian railing shall be provided on the outer side of footpath.

- iv) The railings of existing bridges shall be replaced by crash barriers, where specified in Schedule 'B' of the Concession Agreement.
- v) Parapets/Railings of the existing bridges/culverts to be repaired/replaced shall be specified in Schedule 'B' of the Concession Agreement.

### **7.18 Rail-Road Bridges**

**7.18.1** Unless otherwise specified in Schedule 'B' of the Concession Agreement, ROB/RUB to be provided shall be as specified in this Manual, with particular reference to the provisions of Para 7.3 of this Section.

#### **7.18.2 Road over bridge (road over rail)**

- i) In case a 2-lane bridge exists over the railway tracks, another two-lane bridge shall be constructed for one side traffic. The treatment to existing structure shall be given as in Sub-Para 7.3 (iv) of this Section.
- ii) In case the bridge is to be provided over an existing level crossing, twin 2-lane bridges shall be constructed with overall width as given in Sub-Para 7.3 (ii) of this Section. If the alignment of road at the existing railway crossing has skew angle more than 45°, the alignment of road or of pier/abutment shall be suitably designed to reduce skew angle up to 45°.
- iii) The horizontal and vertical clearances to be provided shall be as per requirement of the Railway authorities.
- iv) The Concessionaire shall be required to obtain approvals of all designs and drawings from the concerned Railway authorities.
- v) The construction of ROB within the railway boundary shall be under the supervision of Railway authorities.
- vi) The approach gradient shall not be steeper than 1 in 40.

#### **7.18.3 Road under bridges (road under railway line)**

- i) Full roadway width as in the approaches shall pass below the bridge structure allowing for widening of Project Highway to 6-lane at a later date. The service roads where provided shall be continued in the bridge portion also.
- ii) The vertical and lateral clearances shall be as per guidelines given in Section 2 of this Manual.
- iii) These structures shall be designed to carry railway loads. The Concessionaire shall be required to obtain approvals of all designs and drawings from the concerned Railway authorities. The design of structure shall be in accordance with relevant Railway codes.

- (iv) The construction of RUB and its approaches shall be carried out in conformity with the terms specified in the approval granted by the Railway authorities.

#### 7.19 Grade Separated Road Structures

- i) The location, type and length of grade separated structures to be provided on the Project Highway shall be as specified in Schedule 'B' of the Concession Agreement.
- ii) The vertical and lateral clearances shall be as per requirements given in Section 2 of this Manual. Design of structures shall conform to requirements specified in this Manual.

#### 7.20 Drainage

An effective drainage system for the bridge deck shall be planned, designed and installed so as to ensure that water from the deck is taken down to ground level/drainage courses by adequate size of drainage spouts and pipes. The type of such arrangement shall be specified in Schedule 'B' of the Concession Agreement.

#### 7.21 Structures in Marine Environment

Necessary measures/treatments for protecting structures in marine environment shall be as specified in Schedule 'B' of the Concession Agreement.

#### 7.22 Repairs and Strengthening

- i) Structures requiring repairs and strengthening shall be specified in Schedule 'B' of the Concession Agreement. This shall be based on detailed condition survey of existing structures and shall bring out the nature and extent of repairs to be carried out, covering the following in addition to other specific requirements:-
- a) Repair/replacement of damaged railings and parapets, provision of crash barriers,
  - b) Replacement of wearing coat (old wearing coat shall be removed and replaced by bituminous wearing coat),
  - c) Replacement of expansion joints,
  - d) Replacement of bearings,
  - e) Structural repairs to substructure/super structure, including replacement of substructure/superstructure if required
  - f) Repair to flooring and protection works.

- ii) The Concessionaire shall submit repairs and strengthening plan for structures in para (i) above to the Independent Engineer for review and comments, if any. For all other structures with minor deficiencies, not affecting structural inadequacies and integrity, appropriate repair measures may be proposed and submitted to the Independent Engineer for review and comments, if any.
- iii) Strengthening/rehabilitation work shall be carried out in accordance with relevant IRC Codes and Guidelines.
- iv) The Concessionaire shall take up repair and widening of existing bridge at a particular site only after the new bridge at that site is constructed and the same can be used by the traffic. Before taking up the works of repair and widening of the existing bridge, the Concessionaire shall make all arrangements to ensure that both way traffic can use the new bridge and a smooth flow of traffic is maintained. The Concessionaire shall take all precautions to guard against any traffic accident due to such diversion and shall use all necessary road signs, traffic management measures etc. for the purpose. After completion of repair and widening of the existing bridge, all arrangements shall be made so that both the old and the new bridges at the site can be used by the traffic. Repair works for substructure, foundation, and abutment etc., which will not affect or disturb the flow of traffic over the existing bridges, may, however, be taken up before completion of the new bridge. In such cases where new 2-lane bridges is not required to be constructed before COD, the existing bridge shall be repaired/strengthened by suitably regulating the traffic on the bridge or by temporary diversion.

#### 7.23 Design Report

The Concessionaire shall furnish the design report including the following to the Independent Engineer for his review and comments, if any.

- i) Sub soil exploration report as per IRC:78 as specified in Para 7.6 above.
- ii) Hydrological Investigation report including design discharge calculation for the bridges, in case of any change in the proposed waterway of any bridge as specified in para 7.5 above.
- iii) Designs and drawings of temporary works, foundations, substructures and superstructure of structures
- iv) Detailed report regarding the bridges whose width is less than the roadway width and the proposal for their improvement.
- v) Any other information relevant to the design report.

**7.24 Responsibility for Design and Structural Adequacy**

The Concessionaire shall be fully responsible for the design, structural adequacy and detailing of bridge and culvert structures. Review by IE shall not relieve the Concessionaire of this responsibility.

---

**SECTION - 8**

**MATERIALS**

**SECTION - 8**  
**MATERIALS**

**8.1 General**

- i) All materials to be used in works shall be in conformity with the requirements laid down for relevant item in IRC/MORTH Specifications unless otherwise specified in this Section. If the Concessionaire proposes to use any material, which is not covered in IRC/MORTH Specifications, it shall conform to relevant Indian Standards, if there are any, or to the International Standards. Proprietary products proposed to be used shall be proven by use in comparable international road and bridge projects, and shall be supported with authenticated licensing arrangement with the manufacturer.
- ii) The Concessionaire shall identify the proposed sources of materials and submit the proposal prior to delivery. If it is found that proposed sources of supply do not produce uniform and satisfactory products at any time during execution, the Concessionaire shall procure acceptable materials conforming to the specifications from other sources.
- iii) In case of manufactured items, the Concessionaire shall submit details pertaining to the product/process/system covering interalia:
  - a) Name of manufacturer and name of product/process/system;
  - b) General features of the product/process/system along with specifications and standards adopted for the product/process/system;
  - c) Authenticated copies of license/agreement;
  - d) Details of projects where the product/process/system has been successfully used;
  - e) Limitations, if any;
  - f) Acceptance tests and criteria;
  - g) Installation and maintenance procedure and schedule; and
  - h) Performance warranty.

**8.2 Structural Concrete**

The Concrete for use in structures shall conform to the provisions in Clauses 302.6 to 302.9 of IRC:21 and Section 1700 of MORTH Specifications. Wherever High

Performance Concrete (HPC) is proposed to be used, the same shall conform to the provisions of IRC:SP:70. Sampling and testing of concrete shall be as per Clause 302.10 of IRC:21. Acceptance criteria for concrete shall conform to Clause 302.11 of IRC:21.

### 8.3 Cement

Any type of cement specified in IRC:21 may be used for the works subject to limitations, if any, specified therein.

### 8.4 Coarse Aggregates

Before commencement of the works, at least three samples, in accordance with the procedure laid down in IS:2430, shall be taken for each quarry source to ascertain the quality, suitability and fitness of the available material for use in the works. Fresh tests shall be conducted in case there is any change in the source or the type of rock being quarried. The proposal, along with a copy of test reports, shall be submitted.

### 8.5 Sand/Fine Aggregates

- i) All fine aggregates shall conform to IS:383 and tests for conformity shall be carried out as per IS:2386 (Part I to VIII). The fineness modulus of fine aggregates shall be between 2.0 and 3.5.
- ii) Before the commencement of the works, at least three samples as per IS:2430 shall be taken for each quarry source to ascertain the quality, suitability and fitness of the available material for use in the works and the proposal along with a copy of test reports shall be submitted to the IE for review and comments, if any.
- iii) Fine aggregates having positive alkali-silica reaction shall not be used.

### 8.6 Water

- i) Water for use in the works for mixing and curing of concrete shall be in conformity with Clause 302.4 of IRC:21.
- ii) Water from each source shall be tested before the start of works and thereafter every three months and after each monsoon till the completion of the works and the proposal along with a copy of test reports shall be submitted to the IE for review and comments, if any.

### 8.7 Chemical Admixtures

8.7.1 The following guidelines shall apply in selection and use of admixtures:

- i) Chemical admixtures shall comply with IS:9103 and meet the requirements stipulated in clause 5.5 of IS:456.

- ii) Admixtures generating hydrogen or nitrogen or containing nitrates, sulphides, sulphates, or any other material liable to affect the reinforcement/ embedments or concrete shall not be used.
- iii) Compatibility of admixture with the cement being used shall be tested before actual use in the works. The test shall be repeated in case of change of type or grade or source of cement.
- iv) Admixtures shall not impair the durability of concrete. They shall not combine with the ingredients to form harmful compounds or endanger the protection of reinforcement against corrosion.
- v) The packaging of admixtures shall clearly indicate the name of the manufacturer/supplier, brand name (name of the product), date of production and expiry, batch/identification number.

8.7.2 In addition to the details as stipulated in Clause 1012.1 of MORTH Specifications, following information shall also be furnished:

- i) pH value and colour.
- ii) Latest date of test and name of the laboratory.
- iii) Shelf life, maximum and minimum temperature for storage, precautions to be taken while mixing and any other instructions for use.

### 8.8 Steel

#### 8.8.1 Steel for prestressing

In addition to the requirement mentioned in Clause 1009.2 of MORTH Specifications, the steel for prestressing shall satisfy following conditions:

- i) Uncoated stress relieved low relaxation steel conforming to IS:14268.
- ii) Prestressing steel shall be subjected to acceptance tests in respect of modulus of elasticity, relaxation loss at 1000 hrs., minimum ultimate tensile strength, stress-strain curve etc. prior to actual use on works as per guidelines contained in BS:4447. The modulus of elasticity value, as per acceptance tests, shall conform to the design value, which shall be within a range not more than 5 percent between the maximum and the minimum.

#### 8.8.2 Reinforcement/Untensioned Steel

- i) Only Fe 500 grade of steel shall be used on works and all reinforcing steel for use in works shall be procured from main/major producers. Fe 415 grade of steel can also be used where permissible as per IRC Codes and Guidelines.

- ii) Only fresh steel shall be brought to the site. Every bar shall be inspected before assembling on the work; and defective, brittle or burnt bars shall be discarded. Cracked ends of bars shall be cut before use.
- iii) Only Thermo Mechanically Treated (TMT) bars conforming to IS:1786 shall be used as reinforcing steel.
- iv) All reinforcement shall be free from loose rust and coats of paints, oil, mud or any other substance, which may destroy or reduce bond. The reinforcement bars bent and fixed in position shall be free from loose rust or scales, coats of paints, oil, mud or chloride contamination and other corrosion products. Where cleaning of corroded portions is required, proposal for effective method of cleaning such as sand blasting shall be submitted to the IE for prior review and comments.
- v) Proprietary steel products will be permissible provided they conform to the minimum requirements.

### 8.8.3 Steel for bearings

Mild steel, high tensile steel, cast steel, steel forgings, and stainless steel shall conform to the provisions contained in Clause 925.1 of IRC:83 (Part III).

### 8.8.4 Structural Steel

All structural steel, castings and forgings, fasteners (bolts, nuts, washers and rivets), welding consumables and wire ropes and cables shall conform to the provisions of Clause 505.1.2, 505.2, 505.3, 505.4 and 505.6 respectively of IRC:24.

### 8.9 Bitumen

Bitumen shall be paving bitumen of viscosity grade complying with Indian Standard Specifications for "Paving bitumen" IS:73:2006 of grade appropriate for the traffic and climatic conditions of the Project Highway. The heavily trafficked roads in hot areas may find harder grade bitumen more appropriate while pavements in mountainous regions subject to sub-zero temperatures during winter months carrying relatively lower traffic loads and subject to the phenomenon of "Frost Heave" may find less viscous bitumen resistant to fatigue and cold cracking more appropriate.

### 8.10 Storage of Materials

All materials shall be stored at proper places so as to prevent their deterioration or intrusion of foreign matter and to ensure the preservation of their quality and fitness for the work. Any material, which has deteriorated or has been damaged or is otherwise

considered defective after review by the Independent Engineer shall not be used in the works and shall be removed from site by the Concessionaire at his cost. Such materials shall not be made acceptable by any modifications.

### 8.11 Report to be submitted

The Concessionaire shall prepare and submit report containing test results of all materials and finished products proposed to be used in the Project Highway.

**SECTION - 9**

**TRAFFIC CONTROL DEVICES/ROAD SAFETY  
DEVICES/ROAD SIDE FURNITURE**

**SECTION - 9****TRAFFIC CONTROL DEVICES/ROAD SAFETY DEVICES/  
ROAD SIDE FURNITURE****9.1 General**

Traffic Control Devices/ Road Safety Devices/Road Side Furniture shall comprise of road signs, road markings, object markers, hazard markers, studs, delineators, attenuators, safety barriers, pedestrian guard rails, boundary stones, kilometre stones, etc. Guidelines given in IRC:8, IRC:25, IRC:26, IRC:35, IRC:67, IRC:79, IRC:103 and Section 800 of MORTH Specifications shall be used for providing these items unless otherwise specified in this Section.

**9.2 Road Signs**

The three types of road signs viz., mandatory/regulatory signs, cautionary/warning signs and informatory signs shall be provided as given in IRC:67 and Section 802 of MORTH Specifications. Proper signs shall be provided for left in and left out at service roads for safe guidance of traffic. Clustering and proliferation of road signs shall be avoided for enhancing their effectiveness.

**9.2.1** The material and specifications for Road Signs shall be governed by the Specifications for Road and Bridge Works issued by the MORTH.

**9.2.2** There shall be corresponding road markings with stop signs, give way signs, merging or diverging traffic signs, lane closed signs, road narrowing signs, slip roads/diversion signs, compulsory keep left/right signs, or any other signs as per IRC:67.

**9.2.3** Wherever the Project Highway alignment is on a curve, there shall be advance cautionary signs for sharp curves (depending on whether it is on left or right) and chevron signs (rectangular in shape with traffic yellow background and black arrow) at the outer edge of the curve. The sign for the curve ahead particularly in mountainous and steep terrain shall always be accompanied with chevron signs at the outer edge of the curve and appropriate delineation.

**9.2.4** The Specifications and Standards of roads signs such as chevron, overhead, etc., which are not covered by IRC:67 would be as per International Standards.

**9.2.5** All road signs shall be with retro-reflective sheeting of high intensity grade with encapsulated lens fixed over aluminium sub-strata as per Clause 801 of MORTH Specifications.

**9.2.6** Kerb mounted signs shall be supported on GI pipes. Overhead signs shall be placed on a structurally sound gantry or cantilever structure made of GI pipes. Its height,

lateral clearance and installation shall be as per MORTH Specifications. The pedestal supporting the gantry or cantilever structure of the overhead signs shall be flushed at the ground level and in no case shall protrude more than 150 mm above ground level.

**9.2.7** Locations and size of overhead traffic signs shall be specified in Schedule 'B' of the Concession Agreement. The following conditions may be considered while deciding about the locations of overhead signs:

- i) Traffic volume at or near capacity,
- ii) Restricted sight distance,
- iii) Built-up stretches,
- iv) Insufficient space for ground mounted signs,
- v) Distances of important places and route highways at suitable intervals,
- vi) Before major intersections.

**9.2.8** No sign, signal or any other device erected for traffic control, traffic guidance and/or traffic information shall obscure any other traffic sign. Further, the signs and signals shall not carry any advertisement.

**9.2.9** Each exit ramp shall have signs mounted on posts indicating the name of the place and the important roads it would lead to.

**9.3 Road Markings**

All road markings shall conform to IRC:35. Road markings shall comprise of carriageway markings, markings on intersections, hazardous locations, parking areas, etc. Where service roads are provided, proper layout and road markings shall be ensured so that merging with traffic is safe. The markings shall be done by means of a self propelled machine which has a satisfactory cut-off value capable of applying broken line automatically.

**9.3.1 Material**

- i) Hot applied thermoplastic paint with glass beads shall be used as road marking material.
- ii) Road markings may also be in the form of prefabricated sheet material, e.g. plastic sheets, which may be set into the pavement with upper surface flush with the pavement surface.

**9.4 Road Delineators**

These are roadway indicators, hazard markers and object markers as given in IRC:79.

**9.4.1 Roadway indicators**

Circular Iron Posts of 1.0 m height covered with reflectorised synthetic material/film, as per criteria, placement and spacing given in IRC:79 shall be provided.

**9.4.2 Hazard Markers** shall be provided as given in IRC:79. In addition, the objects close to the road shall be painted with black and yellow stripes using the paint conforming to IS:164.

**9.4.3 Object Markers** shall be provided as given in IRC:79. In addition, the kerbs in the medians/traffic islands shall be painted with black and white stripes (black and yellow stripes at highly hazardous locations) using the paint conforming to IS:164.

**9.4.4 Lighted Bollards** shall be provided in the median/traffic islands of all major/minor junctions as per International Standards.

**9.5 Raised Pavement Markers (Cat's Eyes/Road Studs)**

The cat's eyes or road studs shall be provided to improve the visibility in night-time and wet-weather conditions. These shall be prismatic retroreflective type two way markers conforming to ASTM D 4280 and provided as per Table 9.1.

**9.6 Attenuators**

Attenuators shall be provided at hazard markers locations given in IRC:79, structural columns of large direction signs, illumination lamp posts and at approaching traffic islands of toll plaza. It shall take repeated impacts without any additional recovery procedures and with minimal or no repairs. The attenuators modules shall be moulded from HDPE plastic. The design, size, number of modules, etc. of attenuators shall be as per International Standards and location specific duly considering the likely impact.

**9.7 Road Side and Median Safety Barriers**

There are two types of safety barriers viz., roadside safety barriers, and median safety barriers.

**Table 9.1 Warrants for Road Studs**

S. No.	Description of sections	Length of section to be provided with studs	Spacing of studs	Location of studs
1	All sections of Project Highway having radius of horizontal curve below 700 m	Length of horizontal curve including its transitions	5 m	Centre of the carriageway
2	All sections of Project Highway where vertical grade is steeper than 5 percent	Till the grade comes to 5 percent	5 m	Centre of the carriageway

S. No.	Description of sections	Length of section to be provided with studs	Spacing of studs	Location of studs
3	All major/minor junctions and median openings	(i) 100 m on either side of the junction/median opening (approaching side)	5 m	Centre of the carriageway
		(ii) Three Rows of studs at a spacing of 0.15 m	0.15 m	across the main carriageway and the cross roads (approaching side 50 m before the junction/median opening)
4	All built-up areas	Length of built-up area	5 m	Centre of the carriageway
5	Uncontrolled Pedestrian Crossings	One row of studs across crossings the main carriageway		

Note :

- Solar Studs shall be provided for locations at S. No. 3 (i) and 5 in Table 9.1.
- White colour road studs shall be used at locations where lane marking in white colour is prescribed in  
 IRC:35 - Amber colour shall be used at locations where lane marking in amber colour is prescribed in  
 IRC:35 - Red colour may be used to indicate no entry (like contraflow side).

**9.7.1 Road side safety barriers**

i) **Warrants:** The longitudinal roadside barriers are basically meant to shield two types of roadside hazards i.e. embankments and roadside obstacles and also for preventing the vehicles veering off the sharp curves. The warrants for a fill section in terms of the height and slope needing protection with roadside barriers are shown in Fig. 9.1. The barrier is not warranted for embankment having a fill slope of 3H:1V or flatter. The warrants for roadside objects are mainly dependent upon the type of obstacle and the probability of their being hit. A barrier shall be installed only if the result of vehicle striking the barrier is likely to be less severe than the severity of accident resulting from the vehicle impacting the unshielded obstacle. Some of the commonly encountered roadside obstacles are bridge piers, abutments and railing ends, roadside rock mass, culverts, pipes and headwalls cut slopes, retaining walls, lighting supports, traffic signs and signal supports, trees and utility poles.

ii) **Types of Roadside Safety Barriers**

There are three types of longitudinal roadside safety barriers viz:

- Flexible type (like wire rope fencing)

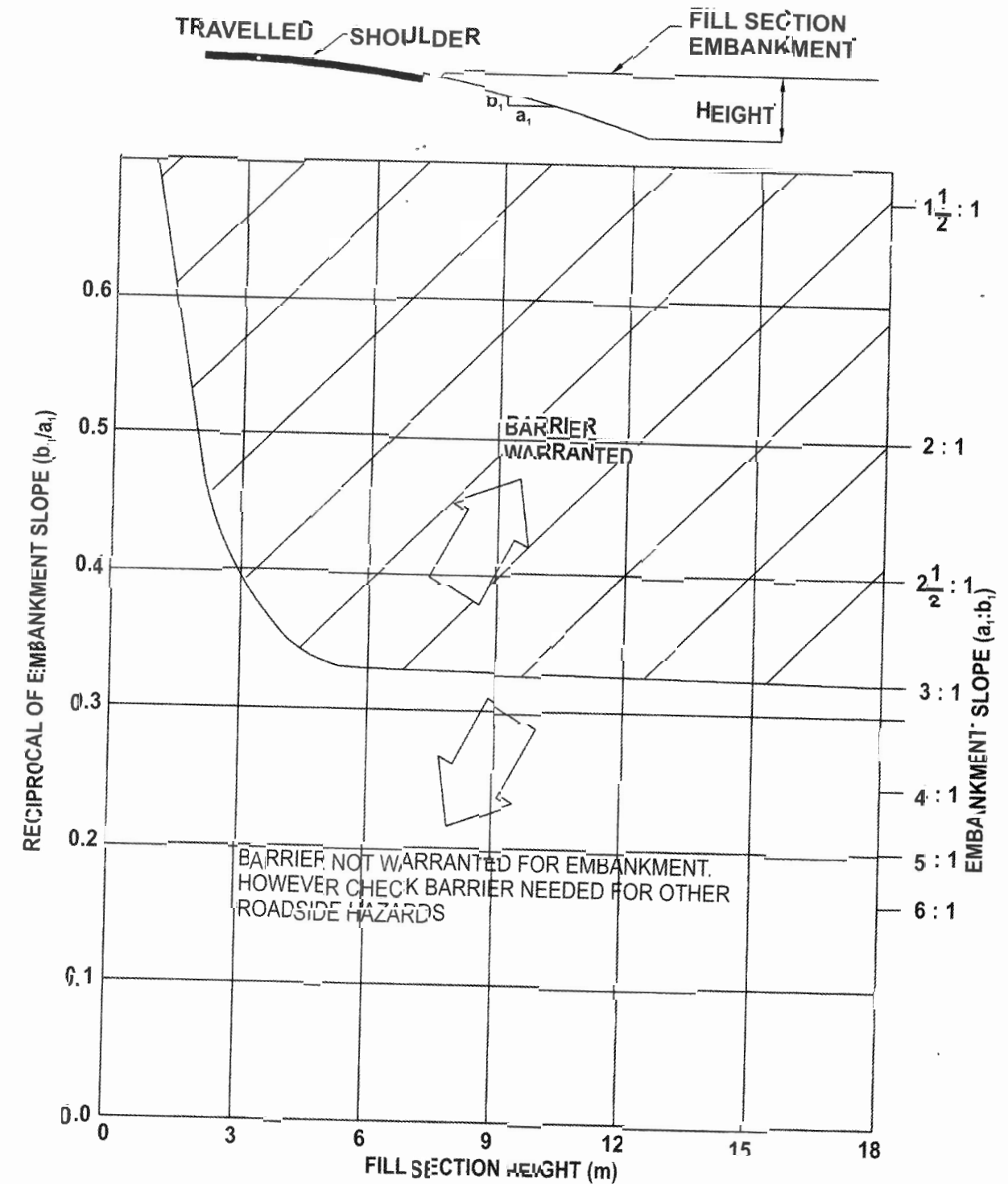

Fig. 9.1 Warrants for Roadside Barriers on Embankments

- b) Semi-rigid type like
- "W" beam type steel barrier
  - Thrie beam type steel barrier

These steel barriers are of strong post type and usually remain functional after moderate collisions thereby eliminating the need for immediate repair.

- c) Rigid type (like concrete crash barriers)

iii) **Road Side Steel Barriers**

- a) **Design Aspects** : The "W" beam type safety barrier consists of steel posts and a 3 mm thick "W" beam rail element which is spaced away from the posts. The spacer minimizes vehicular snagging and reduces the likelihood of a vehicle vaulting over the barrier. The steel posts and the blocking out spacer shall both be channel section of 75 mm x 150 mm size and 5 mm thick. The rail shall be 700 mm above ground level and posts shall be spaced 2 m center-to-center. Typical details are shown in Fig. 9.2.

The thrie beam safety barrier shall have posts and spacers similar to the ones mentioned above for "W" beam type. The rail shall be placed at 850 mm above the ground level. This barrier has higher initial cost than the "W" beam type but is less prone to damages to vehicle collisions especially for shallow angle impacts. Typical details of Thrie beam barrier are shown in Fig. 9.3.

The "W" beam, the Thrie beam and the posts spacers and fasteners for steel barriers shall be galvanized by hot dip process.

- b) **End treatment for steel barrier** : An untreated end of the roadside barrier can be hazardous, if hit, because the barrier beam can penetrate the passenger compartment and cause the impact vehicle to stop abruptly. End treatments should, therefore, form an integral part of safety barriers and the end treatment not spear vault or roll a vehicle for head on or angled impacts. The two end treatments recommended for steel barriers are "Turned down guardrail and Anchored in back slope".

Turned down guardrails have the "W" or Thrie sections reduced from full height to ground level with a gentle slope over a distance of 8 to 9 m. The turned down rail is intended to collapse on impact allowing the vehicle to pass over it without becoming airborne or unstable. In order to locate the barrier terminal away from the traveled way and to minimize drivers' reaction to a hazard near the road by gradually introducing a parallel barrier installation or to transition a roadside barrier nearer the roadway such as a bridge parapet or a railing, the turned down rail shall be flared away from the roadway. Suggested flare rates depending upon the design speed and type of barrier are given in Table 9.2.

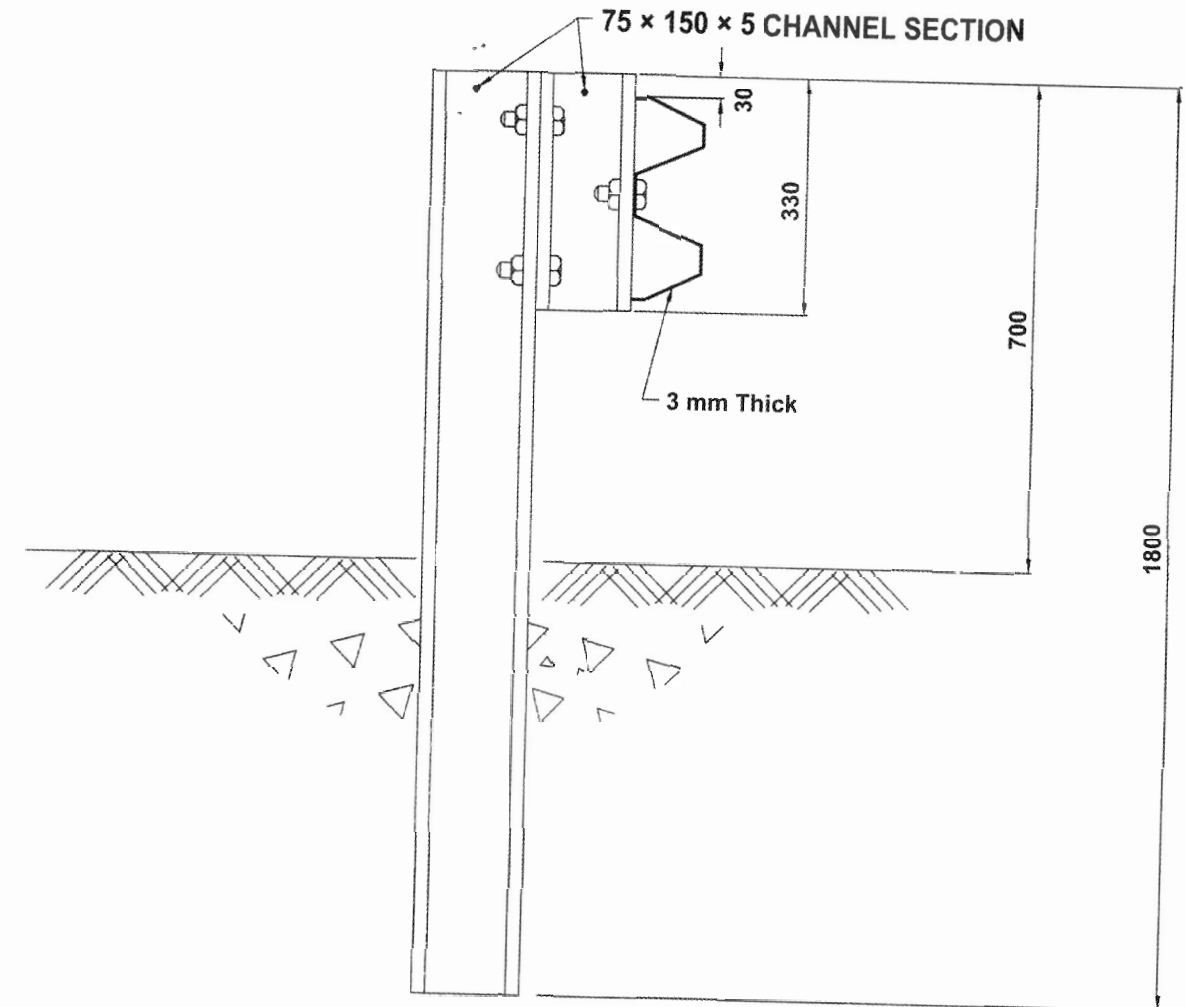

Fig. 9.2 Typical Details of "W" Beam Section

**Note** :- All dimensions are in mm

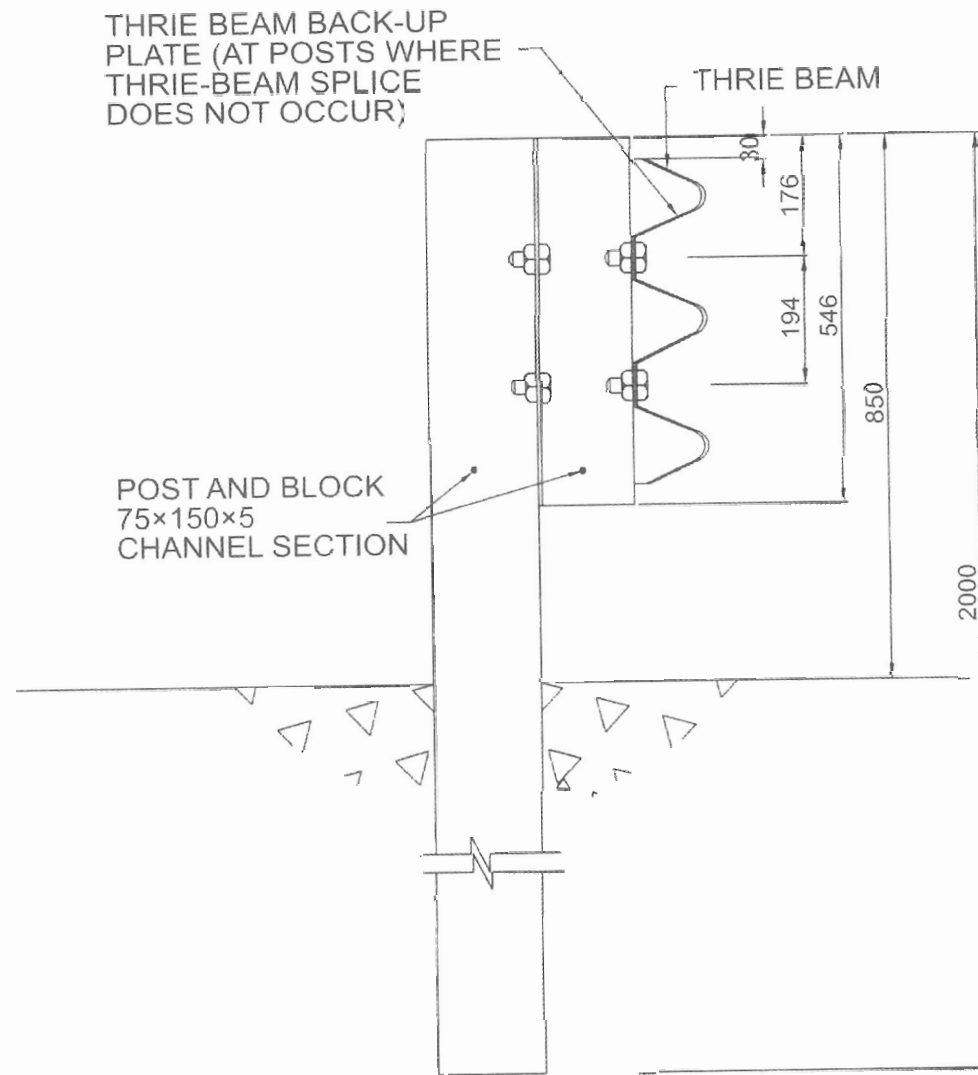

Fig. 9.3 Typical Details of Thrie Beam Section

**Note :-** All dimensions are in mm

**Table 9.2 Flare Rates**

Design speed in km per hour	Flare Rates	
	Rigid barriers	Semi-rigid barriers
100	17:1	13:1
80	14:1	11:1
60	11:1	9:1
40	8:1	7:1

The posts in the end treatment should have the same cross-sections as provided in the main barrier.

At road cross-sections in cutting or if the road transitions from cut to fill, the safety barriers can be anchored in back slopes. The back slope covering the anchored portion of the barrier should be graded flat with side slopes preferably not steeper than 10:1. The anchored portion should develop a tensile strength in the rail element to prevent the rail from pulling out of the anchorage. The barrier can also be anchored in an earth berm specially constructed for this purpose provided the new berm itself is not a hazard to the traffic. The earth berm should be made impervious to erosion.

- c) **Placement :** Placement recommendations determine the exact layout of the barrier and shall be made by the design engineer keeping in view the lateral offset of the barrier and flare rate. The final layout shall be a site-specific combination of these factors. The barriers shall be as far away from the traffic as possible and shall preferably have uniform clearance between the traffic and the hazard.

As far as possible the safety barrier shall be placed beyond 2.5 m of the traveled way. For long and continuous stretches, this offset is not critical. The distance between the barrier and the hazard shall not be less than the deflection of the barrier by an impact of a full sized vehicle. In case of embankments, a minimum distance of 600 mm shall be maintained between the barrier and the start of embankment slope of a hazard to prevent the wheels from dropping over the edge. Typical details are shown in Fig. 9.4.

Flatter flare rates may be used particularly where extensive grading would be required to ensure a flat approach from the traveled way subject to the availability of right of way.

iv) **Road Side Concrete Barriers**

- a) **Design Aspects :** Roadside Concrete safety barriers are rigid barriers having a sloped front face and a vertical back face. The

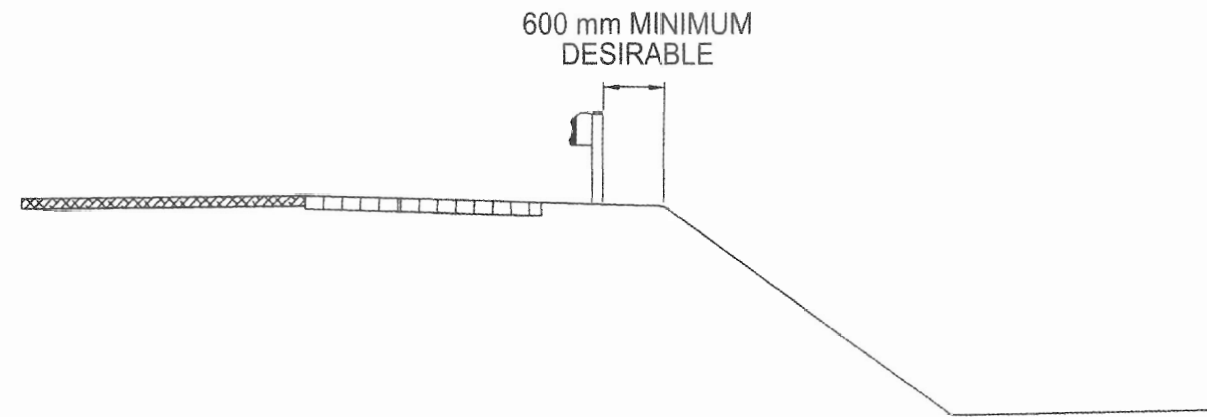

Fig. 9.4 Recommended Barrier Placement

recommended designs of the cast-in-situ and precast barriers are shown in Fig. 9.5 and 9.6 respectively. Based on evaluation of vehicle direction, sight distance, structural stability and the psychological effect of barrier height on driver reaction, the most desirable height of the median barrier is 800 mm. Variations upto 50 mm in height of barrier can be made in the total height of the barrier to meet the site requirements. It is, however, important to maintain the height of lower slope between 200 mm and 350 mm so as to reduce the chances of overturning of the vehicles.

The concrete barrier may be precast in lengths of upto 6 m depending upon the feasibility of transport and lifting arrangements. Concrete grade for the barriers shall not be leaner than M30. The minimum thickness of foundations shall be 25 mm thick cement concrete or hot mix asphalt placed at the base of barrier to provide lateral restraint. Where more than 75 mm thick overlay on the road pavement is anticipated, the foundation step may be increased to 125 mm. However, longitudinal roadside concrete barrier should have elaborate footing design which is structurally safe unless sufficient earth support is available.

- b) **End Treatment** : Safety barrier shall be provided with an end treatment, which shall be obtained by tapering the height of terminating end of the median barrier within a length of 8 m to 9 m.
- c) **Placement** : Placement recommendations for roadside steel barriers, mentioned in para 9.7.1 (iii) (c) above are applicable to concrete barriers as well.

**9.7.2 Median barriers**

- i) **General** : Head-on-collisions, especially on highways with narrow medians, caused by out-of-control vehicles jumping across the medians

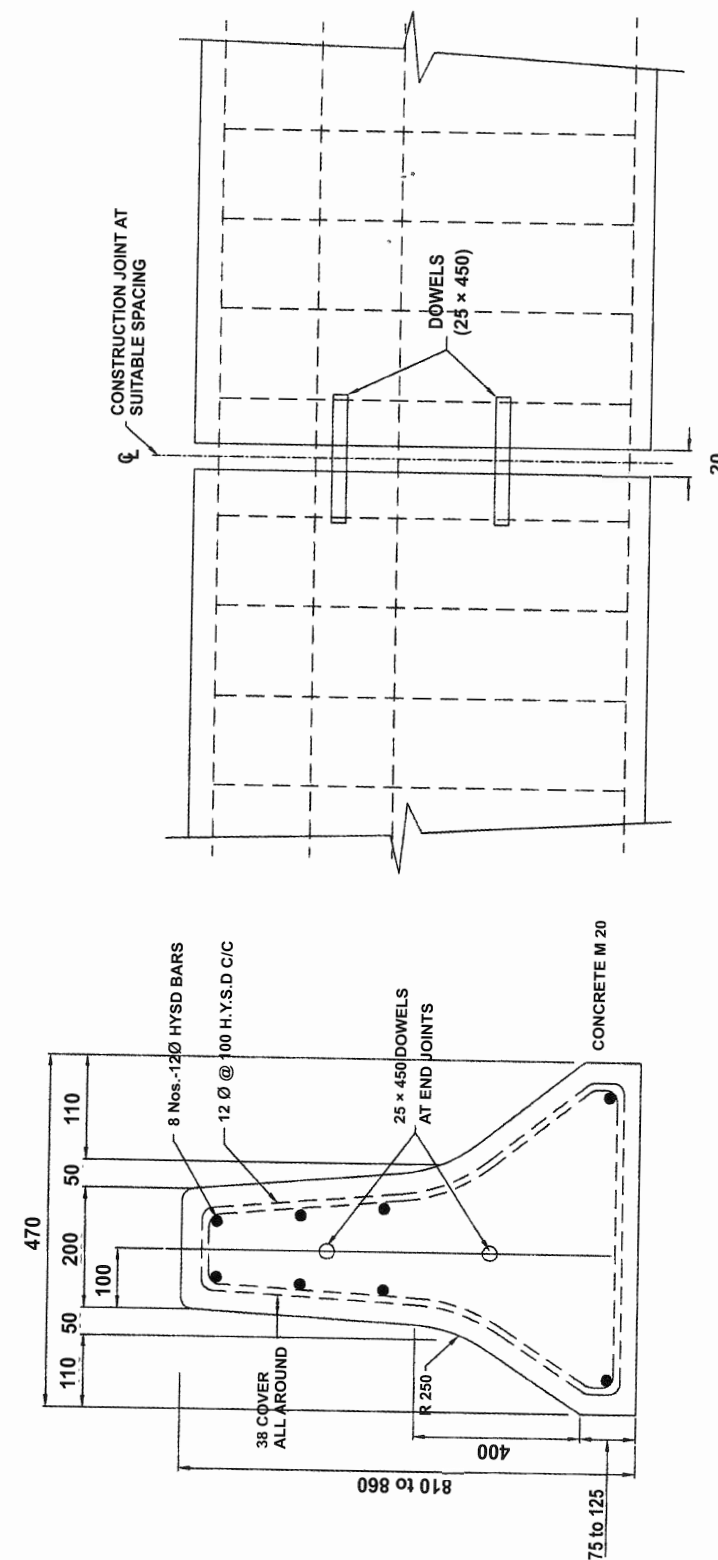

Fig. 9.5 Road Side Barrier Cast-in-Situ Design

NOTE:-  
 1. HYSD - High yield strength deformed reinforcement  
 2. All dimensions are in mm

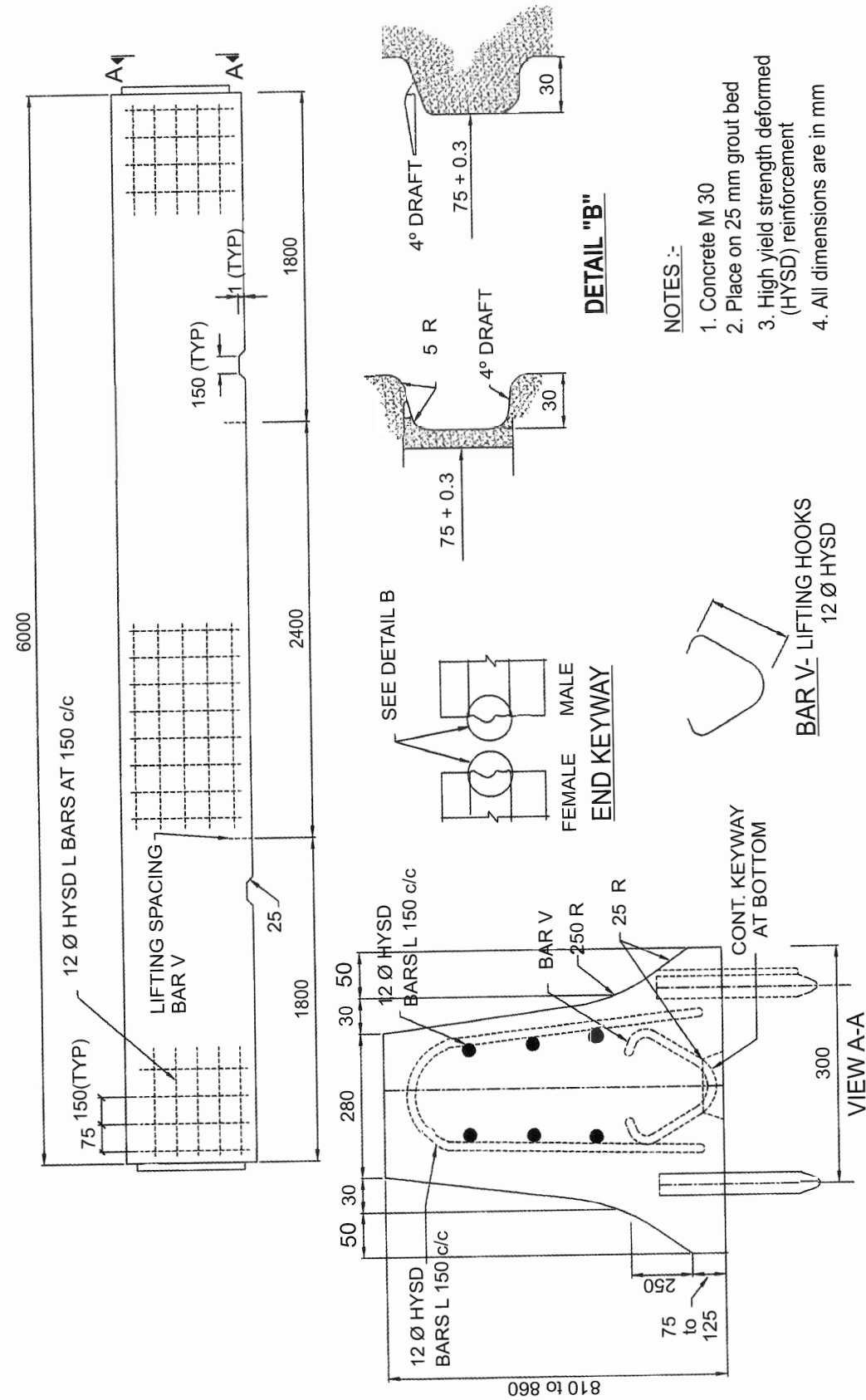

Fig. 9.6 Road Side Barrier Precast Design

are a major source of accidents. Fixed objects on medians also require shielding from the traffic flow. Provision of median safety barrier in such conditions is an important requirement.

- ii) **Warrants :** The requirement of a median barrier is a function of the width of the median and the traffic volume on the road. Fig. 9.7 indicates the warrants for provision of median barriers in terms of the combination of median width and Average Daily Traffic (ADT) in PCUs. At ADT less than 20,000 PCUs and with medians wider than 9 m, the probability of a vehicle crossing across the median is relatively low and median barriers in such cases are optional. Medians with width between 9 m and 15 m do not warrant a barrier unless there is an adverse history of median crossovers.

Median barriers may be impractical where a road has a large number of closely spaced median openings since the barrier needs to be terminated with an end treatment at these points.

An evaluation of the number of median openings, accident history, alignment, sight distance, design speed, traffic volume and median width shall be made prior to taking a decision to install a median barrier.

Median barriers shall also be provided to shield fixed objects in a narrow median. If necessary, median barriers shall be flared to encompass a fixed object, which may be a lamp post, foundation of overhead signs, bridge pier etc.

- iii) **Types of Median Barriers :** There are three types of median safety barrier viz., "W" beam type steel barrier, (Strong post type), Thrie beam type steel barrier, (Strong post type) and Concrete barriers

a) **Steel Median Barriers**

**Design Aspects :** The "W" beam barrier shall be similar to the roadside barrier described in Para 9.7.1 (iii) (a) above except that the "W" beam shall be provided on both sides of the post with similar spacers. Typical details are indicated in Fig. 9.8.

The Thrie beam barrier shall be similar to the roadside barrier described in Para 9.7.1 (iii) above except that the Thrie beam shall be provided on both sides of the post with similar spacers. Typical details are shown in Fig. 9.9.

**End Treatment :** Steel median barriers shall be provided with a "Turned-down-guardrail" end treatment as described in Para 9.7.1 (iii) (b) above except that no flaring is to be provided.

**Placement :** At locations, where the two adjacent carriageways are at the same level, the barrier shall be placed in the center of the median, duly taking into consideration, the drainage requirements. The placement of median barriers in cases where the two

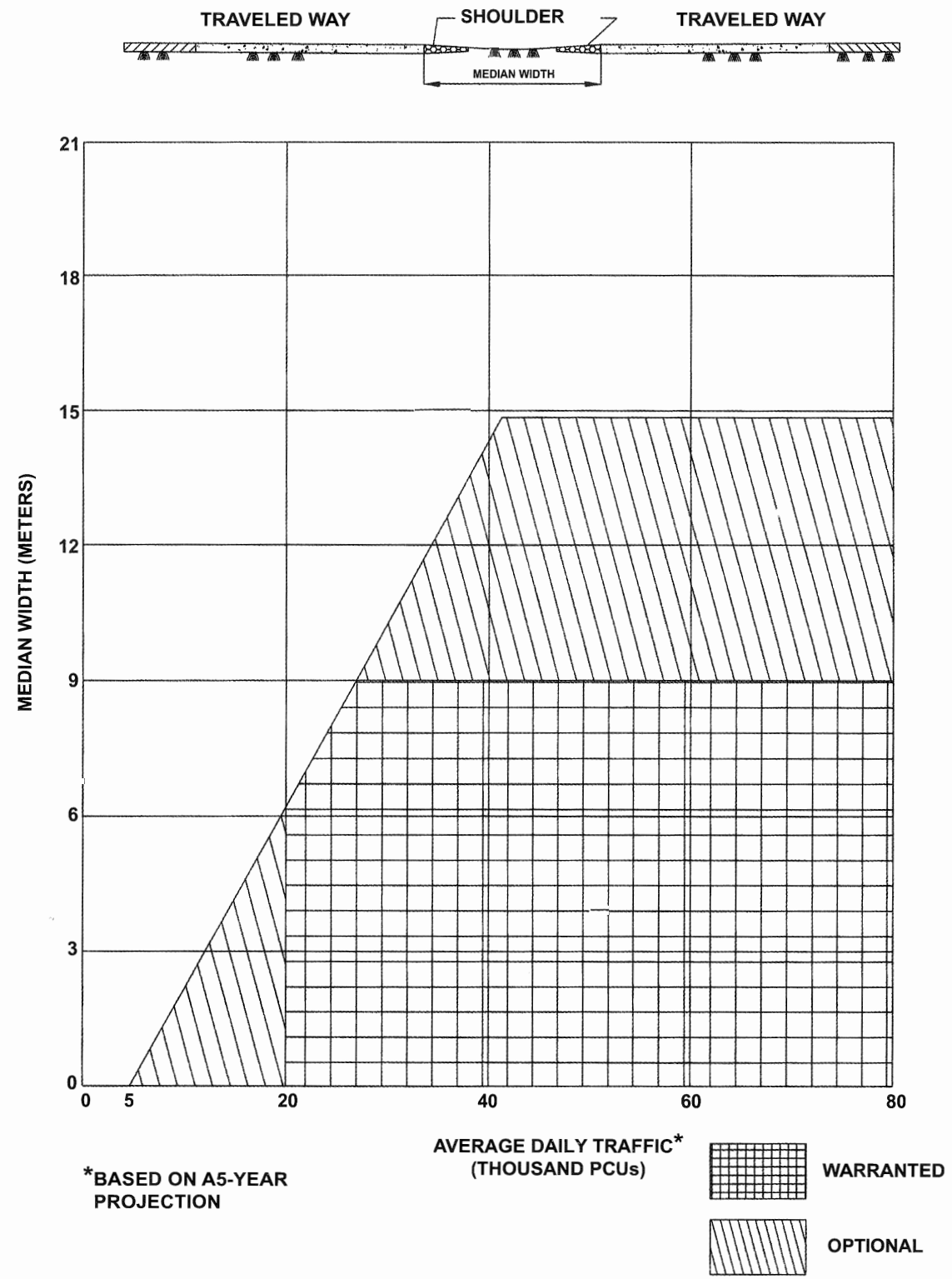

Fig. 9.7 Median Barrier Warrants

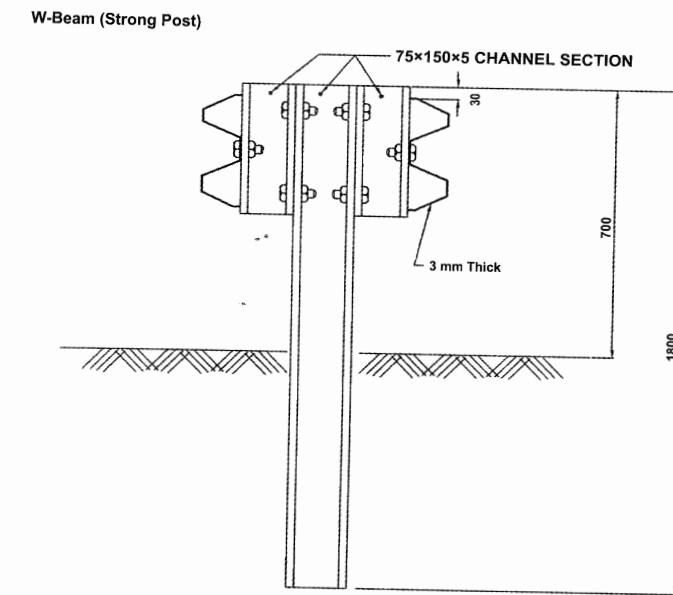

Fig. 9.8 Typical Details of "W" Beam Median Barrier

Note :- All dimensions are in mm

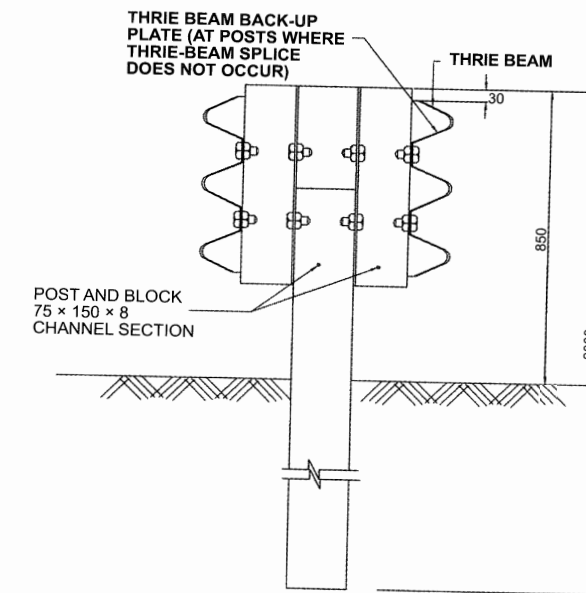

Fig. 9.9 Typical Details of Thrie Beam Median Barrier

Note :- All dimensions are in mm

carriageways are at different levels is a function of the slopes between the two medians. Recommended placement for various combinations is indicated in Fig. 9.10. In case the median barriers need to be flared e.g. for the protection of supports to overhead signs, the flare rates given in Table 9.2 shall be followed.

b) **Concrete Median Barriers**

**Design Aspects :** The design of cast-in-situ and precast median barriers is indicated in Fig. 9.11 and 9.12.

Median barrier shall be terminated sufficiently away from the median opening with the twin objectives of preventing impact by the turning traffic and providing adequate sight distance to the turning traffic. The terminating end of the median barrier shall be tapered in a length of 8 to 9 m.

**Placement :** Placement recommendations for steel median barriers mentioned in Para 9.7.2 (iii) (a) above apply to concrete median barriers also.

iv) **General**

Raised kerbs or drains shall not be provided between the traveled way and the barriers. These destabilize the vehicle balance and disturb its equilibrium before it strikes the barrier, thus defeating the essential purpose of safety and redirection of the impacting vehicle. Steel barriers shall be provided in rural sections whereas concrete barriers shall be provided in built-up sections. In addition to the warrants given in Para 9.7.1 (i) and 9.7.2 (ii) above, the safety barriers shall also be provided at the following locations :

- a) Where embankment is retained by a retaining structure.
- b) On valley side of highway in mountainous and steep terrain.
- c) Between main carriageway and footpath in bridges.
- d) At hazardous locations identified in Schedule 'B' or through safety audit.

The requirements of Safety Barriers for structures are given in Para 7.17 of this Manual.

**9.8 Road Boundary Stones (RBS)**

Road boundary stones shall be provided at the boundary on both sides of the Right of

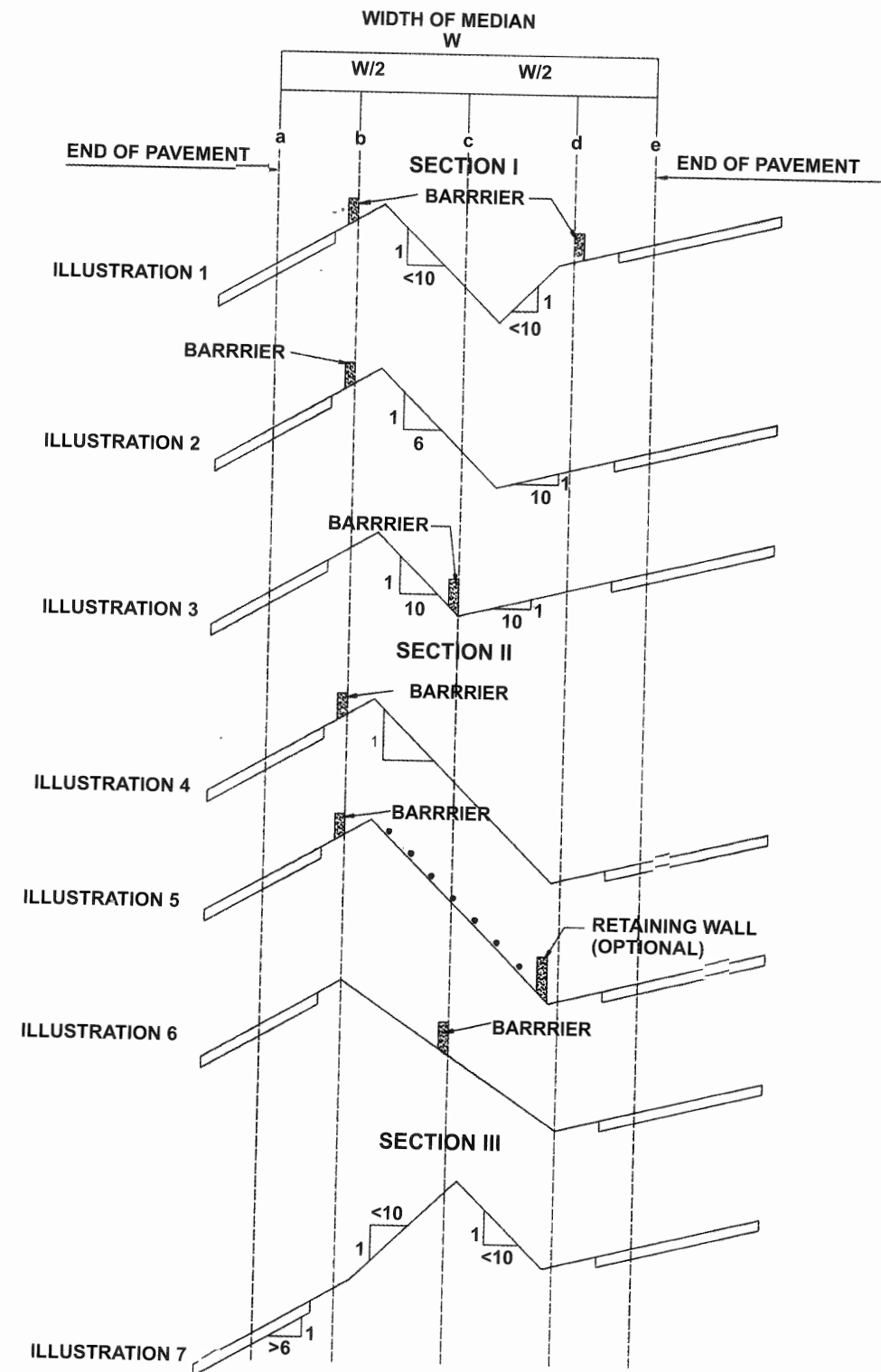

Fig. 9.10 Recommended Median Barrier Placement in Non-level Median

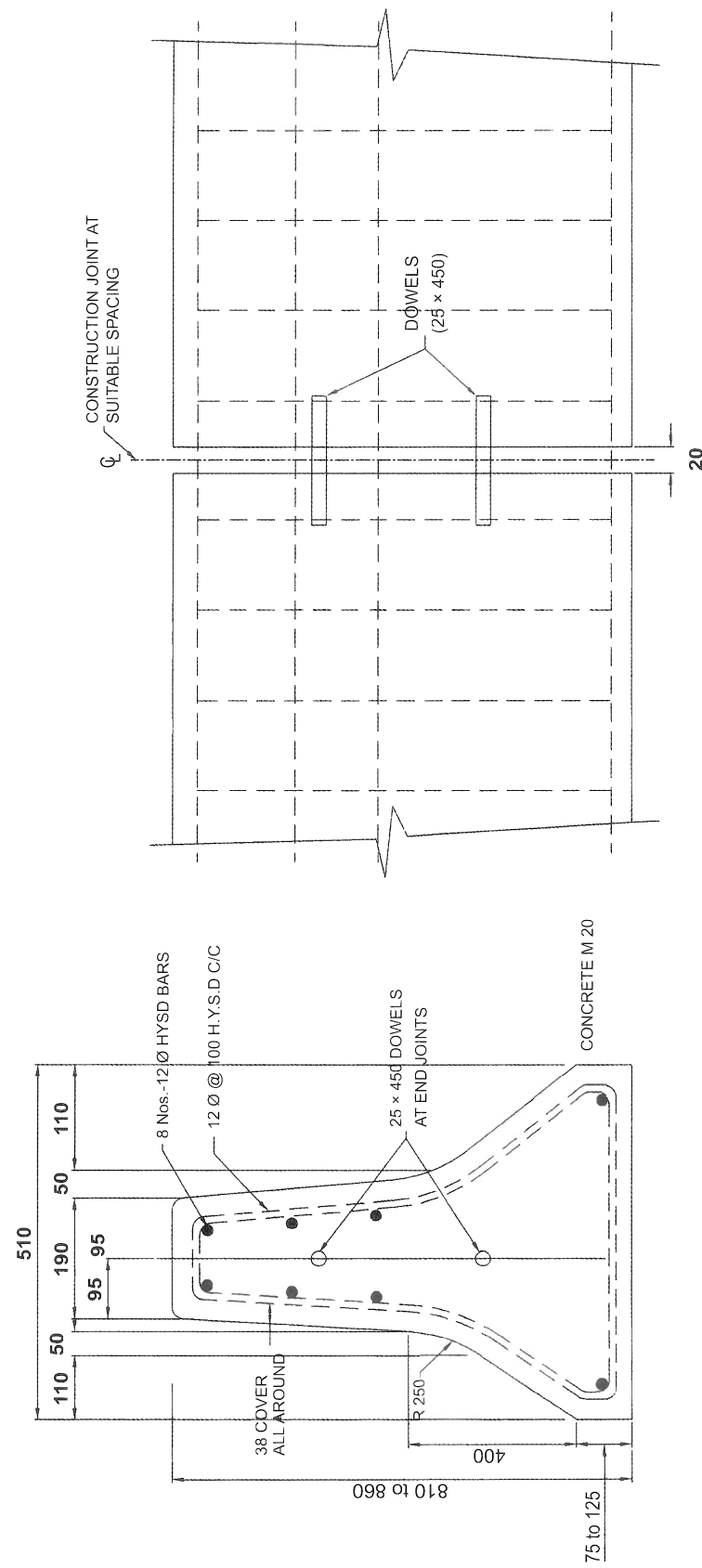

Fig. 9.11 Median Barrier Cast-in-Situ Design

NOTE:-

1. HYSD - High yield strength deformed reinforcement
2. All dimensions are in mm

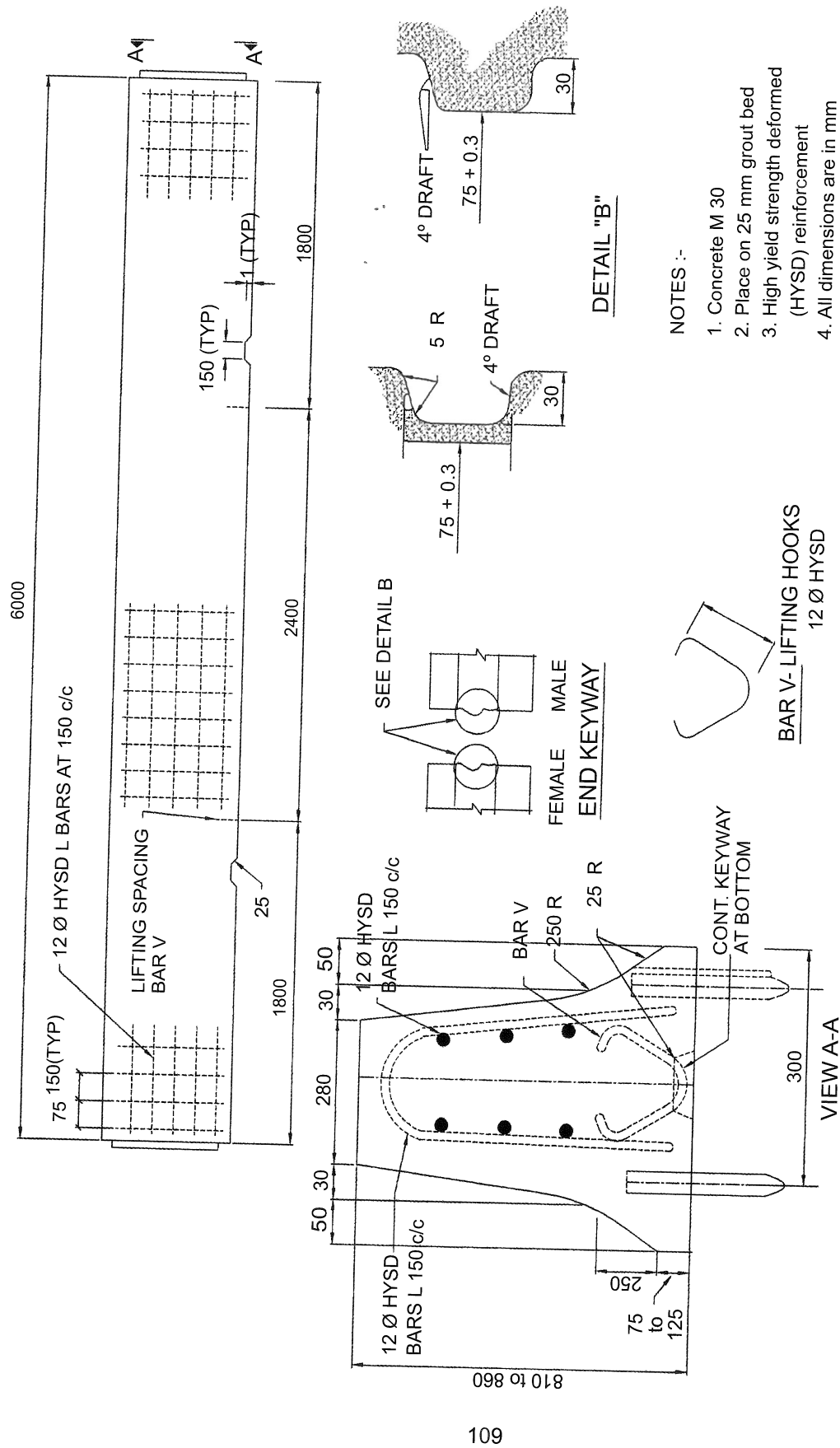

Fig. 9.12 Median Barrier Precast Design

NOTES :-

1. Concrete M 30
2. Place on 25 mm grout bed
3. High yield strength deformed (HYSD) reinforcement
4. All dimensions are in mm

Way. These shall be spaced at 200 m. The boundary stones shall be of cement concrete as per Type Design given in IRC:25. The boundary stones shall be painted with cement primer and enamel paint and marked 'RBS' by paint.

### **9.9 Kilometre and Hectometre Stones**

- i) The kilometre stones shall be provided at each kilometre on both sides of the Project Highway. The design and specification of kilometre stones shall conform to IRC:8. The matter to be written on various kilometre stones and the pattern thereof shall be as specified in IRC:8.
- ii) Hectometre (200 m) Stones shall be provided at every 200 m distance on both sides of the Project Highway. The design and specification of 200 m stones shall conform to IRC:26. The matter to be written on the 200 m stones shall be as specified in IRC:26.

### **9.10 Pedestrian Railings/Guard Rails**

Pedestrian Guardrails of iron/steel sections shall be provided as per IRC:103. The iron/steel guard rails shall be finished with epoxy primer and two coats of synthetic enamel paint after sand blasting (appropriate corrosion protection layer shall be provided in corrosive environment). In case iron/steel sections are not suitable in corrosive environment even after providing corrosion protection layer, concrete guard rails as per IRC:103 shall be provided in those sections.

### **9.11 Solar Based Beacons or Flashing Signals**

These shall be provided at uncontrolled pedestrian crossings; near the public gathering places like educational institutions, worship places, hospitals, etc. cross roads; and median opening locations.

### **9.12 Design Report:**

The Concessionaire shall submit the proposals for traffic control/road safety devices and road furniture together with drawings and details to the Independent Engineer for review and comments, if any. The proposals shall include type, location, material specifications, installation details and the requisite warranties for satisfactory field performance (as applicable).

## **SECTION - 10 TOLL PLAZAS**

## SECTION - 10

### TOLL PLAZAS

#### 10.1 General

The Concessionaire shall provide the Toll Plazas at the locations specified in Schedule 'C' for collection of toll/fee as per the Concession Agreement. The fee collection system shall be speedy, efficient and user friendly. The design of the Toll Plazas should be such that they are aesthetically pleasing and efficient and the fee collection staff should be quick, courteous and adequately trained before deployment.

#### 10.2 Location of Toll Plaza

The location of toll plaza shall be indicated in Schedule 'C' of the Concession Agreement. Their locations shall be decided keeping in view the following factors:

- i) Land availability
- ii) Stream of traffic on Toll Plaza
- iii) Visibility for the approaching traffic
- iv) Reasonably away from road intersections and/or rail crossings
- v) Free from risk of flooding and submergence, etc.
- vi) Preferably on flat land and away from congested urban locations.

#### 10.3 Land for Toll Plaza

Adequate land for Toll Plaza shall be acquired to permit the provision of toll lanes for a projected peak hour traffic of 20 years subject to a minimum number of 16 toll lanes including all other buildings and structures to be accommodated at the Toll Plaza location. Land shall be acquired as per provisions of the Concession Agreement.

#### 10.4 Lay out and Design of Toll Plaza

**10.4.1** Typical layout of 5+5 toll plaza is given in Fig. 10.1. The layout shall provide for future expansion of toll lanes. Stage construction of Toll Plaza in respect of number of toll lanes shall be allowed. However, other structures as envisaged in the Concession Agreement shall be provided at the initial stage itself.

#### 10.4.2 Width of toll lane

The width of each toll lane shall be 3.2 m, except for the lane for over dimensioned vehicles, where it shall be 4.5 m.

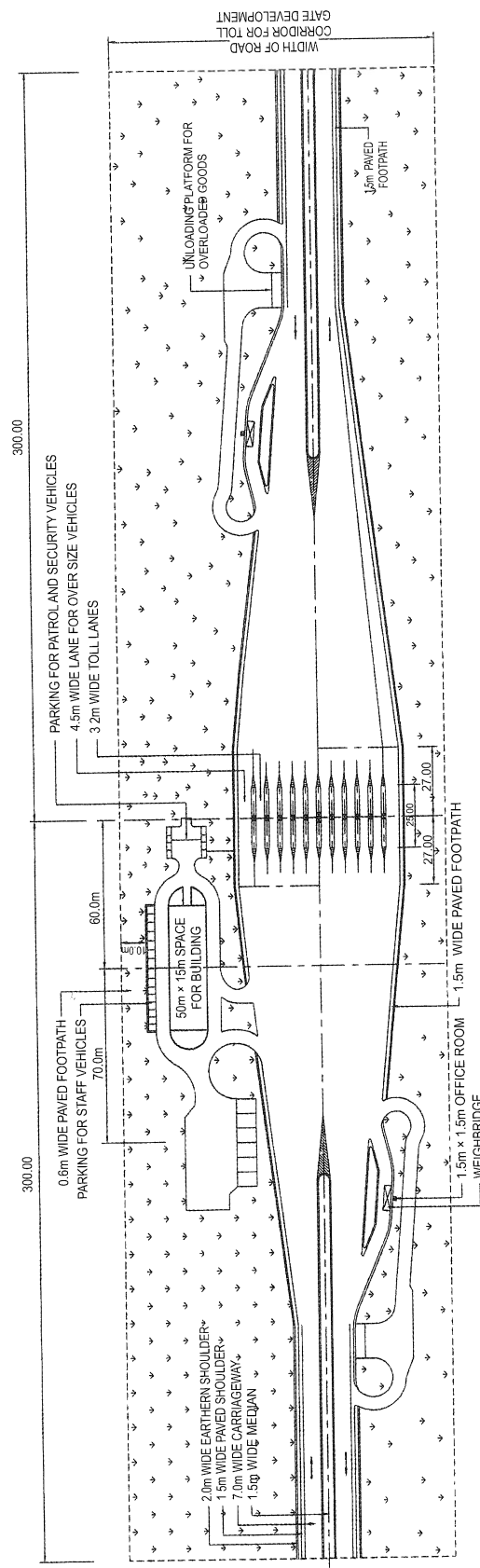

Fig. 10.1 Typical Layout for a Toll Plaza

**10.4.3 Traffic islands at the toll plaza**

Between each toll lane of the toll plaza, traffic islands are required to accommodate toll booth. These islands shall be of minimum 25 m length and 1.8 m width. Protective barriers of reinforced concrete and traffic impact attenuators shall be placed at the front of each island to prevent out of control approaching vehicles crashing into the toll booth. They would be painted with reflective chevron markings.

**10.4.4 Toll booths**

Toll booths may be provided of prefabricated materials or of masonry. The toll booths shall have adequate space for seating of toll collector, computer, printer, cash box, etc. It should have provision for light, fan and air conditioning. The typical details of traffic island with toll booth are given in Fig. 10.2.

Toll booth shall be placed at the centre of each traffic island. The toll booth shall have large glass window to provide the toll collector with good visibility of approaching vehicles. The bottom of the toll window should be placed at such a height (0.9 m) above ground level so as to provide convenience of operation. The toll booths shall be ergonomically designed and vandal proof. There shall be CCTV camera installed at each booth.

**10.4.5 Tunnels**

For the movement between toll office and toll booth of each toll lane, an underground tunnel across all toll lanes shall be provided. Its dimension would be sufficient to accommodate the required wiring/cable system and for convenient movement of personnel. It should also be provided with lighting and ventilation system so that the movement is convenient.

**10.4.6 Transition**

A transition of 1 in 20 to 1 in 10 may be provided from four-lane section to the widened width at Toll Plaza on either side.

**10.4.7 Canopy**

All the toll lanes and toll booths shall be covered with a canopy. The canopy shall be wide enough to provide weather protection to toll operators, drivers and facilities. The canopy shall be of aesthetically pleasing design with cylindrical support columns located at traffic island so that there is no restriction on visibility and traffic movement. The vertical clearance shall be as prescribed in this Manual.

**10.4.8 Drainage**

The toll plaza shall be provided with surface and sub surface drainage system so that all

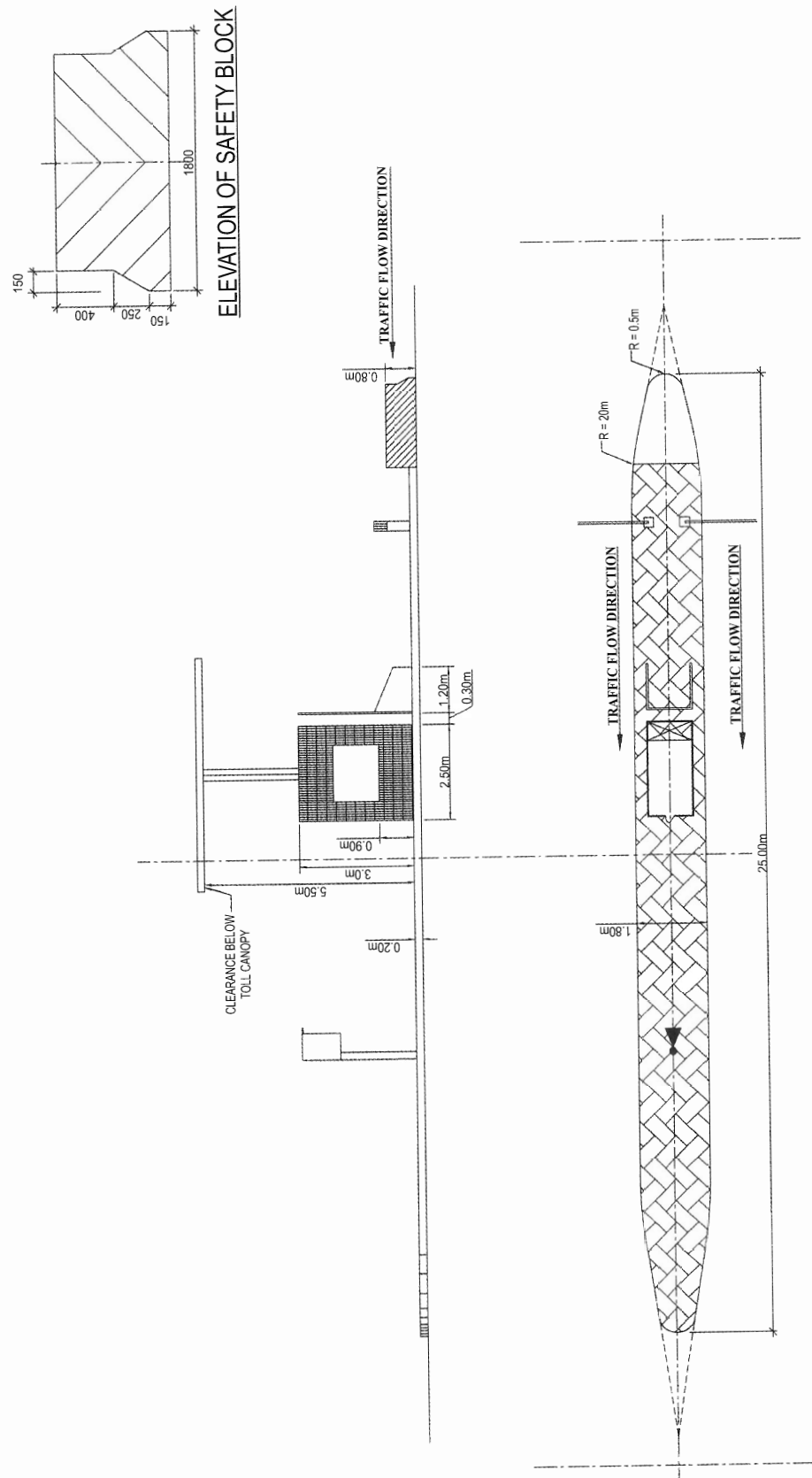

Fig. 10.2 Typical Layout for Traffic Island with Toll Booth

the storm water is drained off efficiently and no ponding or stagnation of water takes place at any area of the toll plaza.

**10.4.9 Equipment for toll lanes**

Each entry lane shall be equipped with a micro controller based Vehicle Counting-cum-Classifer Unit for counting the number of vehicles and their axle number and for identification of the category of vehicle. The semi-automatic toll collection system shall also have a ticket issuing machine for issue of the tickets for user fee at the press of a button on a touch panel and entry lane controller for controlling the equipment of the entry lane and for sending the data to the data processing equipment at Toll Plaza office. Each toll lane shall have electronically operated boom barrier along with synchronised system for traffic lights.

**10.4.10 Electronic toll collection**

The Electronic Toll Collection (ETC) system shall consist of an On Board Unit (with a Smart Card) fitted on a vehicle and a roadside antenna (Road Side Unit) to receive communication for identification of its code and other stored data and a system for transmitting data to and from the on board unit to the customer information management system through the road side unit.

**10.4.11 Prevention of overloading**

Toll plaza location shall also be provided with system for checking and preventing overloading of vehicles at Toll Plaza. For this purpose, weigh in motion systems at approaches to each toll lane are to be installed. Separate space for static weigh bridge and area to hold off-loaded goods from overloaded vehicles shall be provided after the toll barriers for each direction of travel.

**10.4.12 Number of lanes at toll plaza**

The total number of toll booths and lanes shall be such as to ensure the service time of not more than 10 seconds per vehicle at peak flow regardless of methodology adopted for fee collection. For purpose of guidance following parameters are suggested as capacity of individual toll lane for design purpose:

- |     |   |               |
|-----|---|---------------|
| i)  | Semi-automatic toll lane<br>(Automatic vehicle identification but manual fee transaction)                     | 240 veh/hour  |
| ii) | Electronic toll collection (ETC lanes)<br>(Toll collection through on board unit and no stoppage of vehicles) | 1200 veh/hour |

At least two toll lanes in each direction of travel shall be provided with the system of payment through ETC. Not less than 2 middle toll lanes shall be capable of being used as reversible lanes to meet the demand of tidal flow.

Toll plazas shall be designed for projected peak hour traffic of 20 years. As mentioned in Para 10.4.1, the stage construction of toll plaza in respect of number of toll lanes shall be allowed. If at any time, the queue of vehicles becomes so large that the waiting time of the user exceeds three minutes, the number of toll lanes shall be increased so that the maximum waiting time is brought down to less than three minutes.

#### 10.4.13 Toll collection system

For smooth and efficient functioning of toll collection, the following arrangements/facilities shall be provided:

- i) The staff posted at the counters in the semi-automatic system of toll collection shall be provided with sufficient electronic equipment for the collection of toll and recording data, and small denomination notes/coins at the start of each shift.
- ii) Intercom facility shall be provided between booths and the office of the supervisors.
- iii) If the booth is closed for any reason, incoming traffic shall be guided into the adjoining working booth with the help of appropriate signs.
- iv) The entire fee collection complex shall be adequately guarded.

#### 10.4.14 Pavement

Concrete pavement shall be provided in the Toll Plaza area including tapering zone, from durability and long time serviceability consideration and to permit the provision of toll lanes initially for a projected peak hour traffic of 10 years. The concrete pavement may be widened to provide for future toll lanes required as per stage construction. The rigid pavement shall be designed as per IRC:58. For this work, use of paver shall not be insisted.

#### 10.4.15 Traffic signs

A well thought out strategy should be evolved for providing traffic signs and road markings in and around the Toll Plaza in accordance with IRC:67 and IRC:35. The Concessionaire would design the configuration/placement of signs for toll plaza which are not given in IRC:67 and furnish to IE for review so as to ensure uniformity of signs in use on all the highways across the country.

Signs should be placed along the Project Highway, roadway of Toll Plaza to guide and render assistance to the drivers approaching the Toll Plaza. It is necessary to alert the

driver about the existence of Toll Plaza one km ahead with a repeater sign 500 m ahead. Stop sign shall always be used in combination with certain road markings such as stop line and the word 'STOP' marked on the pavement.

The Toll Plaza sign should be supplemented by the sign advising the users of the notified toll rates (fees) for various types of vehicles and exempted categories of vehicles.

Appropriate Signs and Signals shall also be provided on the canopy of toll plaza to properly guide the approaching vehicles about the lane in operation, lane applicable to specific category of vehicle, lane with Electronic Toll System, reversible lane, etc.

#### 10.4.16 Road markings

The road markings shall be used in accordance with Section 9 of this Manual. The road markings for the Toll Plaza area shall consist of lane markings, diagonals, chevron markings. Single centre line is provided at the centre of carriageway at toll gate to demarcate each service lane. Diagonal markings for central traffic island and chevron markings at side traffic island shall be provided to guide the approaching and separating traffic.

In order to control overspeeding of the vehicle approaching toll booth, transverse bar markings, as per typical details given in Fig. 10.3 shall be provided.

#### 10.4.17 Lighting

The toll plaza shall have lighting system to provide visibility to drivers for the use of facility especially to access the correct service lane and also to the toll collector. Indian Standard 'Code of Practice for Lighting of Public Thoroughfare' IS:1944 shall be followed. This would be done by interior and exterior lighting as indicated below. Power supply shall be from public power supply system, but stand by generating set of the capacity to supply the required power shall be provided at toll plaza.

**Interior Lighting :** The toll booths and facility building office shall be illuminated adequately. Indoor lighting shall be with fluorescent lamps. Lighting should be provided in such a manner that glare is avoided or minimised. The level of illumination shall be 200 to 300 Lux as per IS:3646 part II.

**Exterior Lighting :** Lighting of the Toll Plaza is important for enhancing the night visibility. The lighting system shall consist of the following major components.

- i) High Mast lighting
- ii) Lighting on both side approaches to the Toll Plaza
- iii) Canopy lighting of complex

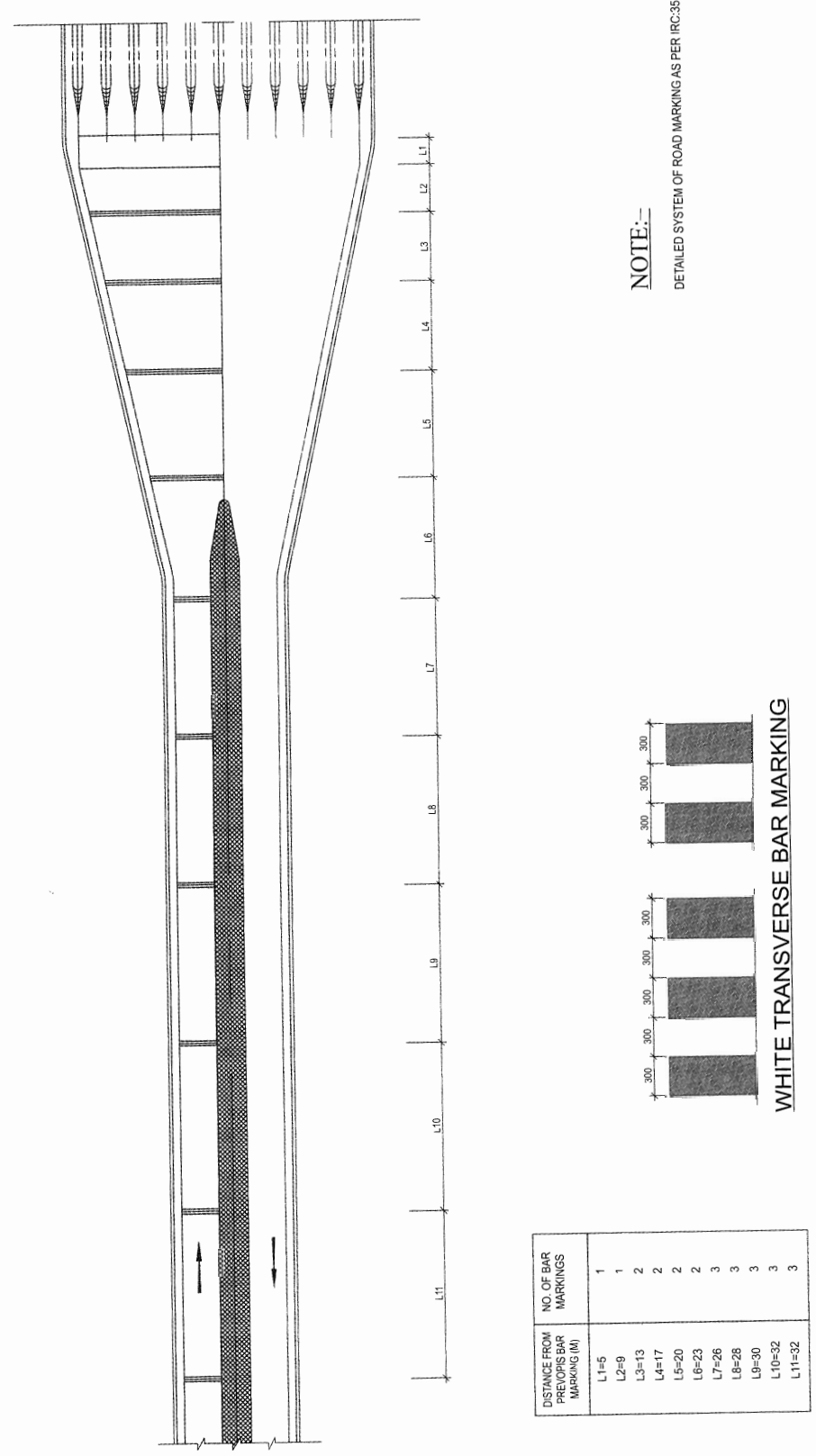

Fig. 10.3 Details of Suggestive Transverse Bar Marking for Speed Control at Toll Plaza

**High Mast Lighting :** Normal low light poles are not able to give the required lighting conditions. It is, therefore, necessary to install high mast. A height of 30 m for the mast is considered suitable to have uniform spread of desired level of illumination in the Toll Plaza area for safe movement of vehicles.

**Highway Lighting :** A minimum requirement of illumination on the road surface of 40 Lux shall be ensured. Lighting in minimum 500 m length on both side approaches of toll plaza shall be provided to enhance the safety at night on the Project Highway and to make the drivers conscious of their approaching the toll gate. These shall be provided on the mild steel welded tubular pole of 10 m height from road surface and with 2 m overhang. Sodium Vapour lamp of 200-250 watts should be provided for these poles on both sides at 50 m staggered spacing. There should be provision for flashing signals for foggy weather conditions.

**Canopy Lighting :** A higher level of illumination upto 100 Lux by providing 150 watt metal halide lamps shall be provided at the toll gate and at toll booth locations. 1000-watt halogen lamps shall be provided at the selected nodes of space frame of the canopy to ensure uniform illumination of the area.

**10.4.18 Water supply**

Adequate water supply shall be provided. For working out water requirement and internal drainage system, reference may be made to IS:1172, IS:5339 and IS:1742.

**10.4.19 Fire fighting system**

Toll Plaza shall have fire fighting equipment, including smoke detectors and auto visual alarm system as per Section 4.17.1 of National Building Code, so that the personnel working in the complex and the office and the road users are protected against fire hazards.

**10.4.20 Toll plaza complex**

Toll plaza shall have a separate office building so as to provide comfortable office space for manager, cashier and other staff. There shall be separate rooms for TV monitors, meetings, toilets, and for the sale of passes, smart cards, on board units and public interaction. The building shall have a strong room for keeping the cash and a garage to accommodate the security van (during operation of loading the collected revenue). There shall be parking space in the same campus for vehicles for the staff and workers and other vehicles engaged in the operation of the Project Highway.

The size of the office complex depends on the minimum requirement of above facilities.

**Provision for future expansion :** The office building shall be located taking into consideration of future expansion.

**10.4.21 Toll audit**

The toll plaza shall have toll audit system and fraud protection measures. The operations for toll collection, supervision, auditing and cash handling shall be done through the qualified personnel with adequate number so that each operation is efficiently handled.

**10.5 Report to be submitted**

The design and layout of Toll Plaza complex including all facilities shall be submitted to the Independent Engineer for review and comments, if any.

---

**SECTION - 11**

**LANDSCAPING AND TREE PLANTATION**

**SECTION - 11****LANDSCAPING AND TREE PLANTATION****11.1 General**

The Concessionaire shall plant trees and shrubs of required number and type at the appropriate locations within the Right of Way and in the land earmarked by the Authority for afforestation keeping in view the IRC Guidelines on Landscaping and Tree Plantation. The Authority will specify the number of trees which are required to be planted by the Concessionaire as compensatory afforestation or otherwise. The Concessionaire shall also maintain the trees and shrubs in good condition during the Concession Period as per the maintenance schedule. The guidelines given in this Section shall be followed in plantation of trees and shrubs.

**11.2 Design Considerations in Various Locations****11.2.1 Set-back distance of trees and other plantation**

Trees on the roadside shall be sufficiently away from the roadway so that they are not a hazard to road traffic or restrict the visibility. Most vulnerable locations in this regard are the inside of curves, medians, junction corners and cut slopes. Trees shall be placed at a minimum distance of 14 m from the centre line of the extreme traffic lane to provide recovery area for the vehicle that runs off the road. A second row of trees 6 m further away will also be planted wherever possible. Preferably the first row of trees shall consist of species with thick shade and other rows of vertical type providing thin shade. Expansion of the Project Highway to 6-lanes shall be taken into consideration while locating the trees so that land is free of trees when further widening takes place. The distances for alternative rows of trees shall be reckoned from the nearest edge of the unidirectional carriageway. No plantation shall be allowed on the embankment slopes.

**11.2.2 Set-back of trees on curves**

Experience has been that growth of thick vegetation close to the formation on inside of horizontal curve leads to serious reduction of sight distance and causes avoidable accidents with cattle/children suddenly emerging from the side. Uncontrolled trees/vegetation, may also affect visibility of traffic control devices and road signs. Therefore, in plain terrain a stopping sight distance of 180 m corresponding to the design speed of 100 km per hour may be ensured on all curved sections of the Project Highway along the innermost lane. However, where there are site restrictions their requirement may be reduced to 130 m corresponding to the design speed of 80 km per hour as a special case. The existing trees and vegetation on the sides have to be suitably thinned/trimmed, or even removed if necessary and a regular programme of pruning of the offending trees shall be undertaken as part of the maintenance operations.

In all cases, location of trees shall be checked to ensure that clear vision of all highway signs/signals is available at all times to the motorists. Also, the foliage or trees shall not come in the way of roadway lighting.

### 11.2.3 Vertical clearance of trees and other plantations

For safe traffic operation, the vertical clearance available across the roadway shall be minimum 5 m. From this angle, the probable size of all plants shall be anticipated in advance, at the time of initial planting.

To allow for the effects of growth, wind and rain, trees shall be trimmed to 6 m and 6.5 m above the pavement in rural and urban areas respectively.

### 11.2.4 Plantation in medians

In the sections of the Project Highway where median width is more than 3 m, shrubs shall be planted and maintained to cut off headlight glare from traffic in the opposite direction. Flowering plants and shrubs are eminently suited for the purpose. These shall be planted either in continuous rows or in the form of baffles. The height of shrubs shall be maintained at 1.5 m to cut off the effect of traffic lights coming from the opposite direction.

In the sections, where the width of median is less than 3 m, shrubs or flowery plants may be planted in between crash barriers or other means like metal/plastic strips to cut off glare shall be provided.

The shape of shrubs and plants shall be suitably regulated so that there is no overgrowth either vertically or horizontally beyond the edge of the paved median.

In the vicinity of road intersections and median openings, median plantation shall be avoided or restricted to low-growing varieties to ensure adequate visibility.

### 11.2.5 Spacing of avenue trees

The spacing of avenue trees will depend on the type and growth characteristics of trees, requirement of maintenance, penetration of distant views, etc. A range of 10-15 m would meet the requirement for most varieties.

### 11.2.6 Choice of trees

The following guidelines shall be kept in view while selecting the species of trees to be planted:

- i) Trees shall be selected with due regard to soil, rainfall, temperature and water level.

- ii) Trees which become very wide shall be avoided as their maintenance would cause interference with traffic flow.
- iii) The species must be capable of developing a straight and clean bole upto a height of 2.5 to 3.5 m from the ground level.
- iv) The selected trees shall, preferably, be fast growing and wind-firm. These shall not be thorny or drop too many leaves.
- v) The trees shall be deep rooted, as shallow roots injure pavements.
- vi) In urban areas, the species selected shall be of less spreading type, so that these do not interfere with overhead services, clear views of signs/signals, and efficiency of roadway lighting.

### 11.3 Report to be submitted

The Concessionaire shall submit scheme for plantation and maintenance of plants and trees to the Independent Engineer for review and comments, if any.

**SECTION - 12**  
**PROJECT FACILITIES**

## SECTION - 12

### PROJECT FACILITIES

#### 12.1 General

The requirement of the project facilities to be provided shall be indicated in Schedule 'C' of the Concession Agreement. This shall include information regarding location and size of the facilities. Land required for provision of facilities shall be acquired by the Authority and the date of handing over of the land to the Concessionaire shall be indicated in the Concession Agreement.

#### 12.2 Pedestrian Facilities

##### 12.2.1 General

Pedestrians are vulnerable to being involved in accidents. Therefore, adequate consideration shall be given to their safety through provision of facilities. The facilities for pedestrians given in this Section shall be provided on the Project Highway.

##### 12.2.2 Footpaths (Sidewalks)

- i) The sidewalks shall be provided in the built-up sections, on both sides, by barrier type (non-mountable) kerbs of height 200 mm above the adjacent road surface.
- ii) The width of sidewalks depends upon the expected pedestrian flow and shall be fixed subject to land availability, but shall not be less than 1.5 m.

##### 12.2.3 Pedestrian guard rails

Pedestrian guardrails shall be provided as specified in Section 9 of this Manual.

##### 12.2.4 Pedestrian crossings

Pedestrian crossings shall be provided where they will be well used. Pedestrian crossings shall be suitably integrated with the overall design of the intersection.

The following criteria shall be followed regarding selection of pedestrian crossings:

- i) **At-Grade Pedestrian Crossing (Pedestrian Crosswalk)** : Pedestrian crosswalks shall be provided at all important intersections and such other locations where substantial conflict exists between vehicular and pedestrian movements. Wherever possible, the crosswalks shall be at right angles to the carriageway and properly marked so that the pedestrians are subjected to minimum inconvenience. Crosswalks shall

not substantially increase the walk distance of pedestrians. Adequate visibility, freedom from obstructions and sufficient space for waiting are the other important requirements for location of crosswalks.

At-grade pedestrian crossings shall be controlled. Controlled form of crossing shall be achieved through provision of Zebra Crossings, whether at signalized intersection or pedestrian actuated signal.

- ii) **Zebra Crossing** : A Zebra Crossing shall not be sited within 150 m of another such crossing. The Zebra Crossing shall be somewhat set back from the carriageway line. However, the set back distance shall not be so much as to cause an appreciable increase in walking distance for the pedestrians. Pedestrian guardrails may be necessary where the setback distance is appreciable or at the skew crossings.

The width of the Zebra Crossing shall be adequate and shall generally lie within a range of 2.0 m to 4.0 m. The crossing shall, as far as possible, proceed uninterrupted through the median strip. In the event of the median strip being used as pedestrian refuge, adequate width of median shall be provided. In case of raised medians, such portion could be suitably depressed with kerb height not exceeding 150 mm.

In the vicinity of Zebra Crossing, guardrails of sufficient length shall be provided to deter pedestrians from crossing the road at any arbitrary point along the road.

- iii) **Pedestrian Underpasses/Overpasses** : The pedestrian underpasses/overpasses shall be provided as specified in Para 2.13.3 of this Manual.

## 12.3 Street Lighting

### 12.3.1 General

- i) The Concessionaire shall provide lighting at locations of the Project Highway specified in Schedule 'B', using appropriate system and source of electric power as per the requirements of this Section.
- ii) The Concessionaire shall make suitable arrangements for procuring power supply to ensure uninterrupted lighting during night and when visibility is low, including provision of DG sets as standby arrangements.
- iii) The Concessionaire shall bear all costs of procurement, installation, running and operation cost of all lighting, including cost of energy consumption specified in this Section.

### 12.3.2 Specifications

- i) Unless stated otherwise elsewhere in this Manual, the minimum level of illumination on the stretches of the Project Highway including Toll Plazas, truck lay-byes, interchanges etc. shall be 40 Lux.

- ii) The layout of the lighting system together with type of luminaries for different locations shall be prepared by the Concessionaire in such a manner that the minimum illumination level prescribed in Para 12.3.2(i) can be achieved and shall be submitted to the Independent Engineer for review and comments, if any, for compliance by the Concessionaire.
- iii) Overhead electrical power and telecommunication lines erected within the ROW by the Concessionaire shall be provided with adequate clearance so that safe use of the highway is not affected.
- iv) Vertical and horizontal clearances for electrical installations shall conform to IRC:32.
- v) All the fixtures, wires/cables, lights shall conform to relevant BIS Specifications as a minimum. The Concessionaire with the prior review and comments of the Independent Engineer can use fixtures with better specifications.

### 12.3.3 Locations where lighting is to be provided

Unless specified otherwise in Schedule 'C' of the Concession Agreement and elsewhere in this Manual, the Concessionaire shall provide lighting at the following locations of the Project Highway:

- i) **Toll Plaza Area** : The lighting in and around Toll Plaza, toll booths, office building, on the approach road, etc. shall be as per Section 10 of this Manual.
- ii) **Truck lay byes** : Lighting at the truck lay byes shall be as per Para 12.4 of this Manual.
- iii) **At interchanges** : Lighting at the interchanges shall be as per Para 3.3.5 of this Manual.
- iv) At Built-up sections on the Project Highway.

## 12.4 Truck Lay-byes

### 12.4.1 General

The Concessionaire shall construct and maintain adequate number and size of truck lay-byes for parking of trucks by the side of the Project Highway as indicated in Schedule 'B' of the Concession Agreement. The guidelines, as given here, shall be followed in regard to location, size and facilities to be provided at the truck lay-byes.

### 12.4.2 Location and size

Truck lay-byes shall, in general, be located near check barriers, interstate borders, places of conventional stops of the truck operators, etc. The places be identified on the basis of

field survey and shall have adequate space for facilities as specified in subsequent Para 12.4.3 and future growth.

### 12.4.3 Facilities

The truck lay-byes shall have the following facilities:

- i) Paved parking,
- ii) Rest areas with toilets, drinking water,
- iii) Telephone.

### 12.4.4 Lighting

The truck lay-byes and 50 m length of the Project Highway on its either side shall be illuminated at night to provide a minimum illumination of 40 Lux. Suitably designed electric poles having aesthetic appeal and energy saving bulbs may be used to provide required illumination. Alternatively, photo voltaic lamps may be used.

## 12.5 Bus Bays and Passenger Shelters

### 12.5.1 General

The buses shall be allowed to stop for dropping and picking up passengers only at the bus bays. The Authority will indicate in Schedule 'C' of the Concession Agreement, the number and broad location of bus bays to be provided by the Concessionaire. The bus bays shall conform to the specifications and standards given in this Section. In cases where bus stands are provided by the concerned State Government Transport Authorities, the Concessionaire shall provide only access road within the right of way.

### 12.5.2 Location

The location of the bus bays shall be fixed on the basis of following principles:

- i) The bus stops shall be sited away from bridges and other important structures and embankment sections more than 3 m high.
- ii) As far as possible, bus bays shall not be located on horizontal curves or at the summit of vertical curves.
- iii) The location shall have good visibility, not less than the safe stopping sight distance.
- iv) The bus bays shall not be located too close to the road intersections. A gap of 300 m from the tangent point of intersections to start/end of the bus bay shall be desirable. At minor intersections (e.g. junctions with village

roads), distance of 60 m may be adopted. However, if a substantial volume of buses is to turn right at the intersection, it is necessary that the bus bay shall be located sufficiently ahead of the intersection so that the buses can be manoeuvred easily from the pick-up stop on the left hand side to the extreme right lane for turning. The location of the bus bays may be fixed after due consultation with the local communities expected to use such facilities.

- v) At major four-way intersections involving transfer of a substantial number of passengers from one pick-up stop to the other, it might be desirable to construct a single, composite bus stop of suitable design to cater to all the bus routes collectively.
- vi) In hilly areas, the bus bays shall be located, preferably, where the road is straight on both sides, gradients are flat and the visibility is reasonably good (usually not less than 50 m). Subject to these requirements, it will be advisable to choose locations where it is possible to widen the roadway economically for accommodating bus bays.
- vii) Where grade separator is provided, the location of bus bays shall be as under
  - a) Sufficiently away from the ground intersection.
  - b) Sufficiently away from the longitudinal slope of the approaches.
- viii) The bus bay and passenger shelter shall be designed to provide for safe and convenient use by physically challenged persons as well.

### 12.5.3 Layout and Design

- i) For plain area, typical layouts of bus bays given in Fig. 12.1 shall be adopted. The length "L" shown in Fig. 12.1 shall be 15 m, which shall be increased in multiples of 15 m if more than one bus is likely to halt at the bus bay at one time.
- ii) For hilly areas, where there is a general constraint on space, the layout indicated in Fig. 12.2 may be adopted.
- iii) The channellizing island between the paved shoulder and bus bay shall not be raised; it shall be paved.
- iv) Bus bays shall be provided on both carriageways of the Project Highway for each direction of travel independently. At intersections, the bus bays for up and down direction shall be located on farther sides of the intersection.
- v) The bus bay shall be provided with a shelter for passengers. The shelter shall be structurally safe and aesthetic in appearance, while also being functional so as to protect the waiting passengers adequately from sun, wind and rain. If the shelter is constructed on the hillside, slopes shall be properly dressed and suitably protected to avoid slips. The shelter shall be set back from the kerb line by at least 500 mm.

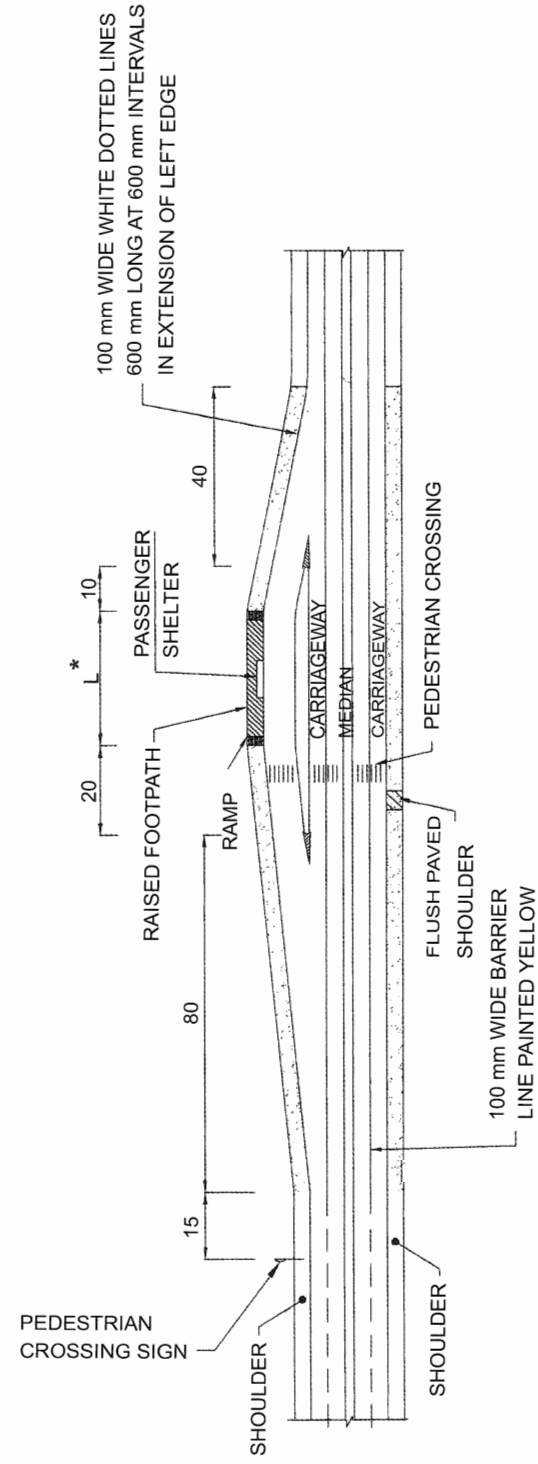

L\*=15 m IF ONLY ONE BUS IS EXPECTED TO STOP AT A TIME IT MAY BE INCREASED BY 15 m FOR EVERY ADDITIONAL BUS EXPECTED TO STOP.

Fig. 12.1 Layout of Bus Stop

Note :- All dimensions are in metres except as shown otherwise.

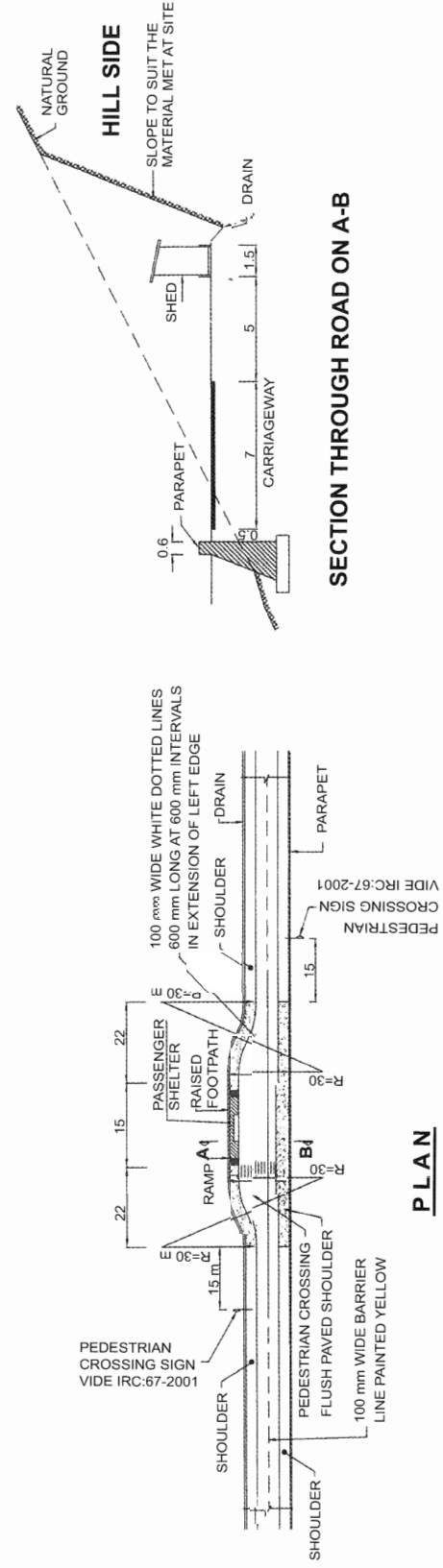

Fig. 12.2 Layout of Pick-up Bus Stop in Hilly Area

Note :- All dimensions are in metres except as shown otherwise.

**12.5.4 Pavement**

The pavement in the bus bays shall have adequate crust with respect to the wheel loads expected. Also, the surfacing shall be strong enough to withstand forces due to frequent braking and acceleration by the buses. The colour and texture of the bus bay surfacing shall be preferably distinctive from that of the main carriageway.

**12.5.5 Drainage**

- i) The bus bays shall have proper cross slope to drain off the excess water. No water, which is likely to splash on the waiting passengers, shall be allowed to collect near the bus shelters.
- ii) Suitable kerb gutter section with requisite longitudinal slope and outlets at intervals to ensure quick disposal of water shall be provided.

**12.5.6 Road markings**

Pavement markings as specified in Section 9 of this Manual shall be provided at the bus stops as shown in Fig. 12.1 and 12.2 with the word 'BUS' written prominently on the pavement. Pedestrian crossings shall be marked slightly behind the standing position of the buses in order to reduce pedestrian conflicts. The kerbs shall be marked with continuous yellow line to indicate "No Parking".

**12.6 Rest Areas**

Location and Layout of the rest areas shall be as indicated in Schedule 'B' of the Concession Agreement. Rest areas shall be provided by the Concessionaire on the lands included in the Site and procured by the Authority. Within the areas so provided, the Concessionaire shall construct and operate, or cause to be constructed and operated, paid facilities such as toilets, telephones, cafeteria, parking, etc.

**12.7 Cattle Crossings**

Facility for cattle crossings shall be provided as specified in Para 2.13.3 of this Manual.

**12.8 Traffic Aid Posts**

**12.8.1** Traffic Aid Posts shall be established at Toll Plaza locations in accordance with the provisions of the Concession Agreement.

**12.8.2** The Concessionaire shall establish and operate Highway patrol unit(s) manned by at least two persons apart from the driver for every unit which shall continuously patrol the highway in a stretch not exceeding 50 km and shall remain in contact with the Control Room on a real time basis. The patrol shall render assistance to users in distress and disabled vehicles through own intervention or by calling for assistance from Control Room,

Crane operators or ambulance as required. The patrol shall promptly clear the road of any obstruction. Where the obstructions take time to be cleared, the section shall be cordoned off by placing traffic cones, which shall be illuminated during night. The patrol vehicle shall be large enough for seating at least four personnel besides the driver and space to carry essential traffic and incidence management and safety tools. It shall also have a light on its top and a siren on board. It shall be equipped with traffic cones and other accessories for traffic control which are fully visible during night time.

**12.9 Medical Aid Posts**

**12.9.1** Medical Posts shall be established at Toll Plaza locations in accordance with the provisions of the Concession Agreement.

**12.9.2** The Concessionaire shall provide ambulance(s) manned by at least two trained and certified paramedics so that the response time is not more than 20 minutes of call. Each ambulance shall be equipped with first aid, life saving medical services and support system implements for transporting the victims to the nearest trauma care hospitals, and providing emergency medical aid during transportation of victims from accident site to the nearest trauma care hospital.

**12.10 Vehicle Rescue Posts**

**12.10.1** The Concessionaire shall provide a vehicle rescue post at Toll plaza location with all necessary equipment as specified in the Concession Agreement.

**12.10.2** Crane(s) shall be available at the site of the incident within 30 minutes of call to clear the disabled/accidented vehicles.

**12.11 Telecom System**

The Concessionaire shall provide a Telecom System at Toll plaza location with all necessary equipment as specified in Schedule 'B' of the Concession Agreement.

**12.12 Highway Traffic Management Systems (HTMS)**

**12.12.1** A real time system working round the clock shall be established for informing the road users of the road, traffic, and weather conditions on the Project Highway when the daily traffic exceeds 40,000 PCUs; for making interventions as required for smooth, safe and efficient traffic operation; and for providing rescue and relief to the users in distress. The system shall be capable of

- i) acquisition of data from various sources such as the road, the users, the maintenance and operation patrol, the ambulance, and the intervention team
- ii) three way communication between the data source and a Central Control Room, the Control Room and the data sources and display units, and between the maintenance and operation teams, through a transmission system, and

- iii) A Central Control Room to process all data and control the highway operation.

**12.12.2** The systems and equipment of HTMS shall meet the following main climatic and environmental requirement as specified in IS:9000

- a) Temperature Range of Operation – Low of 0°C ( $\pm 3^\circ\text{C}$ ) to high of 60°C ( $\pm 2^\circ\text{C}$ )
- b) Relative Humidity of 95 percent
- c) Vibration Frequency Range of 10 Hz – 55 Hz

**12.12.3 Data acquisition system :** This shall consist of (a) Automatic Traffic Counter and Classifier (ATCC), with an in-road loop detectors and treadles. (b) Video cameras installed on road with such pan and tilts that a length of 2 km road is captured for video monitoring of traffic, (c) Emergency Call Boxes installed at every 2 km to enable any user to be instantly in contact with the Control Room, (d) Meteorological sensors for capturing data on temperature, weather, wind, (e) Mobile radios for patrol vehicles and ambulances to be in communication with Central Control Room and among themselves.

**12.12.4** Emergency call boxes (ECB) with loud speaker, micro phone, activation button with LED indicating conversation, shall be housed in a vandal proof casing and operate in full to play mode in noise level of up to 95 decibels with in-built diagnostic features for automatic detection in case of damage by any object. Mobile communication system shall comprise the mobile radio base stations and control centre equipments. It shall have provision for mounted mobile set on ambulances, cranes and patrolling vehicles. The system shall have the facility to connect mobile to mobile, mobile to controller, and controller to mobile along with the systems for waiting, holding, and transfer of calls. The system shall use a pair of frequencies to be allotted to the Concessionaire with the approval of wireless planning and coordination (WPC), Deptt. of Telecommunications and shall operate for full duplex mode.

**12.12.5** The design for the Variable Message Signs (VMS) will be modular with sign panels using LEDs/High-Gain Trans-Reflective LCDs for outdoor ambient lights. The sign panel should be such that a display is legible from a distance of about 200 m. For this purpose, panels shall have minimum dimensions of 3 m length x 1.8 m depth. The minimum height of the characters shall be 300 mm. The contrast ratio shall be more than 30 perpendicular to the bold face and more than 10 at an angle of  $\pm 70^\circ$  to the perpendicular. The equipment shall be capable of storing minimum 10 frames that can be triggered on receiving the tele-command. The sign panels shall be installed on the structure in such a manner that they are aesthetically pleasing and can withstand wind pressures. The equipment shall be capable of storing minimum semi-duplex mode and other known forces. The minimum vertical clearance available at VMS shall be 5.5 m from the road surface. Power supply shall be fed from the integrator locations. The locations for VMS shall be specified in Schedule 'B'.

**12.12.6** The meteorological sensors shall comprise thermocouple/pyrometer, humidity meter, anemometer, visibility meter and sensor for measuring pavement surface temperature. They shall be installed on a single pole with a specific attachment and power supply fed from the integrator. They shall have the facility to communicate on Polythene Insulated Jelly Filled copper cables (PIJF) /Optical Fibre Cable.

**12.12.7** The Automatic Traffic Counter-cum-Classifer (ATCC) shall be capable of detecting and recording all categories of vehicles plying on the Project Highway based on their length and number of axles. The system shall be robust and capable of operating with minimum maintenance and may be either piezo-electric or infrared. It should have minimum accuracy level of 99 percent. The logic units shall be microprocessor based. The system should be able to record and store vehicle data for a period of at least two weeks with a Daily Traffic Volume of up to 1,00,000 vehicles. The system shall have compatibility to transfer the data on PIJF/Optical Fibre Cable/by using any of the available communication mode like GSM (Global System for Mobile Communications)/ GPRS (General Packet Radio Service), landline modem, CDMA (Code Division Multiple Access) depending upon the effective and economic operation of the particular mode available at the site. The system shall be electric/solar power operated depending upon the availability of source.

**12.12.8** The Closed Circuit Television (CCTV) Surveillance shall comprise video camera, its housing and pan, and Tilt Heads. The video camera shall be mounted at a height so as to cover the target length of highway and the housing shall be able to withstand adverse weather conditions. It shall have a 360° angular travel in the horizontal plane and a tilt of 90° down from 0° horizontal. It shall have zoom lens with minimum power of 30 X, auto iris and infrared filter, infrared compatibility for night operation and remotely selectable operating modes. It shall have compatibility with co-axial cable/optical fibre cable.

**12.12.9** The main control centre shall be designed for round-the-clock operations of monitoring, on-line information acquisition and processing the same for decision making. The Main Control Centre shall have equipment of central computer, call centre, terminal junction box, uninterrupted power supply (UPS), counsel operator with monitors and joy sticks, rack accommodation, large display board, line printer and general purpose office computer with monitor, printer, fax and telephone. The system shall also have Network Management system (NMS) or real-time monitoring of Emergency Call Boxes (ECBs) and network diagnostics.

**12.12.10 Transmission System :** This shall consist of a backbone Optical Fiber Transmission system, cable system, interface system, network management system, repeater/amplification system, and power supply system. There shall be 3 or 4 sub-centres (as appropriate) housing all the interface equipment apart from the Control Centre, provided with, as appropriate, cables, interface, terminals (such as optical line terminals and interface, network management system equipment, optical fiber cable

interface equipment and control centre interface equipment, data acquisition system interface, etc). The cables from ECBs, VMS, meteorological data systems, ATCC shall be Polythene Insulated Jelly filled (PIJF) copper cables and those from CCTV cameras shall be coaxial cables. Repeaters/ amplifiers shall be used to maintain the quality of signals. All the cables shall have at least 20 percent spare capacity to allow for expansion. The interface system shall be capable of handling the composite audio, video and data signals at various interface levels and process them.

**12.12.11 Central Control Room (Control Centre) :** The Central Control Room (CCR) shall be the repository of all the data acquired from the field and their processing, storing, and archiving. All the information for real time monitoring of the Project Highway shall be generated at the CCR and the relevant information shall be disseminated to the users through Variable message signs, and to the operation and management teams through mobile radio communication system for appropriate intervention. Another important function to be performed at the Control centre shall be the operation and management of the HTMS itself along with its various sub systems.

CCR shall have the following minimum equipment, hardware and software:

- i) A Central Computer Server with integrated HTMS and HTMS software
- ii) A Traffic Manager's Terminal for operation of the integrated traffic management system
- iii) Call system equipment comprising Operator PC along with sub-systems and digital voice recorder.
- iv) Mobile radio terminal comprising Operator PC and engineering terminal
- v) Computers for Network Management System (NMS) for Fiber Optic Communication System.
- vi) CCTV Console Equipment
- vii) Computers for VMS, AVCC, MET, Traffic Control
- viii) A large size screen
- ix) A line Printer
- x) An Office Computer
- xi) A Power Supply and back up system

**12.12.12 Dissemination of information :** Information generated at the Control Centre shall be disseminated in the following manner:

- a) **To the users :** By displays on the Variable Message Signs, via internet web pages, and by creating a node at the wayside amenities to display the relevant information.

- b) **To the Operation and maintenance teams :** By mobile phones.
- c) **To the ambulances :** By mobile phones.
- d) **To the trauma care centres :** Via ambulances.

### 12.13 Operation and Maintenance Centre

**12.13.1** There shall be operation and maintenance centre(s) either at the toll plaza(s) or at any other location along the Project Highway as identified by the Concessionaire. The land for the same shall be acquired by the Concessionaire at his cost and risk. The operation and maintenance centre would have following minimum facilities:

- i) Main control centre and Administrative block.
- ii) Equipment for operation and maintenance and storage space for them.
- iii) Storage space for equipment and material for traffic signs and markings.
- iv) Workshop.
- v) General garage and repair shop.
- vi) Testing laboratory.
- vii) Parking space for minimum 4 number of large vehicles and for other expected vehicle during peak hours including those for working staff and visitors.

**12.13.2** All building works shall be designed to meet the functional requirements and shall be compatible with regional architecture and micro climate. Locally available materials shall be given preference but not at the cost of construction quality.

**12.13.3** The circulation roads and parking spaces in the O&M centre shall be paved to withstand vehicle loads and forces due to frequent acceleration and deceleration of vehicles. Parking bays/lots shall have proper cross slope and drainage. The marking of the parking bays shall be as per IRC:35 to demarcate parking and circulation space. Parking lots shall have illumination as provided in IS:1944 (Parts I and II).

**12.13.4** The whole campus of operation and maintenance centre shall have system for security with safe entry and exit.

### 12.14 Report to be submitted

The Concessionaire shall submit report containing the proposals for provision of project facilities on the Project Highway to the IE for review and comments, if any.

**SECTION - 13**

**SPECIAL REQUIREMENTS FOR HILL ROADS**

## SECTION - 13

## SPECIAL REQUIREMENTS FOR HILL ROADS

**13.1 General**

**13.1.1** The additional/new carriageway in hilly areas may either be constructed at the same level as that of the existing carriageway or at different levels to form a split highway depending upon the feasibility and geo-technical stability of the area.

**13.1.2** The Concessionaire shall pay due attention to geo-technical, environmental and social aspects of hill roads and take appropriate measures to ensure the following:

(The guidelines given in IRC:SP:48 may be referred to, for details).

- i) Stability against geological disturbances.
- ii) Prevention of soil erosion.
- iii) Provision of efficient drainage and preservation of natural drainage system.

**13.1.3** If there are any landslide prone areas along the road alignment, adequate investigation shall be undertaken and appropriate remedial measures shall be provided as per guidelines given in IRC:SP:48.

**13.1.4** Where any new construction/realignment is involved, the alignment shall avoid large scale cutting and filling and follow the profile of land, as far as possible.

Areas having potential landslide or settlement problems shall be avoided. Adverse impact on the environment shall be reduced by adopting proper mitigation measures. Refer to guidelines given in IRC:SP:48.

**13.1.5** Unstable hill slopes shall be adequately addressed by providing appropriate bioengineering and stabilization measures.

**13.1.6** Necessary safeguard shall be taken to protect ecologically sensitive areas like wild life and bird sanctuaries, reserve forests, national parks, etc.

**13.1.7** Protective structures for traffic such as parapets, railings, roadside safety barriers, boulder nets, etc. shall be provided, where necessary.

**13.1.8** In mountainous and steep terrain, the scope of work defined by the Authority may be two-lane carriageways on different alignments (contours). In that case, the Manual of Specifications and Standards for two-laning of Highways shall apply to the two-lane carriageways on different alignments (contours).

### 13.2 Set Back Distance at Horizontal Curves

Requisite sight distance should be available across the inside of horizontal curves. Lack of visibility in the lateral direction may arise due to obstructions like walls, cut-slopes, wooded areas, etc. Set back distance from the central line of the carriageway, within which the offending obstructions should be cleared to ensure the needed visibility, can be determined using the Equation given in IRC:52.

### 13.3 Grade Compensation at Curves

At horizontal curves, the gradient shall be eased by applying the grade compensation correction for gradients steeper than 4 per cent in accordance with IRC:52.

### 13.4 Hairpin Bends

Hairpin bends, where unavoidable, may be designed either as a circular curve with transition curves at each end or as a compound circular curve.

Design criteria given in IRC:52 shall be adopted for the design of hairpin bends. At hairpin bends, the full roadway width shall be surfaced.

### 13.5 Climbing Lane

Climbing lane shall be provided, where specified in Schedule 'B' of the Concession Agreement, in order to address the necessity of making available separate lane for safe overtaking for vehicle traveling uphill.

Proper signs and road markings shall be provided to ensure that the absolute right of way for climbing vehicles is available.

### 13.6 Rock Blasting

Heavy rock blasting should be avoided. Controlled blasting shall be resorted to. Blasting shall be supervised by experienced personnel. Blasting and related operations shall be carried out in accordance with Clause 302 of MORTH Specifications.

### 13.7 Cut Slopes

Cut slopes shall be rendered stable in the construction stage itself, by cutting at the correct angle and benching etc. including slope stabilizing structures like drains, breast walls, pitching, etc.

### 13.8 Tunnels

Where it is necessary to cross hills or high ridges, the various alternatives including construction of tunnel to avoid deep cuts shall be considered and the most preferred

alternative shall be chosen. The alternative to be followed shall be indicated in Schedule 'B' of the Concession Agreement. Where road is to be taken through tunnel, its salient details shall be indicated in Schedule 'B' of the Concession Agreement.

### 13.9 Drainage

For drainage of water from roadside, an effective system of drainage shall be constructed to lead the run-off to natural water courses. In particular, catch water drains (Refer to para 6.5 of this Manual) shall be provided above the cut slopes. It shall be ensured that water is not drained into villages and cultivated land. Location of cross drains and culverts should be so chosen as to avoid erosion of the outlet. Erosion control works like drop walls, apron at out-fall points along with pitching/paving of the channel shall be provided where required.

### 13.10 Retaining Walls

13.10.1 Retaining walls shall be provided

- i) To support the down hill side unstable strata or fills,
- ii) To achieve width of roadway, where cutting into hill is restricted,
- iii) To arrest damage caused to the valley side and the road, by under cutting by a stream or other water course,
- iv) At valley points, where water flows over the road,
- v) At places where the valley side gets saturated in the monsoons and is likely to result in slips and damage to the road,
- vi) At any other locations warranting provision of retaining walls.

13.10.2 The retaining walls on the existing roads shall be inspected by the Concessionaire to check and assess the requirements of repairs and/or strengthening or reconstruction. If so required, the repair, strengthening or reconstruction work shall be carried out as per the assessment.

13.10.3 For general features, arrangement and design, guidelines given in IRC:SP:48 may be referred to.

### 13.11 Aprons etc.

Construction of apron, pitching, flooring shall conform to Clauses 2503 to 2507 of MORTH Specifications.

**13.12 Disposal of Debris**

Disposal sites shall be identified by the Concessionaire for disposal of waste, debris, etc. Tipping of waste into valley sides, stream channels, water bodies, and forest areas shall not be resorted to.

**13.13 Report to be Submitted**

The Concessionaire shall submit report containing proposal for special requirements in hill areas to the IE for review and comments, if any.

**List of Paras for preparing schedules of the Concession Agreement (Refer Para 1.11)**

<b>Section</b>	<b>Para</b>	<b>Particulars to be specified</b>
Sector 1	1.17	Utilities to be constructed/shifted
	1.19.2	List of sections passing through built-up areas
	1.20	List of stretches where 6-laning shall be provided as part of 4-laning of the Project Highway
Section 2	2.1 (ii) (a)	List of stretches where requirement of 6-laning passing through built-up areas is dispensed with
	2.1 (ii) (b)	Construction of bypass, alignment and land for the bypass
	2.1 (v)	Land for geometric improvements, and such stretches
	2.2.2	Land for geometric improvements and such stretches for ruling design speed
	2.3	Right of way available and land to be acquired.
	2.5.1	Type and widths of median in various stretches
	2.9.4	List of sections where radius of curve less than desirable minimum
	2.10.1 (i)	Width of underpasses
	2.10.2 (ii)	Pedestrian and cattle underpasses where vertical clearance shall be 4.5 m
	2.11.1	Width of overpasses
	2.12.1	Locations of intersections
	2.12.2.1	Location and length of service roads
	2.12.2.2	Treatment of service road at bridge locations
	2.13.1	Location and other features of grade separated structures
	2.13.2	Type of structure for vehicular underpass or overpass and whether cross road shall be carried at the existing level
2.13.3	Location of cattle and pedestrian underpasses or overpasses	

Section	Para	Particulars to be specified
	2.18	List of stretches that are not required to be constructed as 6-lanes when traffic exceeds specified design service volume.
Section 3	3.1.1 & 3.1.2	Location and type of intersection/interchange, other features and land requirements
	3.3.4	Length of viaduct at grade separated structures
Section 4	4.2.1 (ii)	Sections of existing road to be raised
Section 5	5.2.1	Type of pavement for new construction
	5.2.2	Type of strengthening of existing flexible pavement, if not bituminous overlay
	5.2.3	Requirement of CC pavement, and design, performance, construction and maintenance requirements
	5.9.4	Stretches to be reconstructed
Section 7	7.1 (ii)	Bridges which are not required to have independent superstructure
	7.1 (iii)	Bridges which are not required to be high level bridges
	7.1 (viii)	Utility services to be carried over the structures
	7.3 (ii) (b)	List of bridges required to be 6-lane wide
	7.3 (ii) (c)	List of bridges or grade separated structures where passing places are to be provided
	7.3 (iii) (d)	List of culverts to be reconstructed and/or widened
	7.3 (iv) (f)	List of bridge structures to be reconstructed and/or widened
	7.4 (v)	Requirement of special structures like cable stayed/ superstructure bridge, etc.
	7.15.1	Requirement of reinforced earth retaining structures when height more than 10 m.
	7.17 (iv)	Requirement of Crash barriers for existing bridges
	7.17 (v)	Parapets/railings of existing bridges to be repaired/ replaced.
	7.18.1	Locations where railway level crossings not to be replaced with ROB/RUBs

Section	Para	Particulars to be specified
	7.19 (i)	Location and type of grade-separated structures
	7.20	Type of drainage arrangement for the bridge deck
	7.21	Measures for protecting structures in marine environment
	7.22 (i)	Structures to be repaired/strengthened, nature and extent of repairs
Section 9	9.2.7	Locations and size of overhead traffic signs
	9.7.2 (iv)	Locations (hazardous) that require safety barriers
Section 10	10.1	Location of Toll Plaza
Section 11	11.1	Number of trees to be planted
Section 12	12.1	Project facilities and land for providing project
	12.3.1	Locations for providing lighting
	12.3.3	Situations/locations where lighting to be provided
	12.4.1	Location and number of truck lay-byes to be provided
	12.5.1	Location and number of bus bays to be provided
	12.6	Location and layout of rest areas
	12.12.5	Locations of VMS
Section 13	13.5	Requirement of climbing lane
	13.8	Alignment/construction of tunnel and its salient details

**Appendix - 2**

Sl. No.	Code/ Document No.	Title of the Publication (Titles given in bold types have been Just Published)
<b>I. IRC SPECIFICATIONS, STANDARDS, DESIGN CODES</b>		
1.	IRC:2-1968	Route Marker Signs for National Highways (First Revision)
2.	IRC:3-1983	Dimensions & Weights of Road Design Vehicles (First Revision)
3.	IRC:5-1998	Standard Specifications and Code of Practice for Road Bridges, Section I - General Features of Design (Seventh Revision)
4.	IRC:6-2000	Standard Specifications and Code of Practice for Road Bridges, Section II - Loads and Stresses (Fourth Revision)
5.	IRC:7-1971	Recommended Practice for Numbering Bridges and Culverts (First Revision)
6.	IRC:8-1980	Type Designs for Highway Kilometre Stones (Second Revision)
7.	IRC:9-1972	Traffic Census on Non-Urban Roads (First Revision)
8.	IRC:10-1961	Recommended Practice for Borrowpits for Road Embankments Constructed by Manual Operation
9.	IRC:11-1962	Recommended Practice for the Design and Layout of Cycle Tracks
10.	IRC:12-1983	Recommended Practice for Location and Layout of Roadside Motor-Fuel Filling and Motor-Fuel Filling-cum-Service Stations (Second Revision)
11.	IRC:14-2004	Recommended Practice for Open Graded Premix Carpets (Third Revision)
12.	IRC:15-2002	Standard Specifications and Code of Practice for Construction of Concrete Roads (Third Revision)
13.	<b>IRC:16-2008</b>	<b>Standard Specifications and Code of Practice for Prime and Tack Coat (Second Revision)</b>
14.	IRC:17-1965	Tentative Specification for Single Coat Bituminous Surface Dressing <b>(Amalgamated with IRC:110-2005)</b>
15.	IRC:18-2000	Design Criteria for Prestressed Concrete Road Bridges (Post-Tensioned Concrete) (Third Revision)
16.	<b>IRC:19-2005</b>	<b>Standard Specification and Code of Practice for Water Bound Macadam (Third Revision)</b>
17.	IRC:20-1966	Recommended Practice for Bituminous Penetration Macadam (Full Grout)
18.	IRC:21-2000	Standard Specifications and Code of Practice for Road Bridges, Section III - Cement Concrete (Plain and Reinforced) (Third Revision)
19.	<b>IRC:22-2008</b>	<b>Standard Specifications and Code of Practice for Road Bridges, Section VI - Composite Construction (Limit States Design) (Second Revision)</b>