



# Digital Signal & Image Processing Lecture-1

**Dr Prasanthi Rathnala**

**Department of ECE**



# Overview



- Digital Signal Processing System
- Analog to Digital Conversion
- Nyquist–Shannon Sampling Theorem
- Aliasing
- Sampling Effect in Time Domain
- Sampling Effect in Frequency Domain
- Anti Aliasing Filter
- Under-sampling
- Sampling of Band Limited Signals
- Over-sampling
- Digital to Analog Conversion

# Analog vs. Digital Signal Processing

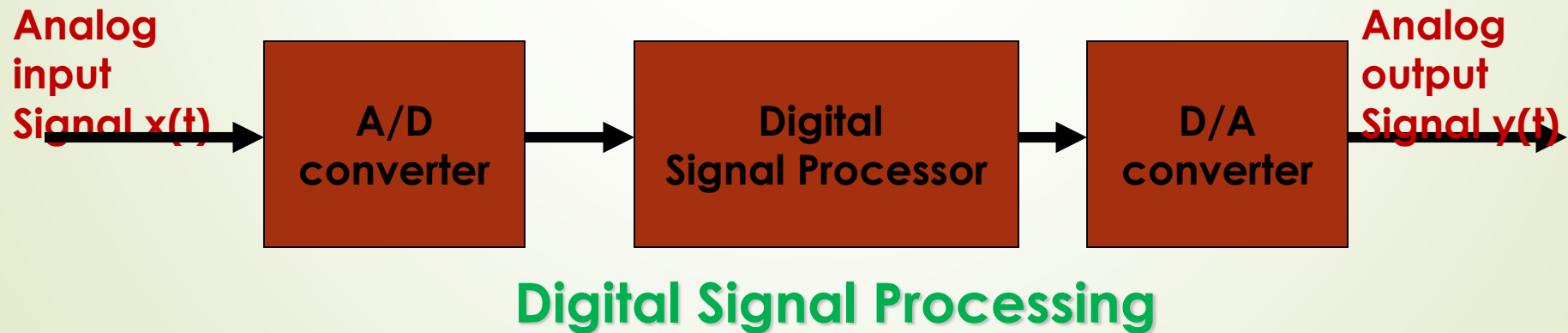

# Typical Digital Signal Processing System

4

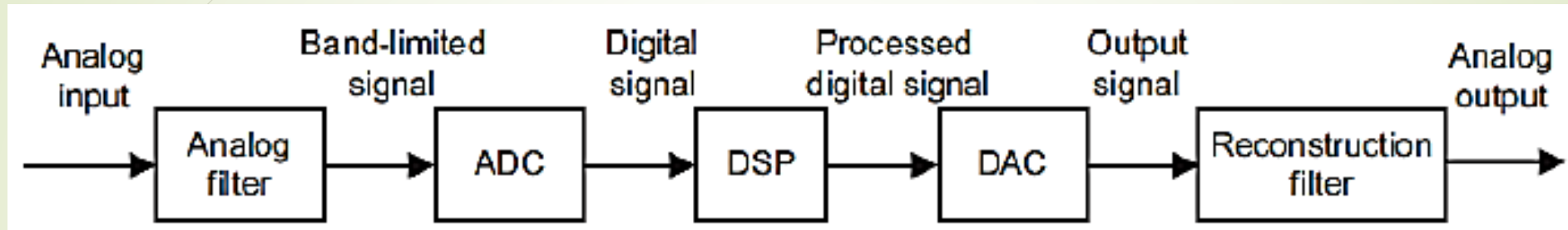

**It consists of**

- **an analog filter called (anti-imaging) filter,**
- **an analog-to-digital conversion (ADC) unit,**
- **a digital signal (DS) processor,**
- **a digital-to-analog conversion (DAC) unit,**
- **and an analog filter called reconstruction (anti-image) filter.**

# Typical Digital Signal Processing System

5

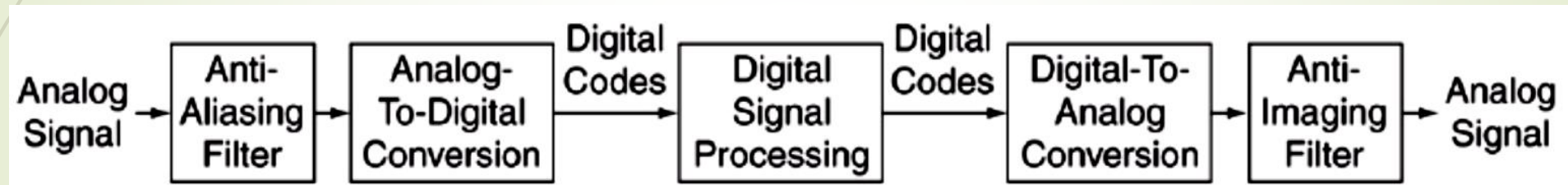

# A/D & D/A Conversion

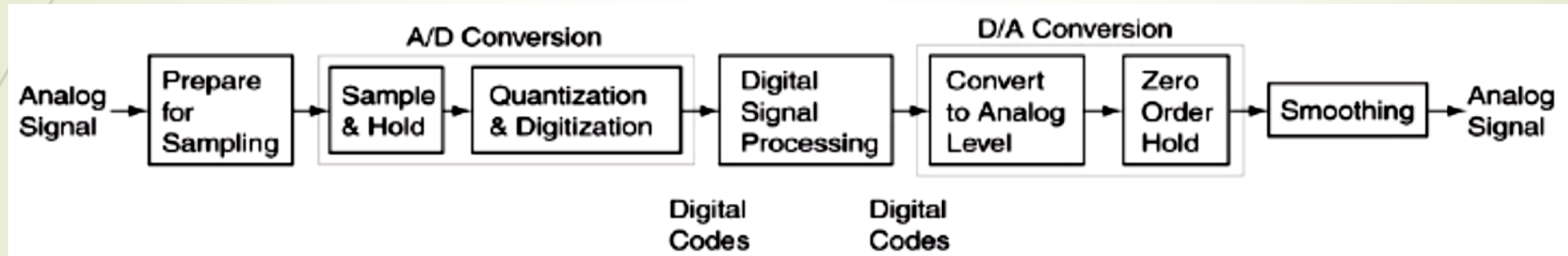

# Analog to Digital (A/D) Conversion

- ▶ Most signals of practical interest are analog in nature  
Examples: Voice, Video, RADAR signals, Transducer/Sensor output, Biological signals etc
- ▶ So in order to utilize those benefits, we need to convert our analog signals into digital
- ▶ This process is called A/D conversion

# Analog to Digital Conversion

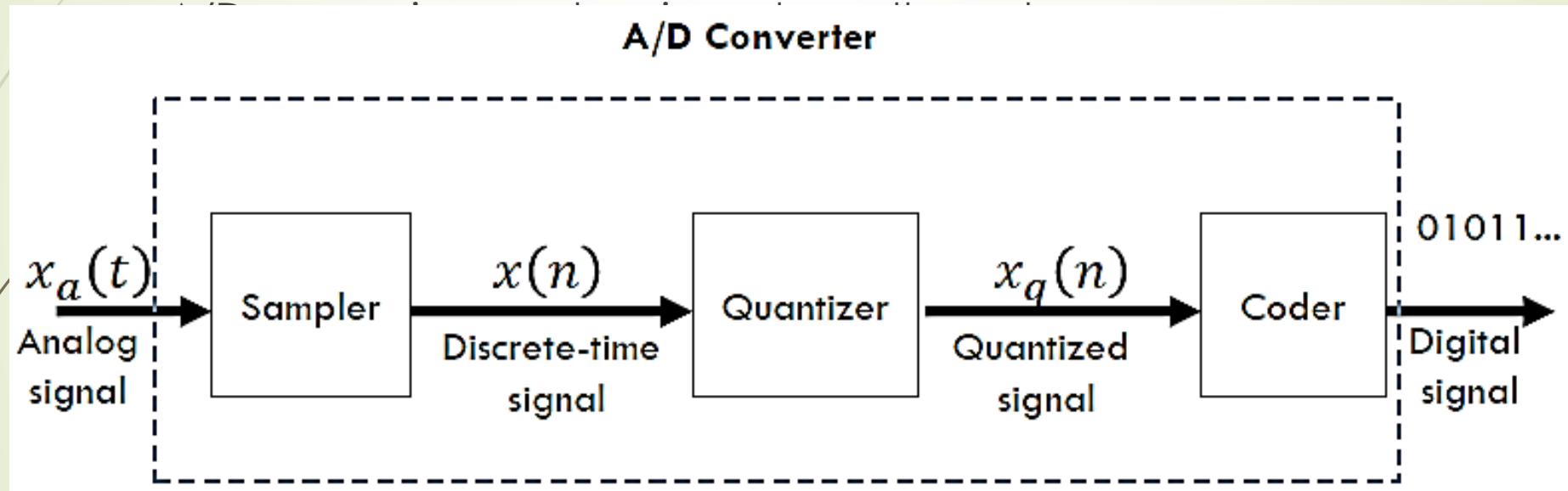



# Analog to Digital Conversion

- Sampling
  - ▣ Conversion from continuous-time, continuous valued signal to discrete-time, continuous-valued signal
- Quantization
  - ▣ Conversion from discrete-time, continuous valued signal to discrete-time, discrete-valued signal
- Coding
  - ▣ Conversion from a discrete-time, discrete-valued signal to an efficient digital data format

# Analog to Digital Conversion

## Sample & Hold (Sampler)

- ▶ Analog signal is continuous in time and continuous in amplitude.
- ▶ It means that it carries infinite information of time and infinite information of amplitude.
- ▶ Analog (continuous-time) signal has some value defined at every time instant, so it has infinite number of sample points.

# Analog to Digital Conversion

## Sample & Hold (Sampler)

- ▶ It is impossible to digitize an infinite number of points.
- ▶ The infinite points cannot be processed by the digital signal (DS) processor or computer, since they require an infinite amount of memory and infinite amount of processing power for computations.
- ▶ Sampling is the process to reduce the time information or sample points.

# Analog to Digital Conversion

## Sample & Hold (Sampler)

- ▶ The first essential step in analog-to-digital (A/D) conversion is to sample an analog signal.
- ▶ This step is performed by a sample and hold circuit, which samples at regular intervals called sampling intervals.
- ▶ Sampling can take samples at a fixed time interval.
- ▶ The length of the sampling interval is the same as the sampling period, and the reciprocal of the sampling period is the sampling frequency  $f_s$ .

# Analog to Digital Conversion

## Sample & Hold (Sampler)

- ▶ After a brief acquisition time, during which a sample is acquired, the sample and hold circuit holds the sample steady for the remainder of the sampling interval.
- ▶ The hold time is needed to allow time for an A/D converter to generate a digital code that best corresponds to the analog sample.
- ▶ If  $x(t)$  is the input to the sampler, the output is  $x(nT)$ , where  $T$  is called the sampling interval or sampling period.
- ▶ After the sampling, the signal is called “discrete time continuous signal” which is discrete in time and continuous in amplitude.

# Analog to Digital Conversion

## Sample & Hold (Sampler)

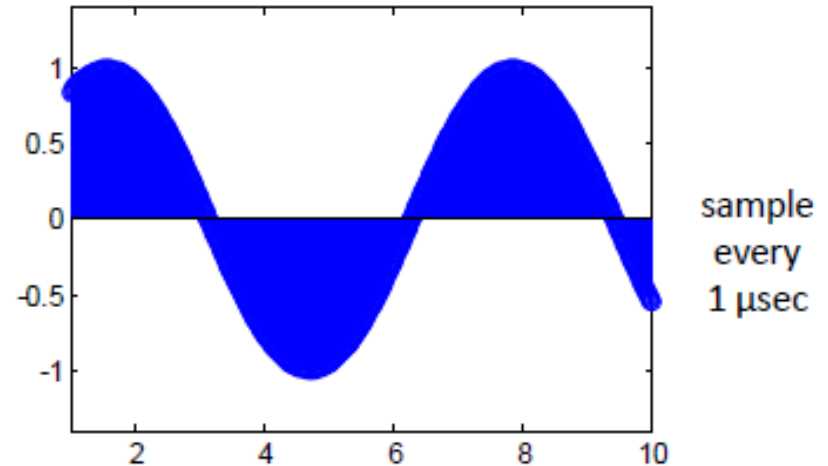
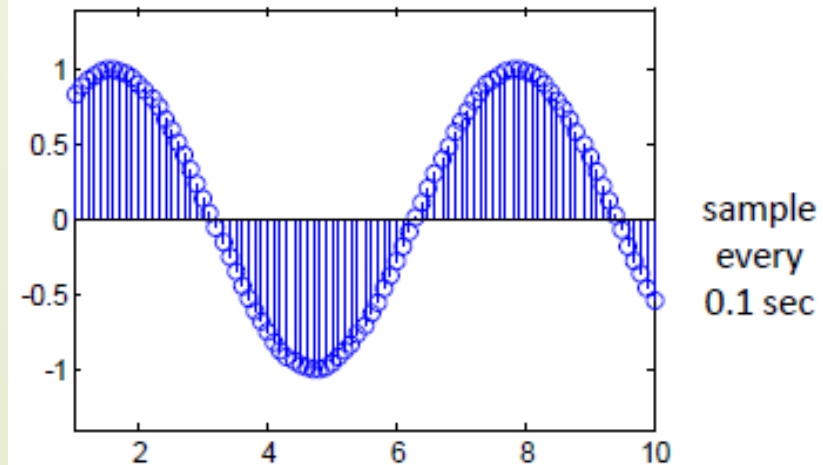
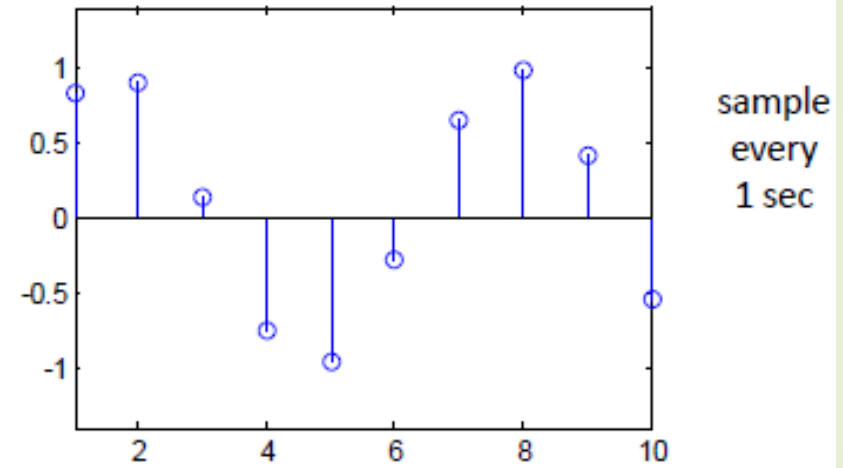
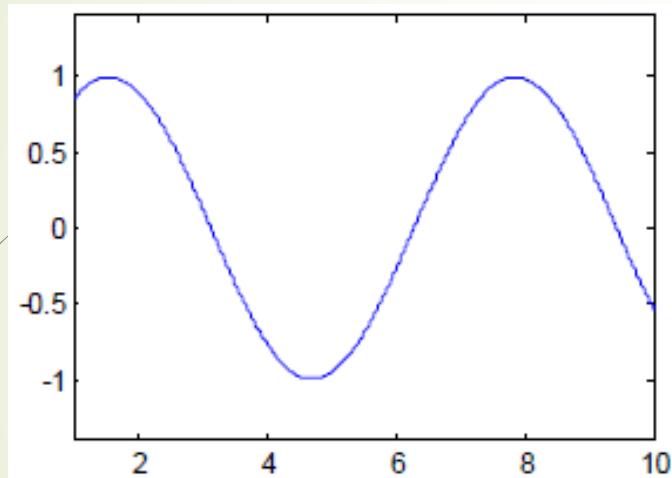

# Analog to Digital Conversion

## Sample & Hold (Sampler)

Figure below shows an analog (continuous-time) signal (solid line) defined at every point over the time axis (horizontal line) and amplitude axis (vertical line).

Hence, the analog signal contains an infinite number of points.

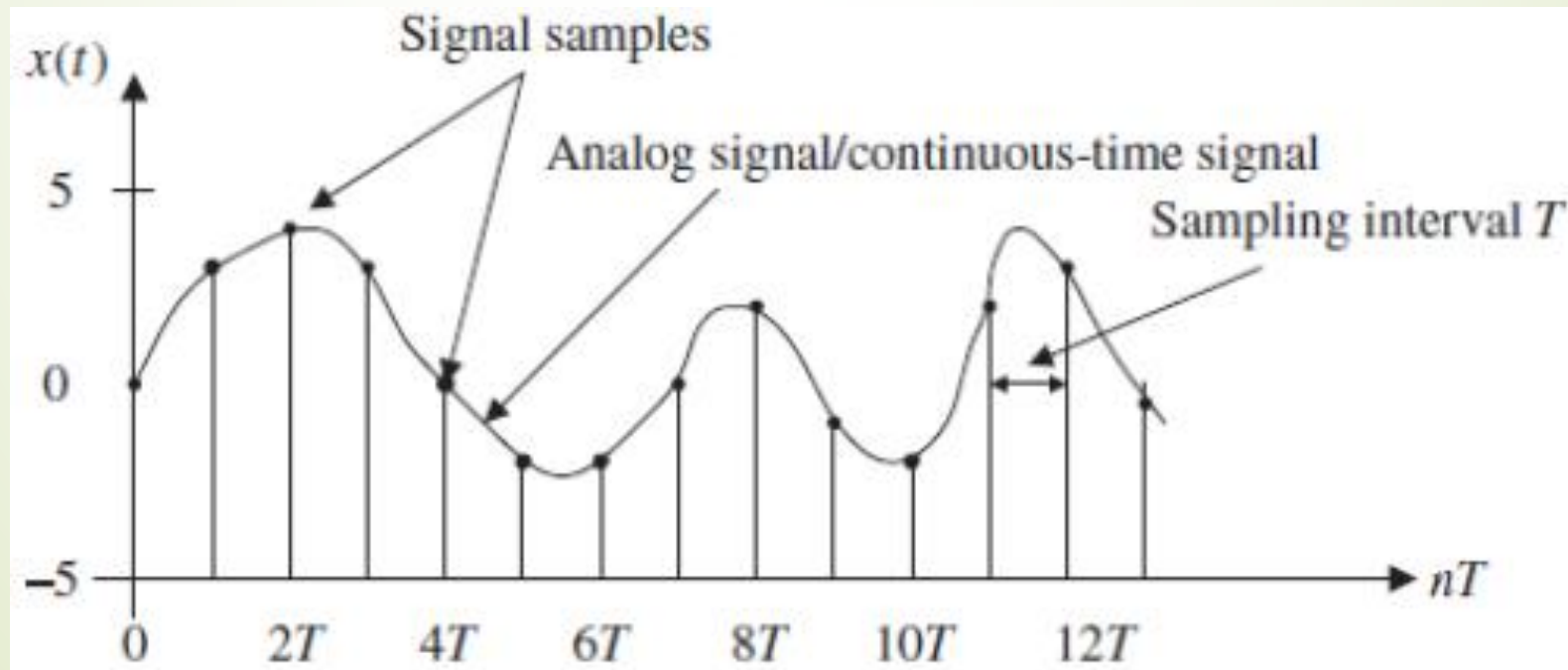

# Analog to Digital Conversion

## Sample & Hold (Sampler)

- ▶ Each sample maintains its voltage level during the sampling interval  $T$  to give the ADC enough time to convert it.
- ▶ This process is called sample and hold.

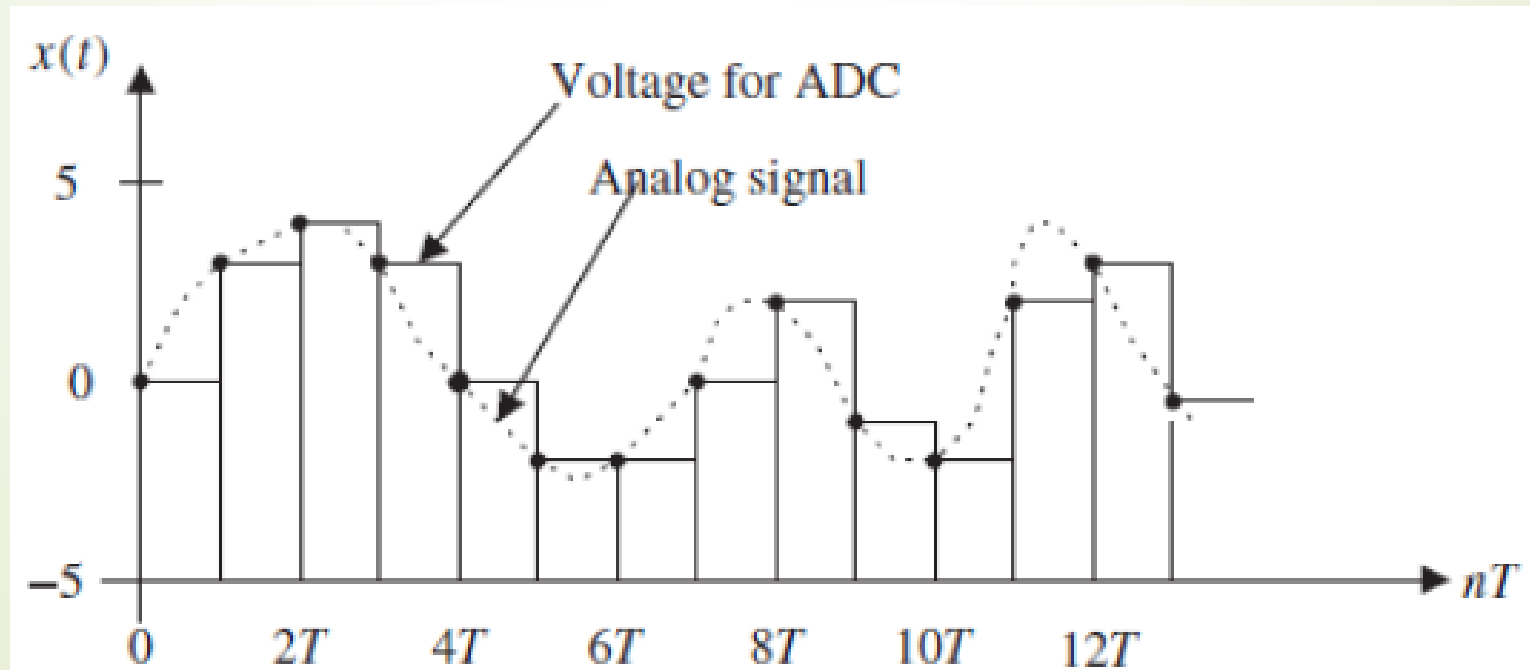

Sample-and-hold analog voltage for ADC



# Nyquist–Shannon Sampling Theorem

17

The sampling theorem guarantees that an analogue signal can be perfectly recovered as long as the sampling rate is at least twice as large as the highest-frequency component of the analogue signal to be sampled.

$$F_s \geq 2F_{\max}$$

# Nyquist–Shannon Sampling Theorem

18

- For a given sampling interval  $T$ , which is defined as the time span between two sample points, the sampling rate is therefore given by

$$f_s = \frac{1}{T} \text{ samples per second (Hz)}$$

- Example

- If a sampling period is  $T = 125 \mu\text{s}$ , the sampling rate is  $f_s = 1/125 \mu\text{s} = 8,000$  samples per second (Hz).

# Nyquist–Shannon Sampling Theorem

19

- In order to sample a voice signal containing frequencies up to 4 KHz, we need a sampling rate of  $2 * 4000 = 8000$  samples/second
- Similarly for sampling of sound with frequencies up to 20 KHz, we need a sampling frequency of  $2 * 20000 = 40000$  samples/second

# Nyquist–Shannon Sampling Theorem

20

**Example: For the following analog signal, find the Nyquist sampling rate, also determine the digital signal frequency and the digital signal**

$$x(t) = 3 \cos(70\pi)t$$

The maximum frequency component is  $x(t)$  is

$$F_{\max} = \frac{70\pi}{2\pi} = 35 \text{ Hz}$$

Therefore according to Nyquist, we need a sampling rate of

$$F_s = 2F_{\max} = 70 \text{ Hz}$$

The digital signal would have a frequency

$$\omega = 2\pi \frac{35}{70} = \pi$$

The digital signal can be represented as

$$x[n] = 3 \cos(\pi n)$$

# Nyquist–Shannon Sampling Theorem

21

**Examp**  $s(t) = 3 \cdot \cos(50 \pi t) + 10 \cdot \sin(300 \pi t) - \cos(100 \pi t)$  rad.

$$s(t) = 3 \cdot \underbrace{\cos(50 \pi t)}_{F_1} + 10 \cdot \underbrace{\sin(300 \pi t)}_{F_2} - \underbrace{\cos(100 \pi t)}_{F_3}$$

$$F_1 = 25 \text{ Hz}, F_2 = 150 \text{ Hz}, F_3 = 50 \text{ Hz}$$

$f_{\text{MAX}}$

So sampling frequency should be

$$f_s > 300 \text{ Hz}$$

# Nyquist–Shannon Sampling Theorem

22

## Exercise

Determine the Nyquist sampling rate of a signal

$$x(t) = 3\sin(5000\pi t + 17^\circ)$$

# Aliasing

How fast must we sample\* a continuous signal to preserve its info content?

**Ex: train wheels in a movie.**

25 frames (=samples) per second.

Train starts ➡ wheels 'go' clockwise.

Train accelerates ➡ wheels 'go' counter-clockwise.



**Why?**

Frequency misidentification due to low sampling frequency.

# Aliasing

## How many hertz can the human eye see?

- ▶ Most don't notice unless it is under **50** or **60** Hz.
- ▶ Generally, people notice when the frame-rate is less than the refresh rate of the display.
- ▶ Depending on the type of CRT, you couldn't see flicker at **30 Hz** or you could still see it at **120 Hz**.



# Aliasing

- ▶ When the minimum sampling rate is not respected, distortion called aliasing occurs.
- ▶ Aliasing causes high frequency signals to appear as lower frequency signals.
- ▶ To be sure aliasing will not occur, sampling is always preceded by low pass filtering.
- ▶ The low pass filter, called the anti-aliasing filter, removes all frequencies above half the selected sampling rate.

# Aliasing

- ▶ Figure illustrates sampling a 40 Hz sinusoid
- ▶ The sampling interval between sample points is  $T = 0.01$  second, and the sampling rate is thus  $f_s = 100$  Hz.
- ▶ The sampling theorem condition is satisfied

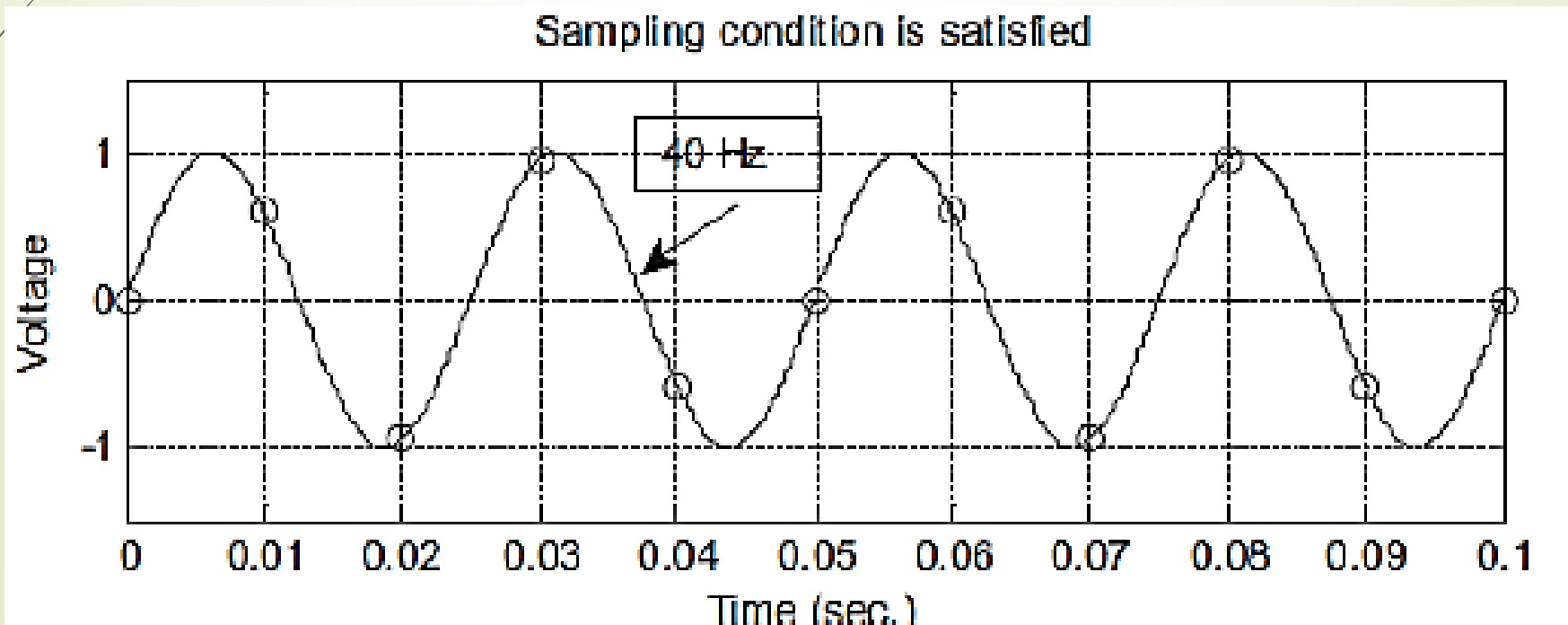

# Aliasing

- ▶ Figure illustrates sampling a 90 Hz sinusoid
- ▶ The sampling interval between sample points is  $T = 0.01$  second, and the sampling rate is thus  $f_s = 100$  Hz.
- ▶ The sampling theorem condition is not satisfied

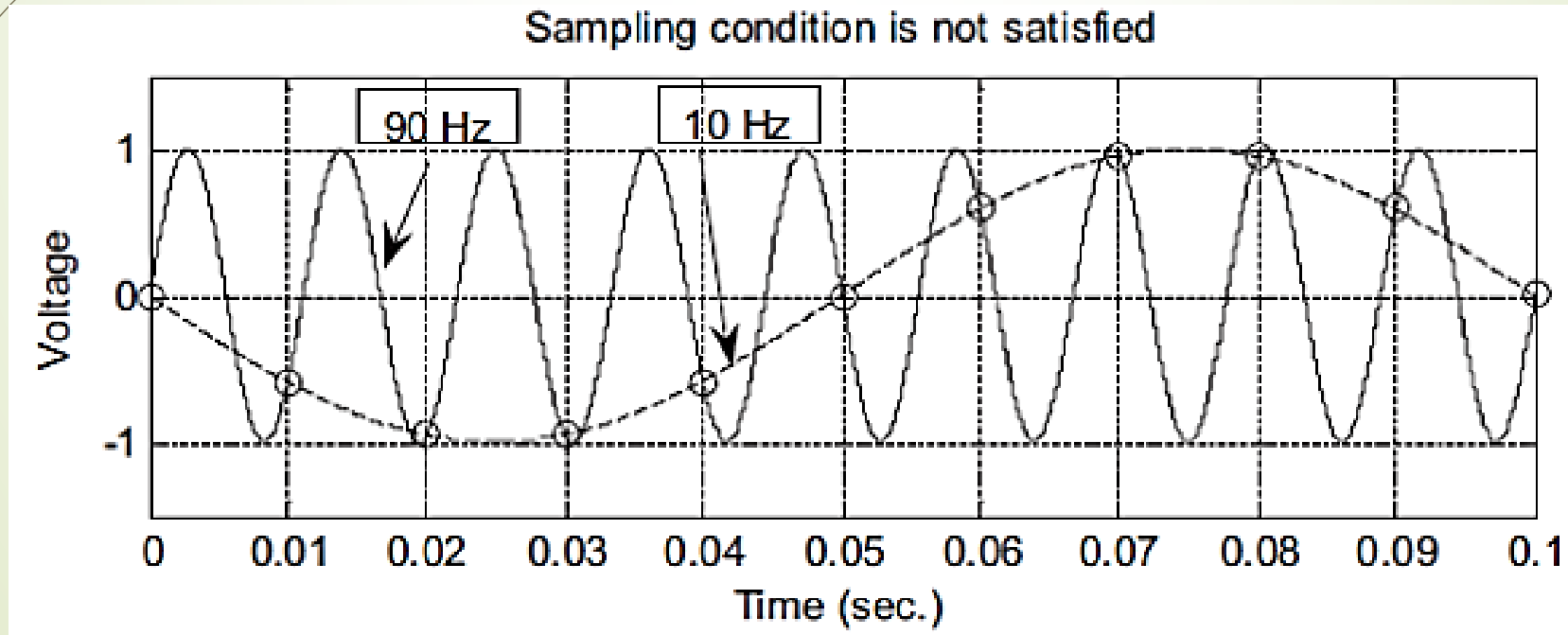

# Aliasing

- Based on the sample amplitudes labeled with the circles in the second plot
  - ▣ We cannot tell whether the sampled signal comes from sampling a 90-Hz sine wave (plotted using the solid line) or from sampling a 10-Hz sine wave (plotted using the dot-dash line).
  - ▣ They are not distinguishable.
  - ▣ Thus they are aliases of each other.
  - ▣ We call the 10-Hz sine wave the aliasing noise in this case, since the sampled amplitudes actually come from sampling the 90-Hz sine wave.

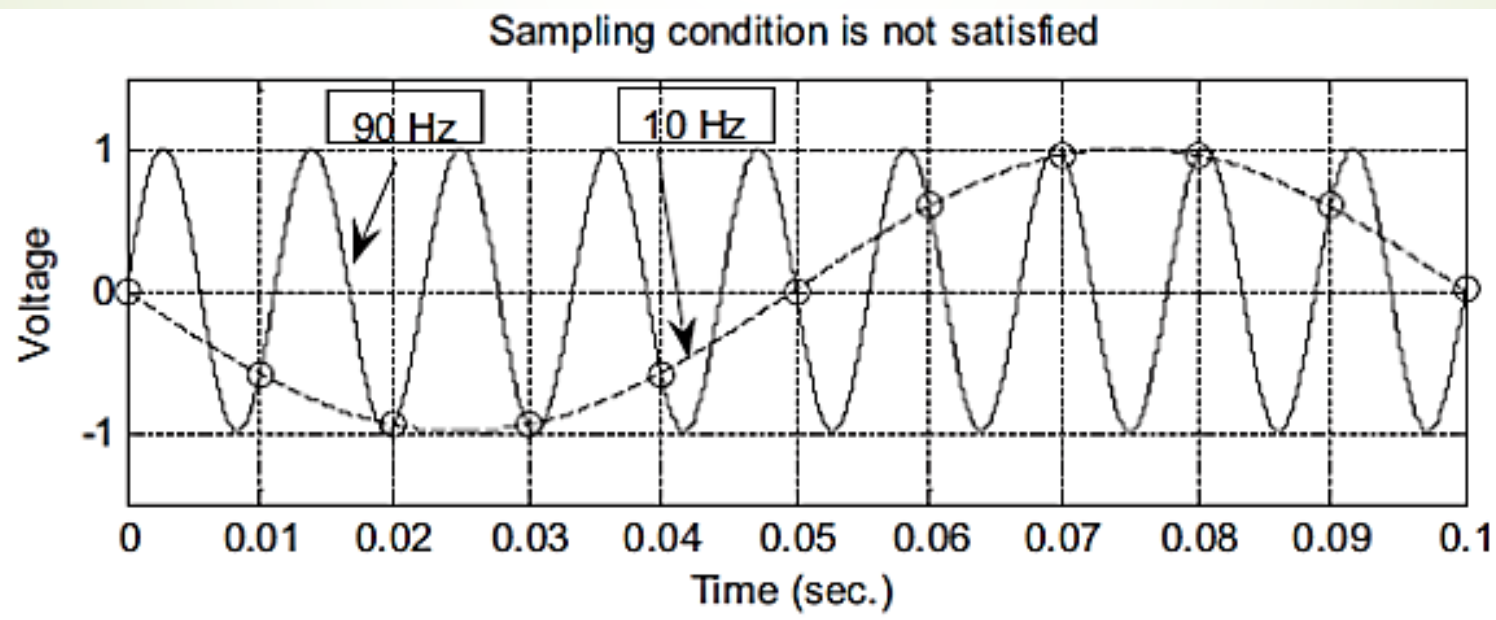

# Sampling Effect in Time Domain

**Example** of Aliasing in the time domain of various sinusoidal signals ranging from 10 kHz to 80 kHz with a sampling frequency  $F_s = 40$  kHz.

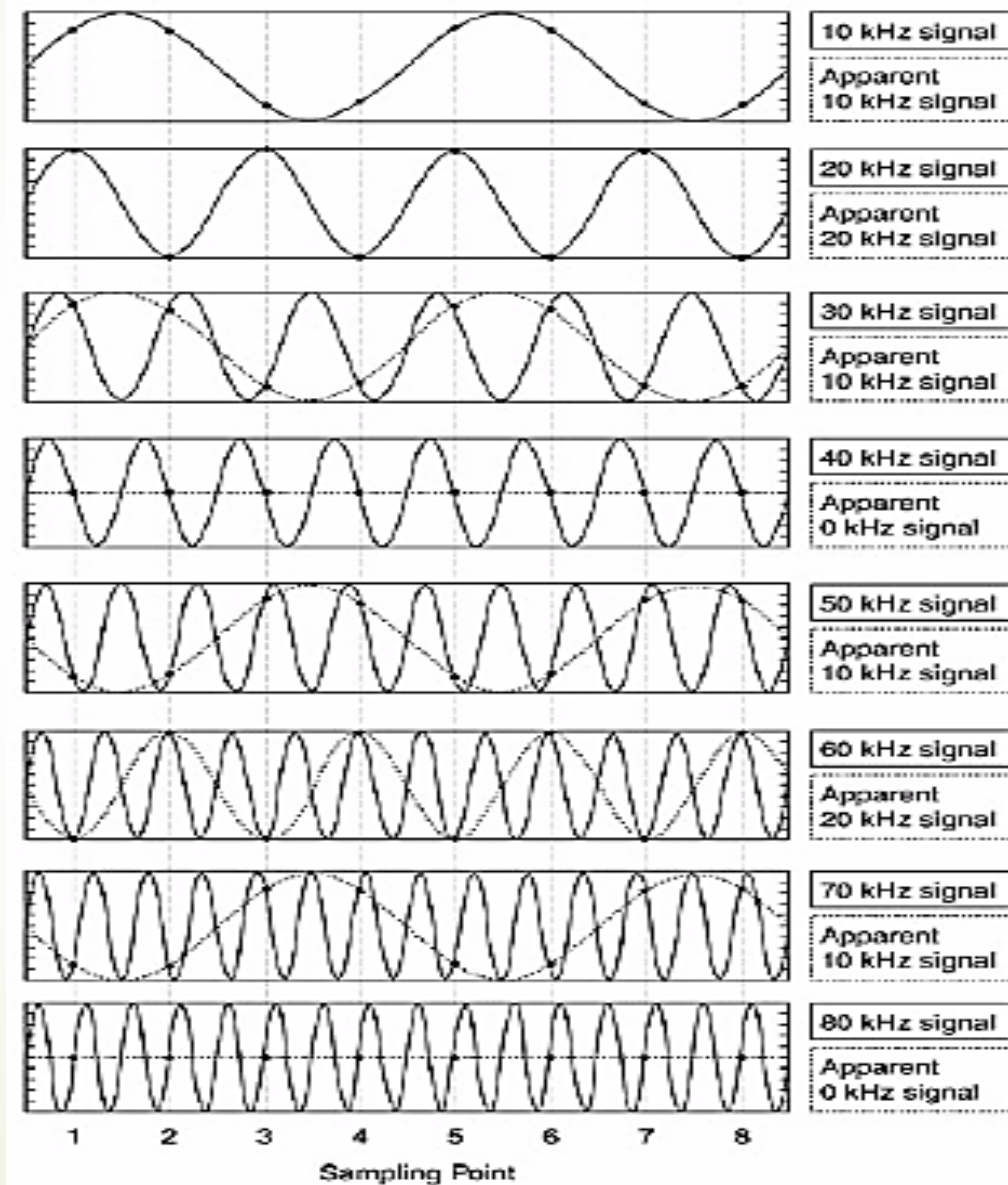

# Time & Frequency Domains

- There are two complementary signal descriptions.
- Signals seen as projected onto time or frequency domains.

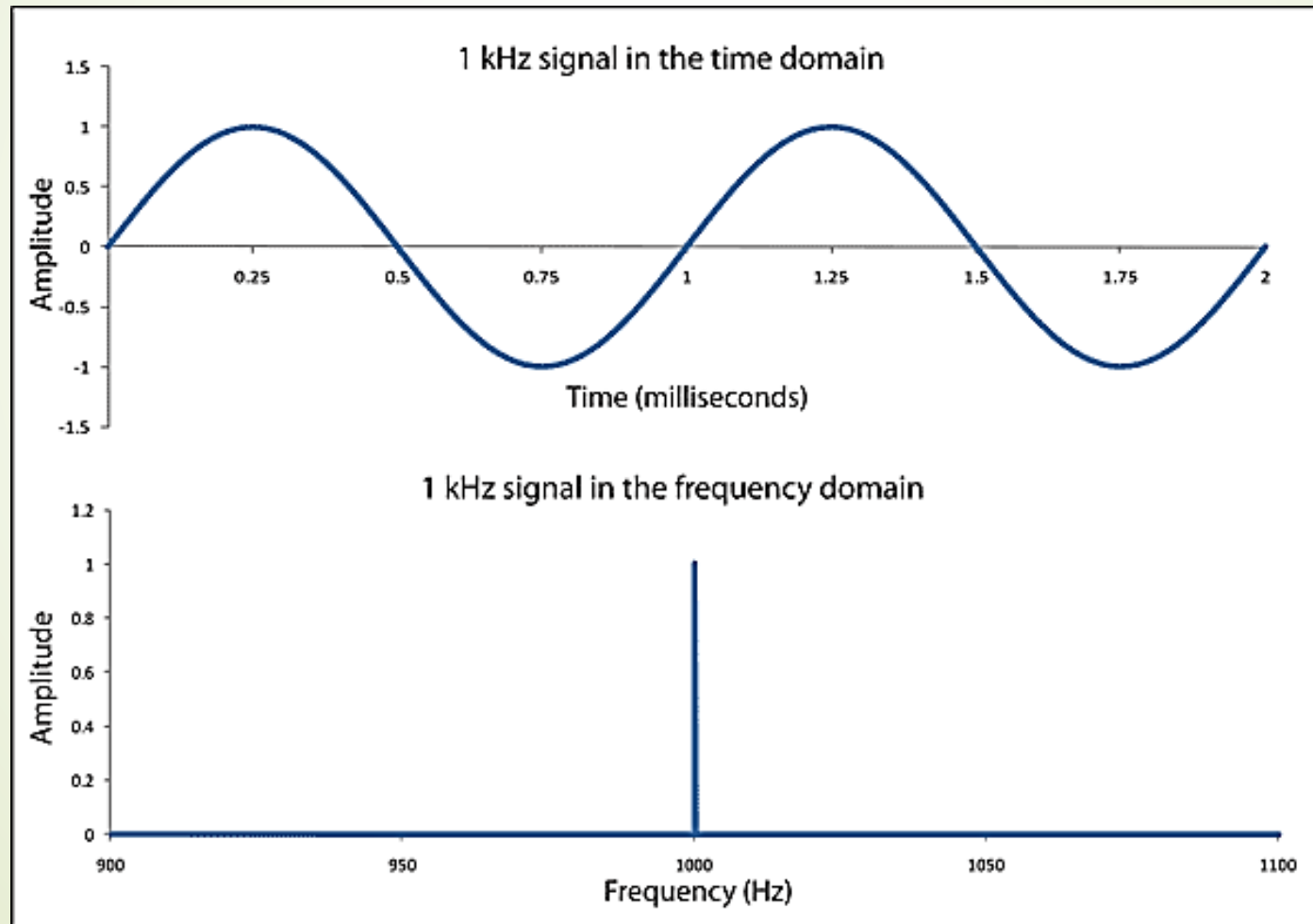

# Time & Frequency Domains

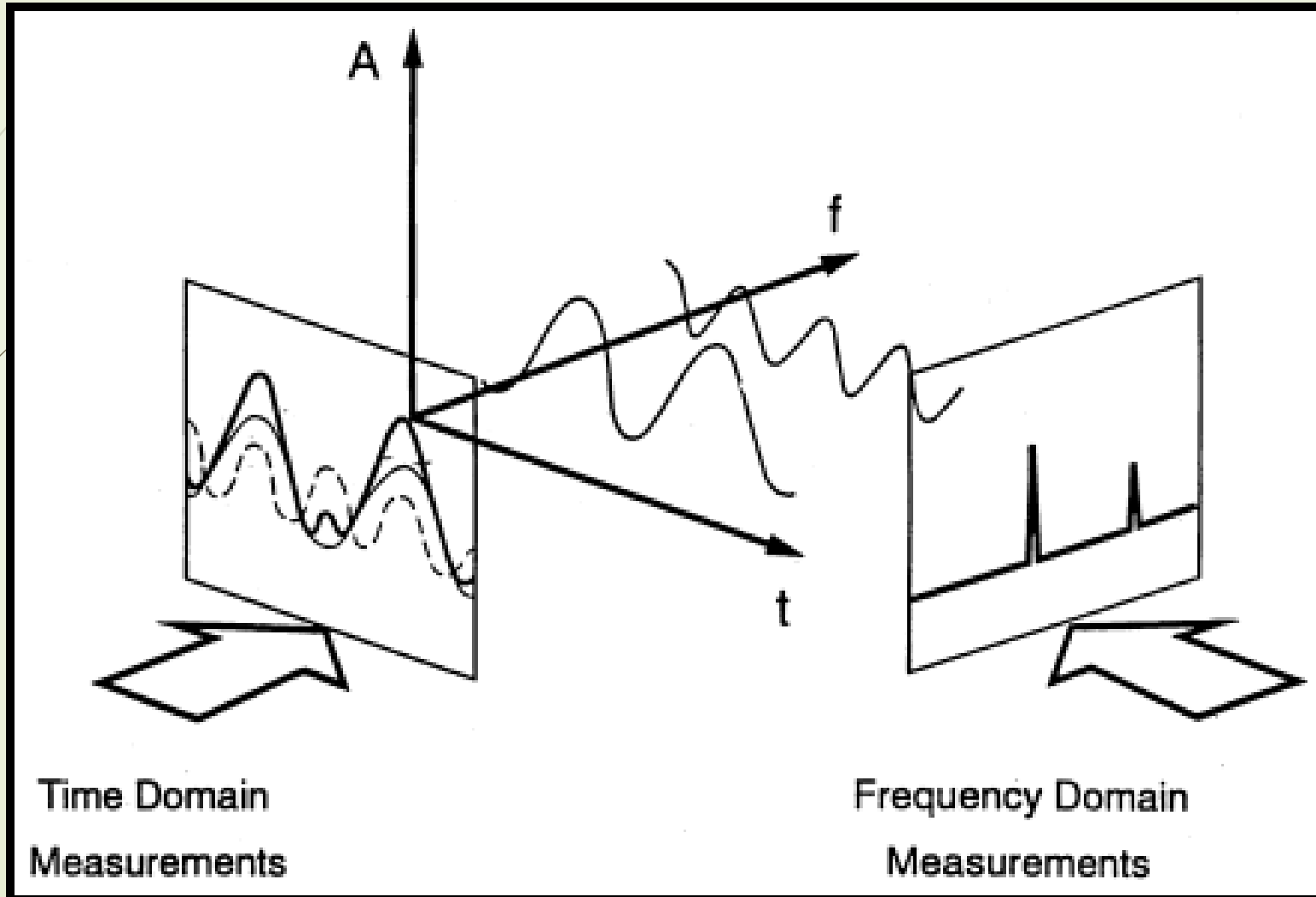

# Signal & Spectrum

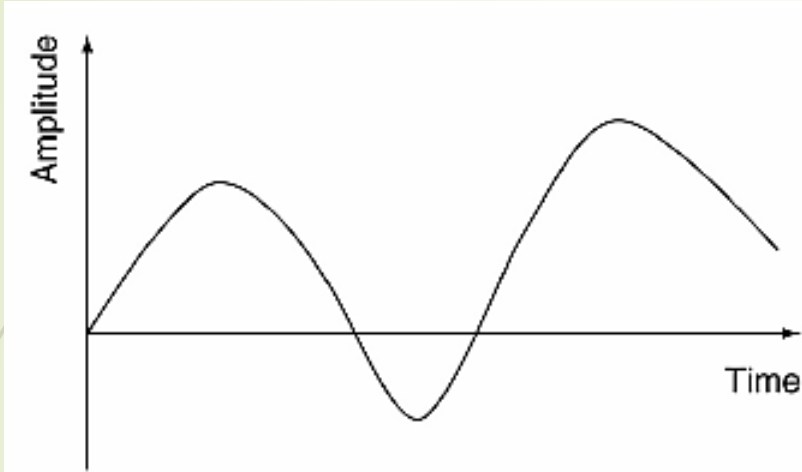

(a) Signal

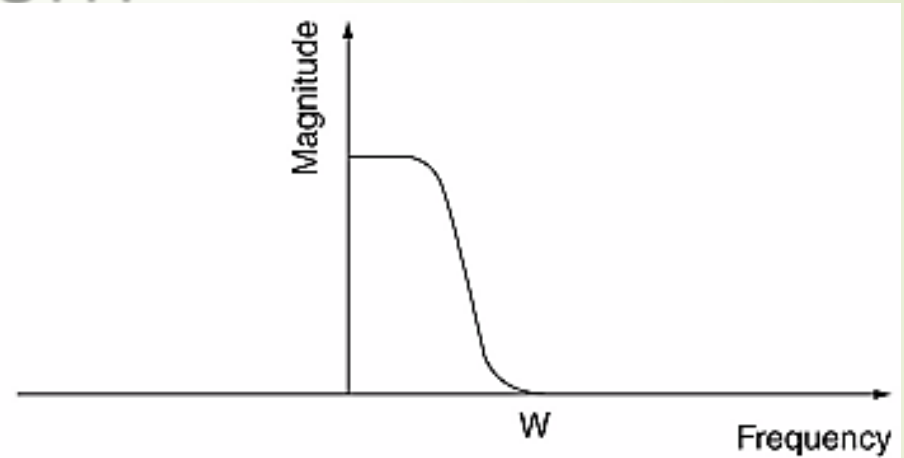

(b) One-Sided Spectrum of Signal

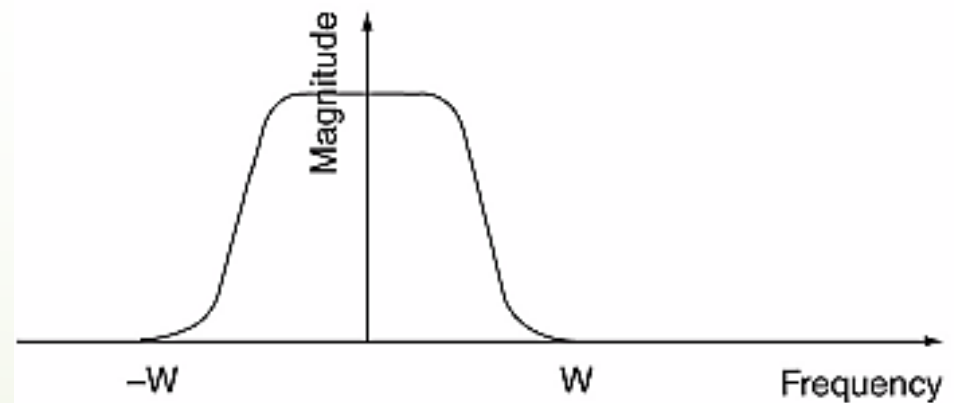

(c) Two-Sided Spectrum of Signal



# Frequency Range of Analog & Digital Signals

33

- ▶ For analog signals, the frequency range is from  **$-\infty$  Hz to  $\infty$  Hz**
- ▶ For digital signals, the frequency range is from **0 Hz to  $F_s/2$  Hz**

# Sampling Effect in Frequency Domain

34

- ▶ Sampling causes images of a signal's spectrum to appear at every multiple of the sampling frequency  $f_s$ .
- ▶ For a signal with frequency  $f$ , the sampled spectrum has frequency components at  $kf_s \pm f$

# Sampling Effect in Frequency Domain

35

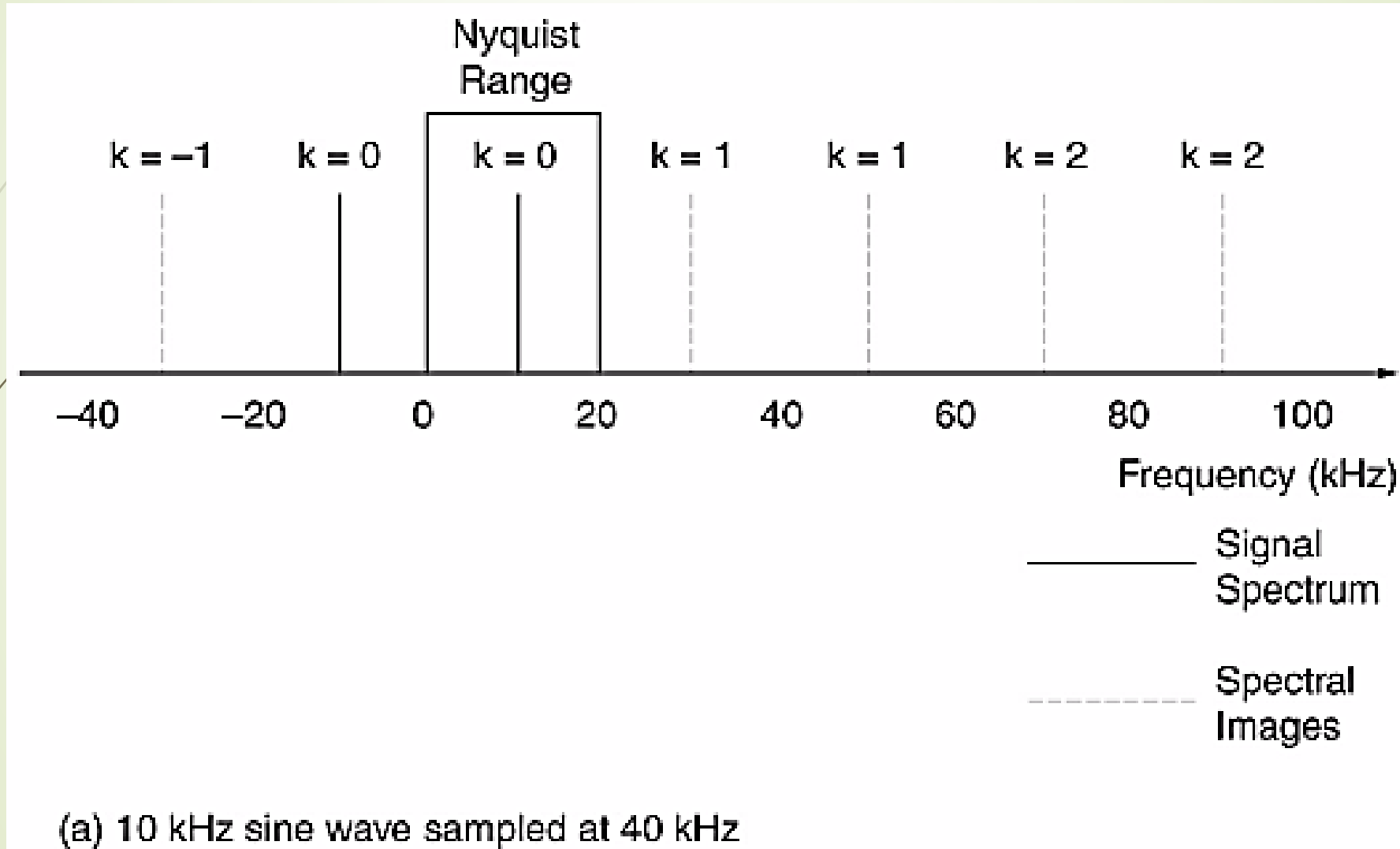

# Sampling Effect in Frequency Domain

36

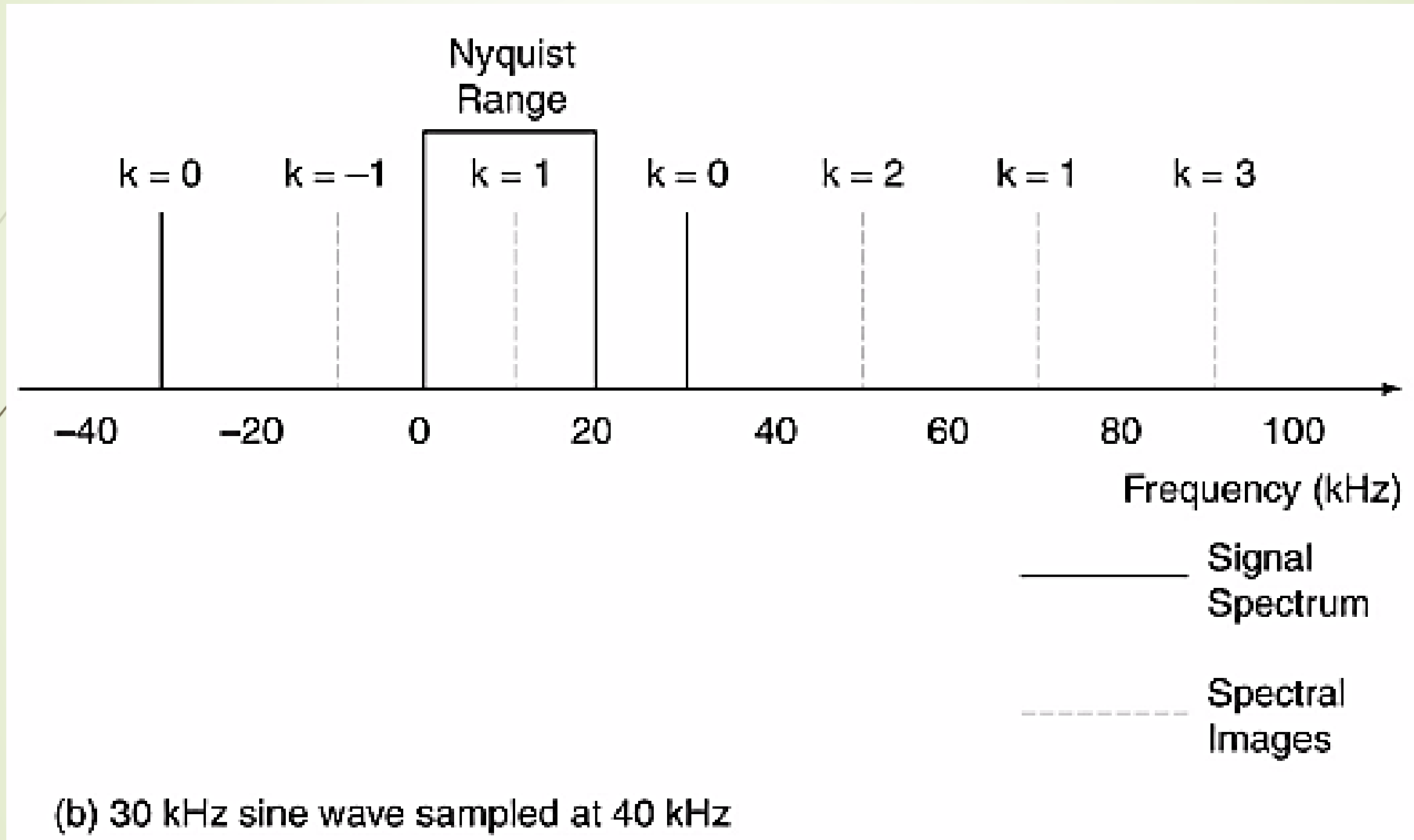

# Anti Aliasing Filter

- ▶ A signal with no frequency component above a certain maximum frequency is known as a band-limited signal.
- ▶ In our case we want to have a signal band-limited to  $\frac{1}{2} F_s$ .
- ▶ Some times higher frequency components (both harmonics and noise) are added to the analog signal (practical signals are not band-limited).
- ▶ In order to keep analog signal band-limited, we need a filter, usually a low pass that stops all frequencies above  $\frac{1}{2} F_s$ .
- ▶ This is called an “*Anti-Aliasing*” filter.

# Anti Aliasing Filter

- ▶ Anti-aliasing filters are analog filters.
- ▶ They process the signal before it is sampled.
- ▶ In most cases, they are also low-pass filters unless band-pass sampling techniques are used.

# Under Sampling

- ▶ If the sampling rate is lower than the required Nyquist rate, that is  $f_s < 2W$ , it is called **under sampling**.
- ▶ In under sampling images of high frequency signals erroneously appear in the baseband (or Nyquist range) due to aliasing.

# Sampling of Band Limited Signals

Signals whose frequencies are restricted to a narrow band of high frequencies can be sampled at a rate similar to twice the Bandwidth (BW) instead of twice the maximum frequency.

$$F_s \geq BW$$



# Sampling of Band Limited Signals

- ▶ While this under-sampling is normally avoided, it can be exploited.
- ▶ For example, in the case of band limited signals all of the important signal characteristics can be deduced from the copy of the spectrum that appears in the baseband through sampling.
- ▶ Depending on the relationship between the signal frequencies and the sampling rate, spectral inversion may cause the shape of the spectrum in the baseband to be inverted from the true spectrum of the signal.

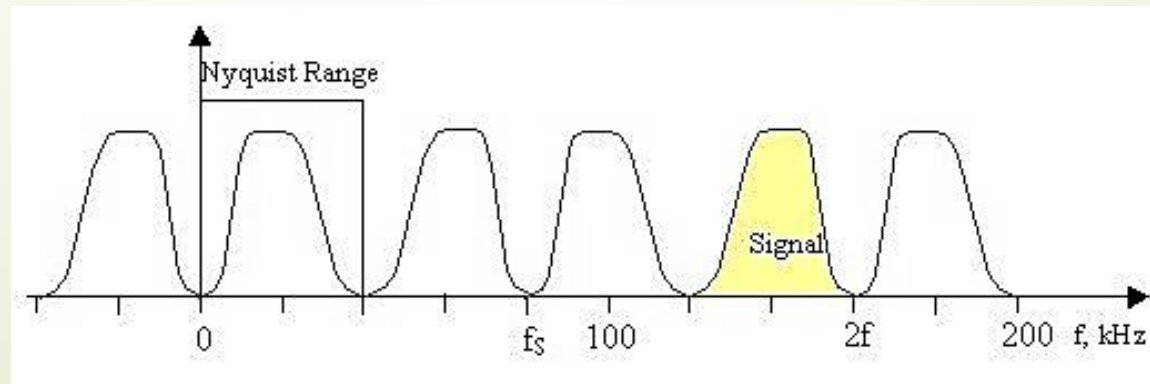

# Sampling of Band Limited Signals

**Figure:** Signal recovered from Nyquist range are Base band versions of the Original signal. Sampling rate is Important to make sure no aliasing and spectral inversion occurs.

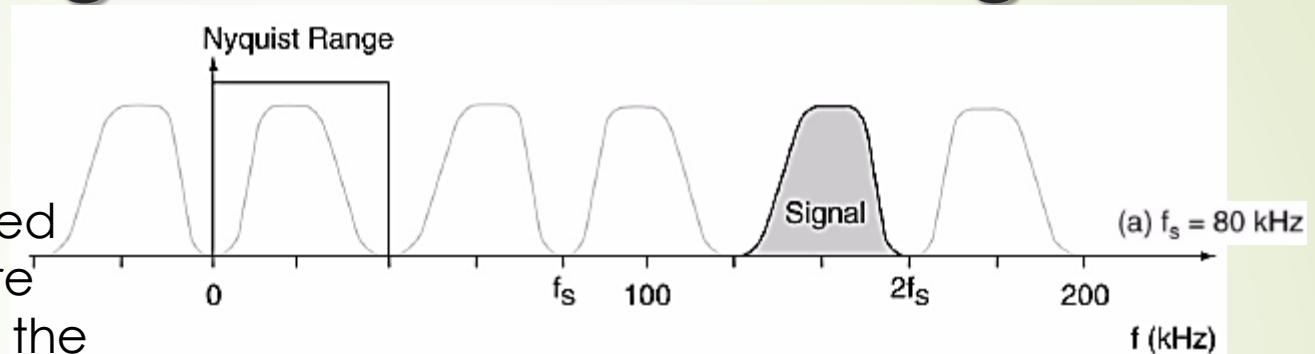

(a)  $F_s = 80$  kHz, signal spectrum is Inverted in the baseband.

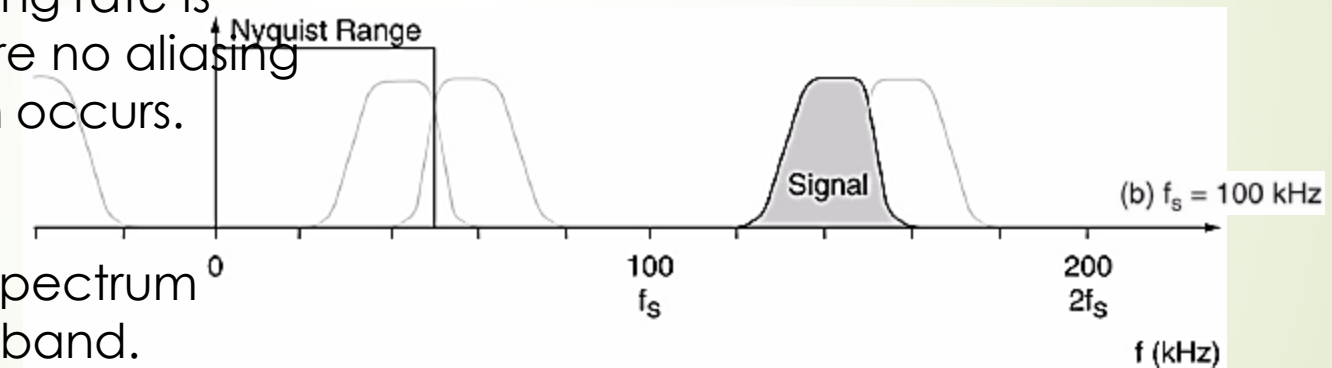

(b)  $F_s = 100$  kHz, the lowest Frequencies In the signal alias to the highest frequencies.

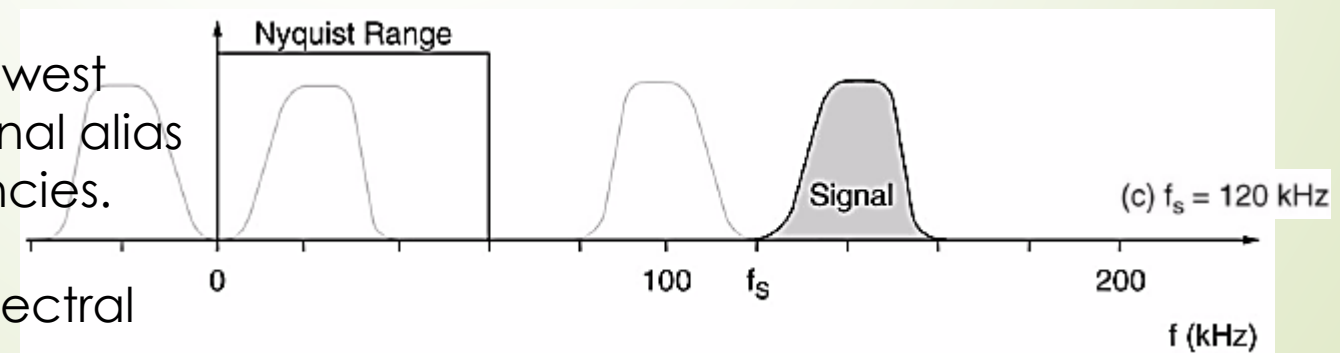

(c)  $F_s = 120$  kHz, No spectral Inversion occurs.

# Over Sampling

- Oversampling is defined as sampling above the minimum Nyquist rate, that is,  $f_s > 2f_{\max}$ .
- Oversampling is useful because it creates space in the spectrum that can reduce the demands on the analog anti-aliasing filter.

# Over Sampling

- In the example below, 2x oversampling means that a low order analog filter is adequate to keep important signal information intact after sampling.
- After sampling, higher order digital filter can be used to extract the informat

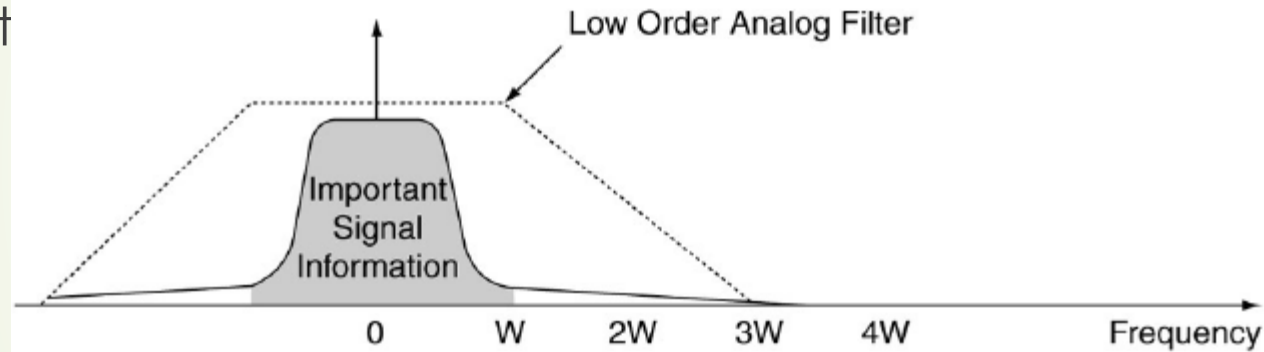

(a) Analog Filtering Before Sampling

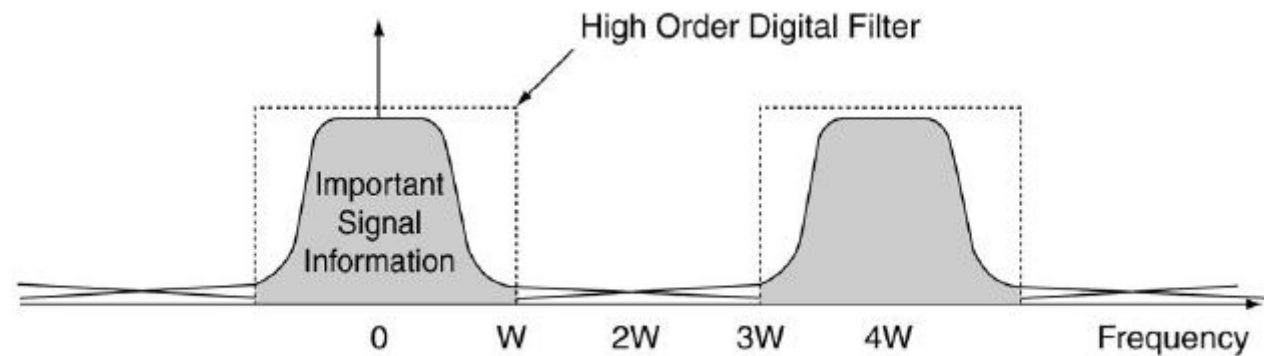

(b) Digital Filtering After Sampling

# Over Sampling

- ▶ The ideal filter has a flat pass-band and the cut-off is very sharp, since the cut-off frequency of this filter is half of that of the sampling frequency, the resulting replicated spectrum of the sampled signal do not overlap each other. Thus no aliasing occurs.
- ▶ Practical low-pass filters cannot achieve the ideal characteristics.
- ▶ Firstly, this would mean that we have to sample the filtered signals at a rate that is higher than the Nyquist rate to compensate for the transition band of the filter

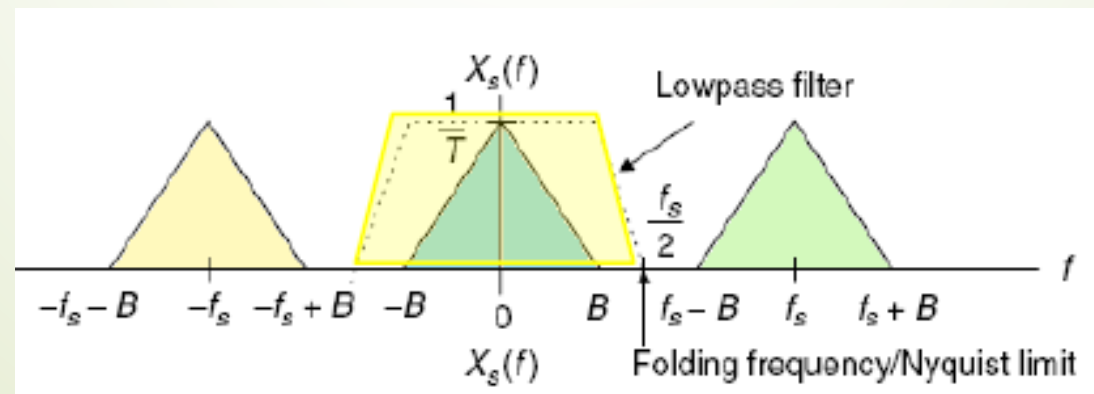

# Spectra of Sampled signals

**Figure:** Signal 's Spectra

- (i) Over sampled
- (ii) Nyquist Rate
- (iii) Under Sampled

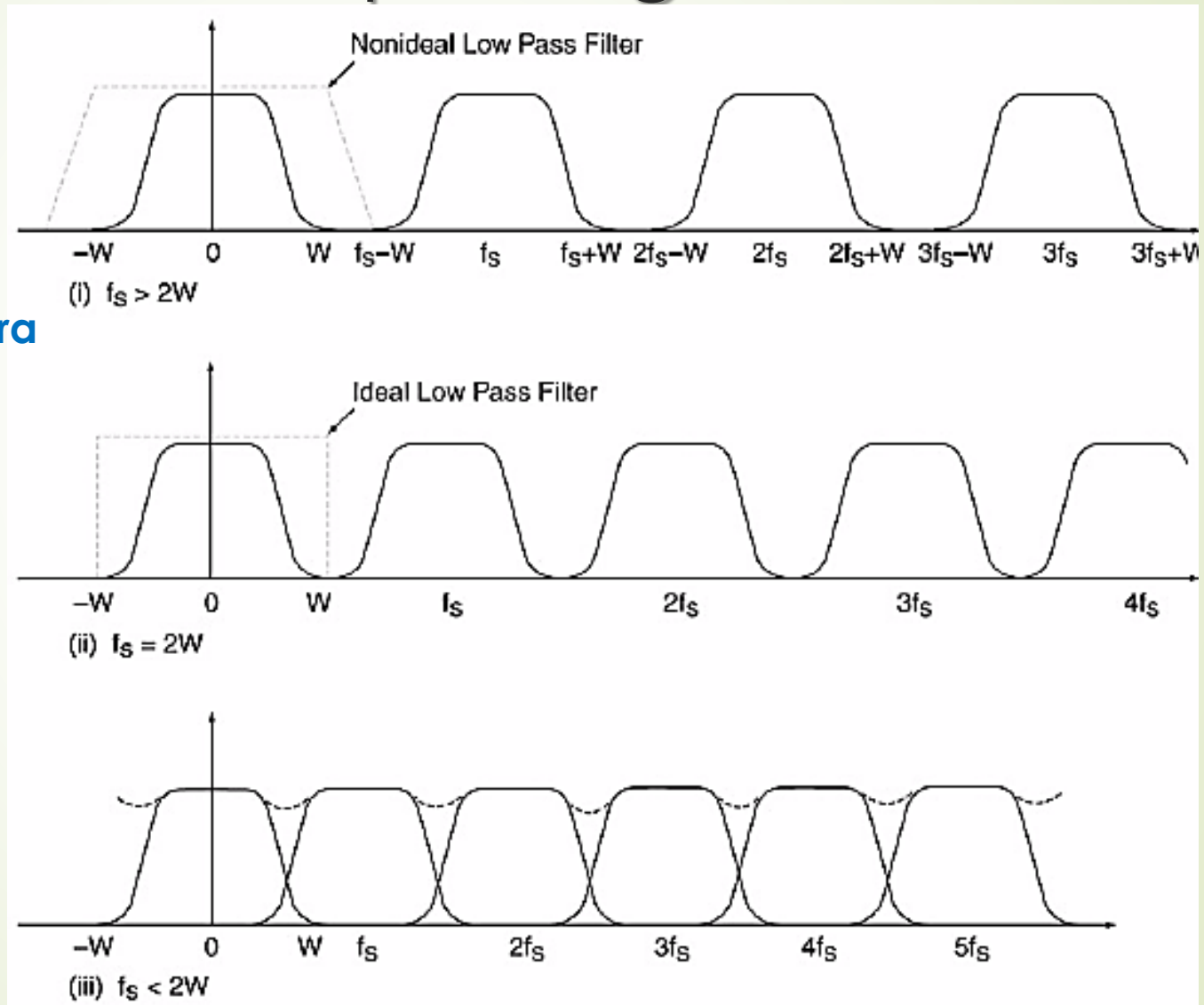

# Sampling Low Pass Signals

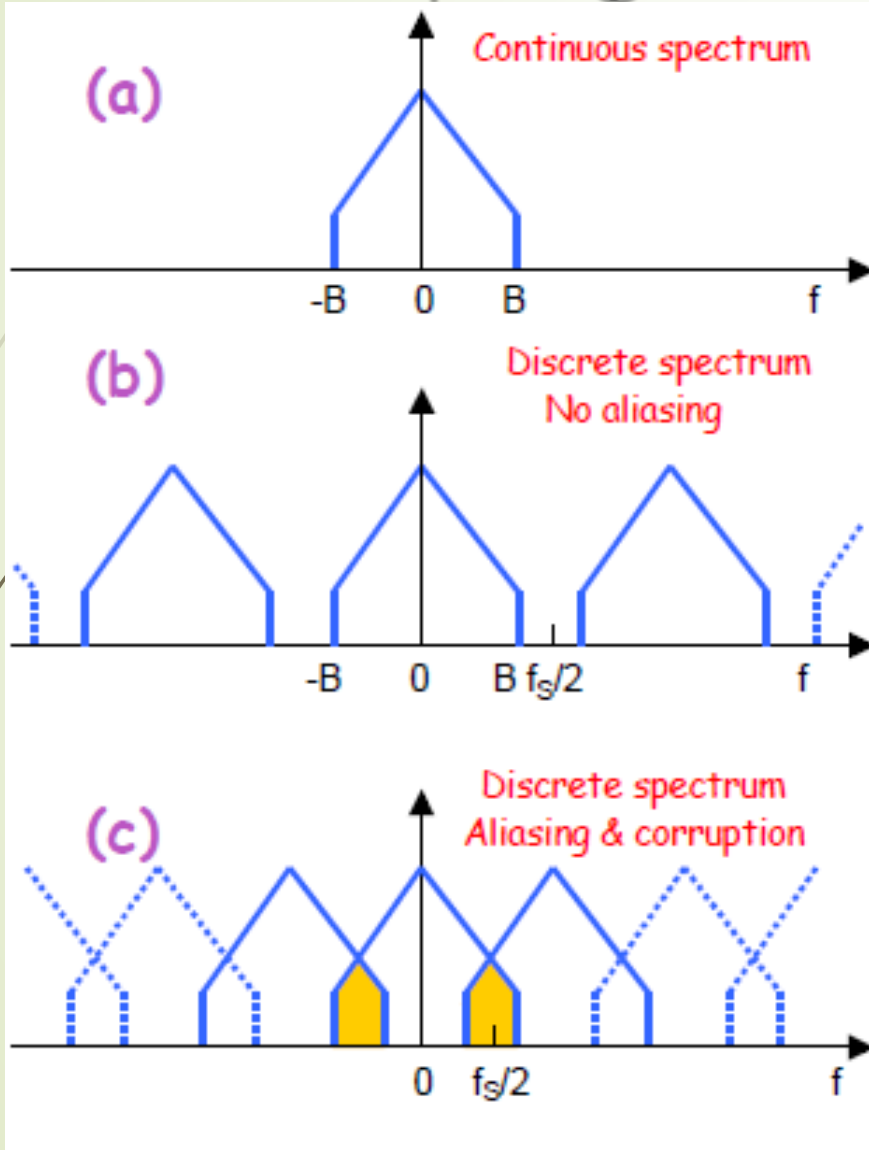

(a) Band-limited signal:  
frequencies in  $[-B, B]$  ( $f_{\text{MAX}} = B$ ).

(b) Time sampling  $\Rightarrow$  frequency repetition.

$f_s > 2B \Rightarrow$  no aliasing.

(c)  $f_s \leq 2B \Rightarrow$  **aliasing!**

**Aliasing: signal ambiguity  
in frequency domain**

# Exercise

**Exercise-1:** If the 20 kHz signal is under-sampled at 30 kHz, find the aliased frequency of the signal.

**Exercise-2:** A voice signal is sampled at 8000 samples per second.

- i. What is the time between samples?
- ii. What is the maximum frequency that will be recovered from the signal?

**Exercise-3:** An analog Electromyogram (EMG) signal contains useful frequencies up to 3000 Hz.

- i. Determine the minimum required sampling rate to avoid aliasing.
- ii. Suppose that we sample this signal at a rate of 6500 samples/s. what is the highest frequency that can be represented uniquely at this sampling rate?



# Exercise

**Exercise-4:** Humans can hear sounds at frequencies between 0 and 20 kHz. What minimum sampling rate should be chosen to permit perfect recovery from samples?

**Exercise-5:** An ECG signal is sampled at 250 samples per second.

- i. What is the time between samples?
- ii. What is the maximum frequency that will be recovered from the signal?

**Exercise-6:** An ultrasound signal ranging in frequency from 900 kHz to 900.5 kHz is under-sampled at 200 kHz. If a 200 Hz target appears in the baseband, what is the actual frequency of the target?

# Analog to Digital Conversion

## Quantizer

- ▶ After the sampling, the discrete time continuous signal still carry infinite information (can take any value) in terms of amplitude.
- ▶ Quantization is the process to reduce infinite information of the amplitude.
- ▶ Quantizer do the conversion of discrete time continuous valued signal into a discrete-time discrete-value signal.
- ▶ The value of each signal sample is represented by a value selected from a finite set of possible values.

# Analog to Digital Conversion

## Quantizer

- ▶ The A/D converter chooses a quantization level for each analog sample.
- ▶ Number of levels of quantizer is equal to  $L = 2^N$
- ▶ An N-bit converter chooses among  $2^N$  possible quantization levels.
- ▶ So 3 bit converter has 8 quantization levels, and 4 bit converter has 8 quantization levels.

# Analog to Digital Conversion

The quantization step size or resolution is calculated as:

$$\Delta = Q = R/2^N$$

where

**R** is the full scale range of the analog signal (i.e.  $Y_{\max} - Y_{\min}$ )

**N** is the number of bits used by the converter

- Resolution of a quantizer is the distance between two successive quantization levels
- More quantization levels, a better resolution!
- What's the downside of more quantization levels?

The strength of the signal compared to that of the quantization errors is measured by dynamic range and signal-to-noise ratio.

# Analog to Digital Conversion

## 4-bit Quantizer

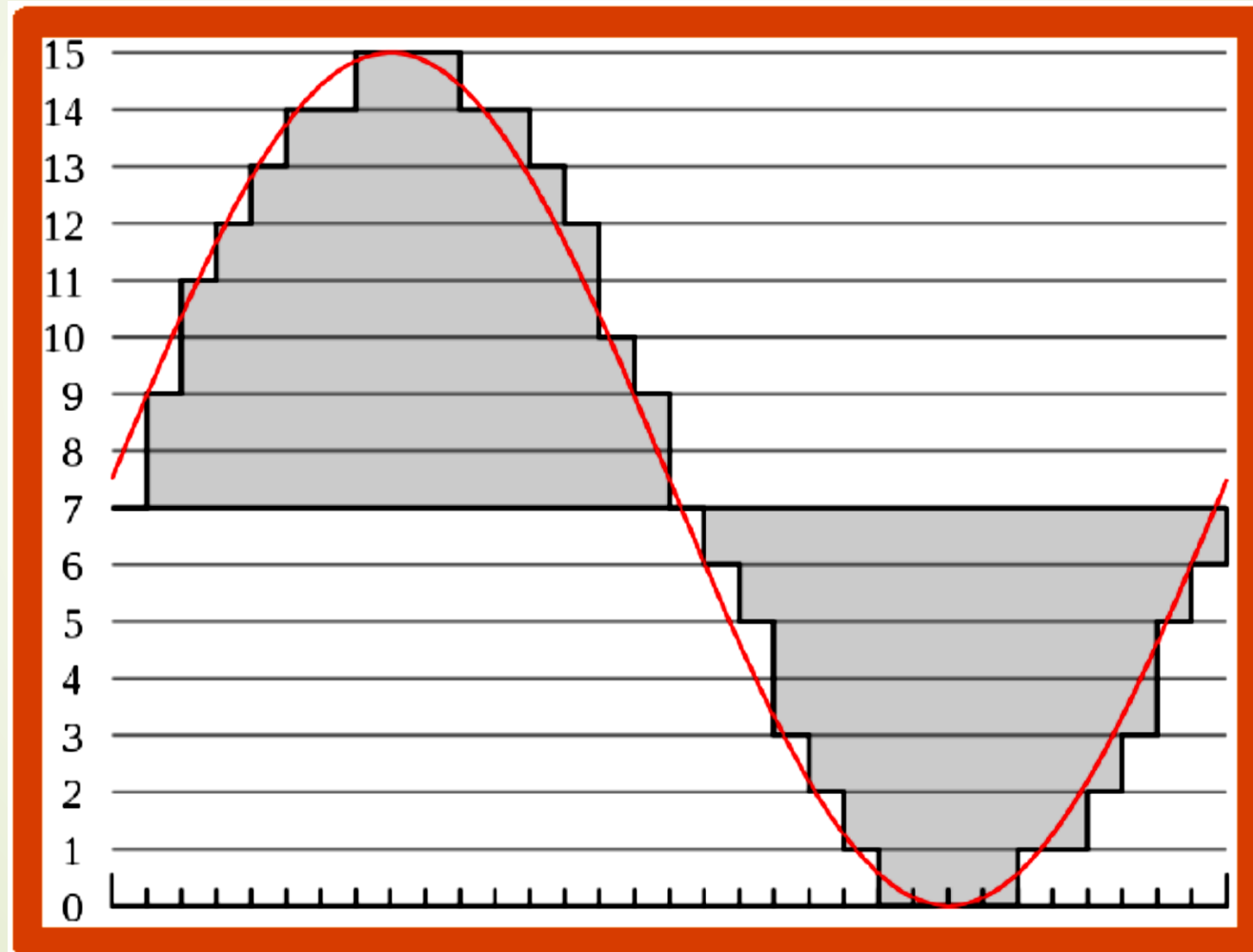

# Analog to Digital Conversion

## 4-bit Quantizer

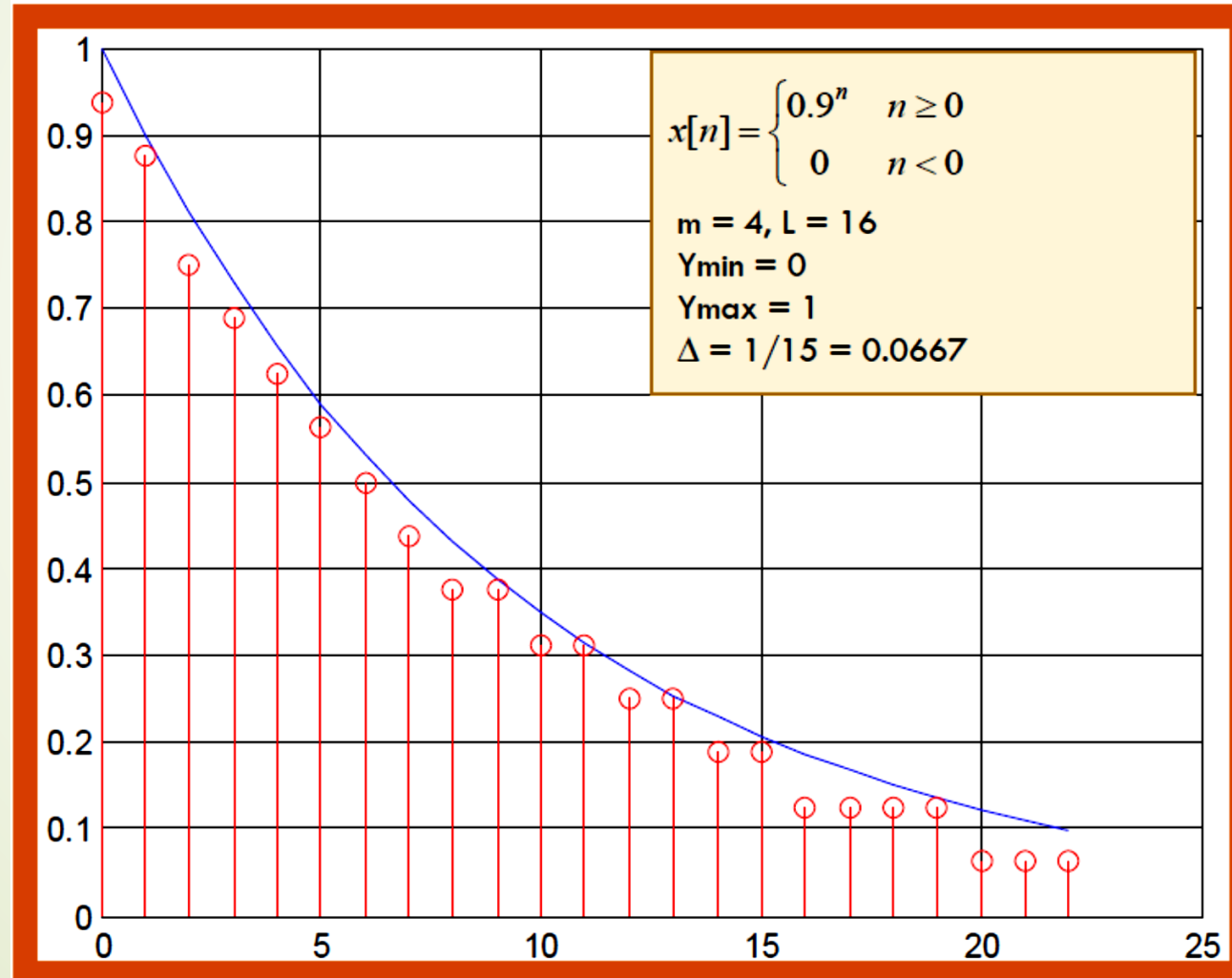

# Quantization Error

- ▶ The error caused by representing a continuous-valued signal (infinite set) by a finite set of discrete-valued levels.
- ▶ The larger the number of quantization levels, the smaller the quantization errors.
- ▶ The quantization error is calculated as the difference between the quantized level and the true sample level.
- ▶ Most quantization errors are limited in size to half a quantization step  $Q$  or  $\Delta$ .

# Quantization Error

- Suppose a quantizer operation given by  $Q(\cdot)$  is performed on continuous-valued samples  $x[n]$  is given by  $Q(x[n])$ , then the quantization error is given by

$$e_q[n] = x[n] - x_q[n]$$



# Analog to Digital Conversion

- Lets consider the signal which is to be quantized.

$$x[n] = \begin{cases} 0.9^n & n \geq 0 \\ 0 & n < 0 \end{cases}$$

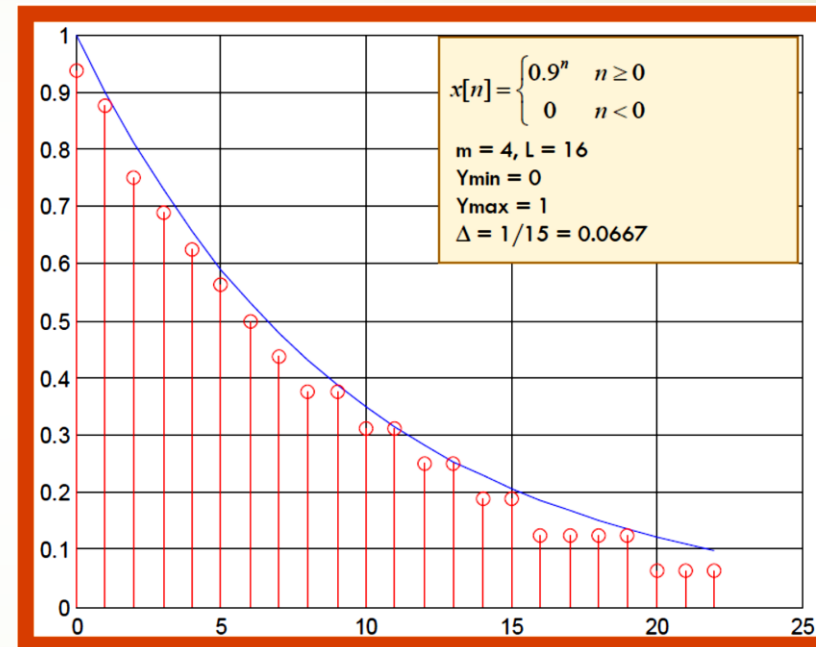

In the figure, we can see that there is a difference between the original signal (Blue Line) and the quantized signal (Red Lines). This is the error produced while quantization

# Analog to Digital Conversion

Quantization error can be reduced, however, if the number of quantization levels is increased as illustrated in the figure

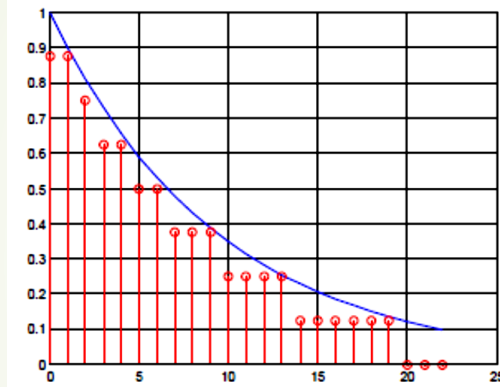

3-bit ADC

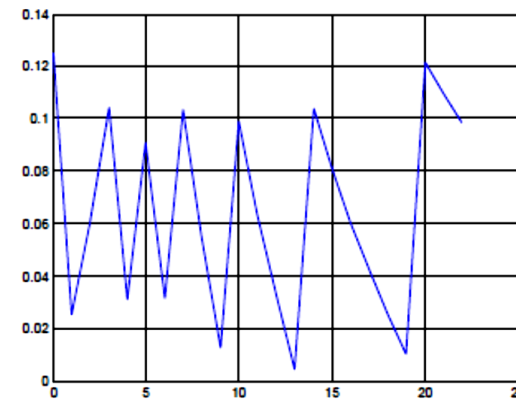

Quant. error

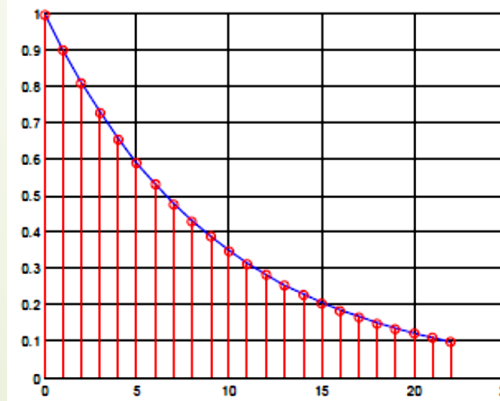

8-bit ADC

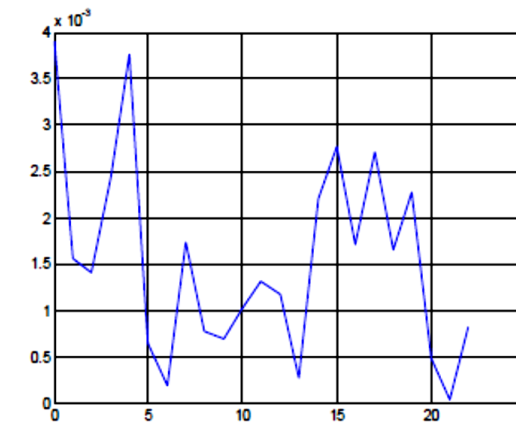

Quant. error

# Analog to Digital Conversion

Quantization of unipolar data (maximum error = full step)

## □ Unipolar Quantizer

A unipolar quantizer deals with analog signals ranging from 0 volt to a positive reference voltage.

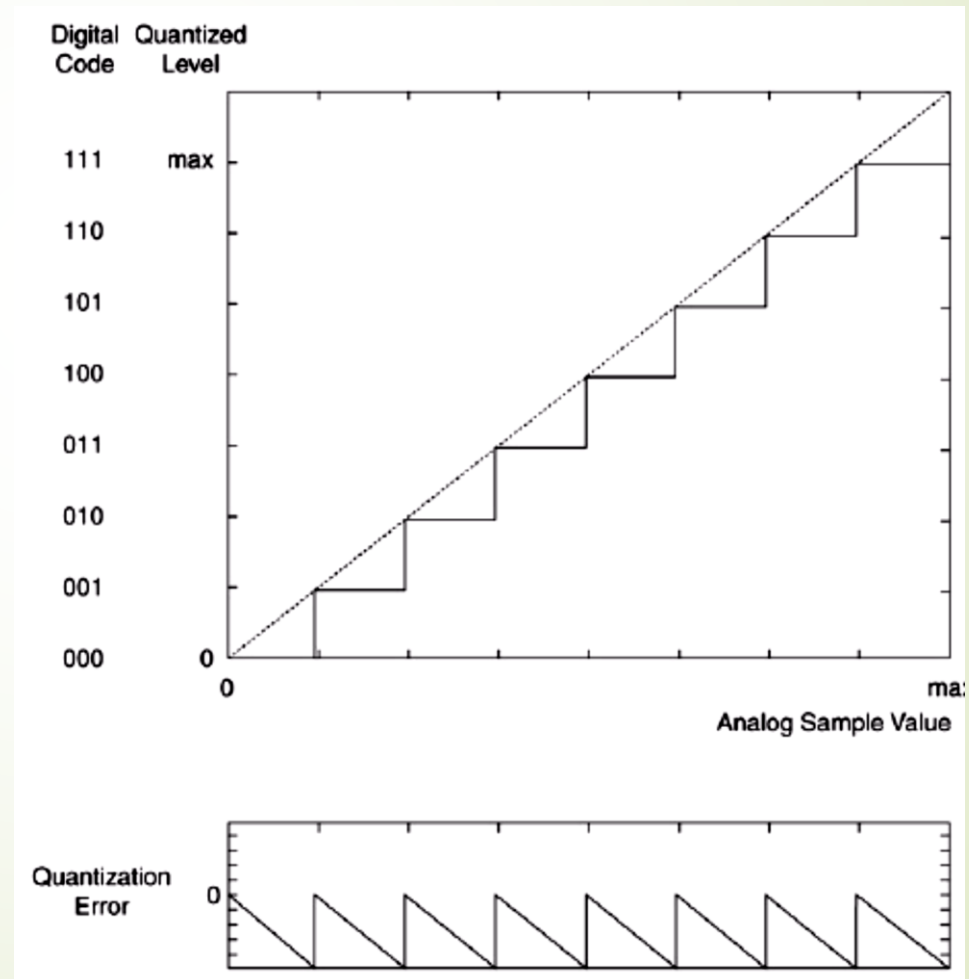

# Analog to Digital Conversion

Quantization of unipolar data (maximum error = half step)

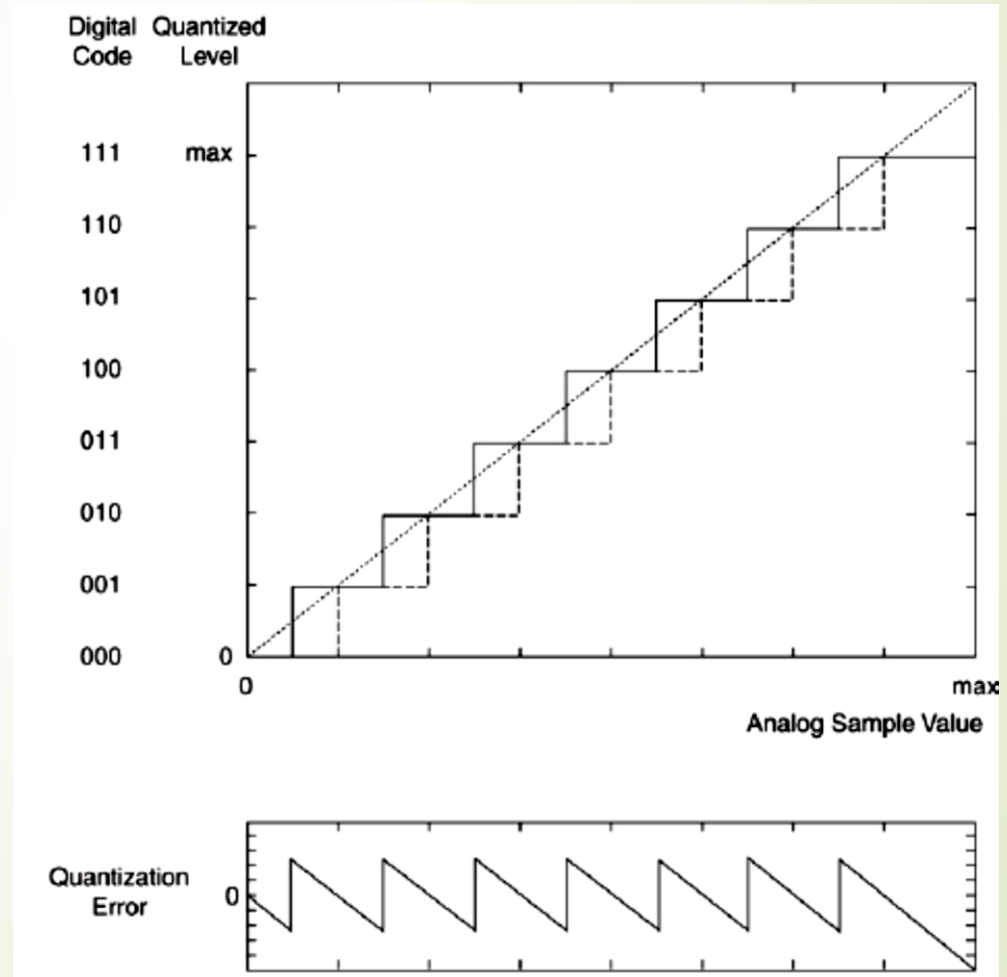

# Analog to Digital Conversion

**Example:** Analog pressures are recorded using a pressure transducer as voltages between 0 and 3 V. The signal must be quantized using a 3-bit digital code. Indicate how the analog voltages will be covered to digital values.

The quantization step size is

$$Q = 3 \text{ V} / 2^3 = 0.375 \text{ V}$$

The half of quantization step

$$0.1875 \text{ V}$$

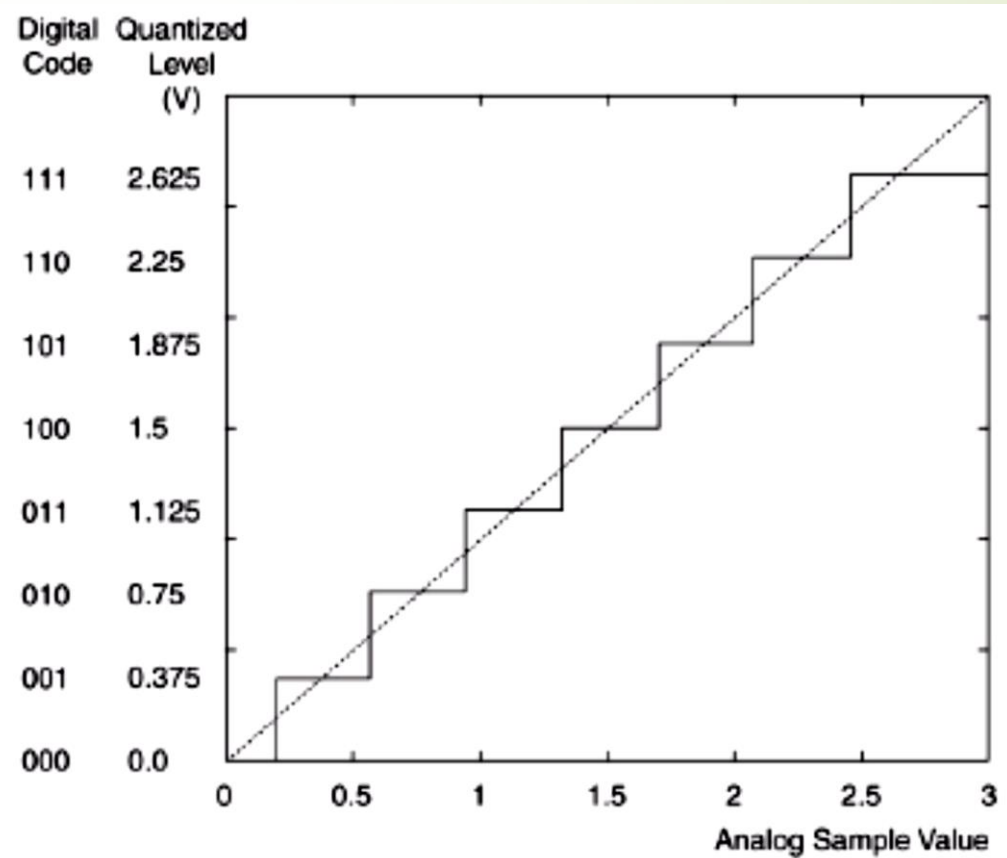

# Analog to Digital Conversion

Quantization of bipolar data (maximum error = half step)

## ▣ Bipolar Quantizer

A bipolar quantizer deals with analog signals ranging from a negative reference to a positive reference

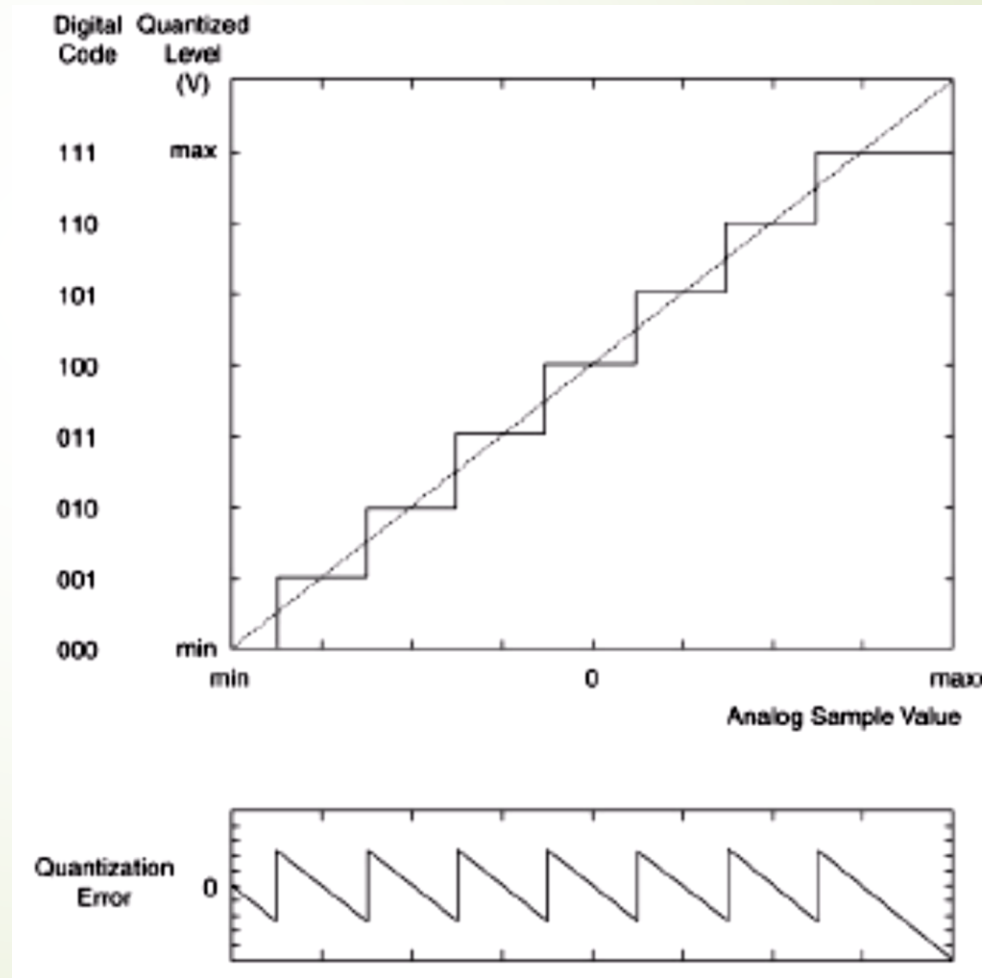

# Three-bit A/D Conversion

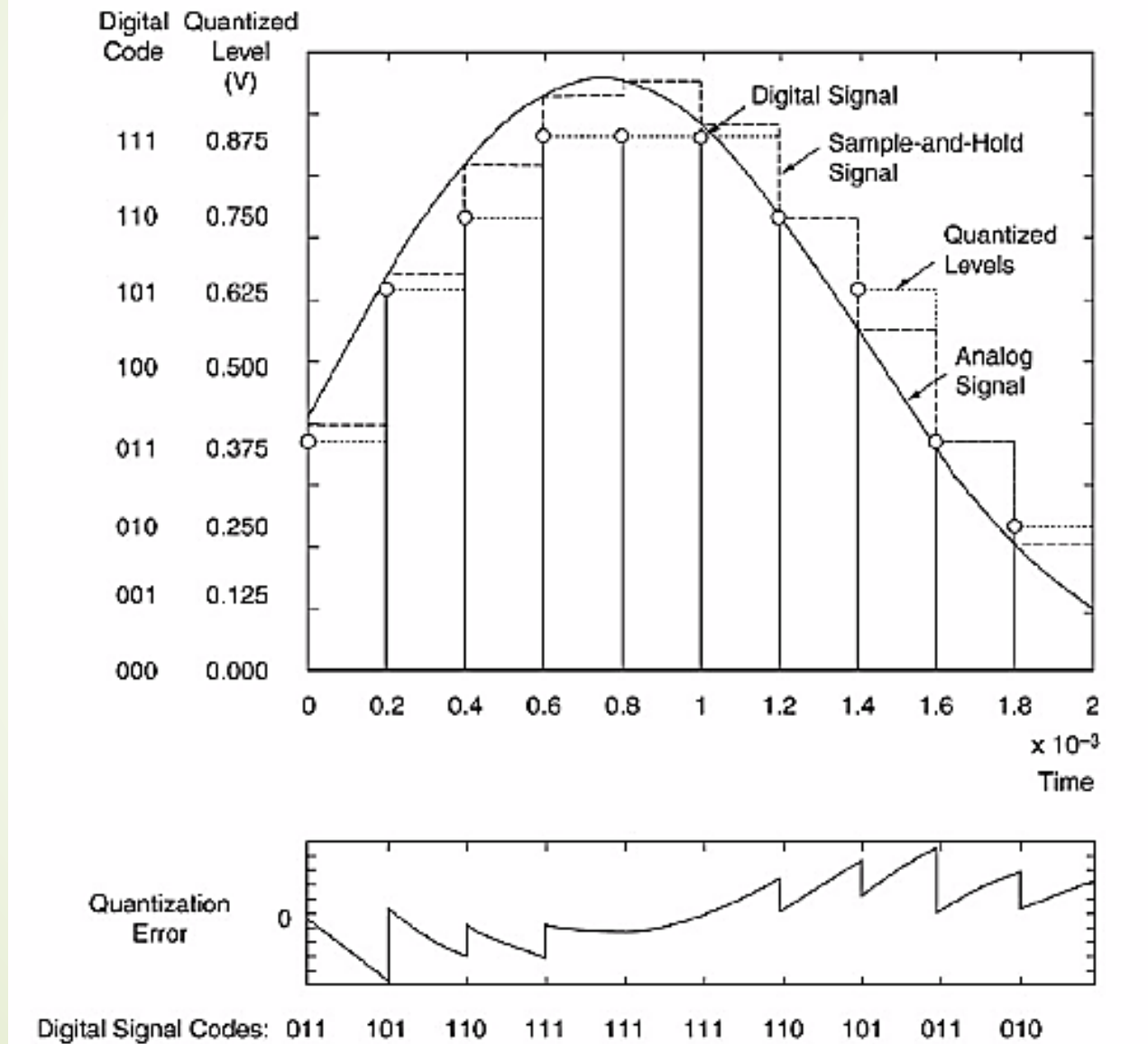

# Dynamic Range

- ▶ Quantization errors can be determined by the quantization step.
- ▶ Quantization errors can be reduced by increasing the number of bits used to represent each sample.
- ▶ Unfortunately these errors can not be entirely eliminated and their combined effect is called quantization noise.
- ▶ The dynamic range of the quantizer is the number of levels it can distinguish in noise.
- ▶ It is a function of the range of signal values and the range of error values, and is expressed in decibels, dB.
- ▶  $Dynamic\ Range = 20\log_2\left(\frac{R}{Q}\right)$



# Signal-to-Quantization-Noise Ratio

- Provides the ratio of the signal power to the quantization noise (or quantization error)

$$P_q = \frac{1}{N} \sum_{n=0}^{N-1} (e_q[n])^2 = \frac{1}{N} \sum_{n=0}^{N-1} (x[n] - x_q[n])^2$$

- Mathe

$$SQNR_{dB} = 10 \log_{10} \left( \frac{P_x}{P_q} \right)$$

where

- $P_x$  = Power of the signal 'x' (before quantization)
- $P_q$  = Power of the error signal 'x<sub>q</sub>'

# Analog to Digital Conversion

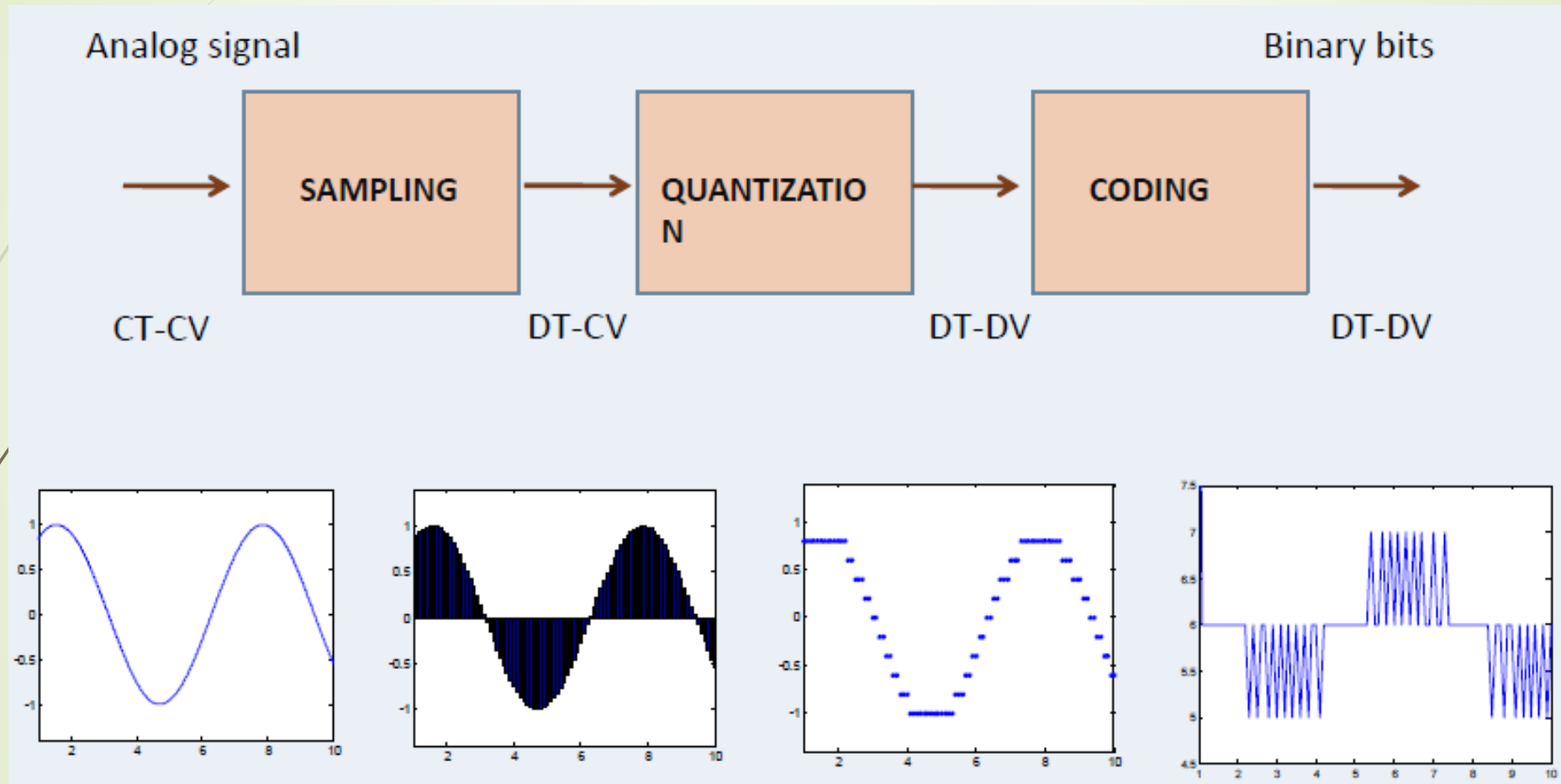

# 2 bit Flash ADC

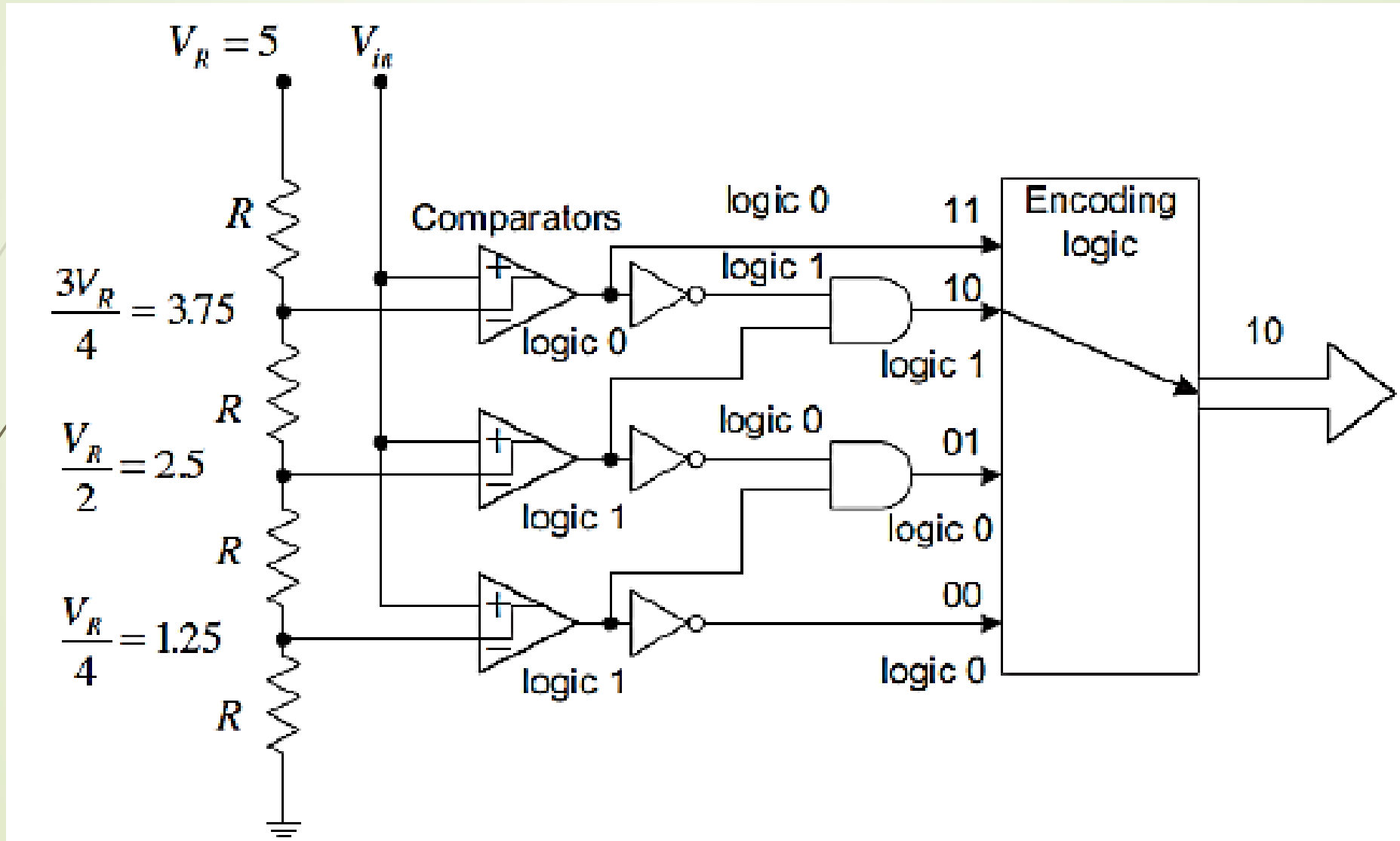

# Digital-to-Analog (D/A) Conversion

Block Diagram of D/A Conversion

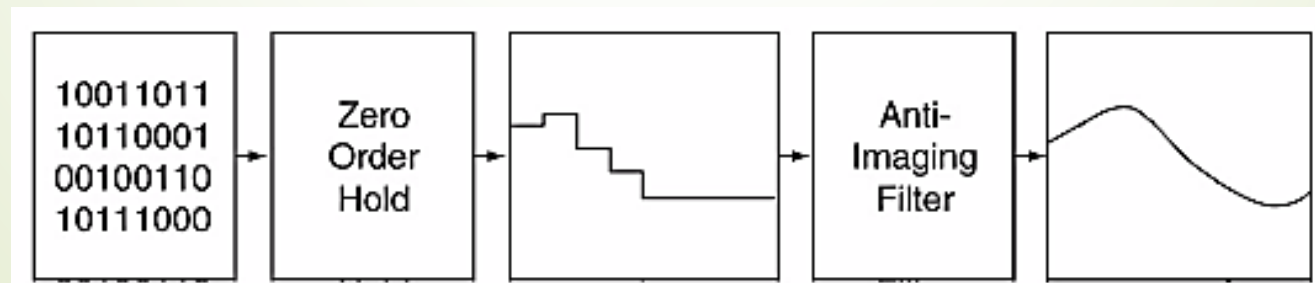
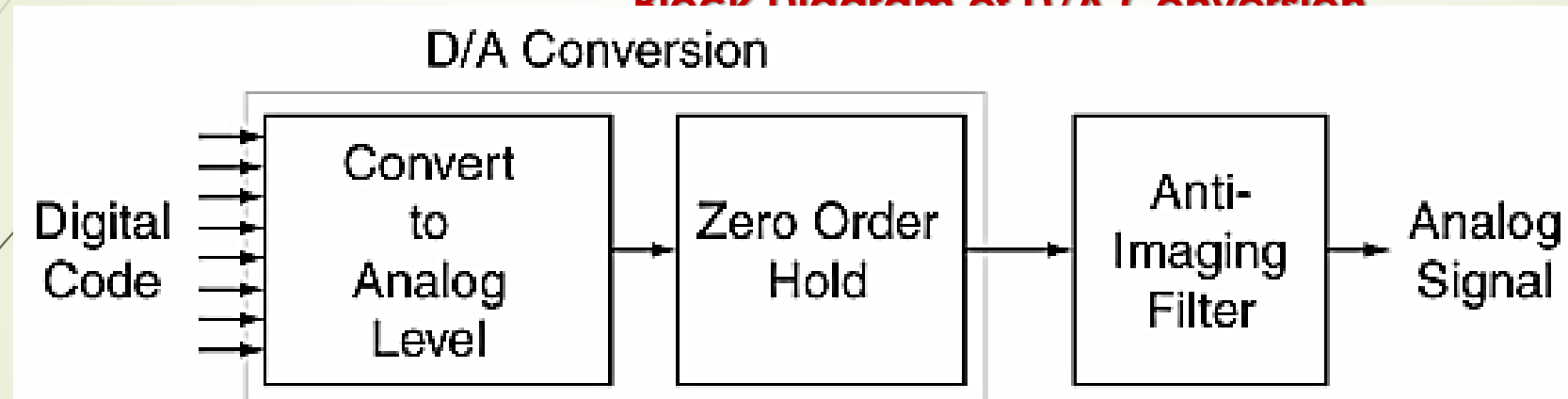

# Digital-to-Analog (D/A) Conversion

- ▶ Once digital signal processing is complete, digital-to-analog (D/A) conversion must occur.
- ▶ This process begins by converting each digital code into an analog voltage that is proportional in size to the number represented by the code.
- ▶ This voltage is held steady through zero order hold until the next code is available, one sampling interval later.
- ▶ This creates a staircase-like signal that contains frequencies above  $W$  Hz.
- ▶ These signals are removed with a smoothing analog low pass filter, the last step in D/A conversion.

# Digital-to-Analog (D/A) Conversion

- ▶ In the frequency domain, the high frequency elements present in the zero order hold signal appear as images, copies of the original signal spectrum situated around integer multiples of the sampling frequency.
- ▶ The smoothing analog filter removes these images and so is given the name of **Anti-Imaging Filter**.
- ▶ Only the frequencies in the baseband, between 0 and  $f_s/2$  Hz, remain.

# Digital-to-Analog (D/A) Conversion

## Three bit D/A Conversion

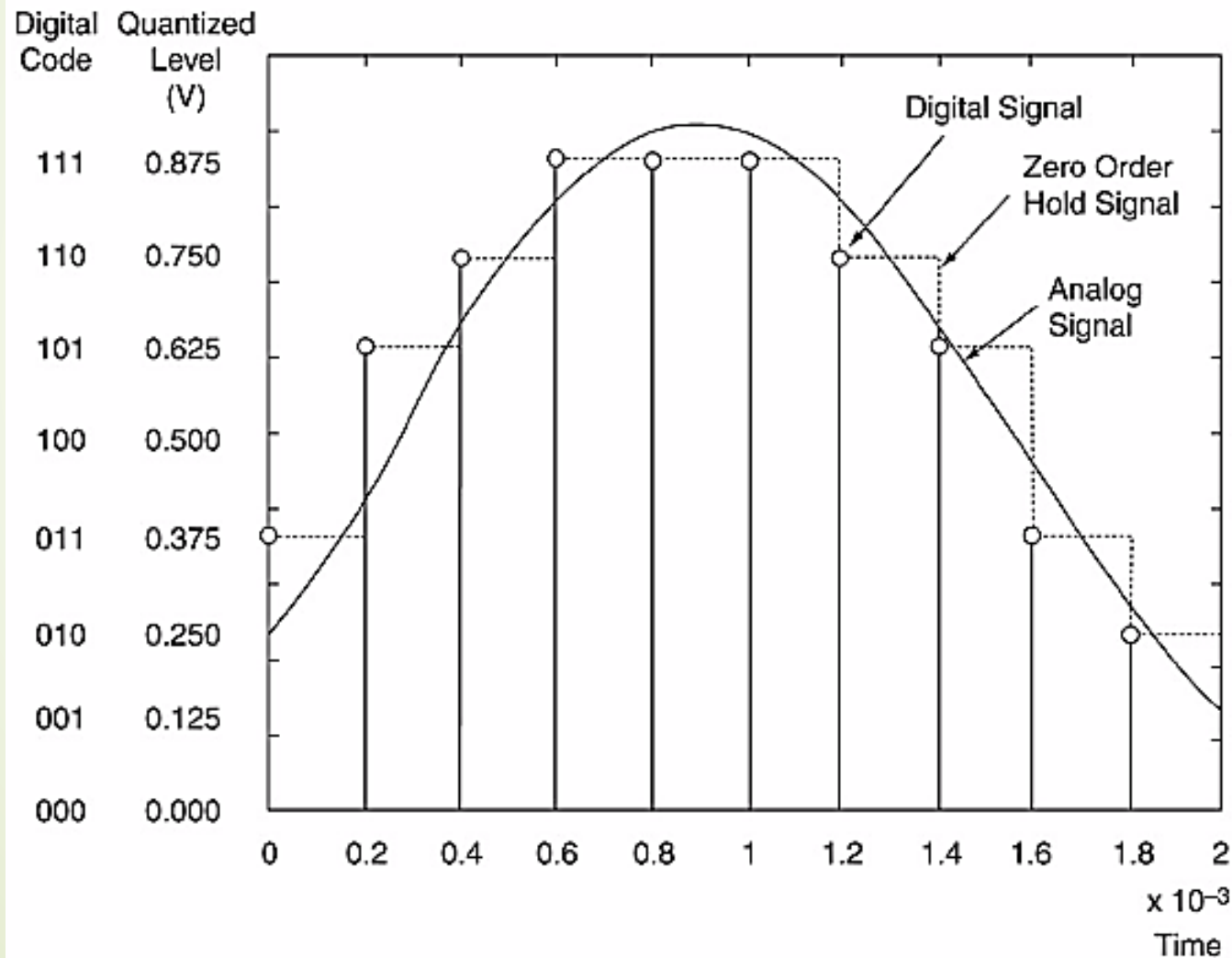

# Comparing Signals in the A/D & D/A Chain

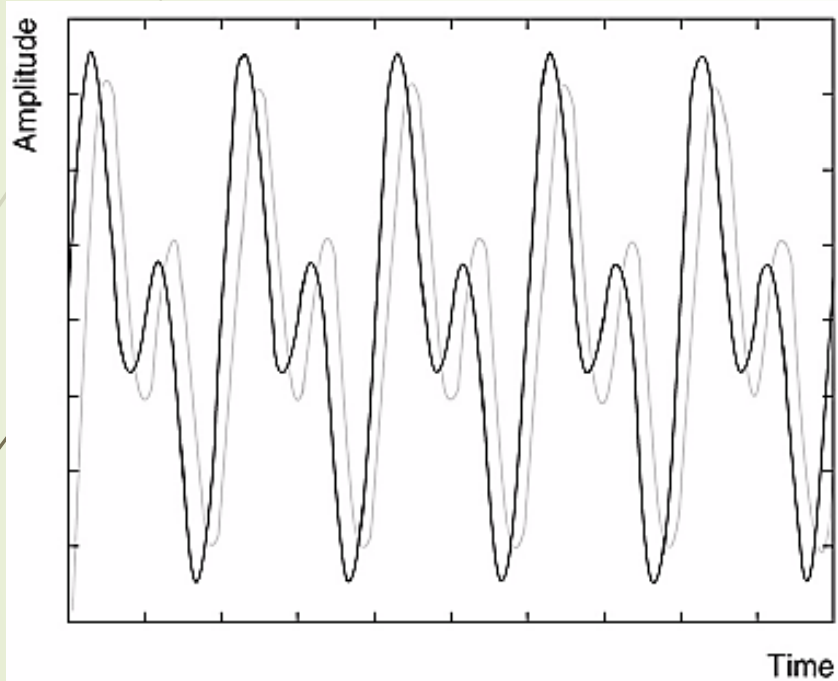

(a) Original Signal with Reconstructed Signal in Background

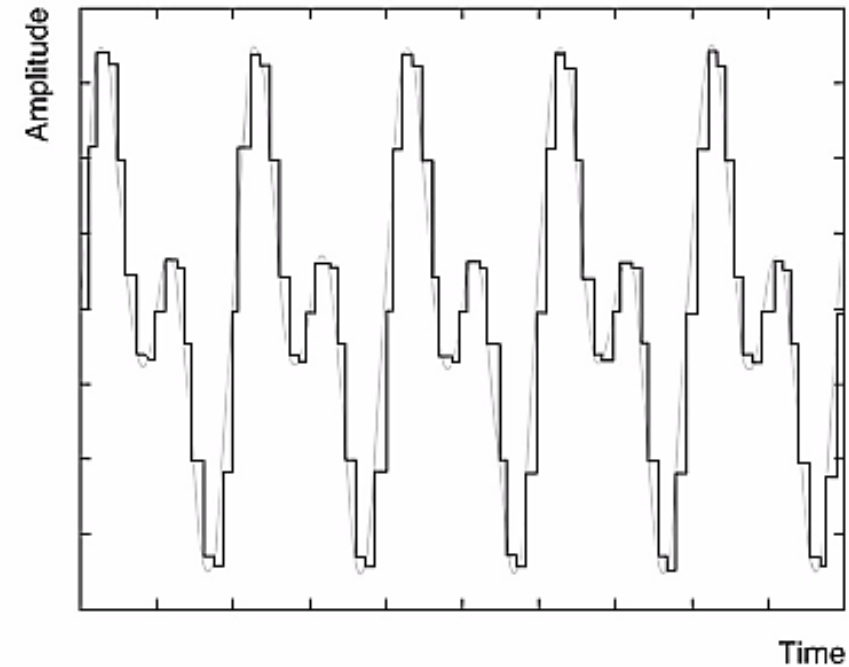

(b) Sample-and-Hold Signal with Original Signal in Background



# Comparing Signals in the A/D & D/A Chain

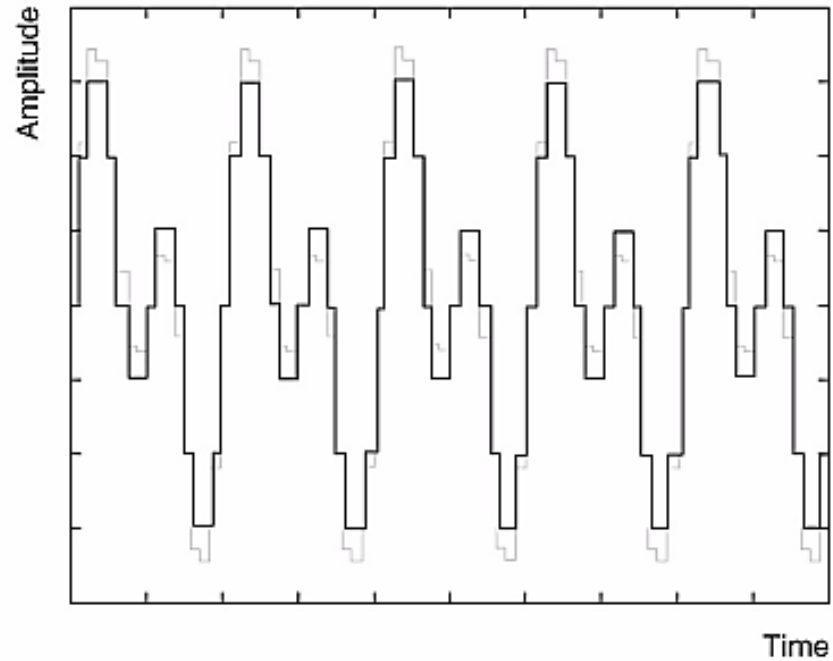

(c) Zero Order Hold Signal with Sample-and-Hold Signal in Background

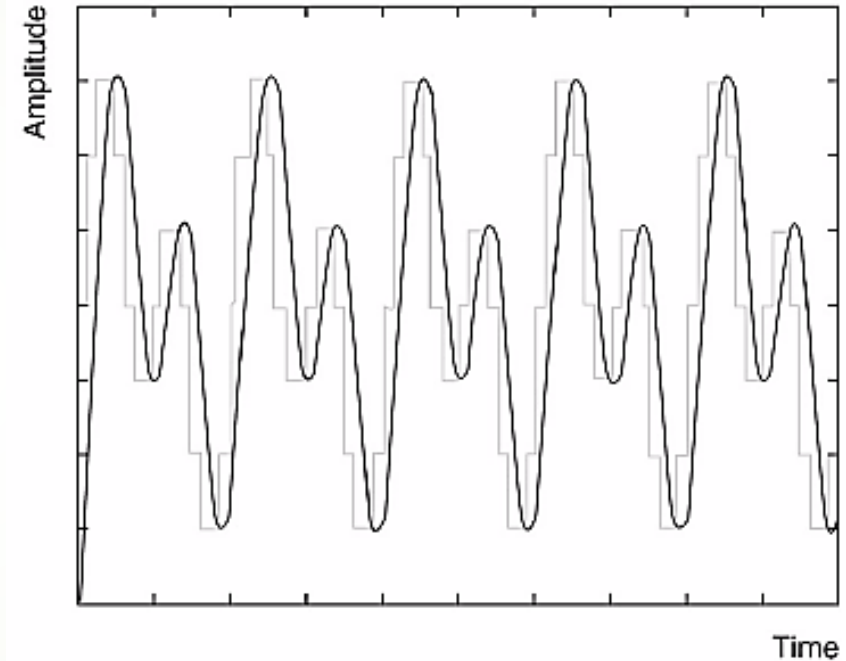

(d) Reconstructed Signal with Zero Order Hold Signal in Background

# Summary

- ❑ An analog signal is continuous in both time and amplitude. Analog signals in the real world include current, voltage, temperature, pressure, light intensity, and so on. The digital signal contains the digital values converted from the analog signal at the specified time instants.
- ❑ Analog-to-digital signal conversion requires an ADC unit (hardware) and a lowpass filter attached ahead of the ADC unit to block the high-frequency components that ADC cannot handle.
- ❑ The digital signal can be manipulated using arithmetic. The manipulations may include digital filtering, calculation of signal frequency content, and so on.

# Summary

- The digital signal can be converted back to an analog signal by sending the digital values to DAC to produce the corresponding voltage levels and applying a smooth filter (reconstruction filter) to the DAC voltage steps.
- Digital signal processing finds many applications in the areas of digital speech and audio, digital and cellular telephones, automobile controls, vibration signal analysis, communications, biomedical imaging, image/video processing, and multimedia.