

Watershed Hydrology

Abstractions from Precipitation

Interception



Before rainfall reaches to ground surface, a part of it caught by **plant foliage**, **buildings**, and **other objects**. The volume of water so caught is called interception. This water is subsequently removed from the surface through **evaporation**.

- Range: 2 mm to 0.5 mm
- Usually not significant for an isolated storm, but, when added over a period of time, it can be significant.
- Total interception is dependent on the storm duration, intensity of the storm, season, vegetation characteristics (canopy density, age, condition and species)



Interception losses are described by the following equation:

$$L_i = S + K.E.t$$

Where,

L_i is the total volume of water intercepted, S is the interception storage (0.25-1.25 mm), t is time, K is the ratio of the surface area of the leaves to the area of the entire canopy and E is the rate of evaporation during the precipitation event.

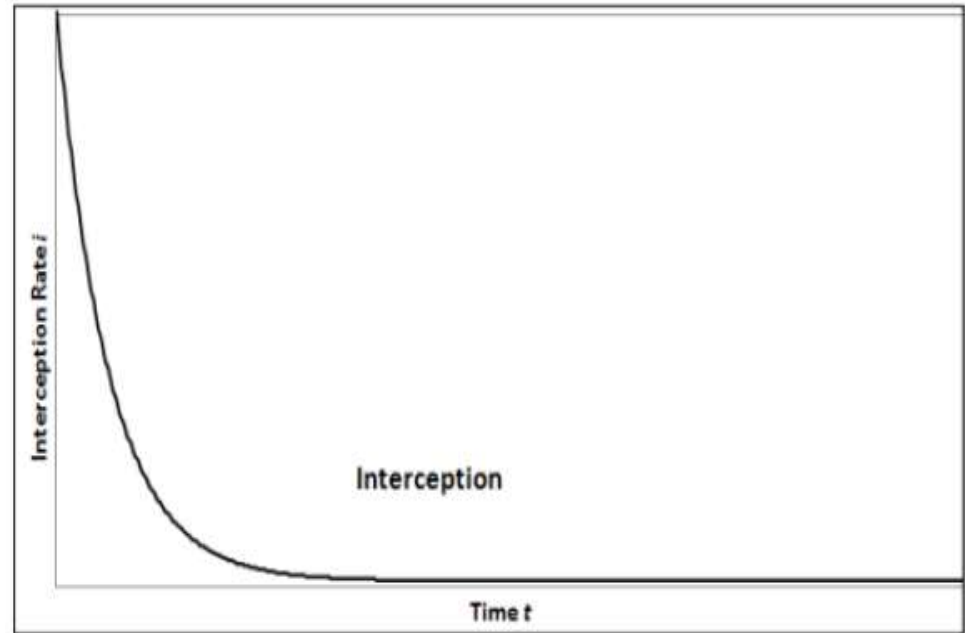

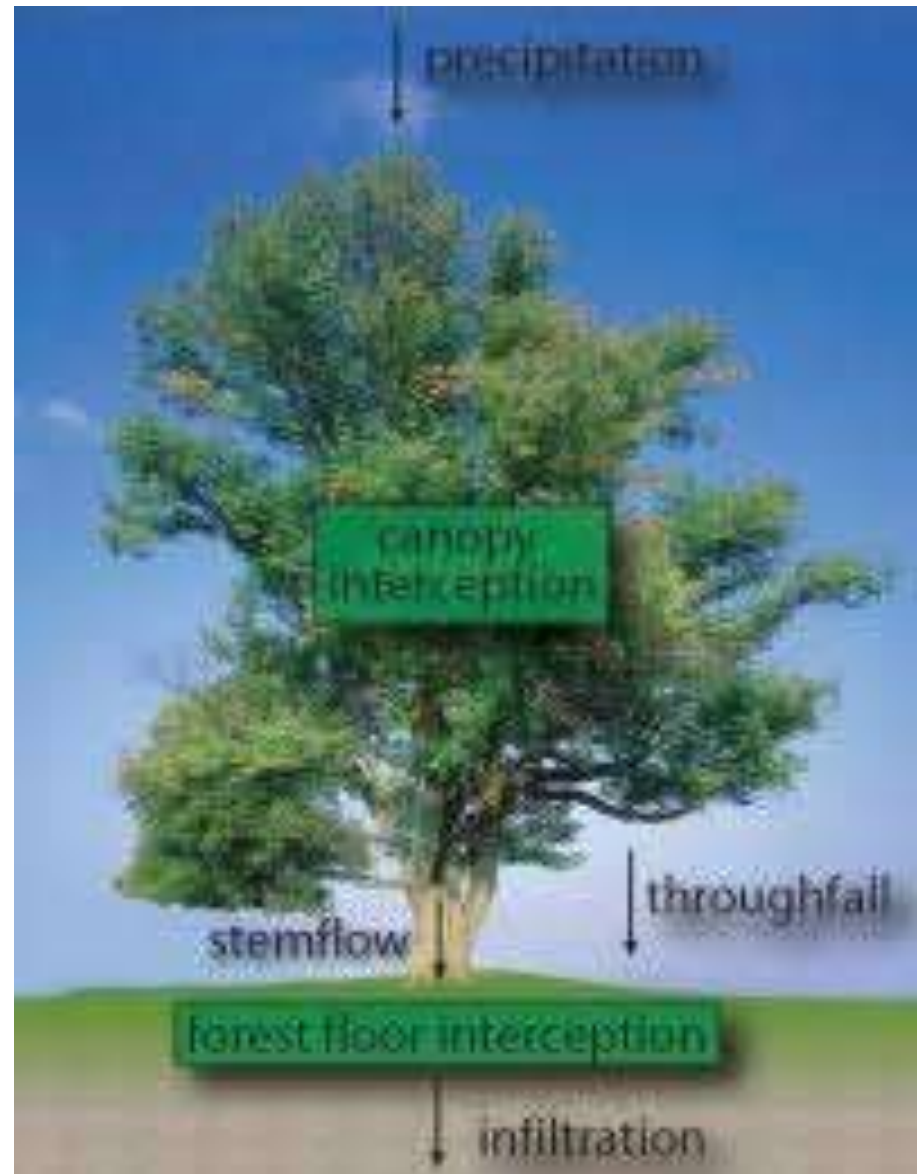

There are three Main Components of Interception:

1. Interception Loss
2. Throughfall
3. Stem-flow



 **Interception loss:** The water that is retained by vegetation surfaces that is later evaporated into the atmosphere, or absorbed by the plant and is regarded as a primary water loss.

 **Throughfall:** The water which falls through spaces in the vegetation canopy, or which drips from the leaves, twigs and stems and falls to the ground.

 **Stemflow:** The water which trickles along the stems and branches and down the main stem or trunk to the ground surface.

Depression Storage



When the precipitation of a storm reaches the ground it must first fill up all depressions before it can flow over the surface. The volume of water trapped in these depression is called depression storage.

- Depression storage range from 1 to 8 mm (0.04 to 0.3 in) with some values as high as 15 mm (0.6 in) per event.
- Depression storage varies greatly with the land use (A paved surface will not detain as much water as a recently furrow field).

 Depression storage is dependent on the amount and intensity of precipitation in the storm, soil characteristics, land use land cover and topography.

 The volume of water in depression storage at any time during a precipitation event can be approximated as (Linsley 1982):

$$V = S_d (1 - e^{-kP_e})$$

Where,

V is the volume of water in depression storage.

S_d is the maximum storage capacity of the depression.

P_e is the rainfall excess, and

k is a constant equal to $1/S_d$.

Evaporation



Evaporation is the process in which a liquid changes to the gaseous state at the free surface, below the boiling point through the transfer of heat energy (evaporation from bare soil and water bodies, such as ponds, lakes, and streams).



Rate of evaporation is dependent on:

- Vapour pressures at the water surface and air above
- Air and water temperatures.
- Wind speed
- Humidity
- Quality of water
- Size of the water body

Measurement of Evaporation

- a) Evaporimeter Data
- b) Empirical evaporation equation
- c) Analytical equation

Evaporimeter: Lake Evaporation = $C_p \times$ Pan Evaporation
 C_p - 0.60 - 0.80 (avg-0.70)

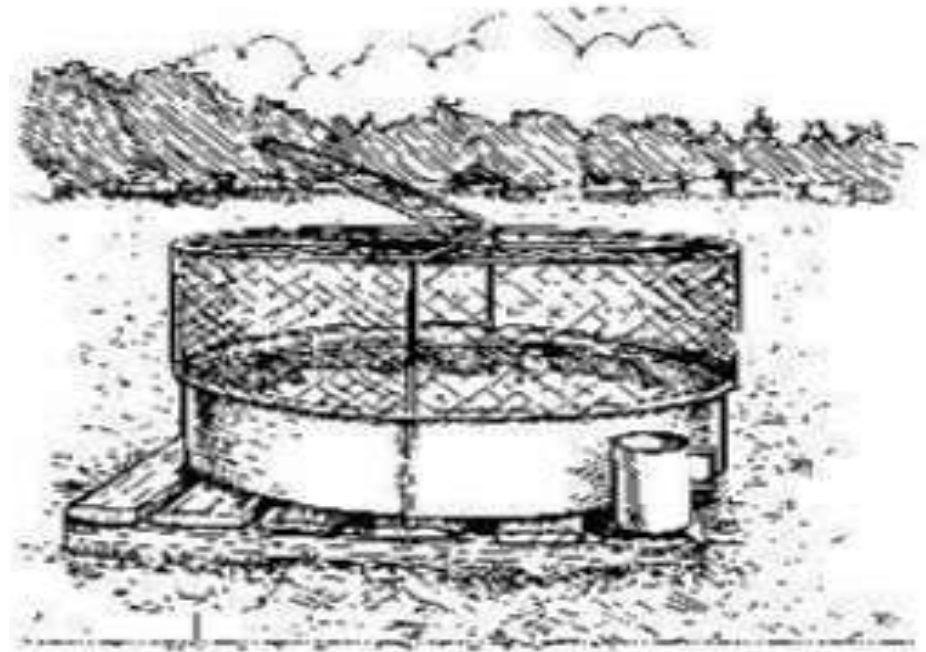
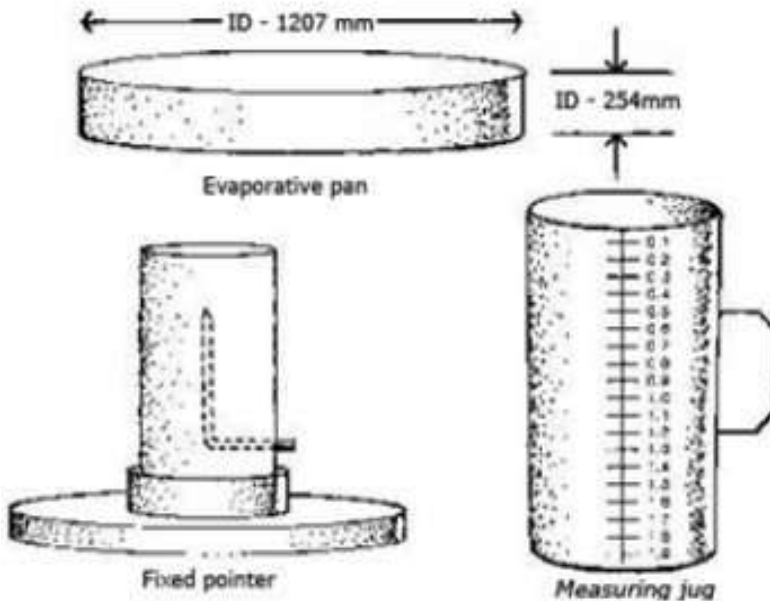

U.S Class A Pan Evaporimeter

Empirical evaporation equations

✓ Based on the Dalton's equation

Where,
$$E_L = K \cdot f(u) \cdot (e_w - e_a)$$

E_L = Lake evaporation (mm/day),

e_w = Saturated vapour pressure at the water surface temperature (mm of Hg),

e_a = Actual vapour pressure over-lying air at a specified height (mm of Hg)

$f(u)$ = Wind-speed correction function and

K = a coefficient

a) Meyer's Formula (1915)

$$E_L = K_m (e_w - e_a) \left(1 + \frac{u_9}{16}\right)$$

U_9 is the monthly mean wind velocity in km/h at 9m above ground.

K_m is the coefficient (0.36 for large deep waters and 0.50 for small)

$$u_h = u_1 h^{(1/7)}$$

Where u_h = wind velocity at a height h above the ground and u_1 = wind velocity

Problem

A reservoir with a surface area of 250 hectares had the following average values of climate parameters during a week: water temperature = 20°C, Relative humidity = 40%, Wind velocity at 1.0m above ground surface = 16km/h. Estimate the average daily evaporation from the lake by using Meyer's formula.

b) Rohwer's Formula (1931)

$$E_L = 0.771(1.465 - 0.000732p_a)(0.44 + 0.0733u_0)(e_w - e_a)$$

p_a = mean barometric reading in mm of Hg.

u_0 = coefficient (0.36 for large deep waters and 0.50 for small shallow water body)



Analytical methods of evaporation estimation

- ✓ Water budget method
- ✓ Energy budget method
- ✓ Mass transfer method

Infiltration

Infiltration is the flow of water into the ground through the soil surface.

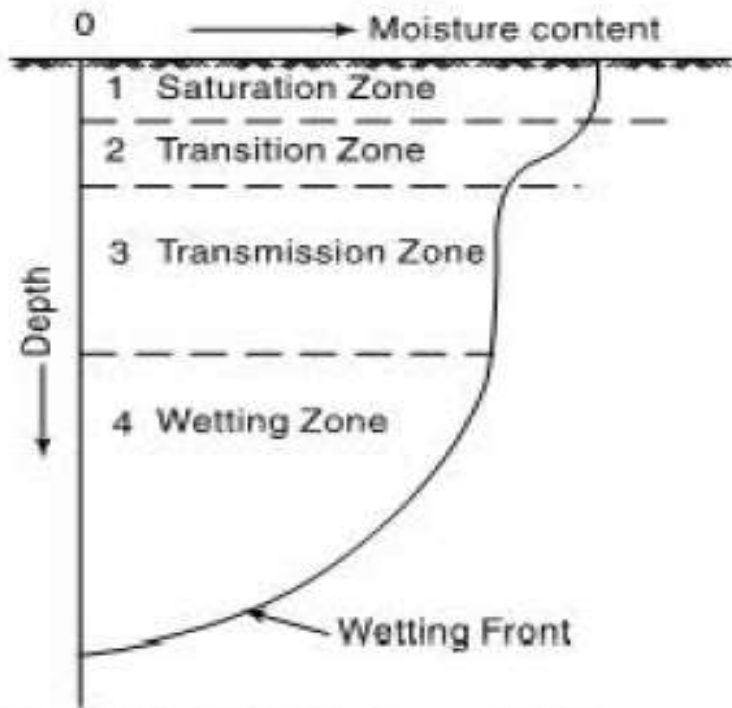

Distribution of soil moisture in the infiltration process

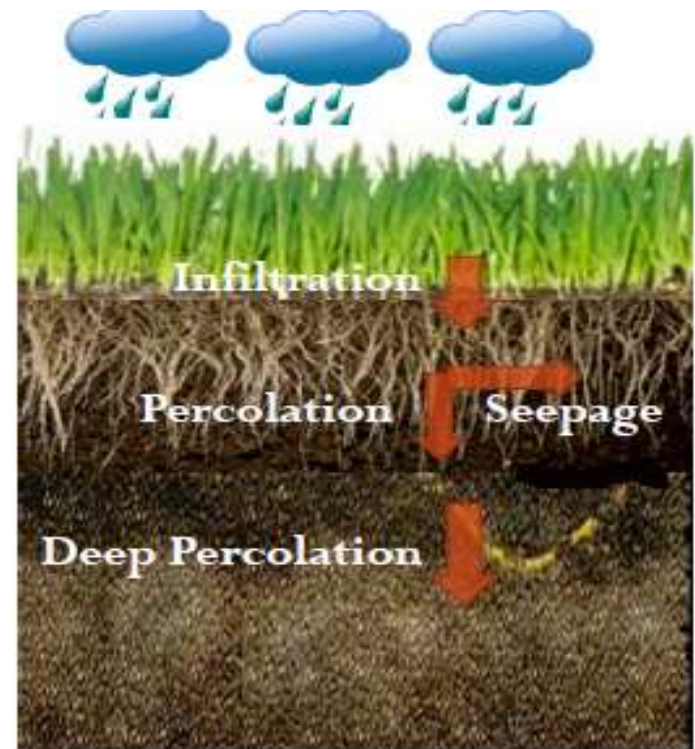

The maximum rate at which the ground can absorb water, the infiltration capacity and the volume of water that it can hold, the field capacity.

Factors Affecting Infiltration Rate

The major factors affecting the infiltration of water into the soil are :

- ✓ Hydraulic conductivity of the soil profile
- ✓ Duration of irrigation or rainfall
- ✓ Condition of the soil surface
- ✓ Initial moisture content
- ✓ Texture
- ✓ Porosity
- ✓ Organic matter
- ✓ Vegetative cover
- ✓ Viscosity of water

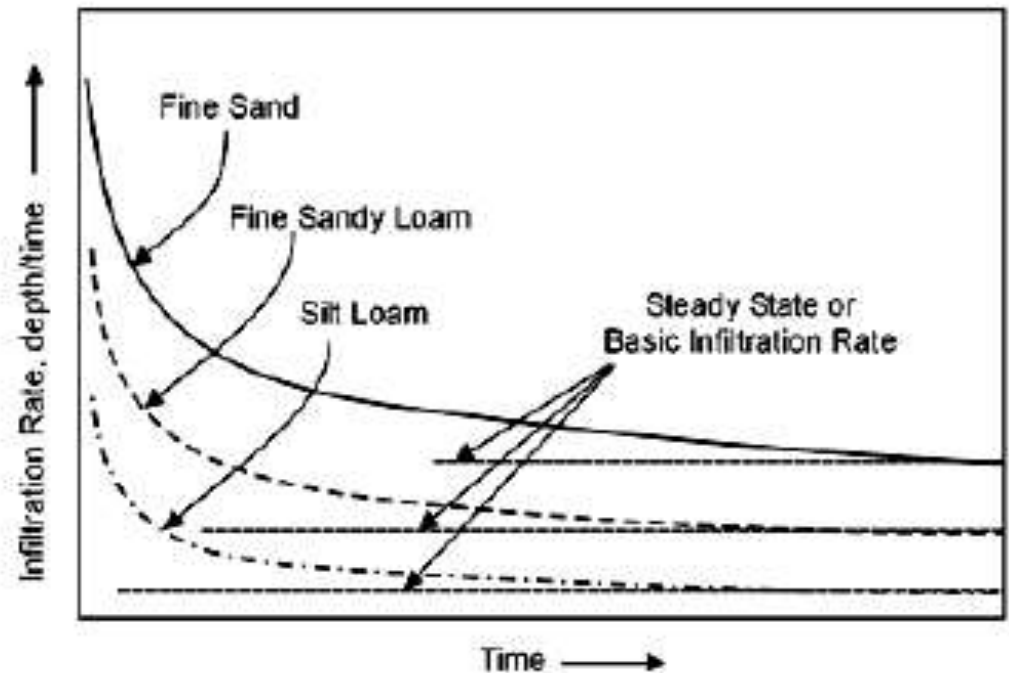

Measurement of Infiltration

The experimental setup for measuring the infiltration is called an infiltrometer. There are two kinds of infiltrometers:

- ✓ Flooding type infiltrometer
- ✓ Rainfall simulator

Flooding type infiltrometer

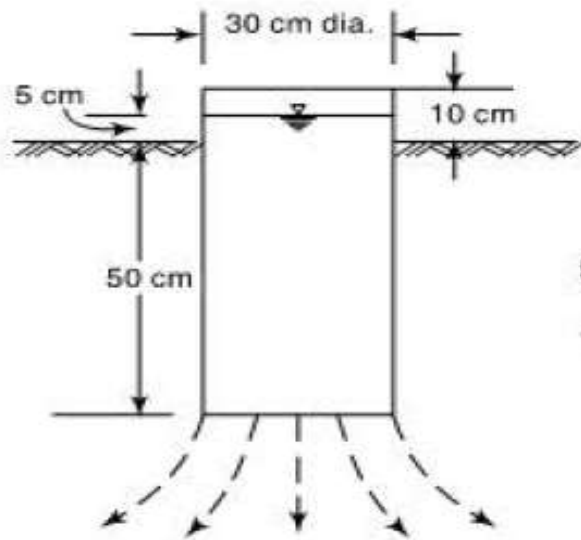

(a) Simple (tube-type) infiltrometer

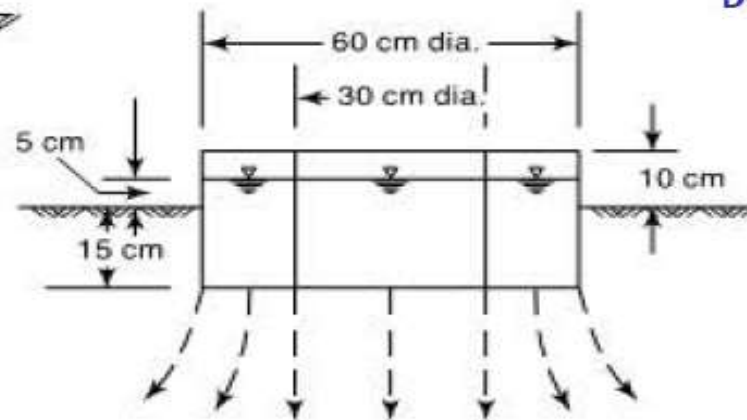

(b) Double-ring infiltrometer

Flooding Type Infiltrometers

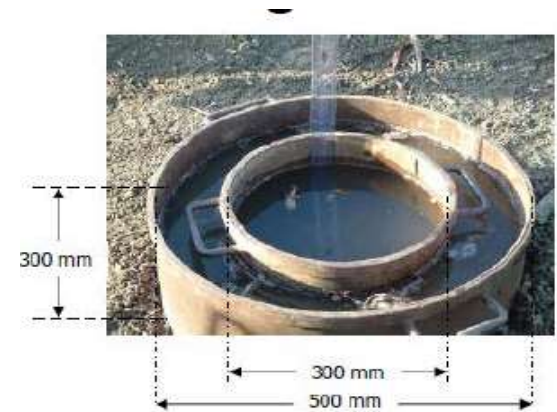

Double ring infiltrometer

Rainfall simulator

- Plot size = 2m x 4m
- Nozzles produce raindrops falling from a height of 2m and are capable of producing various intensities of rainfall.
- Using water budget equation involving the volume of rainfall, infiltration and runoff, the infiltration rate and its variation with time are estimated.

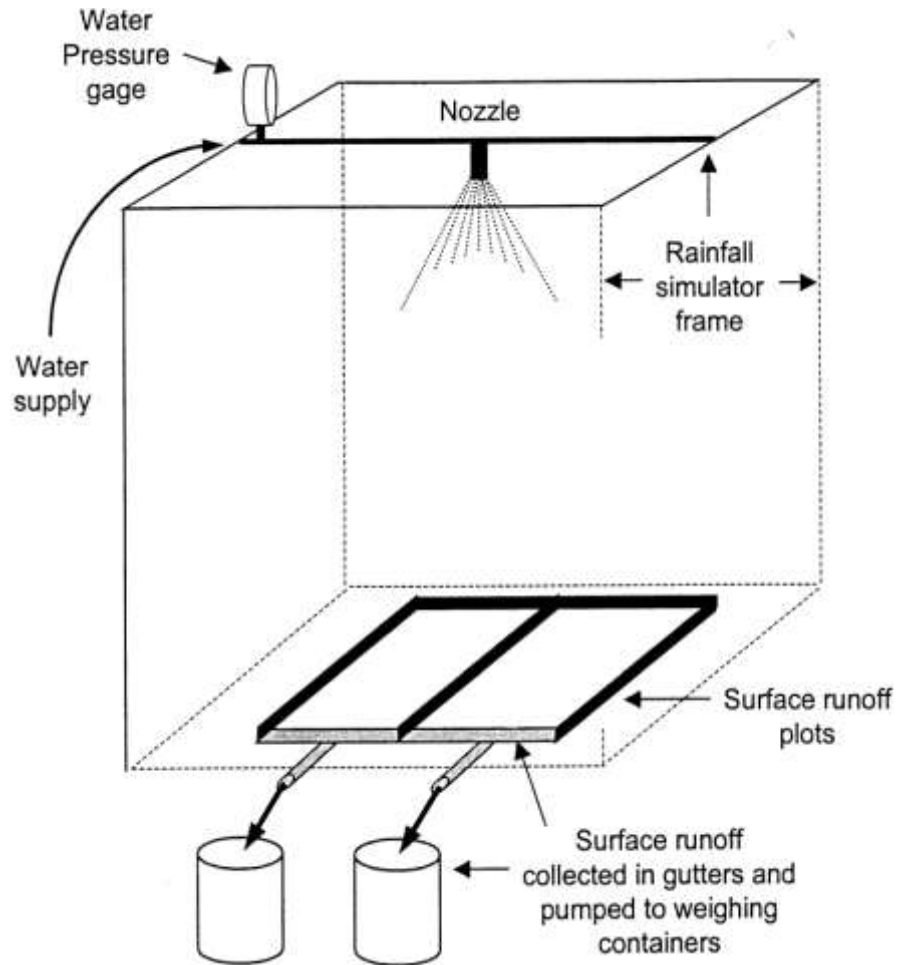

Rainfall simulator type infiltrometer give lower values than the flooding type infiltrometers. This due to effect of the rainfall impact and turbidity of the surface water present in the former.

The average infiltration rate is called infiltration index and two types of indices are in common use.

Φ index

- ✓ The Φ index is the average rainfall above which the rainfall volume is equal to the runoff volume.
- ✓ The Φ index is derived from the rainfall hyetograph.
- ✓ The initial loss is also considered as infiltration.

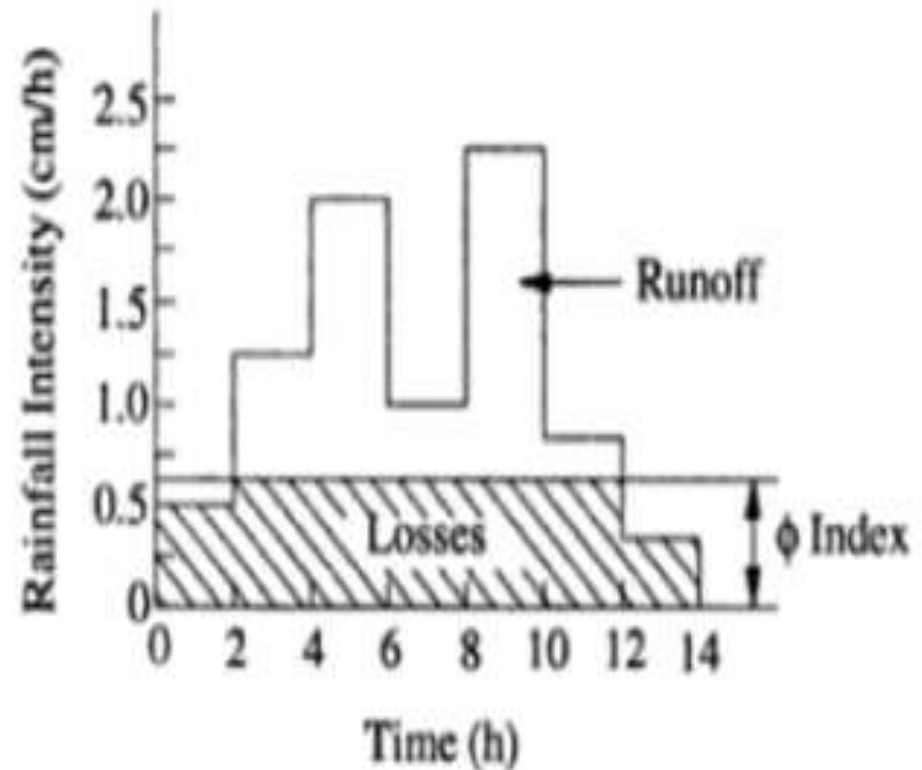

Note:

- ✓ If the rainfall intensity is less than Φ , then the infiltration rate is equal to the rainfall intensity;
- ✓ If the rainfall intensity is larger than the Φ value then the difference between rainfall and infiltration in an interval of time represents the runoff volume.
- ✓ The amount of rainfall in excess of the Φ index is called rainfall excess. The Φ index thus accounts for the total abstraction

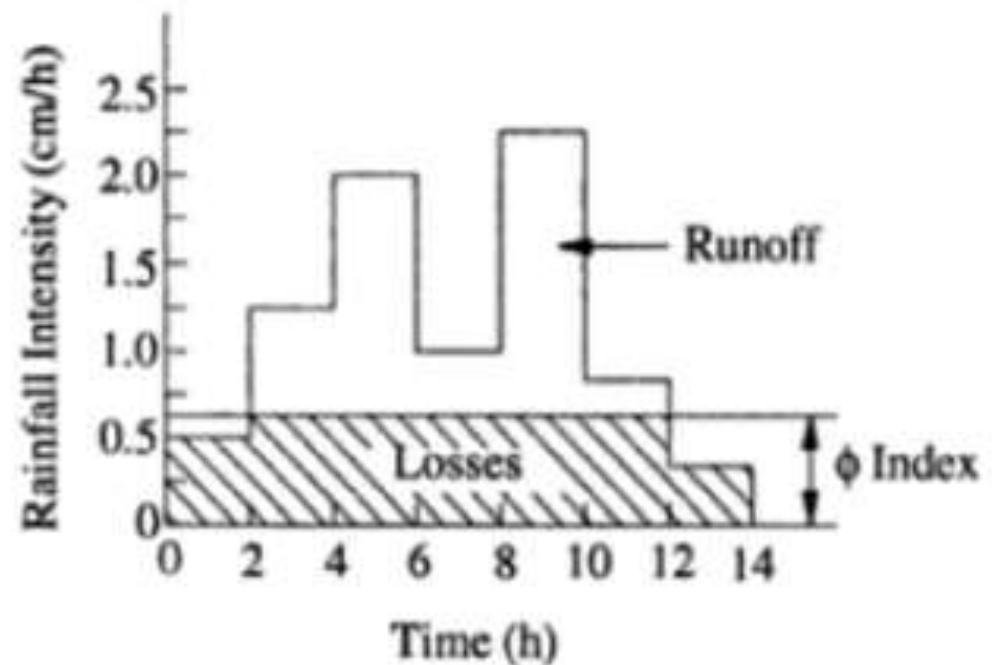

W-Index

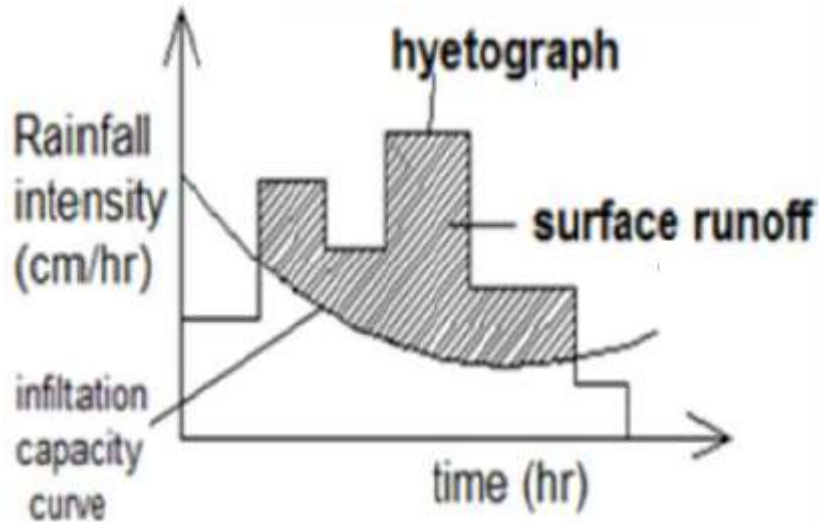

$$W = \frac{P - R - I_a}{t_e}$$

P = Total storm rainfall (cm)

R = Total storm runoff (cm)

I_a = Initial loss (cm)

t_e = Duration of the rainfall excess

(The total time in which the rainfall intensity is greater than W or ϕ)

Φ -Index

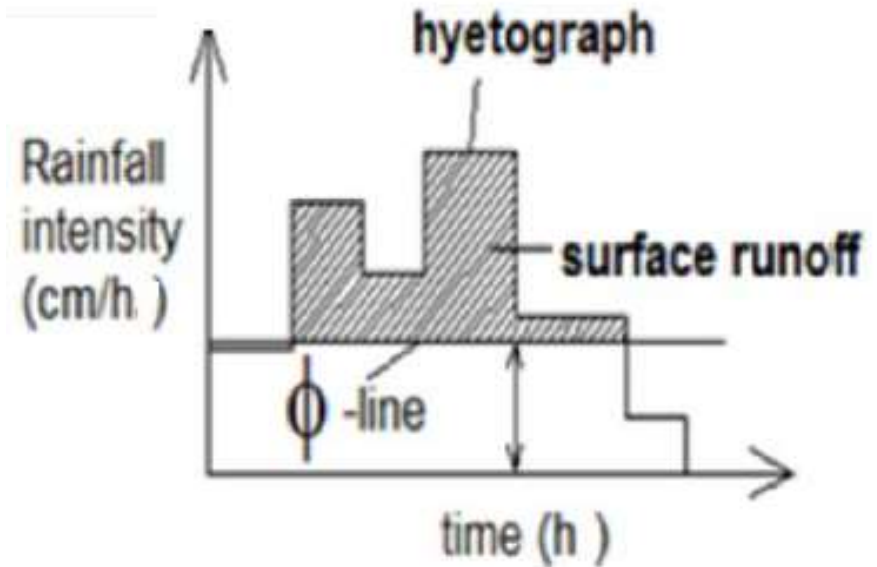

$$\phi = \frac{P - R}{t_e}$$

Problem

A storm with 10 cm of precipitation produced a direct runoff of 5.8 cm. The duration of the rainfall was 16 hours and its time distribution is given below. Estimate the ϕ – index of the storm.

Time from start (h)	0	2	4	6	8	10	12	14	16
Cumulative rainfall (cm)	0	0.4	1.3	2.8	5.1	6.9	8.5	9.5	10.0

Time since start of rain (h)

2 4 6 8 10 12 14 16

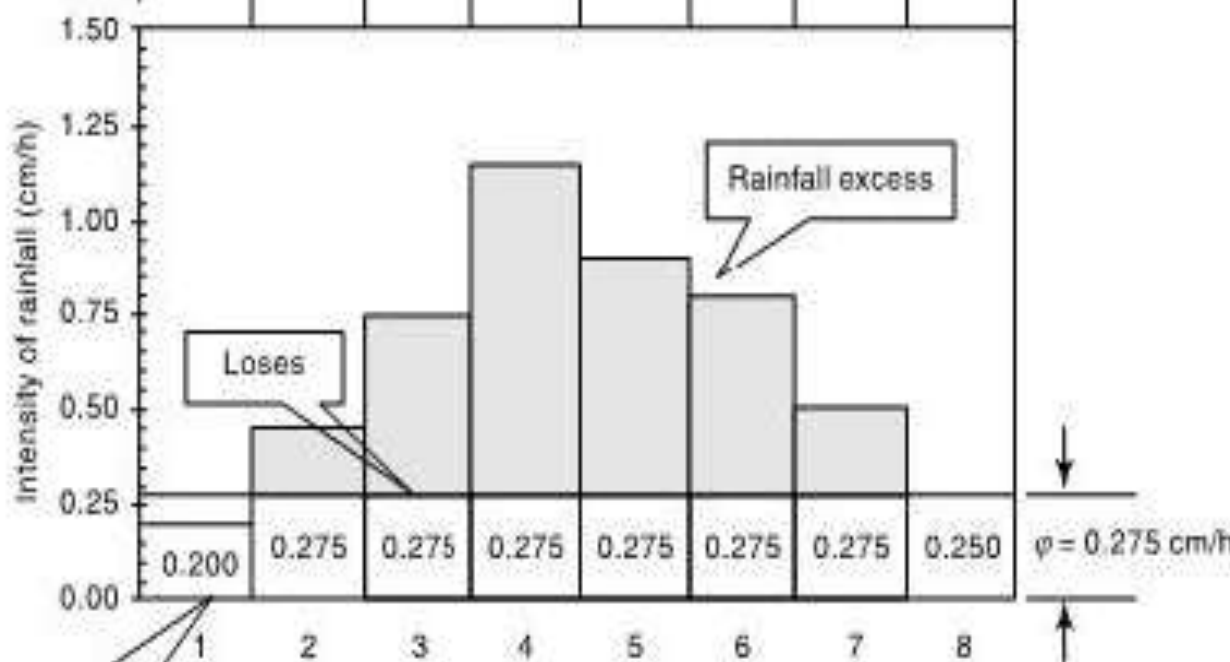

Initial loss

Pulse number	Time from start of rain (h)	Cumulative rainfall (cm)	Incremental rain (cm)	Intensity of rain (cm/h)
1	2	0.4	0.40	0.20
2	4	1.3	0.90	0.45
3	6	2.8	1.50	0.75
4	8	5.1	2.30	1.15
5	10	6.9	1.80	0.90
6	12	8.5	1.60	0.80
7	14	9.5	1.00	0.50
8	16	10.0	0.50	0.25

Trial 1:

$$\text{Runoff } (R_d) = \sum_1^8 (I_i - \phi)\Delta t = \sum_1^8 (I_i \times \Delta t) - \phi(8 \times 2)$$

$$5.8 = \{(0.20 \times 2) + (0.45 \times 2) + (0.75 \times 2) + (1.15 \times 2) + (0.90 \times 2) + (0.80 \times 2) + (0.50 \times 2) + (0.25 \times 2)\} - 16\phi$$

$$5.8 = 10.0 - 16\phi$$

$$\phi = 0.263 \text{ cm/h}$$

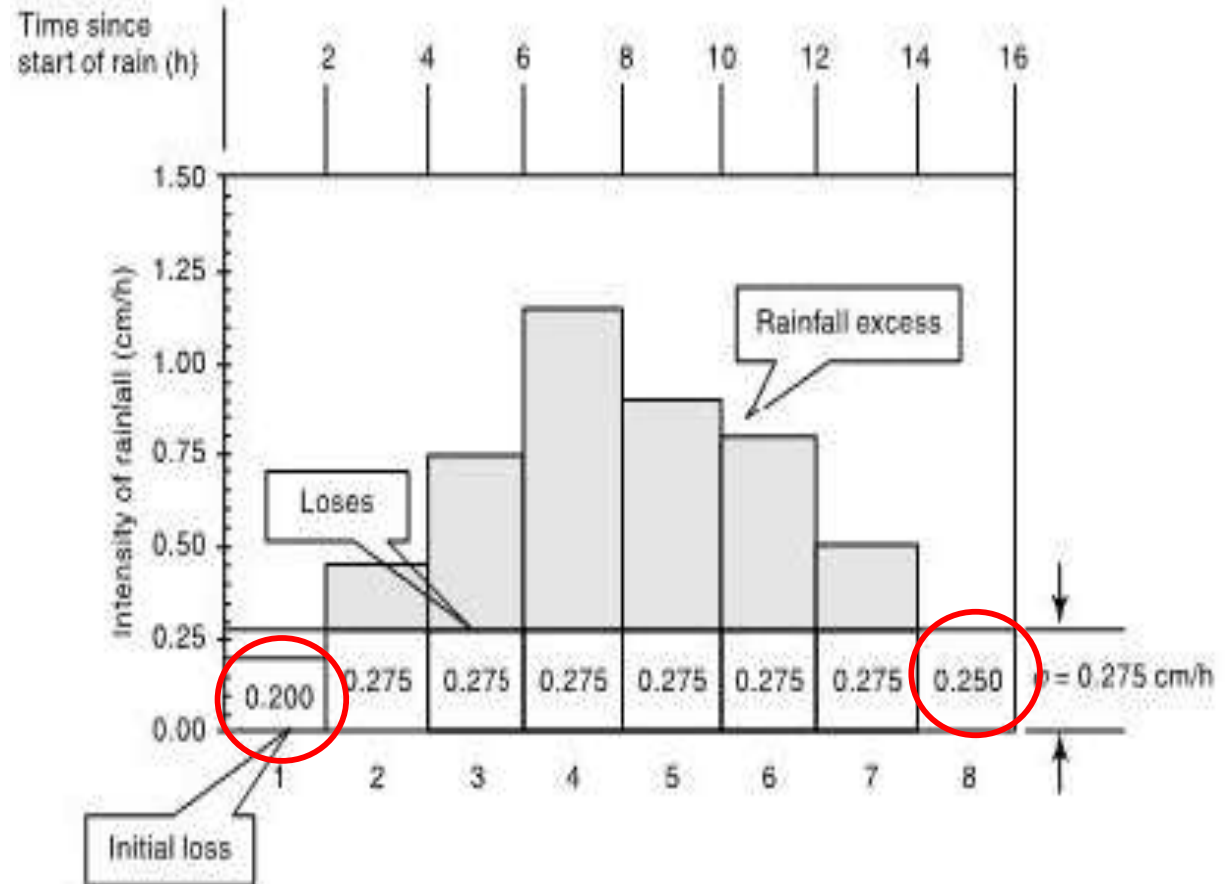

Trial 2:

$$\text{Runoff } (R_d) = \sum_1^6 (I_i - \phi) \Delta t = \sum_1^6 (I_i \times \Delta t) - \phi(6 \times 2)$$

$$5.8 = \{(0.45 \times 2) + (0.75 \times 2) + (1.15 \times 2) + (0.90 \times 2) + (0.80 \times 2) + (0.50 \times 2)\} - 12 \phi$$

$$5.8 = 9.1 - 12 \phi$$

$$\phi = 0.275 \text{ cm/h}$$

The ϕ - index of the storm is 0.275 cm/h and the duration of rainfall excess = t_e = 12 hours.

