



## ***Moving & Rotating Equipment***



## ***Objectives:***

Upon completion of this module, the participant will be able to:

- Recognize the hazards that are associated with moving and rotating equipment.
- Identify the potential consequences when these hazards are not properly addressed.
- Describe methods used to protect personnel working around moving and rotating equipment.
- Describe actions that should be taken if improperly guarded equipment is identified.

# Moving and Rotating Equipment

## Hazard Recognition

[www.discountppe.com](http://www.discountppe.com)



Crushed Hands  
and Arms



Injured  
Fingers



Blindness



- Safeguards are essential in protecting workers from injuries
- Recognizing the hazard is the first step in preventing the injury



## Where Mechanical Hazards are present

- **Point of Operation** - where work is performed by the machine
  - Cutting/Slitting
  - Shaping
  - Drilling
  - Forming of stock
  - Stretching
  - Coating
  - Winding Web
  - Packaging
  - Conveying pallets on conveyor Belts





## Where Mechanical Hazards are present

- **Power Transmission Apparatus** - Part of the machine that transfers energy to the part of the machine performing the work

- Flywheel
- Pulley
- Cams
- Gears
- Connecting rods
- Couplings
- Chains
- Belts

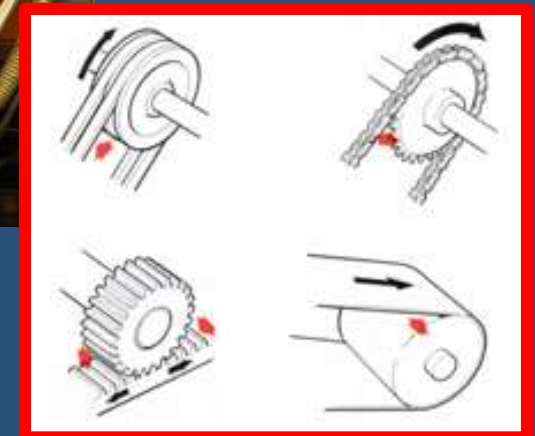



## Where Mechanical Hazards are present

- **Other Moving Parts** - Other parts of the machine that move while performing work
  - Reciprocating moving parts
  - Rotating moving parts
  - Transverse moving parts
  - Robot moving parts
  - Automated Guided Vehicles (AGV)





## Rotation Hazard

- Rotary Motion Hazard:
  - Can catch hair or clothing and draw the operator into the machine
  - Can force a hand or arm into a dangerous position, causing lacerations, broken bones, or amputation
  - Hazard is increased when projections are present on rotating components which can strike the operator (setscrews, nuts/bolts, abrasions, or keys)

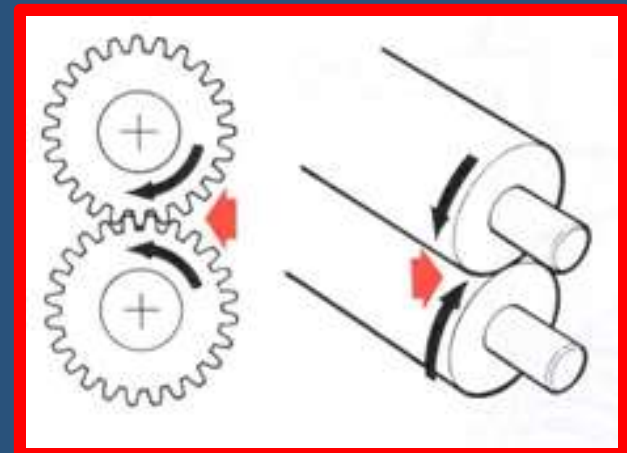
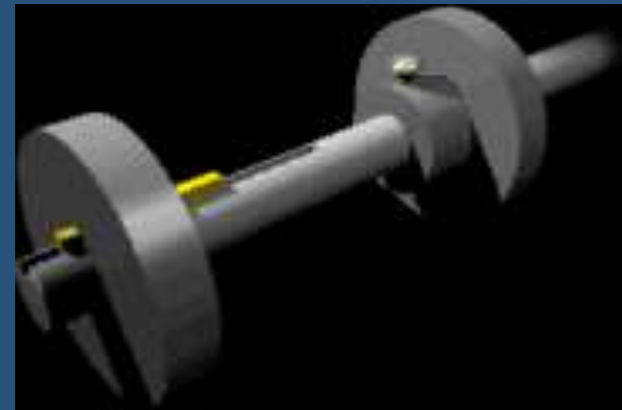



## Rotation Hazard

- Rotary Motion Hazard (examples):

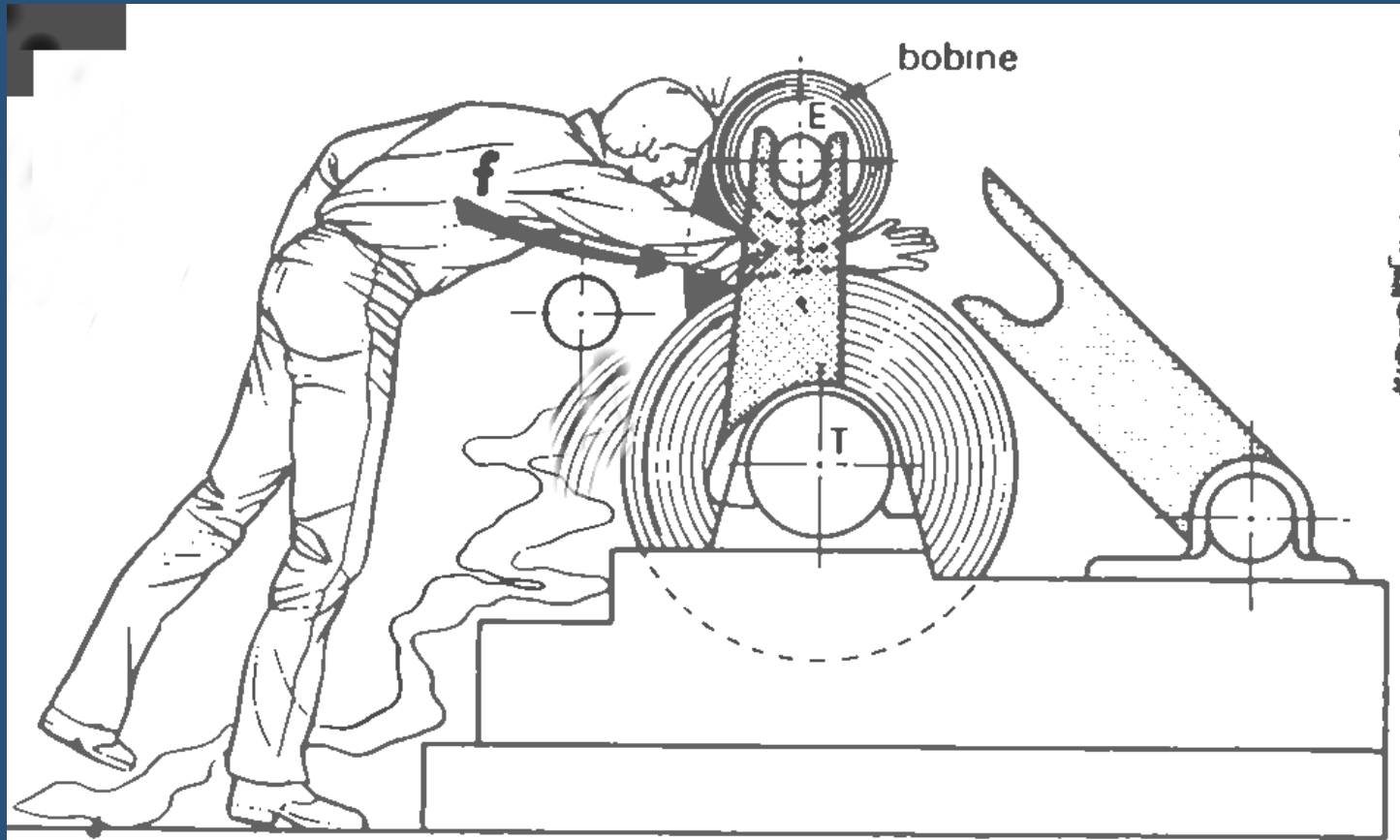





## Rotation Hazard

- Rotary Motion Hazard (examples):

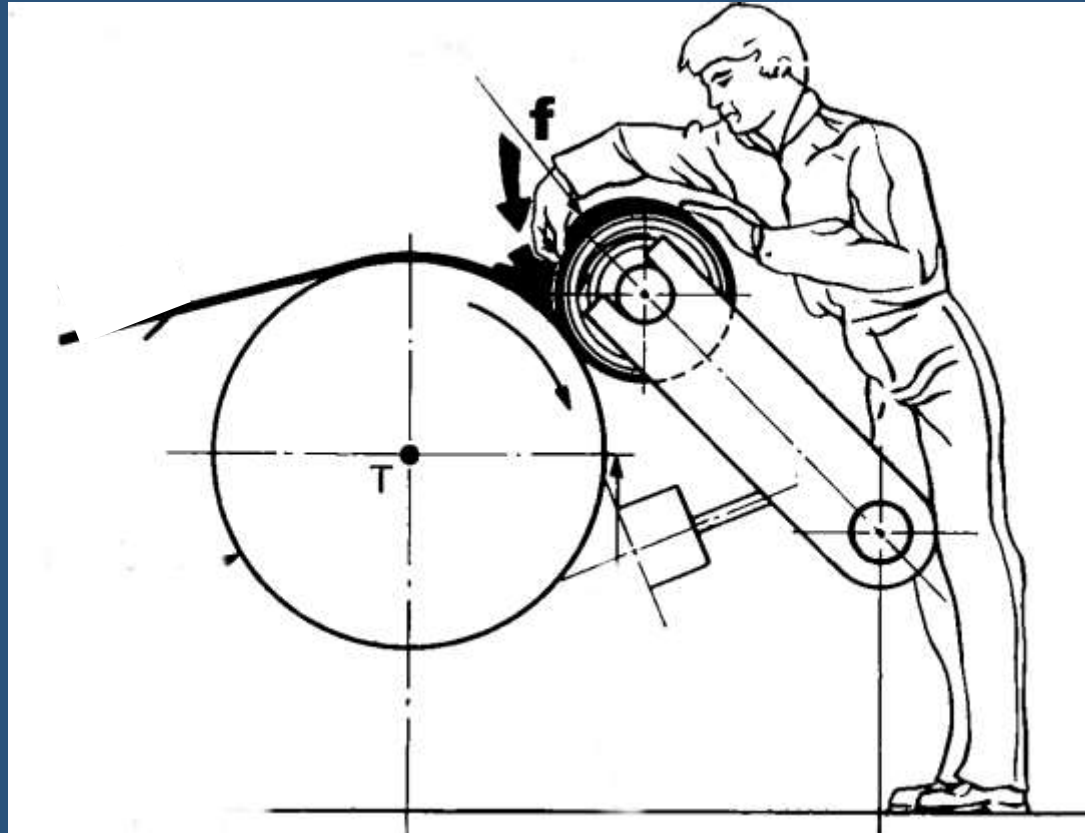



## Rotation Hazard

### ○ Nip points (pinch point) hazards on rotating equipment

- Parts rotating in opposite directions while being parallel to each other

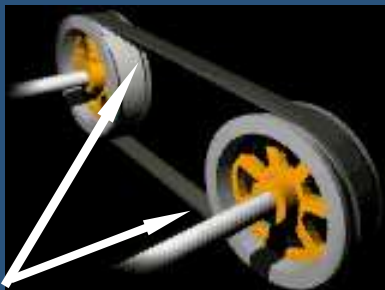
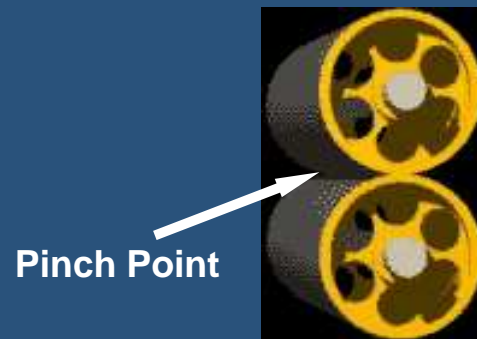

Pinch Points

- Between rotating and tangentially moving parts

- Between rotating and fixed parts





## Rotation Hazard

- Nip points (pinch point) hazards (example)





## Rotation Hazard

- Nip points (pinch point) hazards (example)
- Entanglement caused by catching on projection or in gaps

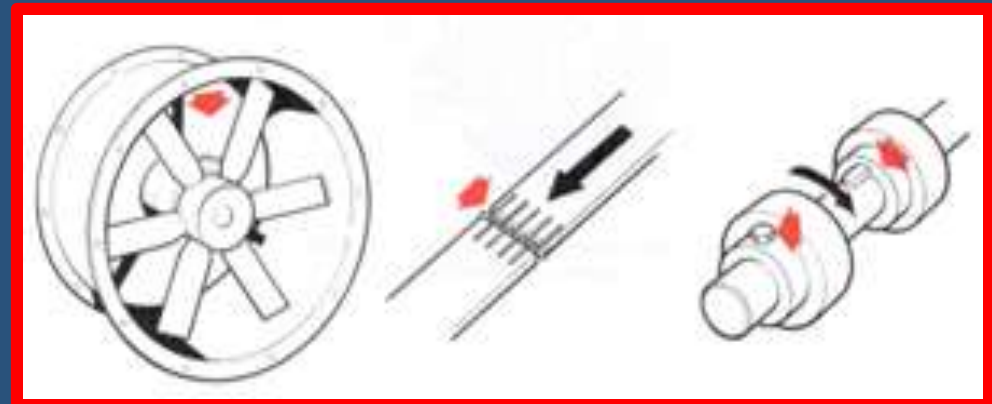



## Rotation Hazard

- Entanglement caused by contact with single rotating surface

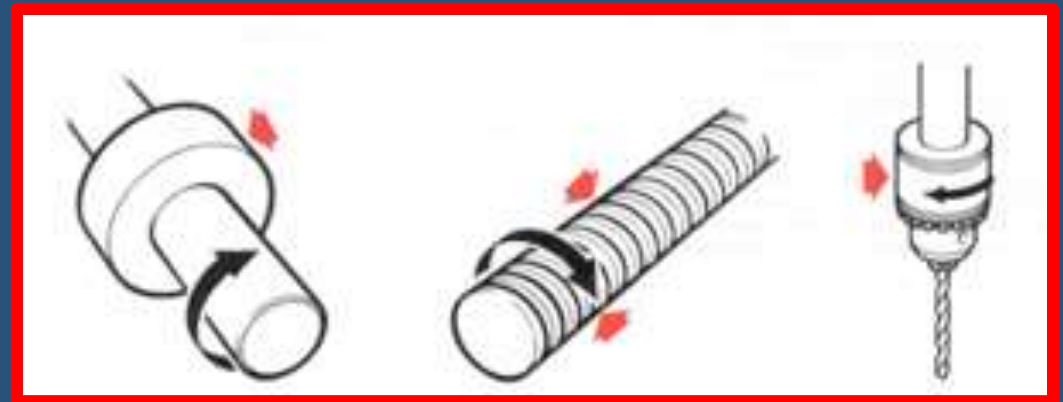



## Reciprocating Hazard

### ○ Reciprocating Motion

- Struck by or caught between the stationary part and moving part of the up-and-down or back-and-forth motion
- Also consider cars and fork-lift trucks





## Friction and Abrasion Hazards

### ○ Abrasive / Rubber Surfaces

- Contact with an abrasive or sticky surface in fast motion

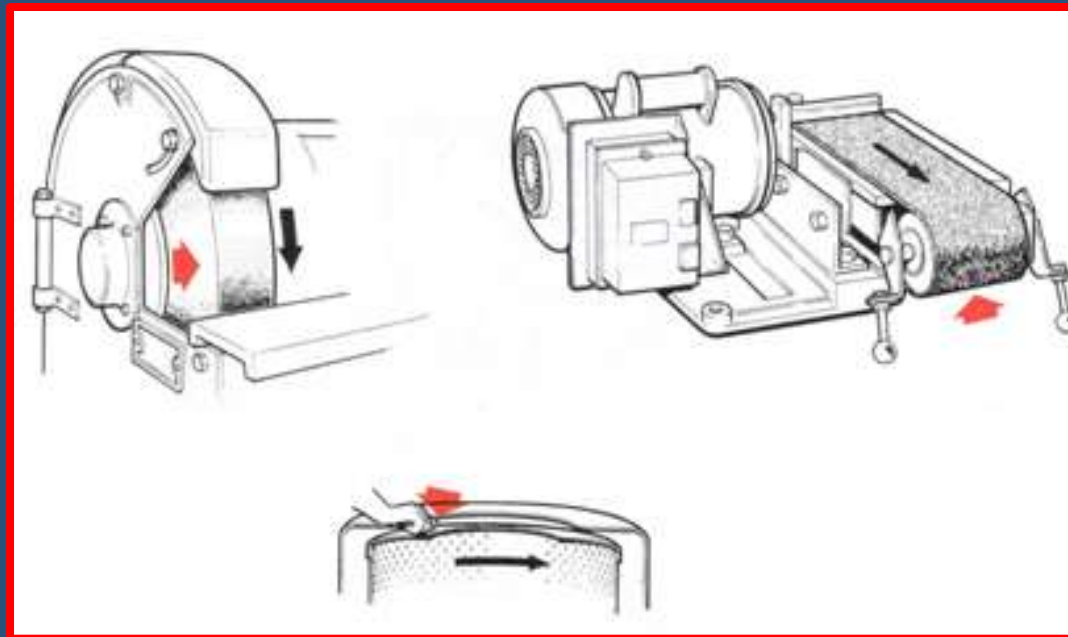

# Moving and Rotating Equipment

[www.discountppe.com](http://www.discountppe.com)

## Hazard Recognition



Knowledge  
Check



Working around equipment which is running with guard removed!!! (Any reactions, what would you do if you would see this?)

NOTE: Unsafe Acts can lead to Unsafe Conditions and vice versa





## TOP – Technical, Organizational & Protection

- o Keep in mind that the priority in findings solutions for hazards is always:

1. Technical, equipment solutions.

2. Organization of work, training, procedures

3. Protection like leather gloves

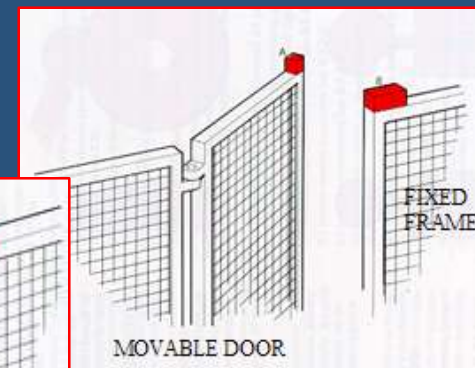
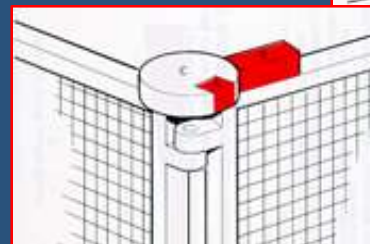

**Note: We apply all three in combination to prevent incidents**



## **Prevention!**

# YOU !

⌘ **You can identify if it's OK out there to prevent you from personally suffering pain, loss of movement, or loss of life!**

⌘ **You are accountable for safe behavior!**

– Maintaining Safe Guards in adequate condition is KEY!!!





## Prevention!

### 1) Minimum Requirements. E.g.:

#### A) New machines :

- Machines Directive (CE marking) in Europe

- OSHA Requirements in US

  - OSHA Standards - 29 CFR - 1910.212, Machinery and Machine Guarding

#### B) For machines that are taken into service before 1995 in Europe:

- Equipment Directive for work in Europe

- No grandfather clause for OSHA requirement in US



## Prevention!

### 2) Basic incident prevention by design, inspection & maintenance

A) E.g. Eliminate machinery risks through equipment design

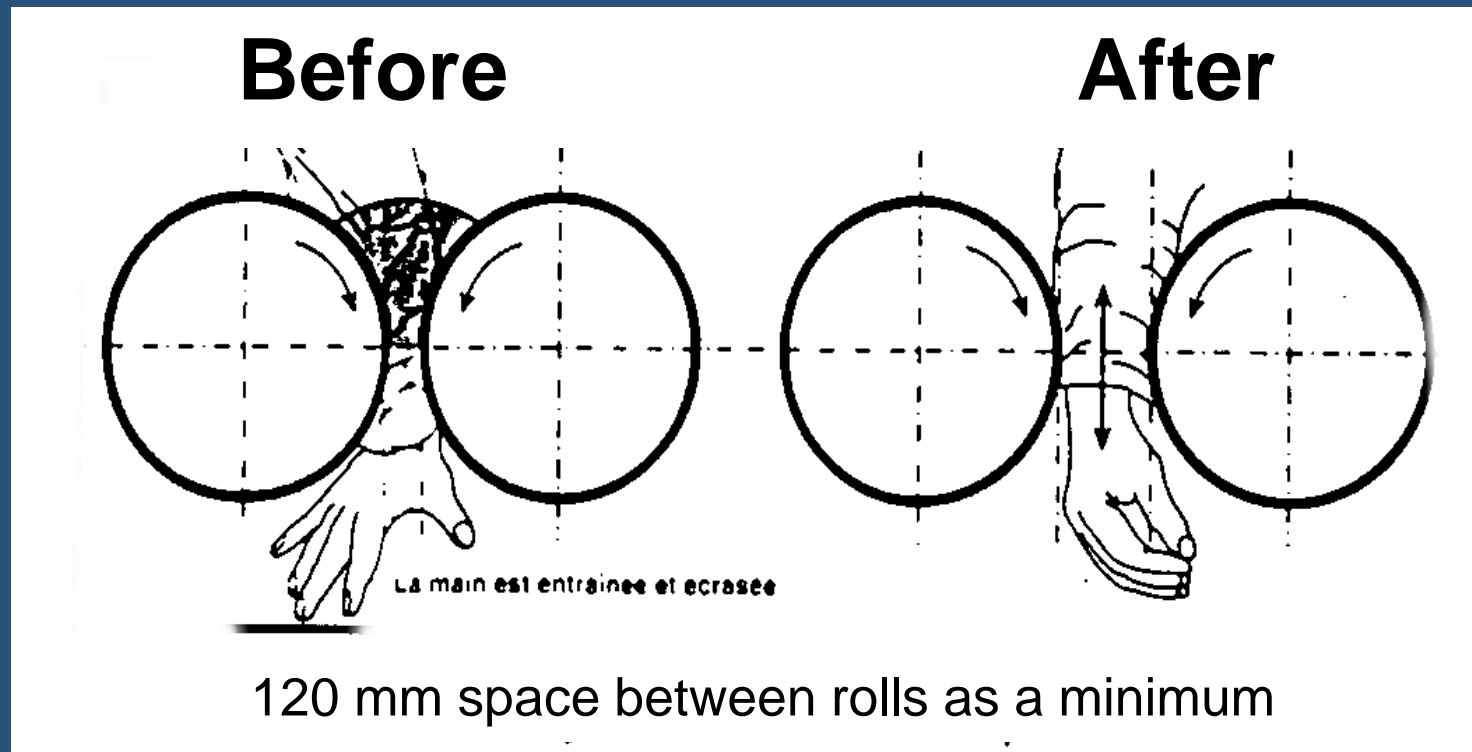



## Prevention!

### 2) Basic incident prevention by design, inspection & maintenance

#### B) Distance / Location

- Area with dangerous moving parts must not be accessible to the operator during operations

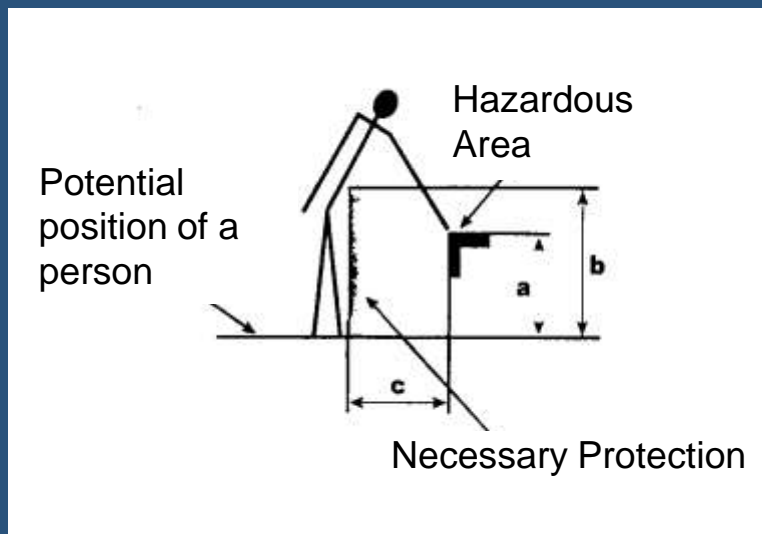



## Prevention!

### 2) Basic incident prevention by design, inspection & maintenance

#### C) Safety Devices:

- Machine stops if the hand or any part of the body inadvertently enters the danger area
- Restrains or withdraws the operators hand from the danger area during operations
- Requires operator to use two hands to control machine, thus keeping the hands away from the danger area
- Light Curtains
- Two-hand Control/Two-hand Trip
- Gate – Limit Switches – Proximity Switches
- **Any others???**



## Prevention!

### 2) Basic incident prevention by design, inspection & maintenance

#### D) Fixed Guards

- The method of fixing and the size of any openings, allowing for an adequate distance between the opening and the danger point will determine its effectiveness.



**CORRECT**

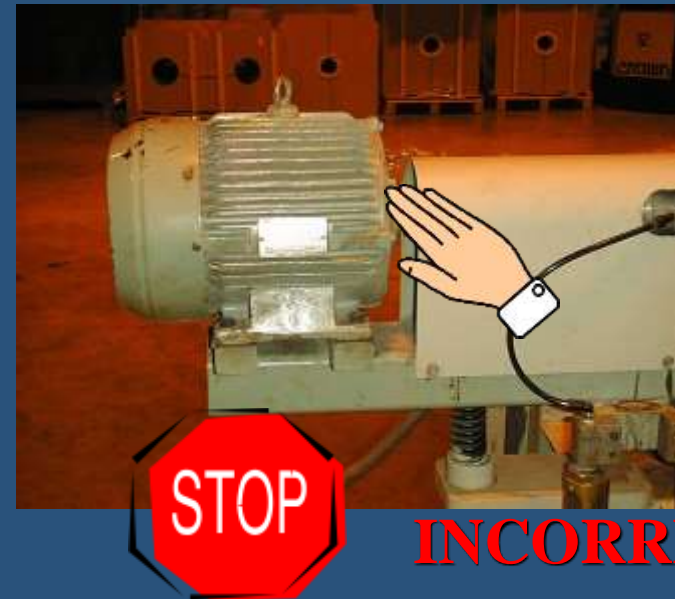

**INCORRECT**



## Prevention!

### 2) Basic incident prevention by design, inspection & maintenance

#### E) Self-Adjusting Guard

- Automatically opened by the movement of the work piece
- Returns to its closed position when the operation is completed

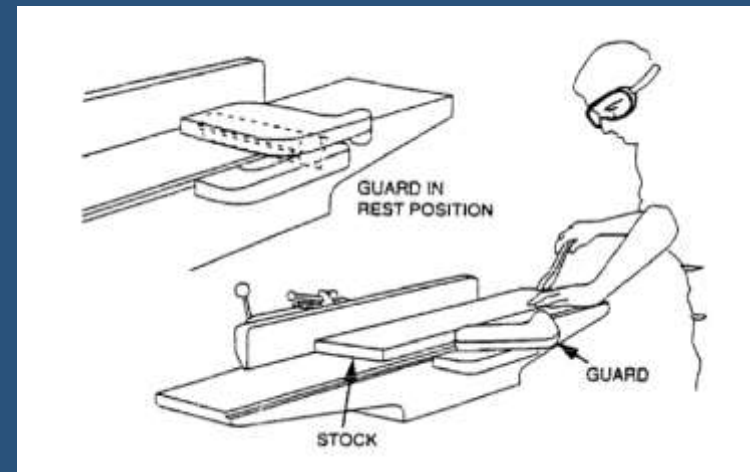



# Moving and Rotating Equipment

[www.discountppe.com](http://www.discountppe.com)

Hazard Recognition



## Prevention!

### 2) Basic incident prevention by design

#### F) Mobile Safeguards





## Prevention!

### 3) Basic is safe behavior

A) Never defeat a machine safe guard

B) Be aware of draft from rotating equipment

- Even with a guard in place, rotating equipment can create a strong draft

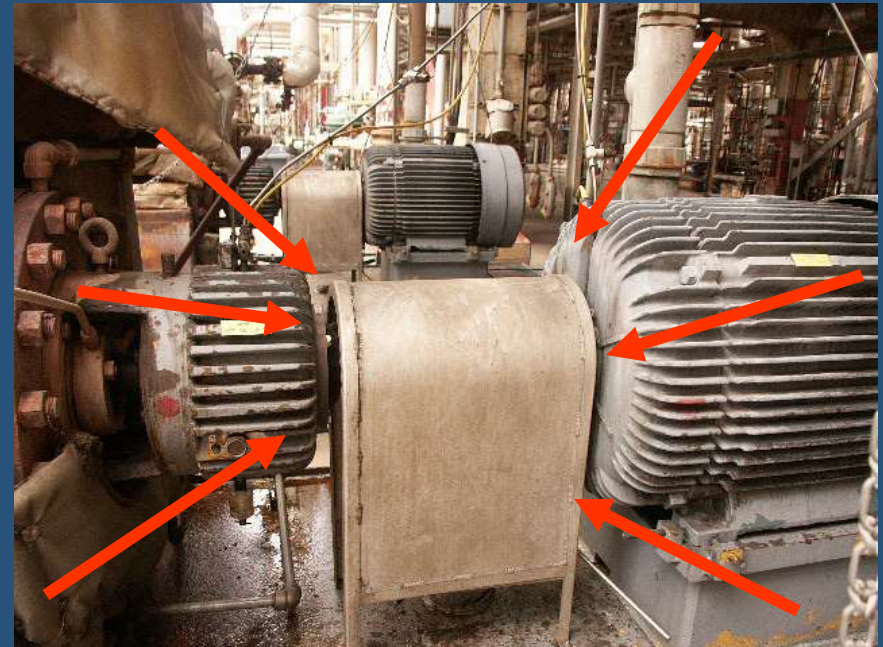



## Prevention!

### 3) Basic is safe behavior

#### B) Be aware of draft from rotating equipment (continued)

- Loose clothing can easily be sucked into moving equipment by just such a draft
- Tools/small equipment hanging out of your pockets may become entangled in moving equipment





## Prevention!

### 3) Basic is safe behavior

#### B) Be aware of draft from rotating equipment (continued)

- Long hair can also be pulled into moving equipment
- When working around moving machinery, take whatever precautions necessary to prevent this

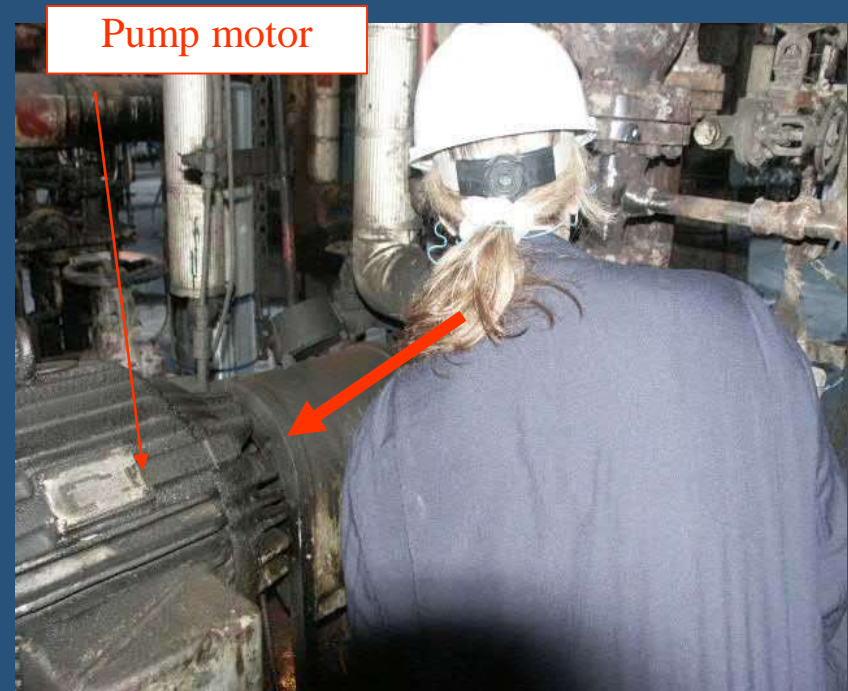



## Prevention!

### 3) Basic is safe behavior

- C) Be aware of loose clothing or tools hanging from your person, and hair that may become entangled in moving equipment.



# Moving and Rotating Equipment

## Hazard Recognition



[www.discountppe.com](http://www.discountppe.com)



If you see any equipment that you feel is not properly guarded

**Raise a red flag**

- Mitigate the concern if possible (e.g. rope off the area) .
- Report it immediately to your supervisor.
- Ask if the equipment should be shut down and tagged **“DO NOT OPERATE”**.
- If necessary, ensure that a Safety work order is entered into the system to address the concern.
- Follow up on the work order.



## Hypothetical Situation

- ⌘ You notice a disturbance on a conveyor belt with bales of rubber. The machine has screens with doors to shield off the rotating parts of the machine. What do you do?
- ⌘ You see a person working on an air fin belt while there is no label on the switch of the electromotor. What do you do?

## Actions

- You are not going to open doors while the machine is running. Stop the machine to solve the problem. Lock, Tag & Try to safe guard!!!
- This includes safe guarding in the sub station/motor control unit (removing/disconnecting fuses).
- You stop the job and verify that the machine is safe guarded (electrically secured through a Lock Tag & Try procedure).

# Moving and Rotating Equipment

[www.discountppe.com](http://www.discountppe.com)

## Hazard Recognition



Exercise

### Hypothetical Situation

- ⦿ You see a guard not properly in place (missing or not properly tight up) and equipment behind is in motion/energized. What do you do?



### Actions

- ⦿ You immediately make this hazard highly visible (signs, barriers) then you notify the equipment owner about the none conformity !





- Quite a number of accidents have happened because the persons involved were caught by a sudden, unexpected release of energy.
- The events may not have been anticipated because of:
  - Not performing an assessment of the risk
  - Failing to recognize the risk (lack of awareness)
  - Underestimating the risk (poor judgment)
- Experience shows that this is particularly true for certain jobs:
  - Jobs that are rarely performed,
  - Jobs performed for the first time,
  - Familiar jobs where there is a change in the circumstances.
- The only way to prevent being caught by surprise is carrying out a thorough risk assessment before each job.

# Moving and Rotating Equipment

[www.discountppe.com](http://www.discountppe.com)

Hazard Recognition



**EVEN THOUGH WE'VE BEEN BORN TO DO A TASK, IT DOESN'T IMPLY WE'LL ALWAYS DO IT SAFELY !!!**

**REMEMBER,**

- **IT DOESN'T MATTER HOW MANY TIMES WE'VE DONE IT,**
- **BEFORE EACH TASK WE MUST DO A LAST MINUTE RISK ASSESSMENT**





## ***Objectives Review:***

Upon completion of this module, the participant will be able to:

- Recognize the hazards that are associated with moving and rotating equipment.
- Identify the potential consequences when these hazards are not properly addressed.
- Describe methods used to protect personnel working around moving and rotating equipment.
- Describe actions that should be take if improperly guarded equipment is identified.