

# **POST HARVEST HANDLING OF VEGETABLES**

This is Members Copy, Not for Sale. Downloaded on Saturday, May 23, 2020

drysrhu

**drysrhu**

# **POST HARVEST HANDLING OF VEGETABLES**

**Dr. R.K. Dhall**

Department of Vegetable Crops  
Punjab Agricultural University  
LUDHIANA-141004



**NARENDRA PUBLISHING HOUSE**  
**DELHI-110006 (INDIA)**

Copyright © 2012, Narendra Publishing House, Delhi (India)

All rights reserved. Neither this book nor any part may be reproduced or used in any form or by any means, electronic or mechanical, including photocopying, microfilming, recording, or information storage and retrieval system, without the written permission of the Publisher and Author.

**First Published in 2012**

**Reprint in 2017**

**ISBN: 978-93-80428-49-9**

*Published by :*

**NARENDRA PUBLISHING HOUSE**

**Publisher and Distributor**

1417, Kishan Dutt Street, Maliwara,

DELHI-110006 (India)

**Phones:** 91-011-23268470, 91-011-23259412

**E-mail:** info@nphindia.com

**Website:** www.nphindia.com

Printed in India

Laser Typeset by Amrit Graphics, Shahdara, Delhi-110032



*This book is Dedicated to  
My Parents*

**drysrhu**

## Contents

|   |            |
|---|------------|
| <i>Foreword</i>   | <i>xix</i> |
| <i>Preface</i>  | <i>xxi</i> |
| <b>1. POSTHARVEST HANDLING: IMPORTANCE AND CONSTRAINTS .....</b>  | <b>1</b>   |
| 1. PRESENT STATUS .....   | 2          |
| 2. OBJECTIVES OF POSTHARVEST HANDLING .....                       | 3          |
| 3. CHANNELS OF POST HARVEST LOSSES .....                          | 3          |
| 3.1. Farm Level .....   | 3          |
| 3.2. Whole Sellers Level .....                                    | 4          |
| 3.3. Retail Level/Consumer Level .....                            | 4          |
| 4. CAUSES OF POSTHARVEST LOSSES .....                             | 4          |
| 4.1. Physical/mechanical Losses .....                             | 5          |
| 4.2. Microbial Losses .....                                       | 6          |
| 4.3. Physiological Disorders .....                                | 7          |
| 4.4. Physiological and Biochemical Aspects .....                  | 9          |
| 4.5. Other Factors of Postharvest Losses .....                    | 9          |
| 5. IMPORTANCE OF POSTHARVEST HANDLING IN VEGETABLES .....         | 10         |
| 5.1. Reduce Postharvest Losses and Improve Shelf Life .....       | 10         |
| 5.2. Improve the Food Safety and Quality .....                    | 11         |
| 5.3. Making Availability of Fresh Vegetables .....                | 11         |
| 5.4. Export Earning and Strengthening Nation Conomy .....         | 11         |
| 5.5. Employment Generation .....                                  | 12         |
| 5.6. Waste Utilization .....                                      | 12         |
| 5.7. Add Taste, Variety and Provide Nutrition .....               | 12         |
| 6. IMPROVEMENT NEEDED IN POSTHARVEST HANDLING OF VEGETABLES ..... | 12         |
| 7. FUTURE POST-HARVEST THRUST AREAS .....                         | 13         |
| 8. CONCLUSION .....   | 14         |
| <b>2. POSTHARVEST BIOLOGY AND TECHNOLOGY .....</b>                | <b>16</b>  |
| 1. BIOLOGICAL FACTORS INVOLVED IN DETERIORATION .....             | 16         |
| 1.1. Respiration .....  | 16         |
| 1.2. Ethylene Production .....                                    | 18         |
| 1.3. Compositional Changes .....                                  | 19         |
| 1.4. Growth and Development .....                                 | 20         |

- 1.5. Transpiration or Water Loss ..... 20
- 1.6. Physiological Breakdown ..... 22
- 1.7. Physical Damage ..... 23
- 1.8. Pathological Breakdown ..... 23
- 2. ENVIRONMENTAL FACTORS INFLUENCING DETERIORATION ..... 23
  - 2.1. Temperature ..... 23
  - 2.2. Relative Humidity ..... 24
  - 2.3. Atmospheric Composition ..... 24
  - 2.4. Ethylene ..... 24
  - 2.5. Light ..... 24
  - 2.6. Other Factors ..... 25
- 3. POSTHARVEST TECHNOLOGY PROCEDURES ..... 25
  - 3.1. Temperature Management Procedures ..... 25
  - 3.2. Control of Relative Humidity ..... 25
  - 3.3. Use of Controlled and Modified Atmospheres ..... 26
  - 3.4. Packing and Packaging ..... 27
  - 3.5. Transportation ..... 27
  - 3.6. Handling at Wholesale and Retail ..... 27
  - 3.7. Other Management Techniques ..... 28
  - 3.8. Preharvest Factors ..... 28
- 3. PRE-HARVEST FACTORS AFFECTING QUALITY AND SHELF LIFE ..... 30**
  - 1. GENETIC FACTORS ..... 30
  - 2. CLIMATIC CONDITIONS ..... 31
  - 3. MINERAL NUTRITION ..... 31
    - 3.1. Nitrogen ..... 32
    - 3.2. Phosphorus ..... 32
    - 3.3. Potassium ..... 33
    - 3.4. Calcium ..... 33
    - 3.5. Effect of Organic Fertilizers and other Materials ..... 34
  - 4. PRE-HARVEST TREATMENTS ..... 34
    - 4.1. Pre-harvest Treatments with Fungicides ..... 34
    - 4.2. Growth Regulating Chemicals ..... 35
  - 5. CULTURAL PRACTICES ..... 37
    - 5.1. Field sanitation ..... 37
    - 5.2. Mulching ..... 37
    - 5.3. Tillage ..... 37

|  |           |
|--|-----------|
| 5.4. Covering/bagging .....  | 38        |
| 5.5. Pruning and Thinning .....  | 38        |
| 5.6. Trellising .....  | 38        |
| 5.7. Irrigation .....  | 39        |
| 5.8. Pesticides and Herbicides .....                                   | 39        |
| 5.9. Blanching .....   | 39        |
| 6. MATURITY AT HARVEST IN RELATION<br>TO QUALITY .....                 | 40        |
| 7. METHOD OF HARVESTING IN RELATION<br>TO UNIFORMITY OF MATURITY ..... | 40        |
| <b>4. MATURATION AND MATURITY INDICES .....</b>                        | <b>42</b> |
| 1. MATURITY .....  | 42        |
| 2. TYPES OF MATURITY .....   | 43        |
| 3. IMPORTANCE OF MATURITY INDICES .....                                | 43        |
| 4. METHOD OF DETERMINING MATURITY<br>AND QUALITY .....                 | 44        |
| 4.1. Days after Full Bloom .....                                       | 44        |
| 4.2. Size and Shape .....  | 46        |
| 4.3. Colour .....  | 47        |
| 4.4. Calendar Date .....   | 51        |
| 4.5. Heat Units .....  | 51        |
| 4.6. Gloss .....   | 51        |
| 4.7. Firmness .....  | 52        |
| 4.8. Chemical Measurements .....                                       | 53        |
| 5. MATURITY INDICES FOR SOME VEGETABLES .....                          | 56        |
| <b>5. HARVESTING AND FIELD HANDLING .....</b>                          | <b>58</b> |
| 1. HARVESTING AND FIELD HANDLING .....                                 | 59        |
| 1.1. Handle with Care .....  | 59        |
| 1.2. Goals of Harvesting .....   | 59        |
| 1.3. Objectives of Grower .....  | 59        |
| 1.4. Planning .....  | 59        |
| 1.5. Labour .....  | 60        |
| 1.6. Conditions Right for Harvesting a Crop .....                      | 61        |
| 2. METHOD OF HARVESTING .....  | 62        |
| 3. HANDLING DURING HARVEST .....                                       | 64        |
| 4. GENERAL DO'S AND DON'TS REGARDING<br>HARVESTING .....               | 66        |

|   |           |
|---|-----------|
| <b>6. COOLING DELAY AND PRE-COOLING .....</b>   | <b>68</b> |
| 1. COOLING DELAY .....                          | 68        |
| 1.1. Respiration .....                          | 68        |
| 1.2. Water Loss .....                           | 69        |
| 1.3. Decay .....                                | 70        |
| 2. PRE-COOLING .....                            | 70        |
| 2.1. Measurement of Pre-cooling Rate .....      | 70        |
| 2.2. Methods of Pre-cooling .....               | 72        |
| 2.3. Comparison Among Cooling Methods .....     | 82        |
| 2.4. Selection of Cooling Method .....          | 83        |
| <b>7. PACK-HOUSE OPERATIONS .....</b>           | <b>88</b> |
| 1. PACK HOUSE OPERATIONS .....                  | 88        |
| 1.1. Dumping .....                              | 89        |
| 1.2. Pre-sorting .....                          | 90        |
| 1.3. Cleaning/Washing .....                     | 90        |
| 1.4. Trimming/Topping .....                     | 91        |
| 1.5. Sizing/Grading .....                       | 91        |
| 1.6. Bunching/Wrapping .....                    | 92        |
| 2. PLANNING A PACK-HOUSE .....                  | 92        |
| 2.1. Site Selection .....                       | 92        |
| 2.2. Flow of Produce .....                      | 93        |
| 2.3. Internal Layout .....                      | 93        |
| 2.4. Constructional Details .....               | 94        |
| 2.5. Equipment and Machinery .....              | 95        |
| 3. PACK-HOUSE MANAGEMENT .....                  | 97        |
| 3.1. Meeting Market Requirements .....          | 97        |
| 3.2. Procurement and Control .....              | 97        |
| 3.3. Supplies of Packing Materials .....        | 97        |
| 3.4. Disposal of Low-grade Produce .....        | 97        |
| 3.5. Staffing .....                             | 98        |
| 3.6. Staff Training .....                       | 98        |
| 3.7. Grower Training .....                      | 98        |
| 3.8. Accounting and Costing of Operations ..... | 98        |
| 3.9. Documentation and Accounting .....         | 98        |
| <b>8. SORTING AND GRADING .....</b>             | <b>99</b> |
| 1. SORTING OF VEGETABLES .....                  | 99        |
| 2. GRADING OF VEGETABLES .....                  | 100       |

|           |   |            |
|-----------|---|------------|
| 3.        | TYPES OF GRADERS .....  | 102        |
| 3.1.      | Screen Graders .....  | 102        |
| 3.2.      | Mechanical Weight Grader .....  | 102        |
| 3.3.      | Diverging Roller Grader .....   | 102        |
| 3.4.      | Expanding Belt Grader .....   | 103        |
| 3.5.      | Expanding Opening Roller Grader .....   | 104        |
| 3.6.      | Roller Sorter .....   | 104        |
| 3.7.      | Computerized Grades for Size, Weight, Colour, TSS,<br>Firmness and Internal Defects ..... | 105        |
| 4.        | GRADE DESIGNATION AND QUALITY<br>OF VEGETABLES .....                                      | 105        |
| 4.1.      | Grade Designation and Quality of Shelling Peas .....                                      | 106        |
| 4.2.      | Grade Designation and Quality of Snow Peas<br>and Sugar Snap Peas .....                   | 109        |
| 4.3.      | Grade Designation and Quality of Ribbed Celery .....                                      | 111        |
| 4.4.      | Grade Designation and Quality of Spinach .....  | 113        |
| 4.5.      | Grade Designation and Quality of Headed Cabbages .....                                    | 115        |
| 4.6.      | Grade Designation and Quality of Brussels Sprouts .....                                   | 118        |
| 4.7.      | Grade Designation and Quality of Tomatoes .....   | 120        |
| 4.8.      | Grade Designation and Quality of Garlic .....   | 124        |
| 4.9.      | Grade Designation and Quality of Onions .....   | 128        |
| 4.10.     | GRADE DESIGNATION OF POTATO .....   | 132        |
| <b>9.</b> | <b>POST-HARVEST TREATMENTS .....</b>  | <b>133</b> |
| 1.        | CHEMICAL TREATMENTS .....   | 133        |
| 1.1.      | Washing with Chlorine Solution .....  | 133        |
| 1.2.      | Growth Regulator/fungicide Treatments .....   | 133        |
| 1.3.      | Calcium Application .....   | 134        |
| 1.4.      | Lime Powder Application .....   | 134        |
| 1.5.      | 1-Methylcyclopropene (1-MCP) Application .....  | 134        |
| 2.        | THERMAL TREATMENTS .....  | 135        |
| 2.1.      | Hot Water Dips and Sprays .....   | 135        |
| 2.2.      | Vapour Heat Treatment (VHT) .....   | 136        |
| 2.3.      | Hot Air .....   | 137        |
| 3.        | SPROUT SUPPRESSION .....  | 137        |
| 3.1.      | Refrigeration and Controlled Atmospheres .....  | 137        |
| 3.2.      | Ionizing Radiation .....  | 138        |
| 4.        | WAXING .....  | 138        |

|            |   |            |
|------------|---|------------|
| 5.         | ESSENTIAL OILS FOR THE CONTROL OF<br>POSTHARVEST PATHOGENS .....    | 140        |
| 6.         | CONTROLLED/MODIFIED ATMOSPHERE<br>TREATMENTS .....                  | 140        |
| 7.         | CURING ROOT, TUBER AND BULB CROPS .....                             | 141        |
| 7.1.       | Field Curing .....  | 142        |
| 7.2.       | Curing Assisted by Shade and Ventilation .....                      | 143        |
| 7.3.       | Curing with Heated Air .....  | 143        |
| 7.3.       | Bulk Systems for Curing Onions .....                                | 144        |
| 7.4.       | Emergency Curing .....  | 144        |
| 8.         | TREATMENTS TO ENHANCE UNIFORMITY<br>IN FRUIT RIPENING .....         | 144        |
| <b>10.</b> | <b>PACKAGING .....</b>  | <b>147</b> |
| 1.         | WHAT IS PACKAGING? .....  | 147        |
| 2.         | FUNCTION OF PACKAGES .....  | 147        |
| 2.1.       | Physical Container .....  | 148        |
| 2.2.       | Protection .....  | 148        |
| 2.3.       | Identification .....  | 148        |
| 3.         | UNIVERSALLY STANDARDIZED REQUIREMENT<br>FOR PACKAGING .....         | 148        |
| 4.         | PACKAGING MATERIALS .....   | 149        |
| 4.1.       | Transport/ Bulk Packs .....   | 149        |
| 4.2.       | Consumer Packs .....  | 155        |
| 5.         | TYPES OF PACKAGES .....   | 157        |
| 5.1.       | Primary Package .....   | 157        |
| 5.2.       | Secondary Package .....   | 158        |
| 5.3.       | Tertiary Package .....  | 158        |
| 5.4.       | Quaternary Package .....  | 161        |
| 6.         | USE OF PACKAGE INSERTS, FILLERS AND LINERS ...                      | 161        |
| 6.1.       | Fiber Board Divider .....   | 161        |
| 6.2.       | Wooden Corners .....  | 161        |
| 6.3.       | Polyethylene Liner .....  | 162        |
| 6.4.       | Foam Sleeve .....   | 162        |
| 7.         | LABELING .....  | 162        |
| 8.         | GENERAL DO'S AND DON'TS FOR PACKAGING HIGH<br>QUALITY PRODUCE ..... | 163        |
| 9.         | MODIFIED ATMOSPHERE PACKAGING (MAP) .....                           | 164        |
| 9.1.       | Passive vs. Active MAP .....  | 165        |



|   |            |
|---|------------|
| 9.2. Characteristics of Packaging Material for MAP .....  | 165        |
| 9.3. MAP Design.....  | 166        |
| 9.4. Gas Composition (O <sub>2</sub> , CO <sub>2</sub> ) Requirements of Selected<br>Vegetables ..... | 168        |
| 9.5. Application of MAP in Vegetables .....   | 169        |
| 9.6. Advantages of MAP.....   | 171        |
| 9.7. Disadvantages of MAP .....   | 172        |
| 9.8. Problems with MAP .....  | 172        |
| 9.9. New and Emerging MAP Technologies .....  | 174        |
| 9.10. Do's and Don't of MAP .....   | 178        |
| 9.11. Future Research Needs .....   | 178        |
| <b>11. ETHYLENE AND RIPENING .....</b>  | <b>179</b> |
| 1. ETHYLENE .....   | 179        |
| 2. HOW THE ROLE OF ETHYLENE WAS DISCOVERED .  | 180        |
| 3. ETHYLENE BIOSYNTHESIS.....   | 180        |
| 4. ETHYLENE PRODUCTION AND SENSITIVITY .....  | 183        |
| 5. WHAT IS RIPENING?.....   | 184        |
| 6. CATEGORIES OF FRUITS .....   | 184        |
| 7. HOW FRUIT RIPENS? .....  | 185        |
| 8. METHODS FOR ARTIFICIAL RIPENING .....  | 185        |
| 8.1. Ripening with Calcium Carbide .....  | 185        |
| 8.2. Ripening with Ethephon .....   | 186        |
| 8.3. Ripening with Ethylene gas<br>(Internationally acceptable technique) .....                       | 187        |
| 9. WHICH METHOD OF ETHYLENE APPLICATION<br>TO USE? .....  | 192        |
| 10. OPTIMUM CONDITIONS FOR RIPENING INITIATION  | 192        |
| 11. DAMAGING EFFECT OF ETHYLENE .....   | 193        |
| 11.1. Accelerated Senescence .....  | 194        |
| 11.2. Induction of Physiological Disorders .....  | 194        |
| 11.3. Isocoumarin Formation .....   | 194        |
| 11.4. Sprouting .....   | 194        |
| 11.5. Abscission of Leaves and Flowers .....  | 195        |
| 11.6. Toughening of Asparagus .....   | 195        |
| 11.7. Reduce Firmness .....   | 195        |
| 11.8. Reduction of Post-harvest Diseases.....   | 195        |
| 12. ETHYLENE POLLUTION SOURCES .....  | 195        |

|  |            |
|--|------------|
| 13. REDUCING THE DAMAGING EFFECTS .....  | 196        |
| 13.1. Eliminating Sources of Ethylene .....  | 197        |
| 13.2. Ventilation .....  | 197        |
| 13.3. Chemical Removal .....   | 197        |
| 13.4. Ultraviolet Lamps .....  | 198        |
| 13.5. Catalytic Oxidizers .....  | 198        |
| 13.6. Bacterial Systems .....  | 198        |
| 13.7. Specific Antiethylene Compounds .....  | 199        |
| <b>12. STORAGE .....</b>   | <b>200</b> |
| 1. GOALS OF STORAGE .....  | 200        |
| 2. UNDESIRABLE EFFECTS ON VEGETABLES DUE TO SHARING OF SAME STORAGE AREA .....                 | 201        |
| 2.1. Chilling Injury .....   | 201        |
| 2.2. Undesirable Ethylene Effects .....  | 202        |
| 2.3. Odour Contamination .....   | 202        |
| 3. REQUIREMENTS AND GENERAL CHARACTERISTICS FOR A STORAGE FACILITY .....                       | 203        |
| 4. STORAGE SYSTEMS .....   | 204        |
| 4.1. Refrigerated/low Temperature Storage .....  | 204        |
| 4.2. Controlled Atmosphere (CA) Storage .....  | 206        |
| 4.3. Hypobaric Storage or Low-pressure Storage (LPS) .....                                     | 211        |
| 4.4. Evaporative Cool Storage .....  | 213        |
| 5. ALTERNATIVE COOLING STRATEGIES .....  | 215        |
| 5.1. Natural or Field Storage (on-farm storage) .....  | 215        |
| 5.2. Night Air Ventilation .....   | 216        |
| 6. ROOT AND TUBER CROPS STORAGE .....  | 218        |
| 7. DRIED AND BULB CROPS STORAGE .....  | 222        |
| 7.1. Bottom Ventilated Storage Structures .....  | 223        |
| 7.2. Top and Bottom Ventilated Storage Structure .....   | 224        |
| 7.3. Low Cost Bottom Ventilated Structure .....  | 224        |
| 7.4. Points to be Consider for Construction of Storage Structures for Dried Bulb Storage ..... | 225        |
| 8. GENERAL DO'S AND DON'TS FOR STORAGE OF HIGH QUALITY VEGETABLE CROPS .....                   | 226        |
| <b>13. TRANSPORTATION.....</b>   | <b>228</b> |
| 1. SELECTION OF TRANSPORT MODE .....   | 228        |
| 2. HOW TO MAINTAIN QUALITY DURING TRANSPORTATION .....   | 229        |
| 2.1. Design Conditions of the Transport Equipment .....  | 229        |

|  |            |
|--|------------|
| 2.2. Produce Temperature at Loading .....  | 229        |
| 2.3. Load/Stacking Pattern .....   | 230        |
| 2.4. Stabilization and Bracing the Load .....                                      | 231        |
| 2.5. Loading of Vehicle .....  | 232        |
| 2.6. Ambient Temperature and Transit Time .....                                    | 232        |
| 2.7. Packages .....  | 233        |
| 2.8. Condition of Transit Vehicle .....  | 233        |
| 2.9. Mixed Loads .....   | 233        |
| 2.10. Product Compatibility .....  | 234        |
| 3. TRANSPORTATION METHODS .....  | 235        |
| 3.1. Domestic .....  | 235        |
| 3.2. International Transport .....   | 237        |
| 4. GENERAL DOS AND DON'TS REGARDING<br>TRANSPORTATION OF HIGH QUALITY PRODUCE ...  | 239        |
| <b>14. DESTINATION HANDLING .....</b>  | <b>241</b> |
| 1. LOADING AND UNLOADING .....   | 242        |
| 2. TEMPORARY STORAGE .....   | 243        |
| 3. REPACKAGING .....   | 245        |
| 4. RIPENING .....  | 246        |
| 5. DISPLAY .....   | 246        |
| 6. GENERAL DO'S AND DON'TS FOR HANDLING<br>PRODUCE AT THE DESTINATION MARKET ..... | 247        |
| <b>15. MARKETING OF VEGETABLES .....</b>   | <b>249</b> |
| 1. THE MARKETING CHANNELS .....  | 250        |
| 2. MARKETING VERSUS SELLING .....  | 251        |
| 3. OPERATORS IN THE MARKETING .....  | 252        |
| 3.1. Farmers .....   | 252        |
| 3.2. Traders .....   | 252        |
| 3.3. Commission Agents .....   | 253        |
| 3.4. Wholesalers .....   | 253        |
| 3.5. Retailers .....   | 253        |
| 4. TYPES OF MARKETING .....  | 254        |
| 4.1. Wholesale Marketing .....   | 254        |
| 4.2. General Do's and Don'ts for Wholesale Marketing .....                         | 260        |
| 4.3. Retail Marketing .....  | 260        |
| 5. MARKETING STRATEGIES .....  | 266        |
| 5.1. Supply of Produce .....   | 266        |
| 5.2. Market Information .....  | 267        |

|            |   |            |
|------------|---|------------|
| 6.         | CONSTRAINTS IN FRESH VEGETABLES                     |            |
|            | MARKETING .....                                     | 269        |
| 7.         | STRATEGIES FOR IMPROVEMENT IN MARKETING ...         | 271        |
|            | 7.1. Development of a Plan .....                    | 271        |
|            | 7.2. Training of Marketing Personnel .....          | 272        |
|            | 7.3. Marketing Research Services .....              | 272        |
|            | 7.4. Assistance to Small Farmers .....              | 273        |
|            | 7.5. ROLE FOR ENTREPRENEURS .....                   | 274        |
| <b>16.</b> | <b>EXPORT OF VEGETABLES .....</b>                   | <b>276</b> |
| 1.         | STRENGTHS .....                                     | 276        |
| 2.         | WEAKNESSES .....                                    | 277        |
| 3.         | EXPORT PERFORMANCE OF INDIAN HORTICULTURE           |            |
|            | SECTOR .....  | 278        |
| 4.         | IMPORTING COUNTRIES .....                           | 281        |
|            | 4.1. Indian or Ethnic Vegetable .....               | 281        |
|            | 4.2. Exotic Vegetable .....                         | 282        |
| 5.         | MARKET FOR THE ORGANIC PRODUCE .....                | 283        |
| 6.         | THE MARKETS IN SOUTH-EAST ASIA .....                | 283        |
| 7.         | COMPETING COUNTRIES IN VEGETABLE EXPORT ...         | 284        |
| 8.         | ESTABLISHMENT OF AGRI-EXPORT ZONES (AEZS)           |            |
|            | BY APEDA .....                                      | 284        |
| 9.         | PERIOD OF REQUIREMENT .....                         | 286        |
| 10.        | PRODUCING POCKETS .....                             | 286        |
| 11.        | VEGETABLES SPECIFICATION FOR EXPORT .....           | 287        |
| 12.        | WHAT IS GLOBALGAP .....                             | 287        |
| 13.        | PROTOCOLS FOR POST-HARVEST HANDLING OF              |            |
|            | VEGETABLES FOR EXPORT .....                         | 289        |
|            | 13.1. Snow pea/ Sugar snap .....                    | 289        |
|            | 13.2. Carrot .....                                  | 289        |
|            | 13.3. French Bean .....                             | 289        |
|            | 13.4. Baby Corn .....                               | 290        |
|            | 13.5. Okra .....                                    | 290        |
|            | 13.6. Bitter Gourd .....                            | 291        |
|            | 13.7. Onion .....                                   | 291        |
| 14.        | STRATEGIES TO IMPROVE EXPORT .....                  | 292        |
|            | 14.1. Selection of End use Specific Varieties ..... | 292        |
|            | 14.2. Changes in Agriculture Produce Marketing      |            |
|            | Act (APMA) .....                                    | 292        |

|   |            |
|---|------------|
| 14.3. Contract Farming .....  | 292        |
| 14.4. Development of Supply Chain Infrastructure .....  | 292        |
| 14.5. Certification for Exports .....   | 293        |
| 14.6. Documentation for Organic Produce .....   | 293        |
| 14.7. Improvement in the Domestic Markets .....   | 293        |
| 14.8. Improvements in Economics by Waste Utilization .....                                      | 294        |
| 14.9. Strategies for Cost Reduction .....   | 294        |
| 14.10. Improving Market Intelligent System (MIS) .....  | 294        |
| 14.11. Linking Small Farmers to the Process .....   | 294        |
| 14.12. Knowledge of Sanitary and Phytosanitary (SPS)<br>Requirements of Importing Country ..... | 294        |
| 15. PESTICIDE RESIDUE LIMITS FOR EXPORT OF FRESH<br>VEGETABLES .....                            | 295        |
| 16. MANAGEMENT OF PESTICIDE RESIDUES .....  | 300        |
| 17. CONCLUSION .....  | 301        |
| <b>17. FRESH-CUT VEGETABLES .....</b>   | <b>302</b> |
| 1. VEGETABLES SUITABLE FOR FRESH CUT PRODUCE  | 303        |
| 2. KEY REQUIREMENTS OF FRESH-CUT VEGETABLES   | 303        |
| 3. REASONS FOR QUALITY CHANGES IN FRESH-CUT<br>PRODUCE .....                                    | 303        |
| 3.1. Physiological and Biochemical Changes .....  | 304        |
| 3.2. Microbiological Changes .....  | 305        |
| 3.3. Safety Aspects of Fresh-cut Produce .....  | 305        |
| 3.4. Nutritional Changes .....  | 306        |
| 4. FACTORS EFFECTING QUALITY AND SHELF LIFE OF<br>FRESH-CUT VEGETABLES .....                    | 306        |
| 4.1. Colour .....   | 306        |
| 4.2. Texture .....  | 307        |
| 4.3. Respiration Rate .....   | 307        |
| 4.4. pH .....   | 308        |
| 4.5. Microbiology .....   | 308        |
| 4.6. Sensory Evaluation .....   | 308        |
| 4.7. Nutritional Content .....  | 309        |
| 5. OPERATIONS IN FRESH-CUT PRODUCT<br>PREPARATION .....   | 309        |
| 5.1. Intelligent Inspection .....   | 309        |
| 5.2. Product Flow .....   | 309        |
| 5.3. Preliminary Washing and Sorting .....  | 310        |

|   |     |
|---|-----|
| 5.4. Peeling .....  | 310 |
| 5.5. Size Reduction/Cutting .....   | 310 |
| 5.6. Size and Defect Sorting .....  | 310 |
| 5.7. Washing/Cooling .....  | 311 |
| 5.8. Dewatering .....   | 312 |
| 5.9. Packaging .....  | 312 |
| 6. METHODS TO IMPROVE THE QUALITY AND SHELF<br>LIFE OF FRESH-CUT VEGETABLES ..... | 313 |
| 6.1. Raw Materials .....  | 313 |
| 6.2. Peeling, Cutting and Shredding .....   | 315 |
| 6.3. Cleaning, Washing and Drying .....   | 316 |
| 6.4. Control of Tissue Softening .....  | 316 |
| 6.5. Browning Inhibition .....  | 316 |
| 6.6. Modified Atmosphere Packaging (MAP) .....                                    | 317 |
| 6.7. Active Packaging .....   | 318 |
| 6.8. Edible Films and Coatings .....  | 318 |
| 6.9. Irradiation .....  | 319 |
| 6.10. Ultraviolet Light .....   | 319 |
| 6.11. Hurdle Technology .....   | 319 |
| 7. COMMERCIAL PACKAGING AND STORAGE OF<br>IMPORTANT FRESH-CUT VEGETABLES .....    | 320 |
| 7.1. Broccoli (Florets) .....   | 320 |
| 7.2. Cabbage (Shredded, Diced) .....  | 320 |
| 7.3. Chinese Cabbage (Sliced, Sticks, Shredded) .....                             | 321 |
| 7.4. Butterhead Lettuce (chopped, shredded, whole leaf) .....                     | 321 |
| 7.5. Spinach (whole leaves, cut leaves) .....                                     | 322 |
| 7.6. Carrots<br>(diced, shredded, sticks, peeled, grated, sliced, cubes)....      | 322 |
| 7.7. ONIONS (Diced, slivered, rings, chunks) .....                                | 323 |
| 7.8. Garlic (peeled) .....  | 323 |
| 7.9. Potato (sticks, diced, sliced, peeled) .....                                 | 324 |
| 7.10. Tomato (Sliced, Diced) .....  | 324 |
| 7.11. Bell Pepper (Diced, Sliced) .....   | 325 |
| 8. TYPICAL POINTS TO REMEMBER FOR HIGH QUALITY<br>FRESH-CUT PRODUCE .....         | 325 |
| 9. FUTURE RESEARCH NEEDS .....  | 326 |
| <i>Literature Consulted</i> .....   | 327 |

डा. एच. पी. सिंह  
उप महानिदेशक (बागवानी)  
**Dr. H. P. Singh**  
DEPUTY DIRECTOR GENERAL (Horticulture)



भारतीय कृषि अनुसंधान परिषद  
कृषि अनुसंधान भवन-II,  
पूसा, नई दिल्ली 110 012  
**INDIAN COUNCIL OF AGRICULTURAL RESEARCH**  
KRISHI ANUSANDHAN BHAVAN-II,  
PUSA, NEW DELHI 110 012

## *Foreword*

Vegetable production has increased appreciably in last decade owing to increasing demand from health conscious population and changing dietary habits. Currently, vegetable production in Indian contributes 13.36% of the global production and occupies second position next to China. The export of fresh vegetables has also witnessed appreciable grow and most sought after vegetables are okra, tomato, baby corn, cucumber, gherkins, chillies, french bean, capsicum, bitter gourd, bottle gourd and onion. Scenario of vegetable production is highly appreciable but much losses up to 20-25 per cent is caused due to inappropriate postharvest handling, grading, packing, storage, transportation and ripening, which require to be put in place to reduce post harvest losses. Thus, the book entitled, “**Post harvest handling of Vegetable Crops**” assumes significance in providing all the information contained in this book will be useful for students, teachers, extension workers and all those interested in postharvest handling of vegetables. I compliment the author for these sincere efforts in bringing out this book for the benefit of all the stakeholders.

H.P. Singh

**drysrhu**



## *Preface*

Vegetable produce plays a significant role in human nutrition by supplying vitamins, minerals, dietary fibre and anti-oxidants to the diet. The quality and safety of vegetable produce reaching the consumer depends upon pre-harvest factors as well as post-harvest management practices throughout the chain, from the field to the consumer. There are some changes in vegetables after harvesting and mostly these are undesirable from consumer point of view. Postharvest changes in fresh vegetable produce cannot be stopped but these can be slow down within certain limits. The most common cause of postharvest losses includes rough handling, inadequate cooling and temperature maintenance, physical injuries, shrivelling, pest damage, physiological disorders, growth and development after harvest, contamination with pathogenic bacteria, pesticides and chemical residues etc. The lack of sorting to eliminate defect before storage, the use of inadequate packaging materials, lack of know-how, poor management and market dysfunction add to the problem. Therefore it is necessary to reduce these losses by adopting the postharvest techniques, which ultimately improve the shelf life of produce. The development of postharvest handling techniques and its use needs an inter-disciplinary and multi-dimensional approach which must include political will, scientific creativity, technological innovations, commercial entrepreneurship and institutions capable of interdisciplinary R&D, all of which must respond in an integrated manner to the developmental needs.

Growing populations across the India continue to create demand for fresh produce and processed vegetable products. Meeting these requirements as well as those of export markets necessitates assuring quality and safety in both domestic and export supply chains. Capacities must therefore be developed in the country in order to respond to consumer and market demand and to avert the risk of large numbers of small

farmers becoming marginalized. At the same time, Governments must develop a vision for the development of the postharvest sector and facilitate activities within the sector in order to realize that vision.

Basic approaches to reduce post-harvest losses and to maintain quality of vegetable produce are the same, regardless of the market to which this produce is targeted. In this book, an attempt has been made to provide the comprehensive information on postharvest handling of vegetables covering various aspects of pre and post-harvest handling including postharvest biology and technology, ripening, storage, packaging, transportation, destination handling, marketing, export and fresh-cut vegetables in the form of 17 chapters. In this book, the basic aspects of postharvest handling of vegetable crops are discussed in the very simple language. It is hoped that the information contained in this book will be useful for students, teachers, extension specialists and all those interested in postharvest handling of vegetables.

I appreciate the efforts made by Mr. Jitendra Jain of Narendra Publishing House in executing a good job in time. I am highly appreciable to my wife Dr. Shikha Dhall and my daughter Priyanshi who have always been affectionate, patient and protective in creating a congenial atmosphere that is so essential for successful completion of such a demanding task.

**R.K. DHALL**

# CHAPTER 1

## POSTHARVEST HANDLING: IMPORTANCE AND CONSTRAINTS

---

Postharvest handling is inter-disciplinary “Science and Technique” applied to agricultural produce after harvest for its protection, conservation, processing, packaging, distribution, marketing, and utilization to meet the food and nutritional requirements of the people in relation to their needs. It has to develop in consonance with the needs of each society to stimulate agricultural production; prevent post-harvest losses, improve nutrition and add value to the products. In this process, it must be able to generate employment, reduce poverty and stimulate growth of other related economic sectors. The process of development of postharvest handling and its purposeful use needs an inter-disciplinary and multi-dimensional approach which must include political will, scientific creativity, technological innovations, commercial entrepreneurship and institutions capable of inter-disciplinary R&D, all of which must respond in an integrated manner to the developmental needs. Building of the right type of socio-culturally oriented human resource is fundamental to this type of development.

Postharvest is also the central connecting link between the grower and the consumer, where the product flows from the grower to the consumer and cash from the consumer to the grower. Logically, the postharvest handling should comprise all the in-between techniques or methods right from the field till the crop reaches to consumer either as fresh commodity or processed products and finally the waste is utilized in a profitable manner.

## 1. PRESENT STATUS

India is the second largest producer of vegetables in the world (ranks next to China) and accounts for 13.36% of the world's production (2008-09) of vegetables. Vegetables are an important component of Indian agriculture due to their productivity, use in diversification, nutritional and medicinal values, value addition and export potential. The production of vegetables has increased from 58.53 million tons in 1991-92 to 129.07 million tons in 2008-09. At present, Indian accounts for 13.36 percent of world production of vegetables and ranks first in production of okra and peas and second in brinjal, cabbage, cauliflower, potato and onion. The productivity of vegetables has increased from 15.2 tons/ha in 2005-06 to 16.2 tons/ha in 2008-09. In spite of huge production and productivity, the postharvest losses in vegetable crops are estimated to be 25-30% due to its highly perishable nature. The perishable nature of the produce coupled with improper postharvest handling and poor infrastructure facilities, results in very high wastage, which in some crops, handling situations and seasons may be as high as 40%.

Postharvest losses can occur in the field, in packing area, in storage, during transportation, in the wholesale and retail market. The most common cause of postharvest losses in developing countries includes rough handling and inadequate cooling and temperature maintenance. Physical injuries, shrivelling, pest damage, physiological disorders, growth and development after harvest, contamination with pathogenic bacteria, pesticides and chemical residues etc. are the primary causes of losses. The lack of sorting to eliminate defect before storage, the use of inadequate packaging materials, lack of know-how, poor management and market dysfunction add to the problem. Reduction of postharvest losses reduces cost of production, trade and distribution, lowers the price for the consumer and increases the farmers' income. Thus any additional production efforts will be negated if higher postharvest losses are to follow. It is indeed a waste of scarce resources (labour, water, fertilizer, pesticides etc.) to produce more to cover up the losses caused by inappropriate postharvest handling. To reduce these losses, producers and handlers like wholesalers, agents, sub wholesalers and retailers must understand biological and environmental factors involved in deterioration and use of postharvest handling techniques to minimize these losses so that best possible quality could be maintained.

## 2. OBJECTIVES OF POSTHARVEST HANDLING

The three main objectives of applying postharvest practices to harvested vegetables are:

- To maintain quality (appearance, texture, flavour and nutritional value)
- To protect food safety
- To reduce losses between harvest and consumption

Effective management during the postharvest period, rather than the level of sophistication of any given technology, is the key in reaching the desired objectives.

## 3. CHANNELS OF POST HARVEST LOSSES

Postharvest losses occur at each and every step of the value chain. These can be classified as losses at the farm level, losses at the wholesaler's level and losses at the retailer's level. They vary according to the influence of factors such as the perishability of the commodity; ambient temperature and relative humidity which determine the natural course of decay; fungal and bacterial decay; damage by pests -insects and birds; the length of time between harvesting and consumption; and practices of postharvest handling, storage and processing.

### 3.1. Farm Level

Farmers fail to link among themselves through effective producer organizations, which have the ability to undertake joint decisions in investment, production and marketing. Similarly, lack of information flow is a major constraint for taking informed decisions with regards to cropping plans as per market demand in terms of varieties, seasons, technology adoption and marketing.

Farmers have weak linkages with enterprises and often fail to link effectively to markets because of limited access to relevant market intelligence and inadequate market infrastructure. Farmers are also poorly linked to research and extension providers who have the ability to address their specific technological and knowledge needs. This would enable them to innovate into high value production systems.

### **3.2. Whole Sellers Level**

Most agencies fail to link with each other, particularly during implementation of national programs. Links between states and central agencies are often limited. Service providers from the public sector are often unable to provide effective services due to lack of funding, bureaucratic hurdles and the lack of a culture. Most NGOs are not used to working in the field of enterprise development and their presence in the agribusiness sector is marginal. Service providers from the private sectors are emerging but are mainly oriented to the needs of corporate clients rather than small and medium enterprises or producer groups that dominate total production.

### **3.3. Retail Level/Consumer Level**

Marketing and processing companies exist in isolation; have weak linkages with farmers and being distant from consumers because of the absence of organized retail chains. This culminates into a typical situation where the enterprise does not get consistent supply of raw material and farmers suffer on account of poor market linkages. The absence of proper certification, quality assurance systems and inadequate infrastructure continues to limit the integration of production with international markets.

## **4. CAUSES OF POSTHARVEST LOSSES**

Fresh vegetables are living tissue subject to continuous changes after harvesting. While some changes are desirable, most from consumer point of view are not. Postharvest changes in fresh vegetable produce cannot be stopped but these can be slow down within certain limits. Fresh vegetable crops are diverse in morphological structure (roots, stems, leaves, flowers and fruit) composition and in general physiology. Thus, commodity requirements and recommendations for maximum postharvest life may vary the commodity. The most common cause of postharvest losses includes rough handling and inadequate cooling and temperature maintenance. More over fresh vegetables are high in water content and thus are subject to desiccation (wilting and shriveling) and to mechanical injury. These are also susceptible to attack by bacteria and fungi, with the result pathological breakdown of the produce. Both biological and environmental factors are

involved in deterioration of vegetable produce. It would, therefore be desirable to understand these factors first.

#### **4.1. Physical/mechanical Losses**

Mechanical damage during harvest can become a serious problem as injuries predispose produce to decay, increased water loss and increased respiratory and ethylene production rate which all will lead to quick deterioration and hence causing quick loss in quality and storability of the produce. The principal postharvest decaying pathogen (*Pencillium*, *Botrytis* etc.) can not infect uninjured healthy vegetables under normal condition, so the enhanced rooting is aided by mishandling. The injury caused to produce during harvesting not only spoils the commodity appearance but also make it unfit for long term storage and long distance transport. Thus it is imperative to develop and follow certain strategies to minimize these injuries to vegetables. The mechanical injury can occur at any stage from production to marketing because of impact, harvesting, abrasion, puncturing and bruising.

##### **4.1.1. Impact injuries**

These type of injuries results from dropping the product onto a hard surface, dropping the picked product on the ground, into basket/boxes with sharp edges and rough inner surfaces, excessive drops during loading and unloading, suddenly stopping or accelerating of a vehicle, over packing of produce etc. Under Indian conditions, with exception of some low moisture containing crops like onion, garlic etc., mechanical injuries were mostly induced either due to faulty harvesting and collection, transportation and loading/unloading.

##### **4.1.2. Harvesting injuries**

These injuries are resulted from wrong method of harvesting. Potato and other underground crops can be easily damaged by careless digging and are often pierced or sliced by tools used while turning the soil to expose the produce. During harvesting, pulling the fruits from the plant always

result in injuries at the stem-end which act as entry point for moulds and bacteria causing decay, increase water loss from the damaged area; cause an increase in respiration rate, thus heat production and ethylene production.

#### **4.1.3. Abrasion injuries**

These injuries results when the produce is not properly packed or in under-filled boxes and move within a container because of the vibrations during the movement of the vehicles with small wheels and bad shock-absorbs, weak crates, bad roads, transmission vibration etc.

#### **4.1.4. Puncturing injuries**

These injuries results from nails or splinters from the crate or box, fingers or nails of a person, other crates, fork-lefts, hard and sharp stalks of fruits etc. Stem-stubs with picked fruits damage/pierces the adjacent fruits during handling.

#### **4.1.5. Bruising injuries**

These injuries leaves the skin intact and may not be visible externally and increases respiration rate in climacteric fruits such as tomatoes, apples, stone fruits and bananas which further cause internal discolouration because of damaged tissues.

### **4.2. Microbial Losses**

Fresh vegetables can become microbiologically contaminated at any point along the farm-to-table food chain. Like any other food, vegetables are prone to microbial spoilage caused by fungi, bacteria, yeasts and moulds. A significant portion of losses of vegetables during postharvest is attributed to diseases caused by fungi and bacteria. Succulent nature of the vegetables makes them easily affected by the organisms. Besides attacking fresh vegetables, the organisms also cause damage to canned and processed products. Many serious postharvest diseases of fresh vegetables occur rapidly and cause extensive breakdown of the commodity and



sometimes spoilage of the entire package. It is estimated that 36% of the vegetable decay is caused by soft rot bacteria. Obviously, the source of infection is soil in the field (Human and/or animal faeces), water used for irrigation (sewage water), cleaning and surface contact with equipment and storage environment. Worker hygiene and sanitation practices during production, harvest, sorting, packing, and transport play a critical role in minimizing the potential for microbial contamination of fresh produce. Most of the pathogens can invade only the damaged tissue; a few such as *Colletotrichum* are able to penetrate the skin of healthy tissue. High temperature and relative humidity favours the development of postharvest decay organisms. More acidic tissue is generally attacked by fungi, while vegetables having pH above 4.5 are more commonly attacked by bacteria, e.g. bacterial soft rot of potato by *Erwinia* spp. and dry rot by *Fusarium* spp., black rot of sweet potato by *Ceratocystis fimbriata*, water soft rot of carrot by *Sclerotinia sclerotium* and leafy vegetables soft rot by *Erwinia carotovora* and dry rot by *Fusarium* spp. Microorganisms attack fresh produce easily and spread quickly, because the produce does not have much of a natural defence mechanism and has plenty of nutrients and moisture to support microbial growth.

### 4.3. Physiological Disorders

Physiological disorders can result from factors like very high and low temperatures, relative humidity etc. The main types of disorders are listed below-

#### 4.3.1. Heat injury

High temperature conditions are injurious to perishable vegetables. Transpiration is vital to maintain optimal growth temperatures in growing plants. Organs removed from the plant, however, lack the protective effects of transpiration, and direct sources of heat, such as sunlight, can rapidly elevate the temperature of tissues to above the thermal death point of their cells, leading to localized bleaching, necrosis (sunburn or sunscald) or general collapse.

### **4.3.2. Relative humidity (RH)**

RH can influence water loss, decay development, the incidence of some physiological disorders, and uniformity of fruit ripening. Water loss is directly proportional to the vapor pressure difference (VPD) between the commodity and its environment. VPD is inversely related to the RH of the air surrounding the commodity. Condensation of moisture on the commodity (sweating) over long periods of time is probably more important in enhancing decay than is the RH of ambient air.

### **4.3.3. Freezing injury**

Vegetables are generally high in water content, and possess large, highly vacuolate cells. The freezing point of their tissues is relatively high (ranging from -3 °C to -0.5 °C), and disruption caused by freezing generally results in immediate collapse of their tissues and a total loss of cellular integrity. Freezing injury occurrence depends on the commodity. Some can be repeatedly frozen and thawed without damage, while others are ruined by one freezing. Freezing occurs in cold storage systems either due to inadequate refrigerator design, or to thermostat failure. Freezing can also occur upon exposure to inclement weather conditions as occurs when produce is allowed to remain for even short period of time on unprotected transportation docks during winter. Injured produce should be marketed immediately, as freezing shortens its storage life.

### **4.3.4. Chilling injury**

Some commodities (chiefly those native to the tropics and subtropics) respond unfavorably to storage at low temperatures which are well above their freezing points, but below a critical temperature termed their chilling threshold temperature or lowest safe temperature. Cooler temperatures interfere with normal metabolic processes. Injury symptoms varied and often do not develop until the produce has been returned to warmer temperatures for several days. Chilling injury is manifested in a variety of symptoms including surface and internal discoloration, pitting, water soaking, failure to ripen, uneven ripening, development of off flavors and heightened susceptibility to pathogen attack.

#### 4.4. Physiological and Biochemical Aspects

The quality of the harvested vegetable depends on the condition of growth as well as physiological and biochemical changes they undergo after harvest. Vegetable cells are still alive after harvest and continue their physiological activity. In fresh vegetables; transpiration, respiration, sprouting of tuber and bulb vegetables lead to direct food loss. The loss is accounted towards senescence process and represents major component of postharvest losses. Postharvest rooting in tuber vegetables, seed germination (e.g. chayote, tomato, pod vegetable), greening of potatoes leading to production of harmful compounds, toughening and sponginess in green bean, sweet corn, carrot and radish that represents physiological loss, though are not significant components of postharvest loss, lower down the quality of the vegetables. The undesirable chemical reactions between compounds present in food such as Maillard reaction, fat oxidation and energy catalyzed reactions lead to significant losses. Contamination of vegetables with harmful substances such as pesticides or obnoxious substances makes the whole lot un-consumable. Chemical reactions between canned vegetable and the container lead to spoilage of the pack.

#### 4.5. Other Factors of Postharvest Losses

In addition to genetic traits, environmental factors such as soil type, temperature, wind during fruit set, frost, and rainy weather at harvest can have adverse effects on storage life, suitability for shipping, and quality. Cultural practices may have dramatic impacts on postharvest quality. Inadequate storage facilities at producing or marketing centres leave the produce to the natural causes of losses-decay by organisms, respiration, transpiration and other biochemical reactions. Transportation and distribution of vegetables are the important areas of postharvest losses. Longer shipment and distribution periods eventually cause heavy losses. The presence or absence of legal standards can affect the eventual retention or rejection of a vegetable for human consumption. Strict legal standards will give better price to farmers and superior quality to consumer. Good Agricultural Practices during harvest operations and any subsequent postharvest handling, minimal or fresh-cut processing, and distribution to consumers must be developed.

**Table 1: Principal causes of postharvest losses and poor quality of vegetables**

| Group                              | Examples     | Principal causes of postharvest losses and poor quality |
|------------------------------------|--------------|---|
| Root vegetables                    | Carrots      | Mechanical injuries                                     |
|                                    | Beets        | Improper curing   |
|                                    | Onions       | Sprouting and roving                                    |
|                                    | Garlic       | Water loss (shriveling)                                 |
|                                    | Potato       | Decay   |
|                                    | Sweet Potato | Chilling injury (subtropical and tropical root crops)   |
| Leafy vegetables                   | Lettuce      | Water loss (wining)                                     |
|                                    | Chard        | Loss of green color (yellowing)                         |
|                                    | Spinach      | Mechanical injuries                                     |
|                                    | Cabbage      | Relatively high respiration rates                       |
|                                    | Green onions | Decay   |
| Flower vegetables                  | Artichokes   | Mechanical injuries                                     |
|                                    | Broccoli     | Yellowing and other discolorations                      |
|                                    | Cauliflower  | Abscission of florets                                   |
| Immature-fruit vegetables          | Cucumbers    | Decay   |
|                                    | Squash       | Over maturity at harvest                                |
|                                    | Eggplant     | Water loss (shriveling)                                 |
|                                    | Peppers      | Bruising and other mechanical injuries                  |
|                                    | Okra         | Chilling injury   |
|                                    | Snap beans   | Decay   |
| Mature-fruit vegetables and fruits | Tomato       | Bruising  |
|                                    | Melons       | Over-ripeness and excessive softening at harvest        |

## 5. IMPORTANCE OF POSTHARVEST HANDLING IN VEGETABLES

### 5.1. Reduce Postharvest Losses and Improve Shelf Life

The postharvest strategies for fresh vegetables are primarily concerned with lowering the respiration rate, loss of water, decay and the effect of injuries. The mechanical injuries are primarily man-made resulting from faulty picking, collecting, grading, packaging, transportation, loading and un-loading etc. The physiological reasons of quality deterioration may be effectively slowed down by temperature, RH and atmosphere management

i.e. postharvest movement of produce at lower temperature ensures the shelf-life extension in perishables. However, the cold stores should not be regarded as hospitals, where damaged produce can be repaired to improve quality. It may at best slow down rate of deterioration. A single rotting lot may infect the entire cold store and do more damage to produce. A few precautions like picking at proper maturity, using proper harvesting tools and containers, tender care during collection, pre-sorting, cleaning/washing, trimming/topping, grading, packaging, transportation, temperature and RH management etc. can help increase the shelf-life of most commodities for reasonable time. Further, only compatible crops should be transported and stored together in the same container/ chamber. Even microscopic injuries on the fruit surface is like an open wound inviting all sorts of pathogens and at high temperature the fruit juice serve as favourable multiplication media for fungi and bacteria.

## **5.2. Improve the Food Safety and Quality**

Fresh vegetables can become microbiologically contaminated at any point along the farm-to-table food chain. Postharvest handling of produce improves its quality and food safety because the produce goes through various postharvest operations i.e. grading, sorting, postharvest treatments, pre-cooling, packaging, cold storage, proper transportation and marketing.

## **5.3. Making Availability of Fresh Vegetables**

Postharvest industry has the enviable role to make the vegetable available throughout the year in a fresh condition by deploying modern technologies like ripening manipulation, refrigeration, freezing, CA storage, MAP, irradiation and postharvest treatments.

## **5.4. Export Earning and Strengthening Nation Conomy**

Export of fresh vegetables to earn valuable foreign exchange is the major spin-off benefit of the postharvest industry. It is evident from the fact that India export's of fresh vegetables has increased from Rs 1902.44 crores in 2007-08 to Rs 7996.62 crores in 2009-10. Moreover, India is strategically located, being close to the Middle-East and South-East Asian

countries i.e. it is easy to export in these countries. Postharvest handling of vegetables has immense potential to contribute to the economy of nation, which reflected in the GDP. At present, horticulture sector contributes about 28 per cent towards agriculture GDP from only about 13 per cent of the cultivated area.

### **5.5. Employment Generation**

With the development of postharvest industry, the ancillary industries are also established resulting in employment generation as well as industrialization of vegetable growing belt. It also offers ample opportunities to self-employment. Being seasonal, this industry provides jobs to the casual labour also. The production, postharvest handling, marketing, and processing of horticultural produce generate lot of employment in rural areas for women and unskilled workers.

### **5.6. Waste Utilization**

The vegetable postharvest industry can convert even the waste from produce into number of value added products and thus can stabilize the economy of the postharvest unit.

### **5.7. Add Taste, Variety and Provide Nutrition**

Vegetable provide nutrition besides adding taste to the food. The fresh-cut and processed vegetables are gaining popularity among urban people due to time scarcity. The industry offers the consumers product for use in the off-season, in affordable packs.

## **6. IMPROVEMENT NEEDED IN POSTHARVEST HANDLING OF VEGETABLES**

- Adequate inputs need to be provided for developing infrastructure for postharvest handling of vegetables.
- The dominance of the middleman and traders in marketing of vegetables should be eliminated/ minimized.

- Establishing and encouraging vegetable growers' association/ cooperatives to undertake various operations (grading, packaging and marketing of produce).
- Vegetable collection centres in production areas should be established.
- Storage facilities should be developed at the collection centres and at terminal markets.
- Need to improve indigenous low cost storage systems developed for onion, garlic, potato and other vegetable crops.
- Ripening facilities at the terminal markets needs to be developed.
- The public transport system should develop special facilities to cater to the needs of perishable so that it reaches the markets in good condition. These may include development of special compartmentalized rail wagons and trucks with cooling and ventilation arrangements.
- Packaging method for different vegetables need standardization and packaging materials should be made available and preferably, developed locally.
- Establishment of more processing units should be encouraged near the production areas, both by the private and public sector.
- Waste from the postharvest industry should be utilized for development of economically viable products.

## 7. FUTURE POST-HARVEST THRUST AREAS

- Postharvest physiology of vegetable produce
- Impact of pre-harvest and postharvest factors on shelf life and postharvest quality
- Genetic manipulation for long life, diseases and environmental-stress resistant cultivars
- Modeling cultivating conditions for high quality and long life (avoiding root stress by heat or drought).
- Objective determination of suitable harvesting date.
- Use of appropriate pre-cooling method for particular vegetable.
- Post harvest treatments (heat, UV, irradiation, CO<sub>2</sub>, chemicals) for storage ability.

## 14 | Post Harvest Handling of Vegetables

- Monitoring refrigerating systems
- Optimum storage conditions for fresh pack and lightly processed produce.
- Possibilities of modified atmosphere packaging (MAP), absorption layers, inserts sensors, PP films with micropores
- Prevention of possible pathogenic organisms in MAP products.
- Adaptive control of storage conditions with biological sensors.
- Storage during transport and as quarantine measures.
- Minimum impact and vibration norms for bruising during sorting and packaging.
- Objective non-destructive measuring of quality and maturity
- Environmental friendly packaging.
- Consumer and traders quality preferences in each country.
- Cost and return of the investment of postharvest technologies.
- Fundamental research on senescence, ripening, respiration, ethylene effect, chilling, fermentation, superficial browning.
- Conduct basic and applied research in CA/ modified atmospheric storage of high value perishable vegetables.

## 8. CONCLUSION

The postharvest handling and technology adoption is a continuous uninterrupted active process by chain of researchers, extension workers, growers and end users. Proper evaluation of postharvest technologies includes technical, economic and social components. It involves beneficiary participation throughout. Decisions to adopt new or improved technologies are made by individual farmers but their decisions are often strongly influenced by incentives and credit schemes, access to reliable sources of inputs, extension advice, training opportunities, and market information all of which are generally the responsibility of national governments or their agents.

Postharvest scientists must accept the challenges presented by the lack of adequate technologies for effective postharvest handling system for vegetable crops by developing better and appropriate technologies,



transfer of such technologies to farmers and other stakeholders in vegetable industry, which must be willing to invest in creation of infrastructure so that whatever is produced could be consumed by the largest section of population. The scientists should concentrate on researchable issues like appropriate technologies, and biochemical and nutritional, marketing, and socio-economic aspects of postharvest handling and management. Since research and development is quite expensive and quick answers to many immediate problems may not available, active involvement of Governments, International donors and corporations in funding, promotion, adoption and infrastructure facilities development is required.

## CHAPTER 2

# POSTHARVEST BIOLOGY AND TECHNOLOGY

---

The primary goal of postharvest biology and technology research is to maintain the quality and safety of fresh produce between harvest and consumption or processing and to reduce post-production losses. To reduce postharvest losses in fresh vegetables, producers and handlers must first understand the biological and environmental factors involved in deterioration, and second, use postharvest techniques that delay senescence and maintain the best possible quality.

Fresh vegetable crops are diverse in morphological structure (roots, stems, leaves, flowers, fruits, and so on), in composition, and in general physiology. Thus, commodity requirements and recommendations for maximum postharvest life vary among the commodities. All fresh vegetables are high in water content and are subject to desiccation (wilting, shriveling) and to mechanical injury. They are also susceptible to attack by bacteria and fungi, with pathological breakdown.

### 1. BIOLOGICAL FACTORS INVOLVED IN DETERIORATION

#### 1.1. Respiration

Respiration is the process by which stored organic materials (carbohydrates, proteins, fats) are broken down into simple end products ( $\text{CO}_2$  and  $\text{H}_2\text{O}$ ) with a release of energy. Oxygen ( $\text{O}_2$ ) is used in this process, and carbon dioxide ( $\text{CO}_2$ ) is produced. An adequate  $\text{O}_2$

concentration must be available to maintain aerobic respiration. This should be considered in selecting various postharvest handling procedures, such as waxing and other surface coatings, film wrapping and packaging. Accumulation of  $\text{CO}_2$  produced by the commodity in its ambient atmosphere can be beneficial or harmful depending upon each commodity's tolerance to elevated  $\text{CO}_2$  level. Respiration results in loss of stored food reserves in the commodity, reduced food value (energy value) and flavour quality. Enzymatic oxidation of sugars and loss of other compounds such as protein, lipids and organic acids are also channelized through respiration. The energy released as heat affects postharvest technology considerations, such as estimations of storage temperature and ventilation requirements.

The rate of deterioration of harvested produce is generally proportional to the respiration rate. Vegetables may be classified (Table 1) according to the rate of respiration by the freshly harvested edible plant parts, where respiration activity is estimated by the amount of  $\text{CO}_2$  produced by the produce (per kilogram of the produce per hour). Based on their respiration and ethylene ( $\text{C}_2\text{H}_4$ ) production during maturation and ripening, vegetables or fruits are either climacteric or non-climacteric. Climacteric fruits and vegetables show a large increase in  $\text{CO}_2$  and  $\text{C}_2\text{H}_4$  production rates during ripening, while non-climacteric fruits show no change in their generally low  $\text{CO}_2$  and  $\text{C}_2\text{H}_4$  production rates during ripening.

**Table 1: Classification of vegetables according to their respiration rate**

| Class          | Respiration Rate<br>(mg $\text{CO}_2$ /kg-hr) | Vegetables   |
|----------------|---|--|
| Very low       | Less than 5                                   | Dried vegetables   |
| Low            | 5-10  | Beet, celery, garlic, honeydew melon, onion, potato (mature), sweet potato, watermelon                         |
| Moderate       | 10-20   | Cabbage, cantaloupe, carrot (topped), cucumber, lettuce (head), potato, radish (topped), summer squash, tomato |
| High           | 20-40   | Carrot (with tops), radish (with tops), cauliflower, leek, lettuce (leaf), lima bean                           |
| Very high      | 40-60   | Artichoke, sprouted beans, broccoli, brussels sprout, endive, green onion, kale, okra, snap bean               |
| Extremely high | More than 60                                  | Asparagus, parsley, peas, spinach  |

## 1.2. Ethylene Production

Ethylene ( $C_2H_4$ ) is a natural product of plant metabolism which affects physiological processes of plants. As a plant hormone, ethylene regulates many aspects of growth, development and senescence and is physiologically active in trace amounts (less than 0.1 ppm). It also plays a major role in the abscission of plant organs.

The amino acid methionine is converted to S-adenosylmethionine (SAM), which is the precursor of l-aminocyclopropane-1-carboxylic acid (ACC), the immediate precursor of ethylene. ACC synthase, which converts SAM to ACC, is the main site of control of ethylene biosynthesis. The conversion of ACC into ethylene is mediated by ACC oxidase. The synthesis and activities of ACC synthase and ACC oxidase are influenced by genetic factors and environmental conditions, including temperature and concentrations of  $O_2$  and  $CO_2$ .

Vegetable crops are classified according to their ethylene production rates in Table 2. There is no consistent relationship between the ethylene

**Table 2: Classification of vegetables according to ethylene production rates**

| Class     | Ethylene production rate at 20°C ( $\mu l C_2H_4/kg-hr$ ) | Vegetables   |
|-----------|---|--|
| Very low  | Less than 0.1   | Artichoke, asparagus, cauliflower, leafy vegetables, root vegetables, potato |
| Low       | 0.1-1.0   | Cucumber, brinjal, okra, chilli, bell pepper, pumpkin, watermelon            |
| Moderate  | 1.0-10.0  | Honeydew melon, tomato   |
| High      | 10.0-100.0  | Cantaloupe   |
| Very high | More than 100.0   | NIL  |

production capacity of a commodity and its perishability; however, exposure of most commodities to ethylene accelerates their senescence. Generally, ethylene production rate increases with the maturity at harvest and with physical injuries, disease incidence, increased temperatures up to 30°C and water stress. One of the major effect of ethylene is to bleach or blanch green colour of leafy vegetables, such as celery, cabbage, broccoli,

Brussels sprout and wrapper leaves of cauliflower and fruit-vegetables like cucumber, pepper and tomato. On the other hand, ethylene production rates by fresh vegetables are reduced by storage at low temperature, by reduced O<sub>2</sub> levels (less than 8%) and elevated CO<sub>2</sub> levels (more than 2%) around the commodity.

### 1.3. Compositional Changes

Many changes in fruit pigments take place during development and maturation of the commodity on the plant; some may continue after harvest and can be desirable or undesirable:

- Loss of chlorophyll (green color) is desirable in fruits but not in vegetables.
- Development of carotenoids (beta-carotene) is desirable in vegetables such as orange carrots, pumpkin, muskmelon, sweet potato and leafy vegetables as it is important for nutritional quality. Red color development in tomatoes is due to a specific carotenoid (lycopene).
- Development of flavonoids especially quercetin in onion and garlic and anthocyanins in brinjal, red cabbage, purple sweet potato, purple broccoli, purple radish and onion is important from nutritional point of view because these compounds constitute the overall sensory quality of vegetables.
- Changes in anthocyanins and other phenolic compounds may result in tissue browning (non-enzymatic reaction), which is undesirable for appearance quality. On the other hand, these constituents contribute to the total antioxidant capacity of the commodity, which is beneficial to human health.
- Changes in carbohydrates include starch-to-sugar conversion (undesirable in potatoes, desirable in melons and other fruits); sugar-to-starch conversion (undesirable in peas and sweet corn; desirable in potatoes); and conversion of starch and sugars to CO<sub>2</sub> and water through respiration. Breakdown of pectins and other polysaccharides results in softening of fruits and a consequent increase in susceptibility to mechanical injuries. Increased lignin content is responsible for toughening of asparagus spears and root vegetables.

## 20 | Post Harvest Handling of Vegetables

- Changes in anti-nutritional factors in vegetables such as alkaloids. Many cucurbit species contain compounds such as glucosides that impart bitter taste and at higher levels fruits become toxic. Pumpkin and squashes contain choline esterase inhibitors, watermelon contains serotonin which cause high blood pressure. Asparagus contains saponins and choline esterase inhibitor. Solanaceous vegetables like tomato contain tomatine and potato when exposed to sunlight accumulates a green toxic substance called solanine. Chilli contain amides or resinoids and capsaicin, which cause skin irritation and gastric discomfort. Cruciferous vegetables contain glucosinolates whereas leafy vegetables (amaranth, spinach, Bathu) contain oxalic acid and oxalates.
- Changes in organic acids, proteins, amino acids and lipids can influence flavour quality of the commodity. Loss in vitamin content, especially ascorbic acid (vitamin C) in storage due to activity of enzyme ascorbic acid oxidase. Production of flavour volatiles associated with ripening of fruits is very important to their eating quality.

### 1.4. Growth and Development

Sprouting of potatoes, onion, garlic and root crops greatly reduce their food value and accelerate deterioration. Rooting of onion and root crops is also undesirable. Asparagus spears continue to grow after harvest; elongation and curvature (if spears are held horizontally) are accompanied by increased toughness and decreased palatability. Seed germination inside fruits such as tomatoes, chow-chow, cowpea, french bean and peppers is an undesirable change.

### 1.5. Transpiration or Water Loss

Majority of the vegetables contain more than 80 per cent of water and some of them like tomato, cabbage, spinach, palak, asparagus, lettuce, cucumber etc. contain as high as 90-95 per cent water. Water loss is the main cause of deterioration because it results not only in direct quantitative loss (loss of saleable weight), but also loss in appearance (wilting and shrivelling), textural quality (softening, flaccidity, limpness, loss of crispness, firmness and juiciness) and nutritional quality. Most vegetables lose their freshness when the vegetable loses 3-10% of its weight. Table 3 shows

the percentage weight loss at which the commodity was judged to become unsalable. These percentages are subjectively determined, but nevertheless indicate the significance of transpiration in determining the shelf life of each commodity.

**Table 3: Water loss (original fresh weight basis) of vegetables at which commodities become unsalable.**

| Crop                 | Maximum permissible water loss (%) |
|----------------------|------------------------------------|
| Asparagus            | 8                                  |
| Broad bean           | 6                                  |
| Runner bean          | 5                                  |
| Brussels sprout      | 8                                  |
| Cabbage              | 7                                  |
| Cauliflower          | 7                                  |
| Cucumber             | 5                                  |
| Onion, Garlic        | 10                                 |
| leek                 | 7                                  |
| Potato               | 7                                  |
| Peas                 | 5                                  |
| Bell pepper          | 7                                  |
| Lettuce, spinach     | 3                                  |
| Tomato               | 7                                  |
| sprouting Broccoli   | 4                                  |
| Carrot (with leaves) | 4                                  |

The commodity's dermal system (outer protective covering) governs the regulation of water loss. Vegetables lose water mainly by transpiration through stomata (e.g. leafy greens). Other paths of water loss are stem scars (e.g. tomato), lenticels (e.g. potato) and cracks that are resulted from mechanical injuries. The thickness, structure and chemical composition of cuticle vary greatly among commodities and among developmental stages of a given commodity. For this reason, water loss is least in tomato, moderate in cabbage and bell pepper, high in summer squash and very high in fresh leafy vegetables etc. Water loss is also associated with degradation effect on pigments and vitamins.

Transpiration rate is influenced by internal or commodity factors (morphological and anatomical characteristics, surface-to-volume ratio, surface injuries and maturity stage) and by external or environmental factors (temperature, relative humidity, air movement and atmospheric pressure). Transpiration is a physical process that can be controlled by applying treatments to the commodity (e.g., waxes and other surface coatings or wrapping with plastic films) or by manipulating the environment (e.g., maintaining high relative humidity and controlling air circulation).

### 1.6. Physiological Breakdown

Exposure of the commodity to undesirable temperatures can result in physiological disorders:

- Freezing injury results when commodities are held below their freezing temperatures. The disruption caused by freezing usually results in immediate collapse of the tissues and total loss of the commodity.
- Chilling injury occurs in some commodities (mainly those of tropical and subtropical origin) held at temperatures above their freezing point and below 5° to 15°C, depending on the commodity. Chilling injury symptoms become more noticeable upon transfer to higher (non-chilling) temperatures. The most common symptoms are surface and internal discoloration (browning), pitting, water soaked areas, uneven ripening or failure to ripen, off-flavor development, and accelerated incidence of surface molds and decay.
- Heat injury is induced by exposure to direct sunlight or excessively high temperatures. Its symptoms include bleaching, surface burning or scalding, uneven ripening, excessive softening and desiccation.

Certain types of physiological disorders originate from preharvest nutritional imbalances. For example, blossom end rot of tomatoes due to calcium deficiency, fruit cracking in tomato and browning in cauliflower due to boron deficiency, buttoning in cauliflower due to nitrogen deficiency and whip tail in cauliflower due to molybdenum deficiency. Increasing calcium content by preharvest treatments can reduce the susceptibility to blossom end rot in tomato. Similarly pre-harvest application of borax reduces fruit cracking in tomato and browning in cauliflower.



Very low O<sub>2</sub> (<1%) and high CO<sub>2</sub> (>20%) atmospheres can cause physiological breakdown of most fresh vegetables and can induce physiological disorders in certain commodities. The interactions among O<sub>2</sub>, CO<sub>2</sub> and C<sub>2</sub>H<sub>4</sub> concentrations, temperature, and duration of storage influence the incidence and severity of physiological disorders related to atmospheric composition.

### 1.7. Physical Damage

Various types of physical damage (surface injuries, impact bruising, vibration bruising, and so on) are major contributors to deterioration. Browning of damaged tissues results from membrane disruption, which exposes phenolic compounds to the polyphenol oxidase enzyme. Mechanical injuries not only are unsightly but also get infection, and stimulate CO<sub>2</sub> and C<sub>2</sub>H<sub>4</sub> production by the commodity.

### 1.8. Pathological Breakdown

One of the most common and obvious symptoms of deterioration results from the activity of bacteria and fungi. Attack by most organisms follows physical injury or physiological breakdown of the commodity. In a few cases, pathogens can infect apparently healthy tissues and become the primary cause of deterioration. In general, vegetables exhibit considerable resistance to potential pathogens during most of their postharvest life. The onset of ripening in fruits, and senescence in all commodities, renders them susceptible to infection by pathogens. Stresses such as mechanical injuries, chilling and sunscald lower the resistance to pathogens.

## 2. ENVIRONMENTAL FACTORS INFLUENCING DETERIORATION

### 2.1. Temperature

Temperature is the main environmental factor that influences the deterioration rate of harvested produce. For each increase of 10°C above optimum, the rate of deterioration increases by two-to-three fold. Exposure to undesirable temperatures results in many physiological disorders e.g. sunscald in tomato

and chilli. Temperature also influences the effect of ethylene, reduced oxygen, and elevated carbon dioxide. The spore germination and growth rate of pathogens are greatly influenced by temperature.

## 2.2. Relative Humidity

The rate of water loss from vegetables depends on the vapor pressure deficit between the commodity and the surrounding ambient air, which is influenced by temperature and relative humidity. At a given temperature and rate of air movement, the rate of water loss from the commodity depends on the relative humidity. At a given relative humidity, water loss increases with the increase in temperature.

## 2.3. Atmospheric Composition

Reduction of oxygen and elevation of carbon dioxide, whether intentional (modified or controlled atmosphere storage) or un-intentional (restricted ventilation within a shipping container or transport vehicle) can either delay or accelerate the deterioration of fresh vegetable crops. The magnitude of these effects depends on the commodity, cultivar, physiological age, oxygen and carbon dioxide levels, temperature and duration of holding.

## 2.4. Ethylene

Because the effects of ethylene on harvested vegetable commodities can be desirable or undesirable, ethylene is of major concern to all produce handlers. Ethylene can be used to promote faster and more uniform ripening of climacteric fruits picked at the mature green stage (e.g. tomato). On the other hand, exposure to ethylene can be detrimental to the quality of most of vegetables.

## 2.5. Light

Exposure of potatoes to light should be avoided because it results in greening due to formation of chlorophyll and solanine (toxic to humans). Light-induced greening of endive is also undesirable.

## 2.6. Other Factors

Various kinds of chemicals (e.g. fungicides, growth regulators) may be applied to the vegetable crops affect one or more of the biological deterioration factors.

## 3. POSTHARVEST TECHNOLOGY PROCEDURES

### 3.1. Temperature Management Procedures

Temperature management is the most effective tool for extending the shelf life of fresh vegetables. It begins with rapid removal of field heat by using one of the pre-cooling methods. Precision temperature management (PTM) tools are becoming more common in pre-cooling and storage facilities. Forced-air cooling continues to be the predominant pre-cooling method for vegetables. It should be ensured that all produce shipments leave the cooling facility within or the optimal storage temperature. Periodic ventilation of storage facilities is effective in maintaining ethylene concentrations below 1 ppm, which permits mixing of temperature compatible, ethylene-producing and ethylene-sensitive commodities.

### 3.2. Control of Relative Humidity

Relative humidity can influence water loss, decay development, incidence of some physiological disorders and uniformity of fruit ripening. Condensation of moisture on the commodity (sweating) over long periods of time is probably more important in enhancing decay than is the RH of ambient air. Proper relative humidity is 90 to 95% for vegetables except dry onion, garlic and pumpkin (70 to 75%). Some root vegetables can best be held at 95 to 100% RH.

Relative humidity can be controlled by one or more of the following procedures:

- Adding moisture (water mist or spray, steam) to air by humidifiers
- Regulating air movement and ventilation in relation to the produce load in the cold storage room
- Maintaining the refrigeration coils within about 1°C of the air temperature

## 26 | Post Harvest Handling of Vegetables

- Providing moisture barriers that insulate storage room and transit vehicle walls; adding polyethylene liners in containers and plastic films for packaging
- Wetting floors in storage rooms
- Adding crushed ice in shipping containers or in retail displays for commodities that are not injured by the practice
- Sprinkling produce with water during retail marketing (use on leafy vegetables, cool-season root vegetables, and immature fruit vegetables such as beans, peas, okra, summer squash, cucumber)

### 3.3. Use of Controlled and Modified Atmospheres

The use of CA during transport and/or storage of fresh vegetables (marketed intact or lightly processed) continues to expand because of improvements in nitrogen-generation equipment and in instruments for monitoring and maintaining desired concentrations of oxygen and carbon dioxide. Controlled atmosphere is a useful supplement to the proper maintenance of optimal temperature and RH during transport and storage of many fresh vegetables. It allows use of marine transport instead of air transport of some commodities.

Several refinements in CA storage have been made in recent years to improve quality maintenance. These include creating nitrogen by separation from compressed air using molecular sieve beds or membrane systems; low O<sub>2</sub> (1.0-1.5%) storage; low ethylene CA storage; rapid CA (rapid establishment of the optimal levels of O<sub>2</sub> and CO<sub>2</sub>); and programmed (or sequential) CA storage (e.g., storage in 1% O<sub>2</sub> for 2 to 6 weeks followed by storage in 2 to 3% O<sub>2</sub> for the remainder of the storage period). Other developments, which may expand use of MA during transport and distribution, includes use of edible coatings or polymeric films with appropriate gas permeability to create a desired MA around and within the commodity. Modified atmosphere packaging is widely used in marketing fresh-cut vegetables. Successful application of atmospheric modification depends on the crop, cultivar, maturity stage at harvest and cost-benefit ratio. Commercial use of CA storage is greatest worldwide on apples and pears but less on fresh vegetables. Atmospheric modification during long-distance transport is used on vegetables like asparagus, broccoli

and melons. Continued technological developments in the future to provide CA during transport and storage at a reasonable cost are essential to greater CA applications on fresh vegetables.

### **3.4. Packing and Packaging**

The produce industry is increasingly using plastic containers that can be reused and recycled in order to reduce waste disposal problems. For example, standard-sized (120 x 100 cm) stacking (returnable) pallets are becoming more widely used. There is continuous increase in use of modified atmosphere and controlled atmosphere packaging (MAP and CAP) systems during palletization, in shipping container (fiberboard box liner) and at consumer package levels. Also, the use of absorbers of ethylene, carbon dioxide, oxygen and/or water vapour as part of MAP and CAP is increasing.

### **3.5. Transportation**

Improvements are continually being made in attaining and maintaining the optimal environmental conditions (temperature, RH and concentrations of O<sub>2</sub>, CO<sub>2</sub>, and ethylene) in transport vehicles. Produce is commonly cooled before loading and is loaded with an air space between the palletized produce to improve temperature maintenance. Delays between cooling after harvest and loading into transit vehicle should be avoided. Proper temperature management should be ensured throughout the transportation. In some cases, vehicle and produce temperature data are transmitted by satellite to a control center, allowing shipments to be continuously monitored. Some new trucks have air ride suspension, which can eliminate transport vibration damage.

### **3.6. Handling at Wholesale and Retail**

Wholesale and retail markets have been increasingly using automated ripening. In automated ripening, the gas composition of the ripening atmosphere, the room temperature and fruit colour are continuously monitored and modulated to meet desired ripening characteristics. Improved ripening systems will lead to greater use of ripening technology to deliver

products that are ripened to the ideal eating stage. Better-refrigerated display units with improved temperature and RH monitoring and control systems are being used in retail markets, especially for fresh-cut vegetable products. Many retail and food service operators are using Hazard Analysis Critical Control Points (HACCP) Programs to assure consumers that food products are safe.

### 3.7. Other Management Techniques

Many technological procedures are used commercially as supplements to temperature management. None of these procedures (alone or in combinations) can substitute for maintenance of optimal temperature and relative humidity, but they can help extend the shelf life of harvested produce beyond what is possible using refrigeration alone.

Treatments applied to commodities include:

- curing of certain root, bulb and tuber vegetables
- cleaning followed by removal of excess surface moisture
- sorting to eliminate defects
- waxing and other surface coatings
- heat treatments (hot water or air, vapor heat)
- treatment with postharvest fungicides
- sprout inhibitors
- special chemical treatments (scald inhibitors, calcium, growth regulators, anti-ethylene chemicals)
- fumigation for insect control
- ethylene treatment (de-greening, ripening)

### 3.8. Preharvest Factors

Recent trends in postharvest quality and safety assurance will depend largely upon advances in production technology, such as:

- Breeding, selection, and molecular engineering of cultivars with better flavour quality and longer postharvest life such as “super-sweet” sweet corn, long-shelf-life tomatoes, and sweeter melons. Plant geneticists

in public and private institutions are using molecular biology methods along with plant breeding procedures to produce new genotypes that taste better, maintain firmness, disease resistant and have other desirable characteristics.

- Optimising water use and nutrition of maximize fruit quality at harvest and its postharvest life based on flavour. Improved ways to get calcium into plants will help reduce incidence and severity of many physiological disorders.
- Establishing effective preharvest integrated pest management (IPM) systems that would maintain the health of the fruits before and after harvest (supplemented by postharvest IPM programs).

## CHAPTER 3

# PRE-HARVEST FACTORS AFFECTING QUALITY AND SHELF LIFE

---

The quality of vegetables at the time of harvest has decisive influence on its post harvest quality. The initial quality at harvest cannot be improved to any greater extent but can be maintained by proper pre-harvest management. There are numerous pre-harvest practices involved in deciding the quality of vegetable crop at harvest, which has a major influence on its post-harvest shelf life and quality. The pre-harvest factors not only include the genetic makeup and maturity at harvest, but also the climate and soil in which the crop was grown and the cultural practices. Several of these factors often interact giving complex inter-relationships. Pre-harvest factors may interact with the practices like fertilizer application, irrigation or chemical sprays. With the background of the pre-harvest factors, pre-harvest treatments have been evolved and are being investigated to produce the best post-harvest qualities.

### 1. GENETIC FACTORS

Within each vegetable crop there is a range of genotypic variation in composition, quality and post-harvest life. Vegetable breeders have been successful in selecting carrot, sweet potato and tomato cultivars with comparably high carotenoid levels and vitamin A content; onion and tomato cultivars with longer shelf-lives, sweet corn cultivars that maintain their sweetness longer after harvest and cantaloupe and watermelon cultivars



with higher sugar content and firmer flesh. These are just a few examples of how genetic manipulation has contributed to improve the quality of vegetables. However, in many cases, commercial cultivars selected for their ability to withstand the rigors of marketing and distribution, tend to lack sufficient sensory quality, in particular flavour.

Vegetable breeders have an unprecedented opportunity to address human nutritional needs by developing vegetable cultivars that are rich in nutrients. In so doing, a multidisciplinary approach should be taken with emphasis on the enhancement of nutritional quality for maximum impact on human nutrition and wellness.

## **2. CLIMATIC CONDITIONS**

Climatic factors, in particular temperature and light intensity, greatly impact on the nutritional quality of vegetables. Consequently, the location of production and the season in which vegetables are grown can determine their ascorbic acid, carotene, riboflavin, thiamine and flavonoid contents. In general, lower the light intensity, lower the ascorbic acid content of plant tissues. Temperature influences the uptake and metabolism of mineral nutrients by plants, since transpiration rate increases with increase in temperature. Rainfall affects water supply to the plant, which may influence the composition of the harvested plant part and its susceptibility to mechanical damage and decay during subsequent harvesting and handling operations.

## **3. MINERAL NUTRITION**

Among the pre-harvest treatments, nutrition of the plant is extensively studied as it affects post-harvest quality. Intake of balanced minerals is the most important pre-harvest factor influencing the post-harvest qualities of vegetable crops. Excess or deficiency of certain elements can affect the quality and post-harvest life. Several physiological disorders of vegetable crops are attributed due to deficiency of mineral nutrients. These disorders are minimized by pre-harvest treatments with specified mineral, even though the actual role of the mineral in preventing the disorder has not been established for most disorders. The application of fertilizers to vegetable crops has been shown to influence their post-harvest respiration

rate. This has been reported for a variety of fertilizers on several crops including potassium on tomato, sulphur on cabbage and cauliflower and organic fertilizers on onion and garlic. The role of important minerals on the post-harvest life of vegetables are discussed below:

### 3.1. Nitrogen

For leafy vegetables, application of nitrogen is very important for stimulating vegetative growth. Lack of nitrogen can lead to stunted growth or to the yellow-red discolouration of leaves in green vegetables e.g. cabbage. Large amount of nitrogen encourages vegetative production rather than fruit development and results in poor storage quality of vegetables. High nitrogen fertilizer is related to increased water loss in storage for sweet potato, decreased flavour in celery, decreased ascorbic acid content in potatoes and cabbage, decreased dry matter and increased rotting and sprouting in onion bulbs during storage and the development of hollow stem in broccoli.

In addition to knowing the amount of fertilizer recommended for the soil type in which crop is being sown. It is also important to know how much nitrogen is already present in soil at the time of sowing/transplanting. It is easy to over-fertilize, since nitrogen may be left over from fertilizers added during the last season. In general, light coloured soils contain little organic matter and will release little nitrogen, while dark coloured soils release more nitrogen. The best approach is to begin the sowing/transplanting of vegetables after conducting the soil tests, and then fertilize to bring the soil upto the recommended rates. If mulching is done for the first time, it is better to add some extra nitrogen to the soil because soil micro-organism will use some of the nitrogen for decomposing the mulching material.

### 3.2. Phosphorus

There is little information in literature on the effects of phosphatic fertilizers on post harvest life of vegetables. Application of 100 kg/ha of phosphorus minimized weight loss, sprouting and rotting of onions. Phosphorus nutrition can alter the post harvest physiology of cucumber by affecting membrane chemistry, membrane integrity and respiratory metabolism.

### 3.3. Potassium

The major mineral in plants is potassium and both high and low levels of potassium have been associated with abnormal metabolism. Low potassium is associated with changes in the ripening of tomato and delays the development of a full red colour by inhibiting lycopene biosynthesis.

### 3.4. Calcium

Among the mineral nutrients, calcium has been associated with more deficiency disorders in vegetables (Table 1) than other minerals.

**Table 1: Calcium-related deficiency disorders of vegetables**

| Produce           | Disorders                             |
|-------------------|---------------------------------------|
| Bean              | Hypocotyl necrosis                    |
| Brussels's sprout | Internal browning                     |
| Cabbage           | Internal tip burn                     |
| Carrot            | Cavity spot, cracking                 |
| Celery            | Black heart                           |
| Cherry            | Cracking                              |
| Lettuce           | Tip burn                              |
| Pepper            | Blossom-end rot                       |
| Potato            | Sprout failure, tip burn              |
| Tomato            | Blossom-end rot, black seed, cracking |
| Watermelon        | Blossom-end rot                       |

Foliar spray of calcium chloride or calcium nitrate can improve quality and reduce disease symptoms and decay in storage for these above crops, especially if applied after a heavy rain or during a period of rapid growth. Some of the disorders such as blossom-end rot of tomatoes can be readily eliminated by the application of calcium salts as pre-harvest spray. Pre-harvest foliar spray with calcium followed by post-harvest dip in calcium increased the firmness of tomato fruits. Addition of calcium chloride to irrigation water improved the quality of mushroom by increasing the whiteness at harvest and reduced post-harvest browning. Pre-harvest spray with 0.4% to 0.6% calcium chloride delayed the ripening, reduced

the physiological loss in weight (%) and extended the storage life of tomato fruits. Calcium has been shown to affect the activity of many enzyme systems and metabolic sequences in plant tissues. The activities of enzymes involved in fruit ripening, viz. pectin methyl esterase (PME), poly galacturonase (PG-ase) are increased or inhibited depending on the concentrations of calcium applied. The ability of calcium to regulate the activities of these various systems has led to speculation that calcium may have a role in the initiation of normal fruit ripening process. It is also possible that calcium prevents the appearance of some physiological disorders.

### **3.5. Effect of Organic Fertilizers and other Materials**

The market for organically produced foods is increasing. There is conflicting information on the effects of the organic production of vegetables on their post-harvest quality. Organic production has been shown results in vegetable crops having higher levels of post-harvest diseases. e.g. garlic and onion.

## **4. PRE-HARVEST TREATMENTS**

Pre-harvest treatments with chemicals and growth regulators like calcium salts, gibberellic acid, polyamines etc. have marked influence on post-harvest quality including delay in ripening, reducing post-harvest physiological disorders, alleviation of chilling injury etc. These pre-harvest treatments influence the fruit firmness, bio-chemical composition, colour development, physiological loss in weight, respiration, enzyme biosynthesis, ethylene production and storage. Pre-harvest application of fungicides is employed to control post-harvest diseases and spoilage during storage and marketing.

### **4.1. Pre-harvest Treatments with Fungicides**

Pre-harvest treatment with fungicides is also used to prevent the development of postharvest diseases and spoilage of vegetable produce. Pre-harvest sprays with fungicides reduce the field inoculum and eradicate the latent field infections, resulting in healthy produce with best initial quality and potential for long storage. In recent years, several systemic fungicides have become available, which can be effectively used to

eradicate the quiescent infections. Pre-harvest treated produce would be safer with less or no residues. Pre-harvest fungicide treatments are the best way to reduce decay in vegetable commodities those are not subjected to controlled ripening or post-harvest treatment practices. Development of resistance to certain specific fungicides by the organisms might be disadvantage of pre-harvest treatments if the same fungicides are to be relied upon for post harvest treatments. Pre-harvest sprays with Captan, Dithane M-45 reduced the incidence of *Phoma rot*, *Geotrichum candidum* and *Phytophthora sp.* and reduced the spoilage in harvested tomato fruits. Preharvest application of Bavistin (0.1%) 15 days prior to uprooting suppresses rotting in kharif onion.

#### 4.2. Growth Regulating Chemicals

Growth regulating chemicals are also becoming important in vegetable crops for modification of crop growth, flowering, fruiting and crop production. If adopted, plant growth regulators (PGRs) can benefit farmers and consumers both. The following approaches should be followed in vegetables crops.

- **Ethrel/ Ethephon :** The foliar application of Ethrel @ 500 ppm on muskmelon, 250 ppm on pumpkin, summer squash and 100 ppm on ridge gourd, sponge gourd, bottle gourd sprayed at 2 and 4 true leaf stages increases number of fruits per plant and improve crop yield. During summer foliar application of Ethrel @ 250 ppm when sprayed on the tomato plants at turning stage of fruits hasten ripening and results early fruit yield during summer. Fruit quality (Vitamin C, TSS and Lycopene content) in tomato was also improved with this treatment.
- **Gibberelic acid (GA) :** Preharvest spray of GA<sub>3</sub> (50 to 150 ppm) to tomato plants were not found useful in delaying the colour development, ripening rate and extending the storage life of tomato fruits. Treatment of seed potato tubers @ 2.5 ppm GA (250 mg GA<sub>3</sub> dissolved in alcohol and later in 100 liters of water) for ½ hour before planting increases the number of tubers and tuber yield. Foliar spray of Gibberellic acid @ 50 ppm a month after planting of garlic cloves increases the diameter of the bulb and ultimately increases the bulb yield.

- **Cycocel (CCC)** : Foliar application of Cycocel @ 250 ppm (250 ml Cycocel in 500 litres of water) improves potato yield when applied 50 days after planting. Cycocel @ 500 ppm spray (500 ml CCC in 500 liters of water for one acre of crop) before onset of frost is helpful in inducing regeneration after frost damage in tomato. Seedling dip treatment in Cycocel 0.5-1.0 per cent (5-10 ml Cycocel 50% mixed in 1 litre of water) for 10-12 hrs before transplanting in saline soils raises the capacity of plants to tolerate salinity and increased the yield of vegetable crops. Similarly in dry conditions, foliar spray of Cycocel @ 250 ppm (250 ml Cycocel 50% mixed in 500 liters of water) at vegetative growth stages of plants in vegetable crops raises the capacity of plants to tolerate drought conditions and increases the yield.
- **Naphthalene acetic acid (NAA)** : The spray of Planofix or NAA @ 100 ml/ha at flowering and 3 weeks after the first spray checks the flower drop problem in chilli during high temperatures. For this purpose 100 ml Planofix may be dissolved in 450 liters of water for spray in one hectare.
- **Cytozyme**: Foliar spray of Cytozyme 0.2% (2 ml Cytozyme in one litre of water) 15 and 30 days after transplanting of seedling improves curd and head yield significantly in cabbage and cauliflower. It also hastenes early curd and head formation in cauliflower and cabbage, respectively. Foliar application of Cytozyme 0.2% thrice, i.e. 21, 42 and 63 days after transplanting increases fruit yield in brinjal.
- **Maleic Hydrazide (MH)** : Pre-harvest application of MH reduces sprouting of onion during storage and extends the storage life of the bulbs as reported by several workers. Because it is necessary for the chemical to be translocated to the apex of the growing point towards the centre of the bulb, it has to be applied to the leaves of the growing crop as pre-harvest spray. Reduction in rooting and physiological losses in weight of the bulbs was also observed as a result of the pre-harvest spray with MH. Pre-harvest spray of MH @ 2000-3000 ppm along with difolatan (0.2%) 15 days prior to harvesting is very effective in reducing the storage losses due to sprouting and rotting of onion bulbs. Restriction on the usage and permitted residues of MH vary among countries. Before spray it is essential to add stickers like Selvet-99 @ 100 g per 100 litres of water. Storage life of garlic is prolonged

and loss in the weight is also reduced by spraying 3000 ppm MH three weeks before harvest.

## 5. CULTURAL PRACTICES

Vegetable crops are generally annual, so there is more effect of environment and cultural practices on the maturity and quality of produce.

### 5.1. Field Sanitation

There are two important sources of inoculum for various fungal pathogens and/or hosts for insect pests. These are (a) culls left in the field (b) field bins that have been in contact with soil contaminated with inoculum.

### 5.2. Mulching

The type of mulching material, its colour and site of application impact the maturity, flavour and composition of vegetables. Plastic mulches used to increase water use efficiency and weed control are found to impact flavour and maturity of tomato and brinjal. Organic mulches (plant residue, peat moss, saw dust, wood bark, composted animal manure) are more effective in summer months as compared to chemical/mechanical mulches. Higher yield and better quality of tomato, bitter melon and muskmelon fruits are obtained with paddy straw mulches in late summer crops. White paper and reflective foils can keep soil about 3 to 6°C cooler than bare soil. Potato, summer squash and cool season vegetables such as broccoli and brussels sprout may benefit from cooler soil temperatures and increase yield. Black paper or black and transparent plastic mulches will increase soil temperature by 6 to 8°C when compared with bare soil, and will encourage early plant development. Melons, cucumbers, peppers and early crop of tomatoes will benefit from soil warming mulches and give early yield advantage.

### 5.3. Tillage

Not much information is available on this aspect. In pumpkin, maturity gets delayed with increasing the number of tillage operations. Plants in minimum tilled plots show early maturity and low yield compared to

tilled plots. Lower synthesis of gibberellins and cytokinins in minimum tillage plants may be the probable reasons for early maturity.

#### **5.4. Covering/bagging**

Individual bagging of bottle gourd (Long type) meant for export, on vine with special paper bags as followed in India would produce best quality bottle gourd and this would help boost export of bottlegourd from our country. Covering or bagging is also practiced in fruit crops like banana and grapes.

#### **5.5. Pruning and Thinning**

Limiting the vegetative growth of crops such as tomato and pole beans will encourage the remaining produce to mature faster. Thinning of tomatoes (indeterminate) and capsicum in the net/poly houses results in production of larger and better quality fruits. During pruning and thinning, there is usually a decision has to be made between total yield and improved quality, but often the better price received for higher grade produce will suggest that maximizing yield will not maximize profits. A cucumber plant is capable of producing many medium sized or few large fruits, while the total weight of cucumbers produced will be about the same. Removing the first and second female flower from pumpkin vines will increase the weight of remaining fruit, since all the plants energy will be directed into this one fruit.

#### **5.6. Trellising**

Trellising encourages the plants to grow upward which will maximize sun penetration around the plant and provide good ventilation, lowers the relative humidity around the plants and reduces the incidence of diseases and improves quality. Cucumbers will nearly double their yield per plant if trellised during production. Vegetable crops which are generally trellised includes tomato (indeterminate), cucumber, bottle gourd, bitter gourd, pole bean, summer squash, sponge gourd, smooth gourd, long melon, pointed gourd, sweet potato and muskmelon. Heavy crops such as muskmelons will require support as they grow and should be securely tied to the trellis. Some growers make a sling of cheesecloth for the heavy fruits and tie



these to the trellis. Trellised plants may require more irrigation to prevent wilting in the heat of the day.

### **5.7. Irrigation**

Growing plants need a continuous water supply for both photosynthesis and transpiration. Excess water via rain or irrigation contributes to a loss of flavour in many vegetable crops, increased susceptibility to decay in storage and early sprouting of root and bulb crops. It appears that too little water may often be better than too much, in terms of overall produce quality and its storage life. Dry conditions followed by rain or irrigation give rise to growth cracks or secondary growth in potatoes or to growth cracks in tomatoes. Drip irrigation is now recommended in some of vegetables like tomato, capsicum, potato, chilli, garlic, onion, brinjal etc. as it saves water, check weeds and improve quality and yield. The scheduling of the last irrigation has an affect on the quality of onion, garlic and potatoes. It is important to withheld irrigation at least 10-12 days before harvest in these crops because it allows the tops to dry down and crop will be ready to dig and cure before further handling.

### **5.8. Pesticides and Herbicides**

Pesticides and herbicides are used as sprays or soil applications to control weeds, disease and insect pests. They are dangerous because they can damage produce by producing spray burns if used incorrectly, and they can leave poisonous residues on produce after harvest. In most countries there are laws to control the use of pesticides, which should be used only in recommended concentrations. Strict observance of the recommended delay between the last spraying and the harvesting is required in order to keep produce below maximum residue level limits.

### **5.9. Blanching**

Pre-harvest blanching of vegetable crops during the last stages of growth makes the produce lighter in colour and milder in flavour. Blanching requires hand labour but add market value to crops such as asparagus, cauliflower, celery, endive and leeks. Using different colours of rubber bands or twine

each day makes it easy at the time of harvest to select those plants tied earliest.

- **Asparagus:** Cover the beds with more soil so that shoots grow longer and become white in colour.
- **Cauliflower:** Grow self blanching type varieties if possible, otherwise cover the head with a paper bag or tie outer wrapper leaves around the head.
- **Celery:** Hill soil around the stalk after wrapping stalks in newspaper to keep out soil.
- **Endive:** Cover head with wrapper leaves 7 to 10 days before harvest.
- **Leeks:** Cover base of the plant with newspaper when it is about half grown, then mount soil about 20-30 cm up the stem.

## 6. MATURITY AT HARVEST IN RELATION TO QUALITY

Maturity at harvest is the most important determinant of storage-life and final fruit quality. Immature fruit are highly susceptible to shriveling and mechanical damage, and are of inferior flavour quality when ripe. Overripe fruit are likely to become soft and mealy with insipid flavour soon after harvest. Fruit picked either prematurely or too late, are more susceptible to post-harvest physiological disorders than the fruit picked at the proper stage of maturity.

Many vegetables, in particular leafy vegetables, and immature fruit-vegetables (such as cucumber, sweet corn, green bean, pea, and okra), attain optimum eating-quality prior to reaching full maturity. Therefore delay in harvest results in low quality of these vegetables.

## 7. METHOD OF HARVESTING IN RELATION TO UNIFORMITY OF MATURITY

The method of harvesting (hand vs. mechanical) can significantly impact upon the composition and post-harvest quality of vegetables. Mechanical injuries (such as bruising, surface abrasions and cuts) can accelerate loss of water and vitamin C resulting in increased susceptibility to decay-causing pathogens. Most fresh vegetables are harvested by hand. Root

crops (such as carrot, onion, garlic, potato, and sweet potato) and some vegetables for processing (such as processing tomatoes) are mechanically harvested. Management of harvesting operations, whether manual or mechanical, can have a major impact on the quality of harvested vegetables. Proper management procedures include selection of optimum time to harvest in relation to product maturity and climatic conditions, training and supervision of workers, and proper implementation of effective quality control.

It should be noted that any practice that reduces the number of produce handling steps will help minimize losses. Field packing (selection, sorting, trimming, and packaging) of produce at the time of harvest can greatly reduce the number of handling steps in preparation for marketing. Mobile field packing stations with adequate shading are used for those fruits (such as grapes and strawberries) and vegetables (such as broccoli, cauliflower, and green beans) that do not require washing as part of their preparation for marketing.

## CHAPTER 4

# MATURATION AND MATURITY INDICES

---

### 1. MATURITY

Maturity is the state of development when the desirable part of crop reaches physiological or horticultural maturity. Proper maturity at harvest is one of the keys to high quality and better post-harvest life. Fruits harvested too early may lack flavour and may not ripen properly, lose moisture quickly, hence deteriorate in quality faster while produce harvested too late may be over ripe and have very short postharvest life. Workers need to be trained to identify the produce ready for harvesting for different markets. For example, tomatoes for local marketing can be harvested red ripe, while those for distant markets should be harvested earlier (pink stage) so they are red ripe by the time they reach the destination market.

Harvesting season can be extended by selecting cultivars that are of high quality when picked small and when large, and sell those vegetables that are removed when thinning during the growing season. Perhaps there is a special market for highly valued “baby vegetables” such as tiny beets, carrot, turnip, lettuce, onion and garlic greens, summer squash, green tomatoes, new potatoes and baby corn. Other crops such as leaf lettuce, fenugreek and spinach can be picked and marketed multiple times over the growing season. Crops such as okra, green bean, cucumber and indeterminate tomato should be harvested continuously, since if the older fruit is allowed to mature and remain on the plant, quality and yield is dramatically reduced. Once harvesting starts, cucumbers in India are

generally picked at 2 to 4 day intervals depending on the weather. Okra is picked every 2<sup>nd</sup> or 3<sup>rd</sup> day, the best time for harvest being 6 to 7 days after the opening of the flowers. Small scale growers can take advantage of the fact that side shoots of broccoli and cabbage will develop new smaller heads once the central head has been removed providing another crop about one month later.

At this point, it is necessary to differentiate between two types of fruits: climacteric and non-climacteric. **Climacteric fruits** can ripen off the plant once they have reached physiological maturity. Climacteric fruit vegetables include tomato, muskmelon. They are capable of generating ethylene, the hormone required for ripening even when detached from the mother plant. A few climacteric fruits such as muskmelons will not increase in sugar content during ripening but will soften. **Non-climacteric** fruits must ripen on the plant if you want to fully mature fruit, since once they have been harvested, no further ripening will occur and commercial maturity is only obtained on the plant. Most of the vegetables are non-climacteric. Climacteric fruits are autonomous from the ripening point of view and changes in taste, aroma, colour and texture are associated with a transitory respiratory peak and closely related to autocatalytic ethylene production. On the other hand, in non-climacteric fruit vegetables such as bell peppers, slight changes in colour take place after harvest. Full red colour is only obtained while fruit is attached to the plant. As a general rule, the more mature the product, the shorter its post-harvest life. For distant markets, this means climacteric fruits need to be harvested as early as possible, but always after reaching their physiological maturity.

## 2. TYPES OF MATURITY

- Physiological maturity is the stage when a fruit is capable of further development or ripening when it is harvested.
- Horticultural maturity refers to the stage of development when plant and plant part possesses the pre-requisites for use by consumers for a particular purpose.

## 3. IMPORTANCE OF MATURITY INDICES

**Assists you to ensure sensory quality and nutritional quality:**  
Harvesting horticultural produce too early (when under-developed or

immature) will result in poor colour, flavour and under-developed nutritional characteristics.

**Ensures an adequate postharvest shelf life:** Harvesting too late will reduce postharvest life. Over-mature produce can be too ripe and soft to withstand postharvest handling, or be too fibrous, tough or woody (have reduced eating quality).

**Facilitate scheduling of harvest and packaging operations:** Maturity indices help to predict beginning dates of harvest and the related equipment, materials, facilities & labour needs.

**Facilitates marketing over the phone or through internet:** This is important when selling to distant buyers and allows buyers to have a clear idea of the quality they are purchasing without having to do a visual inspection of produce.

#### 4. METHODS OF DETERMINING MATURITY AND QUALITY

There are several methods to determine produce maturity. The common is the size of the individual commodity. Other physical characteristics are the colour and firmness. Colour and firmness are often correlated with the chemical changes that occur during ripening. Chemical characteristics include TSS, acidity, sugars, starch, vitamins and pigments. Other recent methods viz. thermal conductivity, X-rays and NIR have also come in practice to judge the maturity of vegetables. The different methods of maturity determination are listed in the Table 1 and their detail is given below:

##### 4.1. Days after Full Bloom

Time period between flowering and fruit maturity is quite constant in some crops like cucumber, brinjal, peas and hence serves as a good indicator of maturity. In some vegetable crops time period from sowing/transplanting to maturity also serves as an indicator of maturity and is practiced in some crops like watermelon, bell pepper etc.

**Table 1: Classification of maturity indices with examples (especially vegetables)**

| Method of judging maturity  | Vegetable(s)   |
|---|--|
| <b>Computational methods</b>                                      |  |
| Calendar date (say 5 <sup>th</sup> June or 26 <sup>th</sup> July) | All vegetables   |
| Days from full bloom to harvest                                   |  |
| Mean heat units   | Peas   |
| Days from sowing/transplanting to maturity                        | Peas, Carrot, Radish, Turnip, Potato                     |
| <b>Physical methods</b>   |  |
| Size, weight  | Pumpkin, Ash gourd, Cabbage, Cauliflower,                |
| Shape   | Broccoli, Cauliflower                                    |
| Colour  | Tomato   |
| Specific gravity  | Watermelon, Potato                                       |
| Tenderness  | Peas, Beans  |
| Firmness  | Broccoli, Cauliflower, Cabbage, Lettuce (head)           |
| Surface gloss   | Tomato, Brinjal, Capsicum                                |
| Development of abscission layer                                   | Muskmelon, Cantaloupe                                    |
| Surface morphology  | Netting in some melons                                   |
| Juice content   | Citrus fruits  |
| Oil content   | Avocado  |
| <b>Chemical methods</b>   |  |
| Titrateable acidity   | Tomato, cauliflower, carrot, peas                        |
| TSS   | Muskmelon, Watermelon                                    |
| Sugars  | Potato   |
| Sugar-acid ratio  | Melons   |
| Starch  | Apple, pear  |
| <b>Physiological methods</b>                                      |  |
| Respiration rate  | Not used commercially, mainly used for research purpose. |
| Ethylene evolution rate   |  |

## 4.2. Size and Shape

Size is a useful index for most of the vegetables. Size and shape charts and sizing rings (Fig. 1) are available for many vegetables. Using photos or hand drawings of the vegetables, shape and size charts can be prepared. These charts can be used by workers to compare produce before harvesting when it is still on the plant with the known standard(s). In vegetables that are naturally large such as pumpkin, watermelon, muskmelon etc., there is a very defined trend towards sizes that can be consumed by a family. In vegetables like peas, beans, zucchinis and miniature vegetables consumer particularly like small sizes (Fig. 2a, Fig. 2b).

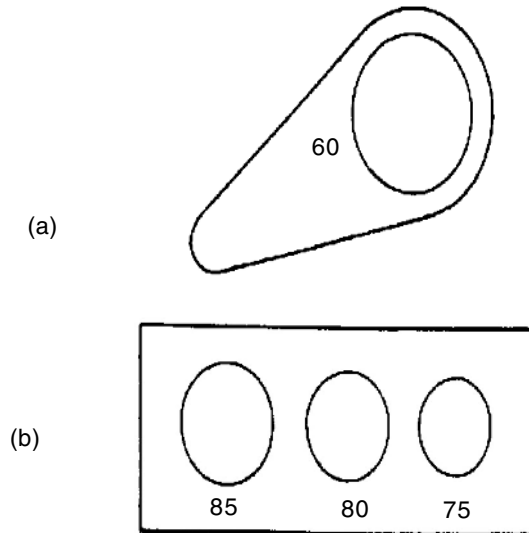


Fig. 1: Sizing rings

## 4.3. Colour

We perceive colour when light reflected off the commodity surface falls upon the eye's retina; there is no colour without light. Colour perception depends on the type and intensity of light, chemical and physical characteristics of the commodity, and the person's ability to characterize colour. Evaluating colour can be subjective or objective. The maturity and ripeness classes of tomato and honeydew melon are given in Table 2 and Table 3 respectively.





**Fig. 2a: Harvest maturity based on the bean diameter**  
(Source: Camelo, 2004)



**Fig. 2b: Readiness for harvest based on the degree of seed development in pea**

**Table 2: Maturity and ripeness classes of tomato**

| <b>Class</b>   | <b>Description</b>  |
|----------------|---|
| Mature green 1 | Seeds are cut when slicing fruit with a sharp knife, no jelly like material in locules.   |
| Mature green 2 | Seeds not cut when fruit is sliced, 'jelly' in at least one locule, minimum harvest stage |
| Mature green 3 | Jelly like material well developed but still completed green                              |
| Mature green 4 | Internal red colouration at blossom end, but not external colour change                   |
| Breaker        | First external pink or yellow colour at the blossom end                                   |

[Table Contd.]

Contd. Table]

| Class     | Description   |
|-----------|---|
| Turning   | 10 to 30% of fruit surface shows colour change from green to yellowish, pink or red |
| Pink      | 30 to 60% of the fruit surface is coloured  |
| Light red | More than 60% is pinkish red, but less than 90% of the surface is red               |
| Red       | More than 90% of the fruit surface shows red colour                                 |

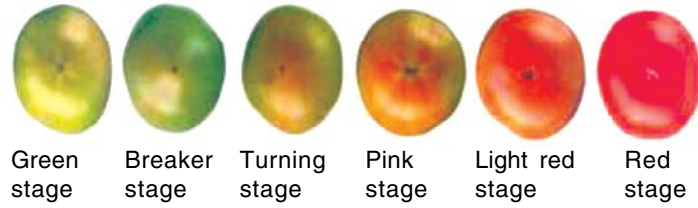
**Table 3: Maturity and ripeness classes of honeydew melon**

| Class               | Characteristics   |
|---------------------|---|
| 0= Immature         | Greenish ground colour, peel fuzzy/hairy, no aroma  |
| 1= Mature, Unripe   | Ground colour white with greenish aspect, peel fuzzy/hairy, no aroma, melon splits when cut, flesh crisp, TSS 10%, minimum commercial harvest maturity                            |
| 2= Mature, Ripening | Ground colour white with trace of green, peel less fuzzy and slightly waxy, slight to noticeable aroma, melon splits when cut, flesh crisp, harvested commercially                |
| 3= Ripe             | Ground colour creamy white to pale yellow, peel waxy, noticeable aroma, abscission zone may begin to form, flesh firm when sliced does not split, harvested for local market only |
| 4 = Overripe        | Ground colour yellow, softening at blossom end, abscission zone fully formed, very aromatic, flesh soft and somewhat water soaked   |

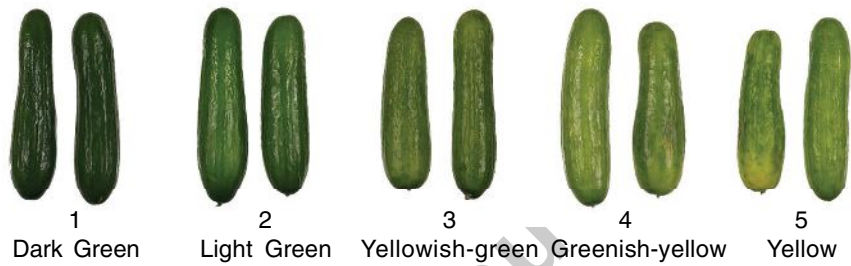
**Subjective:** The human eye is used to evaluate colour.

### **Advantages**

1. Faster and easier than objective measures.
2. Requires no specialized equipment.
3. Colour charts or guides can be used as references for matching and describing colours as in cucumber, tomato and bell pepper (Fig. 3, 4 and 5).

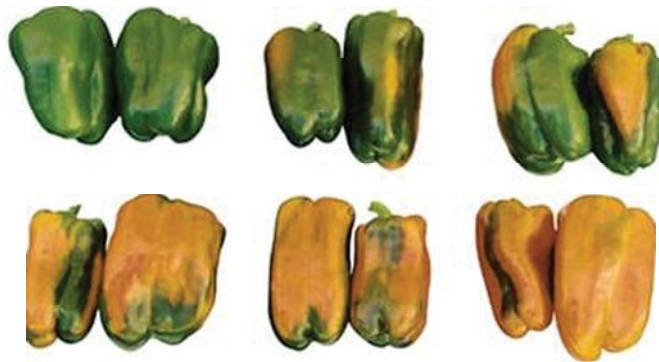


**Fig. 3: Tomato Maturity and ripeness**



CC-1 Cucumber  
Medium Green  
USDA, April 1999

**Fig. 4: Cucumber Colour Rating Scale**



**Fig. 5: Degree of ripening in bell pepper (As with other non-climacteric fruits, ripening does not follow after harvest)**

### ***Disadvantages***

1. Results can vary considerably due to human differences in colour perception and human error.
2. Available light quantity and quality can influence colour perception.

**Objective:** An instrument is used to provide a specific colour value based on the amount of light reflected off the commodity surface or the light transmitted through the commodity. This instrument is popularly known as ‘Hunter Colour Difference Meter’.

### ***Advantages***

1. Less variability in colour measurement.
2. Can measure small differences in colour accurately.
3. Can be automated on the packing line.
4. Portable hand-held units are available e.g Hunter colour differential meter (Fig. 6).



**Fig. 6: Hunter Colour Difference Meter**

### ***Disadvantages***

1. Requires specialized equipment at a significant cost.
2. May be slower than subjective evaluation.

### **4.4. Calendar Date**

For perennial fruit crops grown in seasonal climate which are more or less uniform from year to year, calendar date for harvest is a reliable guide to commercial maturity. Time of flowering is largely dependent as temperature and the variation in number of days from flowering to harvest can be calculated for some commodities by use of degree day concept. Such harvesting criteria can be developed by the growers based on their experiences.

### **4.5. Heat Units**

An objective measure of the time required for the development of the fruit to maturity after flowering can be made by measuring the degree days or heat units in a particular environment. It has been found that a characteristic number of heat unit or degree days are required to mature a crop under usually warm conditions, maturity will be advanced and under cooler conditions, maturity is delayed. The number of degree days to maturity is determined over a period of several years by obtaining the algebraic sum from the differences, plus or minus, between the daily mean temperatures and a fixed base temperature (commonly the minimum temperature at which growth occurs). The average or characteristic number of degree days is then used to forecast the probable date of maturity for the current year and as maturity approaches, it can be checked by other means.

### **4.6. Gloss**

Gloss is a visual aspect of quality that depends on the ability of a surface to reflect light. Gloss enhances the colour of most products but it is particularly valued in vegetables like capsicum, brinjal, tomato etc., to such a point that many of them are waxed and polished to improve their shine. In vegetables, gloss is associated in a certain way to turgidity, a

brilliant green is one of the indicators of freshness. It can also be used as a harvest index in brinjal, cucumbers, squash and other fruits that are harvested unripe where the decrease in shine indicates that they have developed too much and have lost part of their characteristics of flavour and texture. On the contrary, in melon and other species, it is indicative that it has reached ripeness for harvest. There are small portable instruments available for measurement of gloss.

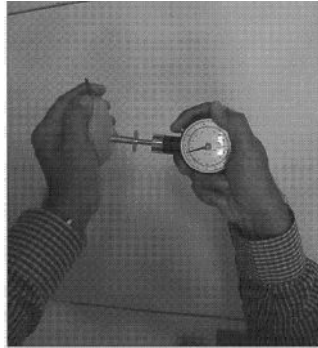
#### 4.7. Firmness

As fruit mature and ripen they soften by dissolution of the middle lamella of the cell walls. The degree of firmness can be estimated subjectively by finger or thumb pressure, but more precise objective measurement is possible with texture analyzer or penetrometer. In those species where the inflorescence is the marketable part such as broccoli or cauliflower or those that form “heads” like lettuce, cabbage, endive, etc; the compactness is the most relevant feature, since open inflorescences indicate that they were picked too late while non-compact “heads” are the consequence of a premature harvest. To a certain extent, it is also an indicator of freshness since compactness decreases with dehydration. The following instruments are used to measure the firmness of the produce.

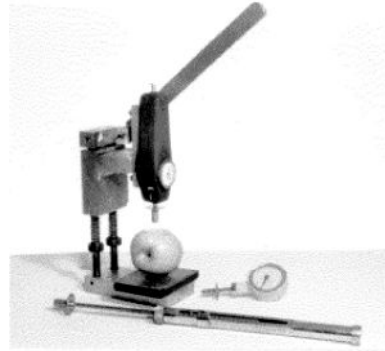
- Effe-gi fruit penetrometer – hand held probe with gauge for pounds-force (Fig 7a)
- Effe-gi fruit penetrometer – mounted on drill press stand (Fig 7b)
- Texture analyzer – used for advanced studies (Fig 8)

Penetrometer measures the pressure necessary to force a plunger of specified size into the pulp of the fruit. Such pressure is measured in pounds and kilograms. The unit should be written as poundforce (lbf) or kilogram (kgf) in order to avoid confusion with the units of mass.

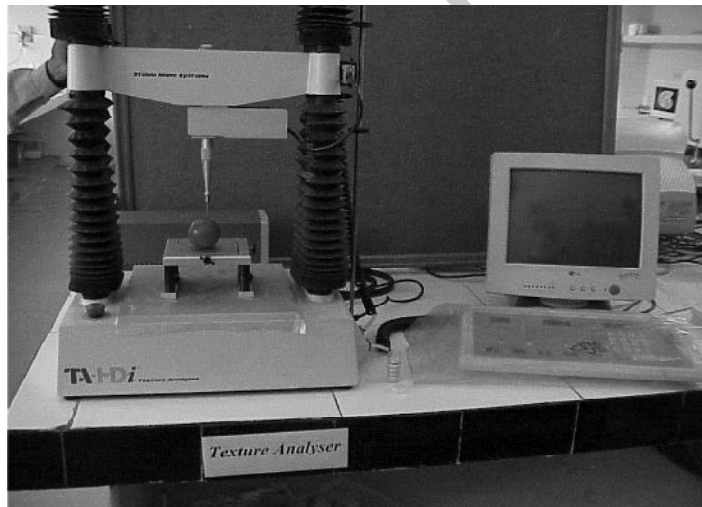
The texture analyzer is a microprocessor controlled texture analysis system. It measures force (hardness, softness/ tenderness), distance (penetration/ deformation) and time, thus, providing a 3-dimensional-product analysis. Force is measured against a set distance and vice versa. The textural analyzer consists of a test box, control console (key board) and a probe carrier having a very sensitive load cell.



**Fig. 7a: Penetrometer – hand held probe with gauge**



**Fig. 7b: Penetrometer – mounted on drill press stand**



**Fig. 8: Texture Analyzer**

#### 4.8. Chemical Measurements

Measurement of chemical characteristics of produce is an obvious approach to the problem of maturity determination. The total soluble solids of the fruit can be measured with refractometer, which indicate the harvest maturity of vegetables like muskmelon, watermelon. Acidity is readily determined on a sample of extracted juice by titration e.g. tomato for processing.

#### 4.8.1. Total Soluble Solids (TSS)

In the fruit juice, sugars, acids, water soluble vitamins, amino acids, hemicellulose are the major soluble solids used to estimate the sugar content. TSS can be determined in a small sample of fruit juice using refractometer (Fig 9a, 9b). The refractometer measures the refractive index, which indicates how much a light beam is “bent” when it passes through the fruit juice. The temperature of the juice is a critical factor for accuracy, because all materials expand when heated and becomes less dense. For a sugar solution, the change is about 0.5% sugar for every 5.6°C. Good quality refractometers have an inbuilt temperature compensation capability. The refractometer has different scales (0-32°B), (28-62°B) and (56-92°B) which can be read directly. For large size fruits like muskmelon, watermelon these should be cut from stem to blossom end and to the centre of the fruit to account for variability in TSS from top to bottom and inside to outside of the fruit. The value of TSS as recorded by refractometer decreases with increase in temperature. If a sample has TSS of 15° Brix at 20°C, the same sample shall show a TSS of 14.22° Brix at 30°C and 15.61° Brix at 10°C. The Recommended minimum soluble solid content (at harvest) of muskmelon and watermelon are given in Table 4.



Fig. 9a: Hand Refractometer



Fig. 9b: Digital Refractometer

Table 4 : Recommended minimum soluble solid content at harvest

| Crop        | TSS (°B) |
|-------------|----------|
| Muskmelon   | 10-12    |
| Water melon | 10       |



### 4.8.2. Titratable acidity (TA)

In tomato, citrus and many other fruits/vegetables, acidity is reduced as the fruit matures. The organic acids present in the fruits and vegetables give flavour, brightness, stability and keeping quality. Commonly occurring acids in fruits and vegetables are citric acid, fumeric acid, tartaric acid, malic acid and oxalic acid. Among various vegetable crops tomato, cauliflower, peas, carrot, spinach and onion contain citric acid 0.47, 0.21, 0.11, 0.09, 0.08 and 0.02 per cent respectively.

Titrate acidity (TA) can be determined by titrating a know volume of juice with 0.1N NaOH to end point of pink colour as indicated by phenolphthalin indicator. The millilitres of NaOH needed are used to calculate the TA. The TA expressed as per cent malic, citric or tartaric acid can be calculated as follows:

$$TA = \frac{\text{acid meq. Factor} \times N(\text{NaOH}) \times A \times 100}{B} = \frac{0.064 \times 0.1 \times A \times 100}{B}$$

A = ml of 0.1 N NaOH used; B = Volume of juice taken (ml)

| Acid     | Acid meq. factor | Commodities                               |
|----------|------------------|---|
| Citric   | 0.064            | Tomato, cauliflower, pea, carrot, spinach |
| Malic    | 0.067            | Apple, pear, peach, tomato                |
| Tartaric | 0.075            | Grape                                     |

### 4.8.3. Dry matter

There is a correlation between dry matter content and organoleptic characteristics mainly used by the industry. In general, a higher content of solids means higher industrial yield and taste. This is particularly important in dehydrated products. In potato, a higher dry matter content is associated with better cooking quality. For the fresh market, however, dry matter content is not used as an indicator of the time of harvest

Dry matter content is calculated by recording the initial weight of sample and kept in hot air oven for drying at  $60 \pm 2^\circ\text{C}$ . Record the loss in weight after every 1-2 hour till it becomes constant. When the sample

weight reached constant then records the final weight of the sample. The Dry matter expressed as percentage can be calculated as follows:

$$\text{Dry matter} = \frac{\text{Final weight}}{\text{Initial weight}} \times 100$$

**Example:** Let weight of Petri Plate (P) = 50 g, Petri plate + sample (initial) weight = 70 g, Petri plate + sample (final) weight = 54 g

$$\text{Dry matter} = \frac{54 - 50}{70 - 50} \times 100 = 20\%$$

## 5. MATURITY INDICES FOR SOME VEGETABLES

Vegetables are harvested over a wide range of physiological stages, depending upon which part of the plant is used as food. High quality flavour and texture is often correlated with smaller, immature sized vegetables. The following table (Table 5) provides recommended maturity indices for harvesting high quality produce for selected vegetables.

**Table 5: Maturity indices of vegetables for harvesting high quality produce**

| Crop   | Harvest Index  |
|--|--|
| <b>Root, bulb and tuber crops</b>            |  |
| Radish and carrot                            | Large enough and crispy (over mature if pithy)                     |
| Potato, onion and garlic                     | Tops beginning to dry out and topple down                          |
| Yam bean and ginger                          | Large enough (over mature if tough and fibrous)                    |
| Green onion                                  | Leaves at their broadest and longest                               |
| Leek   | 2 to 5 cm diameter   |
| <b>Fruit vegetables</b>                      |  |
| Cowpea, snap bean, sweet pea and winged bean | Well-filled pods that snap easily                                  |
| Lima bean and pigeon pea                     | Well-filled pods that are beginning to lose their greenness        |
| Okra   | Desirable size (5-10 cm long) reached and the tips of pods pliable |

[Table Contd.]

Contd. Table]

| <b>Crop</b>                     | <b>Harvest Index</b>  |
|---------------------------------|---|
| Snake gourd and bottle gourd    | Desirable size reached and thumbnail can still penetrate flesh readily (overmature if thumbnail cannot penetrate flesh readily) |
| Brinjal, bitter gourd, cucumber | Desirable size reached but still tender (overmature if colour dulls or changes and seeds are tough)                             |
| Tomato                          | Seed not cut when fruit is sliced, jelly in atleast one locule, minimum mature green 2 stage                                    |
| Bell pepper                     | Fruit full developed, still green and shining   |
| Muskmelon                       | Easily separated from vine with a slight twist leaving clean cavity   |
| Honeydew melon                  | Change in fruit colour from a slight greenish white to cream; aroma noticeable  |
| Watermelon                      | Colour of lower part turning creamy yellow, dull hollow sound when thumped, TSS 10%   |
| <b>Flower vegetables</b>        |   |
| Cauliflower                     | Curd compact, well developed and atleast 15 cm in diameter  |
| Broccoli                        | Bud cluster compact, adequate diameter, all florets should be closed  |
| Brussels sprout                 | Bud that are 2.5 to 5.0 cm in diameter  |
| <b>Leafy vegetables</b>         |   |
| Lettuce (Head)                  | Compact head, not too firm  |
| Lettuce (Leaf)                  | Adequate size leaves  |
| Cabbage                         | Head compact (overmature if head cracks)  |
| Celery                          | Big enough before it becomes pithy  |

## CHAPTER 5

# HARVESTING AND FIELD HANDLING

---

After the proper maturity stage has reached, the produce needs to be harvested for various markets. Harvesting is the gathering of plant parts that are of commercial interest. These include: *Fruits* - e.g. tomato, bell pepper, brinjal etc.; *root crops* - e.g. beet, carrot etc; *Leafy vegetables* – spinach, lettuce and amaranth; *Bulbs* - onion or garlic; *Tubers* - potato; *stems* - asparagus; *petioles* - celery and *Inflorescences* - broccoli, cauliflower etc. Harvest marks the end of the growing period and the commencement of market preparation or conditioning of fresh products. While harvesting, it must be kept in mind that all vegetable crops are very delicate and mishandling at harvesting may lead to mechanical injuries, compression injuries that are irretrievable. The injuries on vegetables enhances ethylene production, moisture loss and serves as an entry point for a wide range of pathogens, hence causing quick loss in quality and post-harvest life of produce. The injury caused to the produce during harvesting not only spoils the commodity but also make it unfit for long-term storage or long-distance transport. In many cases, internal or external defects do not affect product excellence, but the consumer rejects them since the presence of defects is one of the main components of appearance and therefore, of the primary decision to purchase. Different causes during growth (climate, irrigation, soil, variety, fertilization, etc) can lead to morphological or physiological defects. Some examples of morphological defects are “root ramifications” in carrots, “catface” in tomatoes, “knobby” tubers and “hollow heart” in potatoes, etc. Tipburn on leafy vegetables and black heart in celery due to calcium deficiencies as well as the internal rots in various species due to boron deficiencies

are examples of physiological defects. More serious are those physical or physiological defects that originate during or after preparation for the fresh market and that show up at retail or consumer's level. Proper training to the workers engaged in harvesting on what to harvest and how to harvest and the use of proper harvesting tools can reduce postharvest losses.

## **1. HARVESTING AND FIELD HANDLING**

### **1.1. Handle with Care**

The quality and condition of produce sent to market and its subsequent selling price are directly affected by the care taken during harvesting and field handling. The planning and carrying out of harvesting operations must observe basic principles.

### **1.2. Goals of Harvesting**

After successfully producing a high quality crop, it is time to harvest the fresh produce and prepare it for market. The goals of harvesting systems are:

- to gather the commodity from the field at proper stage of maturity;
- with a minimum amount of damage and losses;
- at the rate required for optimum handling;
- in a cost effective way.

### **1.3. Objectives of Grower**

The objective of the grower should be:

- to harvest a good quality crop in good condition;
- to keep the harvested produce in good condition until it is sold;
- to dispose of the crop to a buyer or through a market as soon as possible after harvest.

### **1.4. Planning**

To meet these objectives, success in harvesting and marketing must depend on planning from the earliest stages of production, particularly in regard to:

- crop selection and timing to meet expected market requirements;
- contacts with buyers so that the crop can be sold at a good price when ready for harvest;
- planning harvest operations in good time;
- arranging for labour, equipment and transport;
- providing full supervision at all stages of harvesting and field handling.

### 1.5. Labour

For small-scale production, the labour supply will probably not be a problem but for commercial production more exact requirements will have to be met in regard to training and supervising labour. It is economically sound in terms of return to invest more in proper packing and handling of the produce before it leaves the farm. Growers will have to train their own field labour.

This training should cover general aspects of produce handling for all workers and specific training for those engaged in tasks requiring greater skill.

**General training:** For everyone concerned with harvesting and field handling, general training should include demonstrations of the causes and effects of damage to produce, emphasizing the need for careful handling at all times to avoid mechanical injuries from causes such as wooden containers with rough edges, splinters, protruding nails or staples; overpacking containers; long fingernails or jewellery; throwing, dropping or rough handling of field containers.

To avoid the contamination of harvested produce training should be given to stop the causes that spread contamination which includes placing the produce directly on to the soil, especially wet soil; using dirty harvesting or field containers contaminated with soil, crop residues or decaying produce; contact with oil, gasoline, or any chemicals other than those used specifically for authorized post-harvest treatments.

**Specific training:** Workers allocated to specialized tasks, such as crop selection and harvesting, and the post-harvest selection, grading and packing of the crop should be given specific training. This will include demonstration and explanation of:

- the methods of evaluating the readiness of the crop for harvest, and the rejection of unsuitable produce at harvest, according to market requirements;
- the actual technique to be employed in harvesting the produce, e.g. breaking the stem or plucking, clipping, cutting or digging;
- the use of transfer of produce to field or marketing containers;
- the selection of marketable produce at the field assembly point and grading for size and quality;
- the correct application of post-harvest treatment (where produce is to be packed on the farm directly into marketing packages), e.g. fungicides, wax coating etc.
- the method of packing, market packages or other containers.

### 1.6. Conditions Right for Harvesting a Crop

The decision as to when to start harvesting will depend largely on weather conditions and the state of the market. The flexibility of the marketing date will depend on the crop. For example, root crops can be harvested and sold over a long period, or stored on the farm to await favourable prices. Whereas leafy vegetables like lettuce, celery, coriander leaves must be marketed as soon as they are ready otherwise they will spoil.

When the decision to harvest has been made, the best time of day must be considered. Produce for local markets can be harvested early in the morning. For more distant markets it may be an advantage to harvest in the late afternoon and transport to market at night or early the next morning. The aim is to dispatch the produce to market in the best possible condition i.e. as cool as possible, properly packed and free from damage. The basic rules to observe are:

- harvest during the coolest part of the day: early morning or late afternoon;
- do not harvest produce when it is wet from dew or rain;
- protect harvested produce in the field by putting it under open-sided shade when transport is not immediately available.

## 2. METHOD OF HARVESTING

Harvesting can be performed by hand or mechanically. However, for some crops - e.g. onions, garlic, potatoes, carrots and others - it is possible to use a combination of both systems. In such cases, the mechanical loosening of soil facilitates hand harvesting. The choice of one or other harvest system depends on the type of crop, destination and acreage to be harvested. Vegetables for the fresh market are hand harvested while vegetables for processing or crops grown on a large scale are mainly harvested mechanically.

**Hand harvesting** is particularly suitable for crops with an extended harvest period. The rate of harvesting can be increased by hiring more workers if, for example, due to climate, there is accelerated ripening and a need to harvest the crop quickly. The main benefit of hand harvesting over mechanized harvesting is that humans are able to select the produce at its correct stage of ripening and handle it carefully. This results in higher quality product with minimum damage.

Most staple roots and tubers that grow beneath the soil are likely to suffer mechanical injury at harvest because of digging tools, which may be wooden sticks, hoes or forks. Harvesting of these crops is easier if they are grown on raised beds or mounds, or “earthed up” as is common in potato-growing. This enables the digging tool to be pushed into the soil under the roots or tubers. This method can also be used for celery if it has been earthed up or buried to blanch the stems.

In vegetables, either the whole or a part of vegetative growth can be harvested manually by hands only or with sharp knives. Harvesting methods vary with plant parts harvested:

- leaves only (spinach, palak, coriander etc.) and lateral buds (Brussels sprouts): the stem is snapped off by hand;
- above-ground part of the plant (cabbage, cauliflower, lettuce): the main stem is cut through with a heavy knife, and trimming is done in the field (the cut stem should not be placed on the soil);
- bulbs (green onions, leeks, mature bulb onions): immature green onions can usually be pulled from the soil by hand; leeks, garlic and mature bulb onions are loosened by using a digging fork as for root crops (such as carrots) and lifted by hand. Simple tractor implements are available for undermining bulbs and bringing them to the surface.



The main advantages of **mechanized harvesting** are speed and the reduced cost of harvesting. However, because of the risk of mechanical damage, it can only be used in those crops that require a single harvest. A decision to purchase equipment requires careful evaluation of the initial investment required, maintenance costs and the long period in which equipment may have to stand idle. In addition to this, all operations need to be designed specifically for mechanized harvesting - distances between rows, field leveling, pesticide spraying, cultural practices to varieties which can be adapted to rough handling. Market preparation (grading, cleaning, packing, etc.) and the trade should also be able to handle large volumes of produce.

Another harvesting method is “**Field packing**” means selection, sorting, trimming and packing the produce in the field at the time of harvest (Fig. 1a). The products are then transported to a central cooling facility. It has great potential to reduce mechanical damage by reducing the number of postharvest handling steps between the field and the consumer. Any practice that reduces the number of times the produce is handled will help reduce postharvest losses. Field packing often also reduces costs since there is no need to build and manage a packhouse and can reduce handling problems. When crops are field packed, the picker harvests and then immediately packs the produce after minimal handling. When lettuce is field packed, several wrapper leaves are left on the head to help cushion the produce during transport. Similarly the okra can be harvested by wearing cotton gloves to prevent bruising and then field packed.

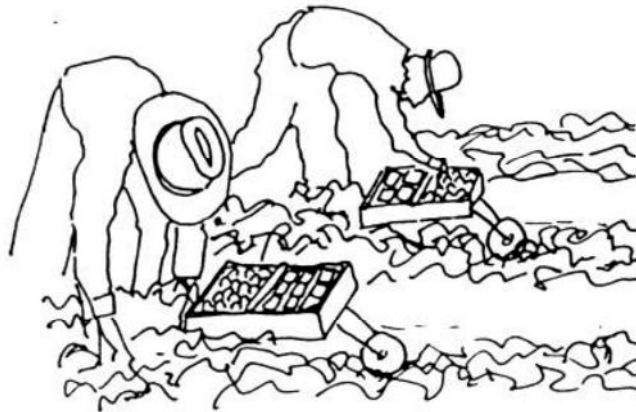
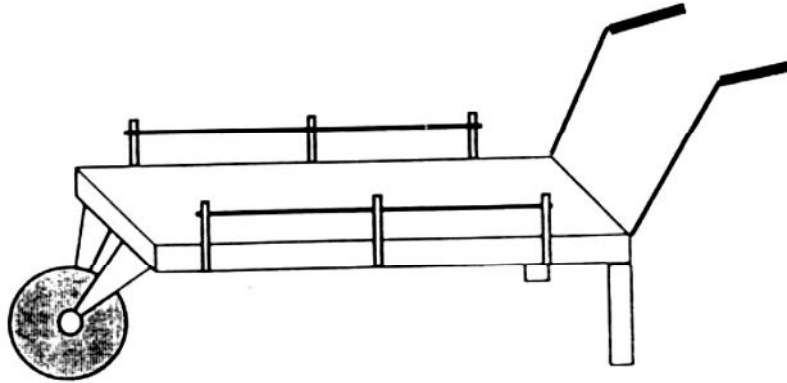


Fig. 1(a): Field Packing and cart used for field packing (Source: Kitinoja and Gorny, 1998)



**Fig. 1(b): Field Packing and cart used for field packing (Source: Kitinoja and Gorny, 1998)**

Providing workers with a small cart can help to reduce the amount of bending and lifting the produce during harvest. The carts shown in fig. 1b have a single wheel in front, and can be pushed along the row ahead of the picker. Filled cartons should be immediately moved into the shade and then into the cooling area as soon as possible. Small, mobile field packing stations are designed to be moved along with the packers and to provide shade for packing operations (fig. 2). A mobile field packing station should provide a comfortably place for packers to fill boxes and have a wide roof to provide shade. The vegetables which are field packed by use of mobile field packaging stations include cabbage, cauliflower, lettuce etc. One difficulty with field packing, however, is the need for increased supervision to maintain consistent quality in the packed product. Field packing is not used for commodities that require classification for both colour and size, such as tomato.

### 3. HANDLING DURING HARVEST

Harvesting involves a number of other activities undertaken in the field. This includes those of commercial interest. Examples include pre-sorting, removal of foliage and other non-edible parts. In some cases, the product is completely prepared for the market in the field. However, the normal practice is to empty the harvest containers into larger ones for transportation to the packhouse. Here, they are dry or water dumped



Fig. 2: Mobile field packing station (Source: Kitinoja and Kader, 1995)

onto grading lines. While these activities are being undertaken, bruising which has a cumulative effect can affect the final quality of product.

Different types of lesions exist. Wounds (cuts and punctures) are frequent during harvest and mainly produced by the harvesting tools used for the removal of plants. Other causes include the nails of pickers or peduncles from other fruits. Rotting fungi and bacteria penetrate produce in this way. This type of damage can be easily detected and is usually removed during grading and packing. Bruises are more common than wounds and are less noticeable and symptoms show up several days later when the product is in the hands of the consumer. There are three main causes of bruises:

- i. **Impact:** Injury caused either by dropping the produce (or packed produce) onto a hard surface or the impact of vegetable rubbing against other vegetable. These types of bruises are common during harvest and packing.

- ii. **Compression:** It is deformation under pressure. This often occurs during storage and bulk transportation and is caused by the weight of the mass of produce on bottom layers. It also happens when the packed mass exceeds the volume of the container or by the collapse of weak boxes or packages unable to withstand the weight of those piled up high.
- iii. **Abrasion:** Superficial damage produced by any type of friction (other fruits, packaging materials, packing belts, etc.) against thin-skinned fruit such as okra. In onions and garlic abrasion results in the loss of protective scales.

Bruise symptoms depend on the affected tissue, maturity, type and severity of the bruise. They are cumulative and in addition to their traumatic effect, trigger a series of responses to stress, including the onset of healing mechanisms. This physiological reaction is: a temporary increase in respiration which is associated with degradation; a transient production of ethylene, which accelerates maturation and contributes to softening. In some cases, mechanical disruption of membranes puts enzymes in contact with substrates which lead to the synthesis of secondary compounds that may affect texture, taste, appearance, aroma or nutritive value. Firmness on the site of impact decreases rapidly because of damage and cell death as well as the loss of tissue integrity.

#### 4. GENERAL DO'S AND DON'TS REGARDING HARVESTING

- Consider the needs and requirements of the market for your produce.
- Vegetable produce being very delicate in nature should be handled with extreme care at the time of harvest.
- For harvesting, always use containers which are clean; smooth and free of rough edges; vented; and not too small/large.
- Stackable plastic crates should be used as field containers during harvest as these are durable, reusable and easily cleaned.
- Harvesters should be trained to recognize the proper maturity stage for the produce (such as size, shape, colour, sweetness or firmness).
- Use sharp knives and clippers for harvesting.

- For reducing the mechanical damage to the produce during harvesting, wear cotton gloves, trim fingernails and remove jewellery such as rings and bracelets.
- The pickers should be trained to empty their picking bags/baskets with care, never dumping or throwing produce into field containers.
- To reduce food safety hazards always keep produce clean and free from soil contamination.
- Prevent heat and sun damage to the produce by keeping it under shade.
- All tools and equipment that come in direct contact with produce should be disinfected.
- Promote early morning or late afternoon harvest; low temperature prevailing at that time would help to keep produce cooler for longer time.
- Field packing to reduce the number of times produce is handled between harvest and marketing should be promoted.
- Root and tuber crops should be cured before storing.

## CHAPTER 6

# COOLING DELAY AND PRE-COOLING

---

## 1. COOLING DELAY

For most vegetables quality begins to drop right after harvest, the common recommendation is to begin cooling as soon as possible after harvest. Cooling delays cause reduced product quality for three main reasons: 1) allowing respiration and associated normal metabolism to continue at high rates, consuming sugars, acids, vitamins and other constituents 2) fastening water loss and 3) increasing decay development. Delays may also allow increased susceptibility to ethylene damage, but ethylene concentrations are usually low near cooling facilities and ethylene does not usually cause as much damage as the other three factors. Delays can also cause undesirable product curvature and growth, but this is a problem with only a few commodities such as asparagus and green onions. Each 1-hour delay between harvest and cooling, results in loss of one day of shelf life. Produce left at ambient dry conditions loses 100 times more moisture than produce shifted to cold room. According to International Institute of Refrigeration (IIR), perishable products should be brought to their final storage temperature within 24 hours of harvest. The main reasons for reduction in product quality due to cooling delay are discussed below:

### 1.1. Respiration

Fresh produce consumes photosynthates that were stored in the product before harvest. Consumption rate depends on the respiratory activity of a particular commodity and its temperature. Commodities such as cabbage and potatoes have low respiration rates compared with mushrooms,

asparagus and sweet corn. At temperatures above 21-24°C, respiration is especially high. For example at 32°C, asparagus respire three times faster than at 16°C. Temperatures above 32°C may cause ripening disorders in commodities such as tomatoes. Cooling products from high summer field temperatures to room temperature (21-24°C) significantly slows respiration.

Increased respiration caused by a few hours of cooling delay rarely causes a noticeable effect on external product quality. The consumer may detect slightly poorer eating quality and appearance and the product may have lost some nutritional value, but it is often very saleable. For example, cantaloupe melons have shown that cooling delays up to 12 hours, even with afternoon harvested product, cause no consistent loss of visual appearance or soluble solids. However delays do cause measurable effects on quality and many produce items may not be suitable for long-distance transport or long-term storage if exposed to significant cooling delays. For example, sweet corn begins losing sweetness immediately after harvest and the rate of loss increases with increasing temperature. Climacteric vegetables like tomatoes are intentionally held at 18-24°C after packing to promote ripening. If kept at a relative humidity above 85%, these commodities will actually improve in quality in a controlled ripening process. But they must be cooled after ripening has been started to slow further ripening during transport and handling.

## 1.2. Water Loss

Shriveling and the loss of fresh, glossy appearance are two of the most noticeable effects of cooling delays, particularly for commodities that lose water quickly and show visible symptoms at low levels of water loss, like most leafy vegetables. Air temperatures have a particularly great effect on rate of water loss. To prevent the consumer from seeing shrivel, moisture loss in the field should be kept less than 1%. Moisture loss is slowed by holding produce in plastic liners. Liners should be vented to prevent temperature rise caused by product respiration and damaging levels of carbon dioxide. Solid bin covers also act as a moisture barrier. Some produce items can tolerate water contact, and spraying them with water slows product moisture loss and can even rehydrate slightly wilted produce. However water remaining on the surface tends to increase decay development and water should be clean and sanitized. Many leafy vegetables can completely

recover from less than a few percent water loss by contact with hydro-cooler water. If hydro-cooling is not available, many vegetables can be sprayed with water before forced air or vacuum cooling to regain some water and reduce loss during subsequent cooling. Water loss is not always a detriment. Some products, like carrots, need some turgidity loss to reduce mechanical damage in handling and fresh-cut processing. Slight water loss in green onions reduces curvature problems.

### 1.3. Decay

Cooling delays tend to increase decay losses, although decay becomes apparent many days after the cooling delay. Damage can be minimized by applying decay control treatments within a reasonable time after harvest. Free water together with high humidity speeds decay development in mushrooms. Decay-prone vegetables should be protected from prolonged water contact and very high humidity during cooling delays. The advantages and disadvantages of cooling delay in selected vegetables are given in Table 1.

## 2. PRE-COOLING

Pre-cooling of the produce soon after their harvest is one of the important components of the cool chain, which ultimately affect the shelf life of the produce. The main purpose of pre-cooling is to immediately remove the field heat from the produce. Pre-cooling not only remove field heat but also reduces rate of respiration, rate of ripening, production of ethylene, loss of moisture and spread of decay.

### 2.1. Measurement of Pre-cooling Rate

The efficiency/performance of a pre-cooler can be measured and prediction of cooling accomplished in a certain interval can be done by determining the “7/8 cooling time”. Seven-eighths cooling may be defined as the time required to cool the product 7/8 of the way from its initial pulp temperature to the temperature of the cooling medium. The remaining 1/8<sup>th</sup> is lost during refrigerated storage or transport.

#### Example:

$$T_{\text{refrigerant}} = \text{Cooling medium temperature} = 10 \text{ }^{\circ}\text{C}$$

$$T_{\text{initial product}} = \text{Initial product temperature} = 30 \text{ }^{\circ}\text{C}$$



**Table 1: Advantages and disadvantages of cooling delay in selected vegetable**

| Product                | Allowable delay (hrs) | Disadvantage of cooling delay                 | Advantage of cooling delay   |
|------------------------|-----------------------|---|--|
| Artichoke              | 8                     | Water loss                                    | None   |
| Asparagus              | 4                     | Increased toughness, reduced shelf life       | None   |
| Broccoli               | 4                     | Water and firmness loss, reduced shelf life   | None   |
| Cauliflower            | 8                     | Water loss                                    | None   |
| Carrot                 | 8                     | Water loss, loss of crispness                 | Reduce cracking if carrots are cold and turgid                                   |
| Cucumber               | 8                     | Water and chlorophyll loss                    | curvature  |
| Dry garlic             | 16                    | None  | None   |
| Dry onion              | 16                    | None  | Curing and drying  |
| Green beans            | 8                     | Water loss                                    | Curing and drying  |
| Green onion            | 8                     | Texture loss                                  | None   |
| Mushroom               | 4                     | Water loss, decay                             | Water loss during cooling delay may reduce                                       |
| Potato, Sweet potato   | 16                    | Water loss if low RH                          | None   |
| Peppers                | 16                    | Water loss, loss of firmness, increased decay | Cure harvest wounds with high RH   |
| Spinach                | 4                     | Water loss                                    | Reduce mechanical injury if peppers cold and turgid                              |
| Summer squash          | 8                     | Water loss                                    | None   |
| Tomato                 | 16                    | Increased decay,                              | None   |
| Green leafy vegetables | 4-8                   | Loss of crispness, water loss                 | Colour development<br>Product is subject to mechanical injury if cold and turgid |

$T_{\text{final}}$  = Product temperature when it is 7/8<sup>th</sup> cooled

$$T_{\text{final}} = T_{\text{initial product}} - [7 \times (T_{\text{initial product}} - T_{\text{refrigerant}})/8]$$

$$T_{\text{final}} = 30 - [7 \times (30 - 10)/8] = 12.5 \text{ }^{\circ}\text{C}$$

So 7/8<sup>th</sup> cooling time is the time required to cool the product from 30°C to 12.5°C

## 2.2. Methods of pre-cooling

Several methods of pre-cooling are used for vegetable commodities:

- Room cooling
- Forced-air cooling
- Hydro-cooling
- Vacuum cooling
- Package icing

Mostly room cooling, forced air-cooling and hydro-cooling methods are used for wide range of commodities. Some commodities can be cooled by several methods, but most commodities respond best to one or two cooling methods.

### 2.2.1 Room cooling

It is low cost and slow method of cooling which require no additional equipment for precooling. In this method, produce is simply loaded into a cool room and cool air is allowed to circulate among the cartons, sacks, bins or bulk load (Fig. 1). This method is most suitable for less perishable vegetables such as potatoes, onion, garlic and sweet potato. Since highly perishable vegetables will deteriorate too much before being adequately cooled, it is important to leave adequate space between stacks of boxes inside the cold room in order to cool the produce more quickly and about 1 inch (2.5 cm) space is sufficient for this purpose. It is observed that place-packed produce require double the time for cooling as compared to tray packed produce. The stacks of produce inside the cold room should be narrow, about 2-3 cartons. Fans should be installed to move the cold air throughout the room. Check the temperature of the produce within

the packages at various locations in the room to determine that the produce being cool as desired.

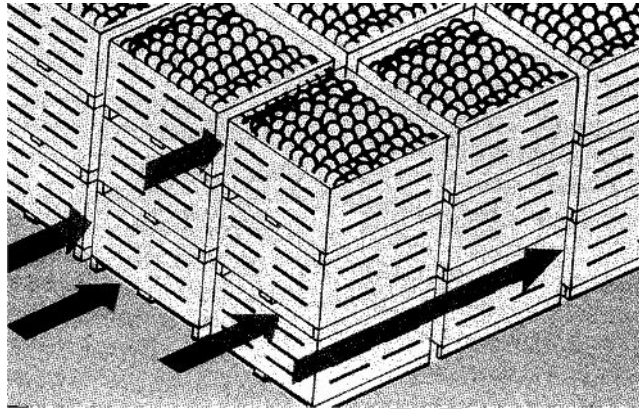


Fig. 1: Room cooling of produce in bins (Source: Kader, 2002)

### ***Vegetable crops suitable for room cooling***

Potato, dry onion, garlic, winter squash, radish, carrot, sweet potato.

### ***Advantages***

- Produce can be cooled and stored in the same room which saves handling costs.
- No extra cost for pre-cooling equipment.
- Suitable for those vegetables which are not marketed soon after harvest, crops that are stored unpacked and crops that require only mild cooling after harvest.

### ***Disadvantages***

- Slow method of cooling.
- Excessive water is lost from the produce due to slow cooling.
- Non-uniform cooling.
- Space requirements for room cooling are more as compared to storage, thus loss of storage capacity.
- Unsuitable for packed produce, takes double time to cool the packed produce as compared to produce kept in ventilated trays.

### 2.2.2 Forced-air cooling

Forced-air cooling is mostly used for wide range of vegetable produce. This is the faster method of pre-cooling and takes 1/4 to 1/10 of the time needed for room cooling. Forced air-cooling pulls or pushes air through the vents/holes in storage containers. In this method uniform cooling of the produce can be achieved if the stacks of pallet bins are properly aligned. This is the most widely adapted pre-cooling method for small-scale operations. Some cold rooms have permanent forced-air cooling units built into a sidewall. Small-scale growers and handlers have designed a variety of portable forced air coolers for use. Forced-air cooling is generally of four types :

- (a) Forced-air cooling tunnel
- (b) Cool wall type forced-air cooling
- (c) Serpentine forced-air cooling
- (d) Forced-air evaporative cooling

In forced air cooling tunnel, cool wall type and serpentine forced air cooling, normally air is pulled through the producer by using exhaust fan which generate a pressure gradient across the produce. Whereas, in forced-air evaporative cooling cool air pushed through the produces by using desert coolers. The CFB boxes or containers used for pre-cooling are specifically designed with ventilation holes so that cold air is circulated through these holes resulting in uniform cooling of produce.

- (a) **Forced-air cooling tunnel:** In this method, a row of palletized containers or bins are placed on either side of an exhaust fan leaving an air space between the rows (fig. 2). The air space between the rows and the open ends on one side (opposite to the direction of exhaust fan) are then covered to create an air plenum tunnel. The exhaust fan creates negative air pressure within the tunnel. The negative pressure then causes air from the room to pass through ventilation holes to directly contact the warm product, sweeping heat from the produce as it moves.
- (b) **Cool wall type forced-air cooling:** This forced-air cooling system uses a permanent air plenum equipped with exhaust fans (Fig. 3). It is often located at one end or side of a cool room, with the exhaust fan designed to move air over the evaporator (refrigeration) coils.

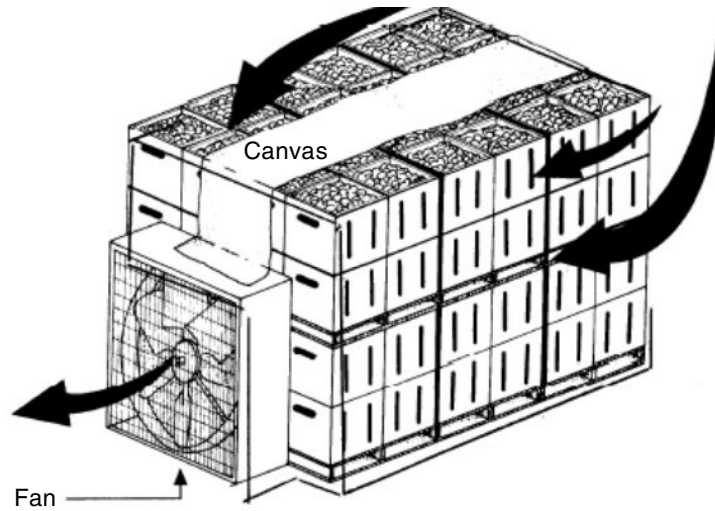


Fig. 2: Forced-air cooling tunnel (Source: Gast and Flores, 1991)

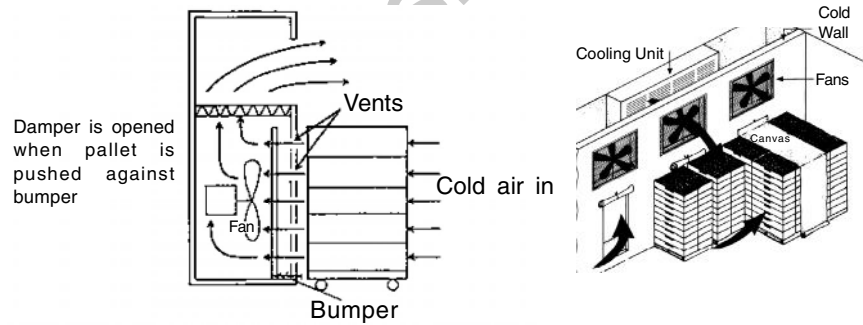
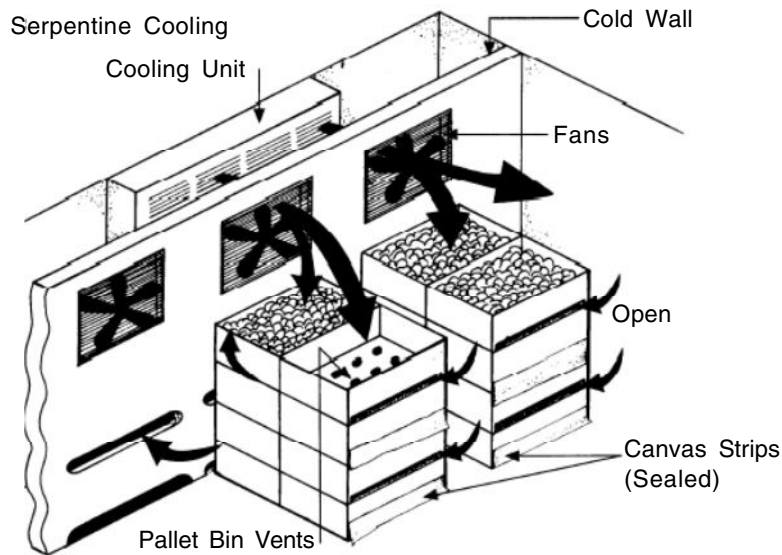


Fig. 3: Cool-wall type forced-air cooler (Source: Rij et al. 1979; Gast and Flores, 1991)

The stacks or pallets are placed in such a way that opening of the boxes/stacks are on the room side. The damper is opened when pallet is pushed against the bumper. Each pallet starts cooling as soon as it is in place and there is no need to wait till the tunnel is completely filled. Different packages or even partial pallets can be accommodated by proper design of the damper system.

- (c) **Serpentine forced air cooling:** The serpentine system of forced-air cooling is used to cool the produce in pallet bins. Bins must have



**Fig. 4 : Serpentine forced-air cooling (Source: Gast and Flores, 1991)**

bottom ventilation slots, with and without side ventilation. It is a modification of cool-wall design which allows the forklift openings between bins to be used for movement of air. To achieve the desired airflow pattern, openings are placed in the cold wall to match alternate forklift openings, starting one bin up from the floor. On the room side of the bins, these same openings are blocked (Fig. 4). Therefore, the air moves up and down between the bins and reaches to the cool wall. In this system, there is no need to keep the space between rows of bins, as opposite to the room cooling method. Rapid cooling is achieved because air flows vertically through relatively shallow layer of product.

- (d) Forced-air evaporative cooling :** This is simply a forced-air cooling system in which the air is cooled with evaporative cooler (desert cooler) instead of mechanical refrigeration. The evaporative cooler produces air at few degrees above the outside wet bulb temperature having relative humidity above 90% and that cool air is pushed through the produce (Fig. 5). This method is suitable for cooling producer that is very sensitive to moisture loss. It is most energy efficient method than other methods of forced air cooling.

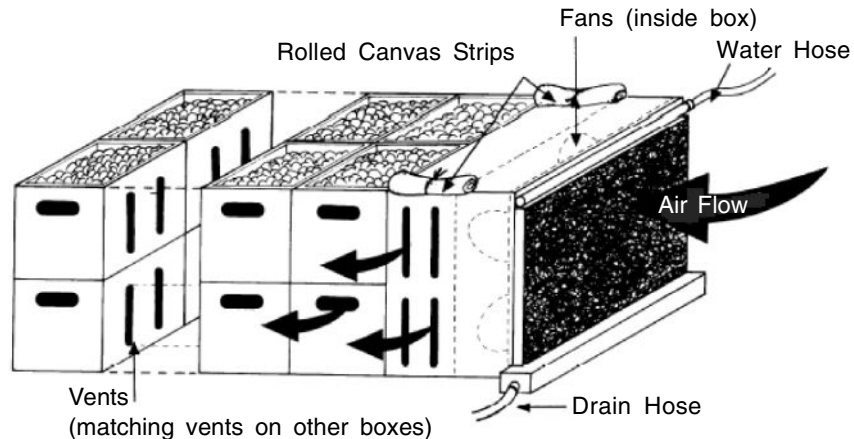


Fig. 5: Evaporative forced-air cooling (Source: Gast and Flores, 1991)

### ***Vegetable crops suitable for forced-air cooling***

Tomato, mushrooms, cucumber, brinjal, okra, summer squashes, peppers, melons etc.

### ***Advantages of forced-air cooling:***

- Fast method of pre-cooling.
- Suitable for wide range of highly perishable vegetables.
- Most suitable for small scale operations.
- Uniform cooling, if palletized containers or bins properly align.
- Cooling times can be controlled for different types of produce by controlling the air flow rate.

### ***2.2.3 Hydro-cooling***

Hydro-cooling is the utilization of chilled or cold water for lowering the temperature of the product in containers before packaging. For the packed commodities it is less used because of difficulty in the movement of water through the containers and because of high cost involved in water tolerant containers. This method of pre-cooling not only avoids water loss but may even add water to the commodity. The hydro-cooler normally used are of two types:

- (a) **Shower type:** In this type of hydro-cooler, cold water is pumped to an overhead perforated pan which produces a shower over the produce which may be in bins or boxes or loose on a conveyer belt passing beneath (Fig. 6). The water leaving the product may be filtered to remove debris, and then passed over refrigeration coil where it is re-cooled.

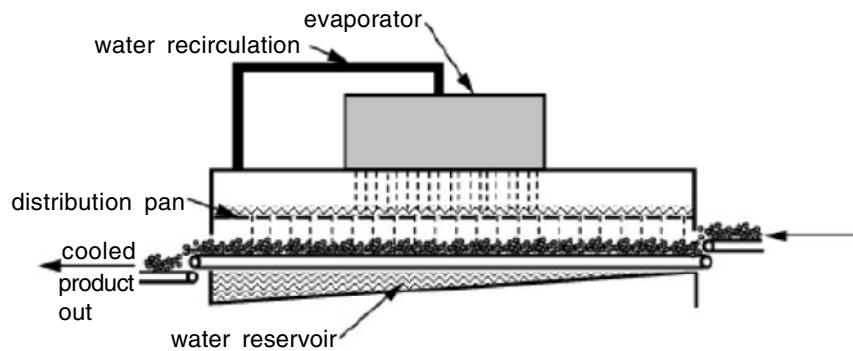


Fig. 6: Continuous flow shower type hydro-cooler  
(Source: Thompson et al, 1998)

- (b) **Immersion type:** In this type of hydro-cooler, the produce is brought in contact with cold water by using a conveyor (flume type) (Fig. 7) or by lowering bins/boxes in a tank of water (Fig. 8) which is continuously cooled by mechanical refrigeration system. Poor cooling would result if the product simply moved with the water. Flume hydro-coolers convey the product either against (counter flow) or across (cross flow) the flow.

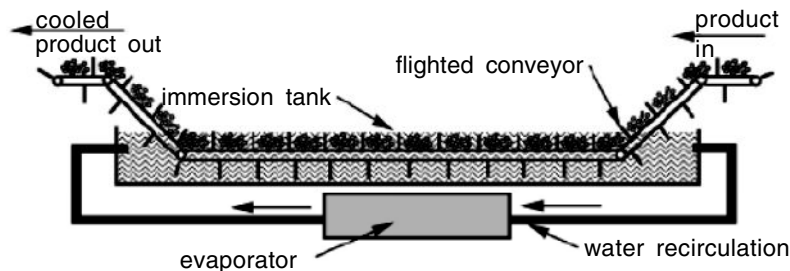
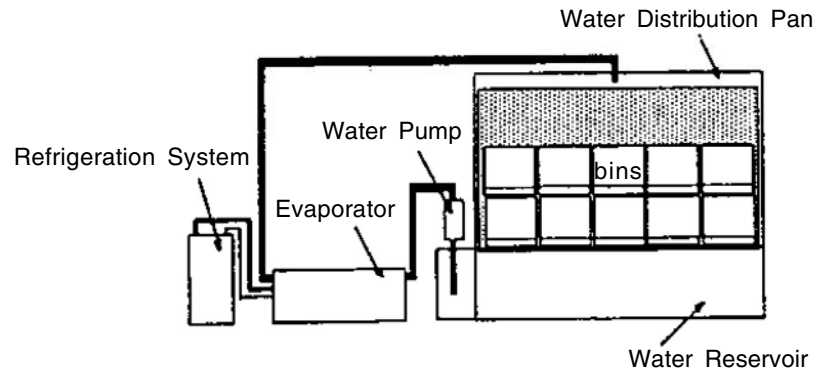


Fig. 7: Continuous flow immersion type hydro-cooler  
(Source: Thompson et al, 1998)





**Fig. 8: Immersion type (Batch type) hydro-cooler (Source: Kasmire, 1977)**

Shower-type hydro-cooler are most common, but there is some use of flume type immersion hydro-coolers. Efficient cooling depends upon adequate water flow over the product surface. Immersion type hydro-coolers usually take longer time to cool produce than shower type cooler and mostly used for bulk product of density greater than water (so it would not float). Generally the small quantity chlorine or other chemicals are added in the water to sanitize it. Typical cooling times are from few minutes to 1 hour depending upon the size of the product.

### ***Vegetable crops suitable for hydro-cooling***

Asparagus, green onion, artichoke, root crops, watermelon, muskmelon, etc.

### ***Advantages***

- Less cooling time is required as compared to room and forced-air cooling and can be used for cooling bulk bins and large size produce.
- Moisture loss does not take place.
- Hydro-cooler can be easily integrated into a packing operation and become a step within a simple packing line.
- Fast on-line cooling is possible.
- Less energy is used as compared to forced-air cooling.

**Disadvantages**

- Most of the packages don't tolerate wetting.
- Use for cooling the produce before packing.
- Wax layer of some vegetables like capsicum, tomato etc. are removed by using shower type of hydro-cooler.

**Precautions**

- Hydro-cooler should be drained and cleaned at least daily or be equipped with special filters to clean the water.
- Shower-pan holes must be cleaned daily to avoid plugging, which causes uneven water flow over the product.

**2.2.4 Vacuum cooling**

Vacuum cooling take place by water evaporation from the product at very low air pressure. In this method, air is pumped out from a larger steel chamber in which the produce is loaded for pre-cooling (Fig. 9). Removal of air results in the reduction of pressure of the atmosphere around the produce which further lowers the boiling temperature of its water. As the pressure falls, the water boils quickly removing heat from the produce. The underlining principle of vacuum cooling process is that water boils at 100°C at atmosphere pressure. With the reduction in pressure, boiling temperature reduces and at pressure of 4.6 mm of mercury water will boil at 0°C. Vacuum cooling cause about 1 per cent product weight loss (mostly water) for each 6°C of cooling. Products which release water quickly from their surface may cool as rapidly as within 20-30 minutes. Produce which have large surface area such as leafy vegetables (e.g. Chinese cabbage, lettuce, spinach) are especially suited to this method due to rapid release of water from their surface. It is not recommended for products like carrot, potatoes, tomatoes, having low area to mass ratio.

**Vegetable crops suitable for vacuum cooling**

Lettuce, green beans, mushrooms, bell pepper, celery, cabbage, spinach, Chinese cabbage etc.

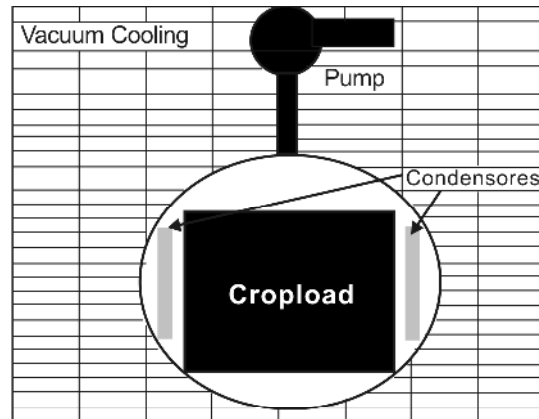


Fig. 9: Vacuum cooling of produce

### **Advantages**

- Packed produce can be pre-cooled if the pack allows moisture transfer.
- Fast and uniform cooling as compared to other methods of pre-cooling.
- Most energy efficient and economical method as compared to other methods.

### **Disadvantages**

- High capital cost
- Produce losses more moisture

### **3.5. Package-icing**

In some commodities, crushed or flaked ice is packed along with produce for faster cooling (Fig. 10). However, as the ice in contact with the produce melts, the cooling rate slows considerably. The ice keeps a high relative humidity around the product. Package ice may be finely crushed ice, flake ice or slurry of ice and water, called liquid ice. Liquid icing distributes the ice throughout the container, achieving better contact with the product. Packed icing can be used only with water tolerant, non-chilling sensitive products and with water tolerant packages (waxed fiberboard, plastic or wood). One kg of ice will roughly drop the temperature of product 3 times its weight by about 28°C.

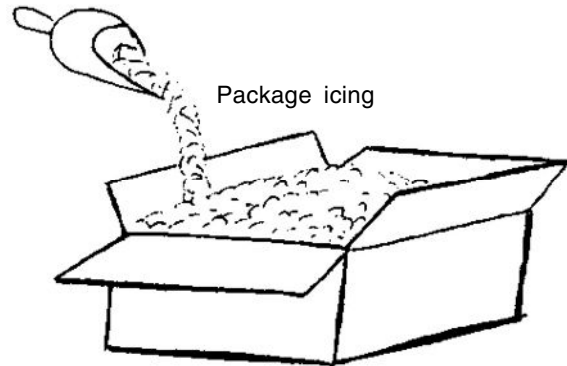


Fig. 10: Package-icing of produce in CFB box (top filling)  
(Source: Kitinoja and Kader, 1995)

### ***Vegetable crops suitable for package – icing***

Broccoli, brussels sprout, green onion, peas, carrot, radish, turnip etc.

### ***Disadvantages***

- Most expensive method (require use of more expensive water tolerant packages; more use of ice i.e. 10 kg ice for 20 kg produce).
- Used only for those commodities that can tolerate prolonged exposure to 0°C wet conditions.
- The weight of ice can add significantly to the freight load.
- During transport of mixed loads, water from melting ice can damage neighboring boxes that are not water tolerant.

## **2.3. Comparison among cooling methods**

Produce is usually cooled to its long-term storage temperature in special facilities designed to rapidly remove produce heat. Forced-air cooling is the most widely adaptable method and is commonly used for many vegetables. Hydro-cooling uses water as the cooling medium and is less widely used than forced-air cooling because some products do not tolerate water contact, and it requires the use of water-resistant packaging. It is

commonly used for root, stem and flower-type vegetables and melons. Vacuum cooling is usually reserved for crops, such as leafy vegetables, that release water vapor rapidly allowing them to be quickly cooled. Package icing utilizes crushed ice to cool and maintain product temperature and is used for a very few commodities, mainly for those whose purchasers have a strong traditional demand for this method. It is still common for broccoli. Room cooling is accomplished by placing warm produce in a refrigerated room and cooling times are at least 24 h and can be much longer if produce is not packaged correctly or no provision is made to allow airflow past boxes. Table 2 is a summary comparison of the five initial cooling methods.

**Table 2: Comparison of methods used for cooling**

| Variable                       | Cooling method |         |         |            |         |
|--------------------------------|----------------|---------|---------|------------|---------|
|                                | Ice            | Hydro   | Vacuum  | Forced-air | Room    |
| Cooling times (hr)             | 0.1-0.3        | 0.1-1.0 | 0.3-2.0 | 1.0-10.0   | 20-100  |
| Water contact with the product | yes            | yes     | no      | no         | no      |
| Product moisture loss (%)      | 0-0.5          | 0-0.5   | 2.0-4.0 | 0.1-2.0    | 0.1-2.0 |
| Capital cost                   | high           | low     | medium  | low        | low     |
| Energy efficiency              | low            | high    | high    | low        | low     |

## 2.4. Selection of Cooling Method

### 2.4.1 Product limitation

Physiological and physical characteristics of a product may limit the cooling method that are suitable for a particular crop. For example, leafy vegetables require fast cooling after harvest, so room cooling is not suitable. Vacuum cooling is a fast cooling method for some leafy commodities. Many vegetables are suited to several cooling methods. Table 3 lists the cooling methods commonly used for various types of vegetables.

**Table 3: Recommended Pre-cooling Methods for Commonly Grown Vegetables**

| Vegetable  | Pre-cooling method   |
|--|--|
| Asparagus, lettuce, Green onion, Spinach                         | Hydro-cooling, Package icing                               |
| Eggplant, Capsicum, Potato, Summer squash, Tomato, Cabbage, Okra | Room-cooling, Forced-air cooling                           |
| Cucumber, Peas, Melons   | Forced-air cooling, Hydro-cooling                          |
| Cauliflower  | Hydro-cooling, Vacuum cooling                              |
| Carrots  | Package icing, Room cooling                                |
| Broccoli   | Package icing, Vacuum cooling, Hydro-cooling               |
| Chinese Cabbage, Snap beans                                      | Hydro-cooling, Room cooling, Forced-air cooling            |
| Greens, sweet corn, Brussels sprout                              | Hydro-cooling, Package icing, Vacuum cooling               |
| Turnip   | Room cooling, Hydro-cooling, Vacuum cooling, Package icing |
| Radish   | Package icing  |
| Beets  | Room-cooling   |
| Garlic, Onion, Pumpkin, Sweet potato, Winter squash, Watermelon  | No precooling needed                                       |

### 2.4.2 Product mix

If a cooling facility will be used for several types of commodities, it may or may not be possible to use the same method for all the products. Table 3 shows that vacuum cooling, packed icing and room cooling are used for only a few products; hydro-cooling is suited for much wider variety; and forced air cooling is adaptable to most type of products and is ideal for operations where a wide variety of products must be cooled. Therefore, forced-air cooling is most often recommended for small scale operations. In some cases, the product mix may require that more than one cooling system be used.

### 2.4.3. **Product temperature requirements**

A facility that must handle products with very different optimum storage temperatures usually needs separate cooling facilities. Keeping chilling sensitive commodities below their critical threshold temperature for too long will cause damage. Table 4 lists the optimum temperatures for selected vegetables.

### 2.4.4. **Cost of operating cooler**

Capital costs can vary significantly between different types of coolers. Liquid ice coolers are the most expensive to purchase, followed by vacuum coolers, forced-air coolers and hydro-coolers. Capital cost per unit cooled can be minimized by using the equipment as much as possible. Vacuum cooling equipment is very compact and is often portable. So it is common for portable vacuum coolers to be used more than 10 months per year. Forced-air cooling facilities can be used for short term storage of product during the harvest season and for long term storage of product after the season ends.

### 2.4.5. **Energy cost**

The energy cost of cooling varies greatly among coolers. Energy use is expressed in terms of energy efficient (EC).

$$EC = \frac{\text{Cooling work done (kWh)}}{\text{Electricity purchased (kWh)}}$$

High EC numbers indicate an energy efficient operation. Actual energy costs for operating a cooler can be calculated assuming a value of EC with the formula below. Energy costs can be less than 5 percent of the total costs in efficient cooling systems.

$$\text{Electricity cost} = \frac{W \times TD \times R \times Cp}{3.6 \times EC}$$

Where, W = weight cooled (kg)

TD = temperature reduction in product (°C)

**Table 4: Optimum storage temperature for selected vegetables (Source: Thompson, 1996)**

| Group   | Temperature         | Crops   | Status of commodities  |
|---------|---------------------|---|--|
| Group 1 | 0-2°C and 90-95% RH | Mushroom, beet (toped), leek, kohlrabi, radish, turnip  | Many of this group produces ethylene.                                  |
| Group 2 | 0-2°C and 90-95%RH  | Asparagus, leafy greens, beans, broccoli, brussels sprout, peas, spinach, cabbage, celery, carrot, cauliflower, parsley, parsnip, kohlrabi, turnip, snow peas, rhubarb, radish. | Sensitive to ethylene.   |
| Group 3 | 0-2°C and 60-65% RH | Garlic, onions dry.   | Moisture will damage these crops.                                      |
| Group 4 | 4-5°C and 90-95% RH | cantaloupes   | Sensitive to ethylene and chilling injury                              |
| Group 5 | 10°C, 85-90% RH     | Beans, potatoes, cucumber, brinjal, okra, pepper, summer squash.  | Many of this group produces ethylene and sensitive to chilling injury. |
| Group 6 | 12-15°C, 85-90% RH  | Bitter gourd, pumpkin, watermelon, muskmelon, winter squash, tomato ripe, ginger, sweet potatoes, green tomatoes  |  |



R = electricity rate (Rs/kWh)

EC = energy coefficient

$C_p = 4184 \text{ J/kg-}^\circ\text{K} = 3.6 \text{ J/kWh}$

Labour and other equipment costs must be included in calculating total operating costs. Although no specific data are available for these costs, they can vary significantly. If the cooling method requires that the product be packed in a special carton, the extra cost of the carton should be included in comparison of different pre-cooler types. For example, package icing, hydro-cooling and water-spray vacuum cooling need water resistant packaging.

#### **2.4.6. Other considerations**

- Market tradition may dictate the choice of a cooling method. e.g. some markets require that broccoli cartons arrive with ice in them.
- Existing facilities may determine the type of cooler to be used. An existing cold storage room can often be used for forced-air cooling small amounts of product by installing a small portable fan. Large amount of produce usually require installation of more refrigeration capacity and a permanent air handling system.
- A short harvesting season in a particular location may rethink the operator to use portable cooling equipment. All types of coolers except room cooling operations can be made portable. They can be moved to different production areas or leased which can reduce the cost of operation.
- Some growers contract with commercial companies for cooling operations. But the grower loses some control over the produce and loses the chance to make profits from cooling operations.

## CHAPTER 7

# PACK-HOUSE OPERATIONS

---

Pack-house operations can be as simple as moving produce from a field lug into a shipping container, or may include a variety of handling practices from cleaning, waxing, sizing, and quality grading to color sorting. The provision of shade during the packing operations is extremely important. In the simplest packhouse, produce is delivered in containers immediately after harvest, directly to the packers. The packers then sort, grade, size and pack the produce directly into appropriate transport containers. In this case, each worker must have knowledge regarding produce defects, grade and size requirements and packing methods. As the size and complexity of the packhouse increases, more operations and workers in specific tasks might be added.

### 1. PACK HOUSE OPERATIONS

The typical series of pack-house operations are illustrated in fig. 1. The number and size of packing lines will depend on the kind and quantity of produce that are handled each day.

Pack house operations include:

- Dumping
- Pre-sorting
- Cleaning/Washing
- Sorting/Grading
- Bunching/Wrapping

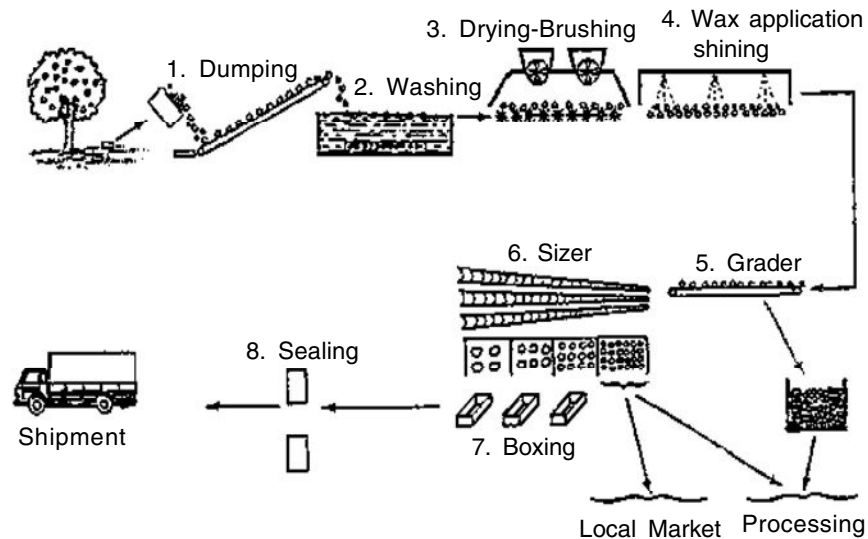


Fig. 1: Flow diagram of pack-house operations (Source: Kader, 1993)

- Post-harvest treatments – Waxing, Chemical treatments, Heat treatments, Labeling
- Packaging
- Cooling
- Storage

### 1.1. Dumping

Unless produce is field packed, it must somehow be removed from the field bin or harvesting container and packed into a shipping container. The first step of handling is known “dumping” the produce from the field container. Dumping must always be done gently either by using water assisted methods or dry dumping.

Dry dumping having padded, sloped ramps or moving conveyor belts can decrease injuries to produce. The field container should be emptied slowly and gently onto a tilted ramp with padded edges.

Wet dumping can decrease bruising and abrasions by using moving, chlorinated (100-150 ppm) water to receive produce. Produce can be

dumped into a water-filled basin or immerse the whole container to float produce out of the field bin and carry delicate produce towards the graders and packers. Wet dumping can reduce mechanical damage, since water is more gentle to produce than a hard surface of a sorting table or a conveyor belt. If the specific density of the produce, such as tomato, is lower than that of water, the produce will float naturally. For those produce which don't float naturally, salts (e.g. sodium lignin sulfonate, sodium silicate or sodium sulfate) must be added to the water to increase its specific density and make the fruits float.

### 1.2. Pre-sorting

Pre-sorting produce is usually done to eliminate injured, decayed or otherwise defective produce (culls) before cooling or additional handling. Pre-sorting will save energy and money because culls will not be handled, cooled, packed or transported. Removing decaying produce items is especially important, since this will limit the spread of infection to other units during handling.

### 1.3. Cleaning/Washing

The choice of cleaning and/or washing will depend upon the type of vegetable and the type of contamination (table 1). Certain vegetables should not be washed because washing will remove the natural waxes from the produce.

**Table 1 : Requirement of cleaning/washing for different vegetables**

| Cleaning/Washing                  | Vegetables   |
|-----------------------------------|--|
| Wash before cooling and packing   | Tomatoes, cucumbers, leafy greens                                |
| Wash after storage                | Sweet potatoes, potatoes, carrots                                |
| Dry brush after curing or storage | Onions, garlic, kiwifruit  |
| Do not wash                       | Green beans, melons, cabbage, okra, peas, peppers, summer squash |

Sanitation is essential to control the spread of disease from one item to another and to limit spore buildup in wash water or in the packhouse

air. Chlorine treatments (100 to 150 ppm) can be used in wash water to help control pathogen buildup during packing operations. There is some variation in the strength of chlorine bleach available commercially in different countries, but a rule of thumb is to use 1 to 2 mls of chlorine bleach per liter of clean water. More chlorine will be required if temperatures are high or water contains a lot of organic matter. Maintain the pH of the water between 6.5 to 7.5 for best results.

#### 1.4. Trimming/Topping

Certain vegetables should be trimmed or topped to remove inedible plant material or excess outer leaves before packing (table 2). This simple practice also helps to reduce the high rate of water loss, which occurs through the leaves of root and tuber crops.

**Table 2 : Requirement of trimming/topping for different vegetables**

| Trimming / Topping  | Vegetables  |
|---|---|
| Remove older outer leaves                                       | Cauliflower, head lettuce, swiss chard and other leafy crops      |
| Remove tops   | Radish, carrot, beet, turnip and other root vegetables            |
| Trim excess tissue (mostly for appearance or ease of packaging) | Long leaves from green onions, tough stems from asparagus spears. |

#### 1.5. Sizing/Grading

Sizing produce is usually a part of grading. Sizing produce is essential for direct marketers, but may be worthwhile if certain size grades, receive a higher price than others. Another reason to desire uniform size produce is for place-packing produce by count or for accurately filling trays. When using these packing methods, if non-uniform sizes are packed together, some produce is not immobilized within the container while other units may be squashed.

In most low-input packhouses, manual sizing is still commonly practiced. Operators should be trained in selecting the size desired and to either directly pack the items into containers or place the selected produce

gently into a bin for packing further down the line. Sizing can be done subjectively (visually) with the use of standard size gauges. Examples of the smallest and largest acceptable sizes for each product can be placed within view of the operator. For easy reference hand held sizers are used for a variety of products. Round produce units can be easily graded by using sizing rings. Rings can be fashioned from wood or purchased ready-made in a wide variety of sizes. Several types of mechanical sizers are available for small scale operations. A wide variety of sizes are designed as conveyors fitted with chain or plastic belts with various sized openings, and are useful for sizing most commodities (Explained in detail in next chapter)

### 1.6. Bunching/Wrapping

Some vegetables are easier to handle and pack if they are bunched and/or wrapped. Wrapped cauliflower in vented polythene film can reduce damage to delicate heads by protecting against abrasions during postharvest handling. Bunching green onion, palak, coriander leaves and mint leaves in small bundles helps in handling these commodities.

**Note:** Other pack-house operators like Post-harvest treatments, sorting and grading, packaging, cooling and storage of vegetables are explained in coming chapters.

## 2. PLANNING A PACK-HOUSE

To perform the packhouse operations efficiently, the required infrastructure should include a building of appropriate size to have equipment for loading/unloading, washing, sorting, grading, waxing, labeling, packing, pre-cooling, ripening rooms, cold rooms for temporary/long term storage. Each component of packhouse is discussed below:

### 2.1. Site Selection

The packhouse should be easily approachable by road and should be centrally located in the produce growing area. The shorter transportation time from farm to packhouse help in reducing postharvest losses and maintenance of freshness of produce. The environment around the packhouse should be free from all sorts of pollution like air, water and soil

pollution. There should be easy access to electricity supply for meeting the water, lighting and power requirements of the equipments.

## 2.2. Flow of Produce

The packhouse should be designed in a logical manner so as to achieve a high degree of efficiency. Some packhouses operate on single crop and the crop arrives during a fixed time of the year. Certain packhouses can handle a number of crops throughout the year. It is advisable to keep the building, machines and workers occupied for whole of the year to make the enterprise viable. Grading lines suitable for round commodities can be used for a number of fruits and vegetables with minor adjustment to suit a particular commodity.

## 2.3. Internal Layout

Internal layout is the prime factor for deciding the overall dimensions of the packhouse structure. All the machines and other utilities should be arranged in such a manner so that the space is efficiently used. A typical packhouse should provide space for the following utilities:

- For receiving the produce
- Washing, grading, sorting lines (mechanical or manual)
- Various treatments (fungicide, hot air/water etc.)
- Pre-cooling method
- Packaging
- Storage of packing material, crates, bins, pallets.
- Cold rooms for temporary storage.
- Ripening rooms (optional) in case the packhouse receives unripe produce.
- Loading the produce for transportation.
- Toilet and change rooms for workers
- Offices
- Maintenance room or workshop
- Passageways for movement of personnel and produce. (Fork lift trucks or hand carts).

## 2.4. Constructional Details

Packhouse building is like any other building having floor, roof and walls. The choice of construction materials depend upon the locally available materials, customs and regulations. The floor should be of high quality concrete having good strength to bear the load of processing machinery. A minimum  $0.5^\circ$  slope should be provided for adequate drainage of wash water. Provision should also be provided for under floor drain lines having drain points at appropriate locations to facilitate cleaning.

The modern packhouses are steel framed structures having pre-fabricated insulated wall and roof panels which use polystyrene or polyurethane foam insulation (PUF). The recommended insulation thickness for panels for various applications is given in Table 3. PUF panels are expensive but possess better structural strength and insulation properties. Such walls and roof are essentially required for packhouses which are maintained at temperatures lower or higher than the environment. Though such panels are expensive but provide better hygiene surfaces and insulation compared with brick or concrete surfaces. All large packhouses should be built by steel structure frames having precast/prefabricated panels. Such structures also provide large spans which facilitate wider passages and suit the installation of machinery. Another advantage is the convenience in extension while adding capacities. For small scale operations, ordinary structures providing shelter from sun, rain and having wire mesh against insects and flies should be adequate. Facilities for adequate lighting and ventilation however should be provided. The packhouse should be well lit with sufficient number of tube lights especially around manual sorting lines.

The most modern packhouses having air conditioned environment require special decks for the loading or unloading of vehicles. For the movement of forklift trucks between air conditioned and unconditioned sections usually hanging polyethylene curtain doors are provided so as to minimize infiltration. For small scale packhouses, self closing wire mesh doors should be provided. Packhouse should have shaded shelter for loading/unloading of vehicles to protect the produce against sun and rain. Besides above mentioned considerations, the designer should keep scope for future expansions at least for next 10 years.



**Table 3 : Wall Insulation thickness for cold rooms**

| Storage temperature(°C) | Thickness of Insulation (cm) |          |
|-------------------------|------------------------------|----------|
|                         | Styrofoam                    | Urethane |
| -18 to -4               | 10                           | 10       |
| 0 to 5                  | 10                           | 7.5      |
| 6 and up                | 5                            | 5        |

## 2.5. Equipment and Machinery

The pack-house is normally equipped with machines and equipment to accomplish all the unit operations starting from unloading of produce, cleaning, washing, sorting, grading, waxing (or any other treatment), labeling, pre-cooling, packaging, storage and loading for transportation. The state-of-the-art packhouses are equipped with automatic washing, cleaning, sorting and grading lines which are equipped with electronic sensors and operate through computer software's. The supporting equipment with these grading lines include- large bin tippers, pallets, fork-lift trucks, controlled atmosphere (CA) stores and cold rooms. The capital investment for such machinery is too high and is only recommended for export quality produce. Most of the packhouses in the developed countries involved in the international trade are built from prefabricated PUF panels and are equipped with such equipment. The approximate cost for this type of packhouse of 30-40 tones per day capacity is approximately Rs 2-3 crores excluding the cost of land.

For local trading at a small level where a simple shelter from sun & rain and having wire mesh guards against insects is available, simple manual equipment should be provided. For instance hand carts in place of fork-lift truck, sorting tables, tubs/tanks for washing, hand brushes for dry cleaning, simple hand held or tilt table type sizers etc. All this equipment can be locally fabricated at reasonable cost. The choice of materials will also depend upon the local factors. The packaging material, especially the corrugated fibre boxes (CFB), tissue papers, paper shredding as fillers and card board dividers have to be arranged locally as per requirements. Many small cardboard manufacturing units are available in all parts of the country which can meet the requirements. For local distribution, stackable plastic crates should be preferred.

For the small scale packhouses having electric supply, it is advisable to provide a desert cooler, especially during hot and dry weather so as to minimize moisture loss from the produce. It is cheap option where air conditioning is unaffordable. In the absence of electric supply, the use of zero energy evaporative cooled stores can help in maintenance of freshness of perishables for a shorter duration. It is a low cost option for temporary storage of produce and is recommended for beginners. The approximate cost for such a small level packhouse of 5-10 tonnes/day capacity is approximately Rs 3-5 lakhs excluding the cost of land.

From the above discussed issues it is concluded that the choice of building structure and machinery for a packhouse depends upon many factors. Some of the points are summarized below for the assistance of growers/marketers who intend to set up packhouses.

- The machines for the various operations of the packhouse should be chosen in such a manner so as to keep the packhouse in operation for a large number of days per year. This will increase the viability of its operation.
- For small scale level, always start with simple, low cost structure and equipment. More sophisticated equipments can be added once the packhouse starts earning profits.
- At the planning stage, keep scope for future expansion.
- Always consider grading and sorting immediately after washing because it reduces the size of machinery proportionately for further unit operations as sorted/culled produce is not further taken for packaging.
- Normally wider and shorter lines grading/sorting have lower initial cost. This is because longer packaging lines add to the cost of building, cost of machine itself and the electrical costs. So, it is advisable to select wider and shorter grading lines. Wider line with slower speed can give the same capacity as narrow line with faster speed.
- The inventory requirements should be estimated in advance since these effect the space requirements, thus affecting the size of structure.

- Before setting up a modern packhouse, visit few operational packhouses and inquire about the reliability of the machinery and equipments and about the after sale services provided by the suppliers.
- Seek expert opinions before the finalization of the project proposals.

#### **4. PACK-HOUSE MANAGEMENT**

The effective management of pack-house requires a high level of efficiency in coordinating the technical, organizational and commercial aspects of operations. Errors and delays in any part of the operations will lower the returns. Operations should continue throughout the year if it is economic to do so.

##### **4.1. Meeting Market Requirements**

Management should be able to advise and instruct both growers and packing-house staff in order to achieve the most efficient operations and high-quality output for the best possible returns.

##### **4.2. Procurement and Control**

A reliable knowledge of the quantity and arrival times of produce to the pack-house is essential for its efficient operation. Growers sending produce to a central pack-house should be aware of the control of quality and the standards observed. The quality of packed produce must also be controlled in order to reduce the possibility of disputes during marketing.

##### **4.3. Supplies of Packing Materials**

Estimates of the coming year's needs must be made in advance. Early arrangements should be made with suppliers to obtain the most advantageous prices and delivery dates. Accurate stock control must be observed so that supplies do not run out during packing operations.

##### **4.4. Disposal of Low-grade Produce**

The selection and grading of produce for market will always result in some substandard pieces. They may have a certain value but should be

disposed of to the best advantage of the pack-house. The management must also know how much produce is a total loss. The disposal of both the low-grade produce and the total-loss produce must be accounted for.

#### **4.5. Staffing**

The staffing of the pack-house must be adequate for its efficient operation but with attention to labour costs. This means the efficient deployment of labour and the need for adequate supervision. Permanent staff may include a manager, clerks, mechanics and maintenance workers, drivers and some skilled packers. Peak periods will require temporary workers.

#### **4.6. Staff Training**

The manager of pack-house should be technically qualified and able to train his foremen. He must also ensure that in-service training is provided for the packing workers.

#### **4.7. Grower Training**

When a pack-house is supplied by several growers, management should train the growers so that they can achieve the quality standards set by the market. Cooperation with post-harvest extension workers is desirable. This may include formal training out of season but will be most effective if farm visits are made when harvesting and pack-house activities are in progress.

#### **4.8. Accounting and Costing of Operations**

The payment to the growers should be made in time, taking into account the quality control requirements. The cost of running the pack-house must be estimated per kg of produce throughput to enable costs to be minimized and growers' returns maximized.

#### **4.9. Documentation and Accounting**

The manager is responsible for seeing that accurate records are maintained and proper accounts prepared. This is fundamental to the success of the pack-house as a business.

## CHAPTER 8

# SORTING AND GRADING

---

**S**orting and grading are two important steps affecting quality and storage life of vegetables. These operations are performed to remove foreign and undesirable material from the fresh produce and to separate the produce into various grades. The comparative commercial value of vegetable crop is dependent on their grade factor. These grade factors further depend on:

- Physical characteristics like size, shape, moisture content, colour etc.
- Chemical factors like odour
- Biological factors like percent germination, insect damage.

A mixture of any product may be separated on the basis of difference in length, width/thickness, specific gravity, surface texture, terminal velocity, colour, shape and magnetic properties etc.

**Sorting** generally refer to the removal of foreign/undesirable matters from the desired products. This may be accomplished by washing, screening, hand picking etc.

**Grading** refers to classification of cleaned product into various quality fractions depending upon various commercial values and other uses.

### 1. SORTING OF VEGETABLES

The simple sorting operation comprises a raw material which contains only two different fractions. They are usable and non usable commodity, normal and undersized fruit or good and poor fruit. The differences in physical properties of the good fruit and culls are used as means to distinguish between them in the segregating process. This process covers two separate operations:

- Removal of non-standard, damaged, blemished or discoloured vegetable and any foreign bodies remaining after washing.
- Quality grading or sorting based on variety, organoleptic criteria and maturity stage.

There are two systems of sorting i.e. static and dynamic. Static systems are common in tender and/or high value crops. Here the product is placed on an inspection table where sorters remove units which do not meet the requirements for the grade or quality category (Fig. 1). The dynamic system is probably much more common. Here product moves along with belt in front of the sorters who removes defective units (Fig. 2). Main flow is the highest quality grade. Often second and third grade quality units are removed and placed onto other belts. It is much more efficient in terms of volume sorted per unit of time. However, personnel should be well trained. This is because every unit remains only a few seconds in the worker's area of vision. There are two types of common mistakes: removing good quality units from the main flow and more frequently, not removing produce of doubtful quality.



**Fig 1: Static quality sorting system**    **Fig 2: Dynamic quality sorting system**

Colour sorting is common in fruit vegetables and can be undertaken electronically. Fruits are usually harvested within a range of maturity that needs to be uniform for sale. Harvesting within a narrow range of maturity reduces colour sorting. However, this is only possible for low-volume operations.

## 2. GRADING OF VEGETABLES

There are two basic systems of grading i.e. according to weight or dimensions (diameter, length or both). Spherical or almost spherical products

like tomato, onions and others are probably the easiest to grade by size. Several mechanisms are available from mesh screens to diverging belts or rollers with increased spaces between them. Grading can also be performed manually using rings of known diameter (fig. 3). Electronic eye are sometimes used to sort out the produce by colour.



**Fig. 3: Sizing with rings of known diameters**

### **Advantages of Sorting and Grading**

- It provides common language to producer, trader and consumer.
- It improves marketing efficiency by selling a produce without personal selection.
- It reduces the chances of dispute between seller, retailer, wholesaler and brings more transparency in the trade.
- Standardized grades helps in fixation of produce rates, which helps in securing incentive price for better quality.
- It serves as a realistic basis for market intelligence and reporting.

### **Additional Benefits**

- Grading the produce into certain size and shape facilitates packing and transportation easy.
- Eliminates re-sorting and re-packing at wholesale or transit markets.
- Can develop specific market for a specific type of produce.

### 3. TYPES OF GRADERS

#### 3.1. Screen Graders

It is chain-link type belt driven over a pair of rolls so that the crop is conveyed along with the belt. A superimposed vibration on the belt ensures that any item smaller than the hole size of belt will drop through the chute or cross-wise conveyor below. The machine would typically have two or three belts with the smaller one coming first to allow the smaller sizes to be removed first. Typical size range is 20 to 100 mm. The belt may be rubber covered to minimize damage. The shape of the hole in the belt is usually square, but hexagonal is also available (Fig. 4). The machine may be used for potatoes.

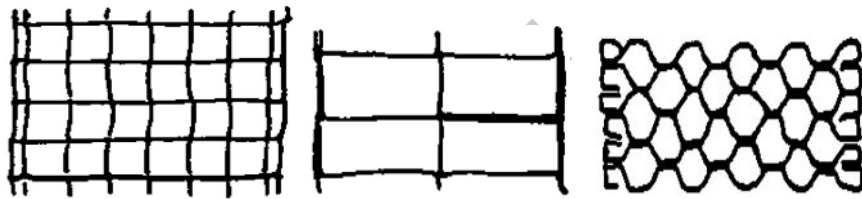


Fig. 4: Shapes of the holes in the screen belt graders i.e. Screen Square (Left), Rectangular (centre) and Hexagonal (right)

#### 3.2. Mechanical Weight Grader

These graders sort the material on the basis of unit weight (Fig. 5). The material is placed into the individual cups by an automatic indexing feed. As the cups travel through the grader they are indexed with spring load trips. The spring tension continuously becomes weaker from beginning to end movement. The heavier products overcome the spring reaction and are discharged at the beginning of travel. The lighter material move to a greater distance. These are used for large sized products like apples, oranges and especially for eggs. These are accurate and moderate to fast and minimum damage to product. The fineness of separation depends upon the calibration accuracy.

#### 3.3. Diverging Roller Grader

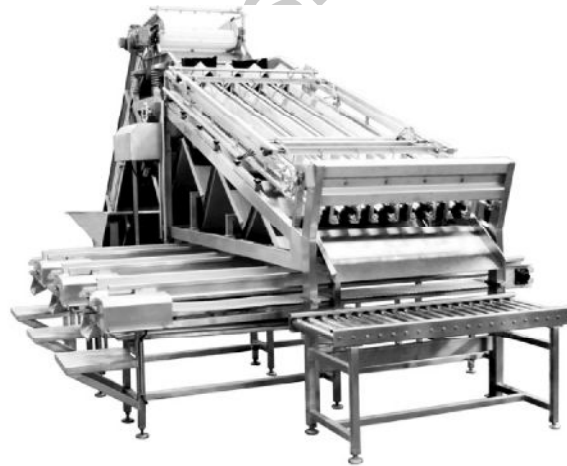
There is a wide range of equipment which employs the same basic principle of diverging elements. Here the fruits are fed into rollers which are having



expanding opening and rotating in opposite direction (Fig. 6). The fruits move in the divergent opening due to rotation of the rollers. Fruits pass through the opening when the size of opening is equal to size of the fruit. This type of grader is most suited for round shape produce like onion and conical shape vegetables like carrots.



**Fig. 5: Mechanical weight Grader (left), individual cups used to carry the fruit (right)**



**Fig 6: Diverging roller grader**

### 3.4. Expanding Belt Grader

The un-graded produce is fed from the end having smaller opening. Fruits get singled and get held in the space between the belts and move along the direction of motion (Fig. 7). Small size fruits get graded by passing

through the small opening near the feeding end. The medium size fruits get graded by passing through the medium opening. The big sized fruits get graded by passing through the largest opening near the far end of belt. The graded fruits can be collected at the respective outlets. The grades can be adjusted as per the number of openings. This grader is suitable for round fruits and can be adjusted for different sizes by adjusting the openings between belts.



**Fig 7: Expanding belt grader**

### **3.5. Expanding Opening Roller Grader**

This is based on expanding element theme, whereby the crop is carried along on a series of rollers which get wider and wider as they move along the length of the table. The smaller ones drop through first and the larger ones further down. The advantage of this machine is increased capacity as compared to the single-row machines. Variable speed is usually an option and four or five grades are possible. The limitation of this type of machine is its inability to discriminate longer from shorter crops. This type of grader is extensively used commercially for grading potato, onion, tomato etc.

### **3.6. Roller Sorter**

There are number of rolls in the roller belt. Each roll rotates about its own axis. So each piece of the product gets an opportunity to orientate

itself to its minimum dimension and get separated. The roller sorter is divided into three roll units so that gap between roller increases through the sorter. Sometime a number of belts may be used to get different grades of products. These are fast, accurate and cause little damage.

### **3.7. Computerized Grades for Size, Weight, Colour, TSS, Firmness and Internal Defects**

The vegetables and fruits are graded as per size, weight, colour, TSS, internal quality, firmness or combination of these. The Fruits move on the chain with cups as explained in mechanical weight grader. These get discharged into the different outlets for different grades as per data fed to the computer. The different grades get collected into different outlet. These are then filled manually in corrugated fibre board (CFB) boxes. The computer can also give signal at the required outlet.

## **4. GRADE DESIGNATION AND QUALITY OF VEGETABLES**

The Directorate of Marketing and Inspection (DMI) of Ministry of Rural Development, Government of India, is the pioneer organization in the country in formulation of grade standards (Agmark standards) for agricultural and allied commodities under the provisions of the agricultural produce grading and marketing act 1937. Under this act the first commodity for which grading and marketing rules were framed was grapes. Subsequently, DMI framed grade standards for number of vegetables and fruits, both for export purpose as well as for domestic marketing. Grading under this rule is voluntary. Thus produce graded under “AGMARK” have to follow the statutory procedures and obtain license known as “Certificate of Authorization”. Under grade specifications, DMI prescribed parameters for specific and general quality characteristics for different vegetables and fruits, with the special characteristics prescribe certain variables like minimum length, weight, diameter etc. of the fruits which are measurable. The DMI standards for quality and grading of some vegetables are listed below:

#### 4.1. Grade Designation and Quality of Shelling Peas

1. Shelling peas shall be obtained from varieties (cultivars) of *Pisum sativum* L.
2. Minimum requirements
  - (i) The pods shall be:
    - (a) intact and sound;
    - (b) clean, free of any visible foreign matter including parts of the flowers;
    - (c) fresh in appearance;
    - (d) free from pests and damage caused by pests;
    - (e) free from abnormal external moisture;
    - (f) free from foreign smell and/or taste;
  - (ii) The seeds shall be:
    - (a) fresh;
    - (b) sound;
    - (c) normally developed;
    - (d) free from pests and damage caused by pests;
    - (e) free from foreign smell and/or taste;
  - (iii) Pods and seeds shall not be affected by rotting or deterioration such as to make it unfit for consumption.
  - (iv) They shall comply with the residue levels of heavy metals, pesticides and other food safety parameters as laid down by the Codex Alimentarius Commission for exports.

#### 3. Criteria for grade designation

| Grade designation | Grade Requirements   | Grade tolerances   |
|-------------------|--|--|
| Extra class       | Shelling peas shall be of good quality. They must be characteristic of variety and/or commercial type.<br>The pods shall be: | 5% by weight of peas not satisfying the requirements, but Class I grade. |

[Table Contd.]

Contd. Table]

| Grade designation | Grade Requirements  | Grade tolerances  |
|-------------------|---|---|
| Class I           | <ul style="list-style-type: none"> <li>● fresh and turgid;</li> <li>● free from damage caused by hail;</li> <li>● free from damage caused by heating;</li> <li>● with peduncles attached; if removed it should be neatly cut;</li> <li>● well filled containing at least five seeds.</li> </ul> <p>The seeds shall be:</p> <ul style="list-style-type: none"> <li>● well formed;</li> <li>● tender;</li> <li>● succulent and sufficiently firm, they should become flat without disintegrating when squeezed between to fingers;</li> <li>● at least half of the full grown size but not full grown;</li> <li>● non;-farinaceous;</li> <li>● undamaged without cracks in the skin of the seeds.</li> </ul> <p>Shelling peas shall be of good quality. They must be characteristic of the variety and/or commercial type. The pods shall be:</p> <ul style="list-style-type: none"> <li>● fresh and turgid;</li> <li>● free from damage caused by hail;</li> <li>● free from damage caused by heating;</li> <li>● with peduncles attached, if removed it should be neatly cut;</li> <li>● well filled containing at least five seeds.</li> </ul> <p>The seeds shall be:</p> <ul style="list-style-type: none"> <li>● well formed;</li> <li>● tender;</li> <li>● succulent and sufficiently firm, they should become flat without disintegrating when squeezed between to fingers;</li> </ul> | <p>10% by weight of peas not satisfying the requirements, but meeting those of class I grade.</p> |

[Table Contd.

Contd. Table]

| Grade designation | Grade Requirements   | Grade tolerances   |
|-------------------|--|--|
| Class II          | <ul style="list-style-type: none"> <li>● at least half of the full grown size but not full grown;</li> <li>● undamaged without cracks in the skin of the seeds.</li> </ul> <p>The pods:</p> <ul style="list-style-type: none"> <li>● shall be fresh and turgid;</li> <li>● with peduncle attached; if removed it should be neatly cut;</li> <li>● shall contain atleast three seeds;</li> <li>● may be riper than those in Extra class grade, over mature pods are to be excluded, the pods may have following defects; provided they retain their essential characteristics as regards the quality, the keeping quality and presentation;</li> <li>● slight skin defects, injuries &amp; bruises provided they are not progressive and there is no risk of the seeds being affected;</li> <li>● slight defects in shape;</li> <li>● slight defects in colouring;</li> <li>● some loss of freshness.</li> </ul> <p>Seeds may have:</p> <ul style="list-style-type: none"> <li>● slight defects in shape;</li> <li>● slight defects in colouring;</li> <li>● slightly harder;</li> <li>● slightly damaged.</li> </ul> | 10% by weight of peas not satisfying the requirements of the grade but meeting the minimum requirements. |

#### 4. Other requirements

- (i) The peas shall be sufficiently developed and conditions shall be such as to enable them to withstand transport of handling and to arrive in satisfactory condition at the place of destination.
- (ii) Seeds if graded and packed separately, shall be marked “Pea seeds”.

5. **Provision concerning size:** No requirement for any grade

**4.2. Grade Designation and Quality of Snow Peas and Sugar Snap Peas**

1. The Mangetout (Snow peas) and sugar snap peas shall be obtained from varieties (cultivars) of *Pisum sativum* L.

**2. Minimum requirements**

- (i) The pods shall be:
  - (a) intact and sound;
  - (b) clean, free of any visible foreign matter including parts of the flower;
  - (c) free from hard filaments or films;
  - (d) free from abnormal external moisture;
  - (e) free from pest and damage caused by pests;
  - (f) free of any foreign smell and/or taste;
- (ii) The pods shall not be affected by rotting or deterioration such as to make it unfit for consumption.
- (iii) Mangetout (snow peas) and sugar snap peas shall comply with the residue levels of heavy metals, pesticides and other food safety parameters as laid down by the Codex Alimentarius Commission for exports.

**3. Criteria for grade designation**

| Grade designation | Grade Requirements  | Grade tolerances   |
|-------------------|---|--|
| Extra class       | The peas shall be of good quality. They must be characteristic of variety and/or commercial type. The seeds if present shall be small and undeveloped.<br>The pods shall be: <ul style="list-style-type: none"> <li>● characteristics of the variety in shape, size and colouring;</li> </ul> | 5% by weight of peas not satisfying the requirements of the grade, but meeting those of Class I grade. |

[Table Contd.]

Contd. Table]

| Grade designation | Grade Requirements   | Grade tolerances   |
|-------------------|--|--|
| Class I           | <ul style="list-style-type: none"> <li>● free and turgid;</li> <li>● with peduncles attached; if removed it should be neatly cut;</li> <li>● free from damage by hail;</li> <li>● free from damage caused by heating;</li> </ul> <p>The peas shall be of good quality. They must be characteristic of the variety and/ or commercial type. The seeds if present shall be small and undeveloped.</p> <p>The pods shall be:</p> <ul style="list-style-type: none"> <li>● characteristics of the variety in shape, size and colouring;</li> <li>● fresh and turgid;</li> <li>● with peduncles attached, if removed it should be neatly cut;</li> <li>● free from damage caused by hail;</li> <li>● free from damage caused by heating;</li> </ul> | 10% by weight of peas not satisfying the requirements, but meeting those of class II grade.              |
| Class II          | <p>This grade includes peas; which do not qualify for inclusion in Class I grade but satisfy the minimum requirements.</p> <p>The seeds, if present, can be slightly more developed than Extra class.</p> <ul style="list-style-type: none"> <li>● The following defects of the pods may be allowed provided the peas retain their essential characteristics as regards the quality, the keeping quality and presentation:</li> <li>● slight skin defects, injuries bruises;</li> <li>● slight defects in shape; including those due to the seed formation;</li> <li>● slight defects in colouring;</li> <li>● some loss of freshness excluding wilted and uncoloured pods.</li> </ul>   | 10% by weight of peas not satisfying the requirements of the grade but meeting the minimum requirements. |



**4. Other requirements**

- (i) The pods shall be sufficiently developed and condition shall be such as to enable them to withstand transport and handling and to arrive in satisfactory condition at the place of destination.
- (ii) Package shall be marked “trimmed”, ‘topped’ or other indications for peas that have their peduncle and/or blossom end removed, where appropriate.

**5. Provision concerning size:** No requirement for any grade**4.3. Grade Designation and Quality of Ribbed Celery**

1. Ribbed celery shall be obtained from Varieties (cultivars) *Apium graveolens* L. var. dulce
2. Minimum requirement
  - (i) Ribbed celery shall be:
    - fresh in appearance;
    - clean and free of any visible foreign matter;
    - free from damage caused by frost;
    - free from cavities, suckers and flower stems;
    - free from pests and damage caused by pests;
    - free of excessive external moisture, properly dried if washed;
    - free of any foreign smell and/or taste;
  - (ii) Whole, upper part of it may be trimmed.
  - (iii) It shall not be rotten or deteriorated so as to make it unfit for consumption;
  - (iv) It shall be normally developed, having regard to the production period.
  - (v) Main root should not exceed 5 cm in length and should be well cleaned.
  - (vi) Ribbed Celery shall comply with the residue levels of heavy metals, pesticides and other food safety parameters as laid down by the Codex Alimentarius Commission for exports.

**3. Criteria for grade designation:**

| <b>Grade designation</b> | <b>Grade Requirements</b>   | <b>Grade tolerances</b>   |
|--------------------------|---|---|
| Extra class              | Ribbed celery shall be of quality, in shape and free of traces of disease on leaves and leaf stalks. The leaf stalk shall not be broken, stringy, crushed or split. In the case of balanced ribbed celery, the leaf stalk shall be white to yellowish white or greenish white in colour for atleast half of their length.             | 5% by number of ribbed celery not satisfying the requirements of the grade, but meeting the requirements for Class I grade.   |
| Class I                  | Ribbed celery must be of good quality, regular in shape and free of traces of disease on leaves and leaf stalks. The leaf stalk shall not be broken, stringy, crushed or split. In the case of blanched ribbed celery, the leaf stalk shall be white to yellowish white or greenish white in colour for atleast half of their length. | 10% by number of ribbed celery not satisfying the requirements of the grade, but meeting the requirements for Class II grade. |
| Class II                 | Ribbed celery in this grade may have slight traces of rust, deformation or slight bruises and have not more than two leaf stalk that are broken, crushed or split. In the case of blanched ribbed celery, the leaf stalk shall be white to yellowish white or greenish white in colour for atleast one third of their length.         | 10% by number of ribbed celery not satisfying the requirements of the grade but meeting the minimum requirements.             |

**4. Other requirements:**

- (i) It's condition shall be such as to allow it to withstand transport and handling and to arrive in satisfactory condition at the place of destination.
- (ii) The ribbed celery may be presented either bundled in the package or stacked in the package. When presented in bundles, all bundles in the same package shall have the same number of pieces.
- (iii) The content of each package shall be uniform and comprise only ribbed celery of the same origin, quality, colour and size.

- 5. Provisions concerning sizing:** Size is determined in relation to net weight. The minimum weight of ribbed celery shall be 150 gms.

| Size Code | Weight (gm)  | Difference in size in the same package (max.) |
|-----------|--------------|---|
| A         | 150 – 500    | 100   |
| B         | 501 – 800    | 150   |
| C         | over 800 gms | 200   |

Size Tolerance- for all grades, 10% by number of ribbed celery not conforming to size requirements.

#### 4.4. Grade Designation and Quality of Spinach

1. Spinach shall be obtained from Varieties (cultivars) of *Spinacia oleracea* L.
2. **Minimum requirements**
  - (i) Spinach shall be:
    - fresh in appearance,
    - clean, free of visible foreign matter;
    - free from pests and damage caused by pests;
    - free of floral stems;
    - free of any foreign smell and/or taste;
    - properly drained if washed;
  - (ii) It shall not be affected by rotting or deterioration such as to make it unfit for consumption.
  - (iii) In the case of spinach heads, the portion comprising of the root shall be cut close to the base of the outer leaves.
  - (iv) Spinach shall comply with the residue levels of heavy metals, pesticides and other food safety parameters as laid down by the Codex Alimentarius Commission for exports.

### 3. Criteria for grade designation

| Grade designation | Grade Requirements  | Grade tolerances  |
|-------------------|---|---|
| Extra class       | Spinach shall be of good quality. It may be in leaf or in heads. The leaves shall be <ul style="list-style-type: none"> <li>● normal in colour and appearance for the variety and time of harvest;</li> <li>● free from damage by frost, animal parasites or diseases impairing appearance or edibility.</li> <li>● In the case of leaf spinach, the leaf stem must not exceed 10 cm. in length.</li> </ul> | 5% by weight of Spinach not satisfying the requirements for the grade, but meeting the requirements for Class I grade.  |
| Class I           | Spinach shall be of good quality. The leaves shall be <ul style="list-style-type: none"> <li>● normal in colour and appearance for the variety and time of harvest;</li> <li>● Free from damage caused by frost, animal parasites or diseases impairing appearance or edibility.</li> <li>● In the case of leaf spinach, the leaf stem must not exceed 10 cm. in length.</li> </ul>                         | 10% by weight of spinach not satisfying the requirements for the grade, but meeting the requirements for Class II grade.  |
| Class II          | Leaf spinach may have slight defects in colour and slight defects caused by frost. However, it shall satisfy the minimum requirements.  | 10% by weight of spinach not satisfying the requirements of the grade but meeting the minimum requirements. In the case of spinach heads, a tolerance of 10 % by weight of heads, having roots attached which do not exceed 1cm in length from the base of the outer leaves may be allowed. |

#### 4. Other requirements

- (i) The Spinach shall be sufficiently developed and in such condition as to enable it to withstand transport and handling and to arrive in satisfactory condition at the place of destination.
- (ii) Leaf spinach and spinach heads shall not be mixed in the same package.
- (iii) Each package shall be marked 'leaf spinach' or 'spinach heads' as the case may be.

5. **Provision concerning size:** No requirement for any grade

#### 4.5. Grade Designation and Quality of Headed Cabbages

1. Headed Cabbages shall be obtained from varieties (cultivars) of *Brassica oleracea* L. var. capitata L. (including red cabbages and pointed cabbages) and from *Brassica oleracea* L. var. bullata DC and var. sabauda L (savoy cabbages);
2. **Minimum requirements:**
  - (i) Headed Cabbages shall be
    - (a) fresh in appearance, sound and intact;
    - (b) free of bursts and showing no signs of flower development;
    - (c) free of bruises and injury;
    - (d) free of damage due to frost;
    - (e) free from pests and damage caused by pests;
    - (f) free of abnormal external moisture;
    - (g) free of any foreign smell and/or taste;
  - (ii) It shall not be rotten or deteriorated so as to make it unfit for consumption.
  - (iii) The stem should be cut slightly below the lowest point of leaf growth. Cut should be clean and leaves should remain firmly attached.
  - (iv) Headed Cabbage shall comply with the residue levels of heavy metals, pesticides and other food safety parameters as laid down by the Codex Alimentarius Commission for exports.

### 3. Criteria for grade designation

| Grade designation | Grade Requirements  | Grade tolerances   |
|-------------------|---|--|
| Extra class       | <p>Headed Cabbage shall be of good quality and possess all the characteristics typical of the variety, they should be compact, having regard to the species. Headed Cabbages, according to the variety, must have firmly attached leaves. They should be uniform in shape and colour. Store headed cabbages may have some of their outer leaves removed. Green Savoy headed cabbages and early headed cabbages, taking into account their variety, must be properly trimmed, but in doing so a number of leaves may be left for protection.</p> <p>They may have following slight defects:</p> <ul style="list-style-type: none"> <li>● small cracks in the outer leaves,</li> <li>● slight bruising and light trimming of the outer leaves, provided that it does not affect the good condition of the produce.</li> </ul> | 5% by number or weight of headed cabbages not satisfying the requirements for the grade, but meeting the requirements for Class I grade. |
| Class I           | <p>Headed Cabbage shall be of good quality and possess all the characteristics typical of the variety. They should be compact, having regard to the species. Headed Cabbages, according to the variety, must have firmly attached leaves. They should be uniform in shape and colour. Store headed cabbages may have some of their outer leaves removed. Green Savoy headed cabbages and early headed cabbages, taking into account their variety, must be properly trimmed, but in doing so a number of leaves may be left for protection. They may have following slight defects:</p> <ul style="list-style-type: none"> <li>● small cracks in the outer leaves,</li> <li>● slight bruising and light trimming of the outer leaves, provided that it</li> </ul>   | 10% by number or weight of headed cabbages not satisfying the requirements of the grade but meeting the minimum requirements.            |

[Table Contd.]

Contd. Table]

| Grade designation | Grade Requirements  | Grade tolerances  |
|-------------------|---|---|
|                   | does not affect the good condition of the produce.  |   |
| Class II          | <p>Headed Cabbage which does not qualify for inclusion in the Class I grade, but meet the minimum requirements. They may have following defects.</p> <ul style="list-style-type: none"> <li>● Cracks in the outer leaves,</li> <li>● More of the outer leaves may be removed,</li> <li>● Larger bruises and the outer leaves may be more extensively trimmed,</li> <li>● Less compact.</li> </ul> | <p>10% by number or weight of headed cabbages not satisfying the requirements for the grade, but meeting the requirements for Class II grade.</p> |

4. **Other requirements:** Headed Cabbage must be such as to enable them to withstand transport and handling and to arrive in satisfactory condition at the place of destination.
5. **Provisions concerning sizing:** Size is determined in relation to net weight. The minimum weight of headed cabbage shall not be less than 200 gms.

| Size Code | Weight (gm)    |
|-----------|----------------|
| A         | 201 - 600      |
| B         | 601 - 1200     |
| C         | 1201 and above |

Sizing is compulsory for headed cabbages presented in packages. In that case, the weight of the heaviest head in any one package shall not be more than double the weight of the lightest head.

Size Tolerance - For all classes 10% by number or weight of Headed Cabbages.

#### 4.6. GRADE DESIGNATION AND QUALITY OF BRUSSELS SPROUTS

1. Brussel Sprouts shall be auxiliary buds growing along the vertical stem of varieties (cultivars) of *Brassica oleracea* L. var. *gemmifera* DC.
2. **Minimum requirements:**
  - (i) Brussels Sprouts shall be
    - (a) intact;
    - (b) sound, fresh in appearance;
    - (c) clean, free of any visible foreign matter;
    - (d) not frozen;
    - (e) free from damage caused by pests;
    - (f) free of insects and/or other parasites;
    - (g) free of abnormal external moisture;
    - (h) free of any foreign smell and/or taste;
  - (ii) The stalk of trimmed Brussels Sprouts must be cut just beneath the outer leaves, the stalk of untrimmed Brussels sprouts must be fractured at the base; the cut or fracture must be clean, without other parts of the Plant adhering.
  - (iii) Brussels Sprouts shall comply with the residue levels of heavy metals, pesticides and other food safety parameters as laid down by the Codex Alimentarius Commission for exports.

#### 3. Criteria for grade designation

| Grade designation | Grade Requirements   | Grade tolerances  |
|-------------------|--|---|
| Extra class       | Brussels sprouts shall be of superior quality.<br>They must be: <ul style="list-style-type: none"> <li>● firm</li> <li>● closed</li> <li>● free of damage by frost.</li> </ul> Trimmed Brussels sprouts must be well coming within the | 5% by weight of brussels sprouts not satisfying the requirements of the grade, but meeting the requirements for Class I or exceptionally, |

[Table Contd.]



Contd. Table]

| Grade designation | Grade Requirements  | Grade tolerances  |
|-------------------|---|---|
| Class I           | <p>coloured. For untrimmed brussels sprouts, tolerances for that slightly discoloured basal leaves are allowed. Slight damage to the outer leaves, caused by picking, grading or packing is also allowed, provided that it does not affect the good condition of the produce.</p> <p>Brussels sprouts shall be of superior quality. They must be:</p> <ul style="list-style-type: none"> <li>● firm</li> <li>● closed</li> <li>● free of damage by frost.</li> </ul> <p>Trimmed Brussels sprouts must be well coloured. For untrimmed brussels sprouts, tolerances slightly discoloured basal leaves are allowed. Slight damage to the outer leaves, caused by picking, grading or packing is also allowed, provided that it does not affect the good condition of the produce.</p> | <p>grade.</p> <p>10% by weight of brussels sprouts not satisfying the requirements of the grade, but meeting the requirements for Class II or exceptionally, coming within the tolerances for that grade.</p> |
| Class II          | <p>This grade includes Brussels sprouts which do not qualify for inclusion in class I. Brussel sprouts shall be of good quality. Brussel sprouts in this class may be:</p> <ul style="list-style-type: none"> <li>● less firm</li> <li>● less closed but not open</li> <li>● may show slight damage due to frost.</li> </ul>  | <p>10% by weight of brussels sprouts not satisfying the requirements of the grade but meeting the minimum requirements.</p>   |

**4. Other requirements:** The conditions of the Brussels sprouts must be such as to allow them to withstand transport and handling and to arrive in satisfactory condition at the place of the destination.

**5. Provision concerning sizing:** Sizing is determined by the maximum diameter of the equatorial section. The minimum diameter is

- 10 mm for trimmed Brussels sprouts graded in Extra class, Class I and Class II.
- 15 mm for untrimmed Brussels sprouts graded in Extra class and Class I.

For Brussels sprouts in Extra class and Class I, the difference between the largest and the smallest sprout in any one package must not exceed 20 mm.

#### **4.7. GRADE DESIGNATION AND QUALITY OF TOMATOES**

1. (i) Tomatoes shall be fruits obtained from varieties of *Lycopersicon esculentum* Mill of the Solanaceae family.

(ii) Tomatoes may be classified into four commercial types:

- Round
- Ribbed
- Oblong or elongated
- Cherry tomatoes (including cocktail tomatoes)

2. **Minimum requirements:** Tomatoes shall be

- (i) (a) whole, sound and fresh in appearance;
- (b) clean, free of any visible foreign matter;
- (c) free of pests affecting the general appearance of the produce;
- (d) free of damage caused by pests;
- (e) free of abnormal moisture excluding condensation following removal from cold storage;
- (f) free of any foreign smell and/or taste;
- (ii) In the case of trusses of tomatoes, the stalk must be fresh, healthy, clean and free from all leaves and any visible foreign matter.
- (iii) Tomatoes shall comply with the residue levels of heavy metals, Pesticides and other food safety parameters as laid down by the Codex Alimentarius Commission for exports.

**3. Criteria for grade designation:**

| Grade designation | Grade Requirements  | Grade tolerances  |
|-------------------|---|---|
| Extra class       | <p>Tomatoes shall be of superior quality. They shall have firm fresh and must be characteristics of the variety as regards shape, appearance and development. They must be free of green backs and other defects. Very slight superficial defects may be there provided these do not affect the general appearance of the produce, the quality, the keeping quality and presentation in the package.</p>  | <p>5% by number or weight of tomatoes not satisfying the requirements of the grade, but meeting those of Class I or exceptionally, coming within the tolerances of that grade.</p>    |
| Class I           | <p>Tomatoes shall be of good quality. They shall have reasonably firm flesh and shall be characteristics of the variety as regards shape, appearance and development. They must be free of cracks and visible green back. The following slight defects may be there provide these do not affect the general appearance of the produce, the quality, the keeping quality and presentation in the package: slight superficial defects may be there provided these do not affect the general appearance of the produce, the quality, the keeping quality and presentation in the package.</p> <ul style="list-style-type: none"> <li>● a slight defect in shape and development;</li> <li>● a slight defect in colouring;</li> <li>● slight skin defects;</li> <li>● very slight bruises;</li> </ul> <p>"Ribbed" tomatoes may show:</p> <ul style="list-style-type: none"> <li>● healed cracks not more than 1 cm. long;</li> <li>● no excessive protuberances;</li> </ul> | <p>10% by number or weight of tomatoes not satisfying the requirements of the grade, but meeting those of Class II or, exceptionally, coming within the tolerances of that grade.</p> |

[Table Contd.]

Contd. Table]

| Grade designation | Grade Requirements   | Grade tolerances   |
|-------------------|--|--|
|                   | <ul style="list-style-type: none"> <li>● small non lignified umbilical scars;</li> <li>● suberization of the stigma upto 1 sq.cm;</li> <li>● no more than one headed scar;</li> <li>● umbilical lignified scars not greater than 1 sq.cm. or linear scar no longer; than 2/3<sup>rd</sup> of the greatest diameter of the fruit.</li> </ul>  |  |
| Class II          | <p>Tomatoes shall be reasonably firm flesh and shall be character (but may be slightly less firm than in class I) and must not show unhealed cracks. Following defects may be there provided they retain their essential characteristics as regards the quality, the keeping quality and presentation.</p> <ul style="list-style-type: none"> <li>● defects in shape, development and colouring;</li> <li>● skin defects or bruises, provided the fruit is not seriously affected;</li> <li>● healed cracks not more than 3 cm. in length.</li> </ul> <p>"Ribbed" tomatoes may show:</p> <ul style="list-style-type: none"> <li>● more pronounced protuberances but without being misshapen;</li> <li>● one umbilicus;</li> <li>● umbilical lignified scars not greater than 2 sq.cm;</li> <li>● fine blossom scar in elongated form.</li> </ul> | <p>10% by number or weight not satisfying the requirements of the grade but meeting the minimum requirements.</p> <p>In case of trusses of tomatoes, 10 % by number or weight of tomatoes detached from the stalk.</p> |

#### 4. Other requirements:

- (i) The contents of each package must be uniform and contain tomatoes of same origin, variety and/or commercial type, quality and size.

- (ii) The ripeness and colouring of tomatoes in “Extra class” and class I must be uniform. In addition, the length of ‘Oblong’ tomatoes must be sufficiently uniform.
- (iii) The tomatoes may be presented as follows:
  - (a) As individual tomatoes, with or without calyx and short stalks;
  - (b) As trusses of tomatoes, (in entire inflorescence or part of inflorescence). Each inflorescence or part of inflorescence should comprise at least the following number of tomatoes.
    - 3 (2 if prepackaged) or
    - in case of trusses of “Cherry” tomatoes 6 (4 if prepackaged).
- (iv) The development and conditions of the tomatoes shall be such as to enable them:
  - to withstand transport and handling, and
  - to arrive in satisfactory condition at place of destination.

**5. Provisions concerning sizing:** Sizing is determined by the maximum diameter of the equatorial section in accordance with following table. The provisions shall not apply to “cherry” tomatoes. The minimum size is set at 35 mm for “round and “ribbed” tomatoes and 30 mm for “oblong” tomatoes:

| Size Code | Diameter (mm) |         |
|-----------|---------------|---------|
|           | Minimum*      | Maximum |
| 1         | 30            | 43      |
| 2         | 35            | 39      |
| 3         | 40            | 46      |
| 4         | 47            | 56      |
| 5         | 57            | 66      |
| 6         | 67            | 81      |
| 7         | 82            | 101     |
| 8         | 102           | over    |

\* When the tomato in vertical position can pass through a circular opening of the designated diameter.

When the tomato in any position can pass through a circular opening of the designated diameter.

- (i) Observance of the sizing scale is compulsory for “Extra class” and “class I” tomatoes;
- (ii) The sizing scale shall not apply to trusses of tomatoes.
- (iii) For all classes: 10% by number or weight of tomatoes corresponding to the size immediately above or below that indicated on the package with a minimum of 33 mm for “round” and “ribbed” tomatoes and 28 mm for “Oblong” tomatoes.

**6. Provisions concerning colour:** Following terms may be used in the description of the colour as an indication of the storage and brightness of any lot and matured tomatoes.

- Mature green : when the tomatoes present a yellow colour;
- Green: when the surface of the tomato is completely green varying from light to dark green.
- Breakers: when there is a definite break in colour from green to tannish - yellow, pink or red on not more than 10% of the surface.
- Mottled: When yellow, rose or red are present in more than 10% but no more than 30% of the fruits.
- Rose: when rose or red colour are present in more than 30% but less than 60% of the fruit (yellow is not included).
- Red: When more than 60% but no more than 90% of the fruits are rose or red colour.
- Mature red: when more than 90% of the surface of the fruit shows red colour.

#### 4.8 Grade Designation and Quality of Garlic

1. Garlic shall be obtained from varieties (cultivars) *Allium sativum* L. They may be (1) fresh, (2) semidry or (3) dry.
2. **Minimum requirements:**
  - (i) Garlic bulbs shall be
    - (a) sound, fresh in appearance;
    - (b) clean, free of any visible foreign matter;
    - (c) firm;

- (d) free from damage caused by pests;
- (e) free from damage caused by frost or sun;
- (f) free from externally visible sprouts;
- (g) free of abnormal external moisture;
- (h) free of any foreign smell and/or taste;
- (ii) They shall comply with the residue level of heavy metals, pesticides and other food safety parameters as laid down by the Codex Alimentarius Commission for exports.

**Foot note:** (1) ‘Fresh garlic’ means produce with a ‘green’ stem and with the outer skin of the bulb still fresh.

(2) ‘Semi-dry garlic’ means produce with the stem and the outer skin of the bulb not completely dry.

(3) ‘Dry garlic’ means produce in which the stem, the outer skin of the bulb and the skin surrounding each clove are completely dry.

**3. Criteria for grade designation:**

| Grade designation | Grade Requirements   | Grade tolerances   |
|-------------------|--|--|
| Extra class       | Garlic shall be of superior quality. They shall be characteristic of the variety and /or commercial type. The bulbs shall be: <ul style="list-style-type: none"> <li>● intact;</li> <li>● regular in shape;</li> <li>● properly cleaned.</li> </ul> They must be free of defects, with the exception of very slight superficial blemishes, provided these do not affect the general appearance of the produce, the quality, the keeping quality and presentation the package. The cloves must be compact; The roots of dry garlic must be cut off flush with the bulb. | 5% by weight of Garlic not satisfying the requirements of the grade, but meeting those of Class I grade or, exceptionally, coming within the tolerances of that grade. |

[Table Contd.]

Contd. Table]

| Grade designation | Grade Requirements  | Grade tolerances  |
|-------------------|---|---|
| Class I           | <p>Garlic shall be of good quality. They shall be characteristics of the variety and/or commercial type.</p> <p>The bulbs shall be:</p> <ul style="list-style-type: none"> <li>● intact;</li> <li>● of fairly regular shape</li> </ul> <p>The following slight defects, however, may be allowed provided these do not affect the general appearance of the produce, the quality, the keeping quality and presentation in the package.</p> <p>slight tears in the outer skin of the bulb; cloves must be reasonably compact.</p> | <p>10% by weight of Garlic not satisfying the requirements of the grade, but meeting those of Class II or, exceptionally, coming within the tolerances of that grade.</p> |
| Class II          | <p>Garlic which do not qualify for inclusion in the higher grade, but satisfy the minimum requirements. The following defects may be allowed, provided the garlic retains its essential characteristics as regards the quality, the keeping quality and presentation.</p> <ul style="list-style-type: none"> <li>● tears in the outer skin or missing parts of the outer skin of the bulb;</li> <li>● healed injuries;</li> <li>● slight bruises;</li> <li>● irregular shape;</li> <li>● upto three cloves missing.</li> </ul>  | <p>10% by weight of Garlic not satisfying the requirements of the grade but meeting the minimum requirements.</p>   |

#### 4. Other requirements:

- (I) The development and condition of the garlic must be such as to enable it to withstand transport and handling and arrive in satisfactory condition at the place of destination.



- (II) Garlic must be presented as follows:
- (i) loose in the package, with cut stems, the length of the stem not to exceed:
    - 10 cm. in the case of fresh and semi-dry garlic,
    - 3 cm. in the case of dry garlic;
  - (ii) in bunches by:
    - number of bulbs;
    - net weight.

The stems must be evened off;

- (iii) in the case of dry and semi-dry garlic only, in strings by:
  - number of bulbs, there being at least six bulbs per string;
  - net weight.

In the case of presentation in bunches or strings, each package must have uniform characteristics (number of bulbs or net weight). Irrespective of the type of presentation, the stems must be cut cleanly, as must roots in the case of dry garlic classified in the 'Extra' class.

- (III) Package shall be marked 'fresh garlic', 'semi-dry garlic' or 'dry garlic'.

#### 5. Provisions concerning sizing:

- (I) Size is determined by the maximum diameter of the equatorial section.
  - (i) The minimum diameter shall be at 45 mm for garlic classified in the 'Extra' Class and 30 mm for garlic classified in Classes I and II.
  - (ii) For garlic presented loose - with cut stems - or in bunches, the difference in diameter between the smallest and the largest bulb in the same package may not exceed:
    - 15 mm where the diameter of the smallest bulb is less than 40 mm;
    - 20 mm where the diameter of the smallest bulb is 40 mm or more.

- (II) Size tolerances: For all grades: 10% by weight of bulbs not satisfying the requirements as regards sizing and the size indicated but conforming to the size immediately above and/or below that specified. Within this tolerances, not more than 3% of bulbs may have a diameter smaller than the specified minimum but not less than 25 mm.
- (III) Garlic bulb without clove may have minimum diameter of 20 mm for Extra class and 15 mm for Class I and Class II.

#### 4.9. Grade Designation and Quality of Onions

1. Onions shall be obtained from Varieties (cultivars) *Allium cepa* L.

2. **Minimum requirements:**

- (i) Onion shall be
- intact,
  - sound, produce affected by rotting or deterioration such as to make it unfit for consumption is excluded,
  - clean, free from any visible foreign matter,
  - free from damage caused by frost;
  - sufficiently dry for the intended use (in the case of onions for storing, at least the two first outer skins and the stem must be fully dried)
  - without hollow or tough stems;
  - practically free from pests;
  - practically free from damage caused by pests;
  - free of all abnormal external moisture;
  - free of any foreign smell and/or taste.

The stems must be twisted or clean cut and must not exceed 6 cm in length (except for stringed onions).

- (ii) They shall comply with the residue level of heavy metals, pesticides and other food safety parameters as laid down by the Codex Alimentarius Commission for exports.

**3. Criteria for grade designation:**

| Grade designation | Grade Requirements   | Grade tolerances   |
|-------------------|--|--|
| Extra class       | <p>Onion shall be of superior quality. They shall be characteristic of the variety of onion not satisfying and /or commercial type.</p> <p>The bulbs shall be:</p> <ul style="list-style-type: none"> <li>● firm and compact;</li> <li>● unsprouted (free from externally visible shoots);</li> <li>● properly cleaned;</li> <li>● free from swelling caused by abnormal development;</li> <li>● free of root tufts, however, onions harvested before complete maturity, root tufts are allowed.</li> </ul> <p>They shall be free of defects, with the exception of very slight superficial blemishes, provided these do not affect the general appearance of the produce, the quality, the keeping quality and presentation in the package.</p> | <p>5% by number or weight of onion not satisfying the requirements of the grade, but meeting those of Class I grade or, exceptionally, coming within the tolerances of that grade.</p>   |
| Class I           | <p>Onion shall be of good quality. They shall be characteristics of the variety and/or commercial type.</p> <p>The bulbs shall be:</p> <ul style="list-style-type: none"> <li>● firm and compact;</li> <li>● un-sprouted (free from externally visible shoots);</li> <li>● free from swelling caused by abnormal development;</li> <li>● free of root tufts, however, onions harvested before complete maturity, root tufts are allowed.</li> </ul>  | <p>10% by number or weight of onion not satisfying the requirements of the grade, but meeting those of Class II grade or, exceptionally, coming within the tolerances of that grade.</p> |

[Table Contd.]

Contd. Table]

| Grade designation | Grade Requirements   | Grade tolerances   |
|-------------------|--|--|
| Class II          | <p>The following slight defects, however, may be allowed provided, these do not affect the general appearance of the produce, the quality, the keeping quality and presentation in the package.</p> <ul style="list-style-type: none"> <li>● a slight defect in shape;</li> <li>● a slight defect in colouring;</li> <li>● light staining which does not affect the last dried skin protecting the flesh, provided it does not cover more than one-fifth of the bulb's surface.</li> <li>● Superficial cracks in and absence of part of the outer skins, provided the flesh is protected.</li> </ul> <p>Onion which do not qualify for inclusion in the higher grade, but satisfy the minimum requirements. They shall be reasonably firm. The following defects may be allowed, provided the onion retains their essential characteristics as regards the quality, the keeping quality and presentation.</p> <ul style="list-style-type: none"> <li>● defects in shape;</li> <li>● defects in colouring;</li> <li>● early signs of shoot growth visible from outside (not more than 10% by number or weight per unit of presentation);</li> <li>● traces of rubbing;</li> <li>● slight marking caused by parasites or disease;</li> </ul> | 10% by number or weight of onion not satisfying the requirements for the grade but meeting the minimum requirements. |

[Table Contd.]

Contd. Table]

| Grade designation | Grade Requirements   | Grade tolerances |
|-------------------|--|------------------|
|                   | <ul style="list-style-type: none"> <li>● small healed cracks;</li> <li>● slight bruising, healed, unlikely to impair keeping qualities;</li> <li>● root tufts;</li> <li>● stains which do not affect the last dried skin protecting the flesh provided they do not cover more than half the bulb's surface;</li> <li>● cracks in the outer skins and the absence of a part of the outer skins from not more than half of the bulb's surface;</li> <li>● cracks in the outer skins and the absence of a part of the outer skins from not more than one-third of the bulb's surface, provided the flesh is not damaged.</li> </ul> |                  |

**4. Other requirements:**

(I) The development and condition of the onion must be such as to enable them to withstand transport and handling and arrive in satisfactory condition at the place of destination.

(II) Onions must be presented as follows:

- arranged in layers;
- loose in the package (including in bulk bins);
- in strings;

For stringed onions, the characteristics of the strings in any one package (number of bulbs or net weight) must be uniform.

**5. Provisions concerning sizing:**

- (I) Size is determined by the maximum diameter of the equatorial section in accordance with the following table.

| Size code<br>the | Diameter(mm) | Difference between the diameter of<br>smallest and largest onion in the<br>same package (mm) |
|------------------|--------------|--|
| A                | 10-20        | 5  |
| B                | 21-40        | 15   |
| C                | 41-70        | 20   |
| D                | 71 and above | 30   |

The minimum diameter is 10mm.

- (II) Size tolerances: For all grades, 10% by weight of onions not satisfying the size identified, but with a diameter of no more than 20% below or above it.

**4.10. Grade Designation of Potato**

Central Potato Research Institute (CPRI), Shimla has developed hand operated potato graders, power operated potato grader and continuous potato grader with conveyor for the purpose of sorting of potatoes into different grades.

**Provision concerning sizing:**

|             |         |
|-------------|---------|
| Small       | < 25 g  |
| Medium      | 25-50 g |
| Large       | 50-75 g |
| Extra large | > 75 g  |

## CHAPTER 9

# POST-HARVEST TREATMENTS

---

**F**resh vegetables are living tissues subject to continuous change after harvest. Some changes are desirable from consumer point of view but most are not. Post-harvest changes in fresh vegetables can not be stopped, but these can be slowed down within certain limits to enhance the shelf life of vegetables. The post-harvest treatments play an important role in extending the storage and marketable life of vegetables.

### 1. CHEMICAL TREATMENTS

#### 1.1. Washing with Chlorine Solution

Washing produce with chlorinated water can prevent decay caused by bacteria, mold and yeasts on the surface of produce. Calcium hypochlorite (powder) and sodium hypochlorite (liquid) are inexpensive and widely available washing solutions. The effectiveness of the treatment will be decreased if organic matter is allowed to build up in the wash water. The effectiveness of chlorine increases as pH is reduced from pH 11 to pH 7, but at lower pH chlorine becomes unstable. Vegetables can be washed with hypochlorite solution (100-150 ppm available chlorine) for two minutes then with tap water for control of bacteria, yeasts and molds. Maintain pH of wash water between 6.5 and 7.5 for best results.

#### 1.2. Growth Regulator/fungicide Treatments

The growth regulators or fungicidal application such as  $GA_3$ , Bavistin, MH etc. can be effectively used to meet the requirements of international

quality standards and to reduce deterioration during transport. Streptocyclin @ 0.02% as post harvest treatment in onion reduces losses due to bacterial rots in storage/handling. Bavistin @ 0.1% when sprayed after harvest in onion also reduces basal rot in storage.

### 1.3. Calcium Application

The post-harvest application of  $\text{CaCl}_2$  or  $\text{Ca}(\text{NO}_3)_2$  play an important role in enhancing the storage and marketable life of fruits by maintaining their firmness and quality. The post-harvest application of  $\text{CaCl}_2$  (2-4%) for 5-10 minutes dip extend the storage life of climacteric fruits.

### 1.4. Lime Powder Application

Bacterial soft rot (*Erwinia*) of cabbage can be controlled by using lime powder or a 15% solution of alum (aluminum potassium sulfate) in water. After treatment of the butt-end of the cabbage heads, the produce should be allowed to dry for 20 to 30 minutes before packing. Lime powder can be applied by pressing the butt end of the cabbage into a small pile of powder.

### 1.5. 1-Methylcyclopropene (1-MCP) Application

Ethylene accelerates chlorophyll degradation and induces yellowing of green tissues, thus reducing the quality of leafy, floral, and immature fruit-vegetables. The incidence and severity of ethylene-induced deterioration symptoms is dependent upon temperature, time of exposure, and ethylene concentration. For example, the yellowing of cucumbers can result from exposure to either 1 ppm ethylene over 2 days or to 5 ppm ethylene over 1/2 day at 10°C. Ethylene effects are cumulative throughout the post-harvest life of the commodity.

Treatment of vegetable crops with 1-methylcyclopropene (1-MCP), which is an ethylene action inhibitor, provides protection against ethylene damage. Among vegetables, the commercial use of this product at concentrations of up to 1 ppm on tomatoes was approved by the United States Environmental Protection Agency.



## 2. THERMAL TREATMENTS

### 2.1. Hot Water Dips and Sprays

Hot water dips are effective for fungal pathogen control, because fungal spores and latent infections are either on the surface or in the first few cell layers under the peel of the fruit or vegetable. Postharvest dips to control decay are often applied for only a few minutes, at temperatures higher than heat treatments designed to kill insect pests located at the interior of a commodity, because only the surface of the commodity requires heating. Some vegetables tolerate exposure to water temperatures of 50–60°C for up to 10 min, but shorter exposure at these temperatures can control many postharvest plant pathogens.. Fungicide effectiveness can be enhanced by applying the fungicide in a hot water bath, thus allowing more effective fungal control with a reduction in chemicals. This has been particularly effective on citrus with the fungicides thiabendazole and imazalil. In addition, generally recognized as safe (GRAS) compounds have been added in hot water to improve the efficiency of antifungal action.

A recent extension of the hot water treatment has been the development of a hot water spray machine. This is a technique designed to be part of a sorting line, whereby the commodity is moved by means of brush rollers through a pressurized spray of hot water. By varying the speed of the brushes and the number of nozzles spraying the water, the commodity can be exposed to high temperatures for 10–60 s. The water is recycled, but because of the temperatures used (50–70°C), organisms which are washed off the product into the water do not survive. This machine is in use both to clean and to reduce pathogen presence on a number of fruits and vegetables, such as mangos and peppers.

Since hot water is a more efficient heat transfer medium than hot air, when properly circulated through a load of fruit a uniform temperature profile is established in the bath. For disinfestations a longer treatment is necessary than for fungal control because the total fruit and not just the surface has to be brought to the proper temperature. The times of immersion can be 1 h or more and temperatures are below 50°C, in contrast to many antifungal treatments which are for minutes at temperatures above 50°C. Fruit should not be handled immediately after

heat treatment. Cool water showers or forced air should be provided to help return the fruit to their optimum temperature as soon as possible after completion of the treatment. Temperature, exposure and application methods are commodity specific and must be carried out precisely in order to avoid heat injuries, particularly in highly perishable vegetables.

**Table 1: Hot water treatments**

| Commodity   | Pathogens          | Temp. (°C) | Time (min) | Possible injuries |
|-------------|--------------------|------------|------------|-------------------|
| Melon       | <i>Fungi</i>       | 57-63      | 0.5        | –                 |
| Bell Pepper | <i>Erwinia sp.</i> | 53         | 1.5        | Slight spotting   |

## 2.2. Vapour Heat Treatment (VHT)

Vapour heat treatment is a method of heating fruit/vegetable with air saturated with water vapour at temperatures of 40–50°C to kill insect eggs and larvae as a quarantine treatment before fresh market shipment. Heat transfer is by condensation of water vapour on the cooler fruit surface. This procedure was first used to kill Mediterranean (*Ceratitis capitata*) and Mexican (*Anastrepha ludens*) fruit fly in a chamber without forced air. However, once ethylene dibromide and methyl bromide came into use as inexpensive chemical fumigants, vapour heat was abandoned. With the ban on use of ethylene dibromide in 1984, and the imminent removal of methyl bromide from use in 2010, vapour heat has again come into use. However, in modern facilities the vapour heat includes forced air which circulates through the pallets and heats the commodity more quickly than vapour heat without forced air. Commercial facilities operate in many countries, mainly for use on subtropical fruits, particularly mango and papaya. The treatment consists of a period of warming (approach time) which can be faster or slower depending on a commodity's sensitivity to high temperatures. Then there is a holding period when the interior temperature of the produce reaches the desired temperature for the length of time required to kill the insect. The last part is the cooling down period which can be air cooling (slow) or hydrocooling (fast). Thus, there are a number of components of the treatment which can be manipulated to find the best combination for elimination of the insect pest without damaging

the commodity. The temperature and exposure time are adjusted to kill all stages of insects (egg, larva, pupa and adult), but fruit should not be damaged. VHT have been approved by the USDA-APHIS (U.S. Department of Agriculture, Animal and Plant Health Inspection Service) for vegetables like pepper, eggplant and tomato.

### 2.3. Hot Air

Hot air can be applied by placing fruit or vegetables in a heated chamber with a ventilating fan, or by applying forced hot air where the speed of air circulation is precisely controlled. Hot air, whether forced or not, heats more slowly than hot water immersion or forced vapour heat, although forced hot air will heat produce faster than a regular heating chamber. Forced hot air, however, has been used to develop quarantine procedures. One reason is that the high humidity in vapour heat can sometimes damage the fruit being treated, while the slower heating time and lower humidity of forced hot air can cause less damage. A high temperature forced air quarantine treatment to kill Mediterranean fruit fly, melon fly and oriental fruit fly has been developed.

## 3. SPROUT SUPPRESSION

In potatoes, garlic, onion and other crops, sprouting and root formation accelerate deterioration. They also determine the marketability of these products. This is because consumers strongly reject sprouted or rooted products.

### 3.1. Refrigeration and Controlled Atmospheres

It reduce sprouting and rooting rates but because of their costs, chemical inhibition is preferred. In potatoes, CIPC (3-chlor-isopropyl-N-phenyl carbamate) is commercially used as sprout suppressant, which is vaporized and applied @ 40ml/tons of potato, as a thermal fog into the stored potato. A periodic fogging of CIPC @ 40 ml/tons at an interval of 60 days was found optimum for storage of potato at  $10 \pm 1^{\circ}\text{C}$  for 6 months. The potatoes stored at high temperature with periodic CIPC fogging recorded low reducing sugars and negligible sprouting. Sprout suppression in onion

bulbs is achieved by pre-harvest application of maleic hydrazid (MH) @ 2000-3000 ppm. This is applied to leaves of the crop some two weeks before harvesting.

### 3.2. Ionizing Radiation

It can be applied to fresh vegetables to control micro-organisms and inhibit or prevent cell reproduction and some chemical changes. The Food and Drug Administration (FDA) permits three types of ionizing radiation to be used on foods : gamma rays from radioactive cobalt-60 and cesium-137, high energy electrons and X-rays. Although all three have similar effects, gamma rays are most commonly used in food irradiation because of their ability to deeply penetrate pallet load of produce. Gamma irradiation equipment irradiates packaged or bulk commodities by exposing the product to gamma energy from cobalt-60 in closed chamber.

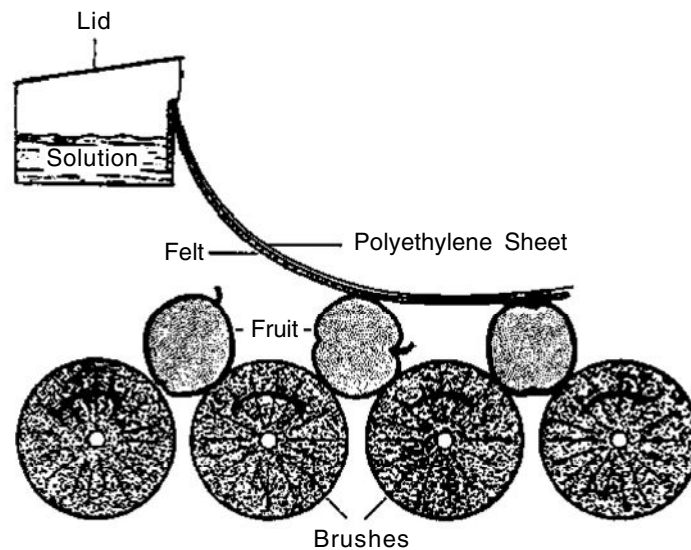
Several workers have attempted irradiation on garlic and onion with gamma rays to control sprouting. The dose varies from 20 Gy to 60 Gy (2K rad to 6K rad) in garlic and 6-9K rad in onion. The radiation treatment given to bulbs within 8 weeks after harvest (before sprouting) can inhibit sprouting effectively, reduce weight loss and prolong storage life for about a year. Doses higher than 100 Gy have been reported to reduce diallyl disulphide content which gives typical flavour to onion and garlic.

The moisture content in produce and the surrounding environment during treatment influence the sensitivity of microorganisms to irradiation. For example, high environmental relative humidity and high water content in produce reduce the effectiveness of irradiation; therefore, control of these parameters during irradiation treatments could extend the shelf life and quality of irradiated vegetables. Recently, disinfections of vegetables with chlorinated water have been replaced with irradiation treatments.

## 4. WAXING

Waxing of immature vegetables such as cucumber and summer squash, mature vegetables such as brinjal, bell pepper and tomato is a common postharvest practice (Fig.1). Food grade waxes are used to replace some of the natural waxes removed during harvesting and sorting operations

and can help reduce water loss during handling and marketing. It also helps in sealing tiny injuries and scratches on surface of vegetables. It also encapsulates aroma compounds, antioxidants, pigments, ions that stop browning reactions and nutritional substances such as vitamins and provide a carrier for decay-control fungicides and growth regulators. It improves cosmetic appearance and prolongs the storage life of vegetables. It produce is waxed; the wax coating must be allowed to dry thoroughly before further handling.



**Fig. 1: Waxing of fruit (Source: Martin and Mieztis, 1964)**

Waxes or edible coating should have desirable characteristics as given below:

- Good sensory quality
- High barrier and mechanical efficiencies.
- Enough biochemical, physico-chemical and microbial stability.
- Free of toxic and safe for health.
- Simple technology of application
- Non-polluting.
- Low cost of raw materials and process for manufacturers.

The commercial available waxes are citrashine, Staryfresh, Sta-fresh 451, Semper Fresh, Carnuba wax, bees wax etc. Government of India has approved only three waxes under PFA rule 42 and sub rule (ZZZ) (25) and these waxes are bees wax (white or yellow) or carnauba wax or shellac wax under proper label declaration. Wax coatings may be applied either by (i) Dipping (ii) Brushing (iii) Spraying. Specific coating applications of different vegetables are given in Table 2.

**Table 2: Specific coating applications for different vegetables.**

| Coating material                            | Vegetables       |
|---|------------------|
| Brilloshine                                 | Melons           |
| Chitosan                                    | Pepper, cucumber |
| Zein  | Tomato           |
| Coating (Surface Systems International co.) | Potato           |

## 5. ESSENTIAL OILS FOR THE CONTROL OF POSTHARVEST PATHOGENS

These plant extracts are generally assumed to be more acceptable and less hazardous than synthetic compounds. This means that essential oils that are registered food grade materials could be used as alternative anti-fungal and anti-bacterial treatments for fresh produce. The potential for these types of plant extracts has not been fully explored. Quite a lot of preliminary work has been done to demonstrate the potential of essential oils for use against postharvest pathogens. One work showed that essential oils from red thyme (*Thymus zygis*), clove buds (*Eugenia caryophyllata*) and cinnamon leaf (*Cinnamomum zeylanicum*) prevented the growth of *Botrytis cinerea*. Other researchers have shown that the essential oil of *Monarda citrodora* and *Melaleuca alternifolia* also exhibit antifungal activity against a wide range of common postharvest pathogens.

## 6. CONTROLLED/MODIFIED ATMOSPHERE TREATMENTS

For commodities that tolerate high CO<sub>2</sub> levels, 15 to 20% CO<sub>2</sub>-enriched air can be used as a fungistat to control decay-causing pathogens.

Insecticidal atmospheres (0.5% or lower O<sub>2</sub> and/or 40% or higher CO<sub>2</sub>) have been shown to be an effective substitute for methyl bromide fumigation to disinfest dried fruits, nuts and vegetables. The effectiveness of insecticidal atmospheres depends upon the temperature, relative humidity, duration of exposure and life stage of the insect. For example, sweet potato weevil (*Cylas formicarius elegantulus*) can be controlled at ambient temperature in stored sweet potato by treatment with low oxygen and high carbon dioxide atmospheres. At 25°C, storage in 2 to 4% oxygen and 40 to 60% carbon dioxide results in mortality of adult weevils in 2 to 7 days.

## 7. CURING ROOT, TUBER AND BULB CROPS

Mechanical damage during harvesting in root, tuber and bulb crops results in bruises, cuts, wounds which increases respiration rate that will lead to increased rates of water loss, decay and physiological deterioration. This damage can be corrected if we create proper conditions for these crops to “heal” before they are removed from the field. Curing root and tuber crops such as sweet potatoes, potatoes, cassava and yams is especially important practice if these crops are to be put into storage for a month or more. Curing practices for root and tuber crops require holding the produce at high temperature and high relative humidity for several days after harvesting which heals wounds and a new protective layer of cells are formed. The best conditions for curing vary among root crops as shown in the table 3, but in practice curing is usually done under ambient field conditions.

**Table 3: Recommended conditions for curing root crops**

| Commodity    | Temperature (°C) | Relative humidity (%) | Days |
|--------------|------------------|-----------------------|------|
| Potato       | 15-20            | 90-95                 | 5-10 |
| Sweet potato | 30-32            | 85-90                 | 4-7  |
| Yams         | 32-40            | 90-100                | 1-4  |
| Cassava      | 30-40            | 90-95                 | 2-5  |

Curing onions and garlic refers to the practice of allowing the external layers of skin and neck tissue to dry out directly following harvest, prior

to handling and storage. If forced heated air is used for curing onions and other bulbs, one day or less at 35°C and 60-75% relative humidity is recommended. The dried layers of 'skin' then protect the produce from further water loss during storage.

### 7.1. Field Curing

Potato, sweet potato and other tropical root and tuber crops can be cured outdoors if piled in a partially shaded area (Fig. 2). Cut grasses or straw can be used as insulating materials and the pile should be covered with canvas or jute bags. Curing requires high temperature and high relative humidity, and this covering will trap self-generated heat and moisture. The stack should be left for about 4-5 days depending upon the crop.

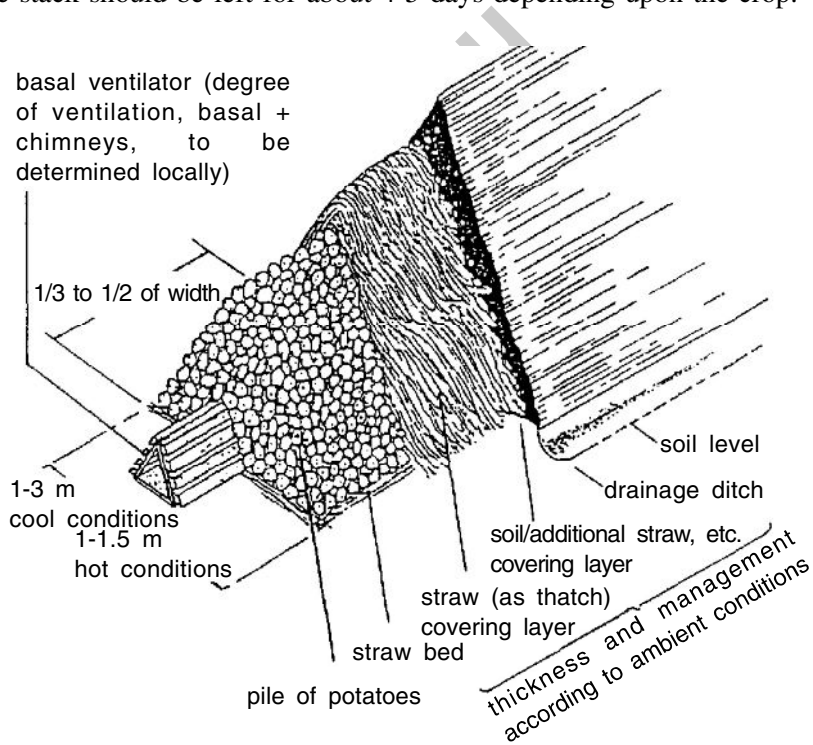


Fig. 2: Field curing of potato (Source: CIP, 1981)



Onions and garlic can be cured in the field in regions where harvest coincides with the dry season. If local weather conditions are dry and warm, these crops can be left in the field after cutting to dry for five to ten days.

## 7.2. Curing Assisted by Shade and Ventilation

The curing of bulb crops can be assisted by the use of ventilated sheds in regions where solar radiation and/or relative humidity is high or natural air movement is low. Produce in sacks should be kept in the shade or canvas tarpaulins under one or more ceiling fans (Fig. 3).

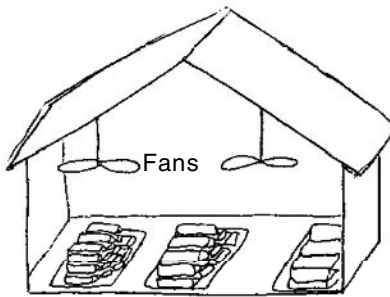


Fig. 3: Curing assisted by shade and ventilation  
(Source: Kitinoja and Kader, 1995)

## 7.3. Curing with Heated Air

The most uniform distribution of heat is obtained when heat is introduced near the floor level of a curing structure. Heaters can be placed on the floor near the bins of produce, or heat can be ducted in from outside the curing room (fig. 4). A high relative humidity can be obtained by wetting the floor or by using an evaporative cooler in the room without introducing outside air.

If heaters are located near the ceiling, then ceiling fans can be used to redistribute the heat down into the room of produce (fig. 5). Bulk bins must be stacked to allow a gap of 10 to 15 cm (4 to 6 inches) between rows for adequate air circulation.

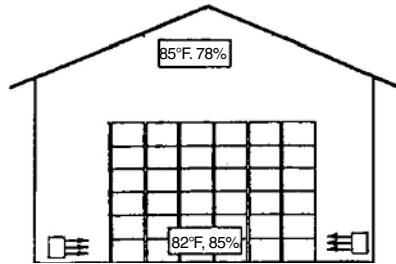


Fig. 4: Heaters placed on the floor (Source: Thompson and Scheuerman, 1993)

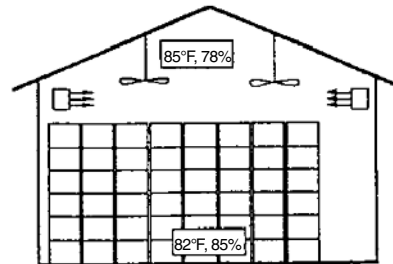


Fig. 5: Heaters located near the ceiling (Source: Thompson and Scheuerman, 1993)

### 7.3. Bulk Systems for Curing Onions

Curing using a bulk system requires a fan, a heating unit and a slatted floor. Fig. 6 shows how air can be brought in, heated and distributed through a load of bulk onions in the curing room. An exhaust opening near the ceiling re-circulates heated air. Curing using heated air results in over drying of bulbs which leads to loss of external scales and exposes fleshy scales underneath. Curing onions should be checked regularly to avoid over-drying.

### 7.4. Emergency Curing

If conditions such as rain or flooded fields do not permit field curing and curing facilities are not available, a temporary tent can be used for curing onions. In the Fig. 7, the tent is constructed from large tarpaulins. Heated air is forced into a hollow area (known as a plenum) at the center of the bins of produce. Several fans are used to circulate the warm air through onions for their curing.

## 8. TREATMENTS TO ENHANCE UNIFORMITY IN FRUIT RIPENING

Among vegetables, ethylene treatment is commercially used in tomato to enhance the rate and uniformity of ripening of fruits. Optimal ripening conditions are given in Table 4.

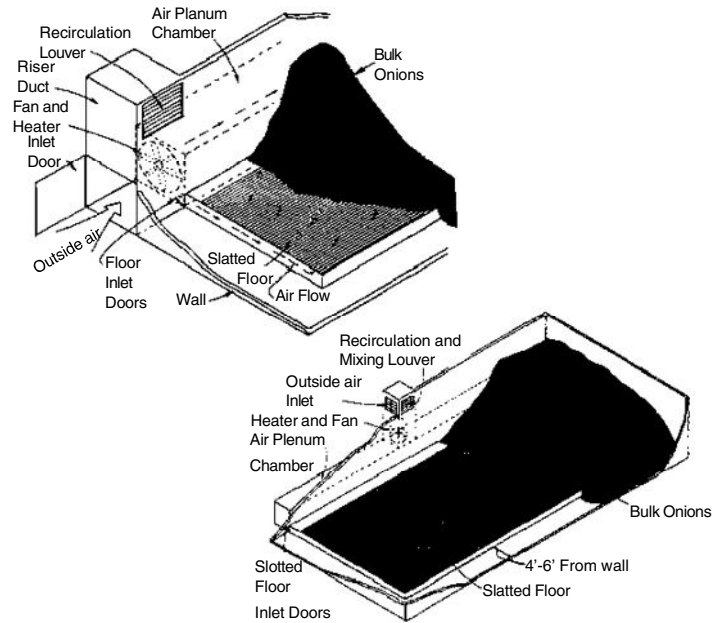


Fig. 6: Bulk systems for curing onions (Source: Davis et al, No date)

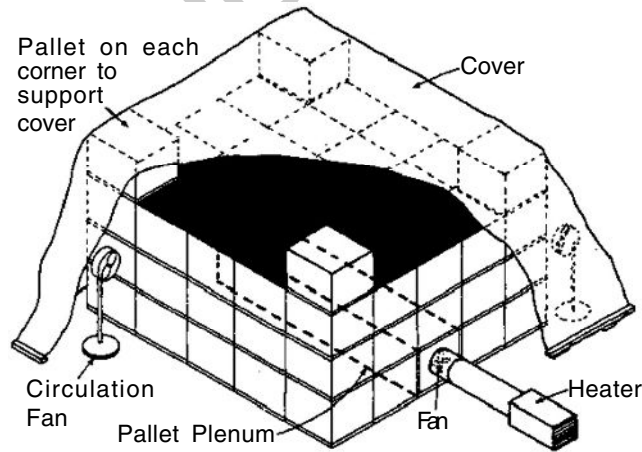


Fig. 7: Emergency curing (Source: Davis et al, No date)

**Table 4: Optimum ripening conditions for climacteric fruits**

|                         |  |
|-------------------------|--|
| Temperature:            | 18 °C to 24 °C   |
| Relative humidity:      | 90 to 95 percent   |
| Ethylene concentration: | 10 to 100 ppm  |
| Duration of treatment:  | 24 to 74 hours depending on fruit type and stage of maturity   |
| Air circulation:        | Sufficient to ensure distribution of ethylene within the ripening room   |
| Ventilation:            | Require adequate air exchange in order to prevent accumulation of CO <sub>2</sub> which reduces the effectiveness of C <sub>2</sub> H <sub>4</sub> . |

Many green vegetables are quite sensitive to ethylene damage. Their exposure to ethylene must therefore be minimized. Ethylene contamination in ripening rooms can be minimized by 1) using ethylene levels of 100 ppm instead of the higher levels often used in commercial ripening operations, 2) venting ripening rooms to the outside on completion of exposure to ethylene, 3) at least once per day ventilating the area around the ripening rooms or installing an ethylene scrubber, 4) use of battery-powered forklifts instead of engine-driven units in ripening areas.

Ethylene-producing commodities should not be mixed with ethylene-sensitive commodities during storage and transport. Potassium permanganate, an effective oxidizer of ethylene, is commercially used as an ethylene scrubber. Scrubbing units based on the catalytic oxidation of ethylene are used to a limited extent in some commercial storage facilities.

# CHAPTER 10

## PACKAGING

---

**P**ackaging fresh vegetables is one of the more important steps in the long and complicated journey from grower to consumer. The function of a package is primarily to contain and protect the produce. Proper packaging of vegetables is essential to maintain product quality during storage, transportation and marketing. Packing and packaging materials contribute a significant cost to the produce industry; therefore it is important that packers, shippers, buyers and consumers have a clear understanding of the wide range of packaging options available.

### 1. WHAT IS PACKAGING?

According to UK institute of packaging

- A coordinated system of preparing goods for transport, distribution, storage, retailing and end use.
- A means of ensuring safe delivery to the ultimate consume in sound conditions at minimum cost.

### 2. FUNCTION OF PACKAGES

- Physical container
- Protection and maintain quality
- Identification

## 2.1. Physical Container

The container must enclose the produce in convenient units for handling and distribution. The produce should fit well inside the container, with little wasted space. Small produce items that are spherical or oblong (such as potatoes, onions and tomatoes) may be packaged efficiently utilizing a variety of different package shapes and sizes. However, many produce items such as asparagus may require containers specially designed for them.

## 2.2. Protection

The package must protect the produce from mechanical damage and poor environmental effects like water vapour, gases, odour, light, microorganisms, dust etc or from damage due to shocks, vibration compression forces etc. This is especially important in case of toxic substances. Damage resulting from poor environmental control during handling and transit is one of the leading causes of rejected produce and low buyer and consumer satisfaction. Each vegetable crop has its own requirements for temperature, humidity and environmental gas composition. Produce containers should be *produce friendly* - helping to maintain an optimum environment for the longest shelf life. This may include special materials to slow the loss of water from the produce, insulation materials to keep out the heat, or engineered plastic liners that maintain a favourable mix of oxygen and carbon dioxide.

## 2.3. Identification

It enables the consumer or any other person to know what food material is packed, date of packaging and expiry date, conditions under which to be kept and type of package. It is also becoming more common to mention nutritional information, recipes, and other useful information specifically for the consumer. Attractiveness of the package is also taken into account.

## 3. UNIVERSALLY STANDARDIZED REQUIREMENT FOR PACKAGING

- The package must have sufficient mechanical strength to protect the produce during handling, compression from overhead weight of other containers, impact and vibration during transportation.

- The package must meet handling and marketing requirements in terms of size, shape and weight in accordance with International standards.
- The material of package must not contain any toxic chemicals which could transfer or produce toxin in packed produce.
- The package should provide fast cooling to the contents.
- The package should be stable to high humidity during pre-cooling, transit and storage.
- The package should be stackable and inter-lockable.
- The package should be re-usable or re-cyclable for easy disposability.
- The package should provide adequate ventilation (5% of total surface area)
- The package should be cost effective in relation to market value of the commodity.
- The package should be of suitable standard depending on the market demand.

#### **4. PACKAGING MATERIALS**

The packages for fresh vegetables can be classified as:

- Transport / Bulk packs
- Consumer / Retail packs

##### **4.1. Transport/ Bulk Packs**

###### **4.1.1. Bags and Sacks**

These are made from paper, polyethylene film, woven polypropylene. These give little protection to the vegetable crops (e.g. potato, onion, carrot etc.) from handling and transport damage. e.g. potato, onion, carrot etc.

###### **4.1.2. Woven Baskets**

These are traditional containers in which crops are placed after harvest. The produce is damaged in these baskets when they are stacked one above the other during transport and distribution.

#### **4.1.3. *Wooden field box***

These are made from thin pieces of wood, widely spread so they are light in weight and cheap to make. These can be used for all types of vegetables.

#### **4.1.4. *Plastic field boxes***

They are strong, durable and made from moulded polyvinyl chloride, polypropylene or polyethylene. They have smooth surface, which does not damage the produce. Initially, they are expensive to buy, but can be used repeatedly.

#### **4.1.5. *Light Weight Plastic Crates***

These are lightweight crates made from HDPE or PP having ventilation which keeps the produce fresh. The crates are stackable and have high compression strength and therefore provide adequate protection to packed produce. These crates are hygienic, clean, reusable and can be recycled.

#### **4.1.6. *Jute Reinforced Plastics (JRP)***

Jute fibers and wood are combined with thermoplastic materials like LDPE, HDPE for making semi-rigid as well as rigid boards. The film layer is placed on both sides of non-woven jute. The composite layers are pressed in a hydraulic press at the required temperature for a certain period of time depending upon the thickness of the end product and the type of film used. These boards have good tensile strength, puncture resistance and moisture barrier property. JRP are now being increasingly used for transport packaging of vegetable products.

#### **4.1.7. *Pallet Boxes***

They are most common base for palletization of produce. They have standard size of 120 × 100 cm and about 10 cm high (Fig. 1). They have capacity of about 500 kg and can hold 20 to 100 units. They are usually made from wood but plastic ones are also available. They are used for whole range of crops, which are commonly loaded on them in the field and transported directly to the store.



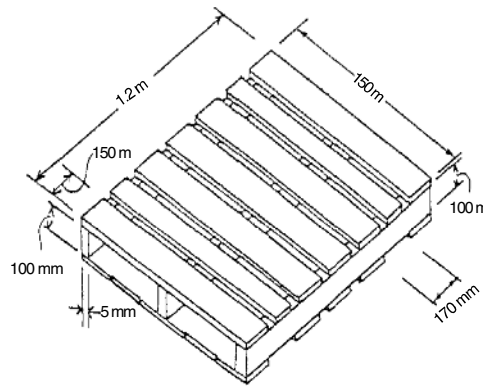


Fig. 1: Standard Pallet (1.2 x 1.0 m)

#### 4.1.8. Polystyrene Boxes

Popularly called thermocol boxes, provides enough protection to produce, are light in weight, hygienic and keeps the produce for longer periods at pack temperature.

#### 4.1.9. Corrugated Fiber Board (CFB) Boxes

Corrugated fiberboard (often mistakenly called cardboard or pasteboard) is manufactured in many different styles and weights. Because of its relatively low cost and versatility, it is mainly used for packing and will probably remain so in the near future. The strength and serviceability of corrugated fiberboard have been improving in recent years. Most corrugated fiberboard is made from three or more layers of paperboard manufactured by the kraft process. Kraft paper made from unbleached pulp has a characteristic brown colour and is exceptionally strong. In addition to virgin wood fibers, Kraft paper may have some portion of synthetic fibers (for additional strength), starch and other materials to give it wet strength and printability.

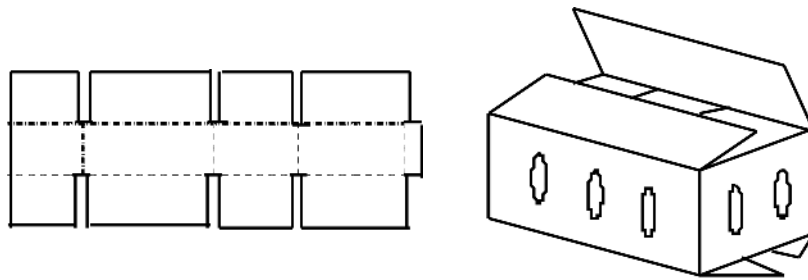
Both cold temperature and high humidity reduce the strength of CFB containers. Unless the container is specially treated, moisture absorbed from the surrounding air and the produce can reduce the strength of the container by as much as 75 percent. New anti-moisture coatings (both wax and plastic) are now available to substantially reduce the effects of

moisture. Waxed fiberboard cartons (the wax is about 20 percent of fiber weight) are used for many produce items that can be used for hydro-cooling or packed icing.

In many applications of CFB containers, the stacking strength of the container is given minor consideration but it is very important from marketing and transportation point of view. For example, canned goods carry the majority of their own weight when stacked. Fresh produce usually cannot carry much of the vertical load without some damage. Therefore, one of the primarily required characteristic of CFB containers is its stacking strength which protects the produce from crushing. Because of their geometry, most of the stacking strength of CFB containers is carried by the corners. For this reason, hand holes and ventilation slots should never be positioned near the corners of produce containers and be limited (not more than 5 to 7 percent of the side area).

**Types of CFB packages:** There are many types of packaging containers available for vegetable crops, and they come in a huge range of sizes. The three containers styles illustrated here are constructed from corrugated fiberboard.

**(a) Regular slotted container (RSC):** The regular slotted containers (RSC) is fully collapsible and the most economical. However RSC has relatively low stacking strength and therefore must be used with produce that can carry some of the stacking load. Collapsible containers can be flattened and stacked, making transportation easy and less expensive and take much less space to store while empty in the packhouse (fig. 2).



**Fig. 2: Regular slotted container (RSC)**

- (b) **Fully telescopic container (FTC):** In FTC, one container is inside another and is used when greater stacking strength and resistance to bulging is required (fig. 3). The choice of package style will depend on the commodity which is going to be packed and the time period for which the container is going to be used in the postharvest system (during cooling, for long-term storage or as a display).

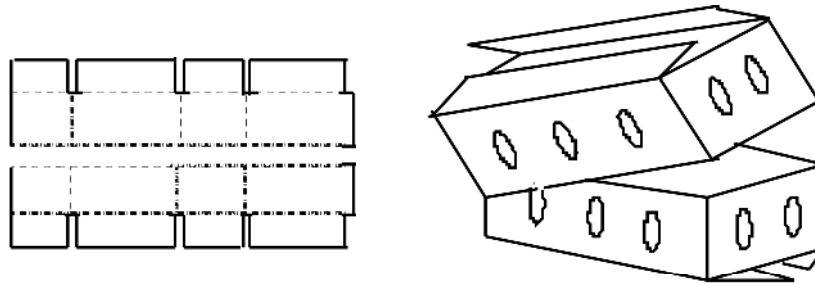


Fig. 3 : Fully telescopic container (FTC)

- (c) **Bliss Box:** The container known as a Bliss box has very strong corners, but is not collapsible. It is constructed from three separate pieces of corrugated fibre board (fig. 4). The Bliss boxes were used when maximum stacking strength is required. Bliss boxes for fresh vegetables most commonly have either flaps that meet in the middle of the top or that form an open topped tray, which is covered with a separate lid.

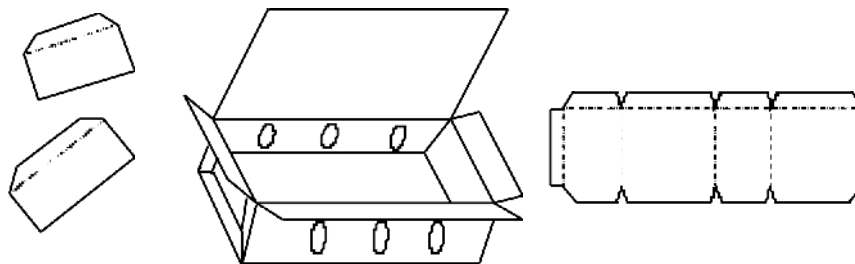
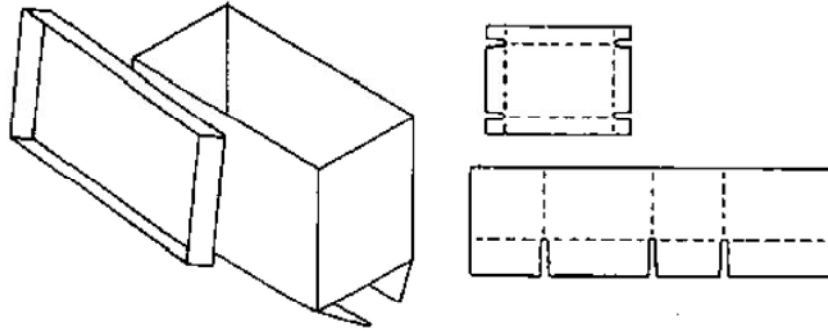
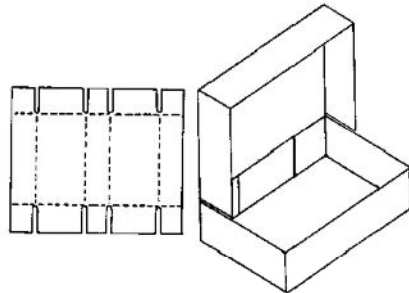


Fig. 4: Bliss Box with its 3 parts

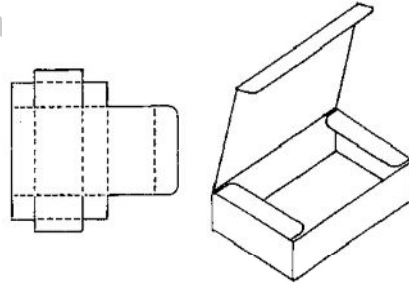
The diagrams below (Fig. 5-9) show a variety of commonly used fiberboard containers. Final dimensions of these containers can be altered to suit the needs of the handler.



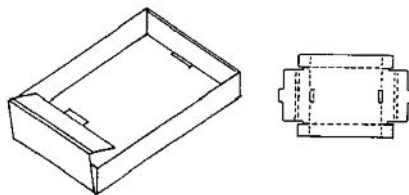
**Fig. 5: Two-piece CFB box with cover**



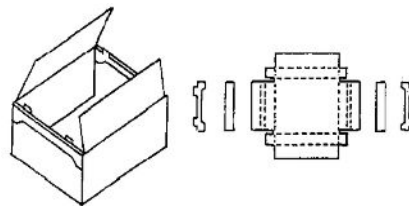
**Fig. 6: One-piece telescopic box**



**Fig. 7: One-piece tuck-in cover box**



**Fig. 8: Self-locking Tray**



**Fig. 9: Interlocking Box**

Shipping containers can be designed and made by the user from fiberboard in any size and shape desired. Three types of joints are commonly used to construct sturdy boxes.

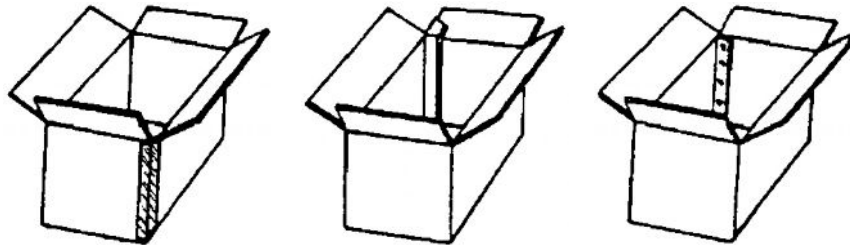


Fig. 10: Taped joints (left), Glued joints (centre), Stapled joints (right)

#### 4.1.10. Rigid plastic or wooden containers

The trimmed asparagus spears are packed upright in containers that provide for a large amount of ventilation (Fig. 9). A simple wooden tray with raised corners is stackable and allows plenty of ventilation for fragile crops such as ripe tomatoes (Fig. 10).



Fig. 11: Asparagus Packing  
(Source: FAO, 1985)

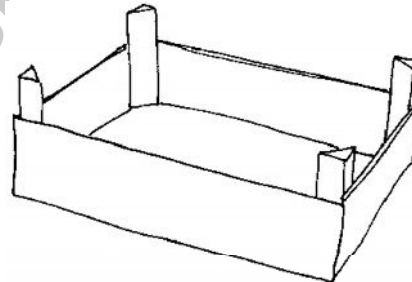


Fig. 12: Wooden tray with raised corners  
(Source: FAO, 1985)

## 4.2. CONSUMER PACKS

Consumer packages are small in size and designed to hold ½ dozen to 1 dozen fruits or ½ kg to 2 kg of vegetables. Many types of packages in terms of forms and materials are used as consumer packs. The selection criterion for the type of consumer pack depends on marketing characteristics of the product. The most commonly used packages are listed below:

#### **4.2.1. Flexible Plastic Films**

Different types of flexible plastic films like LDPE (low density poly ethylene), PVC (Poly Vinyl Chloride), PP (Poly propylene) and cellulose acetate films are used for packaging of vegetable produce. These films are mostly used as pouches with holes punched at regular intervals to allow respiration. They are available in a wide range of thicknesses and grades and can be engineered to control the environmental gases inside the pouch. LDPE is the most widely used material for plastic films.

#### **4.2.2. Clamshells**

Packages with a top and bottom that are heat formed from one or two pieces of plastic are known as clamshells. Clamshells are gaining popularity because they are inexpensive, versatile, provide excellent protection to the produce and present a very pleasing consumer package. Clamshells are most often used with consumer packs of high value produce items like okra, baby corn, snow peas, sugar peas, French beans etc. Clamshells are also used extensively with fresh-cut vegetables and prepared salads.

The concept of a suspended tray clamshell was developed to prevent in-transit fruit motion with respect to the interior surfaces of a container or neighboring fruit. The tray is vacuum-formed and contains pockets shaped like tomato fruit with steeply sloping sides so the fruit are wedged into the cup. The deep pockets and sloping sides allow the pockets to accommodate a range of fruit sizes while still immobilizing the fruit above the bottom of the pocket. A key aspect of the suspended tray is that the walls of the cup are smooth and flexible (not rough, ribbed, or rigid) allowing the cup to conform to the irregular shape of the fruit, immobilizing the fruit during transit without damaging it.

#### **4.2.3. Plastic Punnets**

These are strong, versatile, clear, bright containers which offer product visibility and are provided with holes for ventilation, which keeps the produce fresh. These containers are food-grade, odourless, light weight, stackable and recyclable and give good presentation. They are either made of PET, PVC or PP.

#### **4.2.4. Plastic Net bags (Extruded and Woven)**

The plastic net bags have the feature to stretch and accommodate all sizes and shapes of produce. These bags are available in roll form or in pre-cut lengths with stretch width of 200 - 400 mm. These are generally made of HDPE (High Density Polyethylene) or PA (Polyamide). By allowing air to circulate in and around the produce, these net bags prolong the freshness and shelf-life of the fresh produce. They also eliminate pack condensation thereby preventing spoilage and wastage. They make a colourful point of sale display by allowing clear visibility of the contents, enhancing the natural colours of fresh produce. However, Net bags of any type have several serious disadvantages. Large bags do not palletize well and small bags do not efficiently fill the space inside CFB boxes. Net bags do not offer any protection from rough handling and provide very little protection from light or contaminants. Net bags are used for packing vegetables like potatoes, onion, carrot, cabbage, turnips.

#### **4.2.5. Paper pulp moulded trays**

Trays are made from recycled paper pulp and a starch binder and mainly used for small consumer packages of fresh produce. Pulp trays are available in a large variety of shapes and sizes and are relatively inexpensive. Pulp trays can absorb surface moisture from the product so it is good for small size vegetables like okra, beans which are easily damaged by water. Pulp trays are also biodegradable and recyclable.

#### **4.2.6. Cling film**

It is made of polyethylene film of few microns (15-micron) thickness. These films have low water vapour transmission rate and high gas permeability. A good film must stretch, retain its elasticity and cling to the package. It also keeps the produce fresh and free from dust and contaminations.

### **5. TYPES OF PACKAGES**

#### **5.1. Primary Package**

It is one, which is in direct contact with the contained product. It provides the initial and usually the major protective barrier. e.g. consumer packs which protect and advertise the material e.g. metal cans, glass bottles, jars, bags, over wraps and plastic pouches. It is only the primary package which consumer purchases at retail outlet.

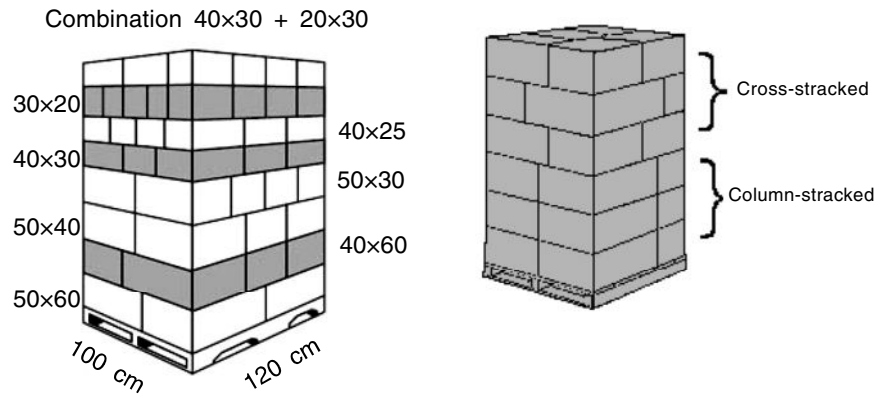
## 5.2. Secondary Package

It contains a number of primary packages. It is the physical distribution carrier and sometimes used as display of primary packages in retail outlet. Examples: wooden, metal, corrugated fiberboard cartons, crates, barrel drum. They need to satisfy the following requirements: be easy to handle, stackable by one person; have the appropriate dimensions so that they fit into transport vehicles; package should be constructed with biodegradable, non-contaminating and recyclable materials.

## 5.3. Tertiary Package

A tertiary package is made up of a number of secondary packages. The most common example being a stretch wrapped pallet of corrugated boxes. Pallets have become the main unit load of packaging at both domestic and international level. Their dimensions correspond to those of maritime containers, trucks, forklifts, storage facilities, etc. They are usually made from wood but plastic ones are also available. Different sizes of pallets exist but the most common size internationally is 120 x 100 cm. The ISO (International Standards Organization) module (norm ISO 3394) sets 60 and 40 cm as basic horizontal dimensions divided in subunits of 40 x 30 cm and 30 x 20 cm (Fig. 13). There are no regulations regarding the height of individual packages. However, the palletized load should not exceed 2.05 m to ensure safe handling. They have capacity about 500 kg and may hold from 20-100 units. On the recommendation of USDA, the MUM system (Modularization, Unitization and Metrication) system has been developed on the basis of container standardization on the 120 x 100 cm pallet. To ensure stability, pallet loads are secured with wide mesh plastic tension netting or a combination of corner post protectors and horizontal and vertical plastic strapping. In many cases individual packages are glued to each other with low tensile strength glue that prevents sliding. They are also stacked crosswise or interlocked to contribute to the load stability. Cross stacking places the corner of one produce package at the middle of the one below it, thus reducing its stacking strength. To reduce the possibility of collapse, the first several layers of each pallet should be column stacked (one package directly above the other) (fig. 13). The upper layers of packages may be cross stacked as usual with very little loss of pallet stability. To reduce the impact, packages need to be designed to meet their functional objectives, with minimal wastage of materials and need to be recyclable, after their main functional use.





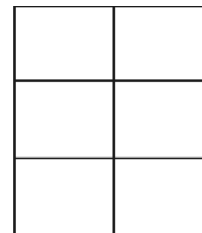
**Fig. 13: Different horizontal package dimensions to maximize utilization of a 100 x 120 cm pallet, according to MUM and ISO (shaded) systems.**

The following illustrations (Fig. 14) show the arrangement of a variety of MUM containers on a standard pallet (100 x 120 cm or 40 x 48 inches). Using MUM containers can save space during transport and storage, since pallet utilization is close to 100%.

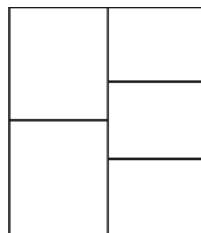
Outside dimensions:  
50 x 60 cm  
No/layer=4  
Pallet utilization  
100%



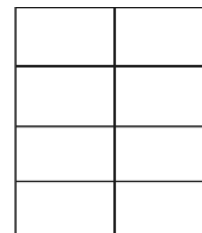
Outside dimensions:  
50 x 40 cm  
No/layer=6  
Pallet utilization:  
100%



Outside dimensions:  
40 x 60 cm  
No/layer=5  
Pallet utilization:  
100%



Outside dimensions:  
50 x 30 cm  
No/layer=8  
Pallet utilization:  
100%



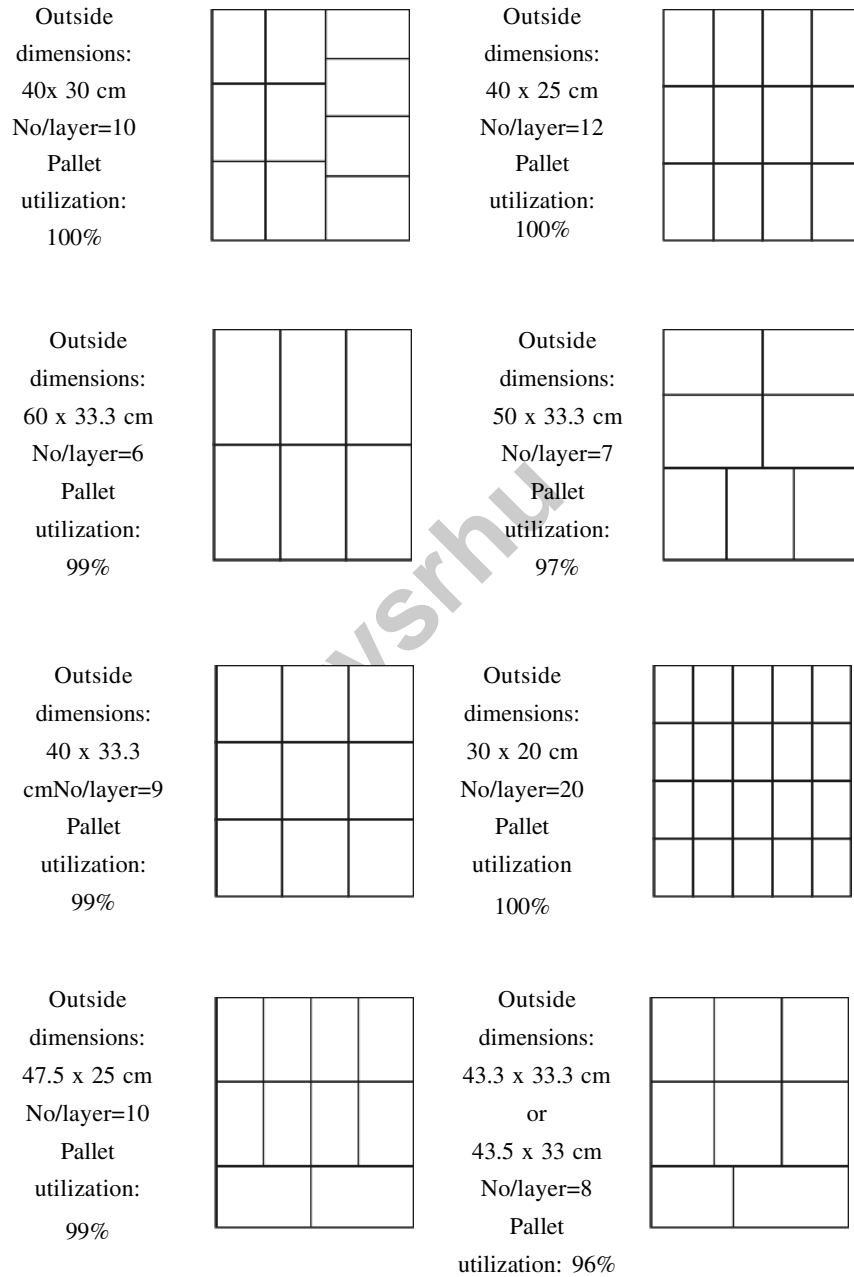


Fig. 14: Arrangement of pallets in MUM containers (Source: McGregor, 1989)

## 5.4. Quaternary Package

In interstate/international trade, a quaternary package is frequently used to facilitate the handling of tertiary packages. Example: pallet bin or metal container. A metal container is upto 12 m in length, which can hold many pallets. It is inter modal in nature i.e. it can be transferred to/ from ships, trains and flat bed trucks by giant cranes. Some designs have environmental control (frozen foods/ fresh fruits and vegetables).

## 6. USE OF PACKAGE INSERTS, FILLERS AND LINERS

### 6.1. Fiber Board Divider

Adding a fiberboard divider to CFB box will increase its strength. The use of simple dividers is common with heavy crops such as melons (Fig. 15), and prevents melons from vibrating against one another during handling and transport.

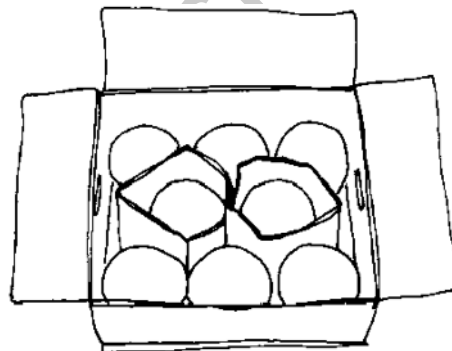
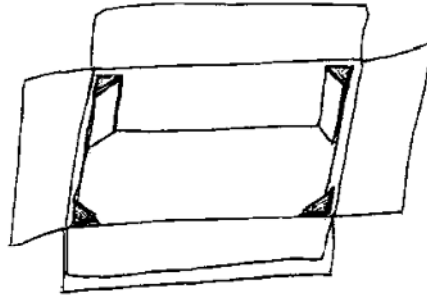


Fig. 15: Use of Dividers

### 6.2. Wooden Corners

Wooden inserts, or fiberboard folded into tight triangles and placed in all four corners can be especially useful when a carton needs strengthening (Fig. 16).



**Fig. 16: Triangular corner supports**

### 6.3. Polyethylene Liner

Polyethylene liner in CFB boxes can protect produce and reduce water loss from produce. Water vapour given off by the produce is contained within the liner, increases the humidity around the produce and decreases the rate of water loss. It is important to keep produce cool to prevent damage in boxes lined with polyethylene due to gas composition changes related to increased respiration rates.

### 6.4 Foam Sleeve

This is a plastic tubular film made of polyethylene foam available in different colours, diameters and lengths. It can be easily slipped over the individual fruits in a snug fit form. It provides a cushioning effect and protects the fresh produce against abrasion and scratches during transit. It is hygienic, nontoxic and odourless.

## 7. LABELING

Labeling packages helps handlers to keep track of the produce as it moves through the postharvest systems and assists wholesalers and retailers in using proper practices. Cartons can contain information on maximum stacking heights, recommended temperature range, RH conditions and warning against storage with ethylene producing crops etc. Labels can be preprinted on fiberboard boxes, or glued, stamped on to containers. Brand labeling packages can aid in advertising for the product's producer, packer and/or shippers. Shipping labels can contain some or all of the following information:

- Common name of the product
- Net weight, count and/or volume
- Brand name
- Name and address of packer or shipper
- Country or region of origin
- Size and grade
- Recommended storage temperature
- Special handling instructions
- Names of approved waxes and/or pesticides used on the product

Labeling of consumer packages is mandatory under FDA regulations. Labels on consumer packages must contain the name of the product, net weight and name and address of the producer, packer or distributor.

## **8. GENERAL DO'S AND DON'TS FOR PACKAGING HIGH QUALITY PRODUCE**

- The packages should be sturdy and capable to withstand handling, cooling and storage conditions.
- Rough packages such as baskets and wooden crates should be lined with cardboard inserts.
- Packages used for heavy produce should be reinforced with corner supports or folded dividers.
- Avoid using very large packages since the produce suffers more damage during handling of large packages.
- For delicate produce such as round melon, summer squash, okra and ripe vegetables like tomato, use shallow packages having single layer or double layers.
- Avoid over filling or under filling packages.
- For adequate ventilation of packages, about 5% of the surface area per side should be vented.
- For immobilizing the produce in a package, use packaging materials such as trays, cups, wraps, liners and pads.
- Use plastic mesh bags for garlic and onions which will provide the lower humidity environment required for proper handling.

- Care should be taken while using fillers and liners in packages that the ventilation holes in boxes are not blocked.
- Labeling containers with logo or farm name help in creating a brand name for quality produce.
- Consumer packages that can be used to display produce during marketing should be considered.
- Use large packages to pack 'consumer packages' such as gift packs or display trays for providing better protection to the containers during stacking, transport and marketing.
- For reducing produce damage, packages with handles to carry should be considered.

## 9. MODIFIED ATMOSPHERE PACKAGING (MAP)

The basic premise of modified atmosphere packaging (MAP) technology is that once produce is placed in a package and sealed, an environment different from ambient conditions will be established as the produce continues to respire. The key to successful use of MAP technology is to know what type of environment will be most beneficial to the produce inside the package and then determining which packaging materials should be used to create such an environment. MAP is only a supplement to proper refrigeration and not a replacement for temperature management.

Environmental conditions important to perishables that MAP can effect are atmospheric oxygen ( $O_2$ ), carbon dioxide ( $CO_2$ ), ethylene ( $C_2H_4$ ) and water vapour (relative humidity) concentrations. Correct use of MAP technology can significantly extend the shelf life of product but, if incorrect packaging and materials are chosen than it create undesirable atmospheric conditions which will injure produce and result in short shelf-life and poor quality.

The effect of MAP is due to slow down plant respiration in low  $O_2$  environments. There is about 21%  $O_2$  in air. As the concentration of  $O_2$  inside the package falls below 10%, respiration starts to slow. This suppression of respiration continues until  $O_2$  reaches about 2-4% for most produce. If  $O_2$  gets lower than 2-4% (depending on product and temperature), fermentative metabolism replaces normal aerobic metabolism and off-flavour, off-odour and undesirable volatiles are produced. Similarly,

as CO<sub>2</sub> increases above the 0.03% found in air, a suppression of respiration results for some commodities. Reduced O<sub>2</sub> and elevated CO<sub>2</sub> together can reduce respiration more than either alone. In addition, elevated CO<sub>2</sub> suppresses plant tissue sensitivity to the effects of the ripening hormone ethylene. For those products that tolerate high concentrations of CO<sub>2</sub>, suppression of the growth of many bacteria and fungi results at >10% CO<sub>2</sub>. The goal of MAP for fresh produce is to create an equilibrium package atmosphere with %O<sub>2</sub> low enough and %CO<sub>2</sub> high enough to be beneficial to the produce.

### 9.1. Passive vs. Active MAP

**Passive MAP:** When the low O<sub>2</sub> and/or elevated CO<sub>2</sub> atmosphere within a MAP results from the produce consuming O<sub>2</sub> and releasing CO<sub>2</sub> within a confined space, that is called passive MAP.

**Active MAP:** Rapid establishment of low O<sub>2</sub> and/or elevated CO<sub>2</sub> environment in the package by flushing the predicted O<sub>2</sub> and CO<sub>2</sub> equilibrium concentration from the outside into the packaged produce.

### 9.2. Characteristics of Packaging Material for MAP

There are ten main characteristics to consider while selecting packaging material for MAP:

- Resistance to puncture
- Sealing reliability
- Antifogging properties
- CO<sub>2</sub> and O<sub>2</sub> permeability
- Water transmission rate
- Good transparency and gloss
- Good thermal and ozone resistance
- Commercial suitability
- Ease of handling

Many plastic films are available for packaging, but very few have gas permeability that make them suitable for MAP. Low density

polyethylene and polyvinyl chloride are the main films used in packaging fresh vegetables. Saran and polyester have such low gas permeability i.e. they are suitable only for commodities with very low respiration rates. The Table 1 provides the permeability of the films currently available for packaging fresh produce.

**Table 1: Permeability (CO<sub>2</sub> and O<sub>2</sub>) of different films used for packaging fresh produce**

| Film type                  | Permeabilities (cc/m <sup>2</sup> /mil/day at 1 atm) |                |                                       |
|----------------------------|--|----------------|---------------------------------------|
|                            | CO <sub>2</sub>                                      | O <sub>2</sub> | CO <sub>2</sub> :O <sub>2</sub> Ratio |
| Polyethylene (low density) | 7,700-77,000   | 3,900-13,000   | 2.0-5.9                               |
| Polyvinyl chloride         | 4,263-8,138  | 620-2,248      | 3.6-6.9                               |
| Polypropylene              | 7,700-21,000   | 1,300-6,400    | 3.3-5.9                               |
| Polystyrene                | 10,000-26,000  | 2,600-7,700    | 3.4-3.8                               |
| Saran                      | 52-150   | 8-26           | 5.8-6.5                               |
| Polyester                  | 180-390  | 52-130         | 3.0-3.5                               |

### 9.3. MAP Design

Once appropriate atmosphere is determined for the commodity to be package, some simple calculations can help in determining the type of film be used to attain such an atmosphere. The important variables in MAP design are:

- Product Mass (Weight)
- Product Respiration Rate
- Film Area
- Film Thickness
- Desired O<sub>2</sub> and CO<sub>2</sub> concentrations
- Film Oxygen Transmission Rate (OTR)
- Film CO<sub>2</sub> Transmission Rate (CO<sub>2</sub>TR)

The respiration rate of the product is further influenced by:

- Storage temperature



- Produce variety
- Growing area and conditions
- Injury to the produce

$$\text{OTR (cc/mil/cm}^2\text{/hr)} = \frac{\text{Product wt (kg)} \times \text{Product respiration rate (ml O}_2\text{/kg/hr)} \times \text{film thickness (mil)}}{\text{Film area (cm}^2\text{)} \times \{\text{desired external O}_2\text{ (\%)} - \text{desired internal O}_2\text{ (\%)} \text{conc.}\}}$$

Similarly CO<sub>2</sub>TR is calculated.

The unknown variables are usually film OTR or CO<sub>2</sub>TR. Film OTR and CO<sub>2</sub>TR are inherent properties of a flexible film and they will determine what flexible packaging material is needed to achieve the desired atmosphere. Once film OTR and CO<sub>2</sub>TR are determined then an appropriate film may be selected with some confidence in its ability to deliver the desired O<sub>2</sub> concentrations within the package for that commodity.

**Example:** You wish to package 4 kg of produce which has a respiration rate of 7 ml O<sub>2</sub>/kg/hr and you will use a package that is 1 mil thick and has an area of 1800 cm<sup>2</sup>. What film OTR will you select to get an atmosphere of 5% O<sub>2</sub> inside the package.

|                                  |   |   |
|----------------------------------|---|---|
| Weight                           | : | 4 kg  |
| Respiration rate                 | : | 7 ml O <sub>2</sub> /kg/hr  |
| Film thickness                   | : | 1 mil   |
| Area                             | : | 1800 cm <sup>2</sup>  |
|                                  |   | (Length (cm) x width(cm) x package side)  |
|                                  |   | 30 x 30 x 2   |
| Internal O <sub>2</sub> (%)      | = | 0.05 = 5%   |
| External O <sub>2</sub> (%)      | = | 0.21 = 21% Air  |
| OTR (cc/mil/cm <sup>2</sup> /hr) | = | $\frac{(4 \text{ kg}) \times (7 \text{ ml O}_2\text{/kg/hr}) \times (1 \text{ mil})}{(1800 \text{ cm}^2) (0.21-0.05)} = 0.0972$ |

Film OTR values may be reported by manufacturers in various units. To convert OTR (cc/mil/cm<sup>2</sup>/hr) to OTR (cc/100 in<sup>2</sup>/day) multiply by 15483.84 OTR (cc/100 in<sup>2</sup>/day)=0.0972x15483.84=1505.029

#### 9.4. Gas Composition (O<sub>2</sub>, CO<sub>2</sub>) Requirements of Selected Vegetables

There are specific gas composition (O<sub>2</sub> and CO<sub>2</sub>) for each vegetable below or above which injury can occur. The O<sub>2</sub> limit below which and CO<sub>2</sub> limit above which injury can occur in selected vegetable crops are given in Table 2 and Table 3 respectively.

**Table 2: O<sub>2</sub> limits below which injury can occur for selected vegetable crops held at typical storage temperatures.**

| O <sub>2</sub> (%) | Commodity  |
|--------------------|--|
| < 0.5              | Chopped greenleaf, Romaine and iceberg lettuce, spinach, broccoli, mushroom  |
| 1.0                | Broccoli florets, chopped butterhead lettuce, Brussels sprouts, cantaloupe, cucumber, crisphead lettuce, onion bulbs |
| 2.0                | Shredded and cut carrots, artichoke, cabbage, cauliflower, celery, chili, bell pepper, sweet corn, tomato.           |
| 2.5                | Shredded cabbage   |
| 3.0                | Cubed or sliced cantaloupe   |
| 4.0                | Sliced mushrooms   |
| 5.0                | Green snap beans   |
| 10.0               | Asparagus  |

**Table 3: CO<sub>2</sub> partial pressures above which injury will occur for selected vegetable crops**

| CO <sub>2</sub> (kPa) | Commodity                                    |
|-----------------------|--|
| 2                     | Lettuce (crisphead)                          |
| 3                     | Artichoke, tomato                            |
| 5                     | Cauliflower, cucumber, potato, bell pepper   |
| 7                     | Snap bean (green)                            |
| 10                    | Asparagus, brussels sprouts, cabbage, celery |
| 15                    | Broccoli                                     |
| 20                    | Cantaloupe (muskmelon), mushroom             |

**Table 4: Gas composition for MAP in selected vegetables and their effect on shelf life**

| Product   | Temperature (°C) | Oxygen (%) | Carbon dioxide (%) | Storage life in air (days) | Storage life in MAP (days) |
|-----------|------------------|------------|--------------------|----------------------------|----------------------------|
| Snap bean | 4-8              | 2-3        | 4-7                | 7                          | 14                         |
| Broccoli  | 0-1              | 1-3        | 5-15               | 28                         | 56                         |
| Lettuce   | 0-1              | 2-5        | <1                 | 21                         | 28                         |
| Capsicum  | 7-12             | 2-5        | 2-5                | 21                         | 28                         |

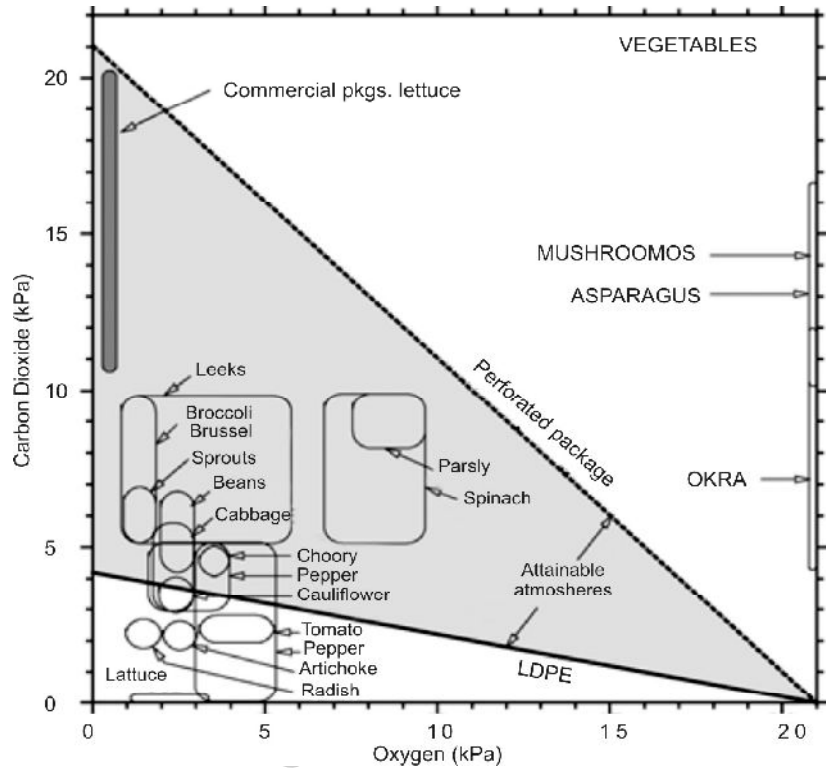
### 9.5. Application of MAP in Vegetables

MAP prevent cut surface browning and extend shelf life of fresh-cut produce by reducing respiration rate. A properly designed MAP, when used in combination with low temperature storage, delays spoilage of vegetables by slowing the natural processes that lead to tissue death and decay by food spoilage micro-organisms. The Fig. 17 shows the recommended O<sub>2</sub> and CO<sub>2</sub> combination for MAP vegetables.

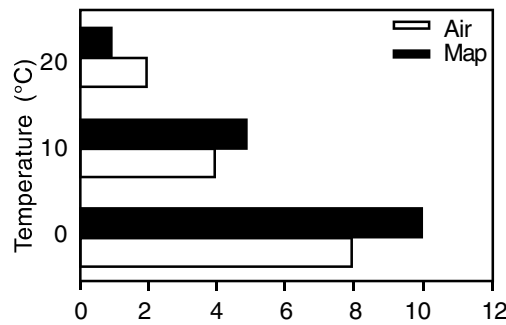
The Fig. 18 shows the effects of storage temperature and MAP on the shelf-life of a perishable commodity, which requires storage temperature of 0°C. At 0°C the use of MAP extends shelf-life by 2 days or approximately 20%, compared to produce stored in air. Product held at 10°C in MAP has a longer shelf-life than product held in air at 10°C, but a significantly short shelf-life than product that is held either in air or MAP at 0°C. This demonstrates that temperature control is more effective than MAP is extending shelf-life. At 20°C MAP product may actually have a shorter shelf-life than if they were held in air, since anaerobic condition may be generated inside MAP packages at 20°C and cause accelerated spoilage.

Lightly processed lettuce (shredded or chopped) can be packaged in 5-mil plastic bags (Fig. 19). After a partial vacuum is created, a gas mixture of 30 to 50% O<sub>2</sub> and 4 to 6% CO<sub>2</sub> is introduced into the bag, which is then sealed.

A single pallet load of produce can be sealed within a shroud of 5 mil polyethylene bag and a plastic sheet on the pallet base using wide tape. A slight vacuum can be introduced and 15% CO<sub>2</sub> (according to packed crop) added to the air introduced via a small hose (Fig. 20). This practice is commercially used in stawbarries



**Fig. 17:** Recommended  $O_2$  and  $CO_2$  combinations for the storage of vegetables. The shaded area depicts atmospheres theoretically attainable by MAP using low density polyethylene (LDPE, lower boundary) and perforated packages (upper, dashed line). The darkened area represents atmospheres observed in commercial MA packages of mixed lettuce-based salads.



**Fig. 18:** Effect of storage temperature and MAP on shelf life of produce

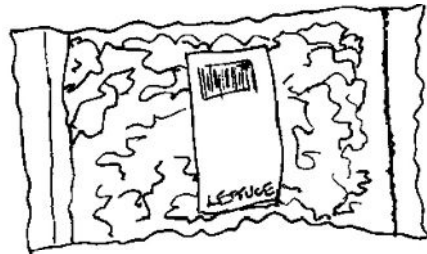


Fig. 19: Use of MAP in sealed plastic consumer bag

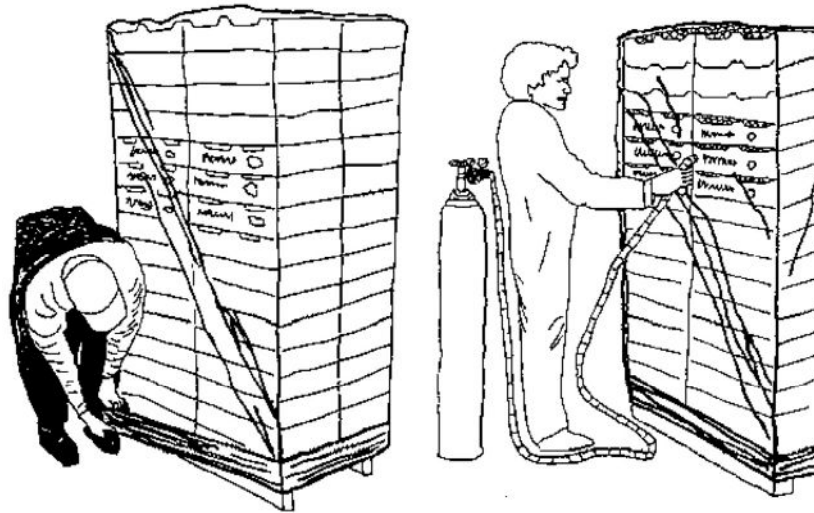


Fig. 20: Filling CO<sub>2</sub> in pallet load of produce (Source: Kitinoja and Kader, 1995)

### 9.6. Advantages of MAP

- Reduce moisture loss (reduced weight loss)
- Delay ripening (longer marketing time)
- Control decay (reduced postharvest losses)
- Delay undesirable composition changes (delay loss of fruit acids and sugars)
- Increased shelf-life allowing less frequent loading of retail display shelves
- Reduction in retail waste
- Improved presentation-clear view of product and all round visibility

- Hygienic stackable pack, sealed and free from product drip and odour
- Easy separation of sliced products
- Little or no need for chemical preservatives
- Reduction in production and storage costs due to better utilization of labour, space and equipment

### 9.7. Disadvantages of MAP

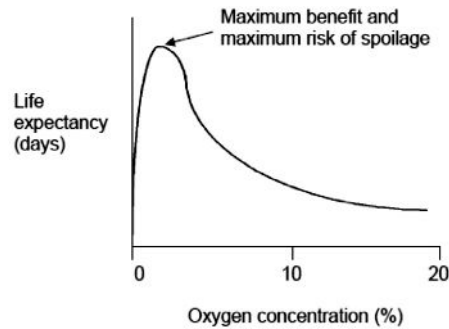
- Capital cost of gas packaging machinery
- Cost of gases and packaging materials
- Cost of analytical equipment to ensure that correct gas mixtures are being used
- Cost of quality assurance systems.
- Increased pack volume which will adversely affect transport costs and retail display space
- Potential growth of food-borne pathogens due to temperature abuse by retailers and consumers
- Benefits of MAP are lost once the pack is opened or leakage in the pack.

### 9.8. Problems with MAP

The difficulty with using modified atmosphere packaging is the establishment of a stable atmosphere inside the plastic bag. MAP is a dynamic system that is not controlled. Therefore it is important to use MAP only as recommended by the manufacturer.

The factor that causes most problems in a commercial situation is temperature. Unfortunately the cool chain for fresh produce is not always continuous throughout the marketing system. Breaks in the cool chain such as during loading or unloading of trucks or packing of produce mean that the cool produce can warm up. Warming of only a few degrees can be enough to cause the respiration rate of the product to rise and the oxygen within the package to fall below the recommended level. If the oxygen level falls too low then anaerobic respiration can be initiated. If this happens alcoholic off-flavour develop within the product, making it unmarketable.

There is always a risk/benefit when using MAP, particularly when a low oxygen atmosphere is providing the benefit. The Fig. 22 illustrates this point. The greatest extension of shelf life occurs at the lowest possible oxygen concentration before anaerobic respiration is initiated.



**Fig. 22: Risk/benefit associated with MAP**

This point also carries the greatest risk. For example, if the respiration rate increases as a result of a small change in temperature then the oxygen level will fall below the critical level and off-flavour will be produced. The same is true for atmospheres where the main benefit is high carbon dioxide. If respiration increases due to an increase in temperature then the level of  $\text{CO}_2$  may rise above the critical level and the product will also be damaged and made unsaleable. There are two ways to minimise the risk of spoilage. Firstly use a package that provides slightly more oxygen, and so provides less benefit in terms of shelf life but the package would also have a reduced risk of spoilage. Secondly ensure that the cool chain is maintained. If there is no guarantee of temperature stability then there is very big risk of using MAP system. If the temperature rises by more than a few degrees then damage could be avoided by opening the bags to ensure adequate oxygen for the product. This is not often feasible but some packers recommend that the MA bags are opened once the product arrives at the wholesale market to ensure there is no risk of spoilage.

### 9.9. New and Emerging MAP Technologies

Currently, packaging systems are not responsive to changes in the environment in which a package is kept. A new type of packaging is on the horizon called active packaging. Active packaging is a group of technologies in which the package is actively involved with food products or interacts with internal atmosphere to extend shelf life while maintaining quality and safety. Active packaging sometimes referred to as 'interactive'

or ‘smart packaging’, which is intended to sense interval or external environmental changes and to respond by changing its own properties or attributes. Some of the active packaging MAP technologies are listed below:

### **9.9.1. Metallocene Technology**

Metallocene technology is developed independently by Dow Chemical Co. and Exxon Chemical Co. uses new single site catalysts to produce desired polymer resins. These catalysts, when applied to manufacture poly ethylene and other polymers, can provide a much narrower distribution of polymer chain length, molecular weight and density and are available from Exxon (under the trade name Exact ®) and Dow (under the trade name Affinity ®). This results in flexible plastic films with very high OTR, low moisture vapor transmission rate, enhanced clarity, superior strength, low seal initiation temperature and very rapid bonding of the seal. These stronger films with stronger seals are finding wide application in produce packaging.

### **9.9.2. Microperforated and Microporous Films**

Alternative approaches to providing high OTR's, especially where there is limited package surface area for gas exchange, have included films with holes or pores. The atmosphere inside the package is determined by the total surface area of the holes on the package surface. The difficulty with manufacturing such films is how to consistently get the right number and diameter of holes per square centimetre of the film. Currently, micro perforations are placed in plastic films by mechanical means, sparks or by laser. “*FreshHold*”, a microporous film technology owned by Albert Fisher, Plc., “*P-Plus*” microperforated technology owned by Print Pak and “*Vitalis film*” micro-perforated film by CFS, Suisse are best examples of microporous film technology used commercially for packaging. Films with pores or small holes have some physical limitations. Carbon dioxide (CO<sub>2</sub>) diffuses through plastic films 2-6 times faster than oxygen (O<sub>2</sub>). Therefore, CO<sub>2</sub> exits a package much faster than O<sub>2</sub> enters.



These films allow the development of an elevated CO<sub>2</sub> environment while maintaining moderate O<sub>2</sub> levels. Thus, these films are applicable only for those vegetables that tolerate high CO<sub>2</sub> without experiencing injury. Most vegetables are tolerant to high CO<sub>2</sub>. In fact, asparagus, broccoli, Brussels sprout, cabbage, celery and some other vegetables are benefited by high CO<sub>2</sub>. Micro perforated films also maintain high relative humidity and are very effective in prolonging the shelf life of above mentioned vegetables. Microporous membranes can also be used in conjunction with flexible films and the best example of this technology is the FreshHold<sup>®</sup> patch. The microporous membrane is placed over an oxygen impermeable film with a large holes. All gas exchange in the package then occurs through the microporous membrane. The membrane has very small pores of which are made by incorporating calcium carbonate or silica into the membrane during the manufacturing process. The micropores are not aligned and gases must diffuse into the matrix of the membrane, where they may diffuse quickly across the small pores. The OTR of the membrane patch can be changed by altering its gauge or by altering the size and number of micropores present. Micropore technology is very effective in creating atmospheres elevated in carbon dioxide and moderate in oxygen concentration.

Macroperforated films are packages with larger holes approximately the size of pin holes. These type of packages are an excellent way to control water loss and not significantly alter O<sub>2</sub> or CO<sub>2</sub> concentrations within a package.

### **9.9.3. Antifog Properties**

Condensation of water inside the package can often occlude the view of the product which reduces consumer appeal. Antifog compounds have been developed that, when included in co-extruded films, migrate to the inner surface of the film and prevent large water drops from forming. This results in more attractive package and better view of the product. However, antifog coatings can interfere with seal integrity and so newer technology relies that antifog material should be applied only on selected areas of the film which is away from the seal.

#### **9.9.4. Films with antimicrobials**

In recent years, attention has been focused on the development of packaging materials containing antimicrobial substances. The idea is to have films or packaging materials that will play an active role in reducing the growth of microbes that cause spoilage and food borne illness. Mostly porous salts of silver with zeolite are incorporated with films as antimicrobial agents. Also, sorbic anhydride, bacteriocin and natural antioxidants are incorporated with film so as to control/minimize the proliferation of specific microorganisms. A “Zeolite film” manufactured by Mitsubishi Corporation, Japan and a “Kontroll film” developed by Kontek, Italy has significantly reduce microbial populations on contact. However, a number of hurdles exist which impede the long-term success of this technology, which includes that film will only be effective where it actually touches the product. Moreover, regulatory and food safety issues exist regarding the migration of these antimicrobial compounds into the foodstuff.

#### **9.9.5. Packaging material with functional filters**

Recently packaging materials are incorporated with cost effective inorganic/organic filters. The filters such as mica, silica, titanium dioxide, aluminum oxide, potassium permanganate, starch and soya protein isolates were added at different concentration levels with LDPE and ULDPE films and converted into films of 75 micron thickness. The addition of filters has significantly improved the performance and barrier characteristics of the LDPE and ULDPE films.

#### **9.9.6. Customized packaging material**

A new class of membranes which create modified atmospheres within packages and assure that the product will not use up all the oxygen in the package and become anaerobic, even if temperature is not well maintained. These membranes, developed and patented by Landec Corporation of Menlo Park, CA, are called Intellimers<sup>®</sup> or smart films. Commonly used films have a preset OTR, and if a product is temperature abused, then oxygen within the package is consumed faster than it can permeate in. This leads to off flavour and odour development, as well as an increased risk of food borne illness due to toxin production by anaerobic microbes. Landecs' Intellimer<sup>®</sup> can be manufactured with a preset temperature switch which increases gas permeability (OTR) of the membrane by one

thousand fold when temperatures rise above the set temperature limit, thus avoiding anaerobiosis.

### **9.9.7. Shrink wrap**

One of the newest trends in fresh produce packaging is the shrink wrapping of individual produce. The greatest advantage of individual shrink wrapping is its ability to control moisture loss. By reducing the transpiration rate and maintaining the fruit firmness, the film forms a barrier which increases the resistance to water vapour. The transpiration rate can be reduced 5 to 20 times using selective permeable plastic films. The individual fruit is first loosely sealed in a flexible film and then shrunk tightly around the produce by passing these packs through a heat shrunk tunnel where they are exposed to hot blown air for a very short period (few seconds). The fresh produce is then cooled by rapid ventilation. The films most commonly used are LDPE or ULDPE. Some of very highly perishable vegetables like lettuce and cucumber have shown increase in shelf life by shrink wrapping.

### **9.9.8. Scavengers (Carbon dioxide, Oxygen, Ethylene)**

Many commodities are physiologically damaged when they are exposed to elevated levels of carbon dioxide or ethylene. Traditionally, ethylene and carbon dioxide absorbers have been incorporated into packaging systems as a sachet. Currently, there is an effort to safely incorporate ethylene and carbon dioxide absorbers directly into boxes, packing trays and films to protect produce from physiological disorders during distribution and handling. An example is a product called Peak Fresh<sup>®</sup> which is a PE film impregnated with mineral particles, with the reported ability to absorb ethylene. In ethylene scavenging system, potassium permanganate-silica gel matrix placed in a sachet is being used to remove ethylene. 'Friss pack' is a paper incorporated with potassium permanganate for use in CFB boxes (Trimbach verpakking, Netherlands). Activated charcoal impregnated with a palladium catalyst and placed in proper sachets effectively removes ethylene by oxidation from packages of minimally processed broccoli and spinach. For oxygen scavenging, sachet containing ferrous salt and NaCl is used to remove oxygen from the headspace. Mitsubishi Gas Chemical Company was the first to launch ferrous-based oxygen scavenger sachets under the trade name 'Ageless' and till date they are regarded as the pioneer in the oxygen scavenging technology. Recently, films incorporated with reactive dyes and

ascorbic acid/organic chelator/free radical species have been developed. For moisture scavenging, films incorporated with propylene glycol or diatomaceous earth and for carbon dioxide scavenging/generating system, sachet containing ferrous with calcium hydroxide have been developed. However, these films are not produced on large scale and there is limited technical information available on this aspect.

### 9.10. *Do's and Don't of MAP*

- Use MAP only in combination with refrigeration
- Do not use MAP on overripe or senescent produce
- Do not use MAP on decayed or injured produce
- Do not package mushrooms in MAP due to risk of *Clostridium botulinum*

### 9.11. Future Research Needs

To utilize MAP technology for wide range of fresh produce, it is necessary to generate some additional information which is:

- Film permeability data at realistic temperatures between 0 and 20°C and realistic RH's between 85 and 95%
- Respiration rates of fresh and prepared produce under several temperature and MAP conditions
- Data on the synergistic effects of elevated levels of CO<sub>2</sub> and information on how any residual effects of MAP may alter a commodity's response to subsequent storage in air
- Data on the RQ (respiratory quotient, i.e. the ratio of CO<sub>2</sub> produced to O<sub>2</sub> consumed)
- Data on the diffusion resistance of various commodities under different atmospheric and temperature conditions.

## CHAPTER 11

# ETHYLENE AND RIPENING

---

### 1. ETHYLENE

Ethylene ( $C_2H_4$ ) plays a role in the postharvest life of many horticultural crops- often deleterious, speeding senescence and reducing shelf life and sometimes beneficial, improving the quality of the product by promoting faster, more uniform ripening before retail distribution. The important role of ethylene as a plant growth regulator has only been established over the last 50 years but its effects have been known from centuries.

Ethylene is a colourless, odorless gas with a faint sweetish smell that exists in nature and also created by man made sources. Solubility of ethylene in water is 20 mg/lit at 20°C and 250 mg/lit at 0°C. Not easily detectable, it exists where produce is stored. In nature, the largest producers are plant and plant products (i.e. fruits, vegetables and floral products) which produce ethylene within their tissues and release it into the surrounding atmosphere. It is also a by-product of man-made processes, such as an exhaust gas from petrol combustion engines.

Ethylene, also known as the 'death' or 'ripening hormone' plays a regulatory role in many processes of plant growth, development and eventually death. Fruits, vegetables and flowers contain receptors which serve as bonding sites to absorb free atmospheric ethylene molecules. The common practice of placing a tomato or banana in a paper bag to hasten ripening is an example of the action of ethylene on produce. The overall effect is to hasten ripening, aging and eventually spoilage.

## 2. HOW THE ROLE OF ETHYLENE WAS DISCOVERED

As is so often the case in science, the discovery of the role of ethylene was made by accident. Illuminating gas used in the 19<sup>th</sup> century for lighting street lamps in Europe contained added ethylene so the lamps burnt with a yellow flame. It was observed that plants growing near any leaky pipes showed some strange growth patterns such as premature leaf fall and death of their flowers. In 1901, a Russian graduate student, Neljubow, was the first to demonstrate that it was ethylene that caused the unusual growth pattern (dwarf stem, fat stem, agravitropism in stem) of pea seedling exposed to illuminating gas. In another study, the role of ethylene was made accidentally. Lemon growers would store newly harvested green lemons in sheds kept warm by kerosene stoves until they turned yellow and ripened enough to market. When new modern heating systems were tried, the lemons no longer turned yellow on time. Research soon found that the important factor in the ripening process was small amounts of ethylene gas given off by the burning kerosene in the heaters. In the early 1930s, a British researcher observed unusual growth deformities in shoots on potato tubers enclosed with same ripe apples. He concluded that apple produced ethylene gas as they ripened. It was soon shown that there was a tremendous increase in the amount of ethylene production by ripening fruits. This increase was accompanied by a similar increase in fruit respiration, a phenomenon which was called 'the climacteric'. In 1959, Burg and Thimann, rediscover old research and begin studies showing ethylene as possible hormone.

## 3. ETHYLENE BIOSYNTHESIS

It was nearly 60 years before researchers finally established the biochemical pathway by which ethylene is produced in plants (Fig. 1).

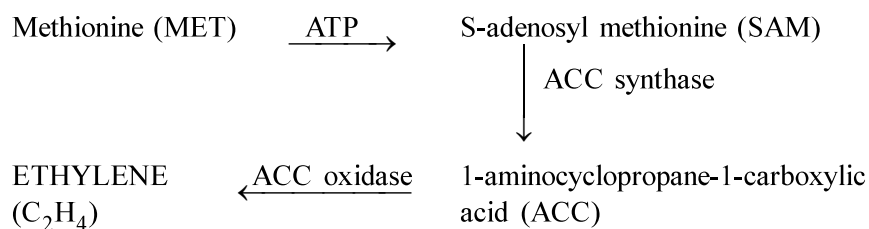


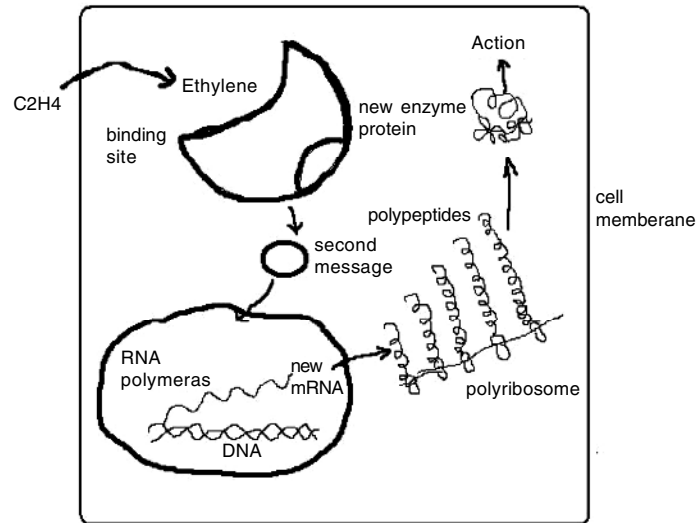
Fig. 1: Pathway of ethylene biosynthesis (Redrawn from Yang, 1987)

The pathway starts with a common amino acid, methionine (**MET**), which is energized by ATP to produce S-adenosyl methionine (**SAM**). The key enzyme in the pathway, ACC synthase, converts SAM to 1-aminocyclopropane-1-carboxylic acid (**ACC**), the immediate precursor of ethylene. Quite recently researchers purified the final enzyme in the pathway, ACC oxidase, which converts ACC to ethylene. The determination of this pathway is very important, because it has led to the discovery of the DNA sequences (genes) that direct the synthesis of the important enzymes, ACC synthase and ACC oxidase. The most elegant demonstration of the importance of ethylene in ripening has used molecular engineering of tomatoes. When the key enzyme of ethylene synthesis, ACC synthase, was removed from tomato fruits using molecular techniques, the fruits no longer ripened unless they were treated with ethylene gas. In climacteric fruits, the ACC content were very low but a massive increase occurred at the time vigorous ethylene production commenced, which accompanied the ripening process. It should be noted that the application of ACC to intact climacteric tomato fruit significantly enhances the ripening process, suggesting that the slight increase in ethylene production caused by the application of ACC may be enough to trigger the ripening process. Intact immature tomato and cantaloupe fruits were treated with ethylene for short period (6-12 hr) and observed that such a short ethylene treatment markedly increases the capacity to convert ACC to ethylene but failed to cause a significant increase in ACC content. Thus application of exogenous ethylene induced the synthesis of EFE enzyme before the synthesis of ACC synthase.

Researches have long been puzzled as to how a molecule as simple as ethylene might have such powerful and specific effects in plants. Early experiments suggested that ethylene was attached to some large molecule in the plant and this attachment was prevented in the presence of increased CO<sub>2</sub> concentration (above 1%) or reduced O<sub>2</sub> concentration (below 8%). A simple scheme that explains many features of the action of ethylene in plants is shown in Fig. 2.

The favoured model is that ethylene binds to a protein, called a binding site (receptor) at the cell membrane, and the binding results in the release of a so-called “second message” instructing the DNA to mRNA (messenger RNA) molecules specific for the effect of ethylene. This

second message then migrates to the cell nucleus, and causes changes in the readout of the DNA. The new messenger RNA molecules that are synthesized attach to “polyribosomes” and make the polypeptides that form the enzymes that bring about ethylene induced actions, including ripening.



**Fig. 2 : Mechanism of ethylene action in plant cells (Source: Kadar 1992)**

In recent years, we have developed ways to manipulate this pathway of ethylene action by interfering with the binding site. Controlled atmosphere storage, by reducing the O<sub>2</sub> concentration and increasing the CO<sub>2</sub> concentration, inhibits the binding of ethylene to the binding site. Low concentrations of ionic silver, usually applied as silver thiosulfate, apparently prevent ethylene from attaching to the binding site. A volatile compound 1-methylcyclopropene (1-MCP) acts in the same way as silver thiosulfate, but only minute amounts (parts per billion) are required to completely prevent the action of ethylene. Similarly 2, 5, norbornadiene (170 µ liter/liter) also inhibit ethylene action in competitive fashion. When norbornadiene (1000 µ liter/liter) was applied to green tomatoes, all fruit remain green during the 2 week experimental period, whereas those which received no norbornadiene ripened with in 5 days. When the ethylene was applied to those norbornadiene treated green fruit, the ripening process



was accelerated, indicating that ethylene was capable of counteracting the norbornadiene action, as expected for competitive inhibition.

#### 4. ETHYLENE PRODUCTION AND SENSITIVITY

Ethylene, the simplest of the organic compounds affecting the physiological processes of plants, is a natural product of plant metabolism and is produced by all tissues of higher plants and by some microorganisms. As a plant hormone, ethylene regulates many aspects of growth, development, senescence and is physiologically active in trace amounts (less than 0.1 ppm). It also plays a major role in the abscission of plants organs. Ethylene production rates increases with maturity at harvest, physical injuries, disease incidence, increased temperature upto 25°C and water stress. On the other hand ethylene production rates by fresh horticulture produce can be reduced by low temperature storage, by elevated carbon dioxide level and by reduced oxygen level around the produce. Exposure of climacteric fruits to ethylene advanced the onset of irreversible rise in respiration rate and rapid ripening. Various packages can delay the onset of climacteric and prolong shelf life of fruits by reducing ethylene production and sensitivity. Even non-climacteric vegetables can benefit from reduced ethylene sensitivity and lower respiration rate under various conditions. The vegetables differ in their ethylene production rates is given in Table 1.

**Table 1: Classification of vegetable crops according to ethylene production rates (Source : Keys and Beaudry, 1987)**

| Class     | (mil C <sub>2</sub> H <sub>4</sub> /kg-hr at 20°C (68°F)) | Commodities  |
|-----------|---|--|
| Very low  | < 0.1   | Artichoke, asparagus, cauliflower, leafy vegetables, root vegetables, potato   |
| Low       | 0.1-1.0   | Cucumber, eggplant, okra, watermelon, chilli, bell pepper, pumpkin, watermelon |
| Moderate  | 1.0-10.0  | Tomato, hoeydew melon  |
| High      | 10.0 – 100.0  | cantaloupe   |
| Very high | > 100.0   | –  |

## 5. WHAT IS RIPENING?

Ripening is a dramatic event in the life of a fruit, in which structure and composition of unripe fruit is so altered that it becomes acceptable to eat. Ripening makes the completion of development of a fruit and the commencement of senescence and it is normally an irreversible event.

In many fruits, ripening is associated with rapid increase in respiration rate. This upsurge, called the “climacteric” is often described as a turning point in the life of the fruit. The climacteric may occur either before or after the fruit is plucked.

## 6. CATEGORIES OF FRUITS

There are two classes of fresh produce in terms of ethylene production. There are climacteric products, mainly fruit that produce a burst of ethylene as they ripen, as well an increase in respiration and there are the non-climacteric products that do not increase ethylene production when they ripen (Table 2). The more obvious way of establishing which class a product fits into is whether or not the product ripens after harvest. Products that ripen after harvest are classed as climacteric and they typically ripen by softening significantly, by changing colour and become sweeter, examples are tomato. A few climacteric fruits, such as muskmelon, will not increase in sugar content during ripening, but will soften. Non-climacteric fruits do not change significantly after harvest and will not respond to ripening with ethylene gas. They will soften a little, lose green colour and develop rots as they become old but they do not change to improve their eating characteristics.

**Table 2: Classification of vegetables according to respiratory behavior during ripening.**

| <b>Climacteric (Ethylene producing)</b> | <b>Non-climacteric (Non ethylene producing)</b>   |
|---|---|
| <b>Vegetables:</b> Tomato, muskmelon    | <b>Vegetables:</b> Eggplant, cucumber, okra, pea, bell pepper, summer squash, watermelon, leafy vegetables etc. |

## 7. HOW FRUIT RIPENS?

The essential elements in the fruit ripening complex might be considered to be (i) respiratory increase during ripening (ii) the synthesis or formation of new sets of enzymes and (iii) the action of these enzymes in bringing about the changes characteristics of ripening such as softening, pigmentation and quality changes in the fruits.

However, the ability of a fruit to become ripe is closely related to action of endogenous hormones. The autocatalytic production of endogenous ethylene is considered to immediately trigger off the ripening process in climacteric fruits. These fruits produce large amount of ethylene once ripening is underway. There is mounting evidence that other plant hormones may also be involved in the regulation of fruit ripening. Auxin, Gibberellins and Cytokinins retard ripening wholly or in part. It appears that auxin declined at about the time that the level of endogenous ABA (abscissic acid) begins to increase. Two enzymes, indol-acetic acid oxidase and peroxidase, which have a potential for breaking down the native auxin, increase in several fruits during ripening. At this critical period, in natural ripening, the internal level of ethylene and ABA increase and application of either of these hastens the onset of ripening.

## 8. METHODS FOR ARTIFICIAL RIPENING

### 8.1. Ripening with Calcium Carbide

Calcium carbide (commonly known as 'Masala'), a grayish solid, is readily produced by heating calcium oxide with charcoal under reducing conditions. When hydrolyzed, calcium carbide produces acetylene, containing trace amounts of ethylene that are sufficient to be used in fruit ripening. Calcium chloride is usually kept in small paper packets inside the boxes of climacteric fruits and the whole package is kept in closed space for a day or two. Water vapor from the fruit when comes in contact with calcium chloride releases sufficient quantity of ethylene which causes ripening. However, the fruits ripened with calcium carbide are overly soft, less tasty with a short shelf life. In addition, it is very dangerous to handle calcium carbide and acetylene because of its explosive properties and health hazards. The fruits ripened with calcium carbide are reported to

cause mouth ulcers, gastric irritation and even food poisoning after consumption. Moreover, the calcium chloride is so reactive that it causes blisters, if touched unknowingly with wet hands. The low price of calcium carbide results in their indiscriminate use in artificial ripening of banana, mango and other fruits. This practice is banned in the US under the act 44-AA of Prevention of Food Adulteration (PFA) Act. 1954 with PFA rules 1955, due to health reasons.

## 8.2. Ripening with Ethephon

Ethephon (2-chloroethane phosphonic acid) is strongly acidic in water solution. When in solution above a pH of about 5, the ethephon molecules spontaneously hydrolyses, liberating ethylene. The amount of ethylene will increase as pH and/or relative humidity increases. Ethephon is commercially available (Ethrel, Florel, cepa) and used for enhancing postharvest ripening. It has to be applied to the fruit in a water solution as a spray or as a dip. After ethephon treatment, water left on fruit surface needs to be evaporated otherwise there is danger of microbial infection at later stages and then store these fruits at temperature of 18-25°C, which is considered optimum temperature for fruit ripening depending on fruit kind and maturity stage. Ethephon is approved for postharvest use on number of vegetables (Table 3). This is safe and effective method of ripening of fruits compared to the conventional technique of using calcium carbide.

**Table 3: Approved uses for ethephon (2-chloroethane phosphonic acid) in US agriculture. (Source: Kays and Beaudry, 1987)**

| Use                           | Approved vegetable crops<br>(*Approved in some states of USA) |
|-------------------------------|---|
| Post-harvest fruit ripening   | Tomatoes*   |
| Pre-harvest fruit ripening    | Peppers, tomatoes   |
| Fruit loosening               | Cantaloupes   |
| Maturity or color development | Peppers, tomatoes.  |
| Sex expression                | Cucumber, squash  |

### **8.3. Ripening with Ethylene Gas (Internationally acceptable technique)**

In this technique, the fruits are exposed to low level of ethylene gas (100-150 ppm) in an air-tight ripening chamber for 18 to 72 hours so as to induce ripening. Air-tight rooms should be opened and completely aired at 12 hours interval to prevent accumulation of carbon dioxide, which reduces the effectiveness of ethylene. While rooms are closed, internal fan should be used to ensure uniform distribution of ethylene. The most important thing in this technique is temperature and relative humidity control inside the ripening chamber, which should range between 18-25°C and 90-95% RH depending upon the fruit kind and maturity stage. Carbon dioxide concentration should be less than 4% (approx 1 room exchange/hr). Air circulation should be sufficient (about 0.1 to 0.2 ft<sup>3</sup> per min per lb product) to ensure distribution of ethylene within ripening room. Several methods are used to provide proper ethylene concentration in the ripening room.

#### **8.3.1. Ethylene generator**

Ethylene generator, in which a liquid produces ethylene when heated in the presence of a catalyst, is now widely used for supplying ethylene in the ripening rooms (Fig. 3). The liquid used is ethyl alcohol which is passed over a bed of activated alumina. Generators convert ethyl alcohol to ethylene and water in the presence of heat and a catalyst. However, only a manufacturer formulated concentrate can be used in currently available generators. Ethylene from generators is slowly released and does not reach dangerous concentrations when used as suggested by the manufacturer. The cost of operating generators is relatively high due to the cost of concentrate, frequency of room ventilation to remove carbon dioxide and the compulsion of operators to use excess amount of the concentrate. Now portable ethylene generators with gas analyzer are available in which the desired gas concentration can be fixed according to the requirement.

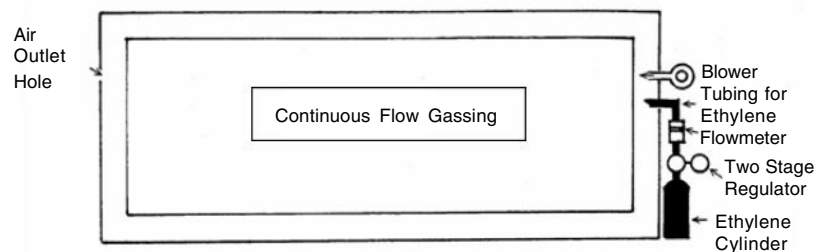
#### **8.3.2. Flow - thru or trickle method (ethylene cylinder)**

Ethylene is available in large steel cylinders where it is stored under pressure. Because, it is highly flammable, the use of pure gas is discouraged. Therefore, it is usually diluted with nitrogen or other inert gases. Typical mixtures are 95% nitrogen and 5% ethylene or 95.5% nitrogen and 4.5% ethylene.



**Fig. 3: Portable Ethylene Generator**

Ethylene is blended with outside air to a concentration of 100-150 ppm and this mixture is passed through the ripening room. The ethylene is introduced into the room continuously. As the flow of ethylene is very small, it has to be regulated carefully. This is done by reducing the pressure using a two stage regulator and passing the gas into the room through a metering valve and flow meter. Air is provided in the ripening room by a small blower type fan mounted over a two inch diameter opening through the wall into the ripening room (Fig. 4). The flow of ethylene is blended with air at this location. Another two inch hole should be cut in the wall opposite to the blower to allow air passage out of the room (Fig. 4).



**Fig 4: Continuous flow ethylene gassing (Source: Kasmire, 1981)**

To prevent build up of either  $\text{CO}_2$  or  $\text{C}_2\text{H}_4$ , fresh air is drawn into the ripening room at a sufficient rate to ensure a change of air every 6 hours. This concentration of ethylene is sufficient to initiate ripening and changing the air within the room each 6 hours keeps the carbon dioxide below 2%. A higher air rate would further reduce the carbon dioxide level but would require additional ethylene. The larger ripening rooms in Florida are 15,000 cu. ft. The air and ethylene rate for this size room would be 41.7 cubic feet per minute (CFM) and 177 cc/min respectively.

**Rate of air and ethylene needed for any given room size can be calculated by use of the following formula:**

$$\text{Air (Cubic Feet per minute)} = \frac{\text{Room size (cu. Ft.)}}{\text{Frequency of air change (minute)}}$$

$$\text{Ethylene (cc/min)} = \text{Air (CFM)} \times V_c \times C$$

Where :

$$V_c = 28.320 \text{ (conversion of cu. ft. to cc)}$$

$$C = \text{desired concentration (150 ppm} = 0.00015)$$

**Example:** if the ripening room contained 10,000 cu. ft. the rate to change the air once in 6 hr would be:

$$\frac{10000}{6 \text{ hrs} \times 60 \text{ min}} = 27.8 \text{ CFM}$$

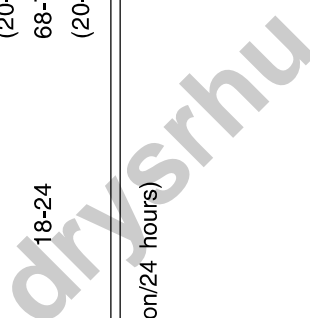
Ethylene required for 150 ppm would be:  $27.8 \times 28.320 \times 0.00015 = 118 \text{ cc/min}$

With this method of application, only a very small amount of ethylene is used and the respired carbon dioxide is maintained at about 1.57%. The room need not be opened for aeration, but can be entered at any time for inspection of the fruit. This is the most economical system currently available. Economic benefits arise both from the very small amount of ethylene required and the faster ripening initiation rate caused by the lack of carbon dioxide inhibition. With a faster initiation rate, a greater volume of tomatoes can be ripened with the existing room capacity. Decreasing the time for ripening initiation by only one day would substantially reduce the energy requirement.

**Table 4: Typical produce storage and ripening temperatures for vegetables that can be ripened (Source: Thompson, 1994)**

| Commodity | Respiration<br>(mg CO <sub>2</sub> / kg-hr) | Ethylene<br>conc.(ppm) | Ethylene<br>exposure<br>time (hr.) | Ripening<br>temp.<br>°F (°C) | Storage<br>temp.<br>°F (°C) | Specific<br>heat<br>Btu/lb-F |
|-----------|---|------------------------|------------------------------------|------------------------------|-----------------------------|------------------------------|
| Tomato    | 24-44                                       | 100-150                | 24-48                              | 68-77<br>(20-25)             | 50-55<br>(10-13)            | 0.95                         |
| Muskmelon | 20-27                                       | 100-150                | 18-24                              | 68-77<br>(20-25)             | 45-50<br>(7-10)             | 0.94                         |

Multiply by 220 to obtain heat to respiration (BTU/ton/24 hours)





### **8.3.3. Shot method**

Placement of ethylene in the ripening room or transport vehicle, which is then closed for a period of time. Short method is further of three types.

#### **8.3.3.1. Tank weight**

This is the most widely used shot method in Florida. A cylinder of ethylene is secured on a balance and weighed gas is released into the ripening room. Injection ports are provided for metering ethylene into the ripening rooms, but these ports are often not used because they restrict the rapid flow of ethylene. Tank-weighting and rapid application, which bypasses tie injection port, can be dangerous.

#### **8.3.3.2. Lecture bottle or refillable small tank**

These containers of ethylene are placed in the ripening room and their entire contents allowed to escape in the room over a period of a few minutes. This method is more costly and filling the tanks with the proper amount of ethylene is very difficult.

#### **8.3.3.3. Slow release**

Ethylene is released at a very slow rate by means of a pressure regulator and flow meter. For example, if 4 cubic feet of ethylene are needed, the gas will be allowed to flow for 8 minutes at a rate of 1/2 cu. ft. (cubic foot) per minute. This method is more accurate than other shot methods.

### **8.3.4. Use of Fruits**

A simple way to ripen fruits at home in small amounts is to use a ripening bowl. Fruits that require ripening like tomato (green) should be placed into the bowl with a ripe apple or ripe banana (or any other high ethylene-generating product). The bowl should have ventilation holes around the top. Using this method, ripening will take from one to four days. Home ripening is also possible using another, extremely low cost technique i.e. placing fruits to be ripened into a paper bag with a ripe piece of fruit, close loosely and check in a few days.

## 9. WHICH METHOD OF ETHYLENE APPLICATION TO USE?

The source of ethylene used by handlers normally is determined by the facilities for treatment, legal consideration, cost and safety. The use of ethylene gas requires some type of enclosure. The cost of building special ripening facilities with precise temperature and relative humidity control is well justified when repeated ethylene applications are required. Each handler also must consider the legality of ethylene application. Ethylene gas used for plant regulation such as colouration or ripening of fruit and vegetables is regarded legally as a pesticide for regulatory purposes (United States Congress, 1978).

## 10. OPTIMUM CONDITIONS FOR RIPENING INITIATION

- Storage room should be fairly air-tight for maintaining the desired atmosphere. Enclosures range from inflated plastic to permanent ripening rooms fabricated from aluminum-clad urethane panels.
- **Temperature :** Room temperature maintained at 18 to 25°C and 90 - 95% relative humidity.
- **Duration of Treatment:** Exposure to ethylene for 24 to 72 hours depending upon fruit kind and maturity stage. Larger tomato fruits require less time and frequently don't benefit from an exposure period as ripening has already been initiated. Smaller fruits and the less mature ones, may require an exposure period greater than 48 hours.
- **Ventilation:** Carbon dioxide concentrations of less than 4% (approx 1 room exchange/hr) normally 1.57-2.0%. Air-tight rooms should be opened and completely aired at 12-hour intervals to prevent accumulation of carbon dioxide, which reduces the effectiveness of ethylene.
- **Ethylene Concentration:** Ethylene @ 100 to 150 ppm if carbon dioxide levels are controlled. While rooms are closed, internal fans should be used to insure uniform distribution of ethylene.
- **Air circulation:** Air circulation should be sufficient (about 0.1 to 0.2 ft<sup>3</sup> per min per lb product) to ensure distribution of ethylene within the ripening room.

## 11. DAMAGING EFFECT OF ETHYLENE

The presence of ethylene is not always beneficial, especially in terms of postharvest shelf life. The degree of damage depends upon the concentration of ethylene, length of exposure time and product temperature. For example, yellowing of cucumbers can result from exposure to 1 ppm ethylene for 2 days or to 5 ppm ethylene for ½ day at 10°C. The effect of ethylene is accumulative, so continuous exposure to a low concentration of ethylene throughout marketing can cause significant harm. However, the loss of shelf life will be most frustrating for the final consumer as the loss of quality will not be obvious during marketing and retail sale. Removal of ethylene from the storage and shipping environment retards spoilage, reduces losses and increases profit. Specific example of detrimental effect of ethylene on postharvest quality of vegetables is included in Table 5.

**Table 5: Detrimental effects of ethylene on postharvest quality of vegetables (Source: Kader, 1994).**

| Commodity        | Symptoms of Ethylene injury   |
|------------------|---|
| Asparagus        | Increased lignification (toughness) of spears.                                    |
| Snap beans       | Loss of green colour  |
| Broccoli         | Yellowing, abscission of florets  |
| Cabbage          | Yellowing, abscission of leaves   |
| Carrot           | Development of bitter flavour   |
| Cauliflower      | Abscission and yellowing of leaves  |
| Cucumber         | Yellowing and softening   |
| Brinjal          | Calyx abscission, browning of pulp and seeds, accelerated decay                   |
| Leafy Vegetables | Loss of green colour  |
| Lettuce          | Russet spotting   |
| Parsnip          | Development of bitter flavour   |
| Potato           | Sprouting   |
| Sweet Potato     | Brown flesh discolouration and off flavour detectable when cooked.                |
| Turnip           | Increased lignification (toughness)   |
| Watermelon       | Reduced firmness, flesh tissue maceration resulting in thinner rind, poor flavour |

### 11.1. Accelerated Senescence

The major reason for the loss of shelf life is that ethylene exposure increases the rate of senescence. In leafy vegetables (spinach, broccoli, parsley etc.) and cucumbers ethylene stimulates senescence, as indicated by loss of chlorophyll or green colour and thus reducing market quality of leafy, floral and immature fruit vegetables and foliage ornamentals. Exposure of cabbage to 10 or 100 ppm ethylene during holding at 1<sup>0</sup>C for 5 weeks resulted in loss of greenness and extensive leaf abscission, but loss of greenness can occur at even lower ethylene levels (1 to 5 ppm) in some cultivars. Ethylene @ 4 ppm increased the rate of deterioration and yellowing in cabbage, Brussels sprout, broccoli and cauliflower kept in air at 1<sup>0</sup>C. For maximum shelf life and quality, green leafy vegetables should not be stored or transported in trucks where there are mixed loads containing ripening fruit such as apples, pears, mangoes, tomatoes or bananas.

### 11.2. Induction of Physiological Disorders

In many plants, exposure to ethylene results in darkening or death of portion of their leaves. e.g. Lettuce suffers from a distinctive disorder, called russet spotting as a result of exposure to ethylene. The symptoms of russet spotting are dark brown spotting of the mid-ribs of lettuce leaves. Similarly, high ethylene levels in the storage chamber reduce the effectiveness of controlled atmospheres in maintaining quality of stored products.

### 11.3. Isocoumarin Formation

In carrots, ethylene exposure caused the biosynthesis of bitter isocoumarins, which make the carrots bitter. It has been shown that concentrations of ethylene as low as 0.5 ppm can cause bitterness in carrots within 2 weeks of storage even when they are stored at 2.5<sup>0</sup>C.

### 11.4. Sprouting

Ethylene stimulated sprouting which is useful in propagules but undesirable in commodities intended for consumption. Sprouting of potatoes, for

example, is undesirable as it results into sugar accumulation inside the potato.

### 11.5. Abscission of Leaves and Flowers

Ethylene induced abscission is most often a problem in leafy vegetables (cabbage, cauliflower) and ornamental plants, where low concentrations can cause complete loss of flowers or leaves.

### 11.6. Toughening of Asparagus

Ethylene stimulates the lignifications of xylem and fiber elements in the growing asparagus spear, leading to undesirable toughness and reducing the portion of the spear that is edible.

### 11.7. Reduce Firmness

Exposing watermelons to 30 or 60 ppm ethylene reduces firmness and rind thickness, accelerates deterioration and reduces acceptability. Ethylene applied to fresh sweet potato roots resulted in reduced firmness after cooking, but had adverse effect on flavour and colour.

### 11.8. Reduction of Post-harvest Diseases

The effects of ethylene on fungal growth and disease development on harvested vegetables are still unclear. Ethylene was found to stimulate rot development by some fungi. In contrast, ethylene has been shown to induce resistance to certain pathogens in some harvested plant organs. Sweet potato slices exposed to 8 ppm ethylene for 2 days became more resistant to infection by *Ceratocystis fimbriata*. The increased resistance was accompanied by an increase in peroxidase and polyphenol oxidase activities.

## 12. ETHYLENE POLLUTION SOURCES

There are many sources of ethylene pollution during postharvest handling of perishables, but the most important are internal combustion engines, ripening rooms and ripening fruits. Other sources are aircraft exhaust,

fluorescent ballasts, decomposing produce and sometimes fungi growing on it, cigarette smoke, rubber materials exposed to heat or UV light and virus infected plants.

A recent survey that included the wholesale markets, distribution centres and retail stores showed that the concentration of ethylene present during the marketing of fresh produce was between 0.017 and 0.06 ppm. The main sources of ethylene during marketing and retail sale are from other ripening fruits in the market or storage room or from the exhaust gases of vehicles and forklift trucks, refrigeration units, power generators etc. Ethylene levels recorded in packing area are lower, possibly due to better ventilation. However, measurements taken in the receiving area in the presence of motorized machinery registered ethylene level similar to those found in storage rooms. Therefore the two areas in the packing houses where ethylene concentrations may be problem are the receiving area and the actual storage area. The ethylene concentration at different stages of harvesting, storage and packaging is listed in Table 6.

**Table 6: Ethylene concentrations at different stages of harvesting, storage and marketing**

| Sample location         | Range (ppm) | Mean (ppm) |
|-------------------------|-------------|------------|
| Field                   | Trace-0.12  | –          |
| Field to cooler         | 0.13-0.11   | 0.07       |
| Holding before cooling  | 0.01-0.80   | 0.16       |
| After cooling           | 0.01-0.29   | 0.12       |
| Cold storage            | 0.01-2.78   | 0.33       |
| Inside rail cars        | 0.01-0.19   | 0.06       |
| Inside trucks           | 0.04-0.22   | 0.08       |
| Distribution warehouses | 0.03-2.49   | 0.25       |
| Retail storage          | 0.06-2.88   | 0.41       |
| Home refrigerator       | 0.02-1.58   | 0.25       |

### 13. REDUCING THE DAMAGING EFFECTS

A number of techniques have been developed to protect sensitive commodities from the effects of ethylene. Selection of the appropriate

method obviously depends on the commodity and the handling techniques used in its marketing. Removing ethylene from the atmosphere around the commodity is the preferable method of preventing deterioration of ethylene-sensitive produce. Of the available methods, the simplest and cheapest are in many cases the most effective.

### 13.1. Eliminating Sources of Ethylene

Preventing ethylene buildup around the product is often the simplest method of reducing the damaging effects of ethylene. For example products that are sensitive to ethylene are better handled with electric forklifts rather than gas powered ones. Trucks and forklifts should not be left ideal in enclosed spaces or during loading or unloading of products. It is also important to remove over ripe or rotting fruit from the storage and handling area, as they are also sources of ethylene. For ethylene sensitive products it is important to avoid storing them with products that produce high levels of ethylene. Where these techniques are not feasible, it is possible to fit combustion engine exhausts with catalytic converters, which will reduce ethylene emissions by 90 percent.

### 13.2. Ventilation

Increasing the ventilation rate of the storage area, assuming that the outside air is ethylene free is another way of reducing the level of ethylene around fresh produce. An exchange rate of one air change per hour can readily be provided by installing an intake fan and a passive exhaust. Ripening room venting should never be done by opening the doors.

### 13.3. Chemical Removal

Ethylene can be removed by a number of chemical processes; the most important are described below:

#### 13.3.1. *Potassium Permanganate*

Commercial materials, such as Purafil, utilize the ability of potassium permanganate ( $\text{KMnO}_4$ ) to oxidize ethylene to carbon dioxide and water. In order to scrub the air efficiently it is best to spread the potassium

permanganate over a larger surface area as possible either in trays or within highly permeable bags. Many porous materials have been used to manufacture permanganate absorbers, including vermiculate, pumice and brick. The type of material may depend on the purpose for which the absorber is required. Attempts to develop liquid scrubbers using  $\text{KMnO}_4$  have been unsuccessful.

### **13.3.2. Activated or brominated charcoal**

Charcoal air purifiers, especially if brominated, can absorb ethylene from air. These systems are largely confined to use in the laboratory, as potassium permanganate absorbers are cheaper and more widely available.

## **13.4. Ultraviolet Lamps**

The commercial cold stores are now using ultraviolet lamps to absorb ethylene. Ultraviolet lamps produce ozone which was thought to be the active ethylene removing agent. Whatever the mechanism, the ozone produced by the lamps is very toxic to fresh produce and must be removed.

## **13.5. Catalytic Oxidizers**

If ethylene and oxygen are combined at high temperature in the presence of a catalyst (such as platinized asbestos) the ethylene will be oxidized. Ethylene scrubbers utilizing this effect are now available commercially and overcome the difficulty of heating the incoming air, by clever use of a bed of ceramic used as a heat sink, and reversible flow of gas through the bed. These scrubbers are very efficient, reducing the ethylene concentration in the air to 1 percent of the input concentration. Because of the small air volume they process, they are most suited to small spaces or long term CA storage systems.

## **13.6. Bacterial Systems**

Tons of ethylene is liberated into the atmosphere each day from internal combustion engines, but the concentration of ethylene in air remains very low (nearly undetectable in fresh rural air). This implies that something removes ethylene from the atmosphere. Bacteria that use ethylene as a



biochemical substrate have been isolated from soils. It seems possible that a scrubber may be developed in which the bacteria grow at the expense of ethylene in the store atmosphere.

### 13.7. Specific Antiethylene Compounds

In cut flowers, it is possible to pulse the stems with a solution of silver thiosulfate. The flowers take the solution up through their stems and this protects them from the effects of ethylene. There is another relatively new gaseous compound called “EthylBloc” that inhibits the effects of ethylene. It is effective at very low concentrations, as low as 10 parts per billion (ppb). The active ingredient is 1-MCP (1-methylcyclopropene). EthylBloc can be used for treatment of flowers but is currently not registered for use on food crops, however registration is in progress.

## CHAPTER 12

# STORAGE

---

The management of temperature and relative humidity are the most important factors determining storage life of vegetable crops. The natural means like ice, cold water, night temperature have been used for long time for protecting food materials from spoilage and these are still common. However, with the development of innovative technologies, it is possible to achieve optimal environments in the insulated stores. In India, onion, garlic and potato are important vegetable which need long period of storage in large quantity.

### 1. GOALS OF STORAGE

- To meet the demand of fresh vegetables throughout the year.
- To reduce waste during glut season and to avoid the low price during peak season.
- To extend the processing season of some commodities.
- To provide planting material when needed.
- To slow biological activity of product by maintaining the lowest temperature.
- To slow growth and spread of microorganisms.
- To reduce product moisture loss.

If produce is to be stored, it is important to begin with a high quality produce. The lot of produce should not contain damaged or diseased units, and containers must be well ventilated and strong enough to withstand

stacking. Damaged produce will lose water faster and have higher decay rates in storage as compared to undamaged produce. In general, proper storage practices include temperature and relative humidity control, air circulation and maintenance of space between containers for adequate ventilation and avoiding incompatible produce mixtures.

## 2. UNDESIRABLE EFFECTS ON VEGETABLES DUE TO SHARING OF SAME STORAGE AREA

To optimize storage conditions, not more than one crop should be stored in the same room, unless this is for a short period of time. Sharing the same storage area can result differences in temperature and relative humidity conditions; chilling and ethylene sensitivity; odor contamination and other problems affecting shelf life and quality.

### 2.1. Chilling Injury

Many vegetables of tropical or subtropical origin are sensitive to low temperature. These crops are injured after a period of exposure to chilling temperature below 10 to 15 °C but above their freezing point. Various physiological and biochemical alterations and cellular dysfunctions occur in chilling-sensitive species in response to chilling stress. When chilling stress is prolonged, these alterations and dysfunctions will lead to the development of a variety of chilling injury symptoms such as surface lesions, internal discoloration, water-soaking of the tissue and failure to ripen normally. Often, products that are chilled will still look sound when remains in low temperature. However, symptoms of chilling injury become evident in a short time after they are removed to warmer temperature. Vegetables that have been chilled may be particularly susceptible to decay. Weak pathogens such as *Alternaria* spp. that do not grow readily on healthy tissues can attack tissues which have been weakened by low temperature exposure.

Both temperature and duration of exposure are involved in the development of chilling injury. Damage may occur in a short time if temperature is considerably below the threshold level, but a product may be able to withstand temperature a few degrees in the critical zone for a longer time before injury becomes irreversible. The symptoms of chilling injury in some vegetables are given in Table 1.

**Table 1: Chilling injury symptoms of some vegetables**

| Commodity      | Lowest safe temperature (°C) | Chilling injury symptoms  |
|----------------|------------------------------|---|
| Asparagus      | 0-2                          | Dull, grayish, limp tips  |
| Cucumber       | 7                            | Pitting, water soaking, decay   |
| Brinjal        | 7                            | Surface scald   |
| Okra           | 7                            | Discoloration, water soaked area, pitting, decay                        |
| Tomato ripe    | 7-10                         | Water soaking, softening, decay   |
| Mature green   | 13                           | Poor colour when ripe   |
| Watermelon     | 4.5                          | Pitting, objectionable flavor   |
| Cantaloupe     | 2-5                          | Pitting, surface decay  |
| Honeydew melon | 7-10                         | Reddish-tan discoloration, pitting, surface decay, failure to ripen     |
| Bell pepper    | 7                            | Sheet pitting, alternaria rot on fruits and calyxes, darkening of seeds |

## 2.2. Undesirable Ethylene Effects

Ethylene causes a wide range of following damage symptoms in sensitive commodities. Avoid handling or storing ethylene sensitive commodities with ethylene producing ones.

- Accelerated ripening (in climacteric fruits)
- Loss of green colour (snap beans, cucumber, leafy greens)
- Induction of leaf disorders (russet spotting in lettuce, death of leafy greens)
- Isocoumarin formation (bitter taste in carrots)
- Sprouting (potatoes)
- Browning of pulp and/or seeds (eggplant, sweet potato)
- Poor flavour (watermelon, sweet potato)

## 2.3. Odour Contamination

Commodities with a tendency to give off or absorb odors should not be stored together. The list of combinations to vegetables and fruits during

long distance transport and storage are given in table 2 in order to avoid odour contamination.

**Table 2: Odour contamination of selected vegetables**

| <b>Odour produced by :</b>              | <b>Odour absorbed by:</b>          |
|---|------------------------------------|
| Tomato                                  | Cabbage, carrots and onions        |
| Ginger                                  | Brinjal                            |
| Grapes (fumigated with sulphur dioxide) | Other fruits and vegetables        |
| Dry Onions                              | Apples, pears                      |
| Green Onions                            | Corn, grapes, mushrooms            |
| Pears                                   | Cabbage, carrots, onions, potatoes |
| Potatoes                                | Apples, pears                      |
| Green peppers,                          | Pineapples                         |
| Strongly scented<br>vegetables          | Citrus fruits                      |

- Tomatoes being ethylene producer should not be stored with ethylene sensitive products like cabbage, carrot, cauliflower, cucumber, brinjal, okra and peas, otherwise these products are likely to be spoiled.
- The odour of ginger root is absorbed by brinjal. So this storage combination should be avoided.

### **3. REQUIREMENTS AND GENERAL CHARACTERISTICS FOR A STORAGE FACILITY**

Generally, storage facilities are linked or integrated to packhouses or other areas where there is a concentration of product. However, often storage can also be undertaken on-farm, either naturally or in specifically designed facilities. Even under conditions of mechanical refrigeration, location and design have an impact on system operations and efficiency. First, climate is an important factor for the location of the storage facility. For example, altitude reduces temperature by 10 °C for every 1 Km of elevation. It also increases overall efficiency of the refrigeration equipment by facilitating heat exchange with ambient temperature, thereby reducing energy costs. Shading particularly of loading and unloading areas reduces thermal differences between field and storage temperature.

Building design is an important factor to be taken into consideration. For example, a square shaped floor perimeter is thermally more efficient than a rectangular one. The roof is the most important part of the structure as it has to protect produce from rain and radiant heat. Its slope should allow easy fall off of rainwater; its dimensions should exceed the perimeter of the building to protect walls from the sun and provide a dry area around the building in rainy weather. Floors should be of concrete, isolated from soil humidity and elevated to avoid penetration of water. Doors need to be wide enough for mechanized handling.

Storage facilities should be thoroughly cleaned before filling. This includes brushing and washing of walls and floors to eliminate dirt and organic debris that could harbor insects and diseases. Before product is placed in the storage room, inspection and pre-sorting should be undertaken. This is in order to remove all potential sources of contamination for the remaining load. Product should be stacked in such a way that there is free circulation of air. During storage, it should also be possible to carry out quality control inspections. If the storage facility becomes full during a long harvest period, it needs to be organized around the principle of the system “first in first out”.

#### **4. STORAGE SYSTEMS**

1. Refrigerated / low temperature storage
2. Controlled Atmosphere (CA) Storage
3. Hypobaric or Low Pressure (LP) storage
4. Evaporative cool storage (low cost or zero energy)
5. Alternative storage strategies

##### **4.1. Refrigerated/low Temperature Storage**

Controlling temperature is one of the main tools for extending postharvest life as low temperatures slow down product metabolism and the activity of microorganisms responsible for quality deterioration. As a result, reserves in the produce are maintained with a lower respiration rate, ripening is retarded and vapor pressure between produce and ambient is minimized, reducing water loss. These factors contribute towards maintaining freshness

by reducing the rate at which quality deteriorates and the nutritional value of the product is preserved. It is also important to precisely control temperature and relative humidity conditions inside the refrigerated storage environment. The temperature in storage facility normally should be kept within 1°C of the desired temperature for the commodities being stored. Temperature below the optimum range for a commodity cause freezing or chilling injury and temperature above it, shorten storage life.

Mechanical refrigeration has two main components: the evaporator, inside the storage area and the condenser which is outside connected by tubing filled with refrigerant. Normally, both elements are finned coils made of high thermal conductivity materials and integrated to a fan. This facilitates heat exchange. An evaporator is placed in the upper part of one of the walls forcing cold air to flow parallel to the ceiling. Hot air extracted from the produce is forcibly passed through evaporator, transferring it to the coil. A refrigerant absorbs this heat as it changes to gas, cooling the air, which is forced again into the room as cold air. The refrigerant is transported as gas to the condenser (outside of building) where it is transformed again into the liquid form. The internal heat is then released outside. With this repeated cycle, the system behaves like a pump - heat is extracted from the stored produce and then released outside. Another key aspect of the mechanical refrigeration system is the expansion valve, which regulates the evaporation and flow of refrigerant. Ammonia and Freon gas are the most widely used refrigerants. However, they are now being replaced by more environmentally friendly products. Refrigeration equipment must be designed to maintain high relative humidity evaporator coils. Mechanical humidifier having spray nozzles or steam systems are sometimes used to add moisture to the storage room and reduce the drying effect of the evaporator coils. However, this added moisture more frequent deposit on the coils and increasing operating problems.

Every crop has an optimal combination of temperature and relative humidity for storage. In many cases, there are differences even within varieties. As previously mentioned, it is recommended not to store more than one crop in the same room, unless this is for a very short period (less than a week) or during transportation. Very incompatible crops should not be stored in the same room for more than 1 or 2 days.

**Table 3: Appropriate storage conditions (refrigerated) for vegetables:**

| Product                | Temp (°C) | R H (%) | Approx. Storage Life |
|------------------------|-----------|---------|----------------------|
| Cauliflower            | 0         | 95-98   | 3-4 weeks            |
| Cabbage                | 0         | 95-98   | 1-4 months           |
| Peas                   | 0         | 95-98   | 1-2 weeks            |
| Carrot                 | 0         | 95-98   | 3-5 months           |
| Potato (seed)          | 1-2       | 90-95   | 4-8 months*          |
| Potato                 | 10        | 90-95   | 6 months**           |
| Bhindi (Okra)          | 7-10      | 90-95   | 7-10 days            |
| Capsicum               | 7-10      | 90-95   | 10 days              |
| Onion                  | 0         | 65-70   | 3-8 months           |
| Bitter guard           | 12-13     | 85-90   | 10 days              |
| Brinjal                | 12        | 90-95   | 7 days               |
| Tomato (Mature green)  | 13-18     | 85-90   | 2-3 weeks            |
| Tomato (Pink)          | 10-13     | 85-90   | 7-10 days            |
| Tomato (Ripe)          | 7-10      | 85-90   | 3-5 days             |
| Asparagus              | 0         | 95      | 3-4 weeks            |
| Cucumber               | 10-12     | 90-95   | 2 weeks              |
| Garlic                 | 0         | 65-70   | 5-8 months           |
| Lettuce                | 0         | 90-95   | 3 weeks              |
| Muskmelon (honey dew)  | 7-8       | 85-90   | 4 weeks              |
| Muskmelon (cantaloupe) | 2-4       | 85-90   | 10 days              |
| Watermelon             | 7-16      | 80-90   | 2 weeks              |

\* Ware potatoes develop sweetness after 4-6 weeks storage, \*\* Anti sprout (CIPC) needs to be used

## 4.2. Controlled Atmosphere (CA) Storage

Controlled atmosphere (CA) storage involves altering and maintaining an atmospheric composition that is different from air composition; generally, O<sub>2</sub> below 8% and CO<sub>2</sub> above 1% are used. Atmospheric modification should be considered as a supplement to storage of produce at optimum temperature and RH for in preserving quality and safety of fresh vegetables throughout its postharvest life. In controlled atmosphere, gas composition



is exactly maintained and mostly used for extremely long period of storage. CA conditions during storage or transportation of vegetables is crop specific (Table 4). However, as a general rule the most common combinations are 2-5% oxygen and 3-10% carbon dioxide.

**Table 4: CA conditions during storage or transportation of vegetables (Source: Thompson, 1996)**

| Crop                    | CA        |                    |                     | Remarks                                   |
|-------------------------|-----------|--------------------|---------------------|---|
|                         | Temp (°C) | O <sub>2</sub> (%) | CO <sub>2</sub> (%) |   |
| Asparagus               | 0-5       | Air                | 5-10                | Limited commercial use                    |
| Broccoli                | 0-5       | 1-2                | 5-10                | Limited commercial use                    |
| Cabbage                 | 0-5       | 2-3                | 3-6                 | Some commercial use for long term storage |
| Lettuce                 | 0-5       | 1-3                | 0                   | Some commercial use with 2-3% CO added    |
| Mushroom                | 0-5       | Air                | 10-15               | Limited commercial use                    |
| Onion (dry)             | 0-5       | 1-2                | 0-5                 | No commercial use                         |
| Tomato (green)          | 12-20     | 3-5                | 0-3                 | Limited commercial use                    |
| Tomato (partially ripe) | 8-12      | 3-5                | 0-5                 | Limited commercial use                    |

From the construction point of view, controlled atmosphere facilities are similar to refrigeration facilities. However, they should be airtight to allow creation of an atmosphere different from normal. The oxygen consumption and its replacement by carbon dioxide by respiration, create the atmosphere. When the appropriate combination has been reached, a limited intake of oxygen is required to satisfy the reduced rate of respiration. Accumulation of carbon dioxide is removed by means of different methods. Because internal atmosphere behaves differently, a pressure compensating system is required to attain equilibrium with the external or ambient atmosphere. As controlled atmosphere rooms are kept locked until the end of the storage period, inspection windows are required to check the produce quality during storage.

Many crops benefit from CA storage but their usage is limited as it is difficult to define ideal products for storing under controlled atmosphere.

However, one of the most important factors is that investment and operating costs should be recovered. Other factors includes (1) product should be seasonal and have a stable demand during a long marketing period. (2) product should have some unique qualities and not be easily substituted by similar products. In other words, it is beneficial to use controlled atmosphere technology when there is no competitor product in the market. This may be the reason that CA usage is limited to specific crops, particularly apples and pears.

#### **4.2.1. Benefits of CA storage**

- Retardation of senescence (ripening) alongwith associated biochemical and physiological changes i.e. slowed down respiration and ethylene production rates, softening and compositional changes.
- Stop development of storage disorders.
- Slow down direct or indirect effect of postharvest pathogens and consequently decay incidence e.g. CO<sub>2</sub> at 10-15% inhibit development of Botrytis rot on strawberries, cherries and other fruits.
- Used as tool in insect control in some commodities.
- Alleviate certain physiological disorders such as chilling injury in various crops and russet spotting in lettuce.

#### **4.2.2. Harmful effects of CA storage**

- Initiation or aggravation certain physiological disorders e.g. blackheart in potatoes and brown stain on lettuce.
- Irregular ripening of fruits, such as banana and tomato, can result from exposure to O<sub>2</sub> levels below 2% or CO<sub>2</sub> levels above 5% for more than 2 to 4 weeks.
- Off- flavors and off-odours at very low O<sub>2</sub> or very high CO<sub>2</sub> concentration may develop as a result of anaerobic respiration and fermentative metabolism.
- Stimulation of sprouting and retardation of periderm development can occur in some root and tuber vegetables like potato

Fresh vegetables vary greatly in their relative tolerance to low O<sub>2</sub> concentration and elevated CO<sub>2</sub> concentration. These are the levels beyond

which physiological damage may be expected. These limits of tolerance can be different at temperature above or below recommended temperatures for each commodity. (Table 5 and 6).

**Table 5: Minimum O<sub>2</sub> concentrations tolerance of selected vegetables during CA storage (Source: Thompson, 1996)**

| Minimum O <sub>2</sub> conc. tolerated (%) | Commodity  |
|--|--|
| 0.5  | Nuts, dried fruits and vegetables                                      |
| 1.0  | Broccoli, Mushroom, garlic, onion, cut or sliced fruits and vegetables |
| 2.0  | Green beans, celery, lettuce, cabbage, cauliflower, Brussels sprouts   |
| 3.0  | Tomato, bell pepper, cucumber, Artichoke                               |
| 5.0  | Potato, green peas, Asparagus, sweat potato                            |

**Table 6: Maximum CO<sub>2</sub> concentrations tolerance of selected vegetables during CA storage (Source: Thompson, 1996)**

| Maximum CO <sub>2</sub> conc. tolerated (%) | Commodity  |
|---|--|
| 2   | Tomato, bell pepper, lettuce, celery, Chinese cabbage, Artichoke, sweet-potato       |
| 5   | Pea, Chilli, Brinjal, cabbage, cauliflower, Brussels sprout, radish, carrot          |
| 10  | Cucumber, okra, asparagus, broccoli, parsley, leek, onion, garlic, potato, snap bean |
| 15  | Mushroom, spinach, kale, cantaloupe  |

#### 4.2.3. Oxygen gas control

to DECREASE:

- purging with nitrogen : Nitrogen uses ammonia in combustion process (at high temperature) to consumer O<sub>2</sub> and produce nitrogen and water.
- from liquid nitrogen through an evaporator
- from a membrane system nitrogen generator
- from a molecular sieve system nitrogen generator

#### 4.2.4. Carbon dioxide control

to **INCREASE:**

- Dry ice
- Pressurized gas cylinder

to **DECREASE:**

- Molecular sieve scrubber
- Activated charcoal scrubber
- Sodium hydroxide scrubber
- Nitrogen Flushing (Pressures Swing Absorption or other technique)
- Hydrated lime (use 0.6 kg of hydrated lime to treat the air used to ventilate 100 kg of fruit. Air can be directed to pass through a box (Fig. 1), located inside or outside the CA storeroom).

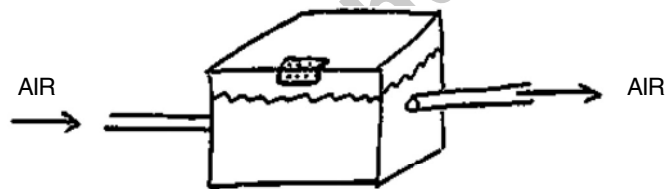


Fig. 1: Use of hydrated lime to control CO<sub>2</sub> during storage

#### 4.2.5. Ethylene control

to **DECREASE:**

- Potassium permanganate e.g. Purafil
- Activated charcoal e.g. Brominated charcoal air purifiers
- Catalytic oxidation e.g. ethylene scrubbers
- UV lamps

#### 4.2.6. Commercial Application of CA Storage

Several refinements in CA storage have been made in recent years to improve quality maintenance which includes creating nitrogen by separation from compressed air using molecular sieve beds or membrane systems, low O<sub>2</sub> (1.0 to 1.5%) storage, low ethylene (< 1 μL L<sup>-1</sup>) CA storage; rapid CA (rapid establishment of optimal levels of O<sub>2</sub> and CO<sub>2</sub>), and

programmed (or sequential) CA storage, eg., storage in 1% O<sub>2</sub> for 2 to 6 weeks followed by storage in 2 to 3% O<sub>2</sub> for the remainder of the storage period. Other developments, which may expand use of atmospheric modification during transport and distribution, include improved technologies for establishing, monitoring and maintaining CA using edible coatings or polymeric films with appropriate gas permeability to create a desired atmospheric composition around and within the commodity.

Commercial use of CA storage is greatest on apples and pears worldwide; less on cabbages, sweet onions and dried vegetables (Table 7). Atmospheric modification during long-distance transport is used in vegetables like asparagus, broccoli and melons. Continued technological developments in the future to provide CA during transport and storage at a reasonable cost are essential for greater applications on fresh vegetables.

**Table 7: Classification of vegetables according to their CA storage potential at optimum temperature and RH**

| Storage duration (months) | Commodities   |
|---------------------------|---|
| >12                       | Dried vegetables  |
| 6 to 12                   | —   |
| 3 to 6                    | Cabbage, Chinese cabbage                                      |
| 1 to 3                    | Mature green tomato   |
| <1                        | Asparagus, broccoli, lettuce, muskmelon, fresh-cut vegetables |

### 4.3. Hypobaric Storage or Low-pressure Storage (LPS)

Hypobaric storage is a form of controlled atmosphere storage in which the produce is stored in a partial vacuum. The vacuum chamber is vented continuously with water saturated air to maintain oxygen level and to minimize water loss. This can be effective method for reducing oxygen tension and for accelerating the escape of ethylene and other volatiles. Ripening of fruit is retarded by hypobaric storage, due to the reduction in the partial pressure of oxygen and due to reduction in the ethylene levels. A reduction in pressure of air to 10 kilopascals (0.1 atmosphere) is

equivalent to reducing the oxygen concentration to about 2 per cent at normal atmospheric pressure. However, in cold stores the relative humidity must be kept high and this water vapour in the atmosphere has to be taken into account while calculating the partial pressure of oxygen in the store. To do this relative humidity must be measured and by using a psychometric chart, the vapour pressure deficit can be calculated. This is then included in the following equation:

$$\frac{P_1 - \text{VPD} \times 21}{P_0} = \text{partial pressure of O}_2 \text{ in the store}$$

Where

$P_0$  = outside pressure at normal temperature (760 mm Hg)

$P_1$  = pressure inside the store

VPD = vapour pressure deficit inside the store.

Hypobaric storage extends the storage life of a wide range of crops when it is combined with refrigeration compared to refrigeration alone. Hypobaric storage or LPS has advantage over than methods of atmosphere modification.

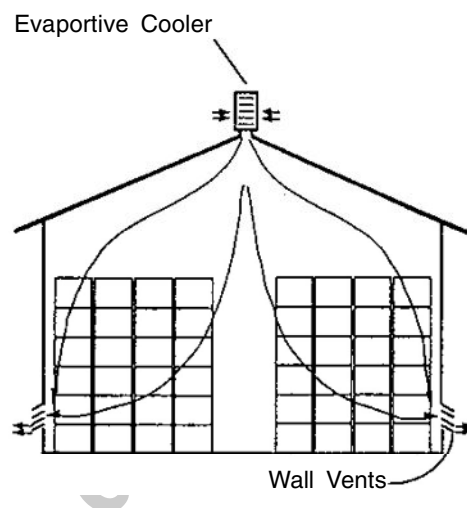
- More exact control of  $\text{O}_2$  concentration that permit the use of lower  $\text{O}_2$  tension that is possible with CA.
- Removal of ethylene and other volatiles

LPS has limitations when  $\text{CO}_2$  or CO addition is important for a given commodity. It retain the produce in fresh condition much longer than what is possible with the conventional cold storage e.g. perishable vegetables like cabbage, cucumber, lettuce, turnip etc. can result extension of storage life (2-3 times more than under convention cold storage). LPS of vegetables at low temperature is not at all costlier than the conventional cold storage, taking into consideration the additional advantages of LPS.

Variable low pressure storage (VLPS) was superior to LPS in cabbage and turnip in respect of storage life, weight loss and appearance. VLPS system did not require moisture addition because the inlet air to the chamber was saturated instantly with the water vapour produced by respiration or evaporation from cabbage and turnip.

#### 4.4. Evaporative Cool Storage

An evaporative cooler located in the peak of a storage structure (Fig. 2) can cool an entire room of stored produce such as sweet potato or other chilling sensitive crops. The vents for outside air should be located at the base of the building so that cool air is circulated throughout the room before it can exit (Fig. 2).



**Fig. 2: Storage room with evaporative cooler at top (Source: Thompson and Scheuerman, 1993)**

Fig. 3 shows the cross-sectional view of a storehouse for vegetables. Note that air inlets are at the base of the building, and the floor is perforated, allowing free movement of air. The entire building is set below ground level taking advantage of the cooling properties of soil.

##### 4.4.1. Zero-energy cool chambers

The low cost cooling chambers (fig. 4) are constructed from bricks. The cavity between the walls is filled with sand and the bricks and sand are kept saturated with water. Fruits and vegetables are loaded into plastic crates and put inside for storage. During the hot summer months in India, this chamber is reported to maintain an inside temperature between 15 and 18°C and a relative humidity of about 95%. The entire rectangular

chamber is covered with a rush mat, which is also kept moist. Punjab Agricultural University, Ludhiana has working model of this cooler at the Department of Agricultural Structures.

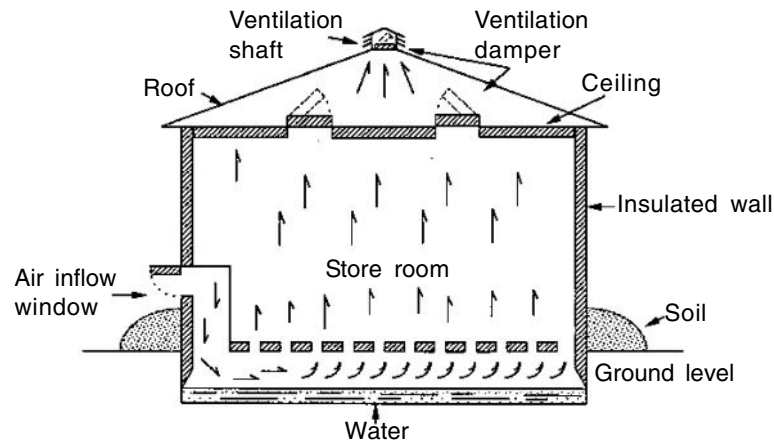


Fig. 3: cross section view of storehouse (Source: Seung Koo Lee, 1994)

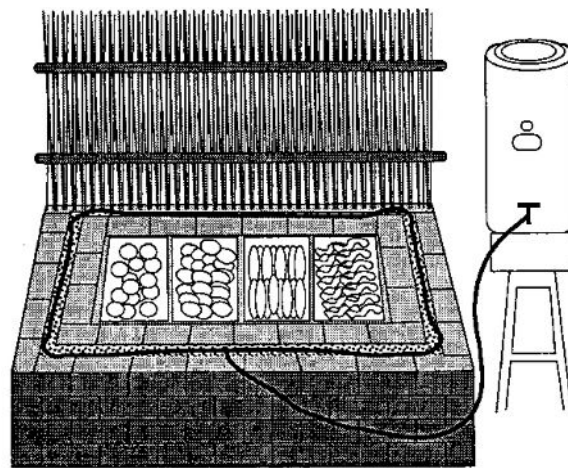


Fig. 4: Zero-energy cool chamber (Source: Roy, 1989)

#### 4.4.2. Larger sound storage structure

The same methods were used to construct this larger evaporative-cooled storage structure. Since a relatively large amount of materials are required



to construct this structure, it may be economically feasible only when handling high value products.

## 5. ALTERNATIVE COOLING STRATEGIES

### 5.1. Natural or Field Storage (on-farm storage)

For short term storage, on-farm storage is economical because it requires only a small investment and no energy. Vegetables need to be stored on-farm for various reasons. Some of on-farm storage techniques are mentioned below:

#### 5.1.1. *In-situ storage*

In-situ storage means delaying the harvest of the crop until it is required. This can be practiced in crops like cassava and potato. The disadvantage is that the crop may be exposed to pest and disease attack and the land remain occupied and as a result a new crop cannot be planted there. In-situ storage of potatoes for upto a period of three months is practiced in Meghalaya and Kumaon hills.

#### 5.1.2. *Storage in sand*

This method is practiced for storage of small quantity of potato meant for home consumption. A layer of sand is spread on the katcha floor in the corner of house and potatoes are spread on them and then again sand is spread over the potatoes. They are turned over once in 15 days and rotted tubers are removed. This method is practiced by farmers in Bihar for storage of potatoes upto six months.

#### 5.1.3. *Pit storage*

Pit is another traditional method of on-farm storage. In Himachal Pradesh, cabbage is stored in trenches. In upper Himachal Pradesh, farmers make *katcha* pits (4 x 4 x 4 ft) and store cabbage, cauliflower, peas and beans for 1-3 months during winter. Two types of pit are used for the storage of potatoes and they are *katcha* pit and *pakka* pit. *Katcha* pit is a simple pit dug under the shade of trees. It is generally rectangular in shape measuring 6 m in length, 4.5 m in width and 3-4 m in height. About 10-30

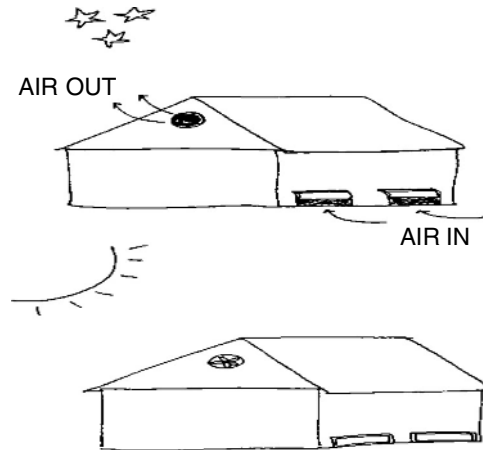
tonnes of potatoes are stored in each katcha pit. The number of farmers using katcha pit has decreased rapidly mainly due to seepage of rain water into pits leading to higher storage losses. Pakka pit is different from katcha pit in that it is lined with a layer of bricks, made in the form of a circular well and is generally bigger in size. Furthermore, it has a longer life, without recurring expenditure on digging and maintenance. A typical pakka pit measures 4.5 m in diameter and 4 m in depth and quantity of potatoes stored varies from 10 to 40 tonnes. The temperature inside the pit is 10 to 15°C lower and RH 20-30% higher than the ambient temperature. A major part of total losses is due to rotting and high incidence of rotting is caused by the pressure exerted by the top layers on the bottom layers of potatoes. By placing the bamboo platform at the bottom of the pit and by reducing the quantity of potatoes stored, it is possible to bring down the storage losses.

#### **5.1.4. Field storage in heaps**

Another method widely used is field storage in heaps. This method ensures that produce is free from soil humidity and is protected from the weather with a tarpaulin, straw, or plastic materials. It is a low cost alternative for bulky crops that require large buildings. For example, potato, onions, pumpkins, sweet potato etc. Smaller heaps are circular in shape with a diameter of 5 to 7 m and the height varies from 1 to 1.5 m. Bigger heaps are 1 to 1.5 m high and 3 to 6 m wide with length varying depending upon the quantity of produce stored. The heaps are covered with 30 to 50 cm thick layer of straw or dried sugarcane leaves. The temperature inside the heap is 10 to 14 °C lower and RH 18-20% higher than the ambient.

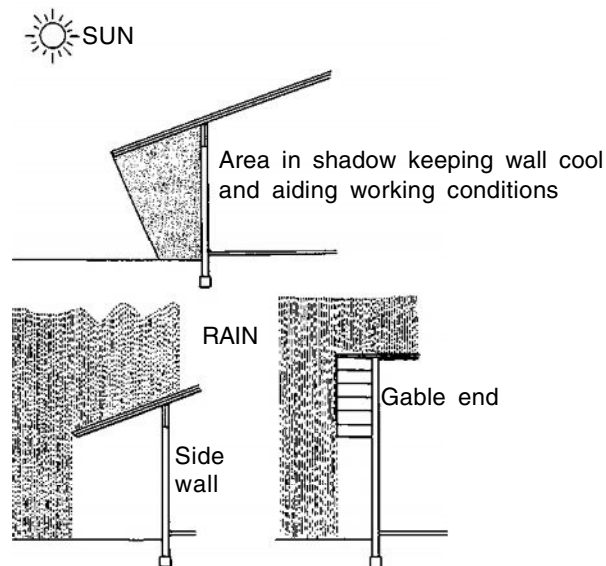
### **5.2. Night Air Ventilation**

Storage structures can be cooled using night air if there is large difference in day and night temperature (Fig. 5). The storage facility should be insulated and vents should be located at ground level. Vents can be opened at night and an exhaust fan located at top can be used to pull cool air through the storeroom. The structure will best maintain cool temperatures during the heat of the day if it is well insulated and vents are closed early in the morning.



**Fig. 5: storage structures with night air ventilation (Source: Walker, 1992)**

Overhanging roof extensions on storage structures are very helpful in shading the walls and ventilation openings from the sun's rays, and in providing protection from rain (Fig. 6). An overhang of at least 1 meter (3 feet) is recommended.



**Fig. 6: Overhanging roof extensions on storage structures (Source: Walker, 1992)**

Where electricity is not available, wind-powered turbines can help to keep storerooms cool by pulling air up through the building (Fig. 7). Vents at the floor level are especially useful for cooling via night air ventilation. The turbine (Fig. 7) can be constructed of sheet metal that is twisted to catch the wind and attached to a central pole that acts as the axis of rotation. Warm air in the storage room rises, causing the turbine to rotate, expelling the air and initiating an upward flow of warm air. The turbine should be placed on the peak of the roof of a storage structure.

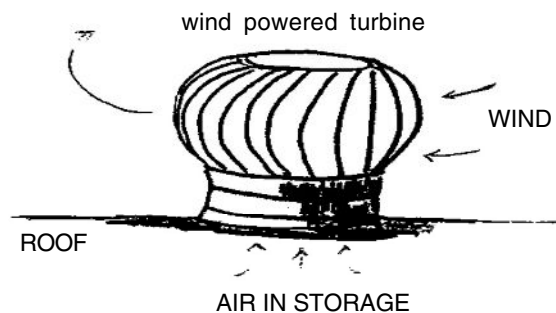
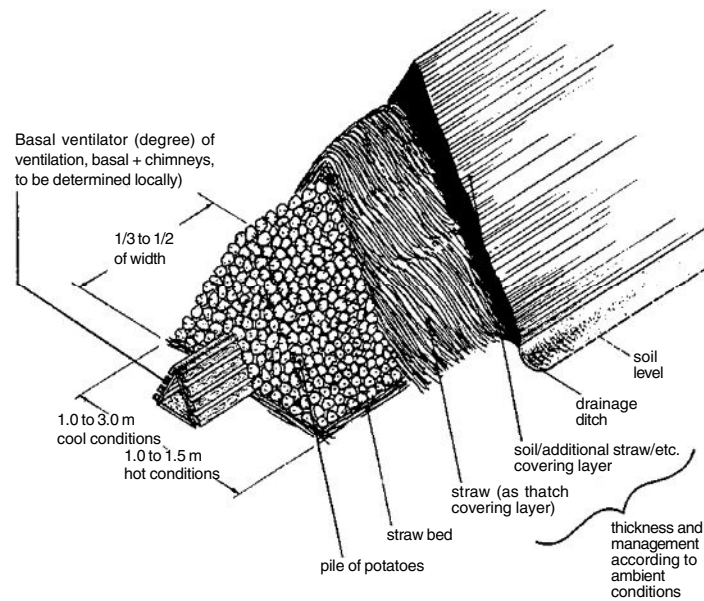


Fig. 7: Wind-powered turbine

## 6. ROOT AND TUBER CROPS STORAGE

When storing potatoes, a field storage clamp is a low cost technology that can be designed using locally available materials for ventilation and insulation. Fig. 8 shows a wooden ventilator box and straw for insulation. The entire pile of potatoes and straw is covered with a layer of soil, which should not be highly compacted. In very cold regions, a second layer of straw and soil can be added. In hot regions, less soil is needed, but more ventilation can be added by constructing chimney type air outlets at the top of the clamp.

Simple storage houses for potatoes can be constructed for small quantities of produce. For example, in Fig. 9, storage structure can store 1 to 2 tons potato and are used on farms (in mountain villages). The first is made from unfinished wooden planks painted white to reduce heat accumulation from the sun and covered with a large thatched roof for protection from sun and rain. It has a large door on one side for loading and unloading.

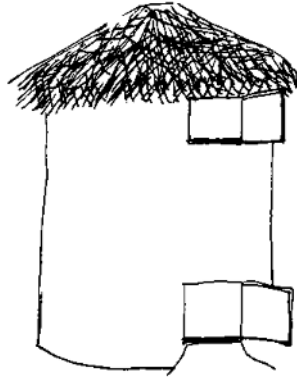


**Fig. 8: Field storage clamp (Source: CIP, 1981)**



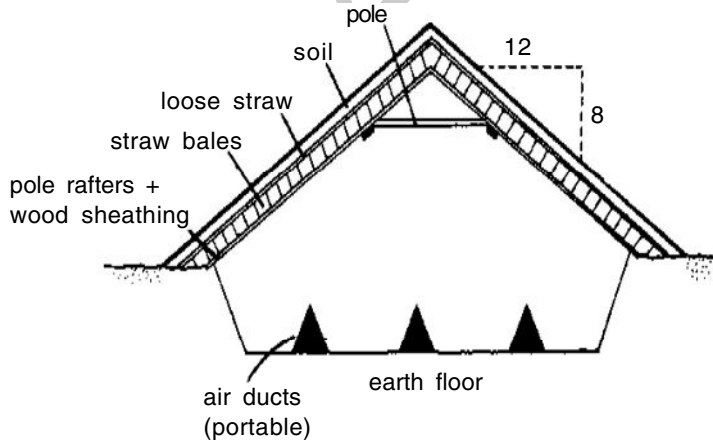
**Fig. 9: Small scale storehouse for potato (Source: CIP, 1981)**

The second storage house is constructed from lath and plaster and mud bricks in a cylindrical form (Fig. 10). It has two doors, one on top for loading, the other at the bottom for easy removal of potatoes for sale or consumption. White-wash helps reduce heat accumulation and a thatch roof protects the potatoes from rain and sun.



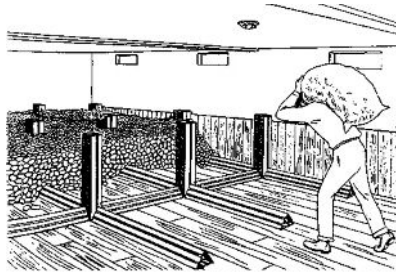
**Fig. 10: Storage house constructed from lath and plaster and mud bricks (Source: CIP, 1981)**

For large quantities of potatoes, a self-supporting A-frame storehouse can be constructed. A pit is dug about 10 feet deep and wooden air ducts are placed along the earthen floor. The roof of the building is constructed of wood, then covered with straw and soil (fig. 11).

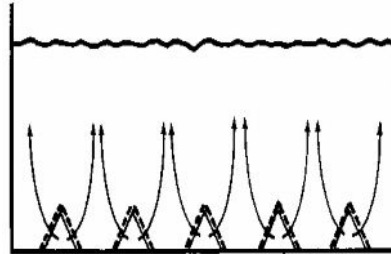


**Fig. 11: Large scale storage of potato (Source: CIP, 1981)**

Ducts for ventilation of bulk storage rooms can be laid out vertically as well as horizontally (Fig. 12 and 13). The storeroom for potatoes shown in Fig. 12 provides plenty of ventilation using simple materials. The room can be of any size or shape since air ducts can be positioned to distribute air evenly throughout.



**Fig. 12: Vertical and horizontal ducts in storage room**  
(Source: CIP, 1981)



**Fig. 13: Ducts for ventilation**  
(Source: CIP, 1981)

When loading potatoes into bulk storage, even distribution of the produce is important for proper ventilation. Uneven loads will inhibit air movement and result in storage losses due to inadequate ventilation.

Potatoes for processing are kept at intermediate temperatures to limit the production of sugars. Potatoes meant for consumption must also be stored in the dark, otherwise the tubers will produce chlorophyll (turning green) and develop the toxic alkaloid 'solanine' if kept in the light. Potatoes for seed purpose are best stored in diffuse light. The chlorophyll and solanine that accumulate will aid to protect the seed potatoes from insect pests and decay organisms.

The recommended storage conditions for root and tuber crops are listed in Table 8. Tropical root and tuber crops must be stored at temperature that will protect the crops from chilling, since chilling injury can cause internal browning, surface pitting and increased susceptibility to decay.

**Table 8: Storage temperature, RH and storage life of root and tuber crops**

| Vegetable     | Temperature ( °C) | RH (%) | Storage life |
|---------------|-------------------|--------|--------------|
| Potato (seed) | 1-2               | 90-95  | 4-8 months*  |
| Potato        | 10                | 90-95  | 6 months**   |
| Sweet potato  | 12-14             | 85-90  | 6 months     |
| Cassava       | 5-8               | 80-90  | 2-4 weeks    |
|               | 0-5               | 85-95  | 6 months     |

[Table Contd.]

Contd. Table]

| Vegetable | Temperature ( °C) | RH (%)   | Storage life |
|-----------|-------------------|----------|--------------|
| Yam       | 13-15             | near 100 | 6 months     |
|           | 27-30             | 60-70    | 3-5 weeks    |
| Ginger    | 12-14             | 65-75    | 6 months     |
| Jicama    | 12-15             | 65-75    | 3 months     |
| Taro      | 13-15             | 85-90    | 4 months     |

\* Ware potatoes develop sweetness after 4-6 weeks storage, \*\* Anti sprout (CIPC) needs to be used

## 7. DRIED AND BULB CROPS STORAGE

Onion, garlic and dried produce are best suited to low relative humidity in storage. Onion and garlic will sprout if stored at intermediate temperatures. Light coloured onion bulbs have better storage life as compared to dark red and white coloured onions. For bulk storage of onions or garlic, natural ventilation systems should be designed to provide air into the store.

The temperature and relative humidity are the prime important factors associated with storage of onion and garlic. Onion and garlic can be stored either at lower temperature (0°C) or at higher temperature (around 30°C). At high temperature, moisture loss and shrinkage are reported. Under both high and low temperature storage, the relative humidity of air should be maintained between 65 to 70%. At high temperature (25-30°C) satisfactory storage life of 6 to 8 months can be expected. At low temperature (0°C) onion and garlic can be stored for about 12 months. High relative humidity (more than 70%) results in mould growth and rotting. The dormancy of bulbs inhibits sprouting and it is highly temperature dependent and sprouting is higher between 5-20°C, hence maintenance of temperature is very important. As far as physiological weight loss is concerned, it is less at 0-2°C and moderately higher at 28-30°C. Thus there are two distant temperatures conditions (0-2°C, 25-30°C) and defined humidity range (65-70% RH) suitable for safe storage of onion and garlic. Thus the onion and garlic storage structure should be planned and designed in such a way that it can achieve and maintain the desired storage conditions in lowest possible cost within the available resources. When



onion and garlic are stored in cold storage at 0-2°C and 65-70% RH, the main problem is of “sprouting of onion and garlic within a week” when it is taken out from cold store. This problem of sprouting can be successfully minimized by use of gamma irradiation treatment.

The onion and garlic are stored in heaps/sacks under ambient conditions in our country. Thoroughly cured onion and garlic bulbs are stored well in ordinary well-ventilated rooms. Garlic with dried leaves can be stored by hanging in well-ventilated rooms. This is, however, not possible on commercial scale because of more space requirement. The large quantity of untopped garlic may be stored in circular heaps of 1 meter diameter and 1-1.5 meter height. Several modified onion and garlic storage structures has been designed and tested by Directorate of Onion and Garlic Research (DOGR) Pune, which help in reduction of storage losses. The detail of onion and garlic storage structures is as follows:

### 7.1. Bottom Ventilated Storage Structures

These structures are permanent type and usually constructed with galvanized iron (GI) framework. The floor is also bottom ventilated and usually built with wooden bantams or bamboos. The sidewalls are also constructed with wooden bantams or bamboos. The roof is made with asbestos sheets. The outward extension of roof to about one meter is recommended to protect the produce from rain and sun rays. The additional aeration provided in this structure helps in reduction of losses (Fig. 14). Generally the storage losses in this structure ranges from 30 to 40% in the storage period of 4-5 months.

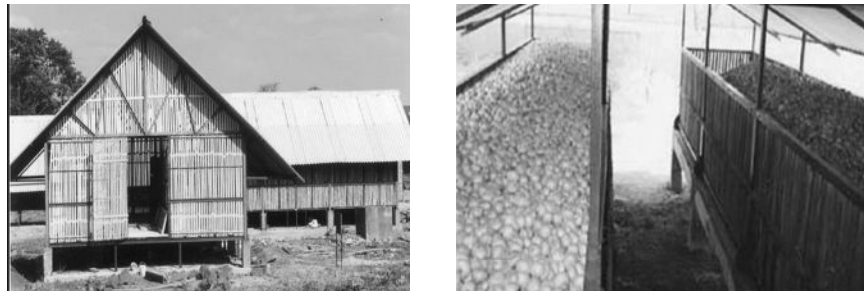


Fig. 14: Bottom ventilated storage structures

## 7.2. Top and Bottom Ventilated Storage Structure

This is a distinct type of onion and garlic storage structure designed and tested by DOGR, Pune. This structure is constructed with GI framework. The floor is ventilated and constructed with wooden bantams. The sidewalls are made of bamboo and plastered with clay and cow dung paste. The ventilation is provided at lower portion of western sidewall and upper portion of the eastern sidewall (Fig. 15). The lower portion ventilator of western sidewall has control flaps to regulate the entry of hot winds in summer and high humid wind in rainy season. Plastered sidewalls controls humidity in rainy days, while it maintains temperature inside during summer. The structure can be constructed with 25 to 50 tones capacity. The cost of construction would be about Rs 3600/tonne. The storage losses in this structure are 28-30% in the storage period of 4-5 months. This structure may better suits to humid and high temperature areas.



Fig. 15: Top and bottom ventilated storage structure

## 7.3. Low Cost Bottom Ventilated Structure

Low cost bottom ventilated structure has been designed by DOGR, Pune, for small and marginal farmers. This can easily constructed by farmers with their own farm resources. The structure is constructed with bamboo/ wooden framework provided with bottom ventilation. The bottom and sidewalls can be made of bamboo or wooden bantams. The roof is made up of thatch from dried sugarcane leaves or grass (Fig. 16). The cost of structure would be around Rs 800/tonne. The storage losses in this structure are 30-35% in 4-5 months of storage period.



**Fig. 16: Low cost bottom ventilated structure**



**Fig. 17: storage of garlic in heaps structure**

#### **7.4. Points to be Consider for Construction of Storage Structures for Dried Bulb Storage**

- It should be constructed in such a manner so that it can maintain the required temperature and relative humidity.
- There are two type of storage structures i.e. one row and two row storage structures. Hence direction of erecting storage structure is more important. One row structure should be erected against the flow of wind whereas, two row structure should be erected along the direction of wind. Therefore, single row should be constructed in North-South direction while double row structure should be constructed in East-West direction.
- The width of one stake should not be more than 4 feet. The maximum height at the sides should be 5 feet and at the centre should be 8 feet. Length of two row structure should not be beyond 40-60 feet whereas in one row it can be according to requirement. There should be minimum 4 feet working space in between two row structure.
- Bottom ventilation of 1 to 1 ½ feet should be provided for proper aeration.
- The floor and sidewall should be constructed with wooden bantam or bamboos.

- The roof should be constructed with asbestos sheet or mangalore tiles or thatches. Galvanized iron sheet are not suitable for roofing. In case asbestos sheet are used it should be thatched with dry sugarcane leaves or grasses during hot periods.
- The structures should be construction at an elevated place. There should not be any water body or water stagnation around the storage.
- In one cubic meter volume about 500 to 700 kg of onion can be stored depending upon the size of bulbs. Thus, size of storage structure to be constructed can be calculated according to the area and production by the farmers.

## **8. GENERAL DO'S AND DON'TS FOR STORAGE OF HIGH QUALITY VEGETABLE CROPS**

- Store only high quality produce, free of damage, decay and of proper maturity (not over-ripe or under-mature).
- Know the requirement for the produce you want to storage and follow recommended for proper temperature, relative humidity and ventilation.
- Don't handle crops for storage when they are wet.
- Cure root, tuber and bulb crops before storage.
- Avoid lower than recommended temperatures in storage, because many commodities are susceptible to damage from freezing or chilling.
- Do not over load storage rooms or stack containers too close together.
- Provide adequate ventilation in the storage room.
- Provide shade for storage structures or paint buildings white or silver to reflect heat.
- Overhanging roof extensions on storage structures are very helpful in shading the walls from the sun's rays, and in providing protection from rain. An overhang of at least 1-meter is recommended.
- Keep storage rooms clean.
- Storage facilities should be protected from rodents by keeping the immediate outdoor area clean and free from trash and weeds.
- Monitor temperature in the storage room by placing thermometers at various locations.

- Don't store onion or garlic in high humidity environment.
- Potatoes should be stored in dark since light will stimulate solanine production (a toxic compound not destroyed by cooking).
- Avoid storing ethylene sensitive commodities with those that produce ethylene.
- Avoid storing produce known for emitting strong odors (apples, garlic, onions, turnips, cabbages, and potatoes) with odor-absorbing commodities.
- Inspect stored produce regularly for signs of injury, water loss, damage and disease. Remove damaged or diseased produce to prevent the spread of problems.

drysrhu

## CHAPTER 13

# TRANSPORTATION

---

Transportation of fresh vegetables is an important component of marketing. Every produce passes through this phase for marketing to shorter or longer distances. The transportation of vegetables is to be done very cautiously to get the premium price of the produce and to prevent losses in the transition stage. To minimize losses during transportation, it is necessary that special attention has be given to the vehicle, equipment, infrastructure and handling. Maintenance of proper temperature and relative humidity, proper packing and stacking and transportation time affect the quality of produce.

### 1. SELECTION OF TRANSPORT MODE

The mode of transport is influenced by:

- The end market (domestic or export)
- The period of transport and nature of route
- The value of the product to be transported
- The nature of product perishability, degree of maturity, susceptibility to mechanical damage, optimum storage conditions
- The volume to be transported
- The cost and reliability of the transport

## 2. HOW TO MAINTAIN QUALITY DURING TRANSPORTATION

### 2.1. Design Conditions of the Transport Equipment

Refrigerated units are not designed to pre-cool the produce but to maintain the desired produce temperature of pre-cooled produce. The air circulation is also limited in transit unit. This air circulation is only sufficient to remove limited amount of respiratory heat produced and heat leakage/transmission through walls/roofs. So either door is opened for few minutes after every few hours or air is leaked through small vents provided. Ribbed floor ensure proper airflow beneath the load. Ducking of air along the roof and intact air delivery chutes will enhance the air circulation (Fig. 1). The suspension system of the transport vehicle influences the mechanical damage to the produce. Stiff suspension system may increase impact damage so these should be replaced by soft springing. Air bag system is effective but costly. Proper cushioning or tray inserts prevents vibration damage.

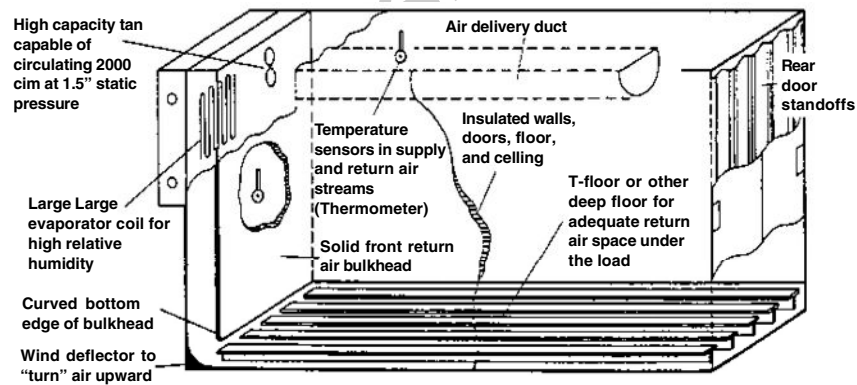


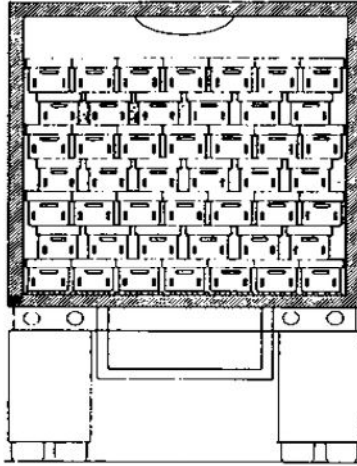
Fig. 1: Maintaining Optimum Transit Temperatures in Refrigerated Truck Shipments (Source: Kasmire and Hinsch, 1987)

### 2.2. Produce Temperature at Loading

Produce should be thoroughly pre-cooled to the required transit temperature prior to loading. Even after pre-cooling highly respiring produce they will still produce enough heat to cause self-heating due to limited air circulation and refrigerated capacity of the transit unit.

### 2.3. Load/Stacking Pattern

In order to reduce the conduction of heat from outside the vehicle into the load of produce, stacking patterns should reduce the amount of contact between the produce and the floor and walls of the vehicle. Produce transported in cartons should also be stacked so as to allow adequate air circulation throughout the load. Fig. 2 shows cross section offset loading of partial telescopic containers. On the floor of the truck, pallets or other supports should be used to keep the cartons or boxes out of direct contact with the floor.

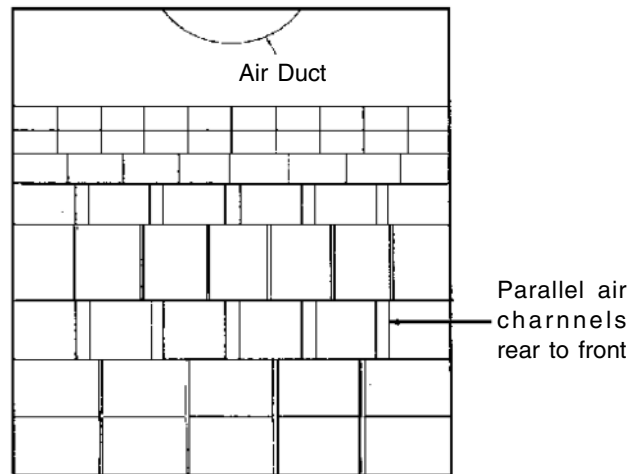


**Fig. 2: Cross section offset loading**

When cartons of various sizes must be loaded together, the larger or heavier containers should be placed on the bottom of the load (Fig. 3). Parallel channels should be left for air movement through the length of load. Loads must have open air channels through and around them that are either vertical or lengthwise horizontal. Loads must be assembled in ways that will maintain their integrity in transit. Various types of gates, braces and locking bars are used to maintain the integrity of loads. Overloading also blocks air circulation so that product temperatures increase during transit. Well-constructed palletized loads with sufficient air channels provide better assurance of proper transit temperatures in heavy loads. In hot or very cold weather, loads should be palletized on



wood racks and kept away from side walls to prevent warming or freezing in wall rows or bottom layers. Containers should be loaded so that they are 2" away from side wall and floor and 4" away from doors in order to minimize conduction of heat from outside environment.



**Fig. 3: Loading cartons of various sizes of containers (Source: Nicholas,1985)**

#### 2.4. Stabilization and Bracing the Load

Stabilization of load is done on pallet basis. The commonly used technique for stabilizing pallets are strapping, corned trays, tension netting or glueing. When loaded in transit trucks, each pallet is secured using combination of ply board (slotted) straps and aluminum load bars. Tightly stacked load may increase the amount of produce to be transported but the effectiveness of temperature management is greatly reduced. This can cause loss of quality and marketability. There should always be a void between the last stack of produce and the back of the transport vehicle (Fig. 4). The load should be braced to prevent shifting against the rear door during transit. If the load shifts, it can block air circulation and fallen cartons can present great danger to workers who open the door at a destination market. Wooden brace for rear door and air fitted bags for sidewalls provide excellent bracing. The bottom of the pallets is braced with wooden blocks to prevent load shifting.

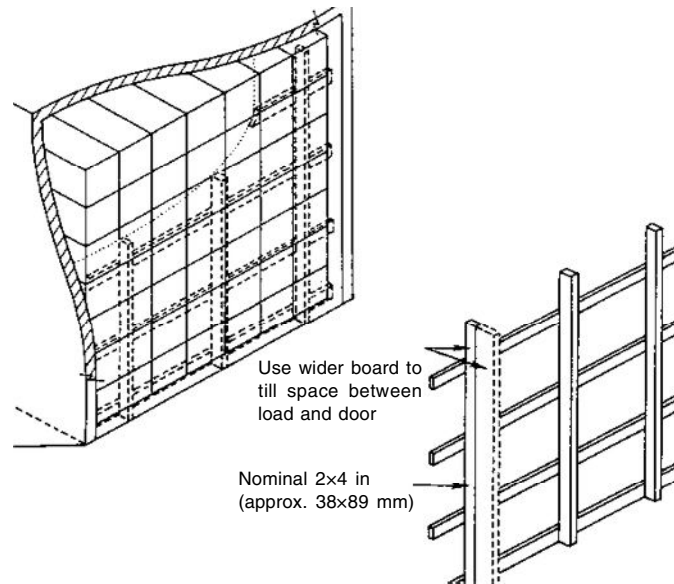


Fig. 4: Bracing the load (Source: Nicholas, 1985)

## 2.5. Loading of Vehicle

The vehicle to be loaded should be pre-cooled to set temperature. The produce should be loaded quickly (15-20 minutes). A maximum of 30 minutes is allowed for loading at non-refrigerated docks.

## 2.6. Ambient Temperature and Transit Time

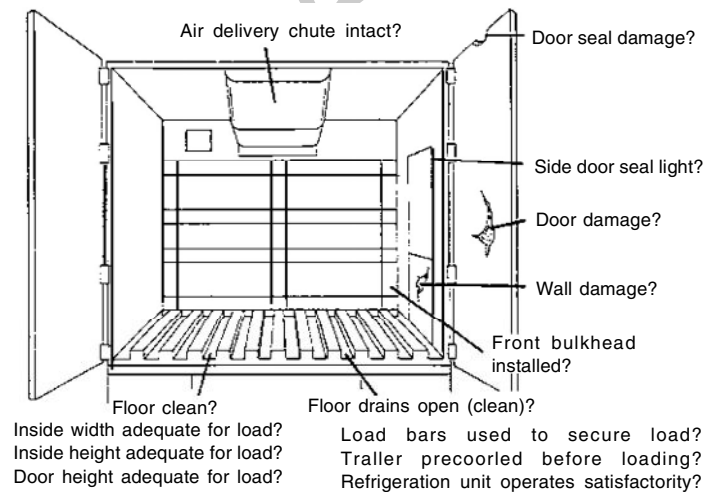
Even when produce is of high quality during loading and storage or transit environment is ideal, there is always some deterioration. Hence, transit times need to be kept minimum so that the produce can reach the market or consumer in best possible quality. The temperature during transit will influence the amount of heat conducted into and out of the transit unit. Since average road temperatures can be much higher during hot summer, making it difficult for refer van to maintain recommended temperatures. During very cold weather, heat is conducted out of the transit unit and the produce may freeze or suffer chilling injuries. Therefore, the transit time under these conditions should be as short as possible. If possible, transportation of produce should be done at cool hours in summer.

### 2.7. Packages

Package vary in their design, construction and uses. Packages are designed to protect the produce, and modify the atmosphere around it. Poorly ventilated packages restrict air movement around produce and hamper effective temperature management. Partial collapse of weak cartons restricts air circulation through the load. Moreover, weak packages and their enclosed contents are more easily damaged by rough handling as compared to strong packages.

### 2.8. Condition of Transit Vehicle

Maintaining produce temperatures is affected by the condition of the transit vehicle. Intact side walls and insulations; clean floor and drains; refrigeration units that are properly serviced, maintained and calibrated; air circulation ducts properly installed; undamaged doors and seals are essential (Fig. 5). Loading good produce into faulty vehicle is wasteful, accelerates produce quality loss and can increase marketing loss.



**Fig. 5: Condition of transit vehicle (Source: Kasmire and Hinsch, 1987)**

### 2.9. Mixed Loads

Maintaining optimum temperature in mixed loads is difficult, especially in loads containing several crops. Crops are generally packed in different

sizes and shapes of packages that are then loaded in different load patterns in various parts of vehicles. When products with different optimum temperature requirements are transported together, compromise temperature settings are used that are designed to protect the most perishable or the most valuable produce in a load. Any part of a load which is in direct contact with floor effectively block the air circulations under the entire load. When loads are assembled from multiple locations, some products may be un-cooled or inadequately cooled before loading. Frequently opening of doors during loading of mixed loads causes warming of already loaded products.

## 2.10. Product Compatibility

For short trips over a few hours, products can be transported in mixed loads without serious damage. Compatibility of products is of some importance over a transit period of 1-2 days, is important for transit period of 3-10 days and is extremely important over transit period of 2-4 weeks. In mixed loads certain product compatibility factors must be considered, which includes:

- **Temperature compatibility:** Differences in temperatures needed for various products in a load must be considered. For example, product that must be kept near 0°C should not be transported with the products sensitive to chilling injury below 10°C.
- **Ethylene production and sensitivity compatibility:** Care must be taken not to transport commodities that produce large amount of ethylene (e.g. apple, banana, tomato, pears, and certain muskmelons) with commodities that are sensitive to ethylene (broccoli, carrots, lettuce, brussels sprout, chinese cabbage, celery).
- **Product odour compatibility:** Some commodities (e.g. onion, garlic) produce odours which can be absorbed by other products, causing the latter to have objectionable odour and less market appeal. Some products absorb odours more readily than others.
- **Moisture compatibility:** Most products benefit from high relative humidity in the transit atmosphere. Other commodities (e.g. garlic, dry onions) benefit from intermediate humidity levels. Although humidity control at high levels is important during long transit periods, it is difficult to achieve.

### 3. TRANSPORTATION METHODS

- Domestic
- International

#### 3.1. Domestic

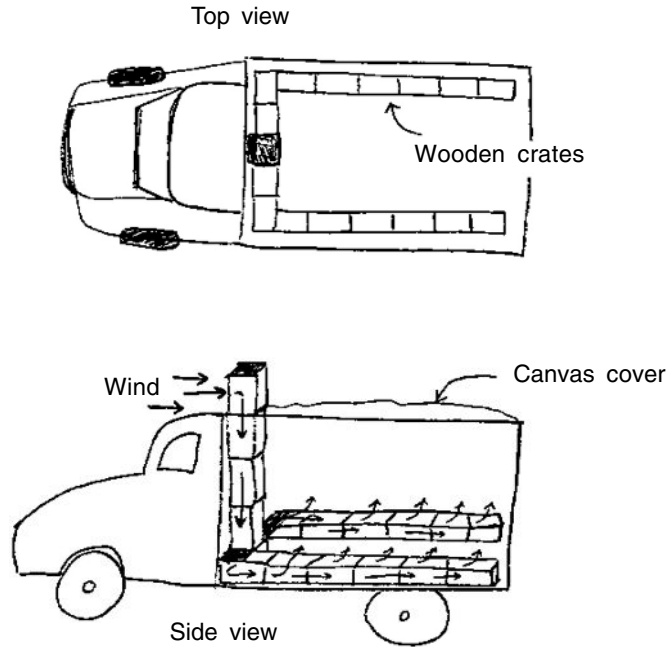
##### 3.1.1. *Non-refrigerated vehicles*

Non-refrigerated vehicles are generally open-sided trucks with wire mesh frames. This type of transportation is inexpensive, convenient and easy. Non-refrigerated vehicles are used for transportation over distance of up to 850 km. Bulk loads of produce should be carefully loaded so as not to cause mechanical damage. Vehicles can be padded or lined with a thick layer of straw or other insulation and cushioning. Woven mats or sacks can be used in the beds of small vehicles. In case of bulk commodity, placing of other loads on tops should be avoided. Never stand upon produce during loading or unloading. Packaged produce should be loaded in uniform stacks and braced properly to prevent damage. Covering the load with a silver or light-colored canvas cover helps in protecting the produce from sun.

Cooling of open loads is desirable whenever possible. A truck-ventilating device can be constructed for non-refrigerated open vehicle by covering the load loosely with canvas and fashioning a wind catcher. The wind catcher and ducts were constructed using wooden crates and this helps in removing the respiration heat of produce during transit (Fig. 6). Air flows upward through the load during transport helps to prevent the produce from overheating. Best results are obtained when produce is transported during early morning hours. High transportation speeds and/or long distance transport during dry weather cause excessive drying of produce. Ventilating systems have been designed for hauling bulk loads of fresh produce. The damage and losses occurred during non-refrigerated transport are caused primarily by mechanical damage and by overheating.

**(a) Mechanical damage.** Damage of this type occurs for many reasons which includes:

- Careless handling of packed produce during loading and unloading
- Vibration of the vehicle, especially on bad roads



**Fig. 6: Ventilation system in open vehicles/ bulk loads**

- Fast driving and poor condition of the vehicle
- Poor storage
- Packages stacked too high; the movement of produce within a package increases in relation to its height in the stack

**(b) Overheating:** This can occur not only from external sources but also from heat generated by the produce within the package itself. Overheating promotes natural breakdown and decay and increases the rate of water loss from produce. The causes of overheating include:

- The use of closed vehicles without ventilation
- Close stacking patterns blocking the movement of air between and through packages, thus hindering the dispersal of heat
- The lack of adequate ventilation in the packages
- Exposure of the packages to the sun while awaiting transport or while trucks are queuing to unload at their destination.

### **3.1.2. Portable field-to-market coolers**

This simple trailer cooler can be constructed using a room-sized air conditioning unit powered by a diesel generator and an insulated storage box. The trailer can either be built as a unit with wheels, or the cooler can be loaded upon a pre-existing wagon or trailer. The cooler is designed to be loaded at the field during the morning hours (when the air temperatures and produce temperatures are relatively low) and used to pre-cool the produce during the period between harvest and packing or between field-packing. Once produce is cooled, the box is sealed and transported to market immediately.

### **3.1.3. Refrigerated transport by road**

Small-scale postharvest cold transport can be accomplished using a cargo van fitted with a high powered air conditioning system. The condition of the inside of a refrigerated van affects its ability to maintain desired temperatures during transport. When renting, leasing or hiring an independent vehicle to transport the produce, it is better to inspect the van before loading. Any damage in the vehicle will let heat in and make temperature management much more difficult. Before loading the produce in van, the vehicles should be pre-cooled to their desired thermostat set point. Pre-cooled vehicle will prevent accumulation of excess moisture on the inner surface of vehicle and reduce subsequent cycling of the refrigeration unit.

## **3.2. International Transport**

### **3.2.1. International transport by sea**

Fresh vegetables are transported in temperature controlled cargo space either in break bulk or reefers (stated in 19<sup>th</sup> century) using ice through which air was circulated. It is now replaced by mechanical refrigeration system.

- **Reefer containers:** These are insulated containers with their own refrigeration units. ISO specification specifies that these must be capable of holding 30 ton produce and should be sufficiently strong to

withstand a vertical load of up to 9 containers stacked above it. These containers have about 70mm insulation (polyurethane foam) in the walls. Containers designed solely for fresh fruits and vegetables shall have thinner insulation, with a heat leakage of  $35 \text{ WK}^{-1}$ . Different specifications and sizes of various types of containers have been developed. Length varied between 17, 20, 24, 35, 40 feet long to prevent interchange of containers between different operating lines. Most standard sizes are 20 and 40 foot as recorded by ISO.

- **Break bulk:** It is a system of transport where individual boxes or pallet of produce are directly stacked in the hold of the ship. Most produce is palletized before shipping. Palletization reduces handling and the labour cost and damage to produce. Standard international pallet is 1000 x 1200 x 2100 mm. The hold of the ship is commonly 2200 mm high. So pallet load can fit in with adequate clearance for air circulation. The boxes should be placed between pallets to improve air circulation and temperature control.
- **Porthole containers:** These are insulated containers without their own refrigeration units. Instead they have 10 cm diameter ports which can be connected to an external refrigerator system. They are used in ships where containers are plugged into ships refrigeration system. They may also be plugged into a unit at port to cool the produce, while awaiting transport. The advantage of this system is lower rental costs of the containers and units can be cooled quickly because of larger refrigeration capacity of the ship. Disadvantages are that special facilities are required both at port and on ship.
- **Ventilated containers:** These are standard metal containers with no insulation or refrigerator unit but some arrangement for ventilation. It may have one rows of holes each at top and bottom of each of long sides of the containers. Ventilation is passive using natural convection currents or a row at bottom of each of long sides and exhaust fan at door. These containers have low rental cost compared to reefers. These containers are used for transporting onion, garlic, potatoes etc. which have low perishability.
- **Modified atmosphere containers:** These containers are gas tight. A plastic curtain is fixed on the door. After loading the produce, the container is sealed and required gaseous atmosphere is injected through purging ports.



- **CA Containers:** Controlling the levels of gases in reefer containers depends upon how gas tight the container is. Current systems allow gas leakage rate of below 1m<sup>3</sup> and most of the air leakage is through floor. The containers with single door and with plastic curtain fitted inside have made it easy to be gas tight.

### **3.2.2. International transport by air**

Vegetables are packed into pallets or closed containers that are specially designed to fit into a specific type of aircraft. Containers come in different shapes and sizes, which are designed to maximize the use of interiors of the aircraft. Most aircrafts have pressurized cargo compartments, which are maintained at low humidity (20-40%) and same temperature as the passenger compartment. There will be increased in humidity and decrease in temperatures if poor ventilation is there. Envircontainers worldwide USA, produce 3 sizes of insulated containers, which are cooled by a fan circulating air across dry ice (Solid CO<sub>2</sub>) and then through the produce in the containers. The container has up to 57 kg of dry ice in a compartment, which is separated from cargo compartment. Air cargo is charged by weight.

## **4. GENERAL DOS AND DON'TS REGARDING TRANSPORTATION OF HIGH QUALITY PRODUCE**

- Vehicles should never be overloaded.
- Minimize compression damage to the produce by avoiding over-filling of containers and stacking heavier produce at the bottom of the load.
- Always use study packages for transportation. A CFB package loss half its stacking strength during a five-day trip in a high humidity environment.
- Handle the produce gently during loading and unloading.
- While stacking containers always align them properly. The corners of a CFB box have most of its strength. A one-inch overhang will decrease stacking strength by 15 to 34%.
- Use transport vehicles having air suspension systems which provide a more gentle ride during transportation and helps in reducing damage due to vibrations.

240 | Post Harvest Handling of Vegetables

- Use suitable trays, place packing, use of plastic bags, container liners, or placing a soft pad at the top of a full box can reduce vibration damage.
- Provide adequate ventilation to the vehicle to prevent heat gain during transport.
- Refrigerated vehicles should be well insulated and have doors that seal tightly and securely.
- Before handling each load, always consult checklist for refrigerated transport.
- When purchasing new or used transport vehicles always check for recommended design and features.
- Before loading always pre-cool refrigerated vehicles to suit produce requirements.
- Minimize delays when loading on an open dock; delays cause heat gain, especially if produce exposed to full sun.
- There should be adequate air flow under the produce or anywhere else in the load.
- Air temperature at supply and return should be monitored for best performance of refrigeration units.
- Always avoid mixed loads if possible or install ethylene scrubbers to prevent damage to ethylene sensitive commodities.
- In refrigerated transport, produce should be loaded away from the sidewalls to prevent heat gain from the external environment.
- Avoid loading mixed sizes of containers or unpalletized produce.
- Always keeps the refrigeration unit running during delays in transport.
- The loaded produce should be braced at least 5 cm (2") away from the side walls and at least 10 cm (4") away from the rear door in the refrigerated transit.
- A portable temperature recorder (data logger) should be used to verify temperature management during transport.

## CHAPTER 14

# DESTINATION HANDLING

---

**D**uring handling produce at its destination, it is important to avoid rough handling, minimize the number of handling steps and maintain the proper temperature and relative humidity. If produce is to be stored before sale, then wholesale and retail markets need clean, well insulated storage rooms. Since numerous crops are usually being handled simultaneously during temporary storage, it is important not to mix commodities that have different temperature requirements or store ethylene sensitive commodities near ethylene generating commodities. Stacking of non-uniform containers should be done with care to prevent collapse and heavy boxes should be placed at the bottom.

Before produce is sold to the consumer, the handler may wish to sort for quality or at least to discard any damaged or decayed produce in order to give more market appeal to the produce. If ripeness or maturity is non-uniform, sorting at destination can provide higher price to seller and better quality to the consumer. If the produce handled is a climacteric vegetable that was harvested before it was ripe (tomatoes), the handler at destination may want to ripen the produce before it is sold to the consumer.

Finally, the handler at destination can help to reduce losses in the future by maintaining good records of the sources of losses occurred at the wholesale or retail level. Identifying whether losses were due to mechanical damage, decay/disease, immaturity or over ripeness allows

the handler to provide better quality feedback to produce suppliers. The different operations carried out on reaching the commodity at destination are discussed below.

## 1. LOADING AND UNLOADING

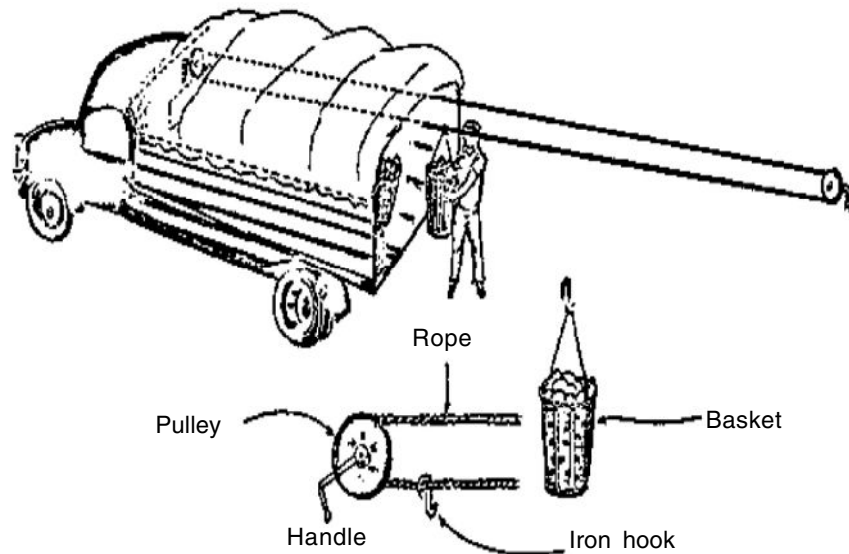
A loading dock can ease the work associated with handling of vegetable produce at destination. Containers can be transferred more rapidly and with less bending and lifting. For large trucks, a loading dock of 117 to 122 cm high (46 to 48 inches) functions well, while for small trucks a height of 66 to 81 cm (26 to 32 inches) is recommended.

Unloading of produce from vehicles can be done by hand or mechanical means. Forklifts are used to unload vehicles in which packages of produce have been palletized. During unloading, care must be taken in handling the packages to avoid dropping, which can cause damage to the package and bruising of the produce upon impact. Impact injury may not be visible on the surface; so careful control is needed to prevent its occurrence. The unloading dock should be constructed by considering the height of the vehicles i.e. platform should be of same height as bed of delivery truck. It is better to turn-off the engine of the delivery truck during unloading because it reduces the heat generation and production of ethylene gas.

A simple device for easing the work of unloading transport vehicles can be constructed using a two pulleys and a strong rope (Fig. 1). One pulley can be mounted inside the truck at the front of the bed, the second outside on a portable post or on a stationary object like the side of a building. Containers can be hung directly by their handles.

A simple set of stairs can be constructed to ease the work of loading and unloading produce. The stairs can be folded and pushed back under the back of the truck when the vehicle is in motion. The steps can be made of wood or steel matting and steel bars can be used for supports.

Using a ramp is a simple and safe method for unloading produce. The ramp should be wide enough to prevent accidents and strong enough to carry the full weight of the handler plus the package she/he is carrying. Providing small carts can also ease the work associated with unloading.



**Fig. 1: A simple device for easing the work of unloading transport vehicles (Source: Pantastico, 1980)**

## 2. TEMPORARY STORAGE

When produce is held at destination for a short time before marketing, the handler can help maintain quality and reduce losses by storing commodities at their most suitable temperature. However, if the storage period is five days or less, relative humidity is maintained between 85 and 95%, and the ethylene level is kept below 1 ppm by ventilation or using a scrubber. Most vegetables can be grouped into the following three categories.

**Table 1: Temporary storage conditions of selected vegetables**

| 32-36°F, 0-2°C |              |          | 45-50°F, 7-10°C | 60-65°F, 16-18°C |
|----------------|--------------|----------|-----------------|------------------|
| artichoke      | endive*      | parsnip  | snap beans      | casaba melon     |
| asparagus*     | garlic       | radish   | cucumber*       | cassava          |
| bean sprouts   | green onion* | rutabaga | eggplant*       | dry onions       |
| beet           | horse radish | rhubarb  | melon           | ginger           |

[Table Contd.]

Contd. Table]

| 32-36°F, 0-2°C      |                     |               | 45-50°F, 7-10°C | 60-65°F, 16-18°C         |
|---------------------|---------------------|---------------|-----------------|--------------------------|
| Sprouting broccoli* | Jerusalem artichoke | shallot       | okra*           | honeydew melon           |
| brussel sprouts*    | kale                | spinach*      | bell pepper     | potato                   |
| cabbage*            | kohlrabi            | snow pea*     | chilli          | pumpkin                  |
| cantaloupe          | leek*               | sweet corn    | summer squash   | sweet potato*            |
| carrot*             | lettuce*            | sweet pea*    | watermelon*     | taro                     |
| cauliflower*        | mint                | Swiss chard   |                 | Tomato (ripe)            |
| celery*             | mushroom            | tumip         |                 | Tomato<br>(mature green) |
| chicory*            | mustard greens*     | waterchestnut |                 | winter squash            |
| cut vegetables      | parsley*            | watercress*   |                 | yam*                     |

\* Sensitive to ethylene damage (Source: Thompson and Kader, 1995)

During temporary storage, certain points have to be kept in mind which is listed below:

- Provide adequate ventilation and air movement in the storage
- Avoid chilling injury
- Avoid water loss (use film wraps, wet the floor of the storage area)
- Avoid mixing ethylene generating commodities with those sensitive to ethylene
- Use flaps on cold room doors to reduce temperature fluctuations
- Use storage racks and stackable boxes to minimize product damage
- Check air and product temperature with a thermometer
- Don't store the most cold- demanding produce directly in front of the cold air outlet
- Use paper wraps or covers to protect chilling-sensitive commodities
- Keep storage area clean
- Use FIFO (first- in, first-out) rotation of produce placed in storage

### 3. REPACKAGING

Repackaging of produce is common when it has been packaged in large containers, such as sacks, boxes, plastics containers, etc. The repackaging process is often carried out using small trays covered with transparent plastic film, which gives an more appealing appearance to consumer. Supermarkets and retail stores display packaged vegetables either on refrigerated shelves or under ambient conditions. Some retail stores and market places use open packages so that consumers can also handle the goods.

Some produce may require washing, trimming, bunching or sorting at the wholesale or retail market level. The layout of the work station used for handling produce at destination should be organized to minimize non-productive movement. Some produce may have to be repacked by the wholesaler or retailer due to changes in quality or uneven ripening. The tomato sorting table (Fig. 2) has work stations for up to five who select either ripe, pink or breakers and allow the green tomatoes to run off to the end of the line. Rejects (culls) are placed in pails under the table.

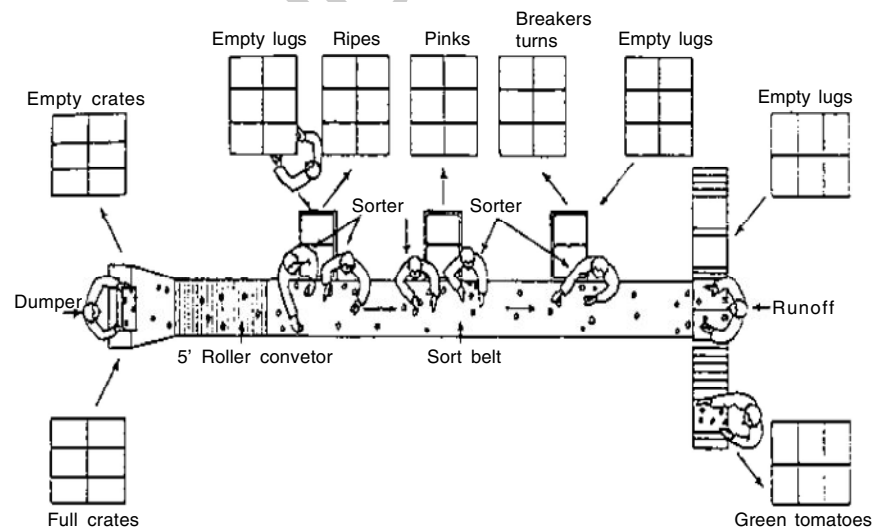


Fig. 2: Tomato repacking methods and equipment

#### 4. RIPENING

Some commodities may require ripening before sale at the wholesale or retail level. Ripening rooms are often used for tomatoes, citrus fruits and bananas. For tomatoes, technical grade ethylene gas is introduced into the room at a concentration of about 100 ppm for about 48 hours. Approximately 0.25 cubic feet/hr of ethylene gas is required for each 1000 cubic feet of ripening room. A small fan can be used to ensure a uniform continuous flow of ethylene into and through the room. Forced-air ripening is increasingly being used to provide more uniform temperatures and ethylene concentrations throughout the ripening room.

Ripening can also be initiated by using ethylene generated by passing ethanol over a bed of activated alumina. This method is safer than using pure ethylene gas. Ethylene-releasing compounds such as ethephon {(2-chloroethyl) phosphoric acid} are sometimes used to ripen tomatoes especially for processing. When using ethephon as a spray, the amount of ethylene released will increase as pH and/or relative humidity increase. Several small ripening rooms may be more useful than a single large room for small scale handlers, since the amount of product handled at destination may vary from time to time. In this case, flow through systems can be designed to allow the use of one or more rooms at the same time. Small scale portable ethylene generators are also available. The ripening conditions of the selected vegetable had already been discussed in detail in the chapter 11.

#### 5. DISPLAY

High levels of post-harvest losses in India are due to poor retailing conditions, where display is in piles or baskets. During display of vegetables, single or double layers of produce are most likely to protect the commodities from compression damage and overhandling by the consumers. Temperatures of the display tables or refrigerated supermarket displays should be suited to the commodity on sale. For example, yellow peppers and tomatoes look pleasing when displayed with lettuce, peppers and tomatoes are chilling sensitive, while lettuce is not. Misting the commodities that can tolerate surface water (lettuce, broccoli, green onions) with cool clean water can help maintain a high relative humidity around



the produce. A simple sprinkler device can be constructed by perforating a pipe with tiny holes and connecting it to a hose (Fig. 3). If this display is used outdoors, shade should be provided.

Outdoor marketplaces suffer from a lack of temperature control and high air circulation, which can lead to desiccation of produce, which will be seen as shriveling and wilting. These marketplaces can often benefit by the increased use of shading and protection from prevailing winds.

This wooden display table (Fig. 3) is designed to be used for commodities such as cruciferous crops or leafy green vegetables that tolerate cooling with ice. The table can be used in the horizontal position or as a tilted display. About 15 kg of crushed ice per square foot of display space are required for cooling per day. A catch pail should be provided for melt water. To minimize ice needs, the display tray should be insulated and kept out of the direct sun.

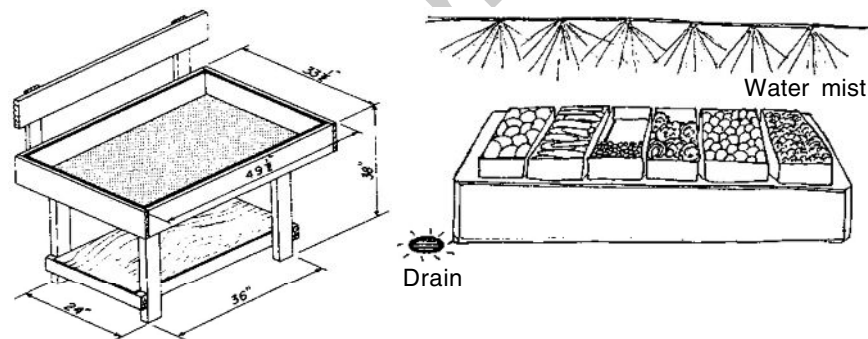


Fig. 3 : Wooden display table (Source: Bartsch et al, No date).

## 6. GENERAL DO'S AND DON'TS FOR HANDLING PRODUCE AT THE DESTINATION MARKET

- Protect unloaded produce from the sun and move containers quickly from the vehicle to the storage area.
- Load and unload produce from vehicles as gently as possible
- Stack containers in cool, well-ventilated storage area.
- Mark containers with date of arrival.

248 | Post Harvest Handling of Vegetables

- Entrance of cold rooms should have plastic strips curtain to reduce temperature variations during produce movement when doors are open.
- Storage rooms must be cleaned periodically to reduce decay organisms and odours.
- Use activated carbon filters in storage room to absorb odours generated by mixed lots of produce.
- Use a pad containing potassium permanganate to reduce ethylene levels, especially if storage temperature is greater than 5°C.
- Resort, trim, wash or ripen produce before marketing to increase its value, than create display of ripened or ready-to-eat produce.
- Create unusual or convenient combination of produce for display.
- Display produce in shallow layers to minimize consumer handling and reduce mechanical damage.

drysrhu

## CHAPTER 15

# MARKETING OF VEGETABLES

---

Marketing plays an important role not only in stimulating production and consumption, but also in accelerating the pace of economic development. Agricultural marketing deals with all the activities, agencies and policies involved in the procurement of farm inputs by the farmers and the movement of agricultural produce from the farm to the consumer. The agricultural marketing system is a link between the farm and the non-farm sectors. It involves all the aspects of market structure or system, both functional and institutional, based on technical and economic considerations and includes pre and post-harvest operations, assembling, grading, storage, transportation and distribution. It is the marketing system that transmits the crucial price signal. The vegetable marketing in India is highly decentralized. There has been concern in recent years regarding the efficiency of marketing of vegetables and this leads to high and fluctuating consumer prices and only a small share of the consumer rupee reach to the farmer. It is observed that Indian farmer is good producer but not good marketer. In 1976, National Commission on Agriculture pointed about the inefficiency in agricultural marketing with particular to fresh perishables and strongly recommended in following words that “It is not enough to produce a crop; it must be satisfactorily marketed.”

Marketing of vegetable crops is complex especially because of perishability, seasonality and bulkiness. Vegetables are an item of daily consumption and are essential in human diet but they are very perishable in nature. Therefore, the cultivation of vegetables is generally concentrated

around towns and cities, so that they can be harvested and transported to the nearby market immediately and in fresh form. With the increase in transport and communication facilities, vegetable cultivation has spread in interior areas where irrigation facilities are available. This is because growing vegetable crops is more profitable than any other seasonal crop particularly the food grain crops. There is also some regional specialization in growing some vegetables. They are grown in one area but marketed in other areas for creating wider market and this also involves long distance transport. For this purpose good road in the interior villages is necessary. Fortunately there are good state and national highways, but there are no good roads in the interior. Vegetables are usually sold through commission agents and very little of pre-harvest contacting is done. Due to this the net returns are generally low. If the farmer does the marketing of his produce himself, then the net returns to him would be double. The costs and margins determine the final price to be paid by the consumer. After deducting market costs and margins from the final price paid by the consumer, farmer gets his net price, which is referred to “Farmer’s share in consumer’s price”. This determines efficiency of marketing. To motivate growers for producing more vegetables, it is imperative that growers get a reasonably good price for their produce. It is also essential to identify the best channel of marketing the vegetables.

## 1. THE MARKETING CHANNELS

The channels of marketing are important aspect of agricultural marketing affecting the price paid by consumer and share received by the producer. The shorter the channel, lesser the market costs and cheaper the commodity to the consumer. When the channel is long with more intermediaries, prices are more and producer’s share is less. The channel which provides commodities at cheaper price to consumer and also ensures greater share to producer is considered as the most efficient marketing channel. The most important marketing channels followed in marketing of vegetables are as follow:

- Producers–consumer
- Producer–retailer–consumer

- Producer–trader–commission agent–retailer–consumer
- Producer–commission agent–retailer–consumer
- Producer–wholesaler–cum–commission agent–retailer–consumer
- Producer–cooperative society–consumer

## 2. MARKETING VERSUS SELLING

Producers can choose to sell vegetable crops to a variety of customers using a wide range of marketing strategies. Marketing requires attitude quite different than does selling. Selling produce ends with finding someone who will take what you have to sell off and pay you for it. Seller is some how being clever enough to get a price high enough to allow to make a profit. Some growers speak of “throwing”, “dumping” or “getting rid of” their produce, as though it is some kind of waste product. Most vegetable growers in India sell their produce even before the crop is harvested and allow a harvested contractor to decide when to harvest and reap the profits associated with postharvest handling and marketing. If growers are uncomfortable with meeting and selling to the people who will eat their produce, or have no particular interest in post-harvest handling, packing, storage and retailing, then they can simply sell their produce directly to a trader or reseller for a minimal wholesales price.

Marketing, on the other hand, requires that the growers/producers determine and meet the needs of their customers before harvesting and packing the product. If growers want to earn more of the potential profits associated with vegetable handling and marketing, and have some interest in applying some of the post-harvest technologies, then they have to think of learning more about direct produce marketing. Marketing is quite different than selling. In marketing grower first trying to find out what buyers want, then supply the produce accordingly to consumer need at affordable price and at that place which is convenient to the consumer.

Marketing produce involves everything from planning exactly what to grow, harvesting at the right time for high quality, proper maturity and food safety, packing and cooling to protect produce quality, storage under proper condition until prices are higher, and transport to a variety of market outlets, to direct sales to customer. Marketing requires knowledgeable about the

produce (its characteristics, nutritional value, use in cooking, etc), packaging (providing protection, information and visual appeal), pricing strategies (offering bulk produce, specialties, value-added products) and promotion (including sales displays, advertising, deliveries and customer service).

### **3. OPERATORS IN THE MARKETING**

There can be many participants in any given marketing system. The main operators in the marketing are listed below:

#### **3.1. Farmers**

Most small farmers are mainly concerned with the growing of crops and their awareness of marketing as a tool to increase income is non-existent or is limited. They learn from other small farmers or from villagers nearby.

To many small farmers, marketing means the sale of produce to a trader to a commission agent. They would sell directly to consumers or to a wholesale market only if the farm is close to such outlets. As their production increases, farmers acquire other sources and information about marketing systems, but in developing countries very few growers have either sufficient knowledge to take advantage of the marketing choices available.

#### **3.2. Traders**

The role of traders is essentially to act as the link between producer and distributor. They are mostly entrepreneurs whose income depends on matching the supply of produce with the demand of the market. They range from small family groups on a local level to large international companies dealing with export and import of produce in many countries.

The marketing of vegetables in developing countries is marked by a large number of small traders who play an indispensable role in the marketing system. Their importance is, however, not always appreciated and their profits are often considered excessive, largely because farmers and government officers are unaware of the traders cost.

### 3.3. Commission Agents

The role of commission agents is to take produce owned by a farmer or a trader and sell it at best price possible. They may find a buyer in an organized wholesale market or by direct contact with distributors.

The commission system has advantages for the farmer, who is likely to get a higher price than he would if sell to an intermediate trader, even though the farmer carries the risk of loss always present in the marketing of perishables. The farmer's confidence in the agent rests on the knowledge that the agents income depends on his getting the best deal for the farmer.

### 3.4. Wholesalers

Wholeselling is the one that covers activities of all individuals or businessmen, which sell to or negotiate sales with customers, who buy for resale or industrial use. His position is that of an intermediary between manufacturer and retailer.

Wholesalers are classified as:

- Local wholesalers, who deliver their purchases to local retailer.
- Provincial wholesalers some time called as distributor and sell the produce to the retailers of a particular district or a state.
- National wholesalers located at a strategic place and distribute produce all over the country.

### 3.5. Retailers

He is the last link in chain of marketing who sells produce directly to consumer. He buys his requirement usually from the wholesalers. Retailers in producing areas may have direct contact with producers and buys goods from them for resale. Market demands for all commodities are essentially determined by retailers, who therefore have great influence on market prices. What the retailer buys reflects the quality and quantity of what he thinks his customers will buy. Farmers and traders should maintain contacts with retailers to be aware of market preferences so that they can arrange production and post-harvest handling practices to provide produce of the

desired quality. Although retailers try to buy produce at the cheapest possible price, most of them will apply a standard mark-up and thus will obtain their usual profit margin regardless of the wholesale price.

## 4. TYPES OF MARKETING

The marketing options include the following

- Wholesale Marketing
- Retail Marketing

### 4.1. Wholesale Marketing

Wholesale marketing is a highly competitive business, involving brokers, commission agents, auctioneers, receivers, distributors and producers. It includes marketing direct to local produce markets/supermarkets, food service providers/school, restaurants/hotels and wholesale marketing cooperatives. Whenever the supply of a specific type of produce is higher than projected demand, prices can fall to very low levels and producers will find it more difficult to make a profit. Some of the practices and technologies can be utilized directly to assist in wholesale marketing efforts:

- Avoid seasonal gluts by producing earlier or later than other growers.
- Produce cultivars with specially characteristics (flavour, appearance, storage potential).
- Use maturity indices to assure highest quality at harvest.
- Sort by quality/maturity to maximize marketing options.
- Field pack to minimize mechanical damage and protect quality.
- Use packaging that will protect produce during handling and extend shelf life
- Cool produce properly (avoid delays in cooling, avoid chilling injury, provide the proper RH environment) to extend shelf life.
- Store the produce on the farm to avoid selling during glut supply periods.

One way to increase potential profits is to market directly to local wholesale customers such as food markets (produce departments, independent retailers, supermarkets), industrial food service operators



(school, hospitals, prison cafeterias), restaurants and hotels, or specially retail food shops (health food stores, gourmet shops) rather than selling produce only through regional terminal markets. Another option is to reduce your total costs by selling to food processors.

Finding a niche market will greatly increase potential profits. Market niches are unpredictable, but often are related to something new or unusual. Providing safe food may be a niche market. Doing something better than it is currently done can fill a niche, for example, providing organically grown vegetables that are free from pesticides. Truly unusual products can sell well if marketed to innovative people, such as a chef known for his unique cuisine. Sometimes nutritious vegetable will be highlighted in the media and will suddenly become popular. A new product that sells well at a high profit today may have to come down as competitors flood the market. Consider niche markets to be temporary and always be on the lookout for a new idea.

#### **4.1.1. Wholesale markets**

The wholesale market provides a convenient point for gathering large amounts of produce from many sources to meet the needs of retailers. In developing countries, incoming produce is most commonly owned by a trader or may be consigned by a cooperative, whereas in developed countries most produce is consigned by farmers.

Wholesale markets may function daily, where farmers or traders bring only small quantities of produce of every size and quality. Facilities are minimal and prices are correspondingly low in wholesale markets. Retail merchants may compete with private customers and will generally get better price because of bulk purchasing. Many such retailers are street hawkers, though others may operate stalls in the market itself, keeping longer hours than does the wholesale operation. Such combination markets are common in India.

#### **4.1.2. Assembly markets**

An assembly market is much like a farmer market except that producers deal with traders instead of directly with consumers. It is a farmer market

on a wholesale level. Traders find assembly markets convenient in saving their expense and time as they need not to travel to farms to collect the produce.

Assembly markets tend to start from a natural need by buyers and sellers, and their location will usually be determined by proximity to good transport (road, rail) or water, so that traders can quickly move their purchases to markets.

The operation of an assembly market can be simple, but a successful one will soon attract people providing services such as weighing, packaging, loading equipment and perhaps even banking. The building of a marketing hall will be used for buying and selling operations under cover and out of the weather, and may attract other services like packing and storing.

Assembly markets can be operated by farmers through some cooperative association, by municipal or central government bodies or by a number of large traders. There is, however, the danger that sectional interests taking control of operations can put other groups or persons at a disadvantage.

#### **4.1.3. Wholesale to processors**

While this marketing option is one of the least complicated for growers. The price producer will receive for produce sold to processors is usually very low compared to the price for fresh produce sold directly to retailers. There is a tendency for producers to believe that they can get rid of their sub-standard “out-of-grade” produce by selling it to processor, but this is not likely, unless a predictable volume of produce at the packinghouse is regularly out- of-grade due to extreme ripeness. Certain melons and stone fruits can be processed (frozen or dried) when they are too ripe for successful fresh handling.

Generally a legal contract is made between the producer and the processor, and planting is done on a pre arranged schedule so that a certain amount of produce is supplied over specified time at a specified price. Some processors provide production and harvesting assistance such as seeds, cultivation advice, harvest labour and/or transport to the processing facility.

#### **4.1.4. Industrial food service customers**

Buyers for these operations often need large quantities of fresh produce, delivered over the season. They are generally not interested in purchasing specialty, high priced produce.

If a producer become a supplier for a local school, hospital, camp, nursing home or prison; he will need to plan production to extend the season to maximize sales. The combination of multiple planting dates, multiple cultivars, production practices and storage methods can supply fresh produce over a long period. Produce can usually be delivered in large sized packages.

#### **4.1.5. Restaurants and hotels**

Since restaurants and hotels have to plan menus well ahead of the produce season, they need a consistent supply at a stable price. Most buyers for these operation want fresh, clean and on time produce. Chefs can give direct feedback to producer on flavour, varieties, size, packaging and the other characteristics of the produce. So the grower has to plan the next year planting according to their demand. Some chefs are willing to try exotic produce or processed product in their restaurant. Even they are willing to pay more for produce that has been washed, trimmed or fresh-cut. If the cold storage facilities at the restaurant or hotel are small, grower may need to make frequent deliveries.

#### **4.1.6. Contract farming/marketing**

Contract farming or marketing essentially is an arrangement between the farmer-producers and the agri-business firms to produce certain pre-agreed quantity and quality of the produce at a particular price and time. It can only be a pure procurement transaction or can extend to the supply of inputs or even beyond. Contract farming is emerging as an important mode of procurement of raw materials by agri-business firms in India due to the developments in the field of agricultural marketing, changes in food habits and in agricultural technology in the new economic environment. This is an important initiative for reducing transaction costs by establishing farmer processor linkages in addition to the already existing methods of

linking the farmers to the consumers. The distinction between ‘sales’ and ‘contract to sell’ needs to be understood clearly. In the case of sale, the title or ownership of goods is transferred at once whereas in the ‘contract to sell’, the goods are transferred at a later date. A contract to sell is not in the true sense of the word a sale, rather it is merely an arrangement to sell. A contract is an agreement but an agreement is not necessarily a contract. In contract farming, companies or organizations engaged in processing and marketing of agricultural products are entering into contracts with the farmers. They provide inputs to the farmers and buy back the product at a rate specified in advance. Following type of inputs and services are normally provided by the company to the farmers.

- Seeds of the variety they need for processing/marketing
- Guidelines to grow the crops
- Pesticides which do not result in residual toxicity
- Extension services
- Fertilizers/hormones required for the crop
- Other material if not locally available.

The contract may be entered into by parties anytime from the start of the sowing to the harvesting, processing, packaging and marketing stage of the crop. Normally, the contract is entered before the start of the sowing because the buyer can then stipulate the conditions for cultivation and postharvest handling. The buyer of the produce generally keeps the right to monitor the crop at every stage of its growth.

**Advantages of contract farming:** Contract farming/marketing is beneficial both for the producer farmers as well as to the processing company in several ways:

To the farmer, contract farming -

- Reduces the risk of price/production
- Ensures the price as market is assured
- Increases the quality consciousness
- Ensures higher production because of better quality seeds and pesticides.
- Reduces marketing costs

- Provides financial support in cash or kind.
  - Ensures efficient/timely technical guidance almost free of cost.
- To the company, contract farming-
- Ensures supply of quality produce at right time and at lesser cost to the company
  - Channelize direct private investment in agricultural activities.
  - Ensures that the toxicity level is reduced as per requirement for export.

**Weaknesses of contract farming:** The important weaknesses of contract farming are:

- Contract farming is involved mostly in cash crops which may lead to shift in area from food crops.
- Contract farming may create the danger of imposition of undesirable seeds.
- The temptation of getting commercial profits from cultivation of a variety of the crop may cause permanent damage to the land.
- Market making outside the country may cause market breaking inside the country.

However, contract farming is a welcome development. But the contract should be made under high scrutiny possibly because of exploitation of the farmers. The terms of the contract should be spelt out in advance and a consent letter is obtained both from the farmer and the company. The government should establish a monitoring mechanism and a dispute settlement body to ensure that both parties adhere to the terms of contract.

Contract farming has been found to be successful in vegetables like gherkins (pickling cucumber), with large processing demand. VST Natural Products Limited in Andhra Pradesh was able to have contracts with the gherkin farmers by providing seeds, credit and other technical inputs for supplying gherkins which were processed and exported. The contract farming in the case of tomato farmers of Punjab and by the Hindustan Lever Limited company was not so successful but contract farming practiced by Bharti Field Fresh in baby corn is great success in Punjab. Presently contract farming is confined to few selected crops in selected pockets. However, here is enormous scope for contract farming/marketing

because with the increasing income, consumers are becoming more health and quality conscious and look for branded products. The Ministry of Food Processing Industries of Government of India has launched a scheme entitled 'Grant under Backward Linkages' to promote contract farming. Under this scheme, a grant of 10 percent of value of raw material purchased from the contract farmers (subject to a maximum of Rs. 10 lakhs per annum) is provided to food processing units upto three years.

### **GENERAL DO'S AND DON'TS FOR WHOLESALE MARKETING**

- Meet customer to inquire about their produce needs (what they want to purchase, how much and when).
- Assess the marketing option to determine which will be profitable
- Pack produce in standardized, new containers by standardized grade (usually by size)
- Check products before transportation to ensure they will meet all the buyers specifications for quality, grade, packaging, volumes or weight.
- Adopt more than one marketing strategy and selling produce to more than one buyer.
- Provide only high quality products, consistent over the season.
- Offer samples of new produce or processed products to prospective buyers.
- Transport the agreed quantity on the agreed date.
- Provide buyers with information on the proper conditions for wholesale level storage of produce. e.g. Refrigerated and moist for leafy greens; cool and dry for onions and garlic.

#### **4.2. Retail Marketing**

It includes marketing direct through farm shops, roadsides stands, pick-your-own operations, farmers market and retail marketing cooperatives. One of the best reasons to direct market is to provide the fresh produce possible by reducing the number of times produce is handled and minimizing the distance between the farm and the market. Some of the benefits of direct retail marketing include:

- Cash sales (immediate payment)
- More control over market prices (higher prices)
- Low volume is not a problem
- Flexible working hours
- Packing, grading, labelling exemptions
- Opportunity to test new products
- Immediate feedback from customers

Some of the practices and technology can be utilized directly to assist retail marketing efforts includes:

- Avoid seasonal gluts by producing earlier or later than other growers
- Produce cultivars with specialty characteristics (flavour, appearance, storage potential)
- Use maturity indices to assure higher quality at harvest
- Sort by quality/maturity to maximize marketing options
- Field pack or ranch pack to minimize mechanical damage and protect quality
- Use containers that will protect produce during handling and extend shelf life
- Cool produce properly to extend shelf life
- Store produce on the farm to avoid selling during glut supply periods
- Ripen produce before marketing to increase sales
- Create displays of ready-to-eat produce (washed fruits, mixed salad greens)

#### **4.2.1. Farmer markets**

These markets are simple retail operations where farmers sell produce directly to consumers. They occur in towns or cities and may be in a covered market hall or on an open street, on a daily or a weekly basis. In these markets farmers sell the produce directly to consumers and can get much higher prices (and in cash) than by selling to traders. To deal with retail customers takes time and moves only small quantities of produce. Losses can be high from customers pinching of produce, which

then must be discarded if sufficiently damaged. The industrious farmer can spend his time more profitably elsewhere.

#### 4.2.2. Retail outlets

As cities grow and exercise more economic power, the trend in retailing is away from street stalls and hawkers and toward fixed shops and supermarkets.

- (i) **Hawkers:** Although they have been part of market systems for centuries, hawkers are actively discouraged in many countries as being traffic hazards and as not contributing much to overall marketing schemes. Hawkers do, however, benefit lower-income consumers by selling at low prices much low-quality produce which might otherwise be a dead loss. Any reduction in their numbers should be the result of more efficiency and better prices in retail outlets and not of official harassment.
- (ii) **Public markets:** Public retail markets have varying degrees of importance, ranging from being the major source of produce for consumers to being a minor supplement to its sale in shops. The usually low prices reflect low overhead and operating costs, but the confinement of produce retailing to central market districts means that customers must travel some distance to market. The emergence of small fixed shops will eventually divert customers away from central markets, even if they must pay higher prices.
- (iii) **Retail shops:** Prices of produce in retail shops reflect a greater variety of goods of a higher standard of quality than those found in public markets. Competition between retailers is based mainly on attracting customers by concentration on shop decoration, presentation of produce and personal contact between staff and customers. Such shops are likely to be situated in or near residential neighborhoods.
- (iv) **Supermarkets:** Retail shops can efficiently and quickly turn over large quantities of produce but, with increasing costs that inevitably follow economic development in communities, retail shops are pressed to sell ever greater quantities in order to retain profitability. Thus supermarkets with their greater financial resources can move into produce-selling at a relatively small increase in overhead costs.



Supermarkets can and do negotiate directly with growers for supplies of fresh produce, thus eliminating middleman costs entirely and selling produce at prices matching those of farmer markets. In developing countries, however, produce in supermarkets is generally more expensive than in open markets, largely because of packaging, high-quality produce and the attraction for the usually affluent customer of easy parking and one-stop shopping.

#### **4.2.3. Pick- your-own**

In pick-your-own method, the customers harvest the produce themselves. The field must near the city, easily accessible by major road or located along a tourist route. Location is the most important factor in whether it is possible to develop a profitable pick- your-own operation. Some variations on this theme include “rent-a-row”, “rent-a-garden”, “U-pick” Operation. The grower can offer lower prices since his cost is reduced (no harvesting cost or packinghouse operations to run, minimal packaging and cooling, no transport or storage). There are some new costs, similar to those of other direct marketing operation (insurance, promotional activities, developing parking areas and providing harvest supervisors and sales personal to work with customers).

The crops especially profitable for pick-your-own operation are those that require a lot of labour for harvesting, packhouse operations and packaging for wholesale or retail sale. Examples include peas, green beans and okra. Other crops well suited to these operations are those that taste better when harvested at full ripe stage e.g. tomato, muskmelon etc.

#### **4.2.4. Co-operative marketing**

When producers of agricultural commodities form a society with an objective of carrying out marketing of their produce, such society is called as co-operative marketing society. The need for co-operative marketing arise due to many defects observed and experienced in the private and open marketing system. There are several malpractices prevail in the marketing of agricultural produce. For example, arbitrary deductions from the produce, manipulation of weights and measures and cheating the

farmers, delay in payment to farmers, etc. In such circumstances co-operative marketing society can largely help the farmers to reduce the malpractices and offer honest and correct services.

There exists a chain of intermediaries between the producer and the final consumer. They include village merchant, trader, wholesaler, commission agent, pre-harvest contractor and retailer. They take their own margins for the services they render. But these margins are generally exorbitant, making the commodities costly for the consumers and reduces the producers share in the consumer's price. A co-operative marketing society can eliminate some or all of the intermediaries and can reach to the consumers and establish direct trade relations with them. This will make commodities cheaper to the consumers and also ensure good quality of produce to them because much of the handling is avoided.

There are some services such as transport, storage, grading, packing, loading/unloading, which are carried out by some private functionaries who charge high rates for these services. A co-operative marketing society performs these services efficiently and at cheaper rates. A co-operative marketing society provides market finance to farmers and ensures better returns to their produce. Cooperative marketing society can also act as an agent of credit co-operative society and help to recover loans advanced by credit societies. At present, most of the financial needs of the farmers are fulfilled by trader - moneylenders at very high rates of interest and with the condition that they will sell their produce through them. This can be avoided, if there is cooperative marketing society. Under the system of co-operative marketing whole responsibility of marketing is taken up by the farmers themselves, organized on co-operative basis. The area of operation of marketing society is usually fixed with reference to local conditions.

It was also observed that HOPCOMS in Karnataka and vegetable cooperatives in thane district helped the vegetable growers by offering higher prices as compared to other intermediaries. These are societies at the producer's level and they federate at state or national level to deal with bigger markets including foreign markets for export of their produce. Incentives have been announced by the Ministry of Food Processing Industries of Government of India for providing financial assistance to

establish cooperative processing units, infrastructure parks and also for establishing backward linkages with producers. The National Horticulture Mission is also providing financial support for establishing the cooperative marketing.

#### **Functions of Cooperative Marketing:**

- To arrange for the sale of members produce to the best possible price.
- To undertake activities in connection with grading, pooling and procurement of produce of the members.
- To provide storage facilities to their members by renting or owning the godowns and thereby facilitate to grant advances against pledge of produce.
- To protect members from all types of malpractices, eliminates the middleman in the chain of marketing.
- It ensures supply of good quality material to consumers.
- It teaches business methods to farmers and serves them as agency to supply market information.
- The society is able to stabilize prices over a long period by adjusting the supply with the demand.
- Marketing societies are also encouraged to undertake export trade.

#### **4.2.5. General do's and don'ts for retail produce marketing**

- Meet customers to inquire about their produce needs (what they want to purchase, how much and when)
- Assess your marketing options to determine which will be profitable.
- Adopt more than one marketing strategy and selling the produce to more than one buyer.
- Provide only high quality products, consistent over the season.
- Create attractive displays and keep the produce section clean.
- Offer samples of new produce to prospective buyers.

## 5. MARKETING STRATEGIES

The aim of a commercial marketing strategy is to sell a commodity at the time and place that can bring the highest possible return. To develop a marketing strategy for vegetables is much more complex because of their fragility and perishability. There are few marketing strategies that can be adopted to give better returns to the stateholders and these are discussed below:

### 5.1. Supply of Produce

The supply of a commodity is calculated from the total quantity of produce that is grown and from the period during which it is available. The quantity on a particular market is determined by the area under cultivation, the productivity of the crop and the amount of that crop brought in from other areas. The supply of most commodities moving to markets in developing countries usually varies over a year, but there is considerable potential for change by manipulating both production and transport factors to level and extend the supply.

#### 5.1.1. *Changing production volume*

Changes in vegetable growing patterns will come about through market forces. For example, when a market is under-supplied with a product, the resulting high prices will encourage farmers to increase the area under that crop. To bring about changes in cultivated crops is more difficult in farming communities that are poorly educated and have little concern with marketing. The opposite can happen if farmers become too conscious of market trends and readily change crops if they have a poor market return.

#### 5.1.2. *Transport to other markets*

Problems of over- and under-supply can be more quickly balanced by transporting produce between districts with surplus or scarcity. Knowledge of prices is essential for profitable trade between such districts i.e. there is need to establish an organized market information system. Inter-district trading can be organized on a long-term basis using information on annual market trends or in response to a short-run supply in a market. For example,

heavy rains can so damage a vegetable crop that supply to local markets are severely cut and prices raise quickly. Traders familiar with regional prices can soon restore equilibrium by transporting supplies of the scarce commodity. By the same means, farmers aware of prices can save themselves the effort and expense of consigning produce to glutted markets.

### **5.1.3. Seasonal supply**

The harvest period of vegetables can be short, with limited quantity of the crop available at the beginning and end of the season and the peak production period coming in between. The out of the season vegetable crops gave more returns to the farmers and traders due to high price. Pre-harvest manipulations like growing location, protected cultivation, farming practices, cultivar selection can spread out harvesting period and post-harvest techniques can extend the marketing period.

## **5.2. Market Information**

The ability of a grower to plan and act on an efficient marketing strategy for vegetables will be greatly aided by access to accurate, adequate and timely information on all aspects of the commodities being traded. Although every person in marketing is in the course of his work collecting and analyzing information, no individual has the resources to gather information on all markets interest. The breadth and diversity of market information can be collected and processed only by some system.

In addition to supplying data to market operators, a market information system performs a valuable public service by making market transactions more transparent. Its best result will be its moderating influence on price fluctuations, as farmers and traders can act more confidently to balance supply and demand and make it more difficult for dishonest or deceptive practices to go unnoticed.

### **5.2.1. Users of market information**

All sections of vegetable industry will benefit from a market information system, although each group will use it differently:

- Farmers need market information in order to plan production and harvest dates and post-harvest operations; it can also give guidance on time, place and price at which to sell produce;
- Traders will be helped to find those markets yielding best returns, and retailers will more easily locate sources of supply; since both buyer and seller will be aware of prices being paid by competitors, they will more confidently operate on lower profit margins, with resultant benefits to farmers and consumers;
- Transport operators can use market information in order to schedule staff and vehicles more easily;
- Storage agencies will be able to use their facilities more efficiently if they are more alert to market trends;
- Consumers can be benefited as market information system generates more competition among retailers
- Governments can use market information to develop a sound agricultural policy in regard to food and to monitor national economic development; it can also be used to produce development programmes or export drives and even to establish the need for better roads and additional transport.

### **5.2.2. Market price**

Market price is the most important information required by market operators. Price data need to be collected from all the major types of trading outlets, and the system should therefore include prices paid at the farm gate, assembly markets, central wholesale markets and retail outlets. If substantial import or export of produce takes place, separate records of those prices should be maintained.

### **5.2.3. Source of data**

Price data should be authenticated by the location from where it is obtained. Although some averaging or amalgamation of data is inevitable and it is often desirable to calculate a national average price for commodities, Similarly, for exports and imports, the prices obtained and prices paid for produce at or from different countries should be separately reported.

#### **5.2.4. Trading volume**

The volume of produce presented for trading in different markets is of considerable importance since volume is a direct determinant of market price. Data on arrivals in assembly and wholesale markets, outgoing dispatches to other markets and traders, and stock being held in a market should be collected.

#### **5.2.5. Marketing costs**

Costs and charges incurred at various stages of the marketing chain could be reported with information on market charges, costs of transport, and stock held.

#### **5.2.6. Market reviews**

The publication of daily or weekly market information in price and volume of produce traded is useful for a continuing assessment of market strategies, but it can also be adapted for long-term planning by analyzing market trends on a quarterly, semiannual or annual basis and for making comparisons with performance in previous years.

### **6. CONSTRAINTS IN FRESH VEGETABLES MARKETING**

- Lack of basic infrastructure viz. cool chains, logistics and supply chain management. The infrastructural problems, pertaining to the cold storage facilities are non-availability of cold stores at some places while of under-utilization at existing cold storages. Development of competitive international transportation, linked to domestic air transport or road and rail transport would help in reduction of post harvest losses.
- Lack of proper grading and quality control system.
- Scattered productions and sometimes in isolated places where even the transportation facilities and other infrastructure is not sufficient for the perishables.
- Lack of unity and organization skill among the farming community, which proves a major constrain in the formation of cluster groups and co-operatives.

- Inefficient and Imperfect markets: Due to prevalence of many intermediaries and malpractices followed by middleman in the price fixation and auction of the perishables in the marketing channel, there is uprise in consumer's price and the producer's share.
- Improper consumer packaging practically unknown in domestic markets : Improper pre and post harvest handling without any sound packaging leads to heavy losses of the produce on reaching the consumer.
- Lack of forward and backward linkages: Absolute lack of the much needed quality inputs, ignorance about new techniques of cultivation, extension backup at proper time and post-harvest processes results in heavy post harvest losses.
- Perishability and Storability: Fresh vegetables penetration is restricted to the certain niche markets and stakeholders due to its limited shelf life. Besides the presence of insufficient numbers of storages and cool chain facilities adding to the woes.
- Low exports: Emergence of many competitive markets with comparative advantages in awake of the globalization and the imposition of different barriers like sanitary and phyto-sanitary measures (SPS) and GLOBALGAP resulted in limited exports of the perishable commodities. Thus a planned strategy is to be made to target the international markets.
- Freight charges: High air freights are also hindrance for cost effective exports. For the exports, fluctuations in the regular supply of vegetables causes problem to remain a regular trade partners.
- Long marketing channel: Prevalence of many of the intermediaries in between the supply chain robbing the lion's share of the producer's by deeply penetrating the consumer's pocket.
- Non-functional Agri Export Zones: Even after more than 10 years of starting of the Agri-Export-Zones in deferent specific production pockets of different produces, full implementation is at its nascent stage due to many socio-political reasons. Thus the final benefit doesn't reaching to the destined.
- Poor post-harvest care and handling of the produce: Improper pre and post harvest care and handling leads to heavy loss ranging from 20-40 percent of the produce.



- Prevalence of primitive methods of selling and price fixation like, secret sale, private negotiation, under cover etc.
- Meager involvement of Government and other cooperative marketing agencies alike to the private agencies.

## 7. STRATEGIES FOR IMPROVEMENT IN MARKETING

### 7.1. Development of a Plan

The methods available to improve a marketing system are almost infinite. The key to successful marketing improvement is to determine which of these methods are most suitable for a particular marketing situation. Any marketing improvement programme must be preceded by a study of the existing marketing situation. Then goals for improvement can be established, to be followed by a plan for action. The active cooperation of vegetable marketing groups is, however, essential to assist in the study. The evaluation must identify the size and shape of:

- All inefficiencies in the present marketing operations
- All inadequacies in services
- All weaknesses traceable to poor organization.

The social and economic targets to be achieved need then to be defined, and the deficiencies in the present system ranked in order of importance with respect to these goals. The seriousness of each deficiency in technical terms should also be given with an assessment of possible technical solutions.

The development plan can be short, medium or long term. It is usually commodity specific or a subsystem of the marketing chain. It should describe various options to improve marketing in terms of social and economic costs and benefits and their feasibility. The action plan should provide a timetable for the various components:

- Organization and management procedures required
- Targets to be achieved
- Delegation of responsibilities for action to specific people or groups.

Although the government may hold responsibility for coordinating such a plan, the follow-up work should be passed on to industry people such as

a market authority or farmers' association, and this could include responsibility for financing parts of the plan.

## 7.2. Training of Marketing Personnel

In India, lack of qualified personnel is a major constraint to bring improvement in the marketing system. A prerequisite of any marketing development programme is the presence of people experienced in all aspects of vegetable marketing. Personnel helping to implement the improvement programme must be qualified in the various supporting technologies and management systems. Experience and knowledge will be required in order to implement:

- an advisory service to assist farmers and post-harvest handling agencies;
- the management of storage facilities and packing houses;
- the organization of market facilities.

Farmers and traders will need training not only in the introduced technologies but also in the need for continuing improvements in marketing. Training of all personnel associated with marketing operations needs to be a national priority if marketing development is to succeed. Additional training must also be given to officers of extension services, who must themselves acquire enough knowledge of marketing activities to assist farmers.

## 7.3. Marketing Research Services

Marketing research sections are increasingly useful to governments in order to:

- collect information on the level of efficiency and activity of local marketing operations;
- keep abreast of technological developments in other countries and of their potential value to local industry;
- be aware of changing market profiles and the opportunities they present to local traders;
- act as a resource group to issue reports and stimulate discussion on improving marketing.

The section would conduct pre-investment surveys and feasibility studies for government plans but could also provide similar services for private projects of national significance. Activities of the section would require a specialist in marketing economics, but it should have access also to specialists in all other subjects pertinent to vegetable marketing, such as agricultural science, post-harvest technology, town planning and construction engineering.

#### **7.4. Assistance to Small Farmers**

Mostly vegetable growers in India are small farmers, therefore, any programme to improve marketing must include plans to upgrade their activities. Efforts directed to this end will be consistent with national development policies as most countries give high priority to improving the economic status and quality of life of the small farmer.

##### **7.4.1. Problems to confront**

Rapid economic development of small farmers is not easy to achieve. Their status is characterized by:

- small landholdings, usually less than 1 hectare;
- lack of access to markets because of inadequate roads or transport;
- haphazard choice of crops; careless preparation of produce for market;
- unawareness of post-harvest technologies and facilities;
- forced dependence on a restricted trading environment;
- lack of control over pricing;
- lack of marketing extension services;
- insufficient resources to change marketing practices.

These are some of the obstacles to general development and must be addressed before small farmers can enter the economic mainstream of a developing country.

##### **7.4.2. Improvement programmes**

The immediate aim of a marketing improvement programme is generally to generate a higher income for farmers through:

## 274 | Post Harvest Handling of Vegetables

- reduced production and marketing costs;
- reduced post-harvest losses by the introduction of better farming and post-harvest handling methods;
- achievement of higher market prices because of improved quality of produce;
- training in marketing strategies.

It is not possible to achieve all these goals in a beginning marketing improvement programme. Priority must be given to identify and attack the main obstacles to progress, and all farmers will not have identical problems. Thus the programme for each farmer must confront his problems, propose solutions, and balance the costs with the likely benefits.

Problems like bad roads are easy to identify, but to orient the supply of produce to meet market needs is much more difficult to accomplish. The effective programme for small farmers will have to consist of a package of technical and logistical proposals; a few unrelated and superficial changes will not be sufficient.

Furthermore, the success of an improvement programme will depend on the establishment of a range of marketing services needed to achieve the development objectives. They can be:

- a physical service, such as extension officers to advise farmers;
- an information service, for the provision of data to plan a flexible marketing strategy;
- a resource service, to assist in getting investment credits.

### 7.5. ROLE FOR ENTREPRENEURS

Improvements in vegetable marketing can be made possible by the provision of various technical supports, but the rate of development will depend to a large extent on how quickly these changes can be incorporated in day-to-day operations.

Government activity in promoting marketing improvement is important but its effect in the market place is limited. The most effective bodies to work for change are the private commercial enterprises concerned with

trading because their livelihood depends on conducting an efficient business that meets the needs of the industry. They are therefore most likely to respond to any changes that can work to their benefit.

In the traditional market operation, where produce passes from the farmer to a wholesaler and a consumer through a trader, the trader is seen in a necessary. Regulations to control trading have been adopted; cooperatives have been formed to eliminate private trading. The results are inconclusive, but the economic struggles facing cooperatives show that commercial trading requires considerable managerial skill and that traders' profits are in proportion to their ability to service the market. Many government-sponsored and cooperative marketing ventures have failed for lack of a profit motive and a sense of cost-effectiveness. Private traders are acutely conscious of cost-effectiveness. They should be considered as a resource in any programme to improve marketing.

drysrh

## CHAPTER 16

# EXPORT OF VEGETABLES

---

India has wide variety of climate and soil on which large number of vegetable crops are grown. The production of vegetables has tripled in the last 50 years with production of 125 million tones of vegetables. The projected demand of vegetables by 2020-21 is 220 million tones. At present, India accounts for 16 percent of world production of vegetables and ranks first in production of okra and second in brinjal, cabbage, cauliflower, pea, tomato and onion. Today horticultural crops cover about 25 per cent of total agricultural exports of the country and the major exports include onions, mango pulp, fresh mangoes, dried walnuts, fresh grapes, loose and cut flowers, spices and dried and preserved vegetables. The horticulture sector contributes about 28 per cent towards agriculture GDP from only about 13 per cent of the cultivated area. Although India has achieved considerable horticulture production level and reached second position next to China but hardly 1% of the horticulture produce are exported. India export's of fresh vegetables has increased from Rs 1902.44 crores in 2007-08 to Rs 7996.62 crores in 2009-10. Over 90% of India exports in fresh vegetable goes to west Asia and East European markets. Major importing countries of Indian vegetables are UAE, Pakistan, Sri Lanka, Nepal, Bangladesh and Malaysia. The major strength and weaknesses for export of vegetables are discussed below:

### 1. STRENGTHS

India's strengths in the vegetable sector include production of wide range of vegetables varieties in one or other part of the country due to varied

agro-climatic conditions and is also the second largest producer of vegetables in the world. Moreover, the cheap and trained manpower is easily available. It is strategically located, being close to the Middle-East and South-East Asian countries i.e. it is easy to export in these countries.

## 2. WEAKNESSES

The main constraint behind the lack of export is the quality of vegetables. The Indian farmers are frequently using chemicals and fertilizers even without their need and are least concern about their residual effects on vegetables. Moreover, negligence in processing, hygiene, packaging, transportation etc also affects the quality of products. As a result, Indian can not claim to have an assured place in international markets. It has also been experienced that some our country's export consignments were rejected at the destination on account of not meeting the recommended international standards due to pesticide residues. Secondly due to highly perishable nature of vegetables about 25-40 percent of produce get wasted due to lack of adequate post harvest handling which cut down the export. The storage and transportation of vegetable produce is lacking in many respects with the result that its quality cannot be maintained. The cold chain network used in the country is primitive and under developed. Human resource development is another area, which is cause for concern. Training of farmers is equally essential for preserving the quality of harvested crop. Similarly, manpower that handles postharvest produce at the industry level also needs to be trained. Moreover, different foreign markets require different varieties. For example, Japan and European markets demands yellow and brown coloured varieties of onion whereas, gulf-countries and South East Asian countries require light to dark red coloured varieties. The quantity demanded also differs in various months owing to no local production particularly in South East Asian countries. In European markets the requirements is mainly from November-December to April-May when there is no local production or stored products is not available or preferred by the consumer. Besides, there is lack of varieties having good shelf life and their demand in the export market. Since we do not have good and uniform variety in any of crop, lot of labour and money is wasted in sorting and grading operations. Moreover, quality control measures at grading and packing levels are not perfect. Higher air freight rates and inadequate air-cargo space also cut down the export of vegetables.

Another reason why India has not been very successful in the export market is that most of the produce was purchased from the wholesale market or from the contractors. Therefore the exporter does not have any knowledge about the pre-harvest care during the growth period. Latent infections therefore appear by the time the produce reaches the importing country. In this way it is a big setback to our exports. The only solution to this problem is contact farming under the supervision of exporters. Another problem is the traceability of the consignment. In this way the feed back received from the importer cannot be passed down to the supplier; in the absence of which the measures to improve quality cannot be undertaken. Moreover, vegetables are main food items in India, domestic price and demand are high which hinder regular export. There is a big competition now from our neighboring countries like Thailand, Malaysia, Bangladesh and Pakistan, so India should honour a minimum export quantity and agreed delivery.

### 3. EXPORT PERFORMANCE OF INDIAN HORTICULTURE SECTOR

India's major export from the horticulture sector are fresh fruits and vegetables, fruit pulps, pickles, chutneys, canned fruits and vegetables, concentrated pulps and juices, dehydrated vegetables and frozen fruits and vegetables. If we look at the value of exports from this sector, we got the following pictures (Table 1).

Table 1 reveals that there has been a slow but steady growth in the exports of both fresh and processed fruits and vegetables from India. The export of Indian fruits and vegetables is primarily to the neighboring countries in South Asia and the middle East.

Apart from time, the number of fruit and vegetable processing units have also been establishing up steadily. Moreover the government is also providing huge financial aid under National Horticulture Mission for uplifting the horticulture sector as a whole. The Agricultural and Processed Food Products Export Development Authority (APEDA) have identified traditional and non-traditional vegetables having good export potential as about 63 items of vegetables are traded in world market. India has been exporting fresh onion, other fresh vegetables, canned and dehydrated



**Table 1 : Export statement of fresh and processed fruits and vegetables**

|   | 2007-08    |           | 2008-09    |           | 2009-10    |           |
|---|------------|-----------|------------|-----------|------------|-----------|
|   | Qty        | Value     | Qty        | Value     | Qty        | Value     |
| <b>Fruits and vegetables</b>              |            |           |            |           |            |           |
| Fresh onions                              | 1008606.48 | 103577.89 | 1670186.29 | 182752.21 | 1664922.89 | 231942.98 |
| Other fresh vegetables                    | 350235.47  | 48949.01  | 505285.46  | 68020.32  | 41924.35   | 73185.9   |
| Walnuts                                   | 6716.48    | 16207.8   | 5696.34    | 14123.63  | 9073.88    | 19789.51  |
| Fresh mangoes                             | 54350.8    | 12741.76  | 83708.18   | 17071.25  | 74460.61   | 20053.98  |
| Fresh grapes                              | 96963.57   | 31782.51  | 124627.97  | 40861.28  | 131153.61  | 54533.89  |
| Other fresh fruits                        | 207700.78  | 30452.6   | 256768.53  | 43086.84  | 260675.43  | 52283.32  |
| Sub Total for fruits and vegetables       | 1724573.58 | 243711.57 | 2646267.77 | 365915.53 | 2559526.77 | 451789.58 |
| <b>Processed fruits and vegetables</b>    |            |           |            |           |            |           |
| Dried and preserved vegetables            | 125726.28  | 42993.81  | 147861.22  | 49641.51  | 124613.5   | 53207.48  |
| Mango pulp                                | 166752.17  | 50968.51  | 173013.6   | 75298.9   | 186197.85  | 74460.77  |
| Other processed fruits and vegetables     | 311756.29  | 96281.65  | 387126.42  | 137179    | 397978.17  | 143550.63 |
| Total for processed fruits and vegetables | 604234.74  | 190243.97 | 708001.24  | 262119.41 | 708789.52  | 271218.88 |

Source: APEDA WEBSITE March 2011

vegetables and various other products like paste, frozen vegetables, ketchup, pickles, juices and powdered vegetables (onion and garlic) mainly to Middle East countries like Behrein, Qatar, Muscat, Abudhabi, Sharjah and Doha. Middle East markets are receiving basically 4.5% of fresh vegetables from India though tremendous potential exists in increasing vegetable export to Middle East.

The trade vegetable items are large in number although exclusive dependence rests on onion, which accounts more than 70 per cent of total foreign exchange from fresh vegetables. Apart from fresh onion, other prime vegetables which are exported in fresh condition are okra, bittergourd, green chilli, bottlegourd, bell pepper, baby corn, round melon, French bean, snow peas, sugar snap, cherry tomato, cucumber, gherkin, asparagus, celery.

There is continued demand for frozen vegetables and tomato products in the foreign countries. Among dehydrated vegetables, peas, onion and garlic are important and among frozen vegetables, prospects for pea, cauliflower, French bean, carrot and okra are bright. Chilli oleoresin is another important export item to USA, Canada, USSR, UK, Singapore, Malaysia, France and Japan earning foreign exchange of worth Rs 88 crores approximately every year.

Now the farmers are realizing the vast export potential of vegetables i.e. the export of vegetable produce has increased in the last few years. In the recent past, some enterprising farmers from Punjab have started exporting snow peas to markets in UK, UAE, Denmark, France, Germany and Holland. Punjab Agri Export Corporation Ltd. (PAGREXCO) had achieved a great success in marketing of fresh vegetables from Punjab to UK especially for NRI's. No doubt, the quality of these vegetables does not compete in the international market but they are highly accepted by Indians living there and good response has been received by PAGREXCO. Later AGREXCO and private exporters would send around 60 consignments from India to UK, Canada, West Asia and Singapore. The Agri export zones for vegetables in Punjab was also being set up by PAGREXCO in association with APEDA in Fatehgarh Sahib, Patiala, Sangrur, Ludhiana and Ropar to increase production and exports of vegetables from Punjab. In Punjab, number of small, medium and large

packhouse facilities have also been setup by individuals and private companies such as Reliance Fresh at Jalandhar, Bharti Field Fresh at Laddowal, Ludhiana, Khet Se Agricultural products (A Tata group enterprise) at Malerkotla, Namdhari Fresh at Bhaini Sahib, Food Park by Punjab Agro at Sirhind especially for export purpose and in the near future many more are coming up.

#### 4. IMPORTING COUNTRIES

The vegetable markets for fresh produce in developed countries are very competitive. India should have an edge in price, quality novelty to take a significant market share. The traditional vegetables are exported to Malaysia, Singapore, Gulf countries, Sri Lanka, Bangladesh, Pakistan and Nepal. The non-traditional vegetables are exported to European countries and Australia in addition to Gulf countries and south-east Asian countries. Most vegetables are exported by air. Kuwait airways, Saudi Airways, Air India and TWA are the important airlines which air lift the vegetables for export.

European Union (EU) is highly potential markets from the India's point of view. With the use of new technologies in post-harvest, Indian entrepreneurs can certainly make a mark in this market.

##### 4.1. Indian or Ethnic Vegetable

Many European countries have sizeable ethnic population from the Indian sub-continent or Africa. They prefer to have particular type of vegetable like okra, brinjal, Asian gourds such as bitter gourd, bottle gourd, ash gourd, ridge gourd, sponge gourd, chilli, parval, legumes etc. These vegetable can be grown throughout the year in India. To make an impact in the international markets we need to grow them under excellent agronomic condition and also under protected cultivation, if required. In this direction, the use of low cost net houses control insects-pest which avoid the pesticide residue problem in vegetables. Drip irrigation and mulching practices will also be useful in increasing the productivity without wasting the also valuable resources like water.

The produce shipped through sea-freight is much higher in volume, economical and can be reached to more number of consumers. Two most

important vegetable where India already has a sizeable export volume are potato and onion, which need not to be covered. In case of onion, India also has a potential to get into the European markets apart from the existing markets, especially for the ethnic population. It is interesting to note that the Indian consumers in European countries are ready to pay a considerable higher price for the Indian onion compared to the regular long day onions, which are commonly available in the super markets and with the retailers. The other important products are garlic and ginger. China and Thailand have made a serious impact in these vegetable and there is a good possibility that India can take a share of this market. It will be very important to produce these vegetables under GLOBALGAP or organic certified foods. Some of the other produce could be muskmelon and watermelon (from November to March). During this time European Economic Community cannot grow these fruits and most of the produce is imported. Now the major player during this time of the year is South American. As this is not the normal production season for cultivating these crops hence, the success in this segments can be achieved either by cultivating in different regions of India during November to March. The first grade fruits can be exported and the rest can be absorbed in the domestic market, which is considerably a big market in itself.

#### **4.2. Exotic Vegetable**

These will include some of the European vegetable (French bean, snow peas, sugar snaps, baby corn, asparagus), which are costly to produce in Europe due to expensive manpower or unfavourable climate. French beans have a big market in Europe due to its year around consumption. Presently, the most important players are Kenya, Morocco, Egypt. The price realization is good in fine or extra fine segments, where the tender beans are harvested and packed in the small packing of 100 to 250g depending upon the requirements of the customer. Similarly, baby corm is another product, which is used in large scale in Chinese and Thai dishes. Presently, Thailand is the biggest supplier as they have standardized the post-harvest technology over the years. This product is also coming from many African and central American countries. Sugar snaps and snow peas have also become important part of European cuisine. The challenge in Indian conditions would be to prolong the season for at least six months, as most

of the multiple retailers would like to have the product on their shelves for a longer time, so that a consumer can develop a confidence for a specific product from new destination. Asparagus is well known to European consumers but till 60's or 70's and it was considered to be highly seasonal vegetable. Presently, asparagus can be produced throughout the year in the tropics and Peru in South American is one of the important players in off-season asparagus exports to Europe. Although Thailand also has its presence in fine asparagus and asparagus tips export. Baby vegetables popularity has increased in the last 5 to 6 years. Almost any vegetable can be grown as baby vegetable but most common ones are carrot, cauliflower, cabbage, zucchini. Most of these exotic vegetables are not so commonly traded in the European markets and are mostly sold by multiple retailers (super markets) at higher prices. Therefore, one has to have an advance contact in hand before venturing into these luxury vegetables.

## 5. MARKET FOR THE ORGANIC PRODUCE

Organic produce is a growing market, especially in the European countries as consumers are becoming more and more skeptical about the excess use of pesticides in modern culture. Many of the retailers are providing up to 10% of shelf space to organic produce in Germany and England. The organic produces are priced 20 to 35% higher than the conventional produce. The organic produce must be certified by the accredited agencies. Most of these countries stipulate a period of three years for the conversion to organic status. Here the challenge for the scientists is to standardize the integrated pest management for organic cultivation.

## 6. THE MARKETS IN SOUTH-EAST ASIA

Since India has endowed with both tropical and sub tropical climates, which makes possible for it to grow some of the winter vegetable like cauliflower, broccoli and lettuce etc. during most part of the year. Although the countries in south-east Asia like Thailand, Malaysia and Singapore, which are also growing economic vegetable produce, due to tropical weather and heavy rains in these countries, most of these vegetable qualities are not of the international standard. Therefore, some of the

super markets shops are importing these winter vegetable from Australia, New Zealand and USA. The retailer, who is paying at least 2 to 3 times more than the local produce can justify the higher price. Hence, there is a reasonably good possibility for Indian fresh vegetable exporters to enter these markets with the application of new technologies to satisfy the customer demand.

## 7. COMPETING COUNTRIES IN VEGETABLE EXPORT

Thailand, Jordan, Lebanon, Syria, Kenya, Zimbabwe, Guatemala, China, Argentina, Indonesia, Egypt, Turkey, Iran, Cyprus, Australia, New Zealand, Spain, Holland are other countries, which also export different vegetables. Details about some of the exporting countries and items being exported are given in Table 2.

**Table 2: Export of different vegetables from different exporting countries**

| Country                | Vegetable(s)  |
|------------------------|---|
| Thailand               | Brinjal, baby corn, chilli, okra  |
| Holland                | Baby corn, capsicum, cole crops, tomato, cucumber, lettuce, root crops and potato |
| Australia              | Bean, cole crops, cucumber, root crops  |
| China                  | European vegetables   |
| Kenya                  | Bean, pea, okra   |
| Guatemala              | Asparagus   |
| Jordan, Lebanon, Syria | Assorted vegetables   |

## 8. ESTABLISHMENT OF AGR-EXPORT ZONES (AEZS) BY APEDA

The concept of Agri-Export Zone attempts to take a comprehensive look at a particular produce/products located in a contiguous area for the purpose of developing and sourcing the raw materials, their processing/ packaging, leading to final export. Thus, the entire effort is centered around a cluster approach to identify the potential products, the geographical region in which these are grown and adopting an end to end approach of integrating the entire process, right from the stage of production till it

reaches the market. Agri-Export Zones for vegetables grown in different states have been established for promoting export at competitive price. The anticipated benefits to accrue as a consequence of setting up of such zones are as follows:

- Strengthening of backward linkage with a market oriented approach.
- Product acceptability and its competitiveness abroad as well as in market.
- Value addition to basic agricultural produce.
- Bring down cost of production through economy of scale.
- Better price for agricultural produce.
- Improvement in product quality and packaging.
- Promote trade related research and development.
- Increase employment opportunities.

Thus, the partnership envisaged between Central Government, State Government, farmer, producer and exporter lies at the heart of the concept of AEZ. The important AEZ for vegetables established in U.P. are Agra, Hathras, Farukhabad, Kannoj, Meerut, Aligarh; in M.P.-Malwa, Ujjain, Indore, Dewas, Dhar, Shajapur, Ratlam, Neemuch and Mandsaur; in Punjab- Fatehgarh Sahib, Patiala, Sangrur, Ludhiana, Ropar and Jalandhar; in Karnataka- Tumkur, Bangalore, Hassan, Kolar, Chitradurga, Dharwad and Bagalkot; in A.P.-Chittor, Mahboobnagar, Rangareddy, Medak, Karimnagar, Warangal, Ananthpur and Nalgonda; in Gujarat- Ahmedabad, Khaida, Anand, Varodara, Surat, Navsari, Valsad, Bheruch, Bhavnagar, Narmada, Surendranagar, Amereli, Rajkot, Junagarh and Jamnagar; in West Bengal- Hooghly, Burdwan, Midnapur, Udainarayanpur, Howrah, Nadia, Murshidabad and North 24 Pargenas; in Maharashtra- Nasik, Ahmednagar, Pune, Satara and Solapur and in Kerala- Trissur, Ernamkulam, Kottayam, Alappuzha, Pathanumthitta, Kollam, Tiruvananthapuram, Idukki and Palakkod. The cultivation of export oriented crops or crops having export potential are to be arranged in these areas exclusively for export purpose, which will be very beneficial to grower as well as consumer as it would be cost effective.

## 9. PERIOD OF REQUIREMENT

The quantity of different vegetables required though differs in different months in view of local production, particularly in South-East Asian countries; the demand is round the year. In European market, the demand is from November-December to April-May when there is no local production or even stored produce is also not available there. India having varied agro-climatic conditions can produce and supply the vegetables to different markets from one to other parts comfortably round the year, provided the necessary infrastructure facilities are created for handling, grading, packaging and speedy transport to markets or processing units.

## 10. PRODUCING POCKETS

Although, it is possible to produce vegetables in one or other parts round the year, but due to ports being near and also good infrastructure facilities created, the production is presently limited in certain pockets for meeting the demands of foreign markets. The detail of some of the vegetables and area of production are mentioned in Table 3.

**Table 3: Some identified pockets for growing vegetables for export**

| Crop                          | Area of production   |
|-------------------------------|--|
| Okra                          | Nasik, Ozar, Saikheda, Dindhori, Kolhar, naraingaon and Sholapur in Maharashtra, Valsad in Gujarat   |
| Watermelon                    | Panvel near Mumbai   |
| Bottle gourd and bitter gourd | Nasik and Pune districts in Maharashtra  |
| Gherkin                       | Nasik in Maharashtra and Bangalore in Karnataka  |
| Capsicum                      | Nasik, Pune and Sarata districts in Maharashtra  |
| Baby corn                     | Bangalore in Karnataka, Nasik and Pune in Maharashtra, Jalandhar and Ludhiana in Punjab  |
| French bean                   | Dindhori in Nasik district, Wai in Satara district   |
| Cluster bean                  | Naraingon in Pune district, Dhule and Ahmednagar in Maharashtra  |
| Tomato                        | Nasik and Pune in Maharashtra and Bangalore in Karnataka   |
| Potato                        | Jalandhar and Ludhiana in Punjab, Kurukshetra and karnal in Haryana, Ooty in TN and Indore in MP, Mathura, Agra, Farukhabad in UP and Hassan in Karnataka. |



## 11. VEGETABLES SPECIFICATION FOR EXPORT

Lot of vegetables is being exported from Mumbai every day and major export is by air. However, since last few years export has been stated by sea container. The major products in demand and their specification are:

- **Okra** : Green, tender, 7-12 cm long, packing 5 kg
- **Bottle gourd** : Green, tender, straight, cylindrical in shape and 25-30 cm long, packing 5 kg
- **Chilli (green)** : Green, 7-10 cm long, packing 5 kg
- **Peas** : Green, tender, straight, 10-12 cm long, packing 5 kg
- **Bitter gourd** : Green, 20-25 cm long, short neck, packing 5 kg
- **Tomato** : Round, medium size, red colour for middle east and cherry tomato for European countries
- **French Bean** : Straight, 10-12 cm long, round green pods in bush beans and flat beans having 12-13 cm length
- **Onion** : For yellow/brown coloured onion: 7-8 cm, round or spindle shape and for Red onion: 4-6 cm for Gulf Markets
- **Potato** : White, oval and 4.5-6.0 cm size
- **Tondali** : Green, tender, 2.5-5.0 cm long, packing 5 kg
- **Gawar** : 10-12 cm length, not over matured, packing 5 kg
- **Suran** : Cleaned, weighing around 5-10 kg
- **Drum stick** : Straight, thick, 24 inch long, packing 5 kg

## 12. WHAT IS GLOBALGAP

The challenge of globalising markets is nowhere greater than in the primary food sector. GLOBALGAP (formerly known as EUREPGAP) has established itself as a key reference for Good Agricultural Practices (GAP) in the global market place, by translating consumer requirements into agricultural production. The GLOBALGAP standard is primarily designed to reassure consumers about how food is produced on the farm by minimising detrimental environmental impacts of farming operations, reducing the use of chemical inputs and ensuring a responsible approach to worker health and safety as well as animal welfare. GLOBALGAP serves as a practical manual for Good Agricultural Practice (GAP)

anywhere in the world. The basis is an equal partnership of agricultural producers and retailers who wish to establish efficient certification standards and procedures.

- GLOBALGAP is a private sector body that sets voluntary standards for the certification of agricultural products around the globe. The aim is to establish ONE standard for Good Agricultural Practice (GAP) with different product applications capable of fitting to the whole of global agriculture.
- GLOBALGAP is a pre-farm-gate standard, which means that the certificate covers the process of the certified product from farm inputs like feed or seedlings and all the farming activities until the product leaves the farm. GLOBALGAP is a business-to-business label and is therefore not directly visible to consumers.
- GLOBALGAP certification is carried out by more than 100 independent and accredited certification bodies in more than 80 countries. It is open to all producers worldwide.
- GLOBALGAP includes annual inspections of the producers and additional unannounced inspections.
- GLOBALGAP consists of a set of normative documents. These documents cover the GLOBALGAP General Regulations, the GLOBALGAP Control Points and Compliance Criteria and the GLOBALGAP Checklist.
- The GLOBALGAP protocol document has been accredited by Dutch Council for Accreditation under European standards EN 45011. The GLOBALGAP certificate gives you better market access and enhanced consumers confidence in food safety and quality.
- Under compliance criteria of GLOBALGAP, all growers must demonstrate their with the following scheme requirements : Traceability, record keeping, varieties and root stocks, site history and site managements, soil and substrate management, fertilizer usage, irrigation, crop protection, harvesting, postharvest treatments, pollution management, workers welfare, environmental issues.
- To obtain the certificate the grower has to meet 100% of the “Major Must” and 95% of the “Minor Must” requirements of the GLOBALGAP control points and compliance criteria.

## 13. PROTOCOLS FOR POST-HARVEST HANDLING OF VEGETABLES FOR EXPORT

### 13.1. Snow pea/ Sugar snap

- Harvesting (using clippers)
- Preliminary sorting (at the time of harvesting only)
- Collecting in crates/baskets lined with butter paper
- Covering the crates with wet Hessian cloth.
- Moving the crates to shelter /pack house
- Precooling at 3-5°C
- Sorting, grading and detopping at 8-10°C
- Packing in punnets/cartons at 8-10°C and labelling
- Cold storing at 0-2°C
- Dispatch at 0-2°C

### 13.2. Carrot

- Harvesting- Done throughout the day (using tractor mounted diggers)
- De-topping (manually) in the field
- Preliminary sorting and grading in the field
- Collecting the produce in crates
- Movement of the product from field to the shed.
- Sorting and grading as per the market requirement
- Washing using mechanical washer
- Packaging in 2'x 3'gunny bags
- Dispatch to the destination (market/cold store). The material was loaded on covered trolleys/trucks for dispatch.
- Storage at 0-2°C and 90-98% RH (In the cold store)

### 13.3. French Bean

- Harvesting (manually)
- Preliminary sorting (at the time of harvesting only)
- Collecting in crates/baskets lined with butter paper

## 290 | Post Harvest Handling of Vegetables

- Covering the crates with wet Hessian cloth.
- Moving the crates to shelter /pack house
- Precooling at 5°C
- Sorting and grading at 8-10°C
- Packing in punnets/cartons at 8-10°C and labelling
- Cold storing at 3-5°C
- Dispatch at 3-5°C

### 13.4. Baby Corn

- Collecting the Cobs in crates
- Dispatch to the pack house: The material was loaded into covered trolleys in crates for dispatch to the pack house.
- Quality check at the receipt
- Pre-cooling at 5-7°C and 90-95% RH
- Peeling using Knives
- Sorting and grading as per the market requirement
- Storage at 5-7°C and 90-95% RH ( In the pre-cooler)
- Packaging in 1 kg perforated polyethylene bags.
- Quality check before dispatch
- Dispatch in covered truck/trolley

### 13.5. Okra

- Harvesting- Done through out the day (Using secateurs)
- Collecting the pods in crates
- Preliminary sorting and grading in the field (In the shade)
- Dispatch to the pack house: The material was loaded into covered trolleys in crates for dispatch to the pack house.
- Quality check at the receipt
- Pre-cooling at 10-12°C and 90-95% RH
- Sorting and grading as per the market requirement at 15-18°C
- Trimming by using clippers

- Storage at 10-12°C and 90-95% RH ( In the pre-cooler)
- Packaging in 5 kg CFB boxes at 15-18°C
- Quality check before dispatch
- Dispatch in refer Van at 10°C

### 13.6. Bitter Gourd

- Harvesting- Done through out the day
- Collecting the product in crates
- Dispatch to the pack house: The material was loaded into covered trolleys in crates for dispatch to the pack house.
- Quality check at the receipt
- Pre-cooling at 12-14°C and 90-95% RH
- Sorting and grading as per the market requirement at 15-18°C
- Trimming using clippers
- Storage at 12-14°C and 90-95% RH ( In the pre-cooler)
- Packaging in 5 kg CFB boxes at 15-18°C
- Quality check before dispatch
- Dispatch in refer Van at 10°C

### 13.7. Onion

- Harvesting manually
- Collecting in crates
- Movement from the field to the shed in trolleys
- Curing for 2-3 days or till the leaves are dry
- De-tailing, De-topping and sorting-grading: using clippers and as per the specifications
- Packaging in 30/40 kg netlon bags
- Storing/Curing in stacks
- Quality check before dispatch
- Dispatch in truck/trolley

## **14. STRATEGIES TO IMPROVE EXPORT**

### **14.1. Selection of End use Specific Varieties**

Various private and public sector institutions have devolved improved varieties of different vegetable crops, which are suitable for growing under different agro-climatic condition. These varieties have been developed keeping in view the use of produce in the fresh form or for processing. The use of specific varieties developed for these purpose is not so much evident in the fields. Efforts are required for continued improvement in development of varieties and introduction of the same in the field. A lot of vegetable produce is wasted due to improper variety, harvesting method and stage of harvesting. The faster results will be achieved if the production and post-harvest practices so developed are demonstrated on the farmer's fields.

### **14.2. Changes in Agriculture Produce Marketing Act (APMA)**

For attracting private investments in the markets, it is essential to bring change in the agriculture produce marketing act. The role of the markets in production areas is critical in development of backward and forward linkages between the growers at one end and consolidators, processors and terminal markets on the other end.

### **14.3. Contract Farming**

Contract farming is a welcome development for reducing transaction costs by establishing farmer processor linkages in addition to the already existing methods of linking the farmers to the consumers. But the contract should be made under high scrutiny possibly because of exploitation of the farmers. The government should establish a monitoring mechanism and a dispute settlement body to ensure that both parties adhere to the terms of contract.

### **14.4. Development of Supply Chain Infrastructure**

Development of value-added centers having proper facilities for washing, sorting, grading, packing and forwarding of packaged produce to terminal

markets will provide critical link to ensure reduction in the wastages and higher realization to growers. Once these facilities are created in different production area, tremendous scope would be available for export of the produce. The developments of supply chain through networking of such facilities will create possibilities of movements of the produce in various forms, i.e. under refrigeration, controlled and modified atmospheres chain for export.

#### **14.5. Certification for Exports**

The buying agencies in developed countries have started prefacing or sometime even restricting import of produce only from such growers which have certified production areas viz. GLOBALGAP. Therefore growers who are conscious to export their production have to kept in mind the requirement of such certification before growing of a particular crop. Similarly, for processing HACCP certification is useful.

#### **14.6. Documentation for Organic Produce**

The organically produced vegetables and their processed products are gaining momentum in the developed countries due to its advantages. However proper understanding and appreciation of documentation and ultimately the certification of production forms is essential to get the full benefits of higher price realization and market acceptance of such produce.

#### **14.7. Improvement in the Domestic Markets**

The accelerated development of export will also be interlinked to improvement in domestic marketing and conditions in the local markets. Due to absence of sorting and grading facilities in domestic markets, usually 5% of produce is considered of good quality, which fetches higher prices. About 60% of the produce receives the average prices while rest of the produce (35%) fetches a very low price. The traders tend to sell vegetables very quickly on the low prices fearing that the produce will soon lose its marketable quality. So there is need to make improvement in the domestic markets.

### **14.8. Improvements in Economics by Waste Utilization**

The processing units on an average produce 40 to 60% of total vegetables intake as waste, which comprises peel, leaves, stalk trimmings, etc. The facilities are required to be created for management of this waste and conversion of the same into value-added products or as renewable source of energy. This would improve the overall economics of the sector.

### **14.9. Strategies for Cost Reduction**

The growth of output achieved through higher productivity is the best route for reduction in output cost. The best tools to increase productivity use higher yielding varieties and better management of other inputs.

### **14.10. Improving Market Intelligent System (MIS)**

Market information is essential not only in improving performance for farmers, but is also necessary at market level for formulation of proper policy and its successful implementation. The chief requirement for successful market intelligence service is accuracy, timing and relevance of the information collected. The state governments should initiate steps towards procuring national hook up through satellites and link all major markets with the system.

### **14.11. Linking Small Farmers to the Process**

Most of the vegetable growers are small and marginal, therefore, they are reluctant to apply the latest pre-and post-harvest management systems due to cost benefit ratio. To ensure that export quality produce is available in bulk quantities, it is essential that farmers are linked into groups. This would further ensure reduction in the operational expenses, which are otherwise very high.

### **14.12. Knowledge of Sanitary and Phytosanitary (SPS) Requirements of Importing Country**

Since the quality standards in Europe and other developed countries are very stringent, it is necessary for growers and exporters to ensure that sanitary and phytosanitary requirements of importing countries are known



in advance so that the risk of rejection is adequately addressed at different stages of production and post- harvest management.

## 15. PESTICIDE RESIDUE LIMITS FOR EXPORT OF FRESH VEGETABLES

To combat insect pests in vegetables, farmers use several kinds of insecticides which are applied somewhat close to the harvest or picking time of vegetables, leaving little or no time for their adequate dissipation. As a result the residue of these chemicals remains in the vegetables and environment (soil, water, air) which adversely effect human health resulting into very serious problems. The pesticide usage in developing countries is considerably higher than that of developed countries. During 2007, the ICAR sources reported 61% of the 796 vegetable samples analyzed containing pesticide residues, 12% of which exceeded the respective MRL (Maximum Residue Limit) values. A survey in UP and Hyderabad revealed that average pesticide intakes through food were 0.27 and 0.36 mg/person/day, respectively and these values were higher than the acceptable daily intakes (ADI) established by FAO/WHO. The Indian Council of Medical Research (ICMR), while reviewing pesticide pollution in India, recorded people in several cities accumulated in their body DDT and HCH in high concentrations of 4.7-22.25 ppm and 1.43-16.85 respectively, from their food and environment. Thus the pesticide residue issues are enormously important to modern agriculture especially vegetables due to their short duration maturity. Farmers and stake holders generally ignore the pesticide residue issues when domestic marketing is concerned but when we talk about the international trade and export, these issues have to be looked seriously and have to follow the maximum residue limits (MRLs) prescribed by the importing country. In the recent past, some of the consignments of vegetables were rejected in the international market due to presence of pesticide residue above MRLs, resulting in appreciable economic loss to the exporter. The MRLs for individual pesticides have been set at international level by Codex Alimentarius Commission under the joint FAO/WHO food standards programme periodically for the last more than 40 years. Besides individual country sets her MRL values, for instance, in India MRLs are fixed under Prevention of Food Adulteration (PFA) Act 1954 and Rules 1955, under the overall control of Assistant Director General

(PFA), Ministry of Health and Family Welfare, Government of India. There are 209 pesticides registered in India but PFA (2003) covered only 71 pesticides. Variation in MRLs of Individual countries often create a bottlenecks in trading of food commodities, particularly in European countries which have lower MRLs for the same pesticides than the other developing countries, targeting sometimes at “Zero level”. The MRLs in vegetables for majority of pesticides range between 0.01-0.1 ppm for European countries (see Table 4). The MRLs of pesticides in vegetables given by Codex Alimentarius Commission is listed in Table 5.

**Table 4: Maximum Pesticides Residue (MRL) for export of vegetables to European countries**

| Sr. No. | Insecticide/Pesticide              | MRL (mg/kg) |
|---------|------------------------------------|-------------|
| 1       | Organochlorine Pesticides          | nbsp;       |
| 2       | Aldrin                             | ND          |
| 3       | Chlordane (cis & trans)            | ND          |
| 4       | Chlorothalonil                     | 1.00        |
| 5       | DDT (all isomers)                  | ND          |
| 6       | Dichlofluanid                      | 10.00       |
| 7       | Dicofol                            | 2.00nbsp;   |
| 8       | Dieldrin                           | ND          |
| 9       | Endosulfan (all isomers)           | 0.50        |
| 10      | Endrin                             | 0.01        |
| 11      | Lindane                            | 0.50        |
| 12      | HCH (alpha & beta)                 | ND          |
| 13      | Heptachlor                         | 0.01        |
|         | <b>Organophosphorus Pesticides</b> |             |
| 14      | Acephate                           | 0.02        |
| 15      | Azinphosmethl                      | 1.00        |
| 16      | Chlorfenvinphos                    | 0.05        |
| 17      | Chlorpyriphos methyl               | 0.02        |
| 18      | Drazinon                           | 0.02        |
| 19      | Dichlorvos                         | 0.10        |
| 20      | Dimerthoate                        | 1.00        |

[Table Contd.]

Contd. Table]

| Sr. No. | Insecticide/Pesticide      | MRL (mg/kg) |
|---------|----------------------------|-------------|
| 21      | Ehion                      | 0.50        |
| 22      | Etrimphos                  | ND          |
| 23      | Fenchlorphos               | 0.01        |
| 24      | Fenitrothion               | 0.50        |
| 25      | Malathion                  | 0.10        |
| 26      | Profenophos                | 0.05        |
| 27      | 2chlorophenol (metabolite) | ND          |
| 28      | Methamidophos              | 0.01        |
| 29      | Methidathion               | 0.50        |
| 30      | Mevinphos                  | 0.10        |

**Source:** Maharashtra State Agriculture Marketing Board. Website (Jan, 2009)

**Table 5 : MRLs for vegetables prescribed by Codex Alimentarius Commission**

| Sr. No. | Insecticide  | Vegetable(s)                        | MRL (mg/kg) |
|---------|--------------|-------------------------------------|-------------|
| 1.      | Acephate     | Potato                              | 0.5         |
|         |              | Lettuce (Head)                      | 5.0         |
|         |              | Tomato                              | 1.0         |
|         |              | Broccoli, Cabbage, Cauliflower      | 2.0         |
| 2.      | Bifenthrin   | Potato                              | 0.05        |
| 3.      | Carbaryl     | Potato                              | 0.2         |
|         |              | Okra and Leafy Vegetables           | 10.0        |
|         |              | Brinjal, Cabbage, Tomato, Peppers   | 5.0         |
|         |              | Cucumber                            | 3.0         |
| 4.      | Carbofuran   | Radish and Carrot                   | 2.0         |
|         |              | Potato, Tomato, Brinjal, Onion      | 0.1         |
| 5.      | Chlordane    | Carrot                              | 0.5         |
|         |              | Vegetables and Fruits               | 0.02        |
| 6.      | Chlorpyrifos | Cabbage, Cauliflower, Onion, Potato | 0.05        |
|         |              | Carrot, Tomato, Peppers             | 0.5         |

[Table Contd.]

Contd. Table]

| Sr. No. | Insecticide         | Vegetable(s)  | MRL (mg/kg) |
|---------|---------------------|---|-------------|
|         |                     | Brinjal   | 0.2         |
|         |                     | Chinese Cabbage, Lettuce (Head)                                 | 0.1         |
| 7.      | Chlorpyrifos-Methyl | Cabbage, Chinese Cabbage, Lettuce (Head), Brinjal, Radish       | 0.1         |
|         |                     | Tomato, Peppers   | 0.5         |
| 8.      | Cyfluthrin          | Tomato  | 0.5         |
|         |                     | Bell pepper   | 0.2         |
| 9.      | Cyhalothrin         | Potato  | 0.02        |
|         |                     | Cabbage   | 0.2         |
| 10.     | Cypermethrin        | Spinach, Lettuce (Head)   | 2.0         |
|         |                     | Cucumber, Brinjal   | 0.2         |
|         |                     | Tomato, Peppers, Leek   | 0.5         |
|         |                     | Brassica Vegetables   | 1.0         |
|         |                     | Onion   | 0.1         |
| 11.     | Deltamethrin        | Leafy vegetables  | 0.5         |
|         |                     | Brassica Vegetables, Fruiting Vegetables (other than cucurbits) | 0.2         |
|         |                     | Bulb vegetables   | 0.1         |
|         |                     | Melons (except Water melon)                                     | 0.01        |
| 12.     | Diazinon            | Potato  | 0.01        |
|         |                     | Bell Pepper, Onion, Chinese Cabbage, Kale, Summer squash        | 0.05        |
|         |                     | Tomato, Broccoli, Carrot  | 0.5         |
|         |                     | Onion   | 1.0         |
|         |                     | Cabbage   | 2.0         |
|         |                     | Cucumber  | 0.1         |
|         |                     | Cantaloupe  | 0.2         |
| 13.     | Dicofol             | Cucumber  | 0.5         |
|         |                     | Melons (except Water melon)                                     | 0.2         |
|         |                     | Tomato, Peppers, Summer squash                                  | 1.0         |
| 14.     | Dimethoate          | Potato  | 0.05        |
|         |                     | Brussels sprout, Cabbage, Lettuce (Head)                        | 2.0         |

[Table Contd.]

Contd. Table]

| Sr. No. | Insecticide      | Vegetable(s)  | MRL (mg/kg) |
|---------|------------------|---|-------------|
|         |                  | Tomato, Peppers, Spinach, Carrot                                      | 1.0         |
|         |                  | Kale  | 0.5         |
|         |                  | Onion   | 0.2         |
| 15.     | Endosulfan       | Potato, Onion, Carrot,  | 0.2         |
|         |                  | Lettuce (Head and leaf), Kale   | 1.0         |
|         |                  | Spinach   | 2.0         |
| 16.     | Fenvalerate      | Cucumber, Melons (except Water melon)                                 | 0.2         |
|         |                  | Bell pepper, Summer and Winter squash, Watermelon                     | 0.5         |
|         |                  | Tomato, Chinese Cabbage   | 1.0         |
|         |                  | Broccoli, Brussels Sprout, Lettuce (Head)                             | 2.0         |
|         |                  | Kale  | 10.0        |
| 17.     | Lindane          | Potato  | 0.05        |
|         |                  | Radish, Kohlrabi  | 1.0         |
|         |                  | Spinach, Lettuce (Head), Endive, Tomato                               | 2.0         |
|         |                  | Carrot  | 0.2         |
|         |                  | Brussels sprouts, Cabbage, Cauliflower                                | 0.5         |
| 18.     | Malathion        | Brinjal, Peppers, Kohlrabi, Cauliflower, Chard,                       | 0.5         |
|         |                  | Endive, Spinach, Lettuce (Head), Cabbage                              | 8.0         |
|         |                  | Kale, Tomato  | 3.0         |
| 19.     | Monocrotophos    | Peppers, Chilli, Brinjal  | 0.2         |
|         |                  | Potato  | 0.05        |
|         |                  | Watermelon, Onion   | 0.1         |
| 20.     | Parathion-methyl | Potato, Lettuce (Head)  | 0.05        |
|         |                  | Spinach, Lettuce (Leaf)   | 0.5         |
|         |                  | Broccoli, Cabbage   | 0.2         |
|         |                  | Carrot  | 1.0         |
| 21.     | Permethrin       | Potato  | 0.05        |
|         |                  | Brinjal, Peppers, Tomato  | 1.0         |
|         |                  | Chinese cabbage, Kale, Cabbage  | 5.0         |
|         |                  | Cucumber, Gherkin, Summer and Winter squash, Cauliflower, Leek, Onion | 0.5         |
|         |                  | Lettuce (Head), Broccoli  | 2.0         |

[Table Contd.]

Contd. Table]

| Sr. No. | Insecticide | Vegetable(s)                                | MRL (mg/kg) |
|---------|-------------|---|-------------|
|         |             | Carrot                                      | 0.1         |
| 22.     | Phorate     | Potato                                      | 0.2         |
| 23.     | Profenofos  | Peppers, Chilli                             | 5.0         |
|         |             | Peppers-sweet, Brussels sprout, Cauliflower | 0.5         |
|         |             | Tomato                                      | 2.0         |
|         |             | Potato                                      | 0.05        |
|         |             | Cabbage                                     | 1.0         |
| 24.     | Triazophos  | Potato, Onion                               | 0.05        |
|         |             | Brussels sprout, Cabbage, Cauliflower       | 0.1         |
|         |             | Carrot                                      | 0.5         |

## 16. MANAGEMENT OF PESTICIDE RESIDUES

There is urgent necessity to apply need based pesticides which should be duly recommended by an appropriate authority. Practices like observing suggested waiting period, harvesting of ripe fruits and vegetables before spray can lead to reduction of pesticides residues. In vegetable production, IPM should be adopted so that the pesticide residue can be reduced while boosting high quality produce. Equally important is to develop or find new pesticide molecules with high efficiency, effectiveness and fast degrading capacity. Furthermore, exporters should testified their produce for pesticide and fertilizer residues from NABL accredited laboratories before exporting and make sure that pesticides and fertilizers residues should be less than the MRL values prescribed by the importing country to avoid lot rejection on reaching destination. Pesticide sticking to vegetable surface can be reduced by washing under tap water for 2 minutes or using 1% sodium chloride solution. Peeling or cooking can reduce upto 50% of residues. Moreover, growing vegetables near opened drains or irrigated fields with sewerage water should be avoided. Proper storage and handling of produce may reduce the presence of mycotoxins. To learn using these pesticides to achieve maximum benefit with minimum risks to our health and environment is a big challenge to be met by one or all.

## 17. CONCLUSION

Since India has suitable agro-climatic conditions for production of all types of vegetables throughout the year in one or other part of the country. But, still vegetable growers and specialists have not equipped themselves with the qualitative aspects of production and pre and post harvest care, which play a very vital role in the export of vegetable produce. The required infrastructure facilities should be in position to facilitate grading, packing and movement of produce from field to the final consumer in shortest possible time. This requires governmental intervention and also sizeable investment in research and development. Setting up of 20 Agri Export Zones in new Exim (Export-Import) policy 2002-2007, is one of the major steps the Government of India has taken to promote export. It is also necessary to familiarize the growers and the exporters with the technologies related to qualitative aspects. While promoting India's vegetable export quality should be the watch ward, we must provide such quality as would be the consumer's delight. It is no longer sufficient if we ensure stomach's satisfaction. Moreover to boost the export, there is need to establish/promote new processing units, net house/protected cultivation for minimum use of insecticides, organic farming, refrigerated vans, cold storage facilities, modern storage and packing centers, more cargo space and pesticide residue testing laboratories. These should be close linkage between exporters and producers of exportable surplus. Moreover, it is necessary to have proper survey of the foreign markets about their requirements of qualities/types of crops they need and accordingly we should diversify/enter the new market with suitable varieties/crops. Promotion of integrated processing complexes with well-developed infrastructure close to producing pockets will have to be taken up. Infrastructure will also have to be developed at sea ports and airports for proper handling and storage etc. There should be exclusive production of vegetables for export having required quality standards. So, to stay in the export world in the new millennium means that one will have to supply a healthier, premium quality produce that is fresh, nutritious and more appealing to ever-discerning and demanding consumers worldwide.

## CHAPTER 17

# FRESH-CUT VEGETABLES

---

**F**resh produce which has been cleaned, cored, peeled, chopped, sliced or diced and then packaged may be considered as fresh-cut produce. Fresh cut produce is essentially purposely wounded plant tissue that must be maintained in a viable, fresh state for extended period of time. The International Fresh-cut Produce Association (IFPA) defines fresh-cut products as fruit or vegetables that have been trimmed and/or peeled and/or cut into 100% usable product that is bagged or pre-packaged to offer consumers high nutrition, convenience, and flavour while still maintaining its freshness. In the last few years, fresh-cut industry has undergone a rapid growth especially in developing countries. Much of growth has come from the healthy alternatives in restaurants, hotels or hospitals, but also the change in the family whereby the consumer wants to buy ready-to-eat products that take little or no preparation time. Fresh-cut products are attractive to consumer because they offer uniform piece, convenience, reduced preparation time and 100% of the product is usable. This reduces labour cost, storage space requirement and training cost at food service establishments. Minimal processing techniques have emerged to meet the challenge of replacing traditional methods of preservation while retaining nutritional and sensory quality. It is well-known that processing of vegetables promotes a faster physiological deterioration, biochemical changes and microbial degradation of the product even when only slight processing operations can be used, which may result in degradation of the colour, texture and flavour.



## 1. VEGETABLES SUITABLE FOR FRESH CUT PRODUCE

There are many fresh-cut vegetables in the market; the most common is lettuce, carrot, tomato, cauliflower, cabbage and melons. These vegetables have established markets as an ingredient into salads or as separate products. The primary products among melons include watermelons, muskmelons and cantaloupes. Most of these products have a shelf life of 4 to 7 days at 0-5°C temperature.

## 2. KEY REQUIREMENTS OF FRESH-CUT VEGETABLES

- Good quality raw material (correct cultivar, variety, correct cultivation, harvesting and storage conditions)
- Strict hygiene and good manufacturing practices (GMP), use of hazard analysis and critical control point (HACCP) principles
- Low temperatures during processing
- Careful cleaning and/or washing before and after peeling
- Good quality water (sensory, microbiology, pH) for washing
- Use of mild additives in washing water for disinfection or preservation of browning
- Gentle spin drying following washing
- Gentle peeling
- Gentle cutting, slicing and/or shredding
- Correct packaging material and packaging methods
- Correct temperature and humidity during distribution and retailing

## 3. REASONS FOR QUALITY CHANGES IN FRESH-CUT PRODUCE

As a result of peeling, grating and shredding, produce will change from a relatively stable product with a shelf life of several weeks or months to a perishable one that has only a very short shelf life, even as short as 1-3 days at low temperature. Fresh-cut produce deteriorates because of physiological ageing, biochemical changes and microbial spoilage, which may result in degradation of the colour, texture and flavour of the produce.

During peeling and grating operations, many cells are ruptured, and intracellular products such as oxidizing enzymes are liberated. The changes occur in fresh-cut produce which effects its quality is discussed below:

### 3.1. Physiological and Biochemical Changes

Wounds inflicted during the preparation of fresh-cut vegetables promote many physical and physiological changes that hasten loss of product quality. Foremost among these, are the removal of the protective epidermal layer and/or exposure of internal cells. These changes not only facilitate water loss, but also provide an easy entry for microbial pathogens and chemical contaminants. Water loss and collapse of injured cells at the cut surface can alter the appearance of the fresh-cut product. As the cut surface loses water, adhering cellular debris may impart a white blush to the surface that masks varietal colour, e.g., white blush on 'baby' carrots. The most important enzyme with regard to fresh-cut vegetables is polyphenol oxidase, which causes browning. Enzymatic browning requires the presence of four different components: oxygen, an oxidizing enzyme, copper and a suitable substrate. To prevent browning, at least one of these components must be removed from the system. Another important enzyme is lipoxidase, which catalyzes peroxidation reactions, causing the formation of numerous bad-smelling aldehydes and ketones.

Ethylene production can also increase in fresh-cut produce because ethylene contributes to the biosynthesis of enzymes involved in fruit maturation. Ethylene can in turn stimulate other physiological processes, resulting in accelerated membrane deterioration, loss of vitamin C and chlorophyll, abscission, toughening and undesirable flavour changes in a range of vegetable crops e.g. tissue softening associated with fruit ripening (e.g., melons, squash, tomatoes) or chlorophyll loss associated with leaf or tissue senescence (e.g., spinach, broccoli).

Furthermore, the respiration activity of fresh-cut produce will increase 1.2-7.0 fold or even more depending on the produce, cutting grade and temperature. If packaging conditions are anaerobic, this leads to anaerobic respiration and thus the formation of ethanol, ketones and aldehydes.

Many vegetables are sensitive to non-freezing temperatures below (around 10°C) and suffer physiological damage if held at these chilling

temperatures beyond a specific period of time. These vegetables include pepper, sweet potato, tomato and zucchini. In contrast to the whole commodity that should not be chilled, the increased susceptibility of fresh-cut products to spoilage often means that the product has a longer market life at 0°C than at higher, non-chilling temperatures. Since most fresh-cut vegetables are consumed soon after purchase and fruit vegetables are fully ripe when processed, chilling injury symptoms usually do not develop to a significant extent because the rate of deterioration due to chilling is slower than the rate of spoilage that is inhibited by low temperatures. The two most important fresh-cut commodities, lettuce and carrots, are not chilling sensitive and should be stored as close to 0°C as possible without freezing i.e. at 1 to 3°C in a commercial setting.

### 3.2. Microbiological Changes

During peeling, cutting and shredding, the surface of produce is exposed to air and there is possibility of produce contamination with bacteria, yeasts and moulds. In the case of fresh-cut vegetables, most of which fall into the low-acid category (pH 5.8-6.0), the high humidity and the large number of cut surfaces can provide ideal conditions for the growth of microorganisms. The bacterial populations found on vegetables vary widely. The predominant microfloras of fresh leafy vegetables are *Pseudomonas* and *Erwinia* spp., although low numbers of moulds and yeasts are also present. During cold storage of minimally processed leafy vegetables, pectinolytic strains of *Pseudomonas* are responsible for bacterial soft rot. An increase in the storage temperature and the carbon dioxide concentration in the package will shift the composition of the microflora such that lactic acid bacteria to predominate.

The high initial load of microorganisms makes it difficult to establish the cell-number threshold beyond which a product can be considered spoiled. Many studies show that a simple correlation does not exist between spoilage chemical markers (such as pH, lactic acid, acetic acid and carbon dioxide levels and sensory quality) and the total microbial cell load.

### 3.3. Safety Aspects of Fresh-cut Produce

Because fresh-cut vegetables are not heat treated, they must be handled and stored at refrigeration temperature of >5°C to achieve a sufficient

shelf life and ensure microbiological safety. However, some pathogens such as *Listeria monocytogenes*, *Yersinia enterocolitica*, *Salmonella spp.* and *A. hydrophila* may still survive and even proliferate at low temperatures. Fresh-cut vegetables are relatively safe when compared with other fruit products as they are generally acidic enough to prevent the growth of pathogens. Usually, those spoilage microorganisms that are present in refrigerated produce are psychrotrophic and therefore have a competitive advantage over most pathogens. However, systematic studies on the microbiological safety of refrigerated fresh-cut vegetables are still needed.

### 3.4. Nutritional Changes

Most studies on fresh and fresh-cut vegetables have been concerned with market quality as determined objectively and subjectively by colour, flavour and texture measurements as well as by microbiological determinations. Little is known about the nutritive value i.e. vitamins, sugar, amino acid, fat and fibre contents of fresh-cut produce.

## 4. FACTORS EFFECTING QUALITY AND SHELF LIFE OF FRESH-CUT VEGETABLES

Guidelines for packing fresh or minimally processed fruit and vegetables generally specify a washing or sanitising step to remove dirt, pesticide residues, and microorganisms responsible for quality loss and decay. Wounding and other minimal processing procedures can cause physiological effects, including ethylene production, increase in respiration, membrane deterioration, water loss, susceptibility to microbiological spoilage, loss of chlorophyll, formation of pigments, loss of acidity, increase in sweetness, formation of flavour volatiles, tissue softening, enzymatic browning, lipolysis and lipid oxidation. The factors effecting the quality and shelf life of fresh-cut produce are listed below:

### 4.1. Colour

Consumers take product appearance into consideration as a primary criterion. Colour has been considered to play a key role in food choice,

food preference and acceptability. Colour is one of the main attributes, along with texture, that determines the freshness of most vegetables. Lettuce and carrot can undergo changes in colour due to different biochemical processes, mainly chlorophyll degradation and browning appearance in the case of the lettuce and carotene degradation, whiteness and browning in the case of the carrot. Lettuce presents two types of browning, edge browning and russet spotting. Wounding of lettuce produces a signal that migrates through the tissue and induces the synthesis of enzymes in the metabolic pathway responsible for increased production of phenolic compounds and browning. The origin of the brown pigment is complex and not fully understood, but is known to involve the oxidation of polyphenols by peroxidase (POD) and polyphenol oxidase (PPO) enzymes. In carrots, wounding induce synthesis of phenolic compound 'Lignin' which results whiteness in carrots and the activation of certain enzymes.

#### 4.2. Texture

Fresh-cut vegetables that maintain firm, crunchy texture are highly desirable because consumers associate these textures with freshness. The appearance of a soft or limp product may give rise to consumer rejection prior to consumption. Textural changes in vegetables are related to certain enzymatic and non-enzymatic processes. Iceberg lettuce is very popular probably due to its crispness and attractive yellow-green colour. However, after cutting, the product undergoes different undesirable biochemical reactions and its texture is not maintained for more than 10 days, even under optimal storage conditions. The texture and crispness evaluation of the lettuce is relatively difficult due to its heterogeneity. However, in carrot, it is easier to evaluate textural characteristics, mainly firmness, due to the consistency of the samples.

#### 4.3. Respiration Rate

Fresh-cut vegetables are living tissues even after treatment and exhibit an increase in respiratory rate. Practical experience has demonstrated that tissues with high respiratory rates and/or low energy reserves have shorter postharvest lives. Modifying the atmosphere composition in which the produce is stored is usually done to slow down the respiration rate, to

reduce product metabolism and maturation, losses in fresh weight and in dry matter. The concentration of oxygen and carbon dioxide inside the headspaces is related to the metabolic state of the sample. The levels of oxygen can have other effects on quality, e.g. inactivating enzymatic reactions. Because PPO requires  $O_2$  to induce cut surface discolouration, reducing the amount of  $O_2$  in the package of fresh-cut product by vacuum, MAP or gas flushing may reduce cut surface discolouration, although not completely stop it.

#### 4.4. pH

Fresh-cut vegetables belong to the low-acid foods (pH 5.8-6.0). Processing and storage conditions can affect the pH of the samples, e.g. high levels of  $CO_2$ . The pH of the vegetables should be adequate in a range of 5-6.5 for quality retention. In the case of fresh-cut Iceberg lettuce, the pH during storage is maintained or slightly decreased.

#### 4.5. Microbiology

The natural microflora of fresh-cut vegetables includes bacteria, yeast and moulds. The natural microbial load depend to a great extent on the type of vegetable, environment consideration, seasonality and the condition under which a particular vegetable is grown. The main characteristics of fresh-cut vegetables which increases the probability of microbial spoilage and contamination includes (1) the presence of cut surfaces and increased moisture content, (2) as minimally processed, sterility or microbial stability of these products can not be ensured, (3) the confinement of the product in a modified atmosphere package. Microorganisms impact the economic value of fresh-cut products by decreasing product shelf-life through spoilage and by posing a risk to public health by causing food borne diseases.

#### 4.6. Sensory Evaluation

The quality of a fresh-cut produce is effected by sensory, nutritional and functional properties. It is easy to measure the colour and texture with different apparatus. However it is much more difficult to evaluate the taste and flavour.

#### 4.7. Nutritional Content

The fresh-cut industry claims their products are convenient and healthy alternatives to fulfill the dietary needs. However, the many changes that happen in vegetables during harvesting, handling and processing can affect antioxidant status. Decrease in the antioxidant activity after processing was reported for fresh-cut spinach. Otherwise, wounding caused an increase in antioxidant activity of Iceberg and Romaine lettuce. Levels of ascorbic acid, carotenoids or polyphenols can reflect the variations in antioxidant capacity of vegetables.

### 5. OPERATIONS IN FRESH-CUT PRODUCT PREPARATION

Fresh-cut product preparation involves various steps which can be broken into specific unit operations. Each unit operation must be performed properly so that finished product quality, shelf life and food safety can be assured satisfactory. Finished product storage temperature, wash water pH and chlorine level, cleanliness (GAP and GMP) and proper handling are primary considerations while preparing fresh-cut product. Each of the unit operations will be described briefly as below:

#### 5.1. Intelligent Inspection

The quality of fresh-cut product is highly dependent on the quality of commodities used for processing. Poor quality ingredients will yield poor quality finished fresh-cut products. Produce received for processing should be sampled and tested for receiving temperature, incidence of defects and insect infestation. Many problems can be avoided by rejecting inferior quality produce on the receiving dock and not allowing it into the cold storage or processing room.

#### 5.2. Product Flow

Bulk commodities should be segregated from finished products to prevent cross contamination. Incompatible commodities should also not be stored together in the same cooling chamber (e.g. lettuce and tomato). Intermediate stage commodities (e.g. whole peeled onions or carrots) are best stored with commodities, as further processing and washing will be done. In storage, date labelling should be done to assure first in first out

inventory rotation. Whole bulk commodities and intermediate fresh-cut products should be gently treated during processing to minimize unnecessary bruising and stress which may reduce product quality and shelf life.

### **5.3. Preliminary Washing and Sorting**

Vegetables produce are sometimes received with dirt or dust. Washing and even scrubbing some commodities and then rinsing in cold chlorinated water may be necessary to remove dirt and reduce microbial population before cutting.

### **5.4. Peeling**

Some commodities such as carrots, onion and most fruits require peeling to remove tough fibrous skin before cutting. No appropriate peeling method is available to prepare fresh-cut produce. Generally hand peeling or abrasive peeling is used to prepare fresh-cut produce. Hand peeling of vegetables will provide the highest quality produce and highest yield but is extremely labour intensive. Whereas abrasive peeling is commonly used in carrots and onion but it can be very damaging to commodities and may result in surface scarring which results white blush in peeled carrots.

### **5.5. Size Reduction/Cutting**

Hand knives and stationery coring units are effectively used for this operation. This is the primary area for sorting out decay or defects. If defects and decay are not sorted out at this point, one defect will be cut into many small pieces and be dispersed in a large amount of produce making it almost impossible to sort out. Moreover, it will contaminate the cutting surface with microbes. After preliminary trimming, size reduction is done by cutting machines. Knife sharpness is a critical factor since dull knives can significantly reduce the shelf life of fresh cut produce.

### **5.6. Size and Defect Sorting**

Size sorting is done to assure that finished piece size is within acceptable limits to meet consumer needs. The most effective way to accomplish



this is by the use of shaker screen sizers, which allow undersize small pieces to pass through a vibrating screen. Pieces greater than the size of the aperture of the shaker screen will continue on the next steps in processing. Defect sorting after cutting is often done to remove physiological defects and/or off-cut pieces. Due to number of different defects which are encountered, trained people on the sorting line is the best solution of this problem.

### 5.7. Washing/Cooling

Properly washing and cooling fresh-cut produce immediately after cutting is one of the most important step in fresh-cut processing. Washing in cold chlorinated water after cutting helps to remove microbes, dirt and cellular juices at the cut surfaces. Rinse water temperature, contact time, chlorine content and pH are the key parameters to assure that produce are rinsed and cooled properly.

Rinse water temperature should be as cold as possible and 0°C is optimal for most products. The longer the fresh-cut produce is in contact with the rinse water, the colder the fresh-cut produce will become. Fresh-cut produce must be cooled as possible when exiting the rinse water system since it is almost impossible to cool fresh-cut produce once they are bagged, boxed and palletized. Rinse water may be sprayed on fresh-cut produce from above via nozzles as it proceeds on a conveyor belt or the fresh-cut produce may be submerged and flumed through the rinse system. Chlorination of rinse water is done by injecting chlorine gas or a liquid (Sodium or Calcium Chloride) @ 50-100 ppm, which will reduce the microbial population on a fresh-cut produce. Maintaining these levels of chlorine at all the times is important as it reduces microbial population on fresh-cut produce and reduces cross contamination in the rinse water system. Chlorine test kits or Biological Oxygen Demand (B.O.D.) meters should be used to monitor and adjust chlorine levels. Excessively high concentrations of chlorine will damage fresh-cut produce and reduces shelf life as well as produce off-flavour and odours. Chlorine function best as a bactericide at a neutral or slightly acidic pH. If the pH of the rinse water increases above 7.5, chlorine is ineffective as a bactericidal agent because it is not in its active form. Closely monitoring the pH of

the rinse water and adjusting it with an appropriate acid (phosphoric or citric) or base (sodium hydroxide) is an important factor in fresh-cut produce preparation.

### 5.8. Dewatering

Dewatering of fresh-cut products is through centrifugation or forced air. The method of choice in the fresh-cut industry to dewater product is via centrifugation (spinning to force water to the outside of a collection vessel). The time and speed of centrifugation are key parameters to adjust for each product. Excessive centrifugation will result in cellular damage and cause products to leak fluids after packaging. Many fresh cut products are too delicate to withstand centrifugal drying and forced-air semi-fluidized bed may be used to strip water away from products. Forced-air drying is most effective on product pieces which have smooth surfaces allowing water to be swept away from the product. Any forced-air used in such an operation must be filtered so as not to contaminate products.

### 5.9. Packaging

The different steps in packaging operation includes weighing, bagging, sealing, metal detection and boxing. Correct amount of product is weighed and packed in polymeric film bags or trays for fresh-cut produce. When fresh-cut products are packaged, the atmosphere within the package may be evacuated or flushed with a mixture of gases to more rapidly establish a desirable modified atmosphere. The correct combination of packaging material, produce weight and gas composition within a package are critical components which must be determined for each product to maintain product quality and extend product shelf life. Some processors add a freshness indicator label to the package in order to give produce buyers and consumers additional confidence in produce quality. Proper sealing of bags is a critical factor in maintaining product quality since bags with imperfect seals will have near ambient oxygen concentrations and accelerated browning. As part of good manufacturing practices all fresh-cut products should be screened for the presence of extraneous ferrous and non-ferrous metal fragments with help of metal detectors. Boxing is

the last step in the fresh-cut processing operation. Boxes should be pre-cooled to make sure that cold product is not packed into warm boxes. Boxes of product should always carry a date of manufacture and best use date and production code to allow first in first out product rotation.

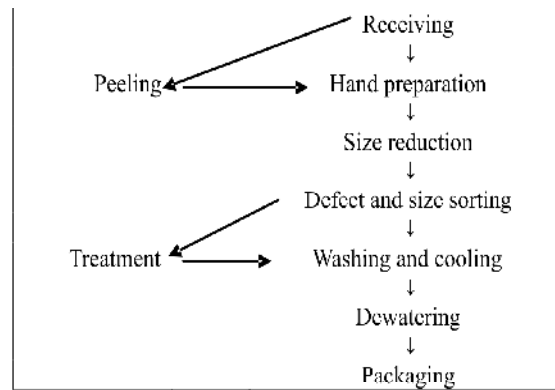


Fig. 1: Flow diagram of fresh-cut product preparation

## 6. METHODS TO IMPROVE THE QUALITY AND SHELF LIFE OF FRESH-CUT VEGETABLES

Fresh-cut vegetables can be manufactured on the bases of several different working principles (Table 1). If the principle is that products are prepared today and consumed tomorrow, then very simple processing methods can be used. The greatest advantage of this principle is the low requirement for investment. If products are required to have a shelf life of several days up to one week in the case of products intended for retailing, then more advanced processing methods and treatments using the hurdle concept are needed, as well as the correct choice of raw materials that are suitable for minimal processing. Table 1 shows requirements for manufacture of pre-peeled and/or sliced, grated or shredded vegetables.

### 6.1. Raw Materials

No systematic studies were conducted on the matching of raw material and processing requirements in the fresh-cut vegetables. However, it is

**Table 1: Requirements for manufacture of pre-peeled and/or sliced, grated or shredded vegetables**

| <b>Working principle</b>                                      | <b>Demands for processing</b>   | <b>Customers</b>  | <b>Shelf life at 5°C (days)</b> | <b>Examples of suitable fruit and vegetables</b>       |
|---|---|---|---------------------------------|--|
| Preparation today, consumption tomorrow                       | <ul style="list-style-type: none"> <li>● Standard kitchen hygiene and tools</li> <li>● No heavy washing for peeled and shredded produce; potato is an exception</li> <li>● Packages can be returnable containers</li> </ul> | Catering industry, restaurants, schools, industry       | 1-2                             | Most vegetables  |
| Preparation today, the customer uses the product within 3-4 d | <ul style="list-style-type: none"> <li>● Disinfection</li> <li>● Washing of peeled and shredded produce at least with water</li> <li>● Permeable packages; potato is an exception</li> </ul>                                | Catering industry, restaurants, schools, industry       | 3-5                             | Carrot, cabbage, iceberg lettuce, potato, beetroot     |
| Products are also intended for retailing                      | <ul style="list-style-type: none"> <li>● Good disinfection</li> <li>● Chlorine or acid washing for peeled and shredded produce</li> <li>● Permeable packages; potato is an exception</li> <li>● Additives</li> </ul>        | Retail shops, in addition to the customers listed above | 5-7*                            | Carrot, Chinese cabbage, red cabbage, potato, beetroot |

\* longer shelf life, up to 14 days is required, the storage temperature must be 1-2°C

self-evident that vegetables intended for pre-peeling and cutting must be easily washable and peelable. Correct and proper storage of vegetables and careful trimming before processing are vital for the production of good quality fresh-cut produce. The correct choice of variety is particularly important in the case of carrot, potato, rutabaga and onion. For example, carrot and rutabaga varieties that give the most juicy grated product cannot be used in the production of grated products that need to have a shelf life of several days, whereas poor colour and flavour becomes problem if the variety of potato is wrong. Furthermore, the results showed that climatic conditions, soil conditions, agricultural practices, including the use of fertilizers and the harvesting conditions, can also significantly affect the 'behaviour' of vegetables, particularly that of potatoes, during minimal processing.

## 6.2. Peeling, Cutting and Shredding

Some vegetables such as potato, carrot, onion and garlic require peeling. Several peeling methods are available; however, on an industrial scale, peeling is normally accomplished mechanically (e.g. using rotating carborundum drums), chemically or in high-pressure steam peelers. Peeling should be as gentle as possible. The ideal method is hand peeling using a sharp knife. Coarse and fine abrasion peeling increased the rate of microbial growth over that of hand peeling. From the point of view of sensory quality, hand-peeled carrots were somewhat better than abrasion-peeled carrots. Browning of potatoes peeled with carborundum drums was much greater than that of hand-peeled potatoes. Carborundum-peeled potatoes must be treated with a browning inhibitor, whereas washing in water is enough for hand-peeled potatoes. Carrots cut with a razor blade were more acceptable from microbiological and sensory point of view than carrots cut using various commercial slicing machines. It is clear that slicing with dull knives impairs the retention of quality because it ruptures cells and releases tissue fluid to a great extent. Mats and blades that are used in slicing operations can be disinfected, for example, with a 1% hypochlorite solution. A slicing machine must be installed securely because vibrating equipment may impair the quality of sliced surfaces.

### 6.3. Cleaning, Washing and Drying

If vegetables are covered with soil, mud or sand, they should be carefully cleaned before processing. Washing after peeling and/or cutting removes microorganisms and tissue fluid, thus reducing microbial growth and enzymatic oxidation during subsequent storage. Washing the produce in flowing or air-bubbling water is preferable to simply dipping it in water. The microbiological of the washing water must be good and its temperature must be low (<5°C). Chlorination of rinse water is done by injecting chlorine gas or a liquid (Sodium or Calcium Chloride) @ 50-100 ppm, which will reduce the microbial population on a fresh-cut produce. However, when chlorine is used, vegetable material should subsequently be rinsed to reduce the chlorine concentration to that found in drinking water and to improve the sensory shelf life. The effectiveness of chlorine can be enhanced by using a low pH, high temperature, pure water and correct contact time. However, careful washing with water containing 100mg chlorine per litre and subsequent rinsing improved the sensory shelf life of fresh-cut vegetables by several days, up to 7-8 days. It is recommended that the washing water is removed gently from the product. Centrifugation seems to be the best method. However, the centrifugation time and rate should be chosen carefully.

### 6.4. Control of Tissue Softening

Tissue softening is a very serious problem in fresh-cut products. The flesh firmness of fresh-cut fruit products can be maintained by its treatment with calcium salt. Dipping fresh-cut products in solution of calcium chloride @ 0.5-1.0% (1% = 10 g per liter water) is very effective in maintaining product firmness. However, calcium chloride may leave a bitter off-flavour on some products. Calcium salts such as calcium lactate or calcium acetate may also be used.

### 6.5. Browning Inhibition

Control of browning on cut-surface is an important step in fresh-cut processing. In case of vegetables, such as pre-peeled and sliced potato, browning is the main problem. As already mentioned that browning of cut surface is due to oxidation of phenolic compounds in the fruits by the enzyme poly phenol oxidase (PPO) in the presence of oxygen. Therefore

reduce oxygen supply, acidification and use of reducing agents will slow down the process of browning.

### **6.5.1. Reduced oxygen**

Because enzyme PPO require oxygen to induce browning, reduced amount of oxygen in a package of fresh-cut product by modified atmosphere vacuum packaging or gas flushing will significantly reduce rate of browning. Excessive amount of oxygen in a package may accelerate browning, while too little oxygen may cause anaerobic metabolism and the production of off-flavour and odour.

### **6.5.2. Acidification**

Enzyme PPO works best at neutral pH of 7 resulting browning. Browning can be slowed by dipping products in mildly acidic food grade solutions of acetic, ascorbic, citric, tartaric, fumaric or phosphoric acid. Citric acid (CA) combined with ascorbic acid (AA), alone or in combination with potassium sorbate in the case of potato seem to be promising for reducing browning, particularly when hand peeling is used. The lowered product pH slows browning but acids may leave off-flavour as well as tissue softening and must be used with care.

### **6.5.3. Reducing agents**

Ascorbic acid or erythroate (an isomer of ascorbic acid) are two common compounds used in the food industry to stop PPO browning. Unfortunately, once all the ascorbic acid or erythroate are used, PPO browning will proceed uninhibited. Ascorbic acid or erythroate are commonly used as a 1% solution to prevent browning of cut surfaces. These compounds are organic acids so they also reduce the pH of commodities and slow PPO browning.

## **6.6. Modified Atmosphere Packaging (MAP)**

The basic principle in MAP is to create an optimal gas balance inside the package, where the respiration activity of a product is as low as possible, but the levels of oxygen and carbon dioxide are not detrimental to the

product. Most films do not result in optimal  $O_2$  and  $CO_2$  atmospheres, especially when the produce has a high level of respiration. However, one solution is to make micro-holes of a defined size and of a defined number in the material to avoid anaerobic. Other solutions include the combination of ethylene vinyl acetate with oriented polypropylene and low-density polyethylene or the combination of ceramic material with polyethylene. Both of the composite materials have a significantly higher gas permeability than either polyethylene or the oriented polypropylene much used in the packaging of salads. Both these materials have good heat-sealing properties and they are also commercially available. The shelf life of shredded cabbage and grated carrot packed in these composite materials is 7-8 days at  $5^\circ C$ , and therefore 2-3 days longer than in the oriented polypropylene that is generally used in the vegetable industry. Products can be packed in normal air in these composite materials.

### 6.7. Active Packaging

Active packaging, that is, packaging that includes various gas absorbents and emitters, is another interesting packaging method for fresh-cut vegetables. Active packaging affects respiration activity, microbial activity and plant hormone activity. In diced onions package, the use of gas absorbent (potassium permanganate and activated alumina) removes ethylene effectively and reduces the levels of sulphur volatiles and  $CO_2$  in the package.

### 6.8. Edible Films and Coatings

Another possible 'packaging' method for extending the postharvest storage life of fresh-cut vegetables is the use of edible coatings. Edible coatings have the potential to reduce moisture loss, restrict the entrance of oxygen, lower respiration, retard ethylene production, seal in flavour volatiles and carry additives that retard discoloration and microbial growth. Edible coatings based on sucrose polyesters of fatty acids and sodium salt of carboxymethyl cellulose delayed water loss or browning; those based on cellulose derivatives retarded the discoloration of cut mushrooms, and the development of a physiological disorder of peeled carrots known as white blush.



## 6.9. Irradiation

Low-dose gamma irradiation is very effective in reducing bacterial, parasitic, and protozoan pathogens in raw foods. Irradiation was approved by the FDA for use on vegetables at a maximum level of 1.0 kGy. In some instances, the produce quality is extended while in others it results in a loss of quality attributes. The irradiation of fresh-cut carrots improved their colour and flavour, although impaired the texture. In minimally processed lettuce, doses of up to 0.5 kGy have been proved not to affect quality; however irradiation levels of 0.81 or 1.1 kGy affect the quality. Irradiated cantaloupes had a lower and more stable rate of respiration than non-irradiated ones.

## 6.10. Ultraviolet Light

Ultraviolet light (UV) acts as an antimicrobial agent directly due to DNA damage and indirectly due to the induction of resistance mechanisms in different vegetables against pathogens. Exposure to UV also induces the synthesis of health-promoting compounds such as anthocyanins and stilbenoids. Another advantage of this technique is that it is relatively inexpensive and easy-to-use equipment are needed. However, high UV doses can cause damage to the treated tissue. The use of Ultraviolet-C (254 nm) on fresh-cut lettuce can reduce deterioration of the produce by effectively reducing microbial populations. But negative effect of UV-C application was increased respiration rate and possibly induced a lignification-like process, which changed the appearance of produce.

## 6.11. Hurdle Technology

Hurdle technology is the combination of different preservation techniques as a preservation strategy. The most important hurdles commonly used in food preservation are based on controlling temperature, water activity, acidity, redox potential and the use of preservatives, modified atmosphere and competitive microorganisms (e.g., lactic acid bacteria). By combining hurdles, the intensity of the individual preservation techniques can be kept comparatively low, minimising the loss of quality, while the overall impact on microbial growth may remain high. The selection of hurdles needs to be tailored carefully to the quality attributes of a product. e.g. combining

lactoferrin, organic acids and oregano extracts with modified atmosphere packaging and pulsed electric field technology to prevent microbial growth mainly.

## 7. COMMERCIAL PACKAGING AND STORAGE OF IMPORTANT FRESH-CUT VEGETABLES

### 7.1. Broccoli (Florets)

Fresh-cut broccoli florets should be tight, firm, turgid and dark green without blooming buds. There should be no sulphur odour or discoloration along the stems and cut ends. The core temperature of raw material should be  $< 1.5^{\circ}\text{C}$ . Raw and processed material should be stored at 1 to  $3^{\circ}\text{C}$  to assure quality. Yellowing is a common problem caused by either chlorophyll loss or blooming of the buds. The cut surface and damaged floret stems can turn black during storage. Development of off-odours can be a major concern when MAP is used. Temperature abuse promotes soft rot and mould growth.

Whole broccoli heads are hand-cut into florets that are  $> 2.5$  cm to  $< 5$  cm long. They are washed in water containing up to 200 ppm total chlorine, to wash residual material from the florets as well as reduce aerobic plate counts.

The benefit of CA ( $5\% \text{O}_2 + 4\% \text{CO}_2$ ) may be marginal for storage up to 14 days at 0 to  $5^{\circ}\text{C}$  compared to air. Lowering  $\text{O}_2$  to 0.25% or increasing  $\text{CO}_2$  to 10% at 0 to  $5^{\circ}\text{C}$  reduces respiration by about 50%. Use of appropriate polymeric film in MAP maintains green colour at 0 to  $5^{\circ}\text{C}$  for more than 21 days. Perforated and micro-perforated polymeric packages reduce off-odour.

### 7.2. Cabbage (Shredded, Diced)

Fresh-cut green cabbage should be light green with a moderate pungent flavour and no sulphur aroma. Raw and processed material should have typical cabbage flavour and should be stored at 1 to  $3^{\circ}\text{C}$  to assure quality and reduce potential for freezing of product during handling, distribution and storage. Fresh-cut cabbage includes diced and shredded product with cut size varying from 0.63 cm to 0.95 cm. Heads are trimmed to remove

wrapper leaves and cored, cut and washed using chlorinated water (100 ppm of total chlorine) for about 1 min before being spun-dried and packaged.

A CA of 5 to 7.5% O<sub>2</sub> + 15% CO<sub>2</sub> is recommended. Lowering O<sub>2</sub> below 5% caused rapid proliferation of fermentative bacteria and off odours within 6 days at 5°C. Off-odours formation in cut cabbage bags with low OTR film (< 3,000 mL/m<sup>2</sup> atm<sup>-1</sup> day<sup>-1</sup>) and discoloration of cabbage leaf packed in high OTR film (> 12,000 mL/m<sup>2</sup> atm<sup>-1</sup> day<sup>-1</sup>) bags are the major quality deterioration during storage.

### 7.3. Chinese Cabbage (Sliced, Sticks, Shredded)

Fresh-cut Chinese cabbage should be handled like cabbage and stored at 1 to 3°C. The recommended CA is 5% O<sub>2</sub> + 5% CO<sub>2</sub>; benefits are moderate compared to air storage at 0°C.

### 7.4. Butterhead Lettuce (chopped, shredded, whole leaf)

It should be stored at 1 to 3°C before and after processing to assure quality and reduce potential for freezing of product during handling, distribution and storage. Browning (enzymatic) of the cut edges is the main defect of fresh-cut lettuce pieces during storage. The best way to prevent discoloration is to reduce O<sub>2</sub> to < 3%. Antioxidant treatment and heat-shock can inhibit discoloration, but these treatments may result in loss of visual quality.

Browning of the cut edges of butterhead lettuce is reduced by modified atmospheres rapidly created by flushing with N<sub>2</sub> to get 1 to 3% residual O<sub>2</sub>, with CO<sub>2</sub> levels of 5 to 10%. Tissue in atmospheres of < 1% O<sub>2</sub> + > 10% CO<sub>2</sub> develop CO<sub>2</sub> injury or brown stain.

The physiological behaviour of butterhead lettuce, eg., sensitivity to CO<sub>2</sub> injury, is modified by cultural practices such as irrigation, climate and fertilization. Susceptibility to brown stain varies among cultivars and position of leaves within the head. Shelf-life of butterhead lettuce was negatively correlated with respiration rate and susceptibility to CO<sub>2</sub>. Off odours and flavours developed (ethanol, acetaldehyde and ethyl acetate aroma), crispness was lost and the tissue became translucent when fresh-cut lettuce was stored in < 0.5% O<sub>2</sub> and/or > 15% CO<sub>2</sub>.

### 7.5. Spinach (whole leaves, cut leaves)

Fresh-cut spinach should be green without any decay or bruise. Fresh and processed products should be stored at 1 to 3°C before and after processing to assure quality and reduce potential for freezing of product during handling, distribution and storage.

Spinach stored in 0.8%O<sub>2</sub> at 20°C had a lower respiration rate, superior appearance and better taste than spinach leaves stored in air. Atmospheres of 0.8% O<sub>2</sub> or 0.8% O<sub>2</sub> + 10% CO<sub>2</sub> reduced the number of aerobic mesophilic and psychrotrophic microorganisms on fresh-cut spinach leaves by 10 to 100 fold, compared to air-stored leaves at 5°C; however, there was no effect at 10°C. These atmospheres had no effect on texture changes during storage at 5°C for 9 days or at 10°C for 7 days.

### 7.6. Carrots (diced, shredded, sticks, peeled, grated, sliced, cubes)

Fresh-cut carrots are orange without a white blush or slimy surface. Raw and processed product should be kept at 1 to 3 °C to assure quality and reduce potential for freezing of product during handling, distribution and storage. Most quality loss in cut carrots results from either formation of white blush, or off-odour and slimy surface generated by bacteria.

Fresh-cut carrots include whole peeled (baby), sticks, sliced, shredded, grated and diced. Whole carrots are washed with water to remove undesirable field material. The stems and tips are excised and the trimmed carrots are peeled, cut, and washed in NaOCl for less than 1 min. Washed carrot cuts are centrifuged to remove excess water and packaged in plastic bags.

Dehydration of surface debris on cut and peeled carrots imparts a whitish translucent appearance to the surface, which reduces its consumer value. Application of edible coating such as sodium caseinate-stearic acid or heating and raising the pH may be helpful in reducing white blush.

Fresh-cut carrots derive slight benefit from 2 to 5% O<sub>2</sub> + 15 to 20% CO<sub>2</sub> atmospheres. Lower O<sub>2</sub> or increased CO<sub>2</sub> levels promotes slimy appearance, increased lactic acid bacteria growth, and accelerated microbial decay and excessive alcohol production. Grated carrots retain good quality for up to 10 days at 2 to 10°C in MAP.

### 7.7. ONIONS (Diced, slivered, rings, chunks)

Fresh-cut onion should have no discoloration on skin and core. Bulbs should be dry, free of decay, firm and 7.5 to 10 cm in diameter. The core of whole onions should be kept at 1 to 3°C before and after processing to assure quality and reduce potential for freezing of product during handling, distribution and storage. The seed stems and new internal growth should be less than 10%; double centers and translucent scale should be less than 5%.

Whole onions are peeled and trimmed by machine or hand. Washing with chlorinated water can be done before or after processing. Bulbs for onion rings are washed with cold water at 0°C before processing. However diced and slivered onions are washed using chlorinated water after processing.

Browning, yellowing and development of translucence are major factors affecting the visual quality of diced onion. Cutting causes important biochemical changes in tissues including development of sulphur aromatic volatiles. These compounds are produced enzymatically by hydrolysis of alliin (odourless derivatives of amino acids) by alliinase. CA of 2 to 5% O<sub>2</sub> + 10 to 15% CO<sub>2</sub> decreases respiration and microbial proliferation and retains sucrose and pungency of cut onions. Lowering the O<sub>2</sub> level can be beneficial for visual quality, but has no effect on aroma. Enrichment in CO<sub>2</sub> improves both qualities. Atmospheres containing 1 to 2% O<sub>2</sub> prevent the loss of pyruvic acid, an indicator of onion flavour intensity and reduce the rate of respiration of the fresh-cut tissue. The inclusion of potassium permanganate as an ethylene scrubber and sulphur volatiles in packages of diced onions improves sensory quality. A storage-life of 10 days is possible for fresh-cut onions packaged in polymeric bags without a gas flush and stored at 2.2°C. Addition of absorbents and potassium permanganate in packages increased shelf-life up to 18 days at 1°C.

### 7.8. Garlic (peeled)

Quality problems with peeled garlic include sprouting and discoloration of areas damaged during peeling. Garlic cloves can be peeled manually or mechanically with compressed air. Acid treatments and edible coatings can improve preservation. Excellent visual quality was maintained for 21,

16, 12 or 8 days of storage in air at 0, 5, 10, or 15°C, respectively. Decay was not observed at 0 and 5°C and was slight at 10 and 15°C. At 5 and 10°C, CA (1% O<sub>2</sub> + 10% CO<sub>2</sub>) gave the best quality (lack of decay and least discoloration).

### 7.9. Potato (sticks, diced, sliced, peeled)

Fresh-cut potatoes should be firm and without brown discoloration. Enzymatic browning is a major problem in the discoloration of peeled or fresh-cut potatoes. Hand-peeling result in good quality, while abrasion-peeling is undesirable for fresh potatoes. Anti-browning dips like 0.5% L-cysteine + 2% citrate, in combination with MAP, are needed to prevent browning of whole peeled potatoes. The recommended storage temperature is 0 °C. Shelf-life of minimally-processed products can be extended to 3 weeks under CA and refrigeration. Dipping potato strips in chlorine solutions (100 and 300 ppm) result in higher microbial populations during storage, while potatoes treated with anti-browning solutions combined with MAP showed only a slight increase. MAP had no significant effect on microbial populations compared to non-packaged samples. The recommended CA is 1 to 3% O<sub>2</sub> + 6 to 9% CO<sub>2</sub>.

### 7.10. Tomato (Sliced, Diced)

Fresh-cut tomatoes should have consistent red colour and firm texture. Sliced tomatoes have no gel loss from the seed cavities. Diced tomatoes have no seeds and stem pieces. Fruit should be firm and have small seed cavities. For diced tomato products, tomatoes should be spray-washed with chlorinated water before cutting. After cutting, an open fluming system with 0.25% CaCl<sub>2</sub> and 100 ppm chlorine is used to wash and remove seeds. For sliced tomato products, whole tomatoes are dipped in 200 ppm chlorinated water for more than 1 min before slicing. Various automated slicing machines have been developed for tomatoes. Although tomatoes are chilling sensitive, they can be stored at 0 to 5°C for a few days before processing to retard softening.

A CA of 3% O<sub>2</sub> + 3% CO<sub>2</sub> will delay ripening, as well as soluble solid content and acidity losses. Water soaking of tomatoes produces translucent tissue, textural changes, and softening reduces the quality of

diced tomatoes during storage. In addition to these deleterious changes, quality of tomato slices can be reduced by seed germination and loss of locular gel. The high acidity of tomato products suppresses microbial growth, but growth of yeasts and moulds can reduce quality in storage.

### 7.11. Bell Pepper (Diced, Sliced)

Fresh-cut bell pepper should have no discoloration (darkening) or water soaking. Raw material should be stored at 7 to 10°C, but stored at 1 and 4 °C after processing to assure quality and reduce potential for freezing of product during handling, distribution and storage. Defects that reduce overall visual quality includes darkening of the green or red pulp, brown discoloration of the cut surfaces and decay. Whole peppers should be spray-washed before processing and washed after being cored and cut to reduce microbial population. Alternatively, cut pepper can be washed using a combination of open flume and close flume systems.

Although intact peppers are chilling sensitive, it is necessary to store fresh-cut red and green pepper at 0 to 5°C to maintain visual quality. Visual quality was maintained and few compositional changes occurred during 15 days of storage at 1°C. Full ripe or red peppers are less chilling sensitive than mature-green fruits of the same cultivar. The recommended CA is 3% O<sub>2</sub> + 5 to 10% CO<sub>2</sub>. Levels of CO<sub>2</sub> > 10% can result in tissue darkening and softening. Shelf-life and sensitivity to CO<sub>2</sub> injury varies significantly among cultivars. Aroma and texture decrease after 6 days in 10% CO<sub>2</sub>, but were maintained in air at 0°C.

## 8. TYPICAL POINTS TO REMEMBER FOR HIGH QUALITY FRESH-CUT PRODUCE

- Certify that the raw ingredient suppliers are produced by using Good Agricultural Practices (GAP).
- Use only the highest quality produce as raw ingredients.
- Always follow Good Manufacturing Practices (GMP).
- Carefully monitor and maintain appropriate wash water pH and chlorine levels.
- Monitor and maintain wash water temperature near 0°C.
- Keep cutting and coring blades as sharp as possible.

- Always keep finished products between 0-5°C.
- Use appropriate flexible packaging material well suited to your product and markets.
- Assure food safety by implementing a HACCP system.
- Prevent temperature abuse during distribution and marketing.

## 9. FUTURE RESEARCH NEEDS

The understanding of physiology of fresh-cut vegetables is essential for ensuring their wholesomeness and nutritional value and for developing the most effective handling procedures and innovate new technologies. Much research is still needed to develop fresh-cut vegetable products that have a high sensory quality, microbiological safety and nutritional value. Products intended for retailing are in particular need of further development. It seems that it is possible to achieve a shelf life of 7-8 days at refrigeration temperatures (5°C), but for some markets a shelf life of 2-3 weeks is necessary. More information about the growth of pathogenic bacteria and the occurrence of nutritional changes in fresh-cut vegetables with long shelf life is needed.

A characteristic feature of fresh-cut processing is an integrated approach, where raw materials, handling, processing, packaging and distribution must all be properly considered to make shelf-life extension possible. New cultivars need to be selected or adapted to meet the specific requirements of fresh-cut processing. The equipment used in unit operations, such as peeling and shredding needs further development so that it can process produce more gently. There is no sense in disturbing the quality of produce by rough treatment during processing and patching it up afterwards by the use of preservatives. Hurdle technology that makes use of natural preservatives, such as inhibitors produced by lactic acid bacteria and the matching of correct processing methods and ingredients to each other are two approaches that should be applied more often during the minimal processing of produce. Active-packaging systems and edible films, as well as more-permeable plastic films that better match the respiration activity of vegetables need to be further developed.



## LITERATURE CONSULTED

---

- Ashby B H et al. 1987. Protecting perishable foods during transport by truck. Washington, D.C.: USDA, Office of Transportation, Agricultural Handbook No. 669.
- Bartsch, J A et al. (No date). Construction and management of an iced produce display. Cornell University, Agricultural Engineering Extension Bull. 438.
- Bubel M and Bubel N (1979). Root Cellaring: The Simple No-Processing Way to Store Fruits and Vegetables. Emmaus, PA: Rodale Press. 297 pp.
- Camelo Andrés F. López (2004). Manual for the preparation and sale of fruits and vegetables-From field to market. FAO Agricultural Services Bulletin 151, Rome.
- CIP (1981). Principles of Potato Storage. Lima, Peru: International Potato Center (CIP). 105 pp.
- Davis H R et al (No date). Storage Recommendations for Northern Grown Onions. Information Bulletin 148. Ithaca, NY: Cornell University Extension.
- Dhatt A S, Mahajan B V C, Sandhu K S, Garg A, Dhall R K and Sharma S R (2008) Handbook on Postharvest Handling of Fruits and Vegetables. 4rd edition, PHPTC, PAU, Ludhiana.

- FAO (1985). Prevention of Post-Harvest Food Losses: A Training Manual. Rome: UNFAO. 120pp
- FAO Agricultural Services Bulletin (2004). Manual for the preparation and sale of fruits and vegetables from field to market.
- Gast KLB and Flores (1991). Pre-cooling produce-Fruits and Vegetables. In: Postharvest management of commercial horticultural crops. Cooperative Extension Service, MF-1002, Kansas state University.
- Kader A A (1994). Perishables Handling Newsletter Issue No. 80.
- Kader A A (2002). Postharvest Technology of Horticultural Crops. 3rd Edition, University of California, Agricultural and Natural Resources.
- Kader A A (2002). Postharvest Technology of Horticultural Crops. 3rd Edition, University of California, Agricultural and Natural Resources.
- Kader A A and Merita Cantwell (2006). Produce Quality Rating Scales and Color Charts. Postharvest Horticulture Series No 23. Postharvest Technology Research and Information Center University of California, Davis.
- Kasmire R F (1977). California Tomatorama. Fresh Market Tomato Advisory Board Information Bulletin No. 17.
- Kasmire R F (1981). Continuous flow ethylene gassing of tomatoes. California Tomatorama. Fresh Market Tomato Advisory Board Information Bulletin No 29.
- Kasmire R F and Hinsch R T (1987). Maintaining Optimum Transit Temperatures in Refrigerated Truck Shipments of Perishables. University of California Perishables Handling Transportation Supplement No. 2.
- Kays S J and Beaudry R M (1987). Techniques in inducing ethylene effects. Acta Hort 201: 77-116.
- Kitinoja L and Gorny J (1998). Post-harvest technology for fruits and vegetables Produce marketers: Economic opportunities. Quality and Food Safety by, Department of Pomology, University of California, Davis. A joint publication of UC Postharvest Outreach Program and Punjab Horticultural Postharvest technology Centre, USAID/ACE project.

- Kitinoja L and Kader A A (1995). Small-scale postharvest handling practices- A manual for horticultural crops- 3rd Edition. Department of Pomology, University of California - Davis, California 95616.
- Martin D and Mieztis E O (1964). A wipe-on device for the application of materials to butts. Field Station Record Volume 3 No. 1 CSIRO Tasmanian Regional Laboratory, Hobart, Tasmania.
- McGregor B (1989). Tropical Products Transport Handbook. USDA, Office of Transportation, Agricultural Handbook Number 668.
- Nicholas C J (1985). Export Handbook for U.S. Agricultural Products. USDA, Office of Transportation, Agricultural Handbook No. 593
- Oregon State University (1978). Onion Storage: Guidelines for Commercial Growers. Oregon State Extension Service. Extension Circular 948.
- Pantastico E B. (1980) . FAO/UNEP Expert Consultation on Reduction of Food Losses in Perishable Products of Plant Origin. Working Document 2: Fruits and Vegetables. (6-9 May, Rome: FAO)
- Rij R. et al. (1979). Handling Precooling and Temperature Management of Cut Flower Crops for Truck Transportation. USDA Science and Education Administration, AAT-W-5, UC Leaflet 21058.
- Roy S K (1989). Postharvest technology of vegetable crops in India. Indian Horticulture. Jan-June: 7678.
- Seung Koo Lee (1994). Assoc. Prof., Postharvest Technology Lab., Department of Horticulture, Seoul National University, Suwon 441-744, Korea.
- Thompson A .K. (1996) Postharvest Technology of Fruits and Vegetables. 1st Edition, Blackwell Science, Inc. USA.
- Thompson J and Scheuerman R W (1993). Curing and Storing California Sweetpotatoes. Merced County Cooperative Extension, Merced, California
- Thompson J F (1994). Ripening Facilities. Perishable Handling Newsletter, Nov. 1994, Special Issue, No 80: 5-8

Thompson J F, Mitchell F G, Rumsey T R, Kasmire R F and Crisosto C C (1998). Commercial cooling of fruits, vegetables, and flowers. Univ. Calif. DANR Pub. No. 21567.

Thompson J F and Kader A A (1995). Postharvest Outreach Program, University of California, Davis.

Walker D J (1992). World Food Programme Food Storage Manual. Chatham, UK: Natural Resources Institute.

Wills R, McGlasson B, Graham D and Joyce D (1998). Postharvest: An Introduction to the Physiology and Handling of Fruit, Vegetables and Ornamentals. 4th Edition, CAB International, UK.

## LITERATURE CONSULTED

---

- Ashby B H et al. 1987. Protecting perishable foods during transport by truck. Washington, D.C.: USDA, Office of Transportation, Agricultural Handbook No. 669.
- Bartsch, J A et al. (No date). Construction and management of an iced produce display. Cornell University, Agricultural Engineering Extension Bull. 438.
- Bubel M and Bubel N (1979). Root Cellaring: The Simple No-Processing Way to Store Fruits and Vegetables. Emmaus, PA: Rodale Press. 297 pp.
- Camelo Andrés F. López (2004). Manual for the preparation and sale of fruits and vegetables-From field to market. FAO Agricultural Services Bulletin 151, Rome.
- CIP (1981). Principles of Potato Storage. Lima, Peru: International Potato Center (CIP). 105 pp.
- Davis H R et al (No date). Storage Recommendations for Northern Grown Onions. Information Bulletin 148. Ithaca, NY: Cornell University Extension.
- Dhatt A S, Mahajan B V C, Sandhu K S, Garg A, Dhall R K and Sharma S R (2008) Handbook on Postharvest Handling of Fruits and Vegetables. 4rd edition, PHPTC, PAU, Ludhiana.

FAO (1985). Prevention of Post-Harvest Food Losses: A Training Manual. Rome: UNFAO. 120pp

FAO Agricultural Services Bulletin (2004). Manual for the preparation and sale of fruits and vegetables from field to market.

Gast KLB and Flores (1991). Pre-cooling produce-Fruits and Vegetables. In: Postharvest management of commercial horticultural crops. Cooperative Extension Service, MF-1002, Kansas state University.

Kader A A (1994). Perishables Handling Newsletter Issue No. 80.

Kader A A (2002). Postharvest Technology of Horticultural Crops. 3rd Edition, University of California, Agricultural and Natural Resources.

Kader A A (2002). Postharvest Technology of Horticultural Crops. 3rd Edition, University of California, Agricultural and Natural Resources.

Kader A A and Merita Cantwell (2006). Produce Quality Rating Scales and Color Charts. Postharvest Horticulture Series No 23. Postharvest Technology Research and Information Center University of California, Davis.

Kasmire R F (1977). California Tomatorama. Fresh Market Tomato Advisory Board Information Bulletin No. 17.

Kasmire R F (1981). Continuous flow ethylene gassing of tomatoes. California Tomatorama. Fresh Market Tomato Advisory Board Information Bulletin No 29.

Kasmire R F and Hinsch R T (1987). Maintaining Optimum Transit Temperatures in Refrigerated Truck Shipments of Perishables. University of California Perishables Handling Transportation Supplement No. 2.

Kays S J and Beaudry R M (1987). Techniques in inducing ethylene effects. Acta Hort 201: 77-116.

Kitinoja L and Gorny J (1998). Post-harvest technology for fruits and vegetables Produce marketers: Economic opportunities. Quality and Food Safety by, Department of Pomology, University of California, Davis. A joint publication of UC Postharvest Outreach Program and Punjab Horticultural Postharvest technology Centre, USAID/ACE project.

- Kitinoja L and Kader A A (1995). Small-scale postharvest handling practices- A manual for horticultural crops- 3rd Edition. Department of Pomology, University of California - Davis, California 95616.
- Martin D and Mieзитis E O (1964). A wipe-on device for the application of materials to butts. Field Station Record Volume 3 No. 1 CSIRO Tasmanian Regional Laboratory, Hobart, Tasmania.
- McGregor B (1989). Tropical Products Transport Handbook. USDA, Office of Transportation, Agricultural Handbook Number 668.
- Nicholas C J (1985). Export Handbook for U.S. Agricultural Products. USDA, Office of Transportation, Agricultural Handbook No. 593
- Oregon State University (1978). Onion Storage: Guidelines for Commercial Growers. Oregon State Extension Service. Extension Circular 948.
- Pantastico E B. (1980) . FAO/UNEP Expert Consultation on Reduction of Food Losses in Perishable Products of Plant Origin. Working Document 2: Fruits and Vegetables. (6-9 May, Rome: FAO)
- Rij R. et al. (1979). Handling Precooling and Temperature Management of Cut Flower Crops for Truck Transportation. USDA Science and Education Administration, AAT-W-5, UC Leaflet 21058.
- Roy S K (1989). Postharvest technology of vegetable crops in India. Indian Horticulture. Jan-June: 7678.
- Seung Koo Lee (1994). Assoc. Prof., Postharvest Technology Lab., Department of Horticulture, Seoul National University, Suwon 441-744, Korea.
- Thompson A .K. (1996) Postharvest Technology of Fruits and Vegetables. 1st Edition, Blackwell Science, Inc. USA.
- Thompson J and Scheuerman R W (1993). Curing and Storing California Sweetpotatoes. Merced County Cooperative Extension, Merced, California
- Thompson J F (1994). Ripening Facilities. Perishable Handling Newsletter, Nov. 1994, Special Issue, No 80: 5-8

Thompson J F, Mitchell F G, Rumsey T R, Kasmire R F and Crisosto C C (1998). Commercial cooling of fruits, vegetables, and flowers. Univ. Calif. DANR Pub. No. 21567.

Thompson J F and Kader A A (1995). Postharvest Outreach Program, University of California, Davis.

Walker D J (1992). World Food Programme Food Storage Manual. Chatham, UK: Natural Resources Institute.

Wills R, McGlasson B, Graham D and Joyce D (1998). Postharvest: An Introduction to the Physiology and Handling of Fruit, Vegetables and Ornamentals. 4th Edition, CAB International, UK.