

UNIVERSITY OF DEVELOPMENT ALTERNATIVE



**PRESENTATION ON THEORY OF
ELECTROLYTIC DISSOCIATION**

PRESENTED TO
SHAHANOOB ROHANI
LECTURER
DEPARTMENT OF PHARMACY

Group Members

Name

ID

- | | |
|-------------------------|-----------|
| 1. Shamima Nasrin Bithi | 032182011 |
| 2. Tofayal Ahmed | 032182017 |
| 3. Rakibul Hasan | 032182015 |

ARRHENIUS THEORY OF IONISATION

Savante Arrhenius(1884)

1. When dissolved in water, neutral electrolyte molecules are split up into two types of charged particles.
2. The ions present in solution constantly reunite to form neutral molecules.
3. The charged ions are free to move through the solution to the oppositely charged electrode.
4. The electrical conductivity of an electrolyte solution depends on the number of ions present in solution.



Electrolyte **Ions**

MIGRATION OF IONS

The movement of ions towards the oppositely charged electrode is called migration of ions.

1. Lodge's moving boundary experiment
2. Movement of colored ions

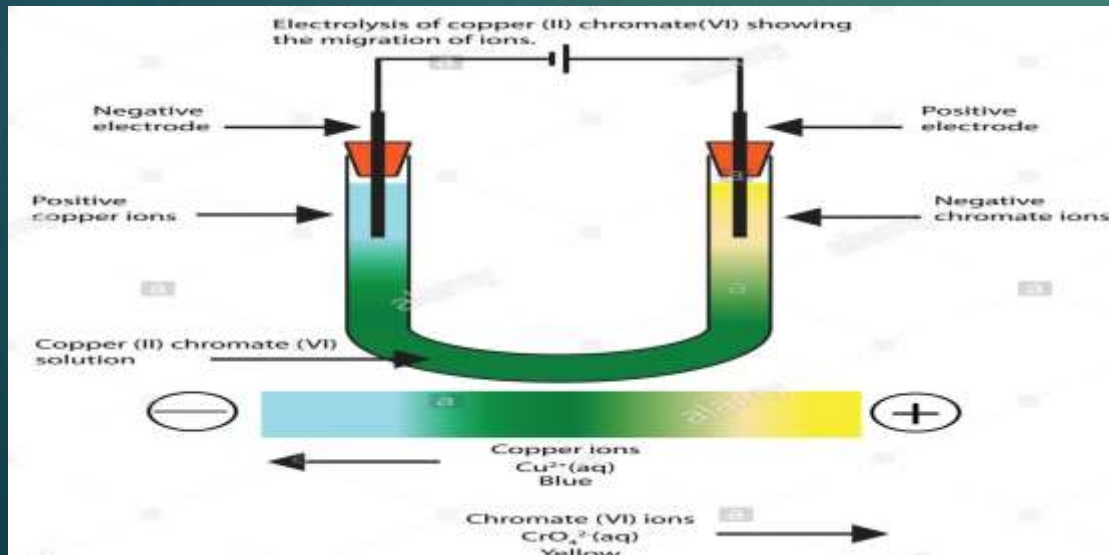
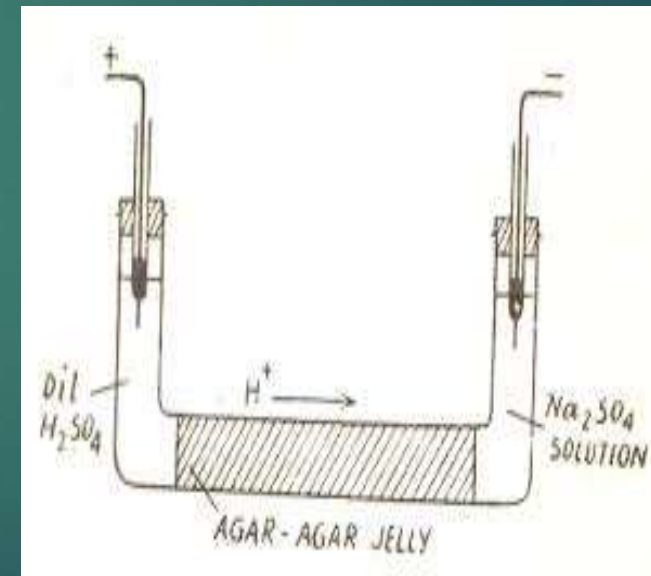
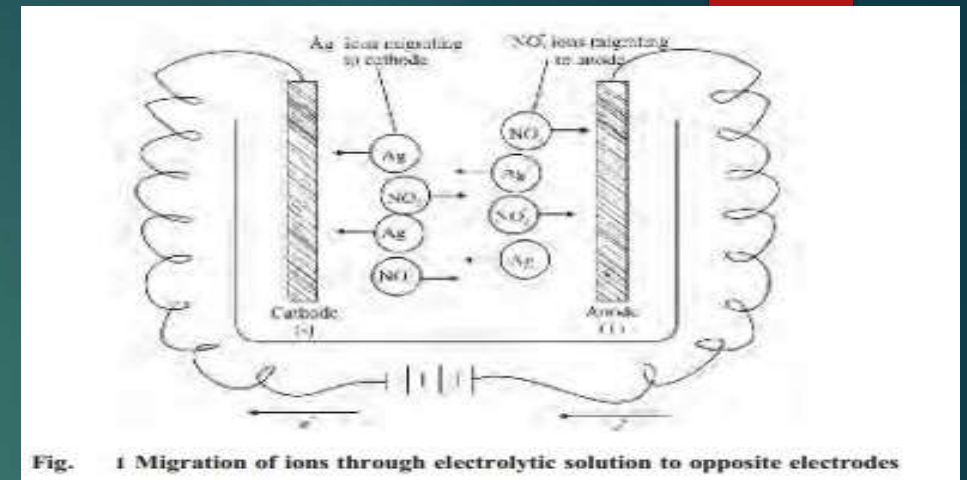

RELATIVE SPEEDS OF IONS

- ▶ The speed of a cation moving away from the anode will be proportional to the fall of concentration of these ions at the anode.
- ▶ Similarly the speed of an anion moving away from the cathode will be proportional to the fall of concentration of anions around the cathode.

Hittorf gave a general rule on them known as Hittorf's Rule : "The loss of concentration around any electrode is proportional to the speed of the ion moving away from it.

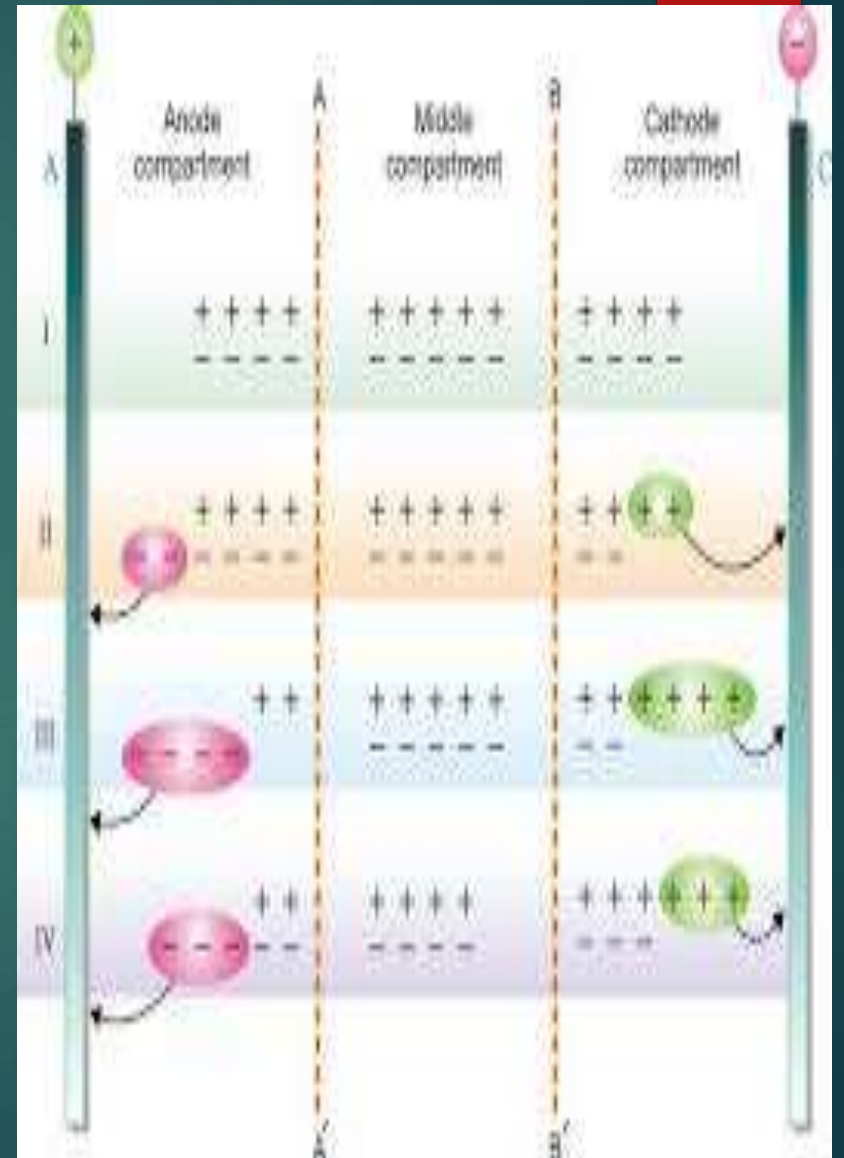

TRANSPORT NUMBER

- ▶ Also known as Hittorf's number.
- ▶ The fraction of the total current carried by the cation or anion is termed its Transport number.

- ▶ The transport number of cation = $\frac{v_+}{v_+ + v_-}$

- ▶ The transport number of anion = $\frac{v_-}{v_+ + v_-}$

[v_+ represents the speed of migration of the cation

v_- represents the speed of migration of the anion]

DETERMINATION OF TRANSPORT NUMBER

- ▶ There are two methods for determination of the transport number of an ion:
 1. Hittorf's method
 2. Moving Boundary method

The Hittorf method is based on measurements of ion concentration changes near the electrodes.

The moving boundary method involves measuring the speed of displacement of the boundary between two solutions due to an electric current

HITTORF'S METHOD

- ▶ Hittorf's apparatus consist of a two limbed vessel connected by a narrow U-tube in the middle. Both limbs as well as the U-tube are provided with stop-cocks at the bottom for the withdrawal of the solution.
- ▶ The two limbs are provided with Pt electrodes. To determine the transport numbers of Ag^+ in $AgNO_3$ the electrodes are either of Pt or pure Ag.
- ▶ The apparatus is filled with a standard solution of $AgNO_3$ (usually 0.1N) and the cell is connected in series with a source of direct current(like battery).

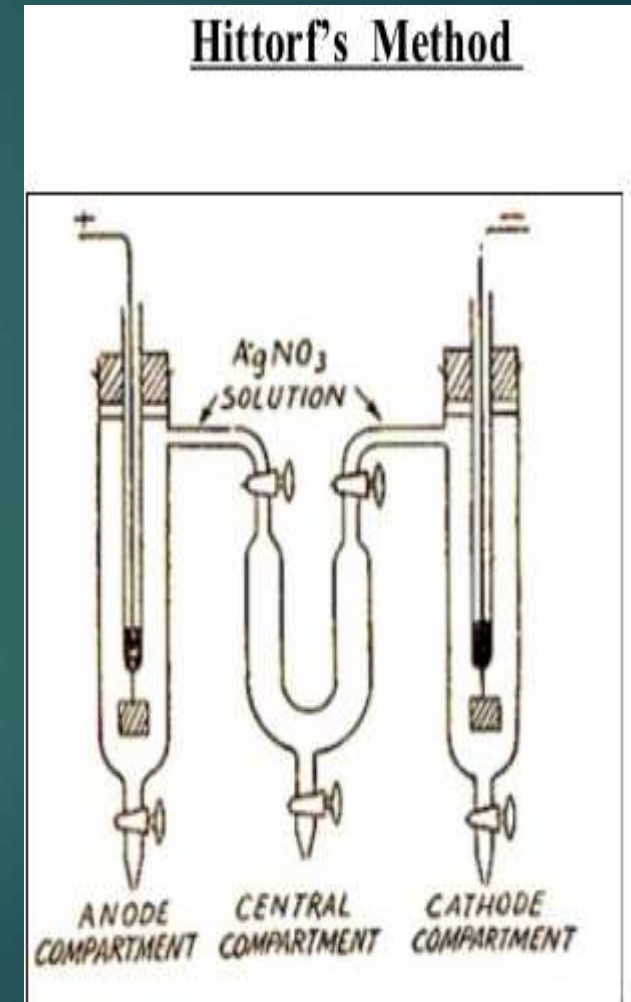

THE MOVING BOUNDARY METHOD

1. This method is based on the direct observation of migration of ions in an electric field. The conductivity cell, in this method consists of a vertical tube filled with cadmium chloride and hydrochloric acid.
2. HCl is the principal electrolyte, and CdCl_2 serves as the indicator electrolyte to enable formation of a boundary.

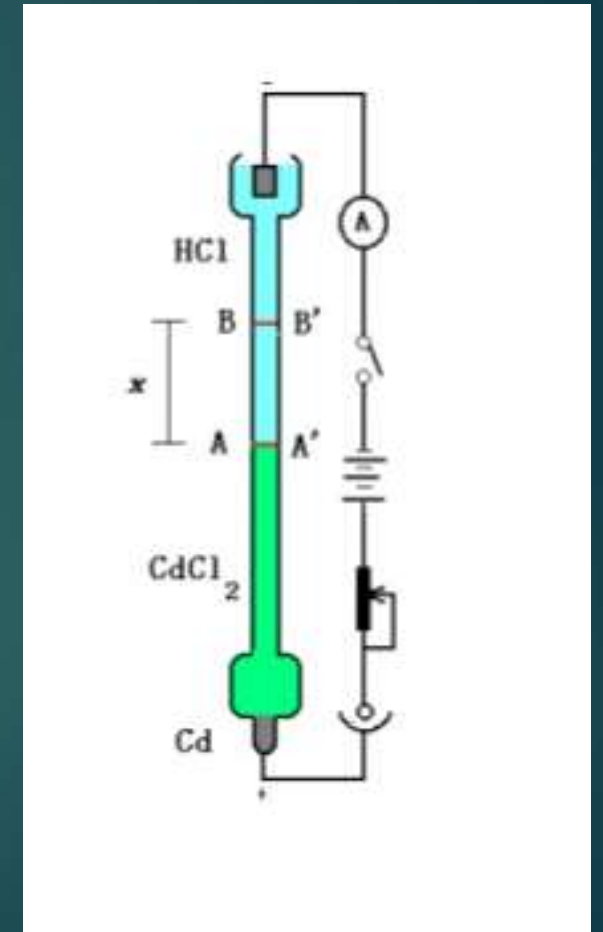

KOHLRAUSCH'S LAW

The equivalent conductance of an electrolyte at infinite dilution is equal to the sum of the equivalent conductances of the component ions.

As mathematically the law is,

$$\lambda_{\infty} = \lambda_a + \lambda_c$$

Where λ_a is the equivalent conductance of the anion and λ_c that of the cation.

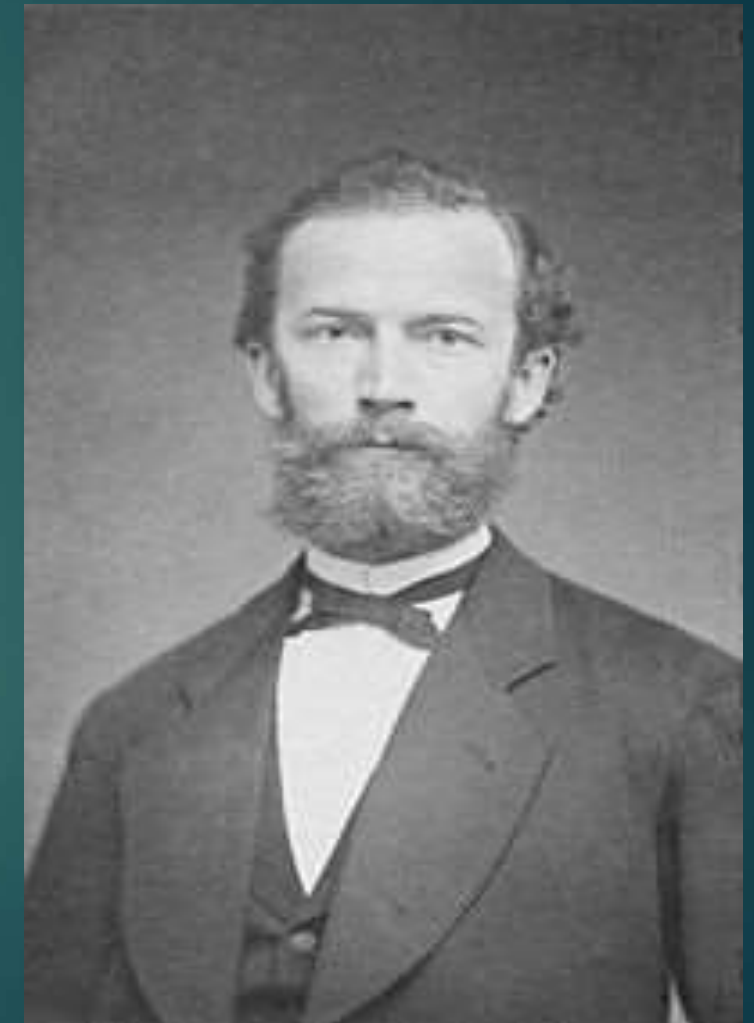

Uses of Kohlrausch's law

→ Calculation of molar conductivity at infinite dilution for weak electrolytes

→ Calculation of degree of dissociation.

→ Calculation of dissociation constant for a weak electrolyte

→ Calculation of solubility of sparingly soluble salt.

CONDUCTOMETRIC TITRATIONS

- ▶ Titration in which conductance measurements are made use of in determining the end point of acid alkali reactions , some displacement reactions or precipitations reactions are called conductometric titration.

Types of conductometric titrations:

- Acid-base titration
- Precipitation titration
- Replacement titration
- Redox (oxidation-reduction) titration
- Complexometric titration

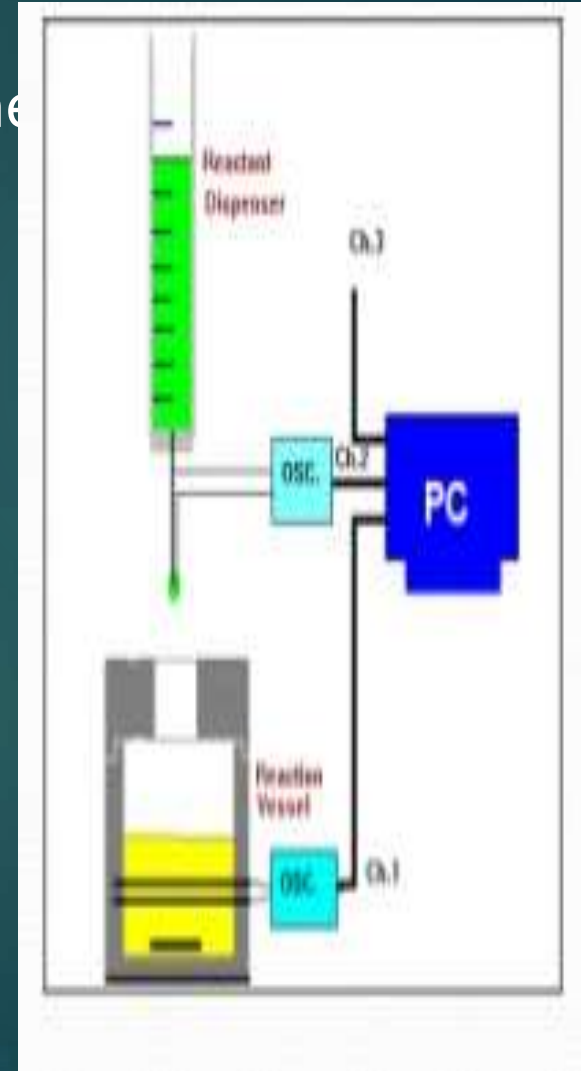

ADVANTAGES OF CONDUCTOMETRIC TITRATIONS

ADVANTAGES OF CONDUCTOMETRIC TITRATIONS

- No need of indicator
- Colored or dilute solutions or turbid suspensions can be used for titrations.
- Temperature is maintained constant throughout the titration.
- End point can be determined accurately and errors are minimized as the end point is being determined graphically.



THANK YOU FOR BEING WITH US