



THERMOCHEMICAL CONVERSION OF BIOMASS

Presented by: Afshan Rashid
16-MRE-013

BIOMASS

- Biomass is organic material which has stored sunlight in the form of chemical energy.
- Biomasses include any organic matter that is available on a renewable basis. It is essential to understand that the origin of the chemical energy in biomasses is solar power.
- Biomass is an important source of energy and the most important fuel worldwide after coal, oil and natural gas.
- Biomass continues to account for an estimated 1/3rd of primary energy use, while in the poorest counties up to 90% of all energy is supplied by biomass.



CONT...

1) Biomass is composed:

- i) Carbohydrate polymers (cellulose and hemicelluloses).
- ii) Aromatic polymer (lignin).

2) Cellulose is an organic compound $(C_6H_{10}O_5)_n$

3) Cellulose is an important structural component of the primary cell wall of green plants.

4) Crystalline, strong and resistant to decomposition in presence of heat.

Cont...

- A **hemicelluloses** is any of several heteropolymers present along with cellulose in almost all plant cell walls.
- Unlike cellulose, hemicelluloses consists of shorter chains of glucose molecules per polymer.
- Hemicelluloses has a little strength in front of heat.

Cont...

- **Lignin** is a class of complex organic polymers that form important structural materials in the support tissues of vascular plants.
- Lignin are particularly important in the formation of cell walls, especially in wood and bark, because they lend rigidity and do not rot easily.
- Lignin fills the spaces in the cell wall between cellulose and hemicelluloses.

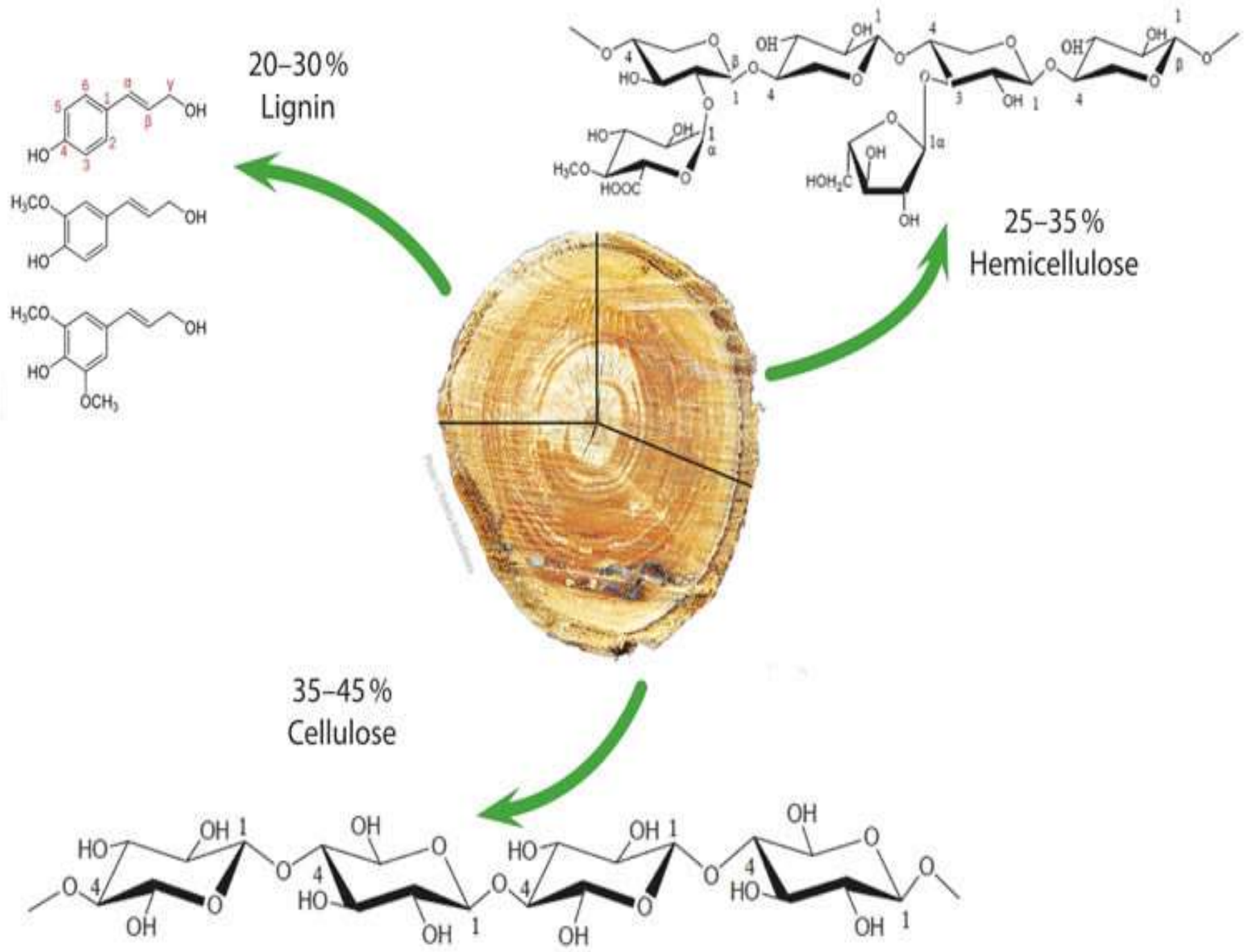

Cont...

- Biomass is divided into **Wet** and **Dry** biomass.
- **Biomass is considered carbon neutral**, because the amount of carbon it can release is equivalent to the amount it absorbed during its life time.
- In the present context, Biomass is considered as a fuel source to partially replace the use of fossil fuels through conversion processes.



Animal
residue



Industrial
residue



Agricultural
residue



Forestry
residue



Municipal
waste



Sewage

Biomass sources

BIOMASS CONVERSION

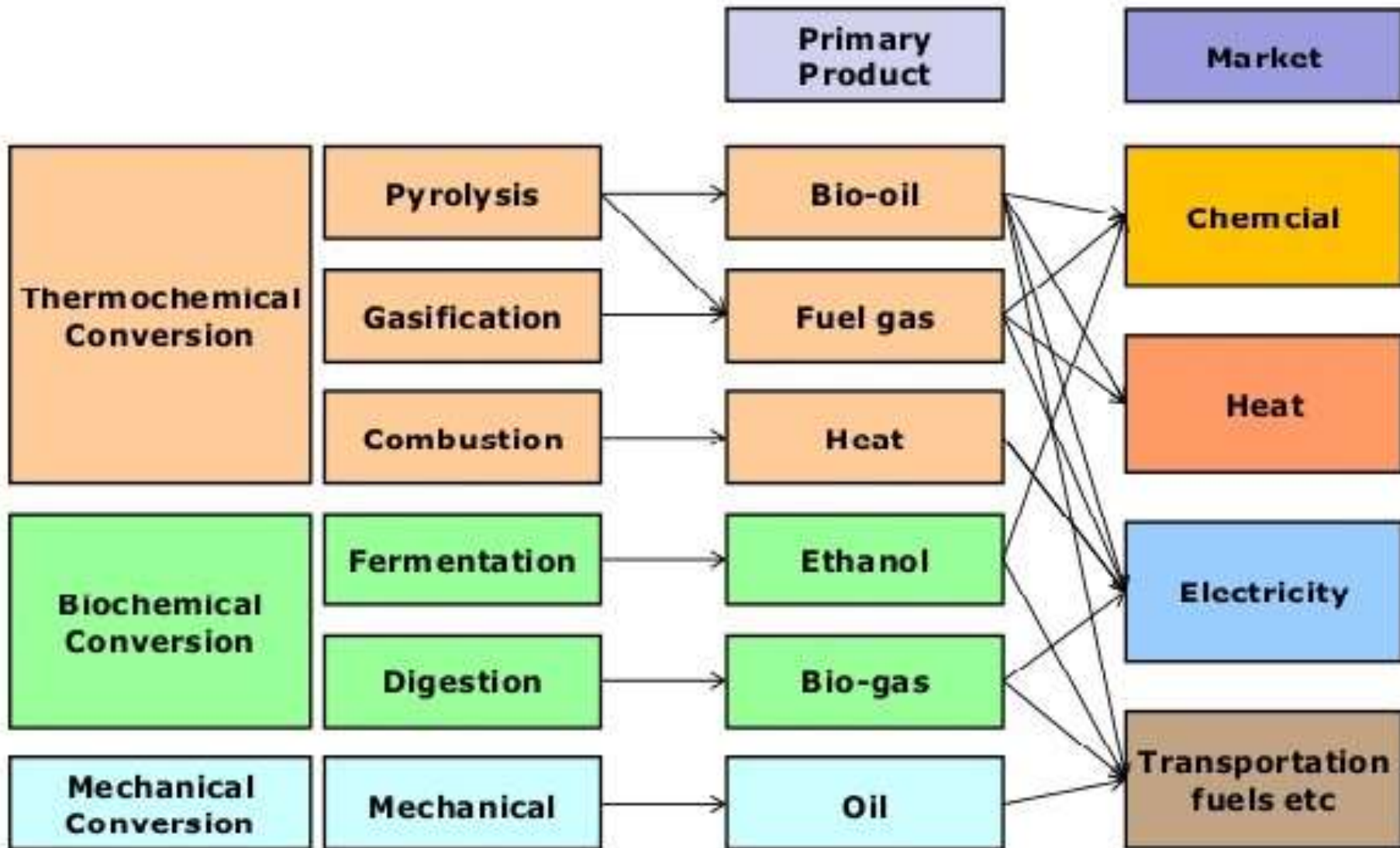

THERMOCHEMICAL CONVERSION

- Thermal conversion processes use heat as the dominant mechanism to convert biomass into another chemical form.
- Also known as thermal oil heating, it is a type of heating in which a liquid phase heat transfer medium is heated and circulated to one or more heat energy users within a closed loop system.
- Thermo chemical processes are most commonly employed for converting biomass into higher heating value fuels.
- Major thermal conversion routes include direct combustion to provide heat, liquid fuel and other elements to generate process heat for thermal and electricity generation.

TYPES OF THERMOCHEMICAL CONVERSION

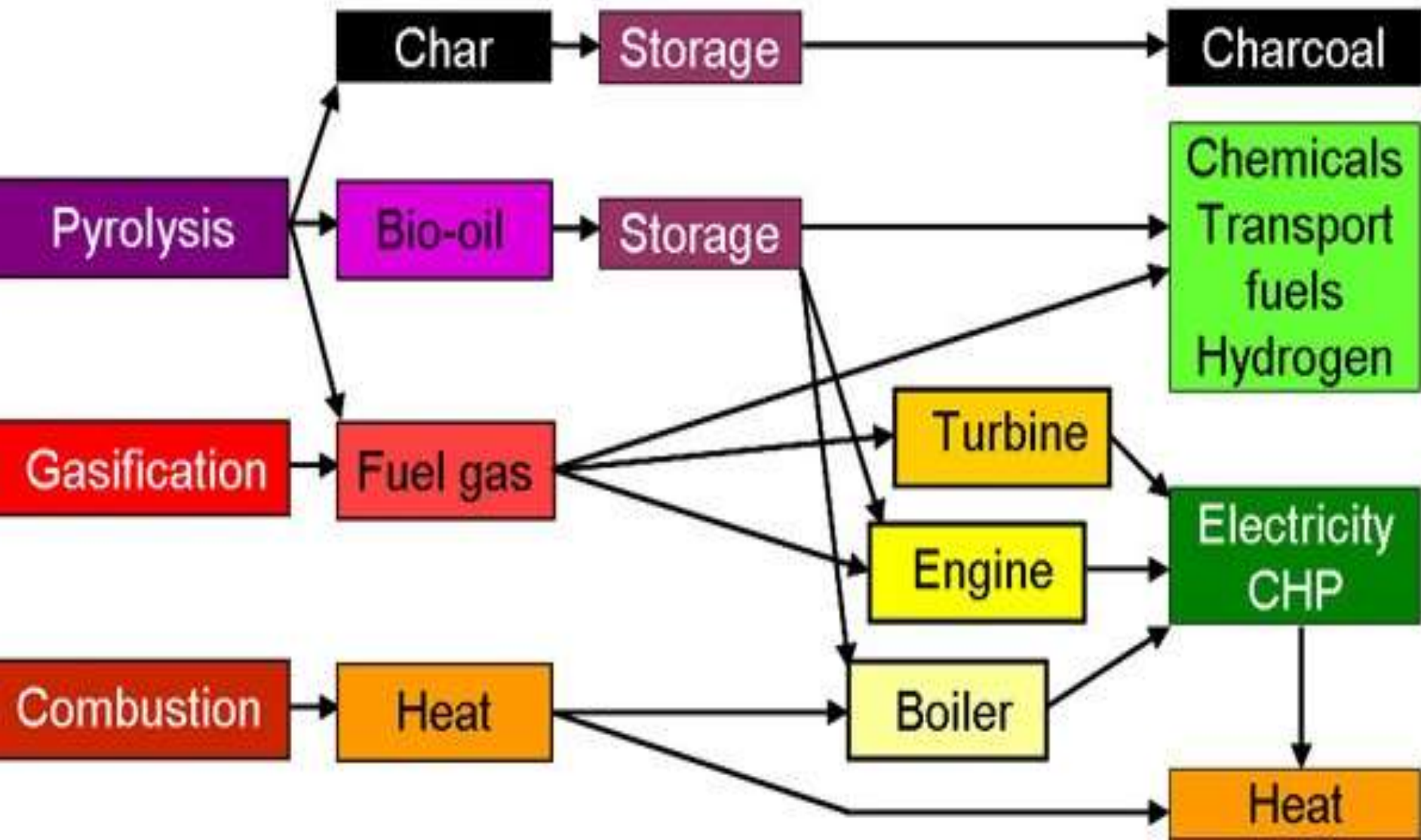

COMBUSTION

- Combustion is defined as the exothermic reaction between fuel and oxygen to form mainly carbon dioxide and water vapors.
- Combustion is the process by which more than 90% of the world's primary energy supply is realized in order to provide heat and energy services.
- It is estimated that in the developing world at least one and a half billion people fulfill their energy needs from wood, either as firewood or indirectly as charcoal.
- Biomass can also be co-combusted with coal in coal-fired plants.

DIRECT COMBUSTION OF BIOMASS

Biomass to Electricity

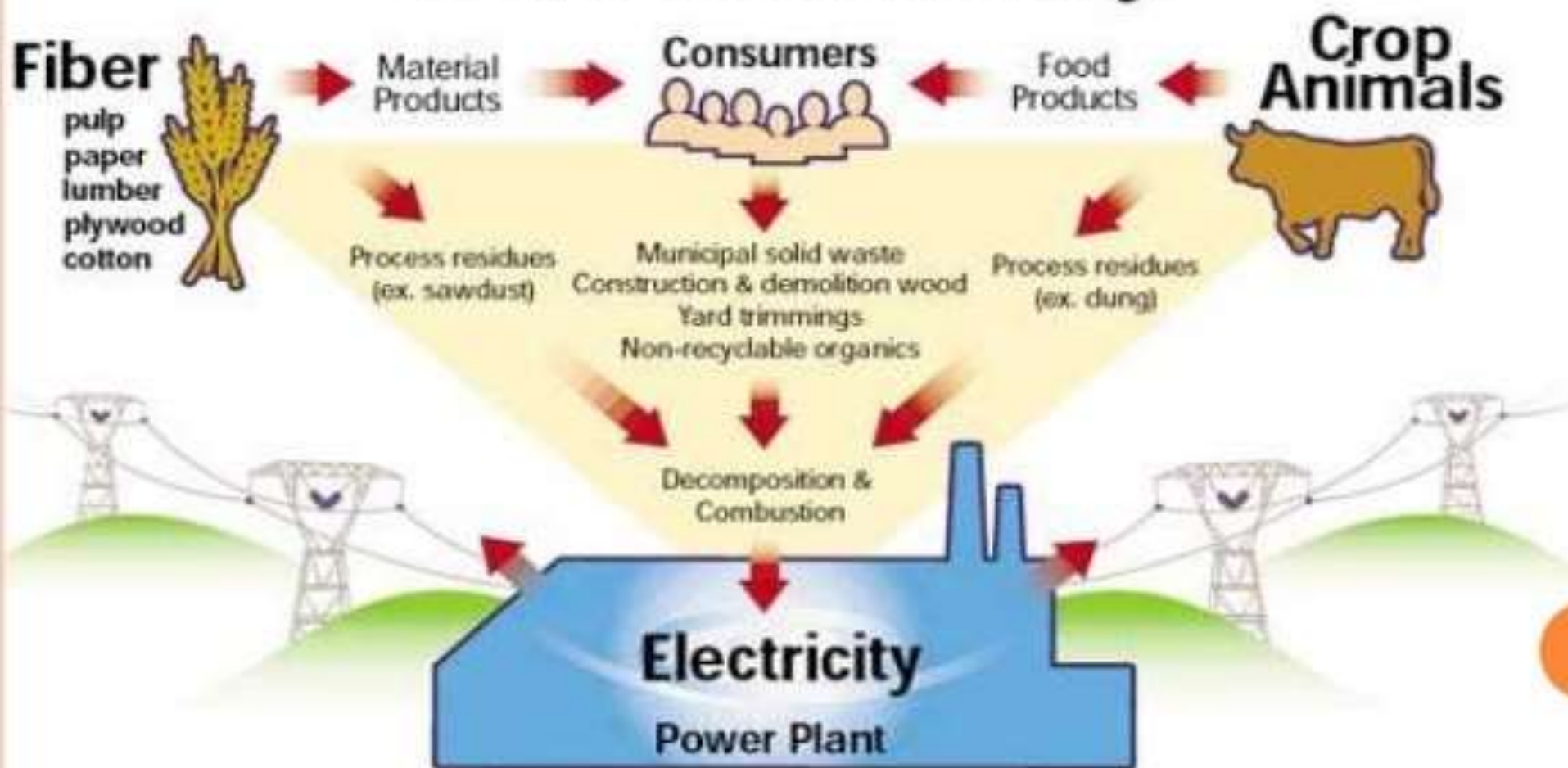

GASIFICATION

- Gasification process is a process of conversion of solid fuel into gaseous fuel for wide applications.
- It produces gaseous fuels like H_2, CO, CH_4, N_2 of low calorific value.
- Biomass Gasification converts biomass into electricity and products, such as ethanol, methanol, fuels, fertilizers, and chemicals.
- In this operation feedstock is heated to high temperatures, producing gases which can undergo chemical reactions to form a synthesis gas.

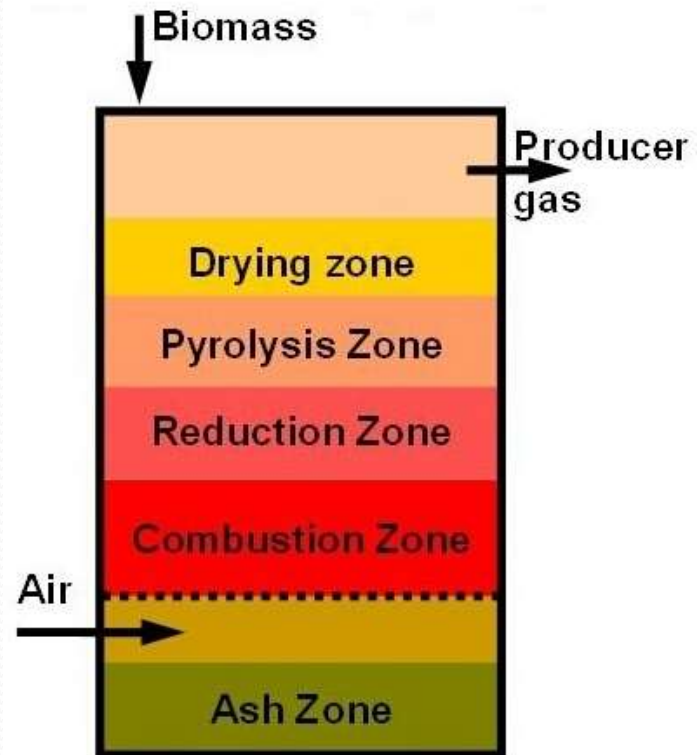

Basic gasification process with different zone.

CONT...

- Biomass is heated with no oxygen or only about one-third oxygen for efficient combustion, it **gasifies to a mixture of carbon monoxide and hydrogen—synthesis gas or syngas** that has an energy content of 5 to 20 MJ/Nm³ (depending on the type of biomass and whether gasification is conducted with air, oxygen or through indirect heating).
- This energy content is roughly 10 to 45% of the heating value of natural.
- This whole process completed at elevated **temperature range of 800–1300 °C** with series of chemical reaction that is why it come under thermo chemical conversion.

GASIFICATION PROCESS

- During gasification, the material is heated to a high temp, Which causes a series of physical and chemical changes that result in evolution of volatile products and solid residues.
- The amount of volatile products and their compositions depend on:
 - i) The reactor temp.
 - ii) Type of fuel material.
 - iii) Characteristics of fuel material.

CONT...

Gasification is made up for five discrete thermal processes:

- i) Drying*: The fuel wood pellets are heated and dried at the top of the gasifier unit. Moisture contained in the wood pellets is removed in this region to a level below 20%.
- ii) Pyrolysis*: The dried wood pellets enter the second zone called the “Pyrolysis” zone. In this process gaseous products from devolatilization are partially burnt with the existing air.
- iii) Combustion*: In the combustion zone the outputs from the above zone, react with the remaining char in the absence of oxygen at a temperature of around 800-900 °C.
- iv) Cracking*: In this zone Tar is breakdown into H_2 , CO and flammable gases by exposure to high temp.
- v) Reduction*: In this region the hot gases formed in the above process is converted in to “Producer Gas” by the endothermic reactions

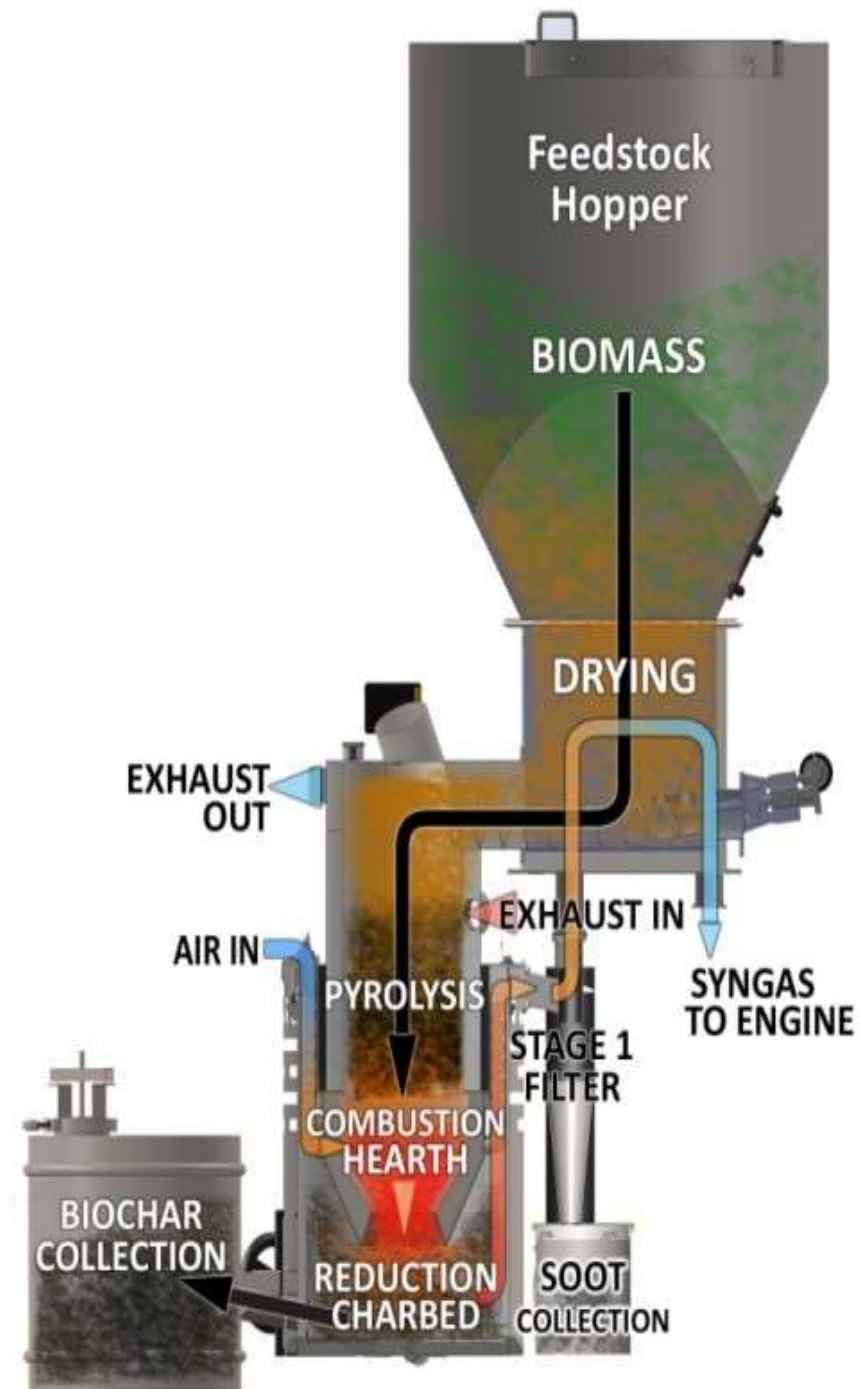
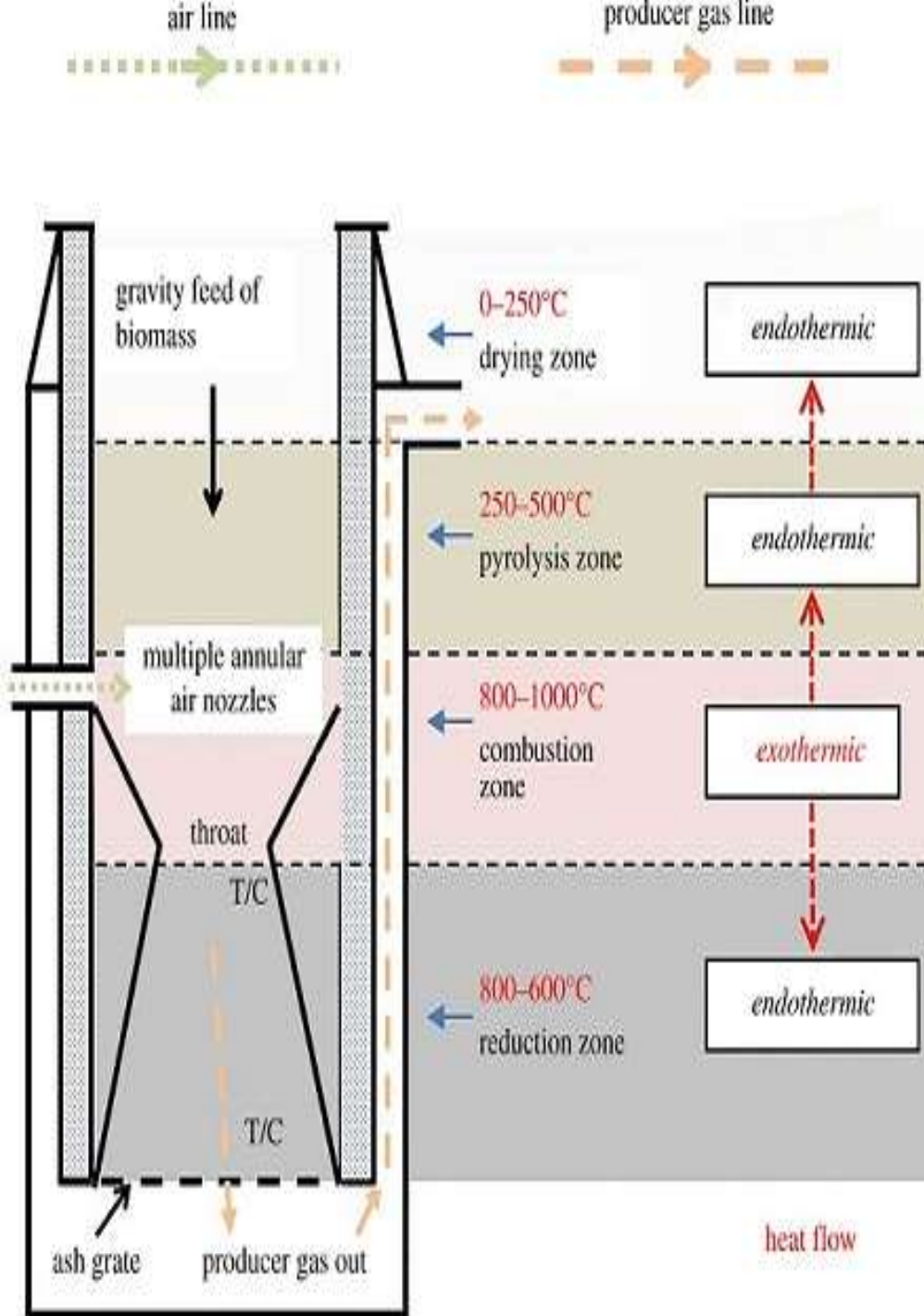

REACTIONS INVOLVED IN GASIFICATION

Combustion zone



Reaction zone



PRODUCER GAS CONSTITUENTS

Constituents	Percentage
Carbon monoxide (CO)	8-9 %
Hydrogen (H ₂)	8-12 %
Carbon dioxide (CO ₂)	2-4 %
Methane (CH ₄)	2-4 %
Nitrogen (N ₂)	45-50 %

Factors Influencing Gasification Process

- Bed temperature.
- Bed pressure.
- Bed height.
- Moisture content of feed material.
- Particle size.
- Air/steam ratio.
- Presence of catalysts.

Classification of biomass Gasifiers

- Design of gasifier depends upon type of fuel used, air introduction in the fuel column and type of combustion bed. Two types:
- Fixed Bed Gasifiers
 - a) Up-draught Gasifier
 - b) Down-draught Gasifier
 - c) Cross-draught Gasifier
- Fluidized Bed Gasifiers
 - a) Circulating Fluidized
 - b) Bubbling Bed

FIXED BED GASIFIERS

- The fixed bed type gasifier simply consisting of cylindrical reactor in which solid biomass fuel gasifying and produced gas move either upward or downward.
- These types of gasifier are simple in construction and generally operate with high carbon conversion, long solid residence time; low gas velocity and low ash carry over.
- Several type of fixed bed gasifiers were operating worldwide and further these can be classified according to the way in which primary air to gasify the biomass enters into the gasifier.

UPDRAFT GASIFIER

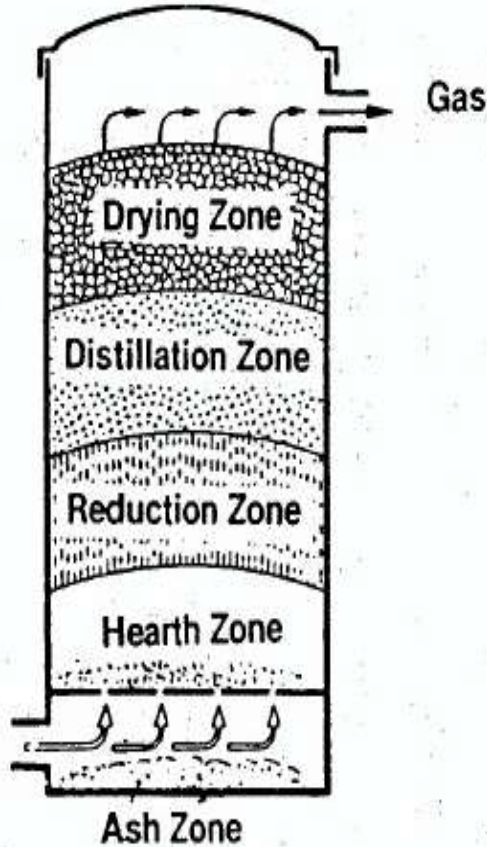

Updraft gasifier

- As the name indicates, air is introduced at the bottom and biomass at top of the reactor.
- A metallic grate is provided at the bottom of the reactor which supports the reaction bed.
- Complete combustion of char takes place at the bottom of the bed, liberating CO_2 and H_2O .
- These hot gases ($\sim 1000^\circ\text{C}$) pass through the bed above, where they are reduced to H_2 and CO and cooled to 750°C .
- Continuing up the reactor, the reducing gases (H_2 and CO) pyrolyze the descending dry biomass and finally dry the incoming wet biomass, leaving the reactor at a low temperature ($\sim 500^\circ\text{C}$).
- The gas is drawn at upper side.

T:700-1200

Tarlow

Scale:<5MW

Feedstock:very critical

DOWNDRAFT GASIFIER

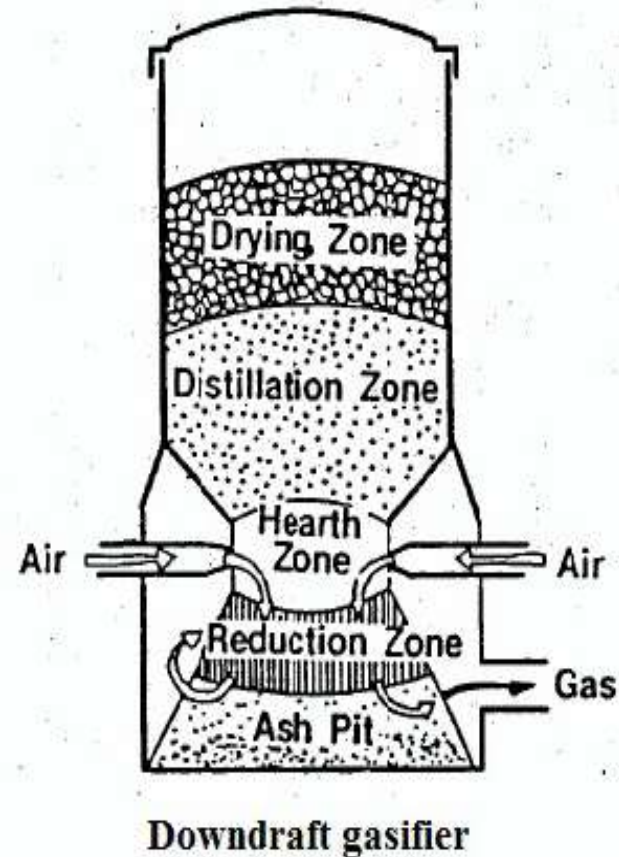

- In a downdraft gasifier, feedstock is introduced at the top and the gasifying agent is introduced through a set of nozzles located on the sides of the reactor.
- Reaction zones in a downdraft gasifier are similar to those in the updraft unit, except the locations of the oxidation and reduction zones are interchanged.
- The most important difference is that the pyrolysis products in the downdraft type are allowed to pass through the high temperature oxidation zone. Hence, they undergo further decomposition.
- Also, the moisture vaporized from the biomass enters the gasification zone and serves as a gasifying agent.
- The final product gases, which leave the gasifier from the bottom at a fairly high temperature (700°C), contain substantially less tar than the updraft gasifiers.

T:700-900
Tar:very high
Control:very easy
Scale:<20MW
Feedstock:critical

1. Updraft or counter-current gasifier

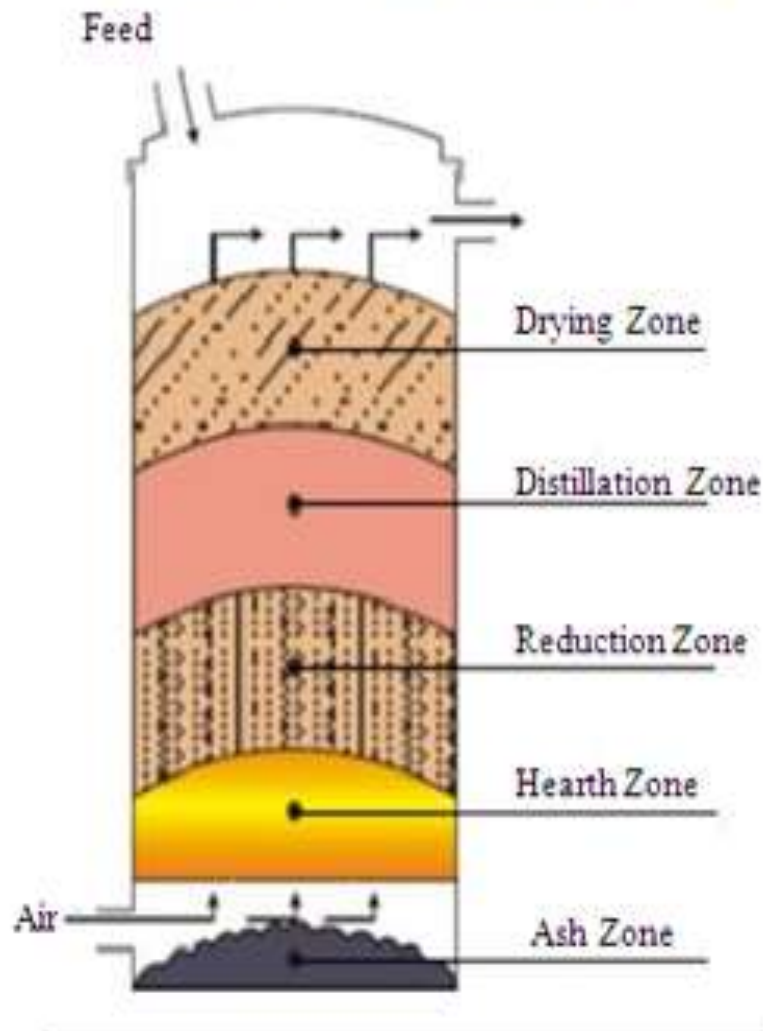

Updraft gasifiers are less sensitive to fuel size and moisture content as compared to a downdraft gasifier.

2. Downdraft or co-current gasifier

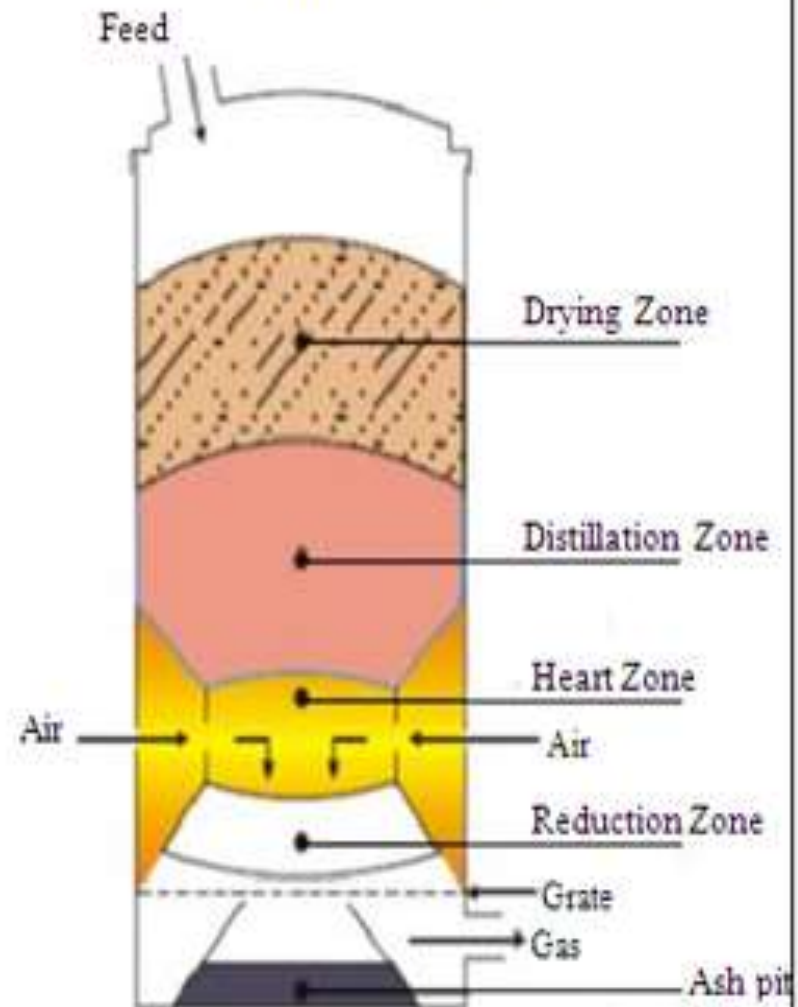

Downdraft gasifiers give relatively cleaner gas (low tar content) and are preferred for engine applications, niche applications demanding clean gas.

Cross-draft gasifiers

- Cross-draft gasifiers exhibit many operating characteristics of the down draft units.
- Air or air/steam mixtures are introduced in the side of the gasifier near the bottom while the product gas is drawn off on the opposite side.
- Normally an inlet nozzle is used to bring the air into the center of the combustion zone .
- The velocity of the air as it enters the combustion zone is considerably higher in this design, which creates a hot combustion zone.
- The combustion (oxidation) and reduction zones are both concentrated to a small volume around the sides of the unit.
- Cross-draft gasifiers respond rapidly to load changes.
- They are normally simpler to construct and more suitable for running engines than the other types of fixed bed gasifiers.
- However, they are sensitive to changes in biomass composition and moisture content.

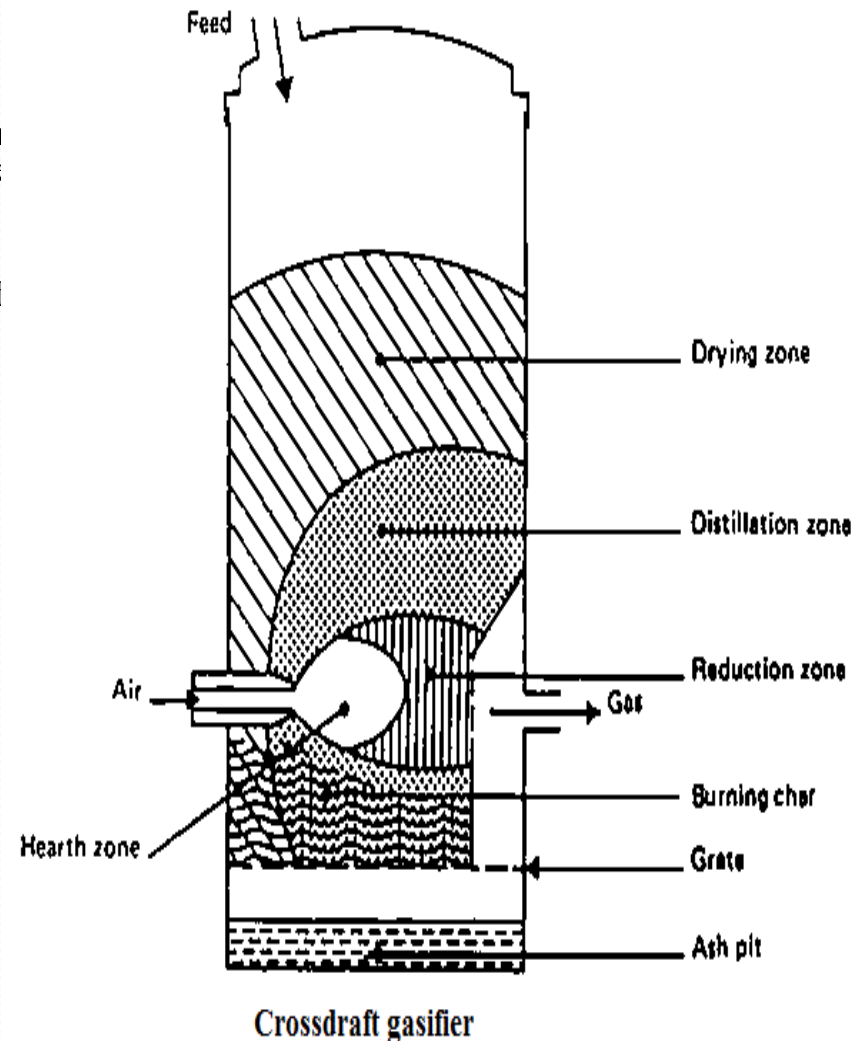

Fluidized bed gasifier

- Fluidized bed (FB) gasification has been used extensively for coal gasification from many years, its **advantage over fixed bed gasifiers being the uniform temperature distribution achieved in the gasification zone.**
- In this type of gasifier, air is blown through a bed of solid particles at a sufficient velocity to keep these in a state of suspension.
- The bed is externally heated and the feedstock is introduced as soon as a sufficiently high temperature is reached.
- The fuel particles are introduced at the bottom of the reactor, very quickly mixed with the bed material and almost instantaneously heated up to the bed temperature.
- As a result of this treatment relatively large amount of gaseous materials produced. Further gasification and tar-conversion reactions occur in the gas phase.
- Ash particles are also carried over the top of the reactor .

FLUIDIZED BED GASIFIER

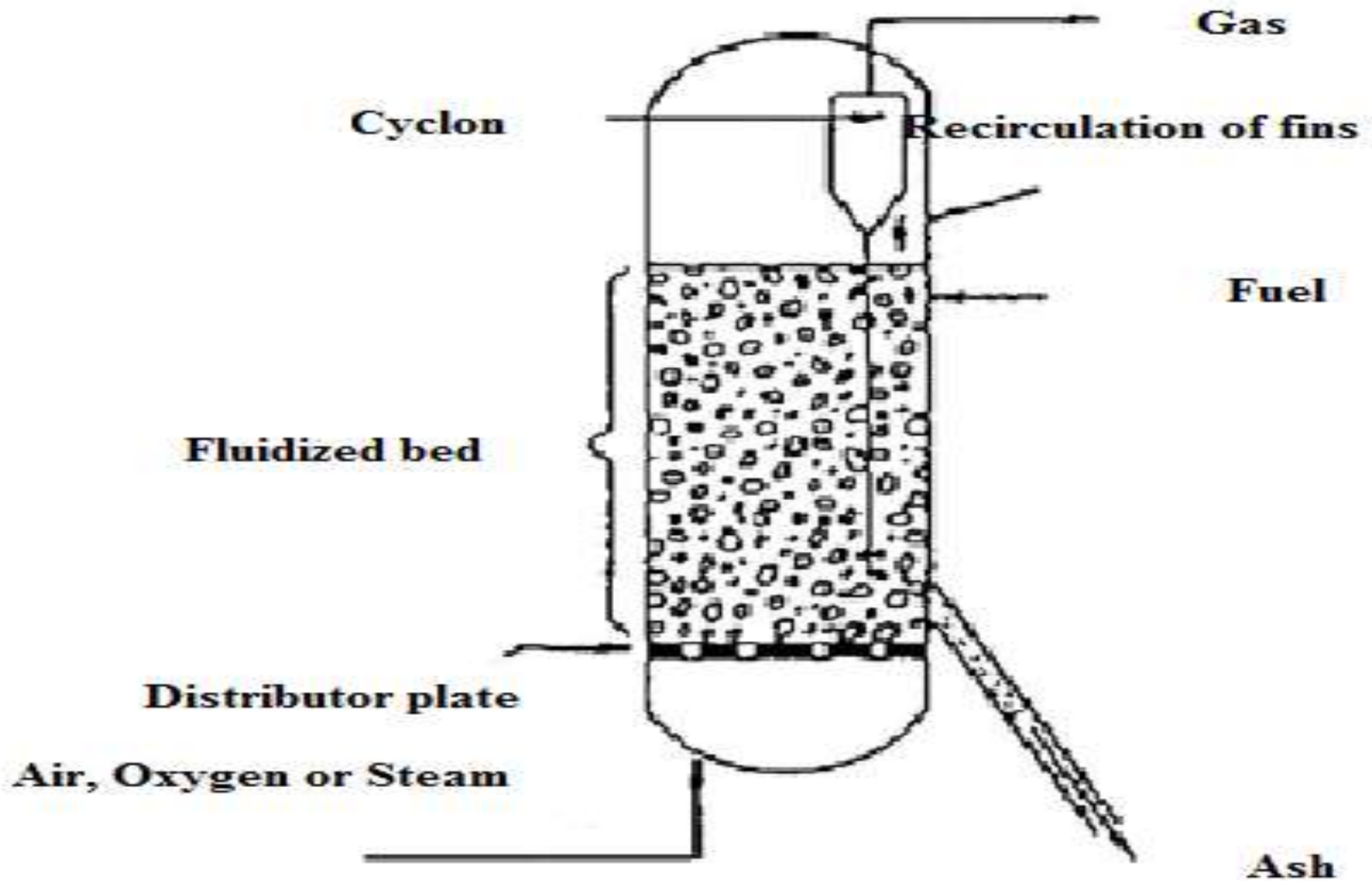

ADVANTAGES OF GASIFICATION

- Provides Sustainable & Affordable alternative to fossil fuel based power plants at low power levels. This technology can assure 'Continuous power supply' even at 'Peak load conditions'.
- Efficiency of the system is very high when compared to other Renewable energy systems such as Wind and Solar.
- Gasification is Eco-Friendly as it is "CO₂ Neutral", generates very little SO₂ & Nitrogen Oxides compared to conventional fossil fuel based power plants.
- It is a cost effective solution as it combines 'Low Unit Capital Cost' with 'Low Unit Cost of Production'. Cost of installation per kWe is about the same as for large power levels.
- Economic, Social and Environmental benefits associated with Biomass make it as an attractive renewable energy option.

DISADVANTAGES OF GASIFICATION

- Gasification is a complex and sensitive process.
- Gasifiers require at least half an hour or more to start the process.
- Getting the producer gas is not difficult, but obtaining it in the proper state is the challenging task. The physical and chemical properties of producer gas such as energy content, gas composition and impurities vary time to time.
- Some amount of tar is released in the gas.
- All the gasifiers have fairly strict requirements for fuel size, moisture and ash content. Inadequate fuel preparation is an important cause of technical problems with gasifiers.

PYROLYSIS

- Pyrolysis is the process which converts biomass directly into solid (charcoal), liquid (bio oil), and gaseous (fuel gas) products by thermal decomposition of biomass in the absence of oxygen.
- The relative amounts of the three co-products depend on the operating temperature and the residence time used in the process.
- Pyrolytic oil may be used directly as a liquid fuel for boiler, diesel engine, gas turbine for heat and electricity generation, or catalytically upgraded to transport grade fuels.
- In all thermo-chemical conversion processes, pyrolysis plays a key role in the reaction kinetics .

PYROLYSIS

Biomass Liquefaction via Pyrolysis

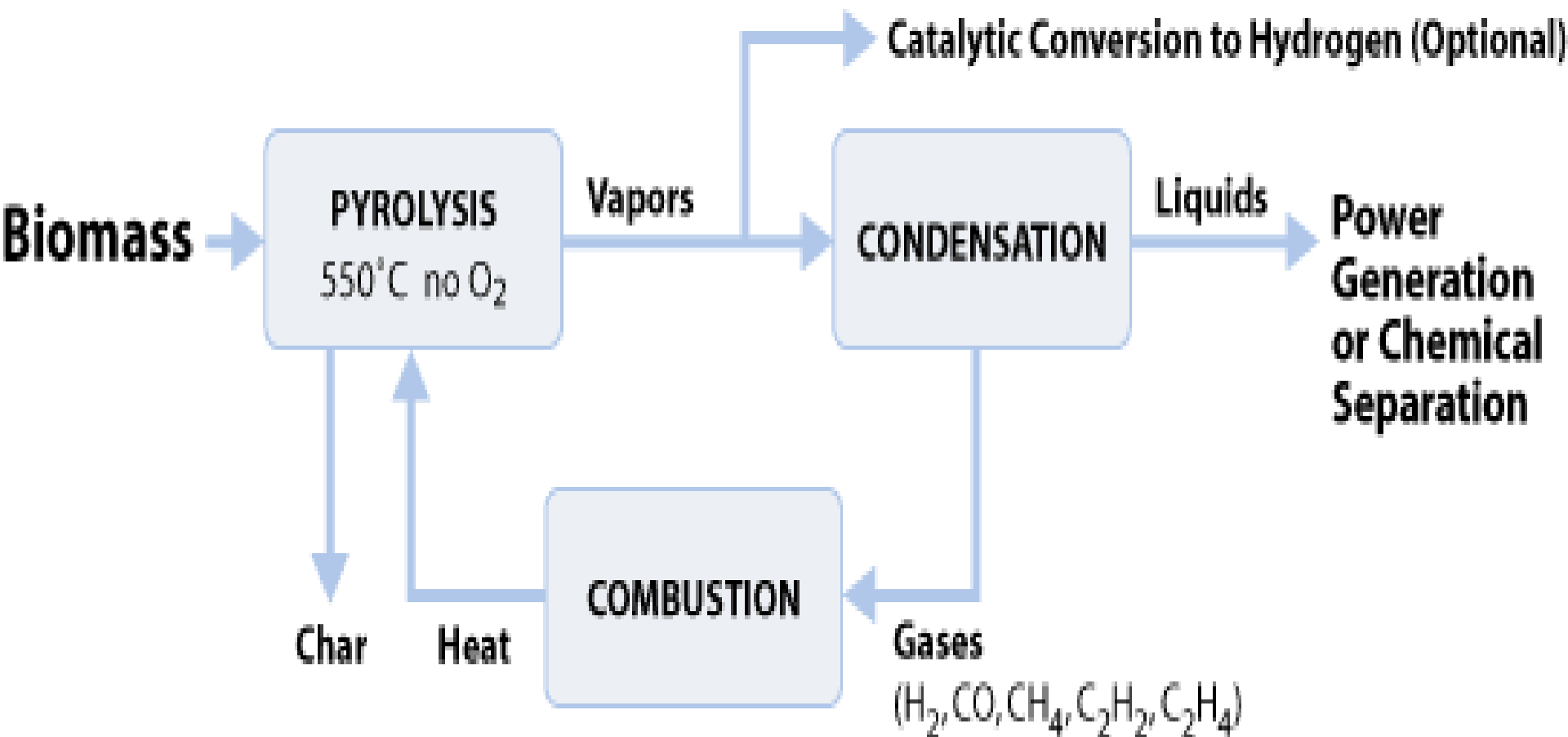

Conclusion

- Biomass conversion technology has huge potential to fulfill the rural energy requirement.
- Available of 365 day in a year, better other renewable energy sources like solar, wind, small hydro power, etc. that depends on climatic conditions.
- It has good agricultural applications such as electricity and steam generation in the sugar cane industry.
- Resolve the high cost generation and transmission of power in remote/rural areas in the country.
- Offer sustainable energy solution.

