

Research in Sputtered Amorphous Silicon Thin Film Solar Cells



Carleton
UNIVERSITY

Canada's Capital University

Presented By:

Martin Friedl
Jeremy Miller
Michael Sawires

- “Total installed [photovoltaic] capacity in the world now amounts to around 40 GW, producing some 50 terawatt-hours (TWh) of electrical power every year.” – EPIA, May 2011

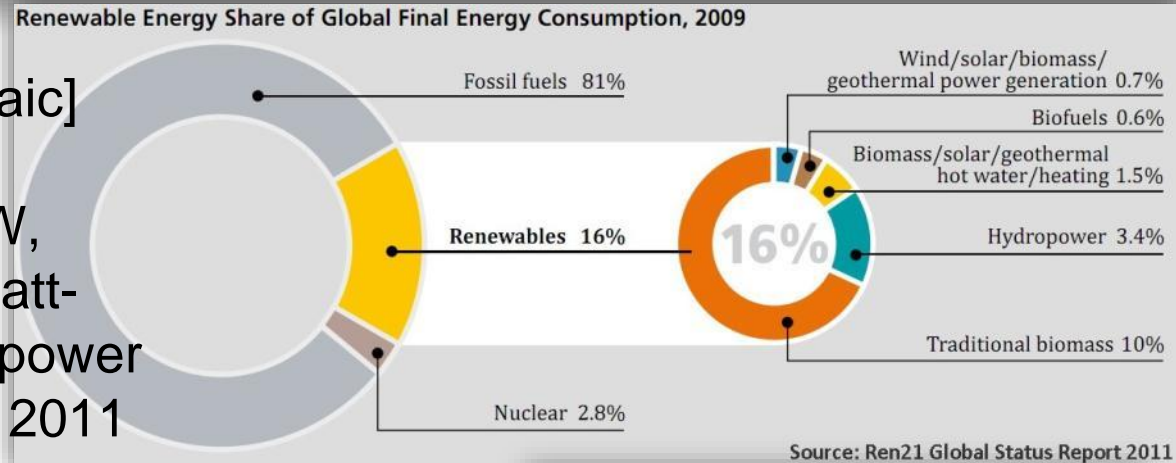

- Only about 0.2% of the total global generated electricity in 2010 comes from PV sources
- Solar will become increasingly important in the future as we begin to rely less on fossil fuels and turn to renewable energy sources for our power needs



Why Silicon?

- Non-toxic
- Abundant
- Relatively cheap
- Mature infrastructure from computer industry



c-Si Cell

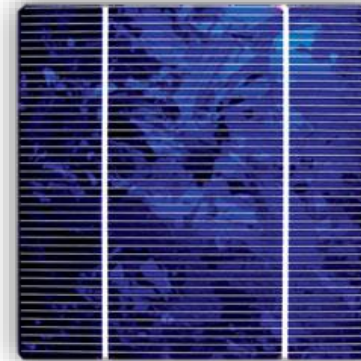

p-Si Cell



a-Si Cell

Solar Cell Technology	Max Lab Efficiency	Typical Cell Thickness	Si Use	Cost
Mono-crystalline Silicon (c-Si)	27.6%	~200 μ m	High	\$\$\$
Poly-crystalline Silicon (p-Si)	20.4%	~200 μ m	Moderate	\$\$
Amorphous Silicon Thin Film (a-Si)	12.5%	<1 μ m	Low	\$

Advantages of c-Si

- Up to 27.6% lab efficiencies
- Little degradation over time

Disadvantages of c-Si

- High temperature and energy intensive manufacturing process
- Use a relatively large amount of Si
- Expensive
- Fragile
- Low band-gap ($1.17 \text{ eV} \approx 1060\text{nm}$)

c-Si Ingot made using
Czochralski process:

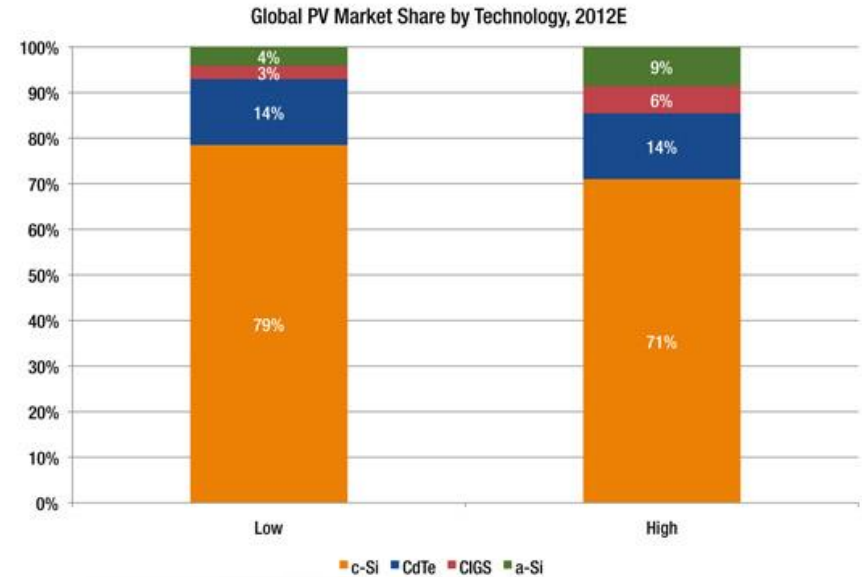
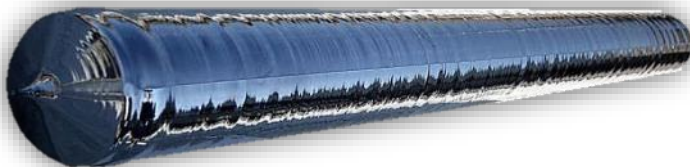

c-Si Cell

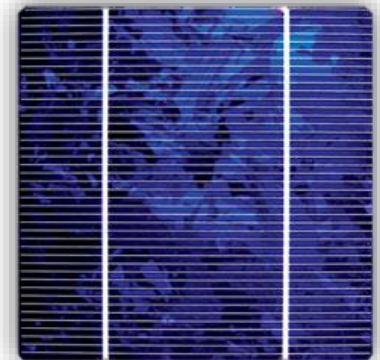

p-Si Cell



Advantages of a-Si TF

- Saves raw material
- Can be deposited on flexible substrates
- Higher photon absorbance than c-Si
- More desirable band-gap
- Potential roll to roll manufacturing would make it very cheap to produce

Disadvantages of a-Si TF

- Less efficient than c-Si
- Currently lower % efficiency per \$ cost than c-Si
- Degrades over time



a-Si Cell

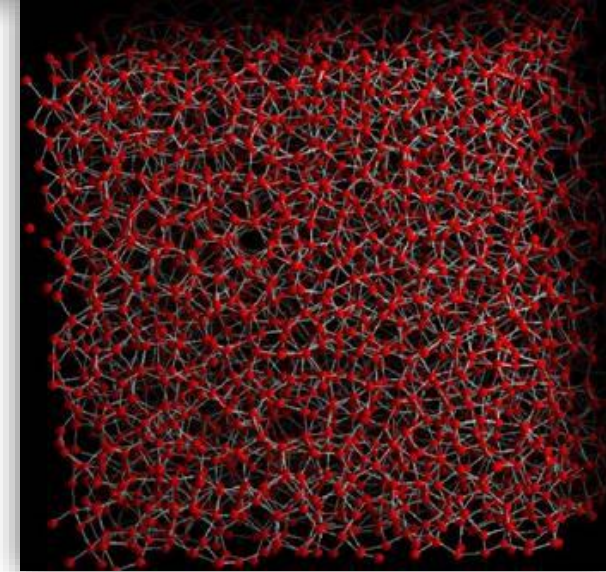

a-Si Atomic Model

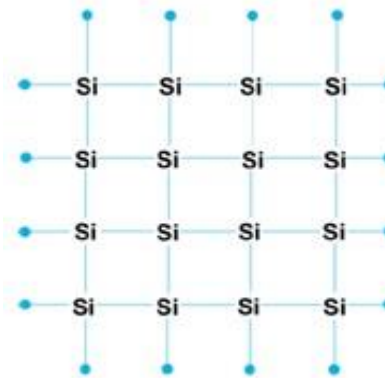

c-Si Structure

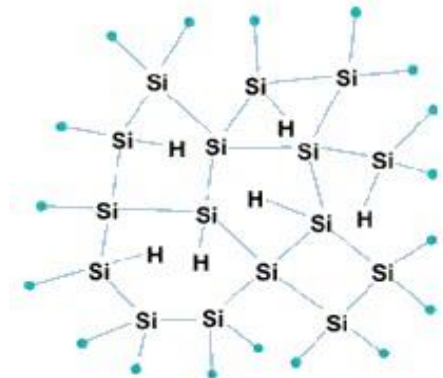

a-Si Structure



Bandgaps Plotted On Solar Spectrum

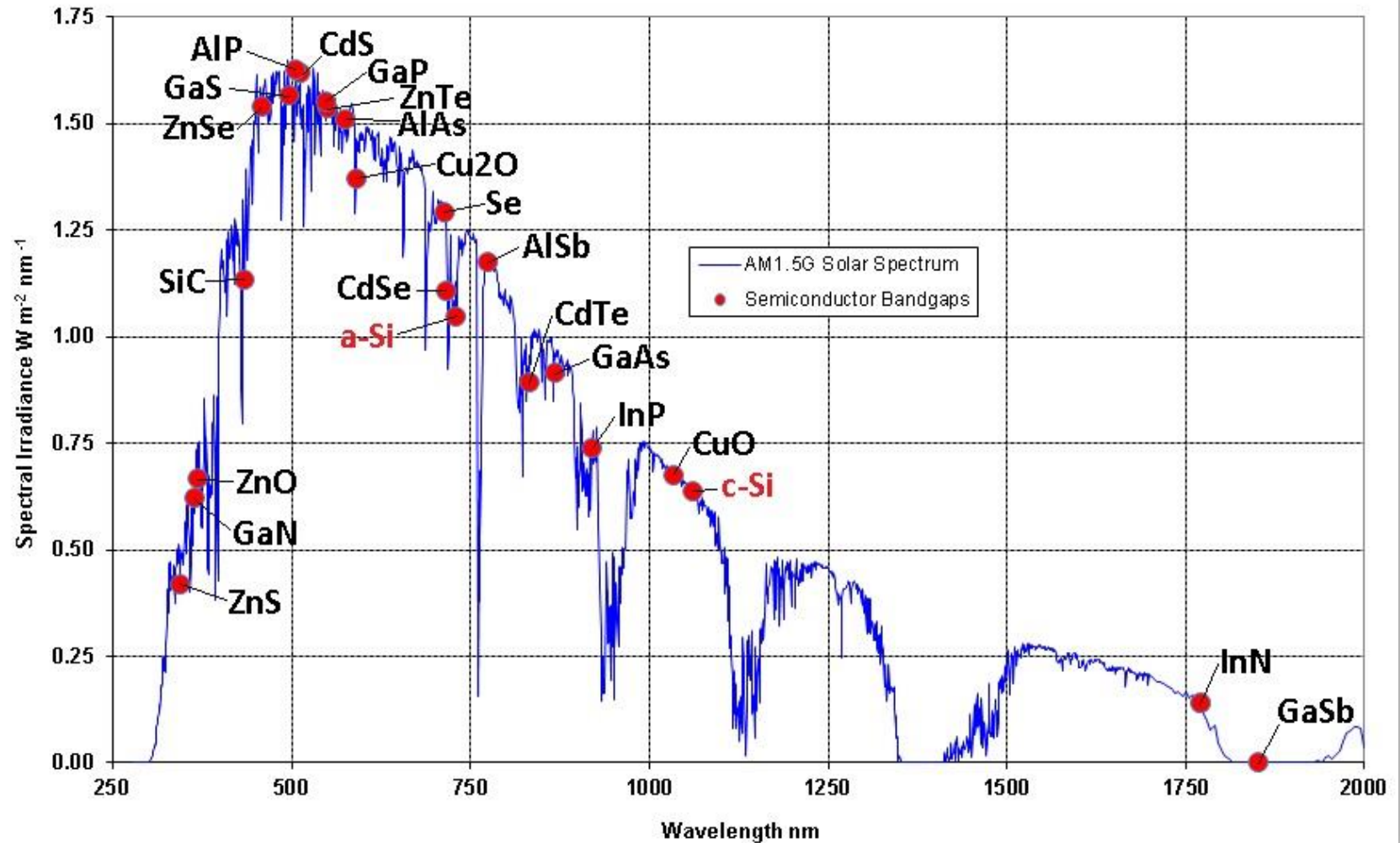

Principles of Operation



Carleton
UNIVERSITY

Canada's Capital University

- PN Junctions
- PIN Junctions
- Schottky Junctions



- Made by bringing a p and an n layer together
- Electrons move to p, holes to n
- Electric field builds up

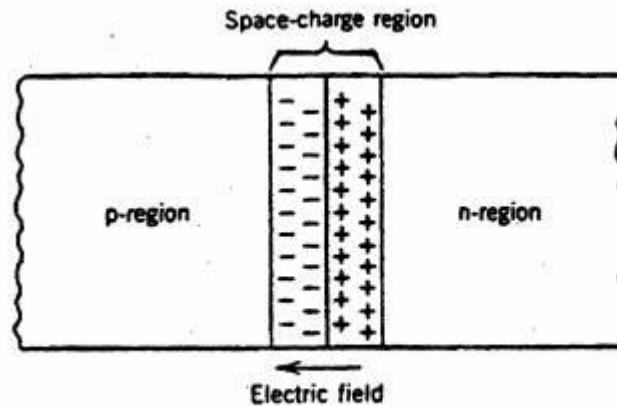

Schematic diagram of a p-n junction under thermal equilibrium.

Band diagrams:

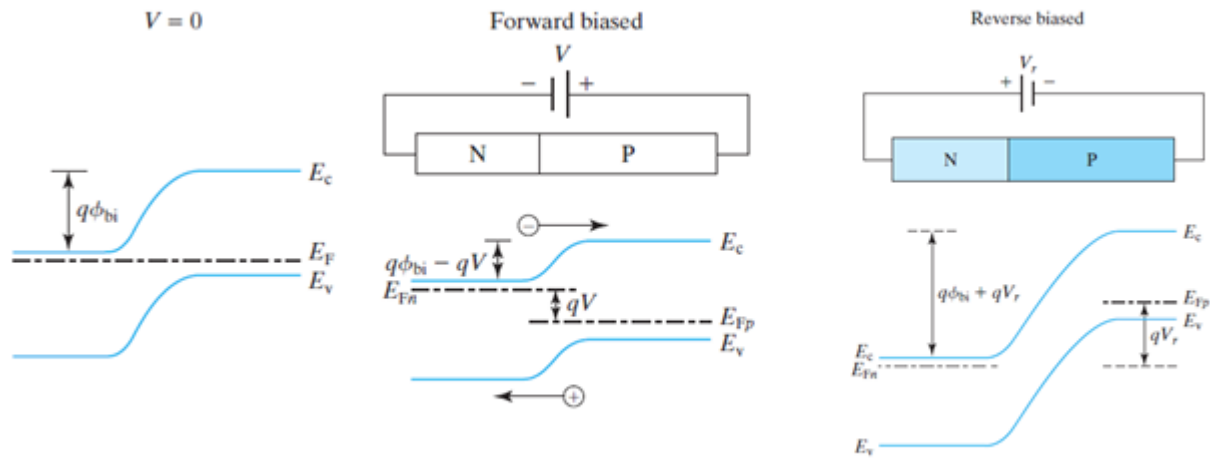

- Use as a photodetector vs. solarcell



- Intrinsic region provides more carriers

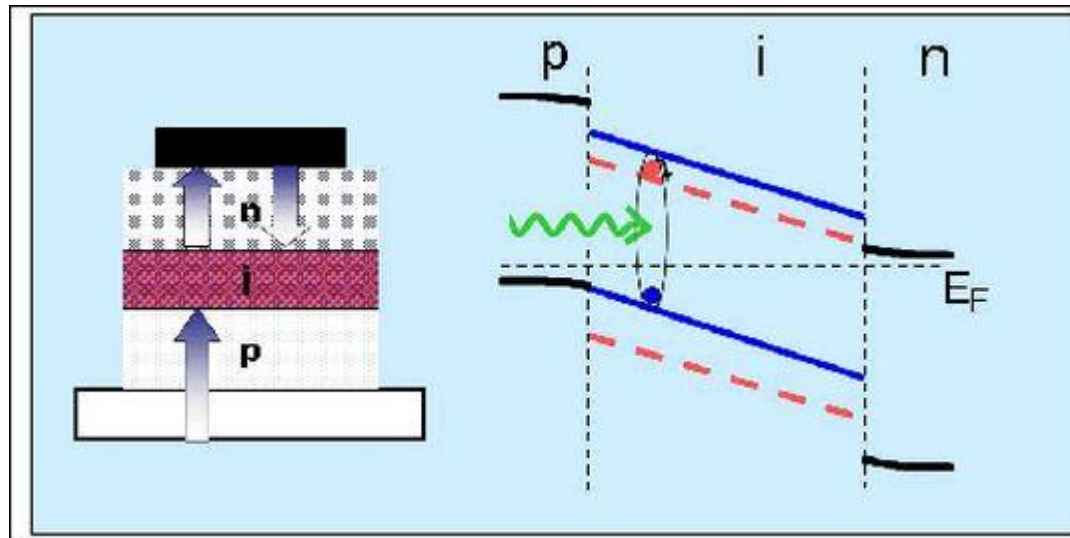

Advantages:

- Thicker depletion region, absorb more penetrating wavelengths
- As a diode, less capacitance, can be used in HF applications

Disadvantage:

- Not practical in LF applications
- Power consuming due to reverse recovering time

Metal-Semiconductor junction

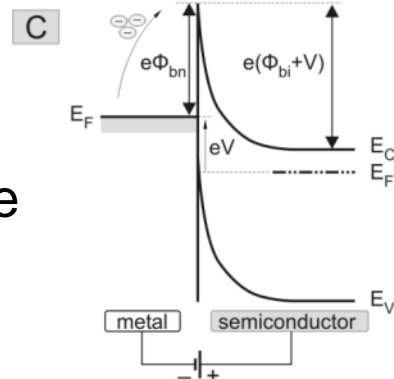
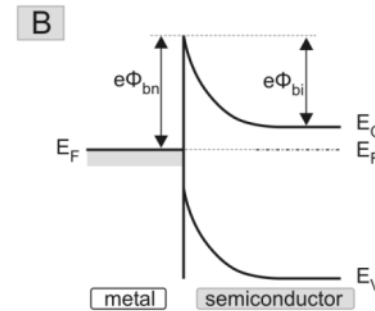
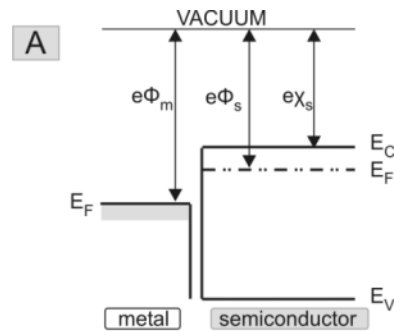

Reverse
Bias

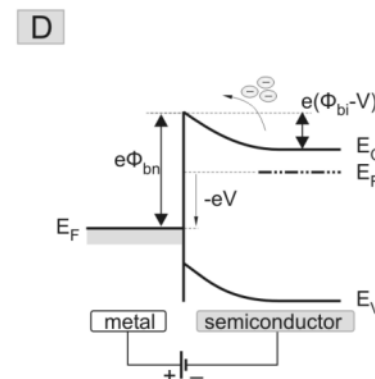

Forward
Bias

Advantages:

- Low forward voltage, responds to less intensity of light
- Smaller dielectric (ϵ) due to metal, lower capacitance, HF applications

Disadvantages:

- Thin barrier makes it easy for charges to leak
- Low reverse breakdown voltage, high reverse current.



Fill Factor:

$$FF = \frac{P_{actual}}{P_{theoretical}} = \frac{V_{MP}I_{MP}}{V_{OC}I_{SC}}$$

Efficiency:

$$\eta = \frac{V_{OC}I_{SC}FF}{P_{in}}$$

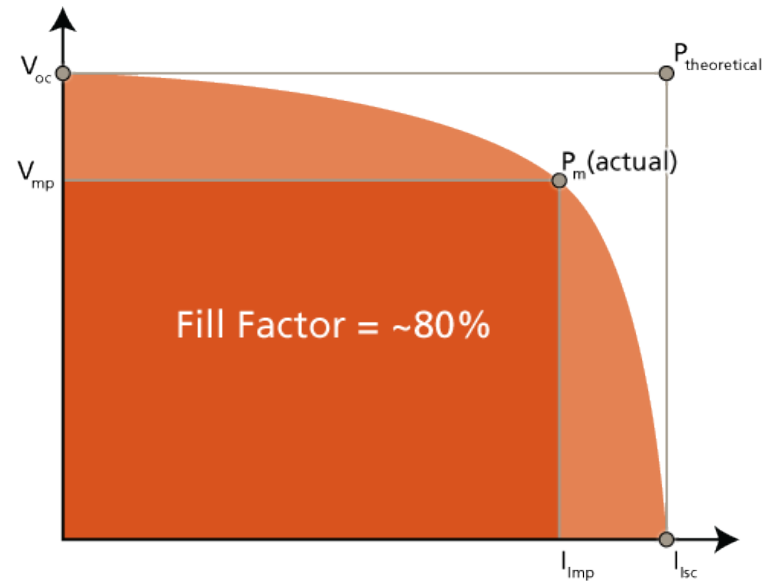

Cell Design



Carleton
UNIVERSITY

Canada's Capital University

- Schottky Solar Cell
- P-I-N Solar Cell

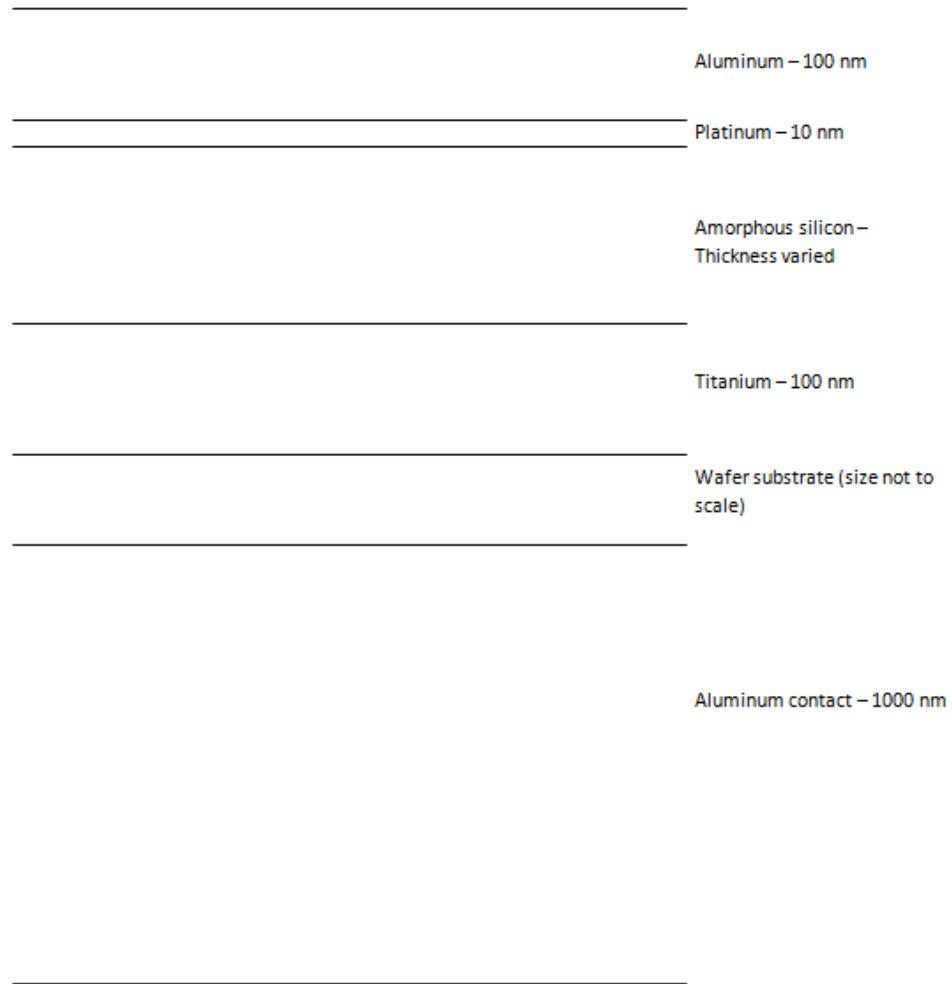

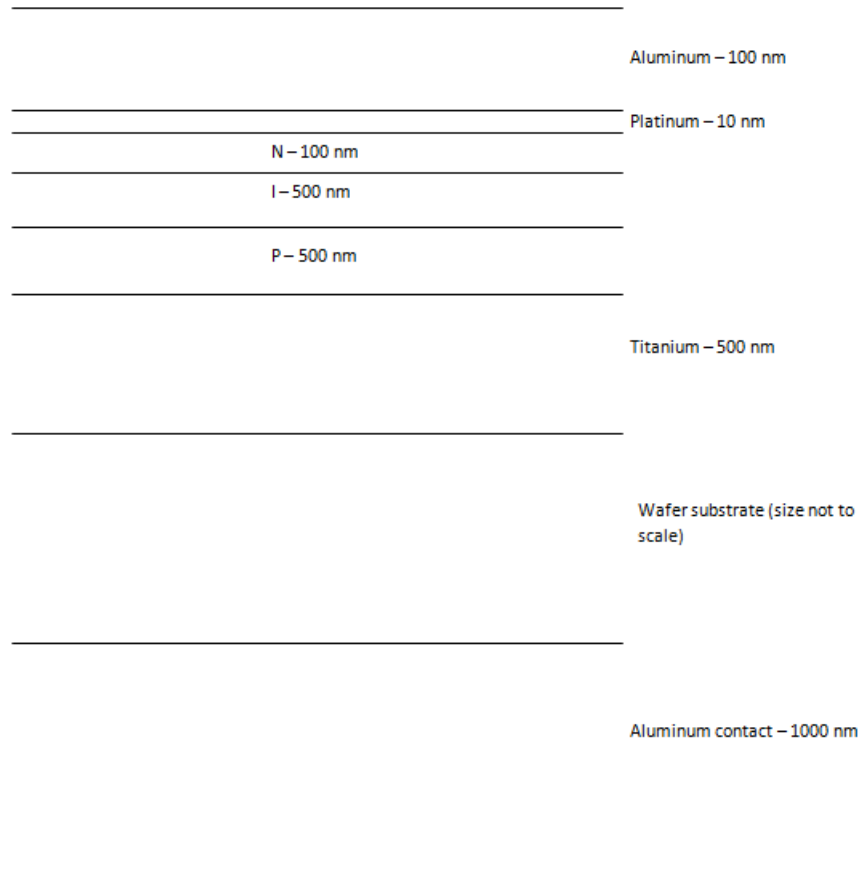

Manufacturing Our Cells



Carleton
UNIVERSITY

Canada's Capital University

- Lab Machines and Processes Used
- Steps in manufacturing

Balzer Oven (Electron Beam Physical Vapor Deposition)

A form of Physical Vapor Deposition (PVD), uses e-beam to vaporize metal and deposit it on a sample

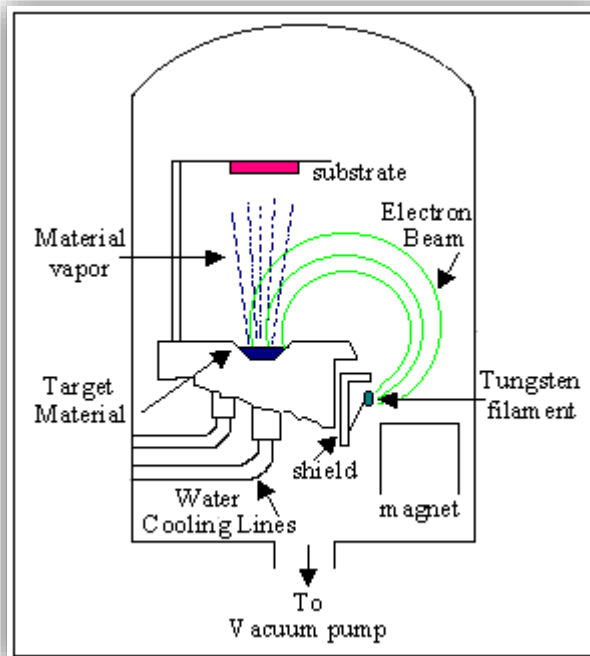

Sample Goes Here

Metal Filled Crucible



How It Works

- Operates under high vacuum, $\sim 10^{-6}$ Torr
- Heats target metal with electron beam
- Heated metal melts and vaporizes
- Metal gets deposited on wafers above

Varian Sputtering Chamber

A form of Physical Vapor Deposition (PVD), uses RF plasma sputtering to deposit Si onto sample

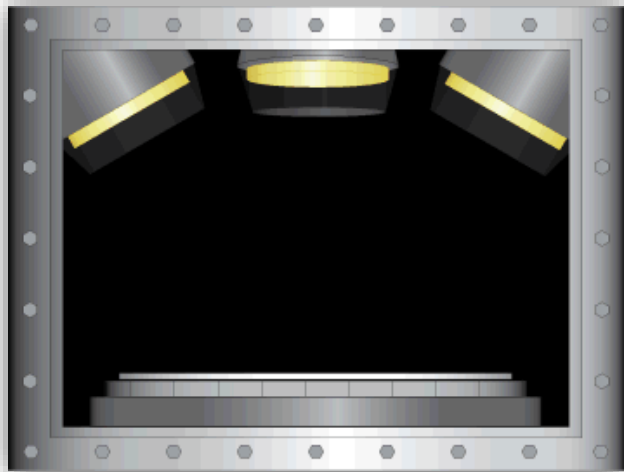

RF Guns +
Si Targets

Sample +
Shutter

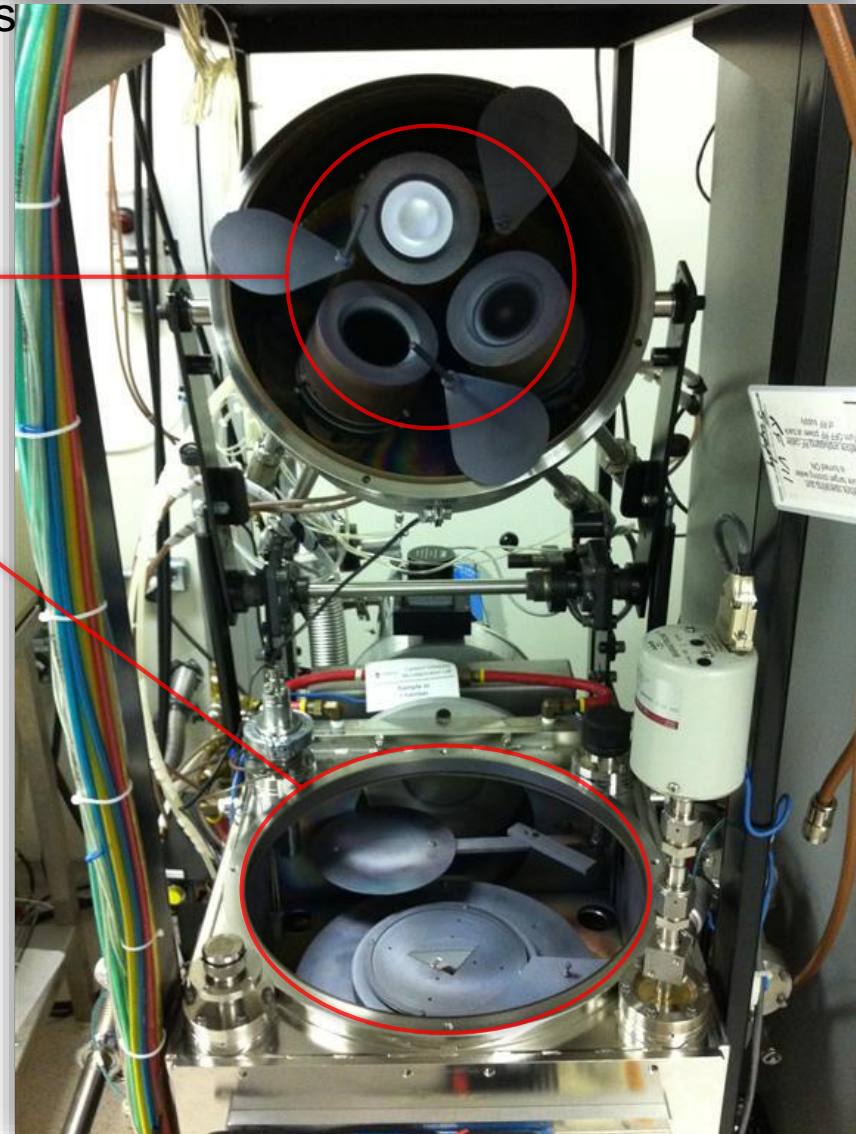

How It Works

- Begins under high vacuum, $\sim 10^{-6}$ Torr
- 25%H/75%Ar gas pumped in brings pressure up to 5 millitorr (mT)
- RF gun creates electric field
- Causes Ar^+ ions to strike Si target
- Si atoms ejected from target, get deposited on sample below

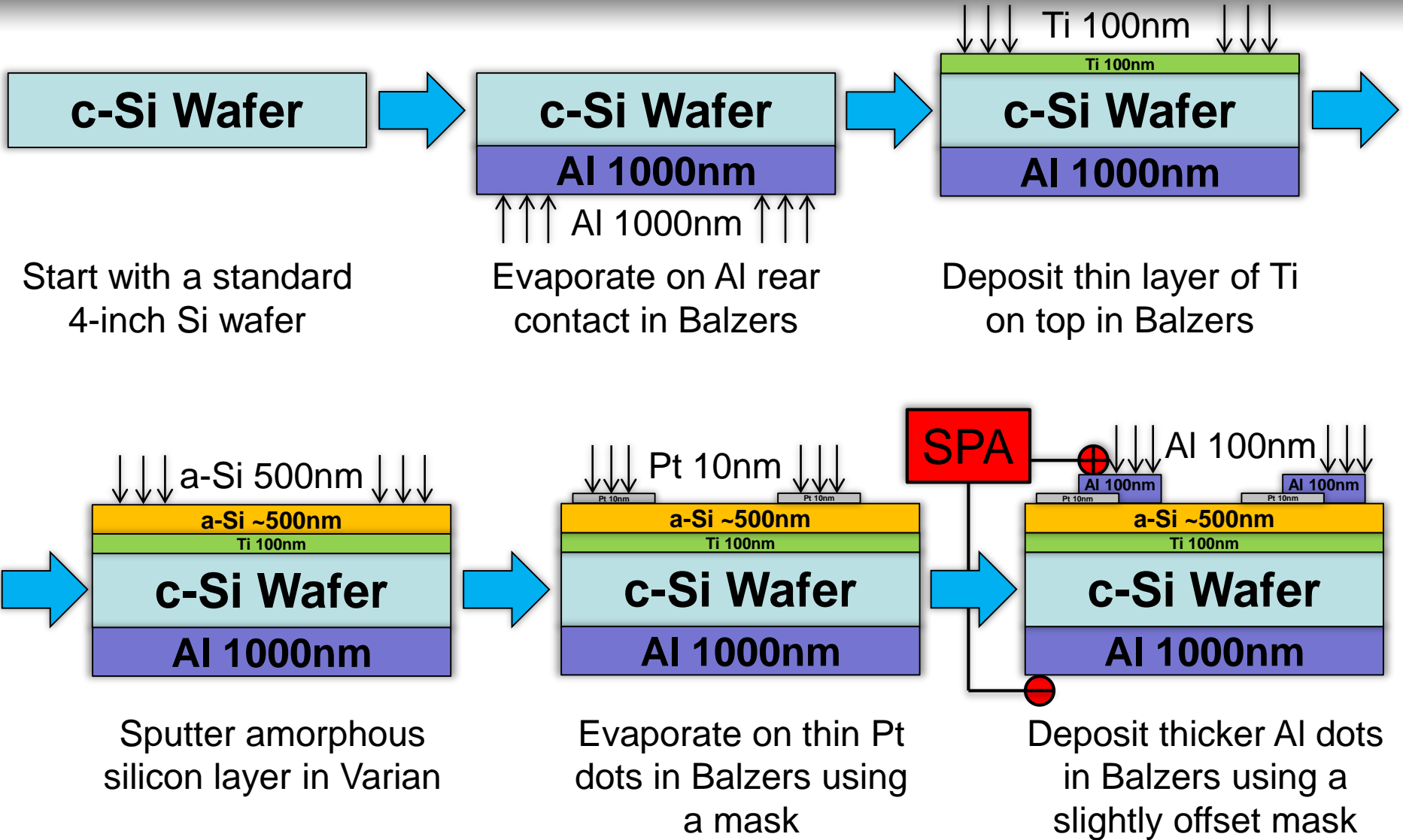

NOTE: Wafer thicknesses NOT to scale

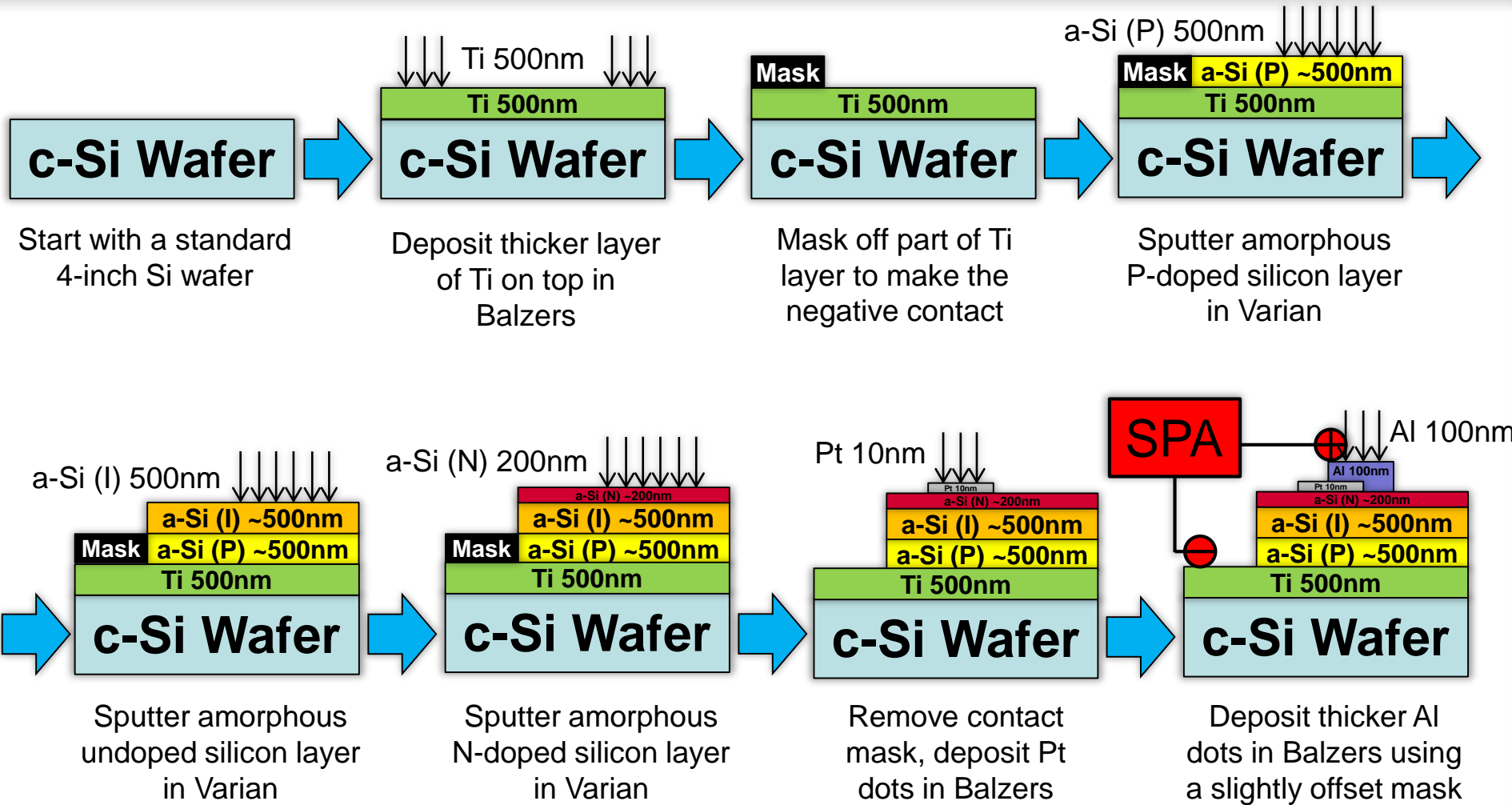



A Few More Pictures of the Varian



Varian +
Controls
←

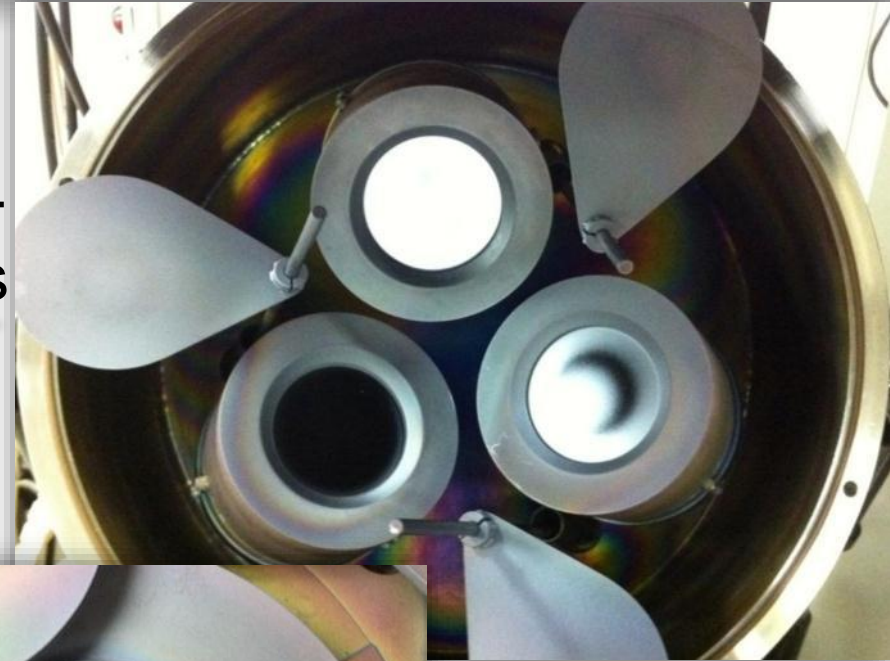

↑ Si Targets

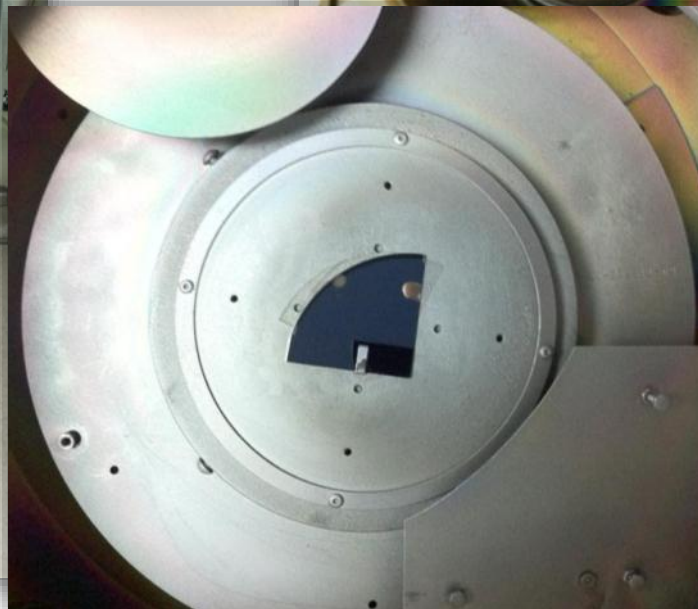

← Loaded Wafer

Testing and Results



Carleton
UNIVERSITY

Canada's Capital University

- Testing Methods
- Cell Fill Factor
- Cell Efficiencies



Probe station and microscope light

- Tested 20 center contacts
- Back contact to the chuck
- Data recorded with HP 4155
- Made use of Matlab script to analyze data

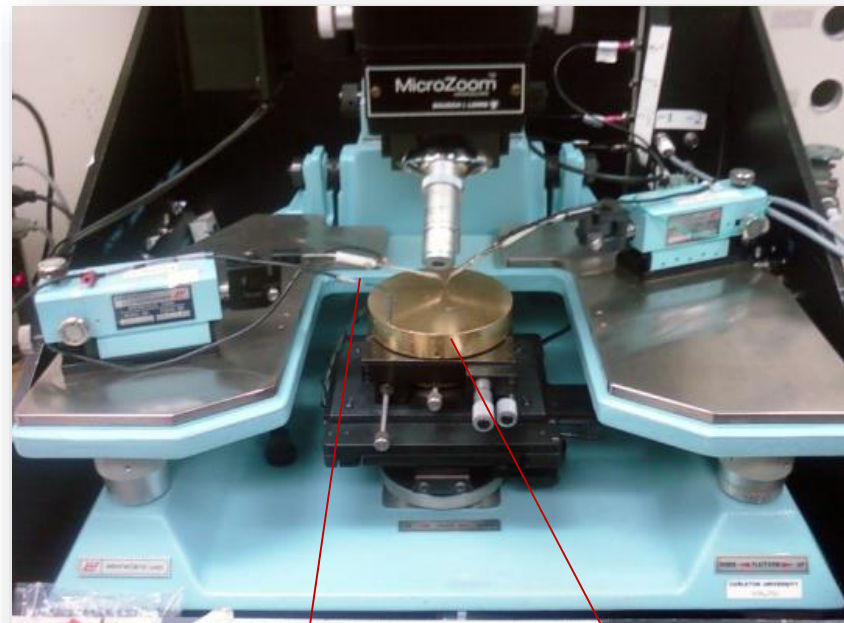
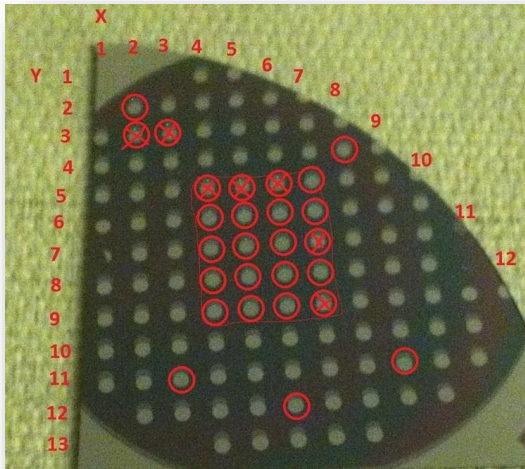

Probe (+) Chuck (-)



Testing for thicknesses:

- SEM images of cross sections of cells
 - Schottcky Barrier
 - PIN

Schottky

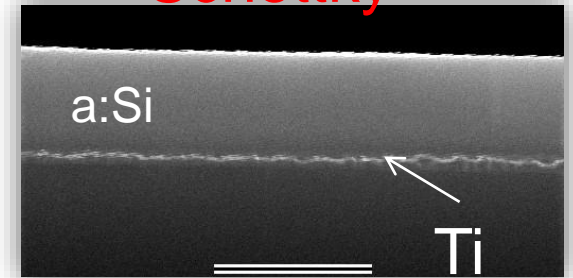

Schottky

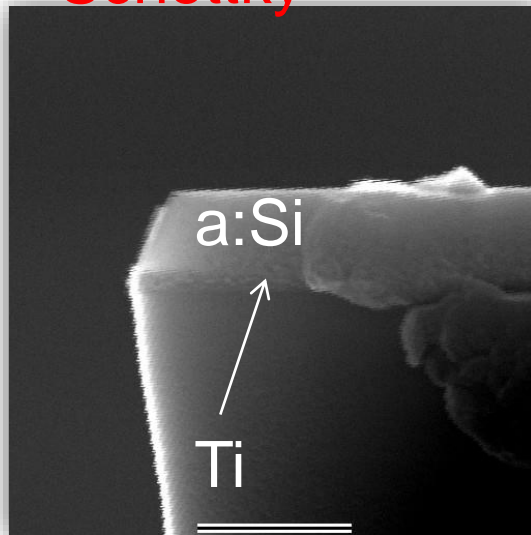

PIN

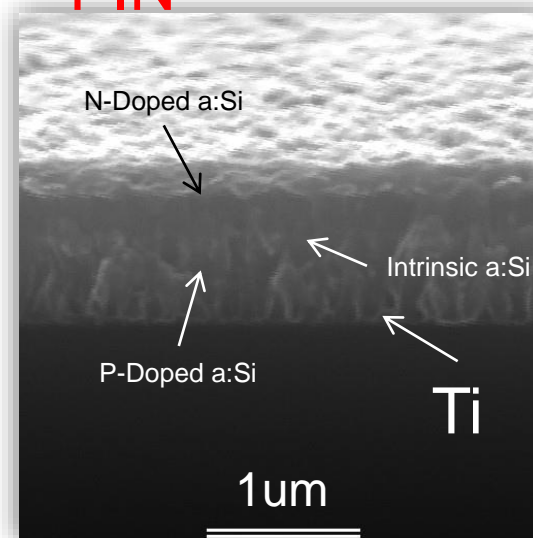

Testing Challenges

- The parameters of the light source at Carleton were unknown
 - Verified testing results at OttawaU
 - AM1.5G Conditions
 - Carleton curve multiplied by factor of 25.

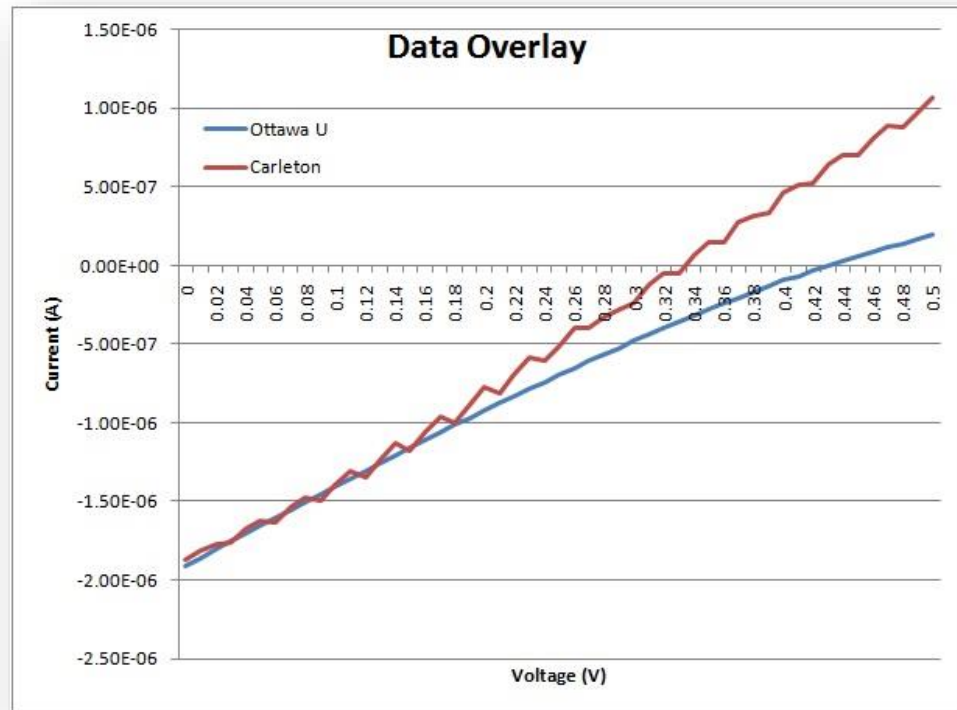

Results the of some of the best Schottky solar cells:

- Cell: R-21(6,7), thickness of $\sim 500\text{nm}$
- 25% H/Ar, 325°C
- Fill Factor: 0.23
- Efficiency: 0.002% (1cm^2)
- $\sim 5\text{m}^2$ to charge iPod (in California)

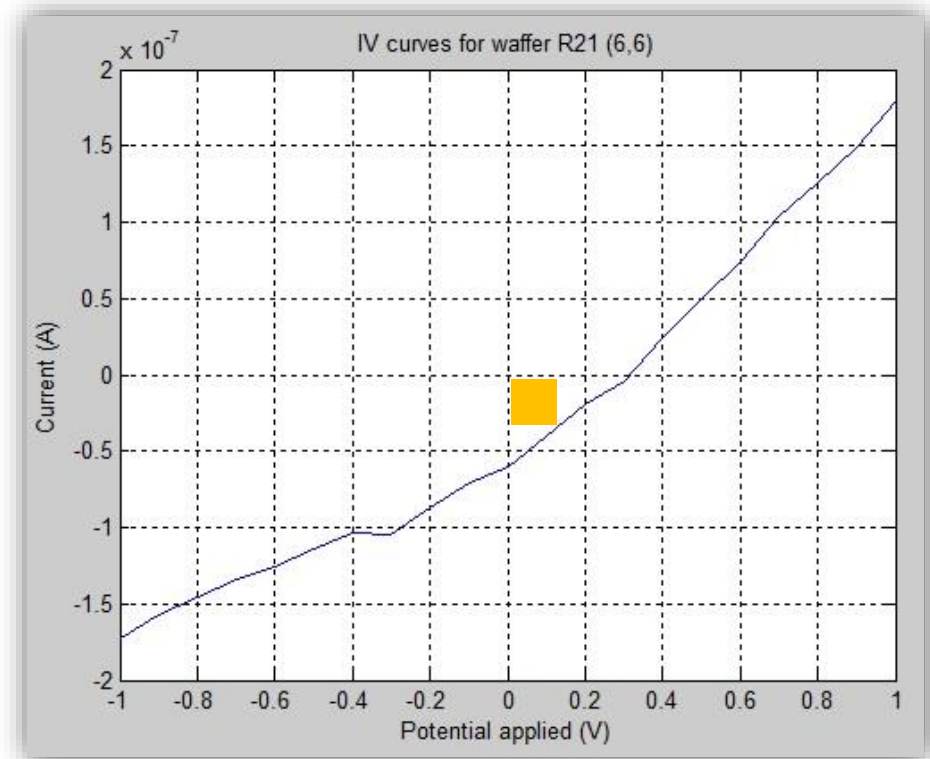
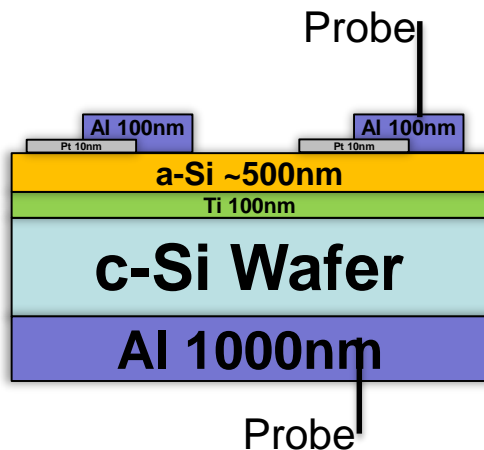

Explanations for Poor results

- Current travels through thick substrate $\sim 0.5\text{mm}$
- Multiple unintended Schottky Barriers

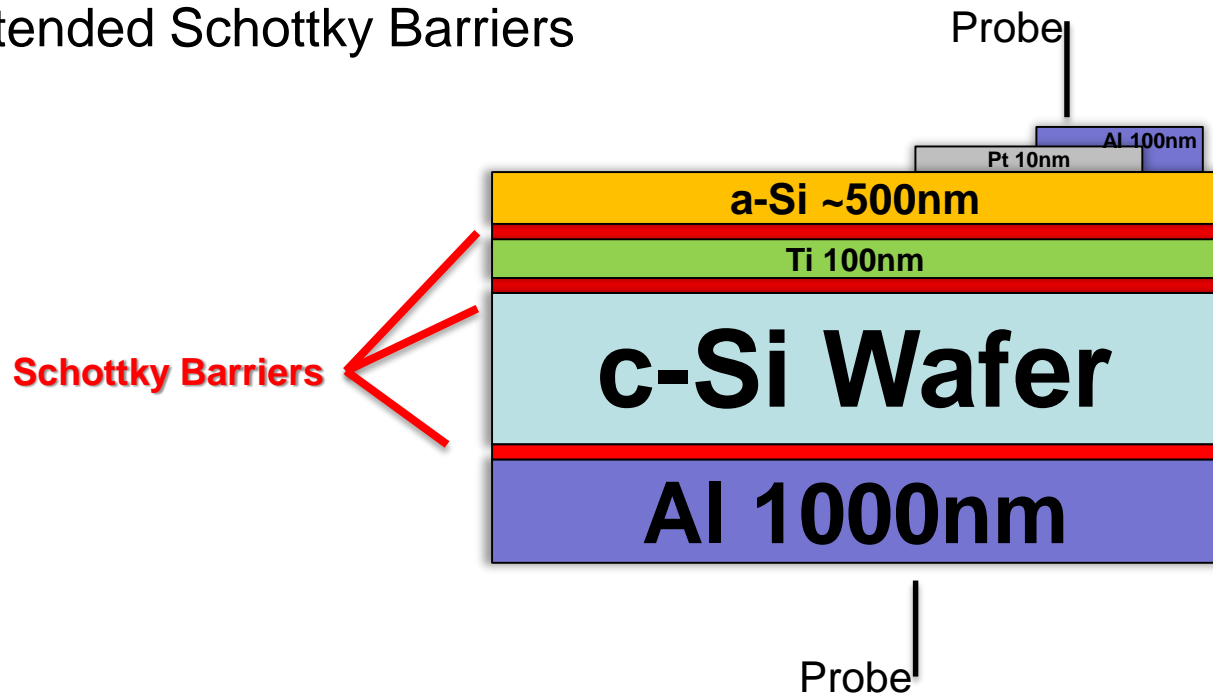



Etching of a:Si layer

- Allow probe to make direct contact onto the Ti layer
- Current no longer has to go through substrate
- Avoids multiple Schottky Barriers

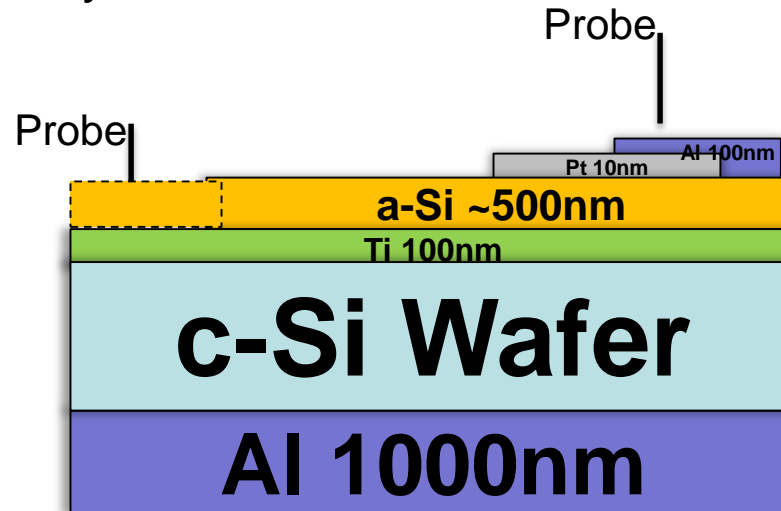

Etching Results:

- Cells behave like resistors
- Mostly likely due to proximity of probes

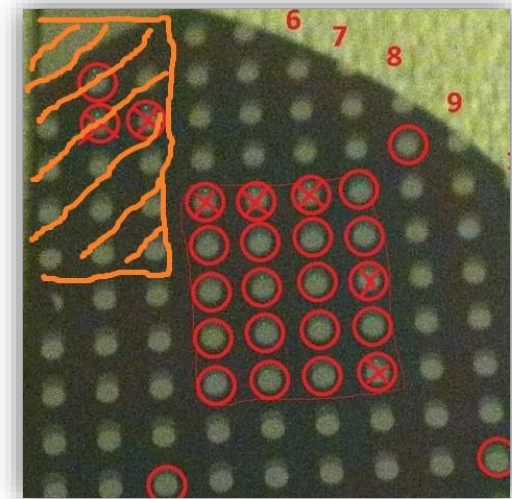
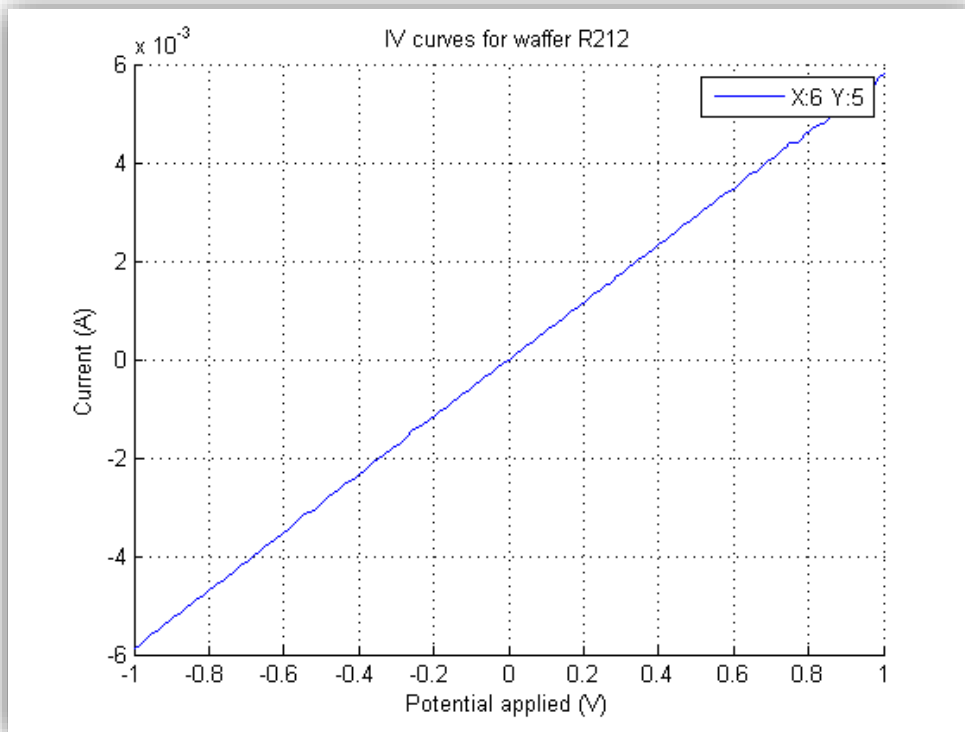

Best results for PIN Cell:

- Wafer, S-2, (4,5)
- Thickness ~ 260nm
- Estimated Fill Factor of 0.37
- Further testing required due to noise on result
- Results vary depending on probe proximity

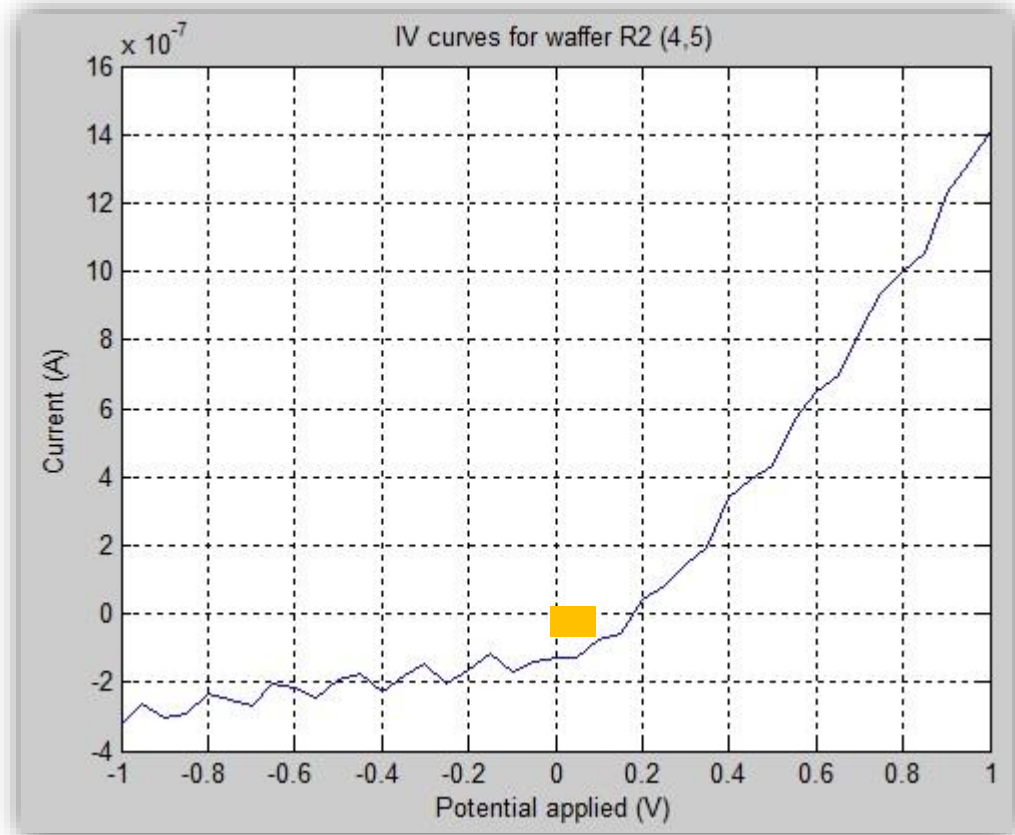
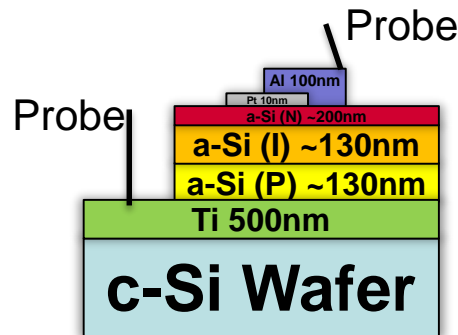



Summary:

- a:Si thin film remains a cheap & non-toxic way to produce solar cells
- More desirable than c:Si
- Potentially cheaper to manufacture than most other cell types

What we'd like to achieve:

- Further Testing in a:Si PIN cells
 - Efficiency values
 - Consistent contact design

Other Research This Summer



Carleton
UNIVERSITY

Canada's Capital University

- ELEC 4703 – New Solar Cell Course (Winter 2012)
- Building New Photonics Testing Stage



Commercial Solar Cells

Different solar cells to be tested by students for efficiency comparison



Amorphous

Monocrystalline

Polycrystalline



Xenon

GaN

Halogen

Vacuum Chuck + Peltier Cooler + Heat Sink

Peltier Cooler

- Takes excess heat energy from vacuum chuck, transfers it to heat sink
- Runs on 12V DC switched by MOSFET

Arduino Control

- Microcontroller measures temperature of chuck and heat sync
- Pulse width modulates MOSEFT to regulate chuck temperature to user setting

PID Algorithm

- Proportional Integral Derivative (PID)
- “Learns” how chuck temperature responds to changes in duty cycle of MOSFET
- Calculates duty cycle of MOSFET to keep temperature to within 1 degree of set temp

Arduino Running PID Code

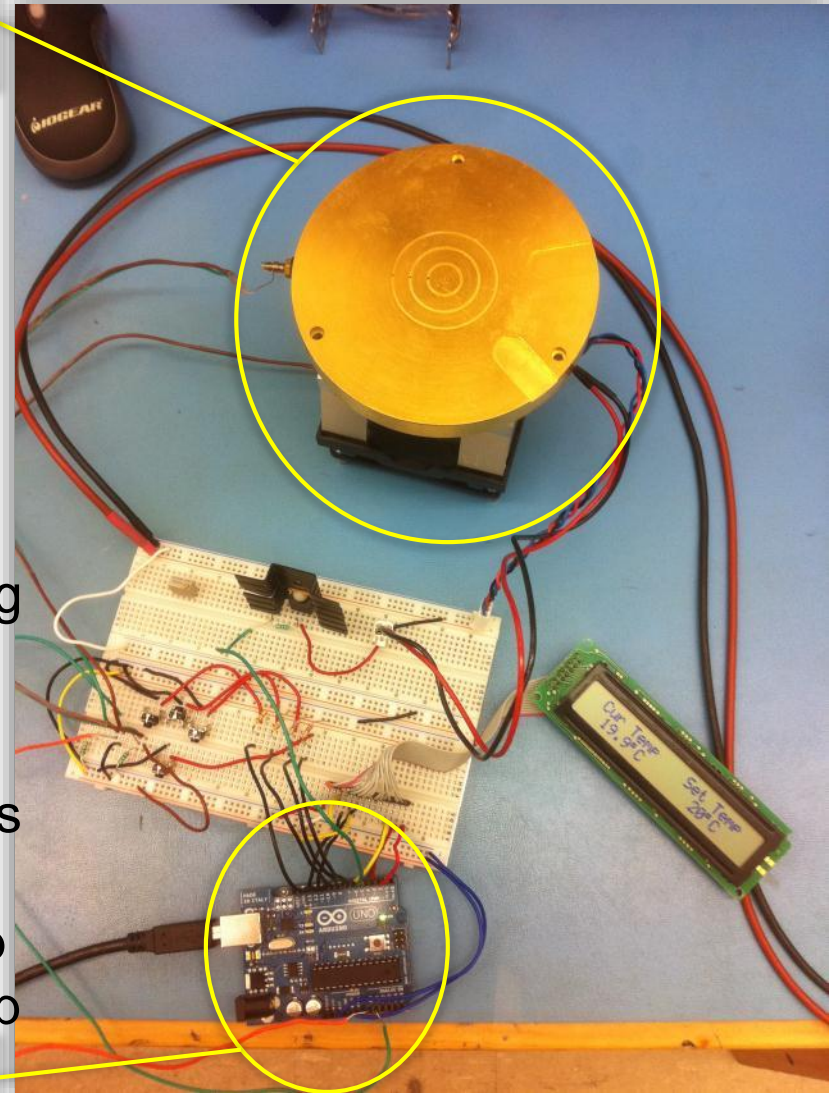

- Used to test optical devices produced in the microfab lab

Components

- LUNA OBR 4600 used to characterize test devices
- Three NanoMax-341 3-axis stages from Thorlabs for fiber to device coupling
- Computer controlled stepper motors + piezo actuators

Specs

- 4mm of travel per axis
- 5nm piezo resolution
- 2-axis auto alignment on input and output side
- All positioning computer controlled through Agilent Vee

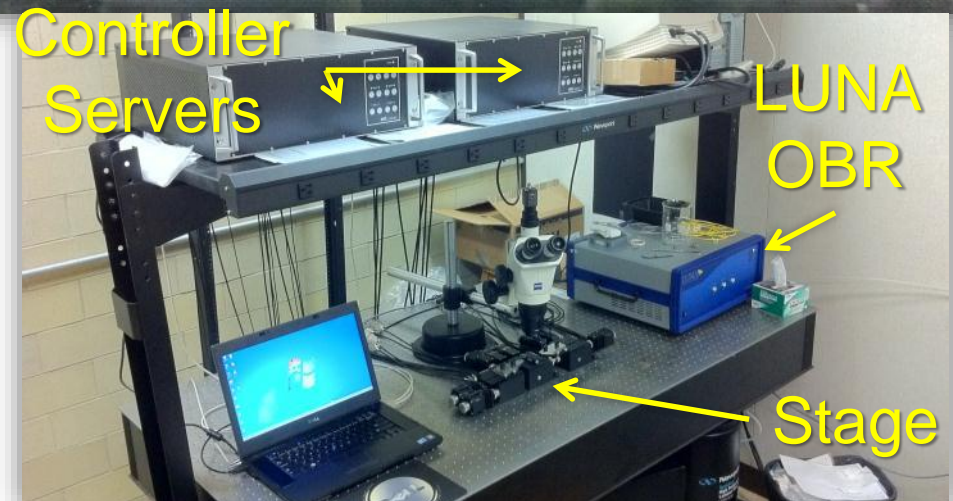
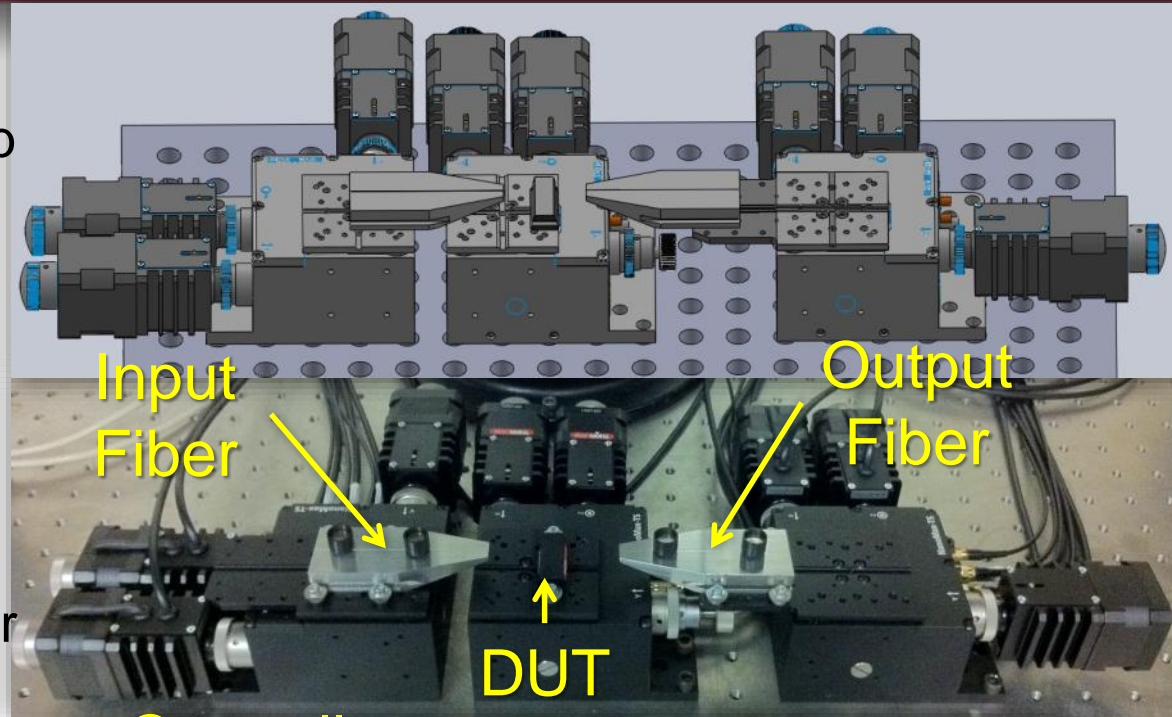

We would like to give special thanks to:

- NSERC
- Dr. Winnie Ye
- Dr. Garry Tarr
- Dr. Karin Hinzer
- Nagui Mikhail
- Rob Vandeusen
- Rick Adams
- Angela Burns
- Dr. Tom Smy
- Blazenka Power
- Andrew Tam
- Ryan Griffin
- Svetlana Demtchenko
- Scott Ferguson
- Scott Bruce



Figure Description	Source Link
c-Si Array	http://exportatv.en.ecplaza.net/110.jpg
c-Si Cell	http://www.hiwtc.com/photo/products/8/00/88/8835.jpg
polySi Cell	http://www.szshxzy.com/my/bookpic/20086312185071841.jpg
c-Si Serpa Power Plant	http://upload.wikimedia.org/wikipedia/commons/6/62/SolarPowerPlantSerpa.jpg
Solar Panels on House	http://www.solar-calculator.org/wp-content/uploads/solar-panels.jpg
Evolution of PV Market Share	http://www.epia.org/publications/photovoltaic-publications-global-market-outlook.html
Thin Film Manufacturing Capacity	http://www.greentechmedia.com/articles/read/the-future-of-thin-film-beyond-the-hype
PV Market Share 2012E	http://www.greentechmedia.com/articles/read/the-future-of-thin-film-beyond-the-hype
Renewable Energy Shares	http://www.ren21.net/Portals/97/documents/GSR/REN21_GSR2011.pdf
Silicon Ingot	http://mxpv.net/upload/2011-6/20116281878817.jpg
Amorphous Silicon Roll	http://www.tjlituo.com/UploadFile%5CNews/img/200912/2009121624917.jpg
Cadmium Telluride Cell	http://gotpowered.com/wp-content/uploads/2011/04/flexible-solar-panel.jpg
CIGS Solar Cell	http://solarcellcentral.com/images/CIGS_Solar_Cell.jpg
Amorphous Bonds	http://accessscience.com/loadBinary.aspx?alD=4936&filename=029300FG0020.gif
Crystalline Bonds	http://accessscience.com/loadBinary.aspx?alD=4936&filename=029300FG0020.gif
Amorphous Silicon Atomic Model	http://physik.kfunigraz.ac.at/~jaf/research/glasses/glasses.html
Sputtering Animation	http://www.ajaint.com/whatis.htm
EBPVD Diagram	http://wwwold.ece.utep.edu/research/webedl/cdte/Fabrication/e-beam.gif