

# 10 Food Packaging Closures and Sealing Systems

## 10.1 CLOSURES FOR GLASS AND PLASTIC CONTAINERS

### 10.1.1 CLOSURE FUNCTIONS

The final, critical aspect of glass and rigid plastic packaging is the closure, which can consist of a cap, lid or cork to seal the jar or bottle (Theobald and Winder, 2006). Although glass, and to a lesser extent plastics, provide an excellent barrier to water vapor, gases and odors, an incorrectly designed or applied closure may compromise the benefits that packaging offers in protecting food products from deterioration and lead to a reduction in shelf life.

Closures are required to perform some or all of the following functions without affecting, or being affected by, the contents of the container:

1. Provide an effective hermetic (air-tight) seal to prevent the passage of solids, liquids or gases into or out of the container.
2. Provide easy opening and (when only part of the contents is used at one time) resealing of the container.
3. Provide evidence of inviolability (i.e., that unlawful access to the contents or their exposure to the atmosphere has not occurred). Roll-on tamper-evident (ROTE) closures (also referred to as roll-on pilfer-proof or ROPP closures), such as the aluminum roll-on closure used on beverage bottles, leave a tell-tale ring around the bottom of the neck of bottles after opening and are designed to deter tampering with the contents by providing visual evidence of tampering.

Many countries are experiencing rapidly aging societies in which a large proportion is likely to have relative difficulties in everyday life as a consequence of reduced strength, loss of dexterity, varying degrees of disability and cognition impairment. One specific area that stimulates a significant amount of controversy is the accessibility and functionality of product packaging, and the popular media frequently report on consumer frustration with regard to “over” packaged or poorly accessible goods. In response, researchers, designers and manufacturers have been undertaking significant work to address these concerns. Yoxall et al. (2010a) showed that although larger-diameter jars (85 mm) required much higher opening forces than smaller ones (75 mm and below), the force required to open many jars was still higher than many elderly people are able to generate.

Yoxall et al. (2006) showed that the maximum torque  $T_m$  that a consumer can theoretically apply to open a container is governed by Equation 10.1

$$T_m = \mu_{hc} N_{\Lambda} r_c \quad (10.1)$$

where

$\mu_{hc}$  is the coefficient of friction between the hand and the container lid surface

$N_{\Lambda}$  is the minimum human grip force required for opening

$r_c$  is the external radius of the container lid

While  $\mu_{hc}$  will remain static to avoid slip between the hand and the external wall of the closure, it is necessary for a consumer to apply enough grip to avoid slip on the exterior surface of the closure. However, over a certain limit, this grip will be enough to transfer through the closure wall and add additional frictional forces to the closure/container thread interface.

Further work by Yoxall and Janson (2008) investigated the grip term in Equation 10.1 using specifically designed equipment and calculated the torques that users would then be able to apply to closures of varying diameters. The data indicated that the optimum diameter for a container lid is around 73 mm, and therefore lids of this diameter are the easiest for consumers to open. Data from Yoxall et al. (2010a) suggested that jars currently available on the market are likely to be difficult for some women and the elderly, in particular, to open. Larger sizes of jars were especially hard to open, with almost all users unable to open containers with 85 mm diameter lids. The smaller lids generally fared better, but many elderly users struggled to open all sizes of containers. Further work is required to more accurately determine the strength of consumers and the forces required to open food packaging, and to find solutions to make container lids of all diameters easier to open for all consumers.

Although various tools are available to improve the accessibility or “openability” of packaging for those who may have potential difficulty, an assessment of some of the common tools by Yoxall et al. (2010b) indicated that while some tools are effective, most offer little or no benefit, as they do not overcome issues such as loss of dexterity and strength among the aged population.

### 10.1.2 CLOSURE CONSTRUCTION

Closures are made from one of two materials: metal or plastic. Metal closures are stamped out of sheets of tinplate, ECCS or aluminum, generally with a thickness of about 0.25 mm. The sheets are usually coated with enamels to prevent the metal from reacting with the contents of the container and are frequently printed. Metal closures can take four forms: screw caps, crowns, lug caps and spin-on or roll-on closures.

Plastic closures are generally either compression or injection molded, the former being based on urea–formaldehyde or phenolic–formaldehyde resins, and the latter on a variety of thermoplastic polymers including PS, LDPE, HDPE, PP and PVC. Today, most closures are injection molded. Plastic closures are available in a wide range of sizes and designs and have defied several attempts at standardization over the years.

The actual sealing component of the closure is the *gasket* or *liner*, which must make intimate contact with the container finish to form an effective seal. Gaskets are made from rubber or plastisols, the latter being suspensions of finely divided resin (often PVC) in a plasticizer, which can be flowed in or molded. Flowed-in compounds are almost invariably used in vacuum closures and closures for heat processed foods.

Liners consist of a cushioning material (known as a *wad*) with a facing material, the purpose of the latter being to isolate the contents of the container from contact with the wad. Generally, the wad is made of composition cork (granules of cork bonded together with either a gelatin-type glue or a synthetic resin) or paperboard, and faced with either a coated paper, a paper faced with plastic film, a plain metal foil, a lacquered metal foil or a metal foil faced with a plastic film or coated with a layer of a wax material. Thermoplastic resins have allowed the development of “linerless” plastic closures, which rely on a variety of styles of sealing rings molded into the closures to create a liquid or hermetic seal.

### 10.1.3 FOOD CONTAINER CLOSURES

In general, closures that are used with food containers can be classified under four headings that are each discussed in turn.

### 10.1.3.1 Closures to Retain Internal Pressure

The closures for this application are generally required to contain pressures from about 200 to over 800 kPa, as typically found in carbonated drinks and beer.

#### 10.1.3.1.1 *Crown Cork*

The traditional pressure-retaining closure has been the crown cork, a crimp-on/pry-off friction-fitting closure made from tinplate with a fluted skirt (angled at 15° to maintain an efficient seal) and a cork or plastisol liner. The crown cork was invented in 1891 by William Painter, an American of British descent who lived in Baltimore, Maryland, who said of his invention (so it is claimed) “this closure gives a crowning and beautiful effect to the bottle” and the name crown stuck. It was simple, economical to produce and retained gas in the bottle. Though simple in concept, the crown cork provides a friction-fit sufficient to seal pressurized beverages. The flared cap skirt, in conjunction with the smoothness of the bottle neck, provides easy access through the prying motion of a bottle opener. The crown cork of today is still much the same, except that the teeth on the skirt have been reduced from 24 to 21, ECCS is used rather than tinplate, and PVC plastisol or some type of olefinic material linings have largely replaced cork (Pitman, 1999). A relatively recent improvement has been the introduction of twist-off crown corks.

The 26 mm crown cork is used worldwide and is normally applied only to a glass finish. A crown applied to a 26 mm pry-off finish will require some type of opening device to remove the crown from the container, whereas a crown applied to a 26 mm twist finish can be removed by hand. The pry-off finish has a large solid ring of glass around the outside. The corrugations of the crown can be crimped under the ring during application to hold the crown in place and form a solid seal. The twist-off finish has four noncontinuous threads and the corrugations of the crown are crimped into the threads to form the seal. The crown can be removed from the twist container by turning it 6 mm.

The crown cork is applied to a filled container using a crowner that exerts a straight downward force on the crown to crimp it onto the finish. The crowning head compresses the crown liner to form a tight seal and bends the crown skirt downward and inward to lock it tightly under the locking ring on a pry-off finish. In the case of a twist-off finish, the knuckles between the corrugations are crimped into the threads in the bottle finish. This effectively puts threads into the inner side walls of the crown, allowing the crown to twist off.

Crowns are used in a wide range of beverage products as an inexpensive, single use seal. They are also used for hot or cold filled, pasteurized and pressurized products and for sterilized vacuum products.

#### 10.1.3.1.2 *Roll-On Tamper-Evident*

A ROTE aluminum closure was first used in the 1920s as a closure on bottles of prescription drugs. It is now used where critical sealing requirements, such as carbonation retention, vacuum retention and hermetic sealing are to be met. The closure is produced as an unthreaded shell containing a liner and is applied to the proper finish on a plastic or glass container. A thread is formed in the closure matching the bottle thread. The ROTE closure is produced in a wide range of sizes (from 18 to 38 mm), and is available in two different tamper-evident styles: the vertically scored and the standard band (both with and without venting). On opening, the vertically scored band ruptures along vertical score lines and is removed as part of the closure. The standard band separates from the closure during opening and remains on the bottle. Both standard and vertically scored closures can be reclosed after the original opening by turning the threaded closure back onto the container finish.

The ROTE closure is produced from coated, light gauge aluminum, and a range of lining materials (plastics, plastisols, pulpboard and facing, etc.) are available depending on the product to be packed. The closure is coated on the inside surface for protective purposes and can be printed and decorated in various colors on the outside surface to enhance the package's appeal.

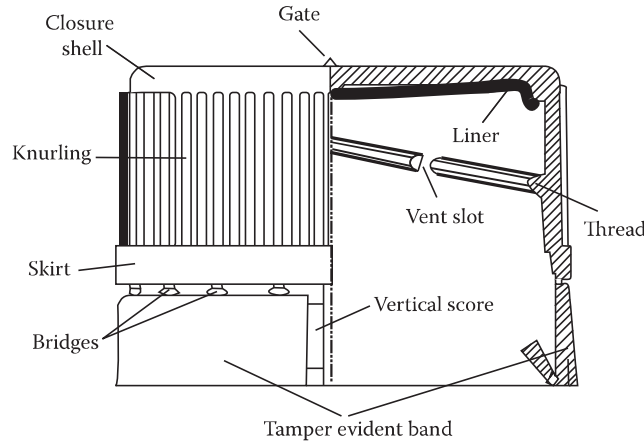

**FIGURE 10.1** Nomenclature for plastic closures. (From Pitman, K., *Closures for beverage packaging*, in: *Handbook of Beverage Packaging*, Giles, G.A. (Ed.), CRC Press, Boca Raton, FL, 1999, p. 209.)

ROTE closures are applied to filled containers using roll-on capping machines. The capping head first applies a downward pressure that compresses the liner onto the sealing surface of the container. The capping head then forms a thread in the closure matching the container thread, while also tucking the tamper-evident band under a locking ring on the container finish.

Plastic versions of the closure are now available and used widely; nomenclature for such closures is shown in Figure 10.1. Plastic prethreaded closures can generally be characterized by their size (diameter), thread form, material (HDPE or PP), seal and type of tamper evidence (Pitman, 1999). The most common size is 28 mm although some 38 mm caps are used for carbonated beverages. The liner in two-piece closures is usually made of EVA as it is soft and easily deformable. The rolled-on or spun-on aluminum or plastic closure is especially popular for carbonated drinks in large containers where reuse is common. Generally, the same closures are applied to glass and plastic bottles.

The standard thread on PET bottles for carbonated beverages has four vertical slots to allow “venting” of CO<sub>2</sub> from the bottle as the cap is unscrewed; the slots in the thread on the bottle line up with the breaks in the thread on the caps to allow a gradual release of pressure from the bottle as the cap is unscrewed. This prevents a phenomenon known as “tail end blow off,” tailing or missiling, which occurs when pressure inside the bottle causes caps to eject while being unscrewed as they reach the end of contact with the threads on the bottle.

### 10.1.3.2 Closures to Contain and Protect Contents

These closures are designed to contain and protect the contents with no internal pressure, (e.g., wine in a bottle).

The style and development of wine is strongly influenced by the choice of closure, with different closures producing different wines over time after bottling wine from the same batch, due to the different O<sub>2</sub> barrier properties of the closures. A key issue is whether wines require O<sub>2</sub> to age in the bottle. Some experts consider that wine development after bottling is a process of reduction, while others consider that some amount of O<sub>2</sub> benefits wine maturation after bottling, and therefore closures with different O<sub>2</sub> permeabilities would help to mitigate reduced off-flavors and sulfur-like odors (SLOs) and create different wine styles. According to Waterhouse and Elias (2010), a certain degree of oxidation is desirable in some wines (e.g., tannic reds, sherries and tawny ports) and undesirable in others (e.g., most whites and rosés). A recent review (Karbowiak et al., 2010) stated that while a basic understanding of key factors influencing the sensory perception of wines has been achieved, other important aspects are still not yet well understood, including the particular role of O<sub>2</sub>. Oxidation reactions are assumed to play a dominant role in wine aging, and seem to be related to measured values of O<sub>2</sub> transfer through various types of closures.

The most common closure for wine has been the traditional bark cork obtained from the cork oak tree *Quercus suber*, native to southwest Europe and northwest Africa, and grown commercially for its cork mainly in Portugal and Spain. The cork stopper has been used as a closure on glass bottles for over 25 centuries and provides an incomparable friction-hold seal. With a high cellular density, cork is compressible, elastic, largely impervious to air and water and low in thermal conductivity. However, 5%–10% of all wines sealed with natural cork suffer from “cork taint,” an objectionable taint caused by TCA (2,4,6-trichloroanisole) and other organohalogens, which can result in undesirable musty aromas and flavors. TCA is a naturally occurring, odorous (albeit harmless) compound that certain microorganisms produce from TCP (2,4,6-trichlorophenol); it has a very low taste threshold of 5 parts per trillion (ppt) or less depending on the sensitivity of the consumer (see Section 22.7.3).

Various approaches have been adopted to overcome the problem of cork taint in wine, a major one being the elimination of hypochlorite bleaching of corks as this was considered one of the major sources of chlorophenols. An Australian company has developed technology that reduces the likelihood of cork taint by applying a polymeric-based membrane to each end of the cork, which reduces chemicals entering the wine, regulates the passage of O<sub>2</sub> through the cork and retains cork moisture, resulting in less cork breakage. It is claimed that 90%–100% of the TCA in corks is prevented from entering the wine if corks with membranes are used.

The agglomerate cork, originally developed as a closure for sparkling wine, consists of small pieces or granules of clean, natural cork bound together with resin or a chemical binder into a single stopper. When one or more thin disks of intact natural cork are attached to the end intended to be in contact with the wine (and sometimes on the external end as well), it is referred to as a technical cork. An effective disinfecting or deodorizing process, which extracts volatile components from the cork prior to agglomeration, is claimed to eliminate the possibility of contaminants being retained inside the lenticels (pores through which gases are exchanged between the atmosphere and plant tissues).

In the early 1990s, many wineries tried synthetic (plastic) corks as a way to avoid cork taint. Although some synthetics were criticized for leaching a plastic flavor into wines, their use is growing and new formulations are being introduced. Two basic types of synthetic closures are currently available: injection molded and extruded closures. Extruded closures are manufactured by coextruding a long continuous length of HDPE and PP with a foamed LDPE core that is cut to size to make the individual “corks.” Recently, Lopes et al. (2011) examined the sealing effectiveness of different closures on the permeation of TCA when bottled wine model solutions were stored in a contaminated environment. Natural and agglomerate corks were effective barriers as they retained high concentrations of TCA in their outer portions, whereas TCA penetrated synthetic corks and contaminated the wine.

In response to the increased use of synthetic corks, the cork industry has adopted three measures to avoid TCA and TCA precursors in corks: (a) preventing contamination of cork with chlorinated compounds, (b) avoiding microbial growth on cork and (c) corrective stripping of TCA and associated compounds from cork (Pereira, 2007). One of the world’s largest cork manufacturers patented a process in 1999 that uses supercritical CO<sub>2</sub> for selective extraction of volatile compounds from cork, removing as much as 97% of TCA. Others use a controlled steam distillation process or microwaves to dry the cork and destroy TCA-producing microorganisms. Another process to remove the VOCs responsible for sensory problems in corks uses a carrier gas composed of water vapor and ethyl alcohol that is able to remove contaminants down to acceptable levels of <3 ng L<sup>-1</sup>.

The diameter of a cork on average is 24 mm, which is compressed to about 16 mm to fit into the bottleneck, after which it expands back to the average diameter of the bottleneck (ca. 18 mm). The ease of extraction depends on the structure of the cork, which affects its adhesion (friction) to the glass bottle neck. The extraction force should be >15 kg to guarantee sufficient adhesion of the cork to the bottleneck. Synthetic corks have shown a high variability of extraction force ranging from 10 to 50 kg, with values of 30 to 35 kg usually considered as optimal for uncorking, and values >45 kg indicating that the corks cannot be easily removed (Giunchi et al., 2008).

When natural cork stoppers are compressed in the bottleneck immediately after bottling, the air pressure in the cells ranges from 600 to 900 kPa and consequently air at atmospheric pressure (101 kPa) is unable to enter the bottles through the cork or between the cork–bottleneck interface. However, the extremely high internal pressure forces air out of the cork, which occurs preferentially in natural and technical corks during the first 12 and 24 months of storage, respectively, being facilitated by small openings of 60 nm diameter in the walls separating each individual cork cell (Lopes et al., 2007). Some permeation through the cork–glass interface is also possible, mainly after 12 months of storage in natural cork stoppers. Synthetic closures are permeable to atmospheric  $O_2$ , mainly after the first month of storage.

A challenge to the cork was the development in France in the late 1960s of an aluminum rolled-on closure known as Stelvin®. Research suggested that it performed better than the bark cork. The Stelvin capsule is made up of a screw cap, a long printable skirt and a liner specifically designed for contact with wine. The wad or liner consists of three or four components as shown in Figure 10.2, depending on the anticipated shelf life of the wine. For wines with a shelf life of up to 5 years, the liner consists of a central core of expanded LDPE foam to provide controlled and uniform compressibility, covered on both sides by a coextruded LDPE-PVdC copolymer-LDPE film. For wines requiring more than a 5 year shelf life, expanded LDPE is laminated to white kraft paper that is adjacent to a layer of tin foil to provide a gas barrier and a PVdC copolymer facing, which isolates the tin foil from the wine and provides an additional  $O_2$  barrier. The Stelvin screw cap requires a special glass bottle finish known as BVS (Bague Vin Suisse) where the threads start at 2.8 mm from the top instead of the usual 1.65 mm. Stelzer (2005) reviewed many of the technical publications concerning the shelf life of wine in bottles sealed with Stelvin closures.

Reeves (2010) tabulated the reported OTRs of various wine bottle closures. Values ranged from 0.0001 to  $>1.0 \text{ mL } O_2 \text{ closure}^{-1} \text{ day}^{-1}$  for cork, reflecting both natural variation and methodological differences. Values for synthetic cork varied from 0.007 to 0.031, and for screw caps from 0.0003 to  $0.001 \text{ mL } O_2 \text{ closure}^{-1} \text{ day}^{-1}$ . Karbowiak et al. (2010) presented a similar table but with units of  $\text{mg } O_2 \text{ closure}^{-1} \text{ year}^{-1}$  and these can be converted to  $\text{mL } O_2 \text{ closure}^{-1} \text{ day}^{-1}$  by multiplying by 521.6. Both tables confirm the high variability in permeability of natural cork stoppers from various origins, and even within a given batch of cork, and the very low permeabilities of screw caps. Faria et al. (2011) reported the permeability of dry, uncompressed cork to  $O_2$ ,  $N_2$ ,  $CO_2$  and the refrigerant R-134a. One of their main findings was the large variability in cork permeability

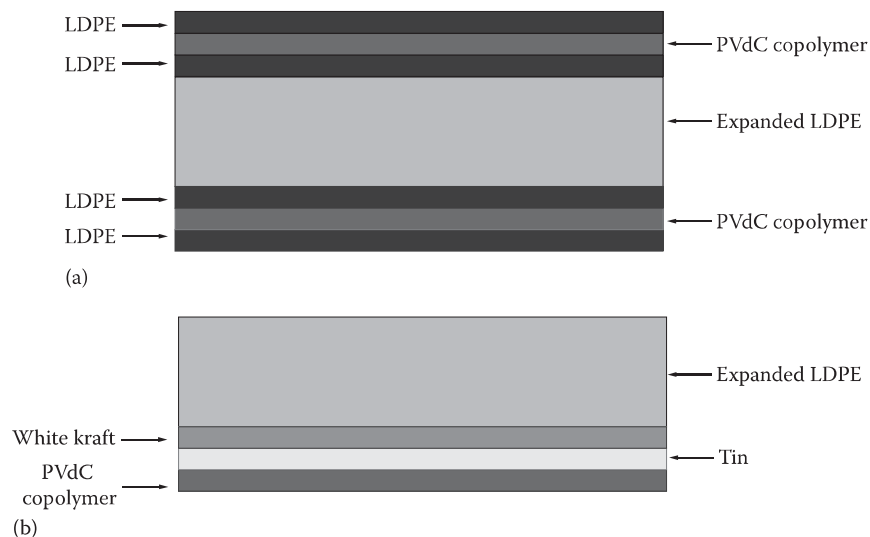

**FIGURE 10.2** Composition of liners in Stelvin capsules (a) for shelf life up to 5 years and (b) for shelf life greater than 5 years.

(3 orders of magnitude), even in the absence of macroscopic inhomogeneities. Cork density and boiling processing were factors affecting the mean permeability. As their results were obtained for uncompressed cork, they are not directly applicable to cork closures. However, they provide a clear picture of the permeability of cork, as a natural material, to several gases. Overall, wine closures must be considered a unique type of food packaging, and Karbowski et al. (2010) have suggested that it may be of interest to investigate, in a more detailed way, the relationship between a closure's permeability properties and the chemical reactions occurring in wine.

Recently, a simple, nondestructive technique for the measurement of coextruded closure OTR was presented (Diéval et al., 2011). It uses luminescence-based technology with separate sensors to measure O<sub>2</sub> ingress through the closure or at the interface between the closure and bottleneck. They reported values for synthetic corks ranging from 0.0171 to 0.0358 mL O<sub>2</sub> package<sup>-1</sup> day<sup>-1</sup> for 100% O<sub>2</sub> that converts to 0.0036–0.0075 mL O<sub>2</sub> package<sup>-1</sup> day<sup>-1</sup> for air, which is the parameter of practical interest since wine bottles are not stored under 100% O<sub>2</sub>!

### 10.1.3.3 Closures to Maintain Vacuum inside Container

These closures are designed to maintain a vacuum inside glass containers that typically contain heat-processed food (Nairn and Norpell, 2009). Metal vacuum closures are frequently referred to by the following terms: the *panel* is the flat center area in the top of the closure; the *radius* or *shoulder* is the rounded area at the outer edge of the panel connecting the panel and the skirt; the *skirt* is the flat, almost vertical portion on the side of the closure, which serves as the gripping surface and may be smooth, knurled or fluted; the *curl* is the round or rolled portion at the bottom of the skirt that adds rigidity to the cap and serves to protect the cut edge of the metal; the *lug* is a horizontal inward protrusion from the curl, which seats under the thread or lug on the finish of the container, holding the closure in position.

Three types of vacuum closures are used in food processing:

1. Lug-type or twist cap. This can be removed without a tool and forms a good reseal for storage. It has three, four or six lugs and a flowed-in plastisol liner.
2. Press-on twist-off cap. This has no lugs but the finish is threaded. The gasket is molded plastisol and covers the outer edge of the panel and the curl of the cap. It is widely used on baby foods. This type of closure is held on mainly by vacuum with some assistance from the thread impressions in the gasket wall.
3. Pry-off (side seal) cap. This is still widely used on retorted products. It consists of a cut rubber gasket held in place by being crimped under the curl. As with the preceding closure, the pry-off (side seal) cap is also mainly held in place by vacuum with slight assistance from the friction of the rubber gasket against the side of the container finish.

All the earlier-mentioned closures are made of metal (tinplate or ECCS) and are fitted either with flowed-in liners, gaskets or rubber rings.

Vacuum closures often have a safety button or flip panel that consists of a raised, circular area in the center of the panel that serves two purposes. First, it provides a visual indicator to the consumer that the package is properly sealed (containers with these types of closures usually have instructions on the closure warning consumers not to purchase or consume the product if the flip panel is up). Second, in the processing plant, the flip panel aids in automatic online detection (using a “dud” detector) of low vacuum or no vacuum containers.

### 10.1.3.4 Closures to Secure Contents inside Container

Some closures are designed only to secure the contents inside the container (e.g., peanut butter). They are frequently screw caps with a minimum thread engagement of three quarters of a turn. They are made either from metal or plastic, and typically have either a plastic-coated paperboard wad inside or may be of the linerless plastic style.

## 10.2 HEAT SEALING

Heat sealing involves welding thermoplastic polymer surfaces together in order to produce seals or joints of sufficient strength to withstand stresses in the distribution and consumer environment (Aithani et al., 2006b). A seal can be nonpeelable (tearable) or peelable (so-called easy open) and the latter are discussed in Section 10.3. The heat sealability of a packaging film is one of its most important properties when considering its use, and the integrity of the resultant seal is of paramount importance to the ultimate integrity of the package, as seal failure inevitably leads to food deterioration and a reduction in shelf life. Heat sealability is a property of the materials that are being heat sealed and at a given thickness is a function of the material composition, average MW, MW distribution and thermal conductivity (Aithani et al., 2006b).

Heat sealable films are considered to be those films that can be bonded together by the normal application of heat, such as by conductance from a heavy heat-resistant metal bar containing a heating element. Non-heat-sealable films cannot be sealed this way, but they can often be made heat sealable by coating them with heat sealable coatings (HSCs). In this way, the two facing coated surfaces become bonded to each other by application of heat and pressure for the required dwell time.

There are two types of seals (Figure 10.3). A *fin* seal is formed when the inside surface of the film is sealed against itself; it is commonly used to form the top and bottom seals on horizontal or vertical form-fill-seal machines. A *lap* seal is formed when the inside surface of the film is sealed against the opposite (outside) surface of the film; it is commonly used to form the longitudinal or back seal on vertical form-fill-seal machines.

The basic heat sealing process involves fusing two polymers to one another through the application of heat and pressure. As the sealant layer begins to melt, more intimate contact or wetting of the sealing surfaces occurs. Given sufficient time, molecular segments diffuse across the interface forming entanglements, and thus the seal strength increases.

A number of factors influence the quality of a heat seal and they can be conveniently summarized under three headings:

1. Machine factors: dwell or clamp time, temperature and pressure
2. Resin factors: density, MW, MWD and additives in the resin
3. Film factors: thickness, style or form (e.g., whether gusseted or not) and any treatment for printing such as corona discharge

All of these factors tend to interact in a complex way. For example, the amount of heat available may be limited by the capacity of the heating elements, by the rate of heat transfer of the sealing bar and its coating or the type of product being packaged. Increasing the dwell time (i.e., the time during which heat is applied, typically a second or less) will increase the heat available, but this may prove to be uneconomical since fewer units will be able to be handled per minute on the production line. The interfacial temperature and dwell time are the primary factors that control the heat

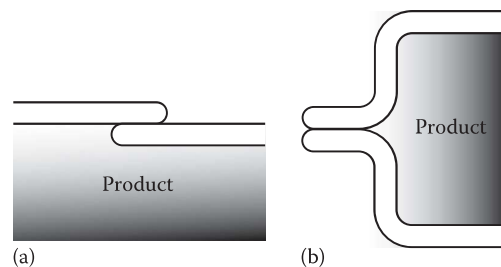

**FIGURE 10.3** Two major types of heat seals: (a) lap seal and (b) fin seal.

seal strength. In practice, it is usually the surface of the heat generator rather than the interfacial temperature that is measured and controlled, resulting in problems of either overheating or improper cooling. Pressure normal to the seal surface has little effect above the level required to flatten the webs for good contact (Theller, 1989). Corona discharge treatment of LDPE and LLDPE has been reported to cause an increase in seal initiation temperature of 5°C–17°C and change the seal failure from normal tearing to peelable mode. A reduction in seal strength has also been reported when films were contaminated with oleic acid, low MW polymer fractions, additives such as antioxidants and slip agents and external processing aids such as mold release agents.

### 10.2.1 CONDUCTANCE SEALING

Conductance (also known as *resistance* or *bar*) sealers are the most common type of heat sealers in commercial use and typically consist of two metal jaws or bars (often patterned or embossed to give the seals extra strength), one of which is electrically heated, the temperature being controlled thermostatically. The second or backing jaw is often covered with a resilient material such as rubber to distribute pressure evenly and aid in smoothing out the film in the sealing area. Frequently, the unheated jaw is water cooled, although in some situations it may be heated to the same temperature as the first jaw to enable sealing through sheets of film in exactly the same way each time. The edges of the jaws are often rounded to avoid puncturing the packaging material. A simple conductance heat sealer is shown in Figure 10.4.

Conductance sealers are used for a range of packaging materials including RCFs and laminated materials such as foil or paper with an HSC (commonly LDPE or LLDPE). However, they are not suitable for unsupported materials such as LDPE film, which would simply melt and stick to the jaws. Serrated jaws can be used to ensure that the two webs are stretched into intimate contact with high local pressure; they also improve appearance. For all sealing jaws, a nonstick coating is desirable; PTFE is commonly used, either as a cloth-reinforced film or, in the case of serrated jaws, as a powder bound in a heat-resistant vehicle.

Dwell time should be able to be controlled to fractions of a second and be easily adjustable as it needs to be changed when different materials are heat sealed. Likewise, the pressure between the jaws should also be easily adjustable.

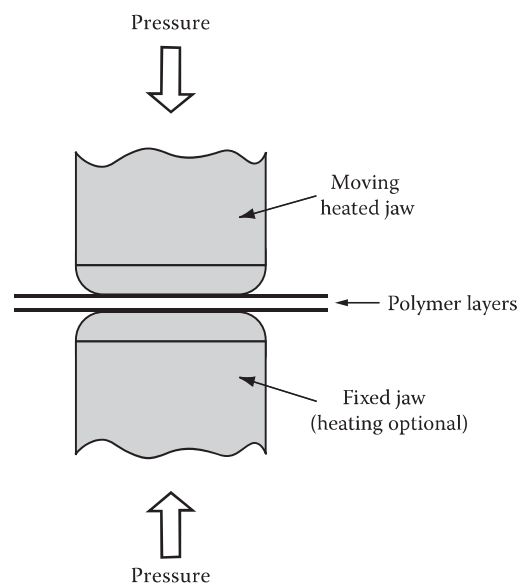

FIGURE 10.4 Conductance or bar sealer.

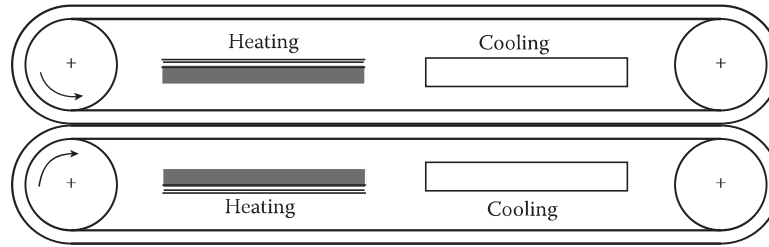

FIGURE 10.5 Band sealer.

A variation on this type of sealer is the band sealer, where the films travel between two endless bands of metal that are pressed together by heated bars (Figure 10.5). The heat passes through the bands and seals the films. The bands are then pressed together by chilled bars to withdraw heat from the seal. Band sealers are widely used for sealing pouches and have the advantage of being continuous.

Mihindukulasuriya and Lim (2012) studied the effects of liquid contaminants on the heat seal strength of three different LDPE film–film interface conditions: (1) no contaminant, (2) water contaminant and (3) vegetable oil contaminant. In the presence of liquid contaminant, jaw pressure played an important role in displacing the liquid from the seal area to form intact seals. Short dwell time (0.3 s) and low jaw temperature (150°C) was not favorable for forming intact seals in films contaminated with water or vegetable oil. The optimum jaw temperature and dwell time required to produce intact seals for oil-contaminated films was 180°C and 0.3 s, whereas a combination of 165°C jaw temperature and 1 s dwell time was required to form intact seals for water-contaminated films. Interface temperatures of 130°C–140°C resulted in optimum seal strength for both water-contaminated and clean film specimens. Above 140°C, a weakening of seal strength was observed, presumably because of the change in melt flow characteristics and possible initiation of thermal degradation of the polymer.

### 10.2.2 IMPULSE SEALING

In this method, the films (usually unsupported materials) are clamped between two cold metal bars and then fused by applying an impulse current of 20–50 A through a nichrome resistance wire or ribbon (typically 2–5 mm wide and 0.1–0.15 mm thick) on one or both sealing jaws for a short time (0.2–3.0 s); cooling occurs under pressure (Hishinuma, 2009). Although impulse sealers have the same general configuration and mechanical construction as conductance sealers, much lighter jaws are used (Figure 10.6).

Generally, the current in the resistance wire is kept constant and the amount of heating is changed by adjusting the energizing time in the resistance wire (Hishinuma, 2009). Dwell time of the heating impulse must also be controlled, as must the length of the cooling period. Thus, two timers are often found on impulse sealers, with the second timer controlling the cooling of the resistance wire to allow the film to harden under pressure and prevent deformation of the film in the sealed area. If very heavy films are to be sealed, both jaws may contain resistance wires. Water is recirculated through a tube behind the impulse ribbon to prevent excess heating and promote rapid cooling of the heat seal, thus permitting the sealing of unsupported thermoplastic materials.

To prevent the film from sticking to the heated jaws, it is usual to cover them with a layer of thin heat-resistant material such as silicone-rubber-coated fiberglass, PTFE-coated fiberglass or PTFE-coated polyimide film (Morris and Darby, 2009). Generally, the seals produced by impulse sealing are of excellent quality and tend to be narrower than those produced by conductance sealing. The main drawback is the high maintenance costs as the nichrome wire and release coverings require frequent replacement.

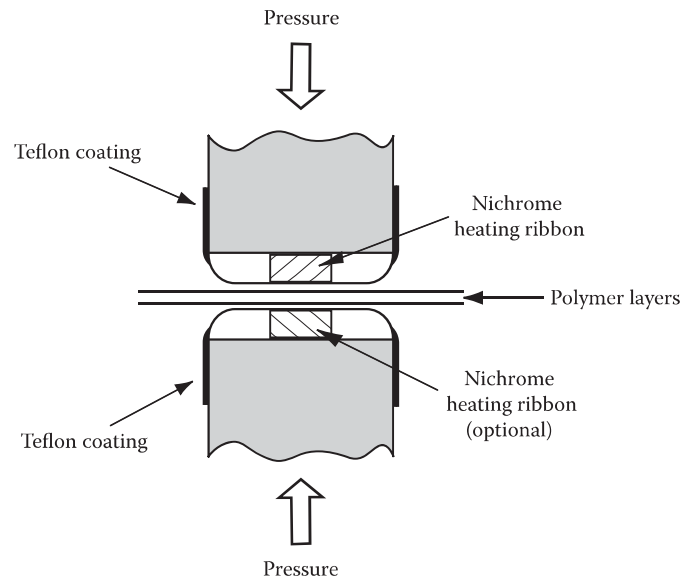

FIGURE 10.6 Impulse sealer.

### 10.2.3 DIELECTRIC SEALING

In dielectric sealing (also known as radio frequency [RF] sealing), a high frequency (HF) generator transforms low frequency electrical energy from the alternating current network into HF electrical energy (typically 50–80 MHz), which is then passed through two or more layers of film (Figure 10.7). The dipoles in the polymers oscillate in response to the alternating electric field and molecular resistance generates heat to melt the polymer. The electrodes (usually made of brass) are the top and bottom jaws and the latter is the ground of the circuit. The pressure that the jaws exert on the films helps to bring about thorough fusion and bonding.

Dielectric sealing is only applicable to materials that are polar and capable of forming a dipole moment, that is, have a dielectric loss factor approaching 0.01 or higher. Such materials include EVA, EVOH, PA, PET, PVC, PVdC and composite materials. The main advantages of dielectric sealing are that only the desired area is heated and the sealing instrument remains cool. It is used principally with PVC and nylon 6,6 films as they are difficult to heat seal by direct means because they tend to degrade at temperatures close to their softening point.

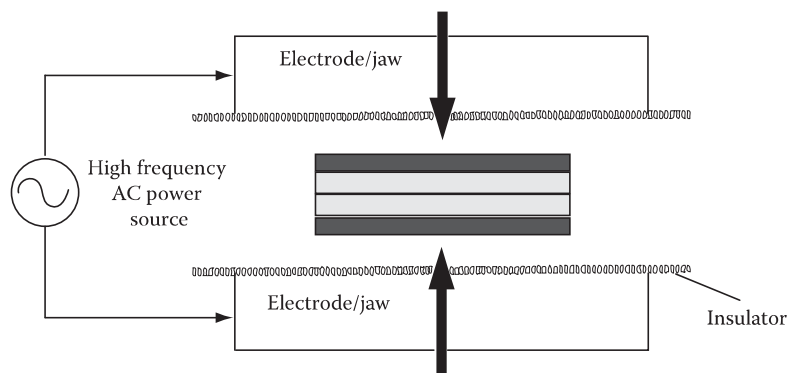

FIGURE 10.7 Dielectric sealing.

### 10.2.4 INDUCTION SEALING

Induction sealing is a noncontact method of heat sealing made by exposing a metal (generally aluminum foil) coated with a thermoplastic sealant to a HF, electromagnetic field generated by passing an alternating current of 20–30 kHz through a coil. The field induces circulating eddy currents (also called Foucault currents), which generate precise amounts of localized heat in the foil, melting the sealant layer without any physical contact between the coil and the package. The basic components of an induction heating system are an AC power supply and an induction coil (Figure 10.8).

The original concept and method for induction sealing was conceived and proven by Jack Palmer from the FR Corporation of New York as a means of solving liquid leakage from polyethylene bottles during shipment; he was issued with U.S. Patent 2937481 in May 1960. Modern advances in solid state technology have made induction heating a remarkably simple and cost-effective sealing method.

Induction sealing is used to heat seal diaphragms or inner seals to bottles and jars. An induction seal provides tamper evidence and a hermetic seal when used as an inner seal beneath a normal threaded closure. The torque of the cap holds the seal in place during the induction heating process. The operating frequency of the power supply determines the heating pattern of the electromagnetic field. Higher frequency results in heat concentration on the outside edge of the inner seal, which is beneficial for one piece type liners. As the frequency is lowered, the heating tends to be more uniform across the inner seal.

Induction sealing is also widely used to heat seal both the longitudinal and transverse seals of laminated paperboard cartons containing aluminum foil. Tetra Pak was awarded U.S. Patent 4637199 in 1987 for an “*Induction apparatus and method for sealing of thermoplastic coated packing material.*” A number of nonconductive sealing jaws, each containing a secondary induction coil, are mounted on an endless chain opposite corresponding rigid pressure jaws also mounted on an endless chain. After the sealing pulse is terminated, there is a cooling time that enables the LDPE to resolidify as a single layer, guaranteeing a strong and tight seal. The jaw pressure must be kept for sufficient time to allow suitable sealing and cooling, in order to ensure a tight closure of the package. In continuous transverse sealing, the pressure jaws include a knife to sever the seals.

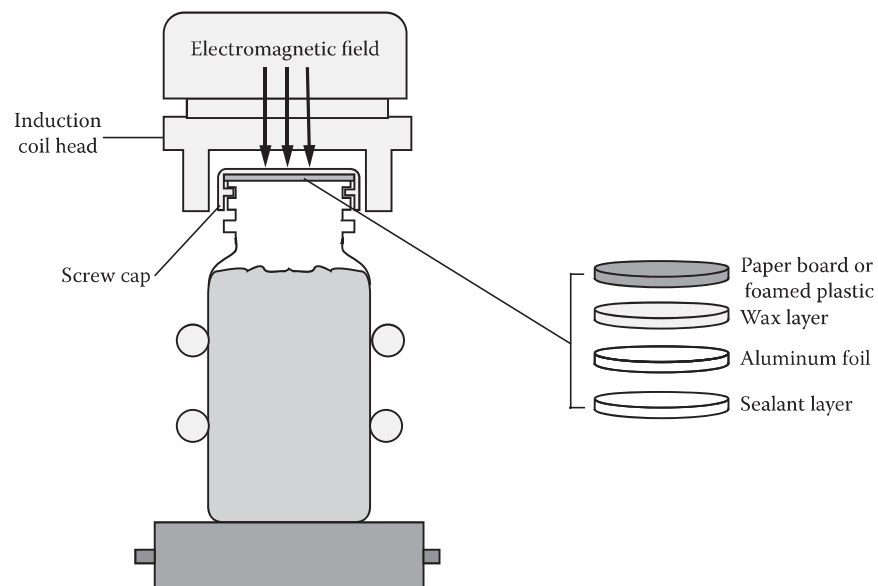

FIGURE 10.8 Induction sealing.

The great advantage of induction sealing is its applicability to almost all thermoplastic materials. Placing an electroconductive layer such as aluminum foil close to the thermoplastic material allows the sealing of composite materials with a thick heat-insulating layer, which are usually unsealable using other methods. Unlike ultrasonic sealing, the mechanical stress on the material is unimportant.

### 10.2.5 ULTRASONIC SEALING

In this method of sealing, a generator feeds a 20–40 kHz signal into a transducer that transforms electrical energy into mechanical vibrations of the same frequency. The mechanical energy is converted into heat at the interface and produces an almost instantaneous weld. Little overall heating is produced, thus enabling oriented films to be sealed without any change in dimensions. Ultrasonic sealing is also useful to seal materials that are too thick to permit conductive heat transfer through them for sealing (Morris and Darby, 2009).

An ultrasonic horn acts as a focusing tool for the vibrations that pass through the film to an anvil (Figure 10.9). Any gap between the two surfaces to be sealed weakens the transmission of the ultrasonic vibrations. Therefore, to ensure transmission and energy dissipation, the horn presses the films against a counter tool called the anvil that also functions as an energy director. The heating is initiated by starting the vibration of the horn and is stopped by switching off the ultrasound (Bach et al., 2012). The pressure, along with temperature and dwell time (expressed in terms of the rate at which the film is fed between the welding head and anvil), are adjusted to get optimum seal quality. The biggest disadvantage of ultrasonic sealing is its cost (Morris and Darby, 2009). Ultrasonic sealing has particular advantages for longitudinal seam sealing in horizontal form-fill-seal machines for confectionary products such as chocolate as the cool tools prevent melting of the product. It has

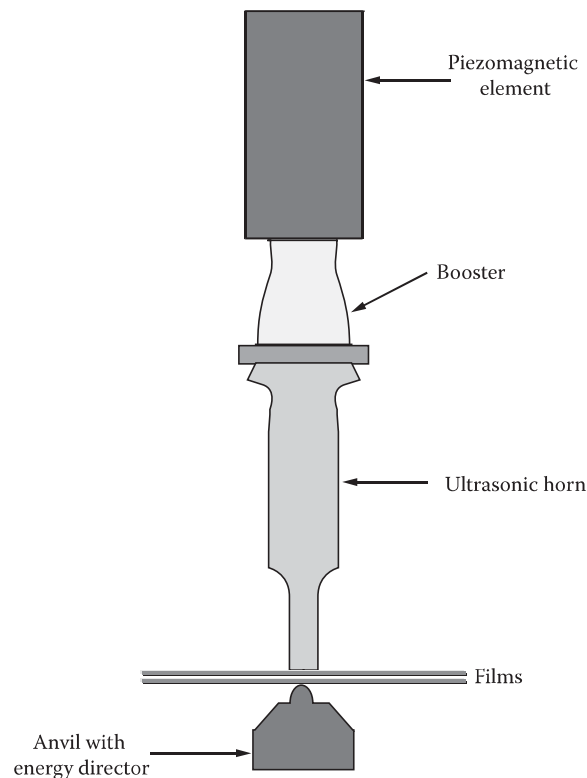

FIGURE 10.9 Ultrasonic sealing.

been suggested that ultrasonic sealing may be a useful alternative to cold sealing processes and help reduce packaging material costs (Bach et al., 2012).

Ultrasonic sealing is useful for sealing materials that are too thick to permit conductive heat transfer through them as in conventional sealing methods. Resistance to contamination in the seam area is often mentioned as one of the biggest advantages of ultrasonic sealing, because of the expulsion of the contamination due to the vibrations. Three expulsion mechanisms have been identified: (1) expulsion because of the static sealing force in combination with shaped sealing tools, (2) expulsion because of the vibration of the ultrasonic horn and (3) expulsion because of the squeezing out of melted sealing material. Bach et al. (2012) concluded that ultrasonic vibrations of the horn mainly influence the expulsion of loose materials by inducing a vibration of the films. For fluids and pasty goods, expulsion by the static force combined with the tool's shape and expulsion by melted sealing material dominated.

### 10.2.6 HOT-WIRE AND HOT-KNIFE SEALING

Hot-wire and hot-knife sealing use a thin wire or strip of metal with a radiused edge (knife) mounted in or on the surfaces of a bar heated with a low voltage current. The relatively small surface area of contact causes all of the force of sealing to be transmitted through a small area, resulting in a high pressure in the seal area (Morris and Darby, 2009).

This method has found application for the manufacture of polyethylene bags and pouches in tubular form, with the sealing and cutting operations carried out in one step. It is only applicable to thermoplastic films that can tolerate high temperatures for a short time and also have a low viscosity in the fused stage. When unsupported films are trim sealed by this method, they tend to form a strong bead in their seal areas due to surface tension and orientation. This method is also used to a limited degree with laminated materials.

There is a tendency with this method of sealing to get what is known as “angel hair”—fine strands of polymer protruding from the seal area. This can be controlled with the use of proper temperatures and times. Generally, films thicker than 0.05 mm are difficult to seal through, especially if they have gusseted structures.

### 10.2.7 TESTING OF HEAT SEALS

Seal strength is a quantitative measure for use in process validation, process control and capability. Seal strength is not only relevant to opening force and package integrity, but also to measuring the ability of the packaging processes to produce consistent seals. Seal strength at some minimum level is a necessary package requirement, and at times it is desirable to limit the strength of the seal to facilitate opening. *Hot tack* refers to the strength or peel resistance of a seal while it is still hot following heat sealing.

Testing the strength of heat seals between thin films is generally determined by measuring the force required to pull apart at a constant rate the pieces of film that have been sealed together, either in a dynamic load test or a static load test. The latter test tends to be qualitative whereas the dynamic test (usually performed on some type of tensile testing equipment) is quantitative. The *seal strength* ( $\text{N m}^{-1}$ ) is defined as the maximum (peak) force required to separate the seal divided by the film width (typically 15–25 mm). At sufficiently high extension, failure of the test piece occurs. The elongation of the test piece at failure (*seal elongation*) and the area under the force/distance curve (*seal energy*) are commonly taken as indicative of the toughness of the seal.

The ASTM F88 standard test method for determination of the seal strength of flexible barrier materials describes the procedures to be followed, along with the equipment to be used and the methods to be employed, thus enabling useful comparisons to be made between the seal strength of different materials and/or different sealing methods. This test method measures the force required to separate a test strip of material containing the seal. It also identifies the mode of specimen failure.

ASTM F2029 details standard practices for making heat seals for determination of heat sealability of flexible webs as measured by seal strength. These practices apply primarily to webs intended to be used on commercial machines employing reciprocating sealing jaws, such as most form-fill-seal packaging machines, platen heat sealers and so forth. Conditions of dwell time and sealing pressure on machines of this type are typically different from those on rotary machines. This standard is restricted to sealing with a machine employing hot-bar jaw(s). Impulse, high-frequency and ultrasonic heating methods are not included. Determination of heat sealability as judged by seal continuity, typically measured by air-leak, dye penetration, visual examination, microorganism penetration or other techniques is not covered by this standard.

In form-fill-seal operations, sealed areas of packages are frequently subject to disruptive forces while still hot. If the hot seals have inadequate resistance to these forces, breakage can occur during the packaging process. ASTM F1921 measures hot seal strength (hot tack) and can be used to characterize and rank materials in their ability to perform in commercial applications where this quality is critical. This test method is restricted to instrumented hot tack testing, requiring a testing machine that automatically heat seals a specimen and immediately determines strength of the hot seal at a precisely measured time after conclusion of the sealing cycle.

For many small and odd shaped packages, the seal strength cannot be measured by standard means. The upper force limit for each individual package can be determined by applying a constant force and maintaining it for a predetermined time. By placing the package within restraining plates during pressurization, the dimensional stability of the package is maintained in a manner that results in stresses applied more uniformly along the perimeter of the package, where seals are normally placed. This allows the test to have a higher probability of detecting the weakest area of the seal and provides a measurement of the pressure required to “burst” open the package. This test only applies to flexible packages with seals placed around the perimeter of the package (i.e., pouches).

Test method ASTM D3078 covers the determination of gross leaks in flexible packaging containing a headspace gas. The package is submerged in a transparent container filled with a mixture of water and dye. Vacuum is created inside the container and maintained for a specific length of time. When the vacuum is released, any leaks will draw in dye revealing an imperfect seal. Test sensitivity is limited to  $1 \times 10^{-3}$  kPa  $m^3 s^{-1}$  or even less, and small leaks may not be detected. Positive pressure inside the pouch after the vacuum is drawn may force the product to plug small leaks. The size of the leak that can be detected depends on the products contained, the nature of the packaging material and the test parameters selected.

Test method ASTM D1876 is primarily intended for determining the relative peel resistance of adhesive bonds between flexible adherends by means of a T-type specimen using a tension testing machine. The bent, unbonded ends of the test specimen are clamped in the test grips of the tension testing machine and a load of a constant head speed is applied to give force as a function of elongation. The peel force, defined as the average force between 20% and 80% of the elongation at break, is determined.

Two tests are commonly used to assess the seal integrity of aseptic laminated paperboard cartons. The electrolytic test is based on the principle that a tight plastic container is an electrical insulator. By introducing an electric potential across a brine-filled package that is partially immersed in a brine solution as shown in Figure 10.10, the existence of holes in the package can be determined. Any defect in the package that allows current to flow out of the package results in a positive test. However, the electrolytic test is not a conclusive test since it is possible for tight packages to give positive results. Therefore, all positive tests should be followed with a dye test.

In the dye test, after rinsing the filled and sealed carton with water and drying, a solution of 0.5% Rhodamine B in isopropanol is applied to the critical areas of the package including the longitudinal and transverse seals. The carton is then allowed to develop for 5 min and dried in a warm cabinet overnight. The flaps of the package are unfolded and the dye-coated paper removed and examined for ink penetration. Any signs of the pink dye indicate the presence of holes in the polyethylene layers.

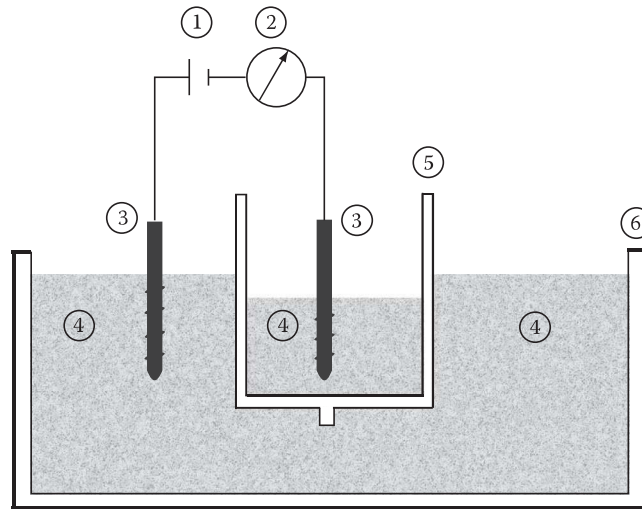

**FIGURE 10.10** Electrolytic test for presence of pinholes in an aseptic carton package: (1) 9 V battery, (2) ampere meter, (3) electrode, (4) saline solution, (5) aseptic package and (6) bath.

High voltage leak detection (HVLD) is an emerging technology for fully automated detection of package leaks and tampering (Song, 2009). It is capable of detecting pinholes less than  $10\mu\text{m}$  in diameter. Although nondestructive, it may further damage defective packages by enlarging pinholes 5–10 fold due to the high voltages involved.

Many other less formalized methods of testing heat seals are widely used in the food industry. For example, polarized light can be used with transparent materials, with the birefringence patterns providing a visual guide to the consistency of the seal and highlighting any gaps or stresses.

### 10.3 PEELABLE SEALS

The technology of easy-open, peelable seal packaging has been used in the food industry since the concept was developed in the late 1960s. Peelable seal technology provides retention of package integrity yet allows consumers to access the contents without tearing or otherwise destroying the package. Seals can be made peelable either by using peelable films or HSCs, or by controlling the sealing temperature (Aithani et al., 2006a). Seal strength as a function of interfacial temperature is shown in Figure 10.11.

There are three basic peel mechanisms for achieving peelable heat seals (Dodrill, 2005).

#### 10.3.1 ADHESIVE PEEL

An adhesive peel separates between the interface of the two webs being heat sealed together as shown in Figure 10.12. As a result, it provides a relatively poor seal indicator with no transfer to the opposite web, but is desirable for applications such as lidding for a food tray. The seal strength of materials with adhesive peels tends to be more sensitive to temperature, pressure, and/or dwell time fluctuations, because seal strength is greatly affected by surface mechanics.

#### 10.3.2 COHESIVE PEEL

With a cohesive peel, the sealant splits when peeled with some of the sealant transferring to the opposing web while some remains with the original sealant web as shown in Figure 10.13. Sealants designed to provide cohesive peels are usually created by blending a contaminant (usually an

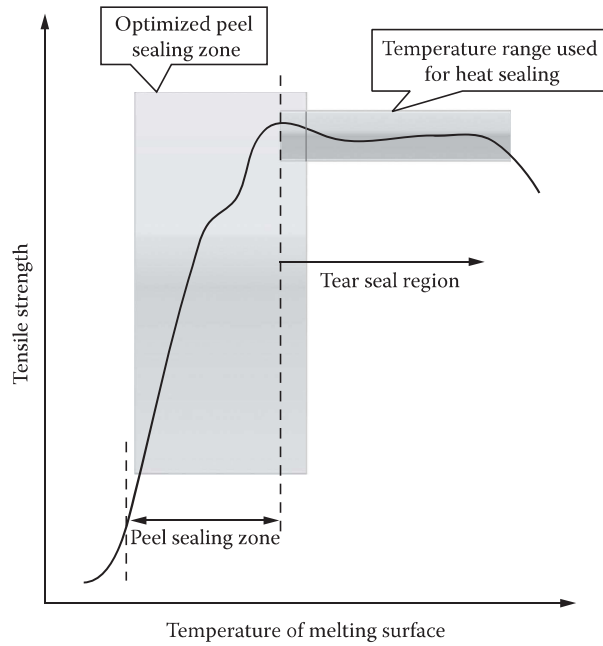

**FIGURE 10.11** Tensile strength of heat seals as a function of interfacial temperature.

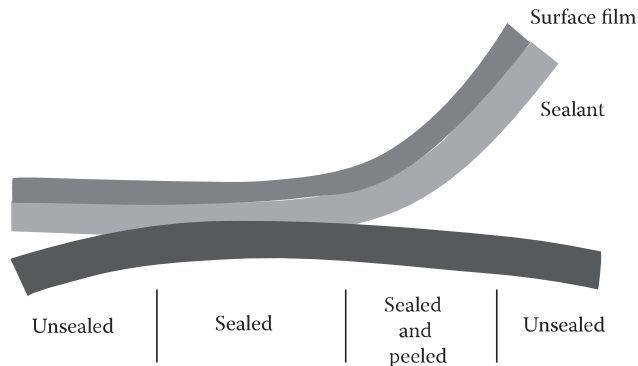

**FIGURE 10.12** Adhesive peel. (From Dodrill, D., *Advances in Peelable Sealant Technology*, Rollprint Packaging Products, Inc., Addison, IL, 2005. With permission.)

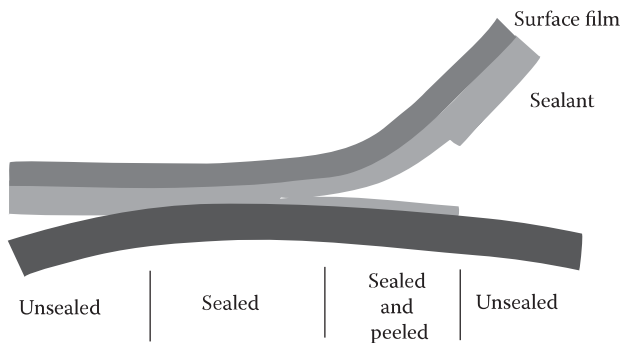

**FIGURE 10.13** Cohesive peel. (From Dodrill, D., *Advances in Peelable Sealant Technology*, Rollprint Packaging Products, Inc., Addison, IL, 2005. With permission.)

incompatible resin that will not solubilize in the base resin, thus disrupting the resin matrix) into a base resin. The sealant splits when peeled because the strength of the seal interface (the bond between the two webs) is stronger than the internal bond of the sealant layer.

The seal strength of a cohesive peel is controlled by varying the amount of contaminant blended into the sealant, resulting in sealants with a very wide operating window. Because the sealant splits when peeled, cohesive peel sealants are more prone to stringing (sometimes called angel hair) than adhesive peel sealants.

The key to creating a sealant with a cohesive peel is selecting two (or more) resins that are incompatible. Sealants based on polybutene-1 have long been the standard for providing peelable seals to polyolefins where the incompatibility between polybutene-1 and polyethylene causes weak bonding. The failure mechanism is cohesive and propagates through the sealed layer, resulting in uniform separation of the substrate layers. Seal strength is dependent on the thickness of the polybutene-1 blend layer; as the thickness of the sealant layer increases, so does the seal strength. Recently, EAA ionomer resins have been used in blends with LDPE resins, plastomers or PP resins to create tailor-made cohesive seals that resist aging. A thin layer of EAA ionomer resins, coextruded with HDPE resins, can provide the desired burst peel.

### 10.3.3 DELAMINATION PEEL

The delamination or interlaminar peel is designed to fail at the interface between the sealant layer and the material to which it is being sealed as shown in Figure 10.14. The strength of the bond between the sealant layer and the surface film is greater than that at the interface, which is why it peels by delamination. In order for a delamination peel to open, the user must break through or tear the sealant layer from the substrate to initiate the peel. As a result, stringing and webbing are a much greater concern for this peel mechanism.

### 10.3.4 HEAT SEAL COATINGS

HSCs have a very long history and were the original way to achieve peelable seals. They are based on the cohesive failure of the adhesive, which is less than the bond strength between adhesive and sealed material. Today, there is a tremendous variety of HSC options available to provide peelable seals to most substrates. HSCs based on resins and additives are traditionally applied to a web as solutions and are often more expensive than other types of peelable sealants (Dodrill, 2005).

Solution-applied HSCs have long been the standard for providing peelable sealants to PP for retort applications. The sealant must withstand typical retort temperatures of 120°C and above and

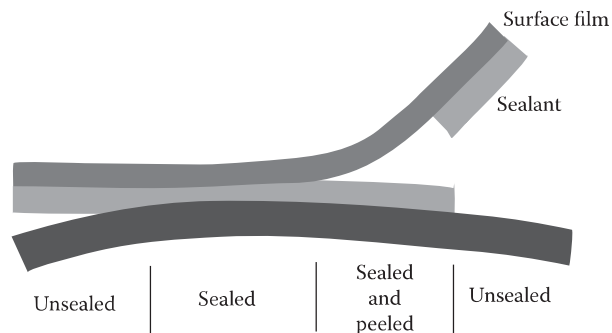

**FIGURE 10.14** Delamination peel. (From Dodrill, D., *Advances in Peelable Sealant Technology*, Rollprint Packaging Products, Inc., Addison, IL, 2005. With permission.)

must seal and peel to PP. In addition, the peelable seal must not creep when exposed to the forces created by any pressure differential between the inside and outside of the package. The PP extrusion coated sealants consist of a three-layer coextrusion of a modified PP designed to promote adhesion, a bulk layer of PP and a thin peelable PP sealant layer. These sealants can be coated by coextrusion onto PET, aluminum foil and other heat-stable webs.

### 10.3.5 SEAL INTERFACE TEMPERATURE

A relatively new technique referred to as MTMS (method for measuring temperature of melting surface) has been used to predict the strongest peelable seal on various commercial packaging films (Aithani et al., 2006b). The MTMS system consists of three components: a temperature control unit to control the temperature of both sealing jaws, a manually-operated heat sealing unit and a time–temperature recorder unit (Hishinuma, 2009). The temperature of the seal interface is measured using a thermocouple to generate a time–temperature profile from which the inflection point (also called the fusion point) is identified. This inflection point is associated with a physical change in the state of the material being sealed. The highest peelable seal strength was achieved at a temperature close to the fusion point but below the melting point. Seals made above the fusion temperature resulted in weld seals. The key temperatures for producing peelable seals for some common polymer films are presented in Table 10.1.

### 10.3.6 NANOCOMPOSITE HEAT SEALANTS

Nanocomposite heat sealants based on LLDPE/LDPE blends reinforced by a combination of EVA copolymer and organically modified MMT were reported by Manias et al. (2009). These materials yielded hermetic but peelable heat seals characterized by almost constant seal strength, which was largely independent of sealing temperature. This novel performance was ascribed to a synergy between the EVA copolymer and the MMT nanofillers, which have an interfacial adhesion that is strong enough to promote mixing and maintain the sealant integrity, but is weak enough to dictate paths of easy crack propagation on seal peeling. This synergy resulted in a general cohesive failure of the nanocomposite sealant and consequently in the formation of a broad range of peelable seals.

**TABLE 10.1**  
**Key Temperatures for Producing Peelable Seals for Some Common Polymer Films**

Film Composition	Thickness (μm)	Melting Temperature by DSC (°C)	Interface Temperature (°C)	Inflection Point/Fusion Temperature (°C)
Copolymer of 90% PE/10% LLDPE	35.6	123.6	140.0	112.6–113.0
Coextruded HDPE/EVA	50.8	131.7	140.0	126.7–128.0
Cast PP with heat-sealable coating	71.1	164.8	175.0	142.9–143.1
Black pigmented LDPE	50.8	111.0	119.0	104.4–104.5
Coextruded LLDPE/EVA	58.4	102.7	120.0	95.7–96.7

Source: Adapted from Aithani, D. et al., *Packag. Technol. Sci.*, 19, 245, 2006b.

## 10.4 COLD SEALS

For the packing of heat-sensitive foods such as chocolate, chocolate-coated biscuits, certain confectionary and ice cream, significant product damage can result from heat sealing. Therefore, cold seal technology that requires only mechanical pressure to bond two layers together is used as an alternative to heat sealing. Although there is some use of cold seals in vertical FFS packaging, the main application is in horizontal FFS or flow wrap bar lines and overwraps. Compared to heat sealing, cold seals are much less sensitive to sealing dwell time and more tolerant to variations in packaging line speed (Durston, 2006). Cold seal adhesives differ from pressure-sensitive adhesives discussed in Section 9.4.2.4 in that the latter are permanently tacky and must be covered with release paper to prevent adhering to anything until the final use. The uniqueness of cold seal adhesives is that they seal only to themselves.

Cold seal adhesives consist of a water-based emulsion of which the key component is natural rubber latex, which offers a unique combination of adhesion and cohesive strength in the required range but without tackiness; other ingredients include water, ammonia, surfactants, antioxidants, antifoam agents, biocides and an acrylic component to aid adhesion to the coated surface (Durston, 2006). In recent years a synthetic version of cold seal adhesives based on EVA copolymers has been developed. The emulsion is printed onto the desired seal areas of the inner surface of a web substrate using an engraved gravure cylinder at a coating rate of 2–6 gsm depending on the application. A release lacquer consisting of polyamide resin is applied to the outer printed surface to permit easy unwinding of the reel. Alternatively, a release film such as low surface tension plain OPP can be laminated over the print.

## REFERENCES

- Aithani D., Lockhart H., Auras R., Tanprasert K. 2006a. Predicting the strongest peelable seal for 'easy-open' packaging applications. *Journal of Plastic Film and Sheeting* 22: 247–264.
- Aithani D., Lockhart H., Auras R., Tanprasert K. 2006b. Heat sealing measurement by an innovative technique. *Packaging Technology and Science* 19: 245–257.
- Bach S., Thürling K., Majschak J.-M. 2012. Ultrasonic sealing of flexible packaging films—Principle and characteristics of an alternative sealing method. *Packaging Technology and Science* 25: 233–248.
- Diéval J.-B., Vidal S., Aagaard O. 2011. Measurement of the oxygen transmission rate of co-extruded wine bottle closures using a luminescence-based technique. *Packaging Technology and Science* 24: 375–385.
- Dodrill D. 2005. *Advances in Peelable Sealant Technology*. Addison, IL: Rollprint Packaging Products, Inc. Downloaded from <http://www.rollprint.com/PDF/PeelableSealants.pdf>
- Durston J. 2006. Flexible packaging closures and sealing systems. In: *Packaging Closures and Sealing Systems*, Theobald N., Winder B. (Eds). Boca Raton, FL: CRC Press, pp. 204–230.
- Faria D.P., Fonseca A.L., Pereira H., Teodoro O.M.N.D. 2011. Permeability of cork to gases. *Journal of Agricultural and Food Chemistry* 59: 3590–3597.
- Giunchi A., Versari A., Parpinello G.P., Galassi S. 2008. Analysis of mechanical properties of cork stoppers and synthetic closures used for wine bottling. *Journal of Food Engineering* 88: 576–580.
- Hishinuma K. 2009. *Heat Sealing Technology and Engineering for Packaging: Principles and Applications*. Lancaster, PA: DEStech Publications.
- Karbowiak T., Gougeon R. D., Alinc J. B., Brachais, L., Debeaufort F., Voilley A., Chassagne D. 2010. Wine oxidation and the role of cork. *Critical Reviews in Food Science and Nutrition* 50: 20–52.
- Lopes P., Marques J., Lopes T., Lino J., Coelho J., Alves C., Roseira I., Mendes A., Cabral M. 2011. Permeation of d<sub>5</sub>-2,4,6-trichloroanisole via vapor phase through different closures into wine bottles. *American Journal of Enology and Viticulture* 62: 245–249.
- Lopes P., Saucier C., Teissedre P.-L., Glories Y. 2007. Main routes of oxygen ingress through different closures into wine bottles. *Journal of Agricultural and Food Chemistry* 55: 5167–5170.
- Manias E., Zhang J., Huh J.Y., Manokruang K., Songtipya P., Jimenez-Gasco M.M. 2009. Polyethylene nano-composite heat-sealants with a versatile peelable character. *Macromolecular Rapid Communications* 30: 17–23.
- Mihindukulasuriya S., Lim L.-T. 2012. Effects of liquid contaminants on heat seal strength of low-density polyethylene film. *Packaging Technology and Science* 25: 271–284.

- Morris B.A., Darby D. 2009. Sealing, heat. In: *The Wiley Encyclopedia of Packaging Technology*, 3rd edn., Yam K.L. (Ed.). New York: John Wiley & Sons, pp. 1089–1096.
- Nairn J.F., Norpell T.M. 2009. Closures, Bottle and Jar. In: *The Wiley Encyclopedia of Packaging Technology*, 3rd edn., Yam K.L. (Ed.), New York: John Wiley & Sons, pp. 269–284.
- Pereira H. 2007. *Cork: Biology, Production and Uses*, Oxford, England: Elsevier, pp. 274–288.
- Pitman K. 1999. Closures for beverage packaging. In: *Handbook of Beverage Packaging*, Giles G.A. (Ed.). Boca Raton, FL: CRC Press, pp. 207–246.
- Reeves M.J. 2010. Packaging and the shelf life of wine. In: *Food Packaging and Shelf Life: A Practical Guide*, Robertson G.L. (Ed.), Boca Raton, FL: CRC Press, pp. 231–257.
- Song Y.S. 2009. High-voltage leak detection (HVLD) technique for hermetically sealed packages. In: *The Wiley Encyclopedia of Packaging Technology*, 3rd edn., Yam K.L. (Ed.), New York: John Wiley & Sons, pp. 573–575.
- Stelzer T. 2005. *Taming the Screw: A Manual for Winemaking with Screw Caps*, Brisbane, Queensland, Australia: Wine Press.
- Theller H.W. 1989. Heat sealability of flexible web materials in hot-bar sealing applications. *Journal of Plastic Film and Sheeting* 5: 66–93.
- Theobald N., Winder B. (Eds). 2006. *Packaging Closures and Sealing Systems*, Boca Raton, FL: CRC Press.
- Waterhouse A.L., Elias R.J. 2010. Chemical and physical deterioration of wine. In: *Chemical Deterioration and Physical Instability of Food and Beverages*, Skibsted L.H., Risbo J., Andersen M.L. (Eds). Boca Raton, FL: CRC Press, pp. 466–482.
- Yoxall A., Janson R. 2008. Fact or friction: A model for understanding the openability of wide-mouth closures. *Packaging Technology and Science* 23: 137–147.
- Yoxall A., Janson R., Bradbury S.R., Langley J., Wearn J. 2006. Openability: Producing design limits for consumer packaging. *Packaging Technology and Science* 19: 219–225.
- Yoxall A., Langley J., Janson R., Lewis R., Wearn J., Hayes S.A., Bix L. 2010a. How wide do you want the jar?: The effect on diameter for ease of opening for wide-mouth closures. *Packaging Technology and Science* 23: 11–18.
- Yoxall A., Langley J., Luxmoore J., Janson R., Taylor J.C., Rowson J. 2010b. Understanding the use of tools for opening packaging. *Universal Access in the Information Society* 9: 273–281.