

ALLOSTERIC ENZYMES

Allosteric enzymes: Binding of ligands to proteins - Co-operativity, the Hill equation, equilibrium dialysis technique. **Sigmoidal kinetics:** The MWC and KNF models. Significance of sigmoidal behaviour. Allosteric enzymes and metabolic regulation. Study of ATCase- as typical allosteric enzyme.

8 Hr

INTRODUCTION

Enzymes:

Enzymes may be defined as biocatalysts synthesized by living cells. They are protein in nature, colloidal and thermolabile in character and specific in their action. They are known as catalyst of life. They accelerate the rate of reaction.

Berzelius in 1836 coined the term catalysis.

In 1878, **Kuhne** used the word enzyme to indicate to indicate the catalysis taking place in the biological systems.

Allosteric Enzyme:

Some of the enzymes possess additional sites, known as allosteric sites (Greek; allo-other) besides the active site. Such enzymes are known as allosteric enzyme. The allosteric sites are unique places on the enzyme molecules; allosteric enzymes have one or more allosteric site.

History

The term allosteric has been introduced by the two Noble laureates, *MONOD AND JACOB*, to denote an enzyme site, different from the active site, which non competitively binds molecule other than the substrate and may influence the enzyme activity.

PROPERTIES OF ALLOSTERIC ENZYME

- Allosteric enzyme have one or more allosteric sites
- Allosteric sites are binding sites distinct from an enzyme active site or substrate binding site
- Molecule that bind to allosteric sites are called effector or modulator
- Effector may be positive or negative, this effector regulate the enzyme activity. The enzyme activity is increased when a positive allosteric effector binds at the allosteric site known as activator site. On the other hand, negative allosteric effector bind at the allosteric site called inhibitor site and inhibit the enzyme activity.
- Binding to allosteric sites alter the activity of the enzyme, this is called cooperative binding. Allosteric enzymes display sigmoidal plot of V_0 vs $[S]$.

KINETIC PROPERTY OF ALLOSTERIC ENZYME

According to the term of conformational changes:-

- Most of the allosteric enzymes are oligomeric in nature, the subunit may be identical or different. The non-covalent reversible binding of the effector molecule at the allosteric sites brings about a conformational change in the active site of the enzyme, leading to the inhibition or activation of the catalytic activity.

MODEL OF ALLOSTERIC REGULATION

Two main model have been proposed to describe the mechnastic basis of enzyme allostery:

- *Concerted model* : Given by MONOD, WYMAN AND CHANGEUX.
- *Sequential model*: Given by KOSHLAND, NEMETHY AND ALLOUS

Why Sigmoid Curve:

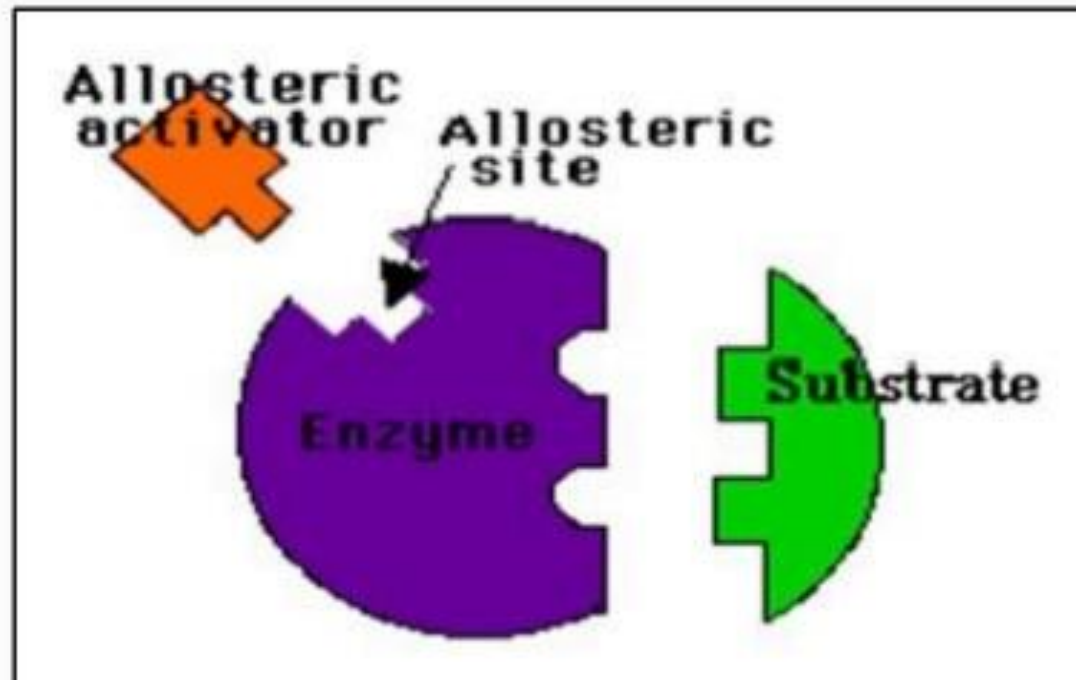

ALLOSTERIC EFFECTOR

It has been suggested that allosteric effectors are:

- *Positive allosteric effector.*
- *Negative allosteric effector.*

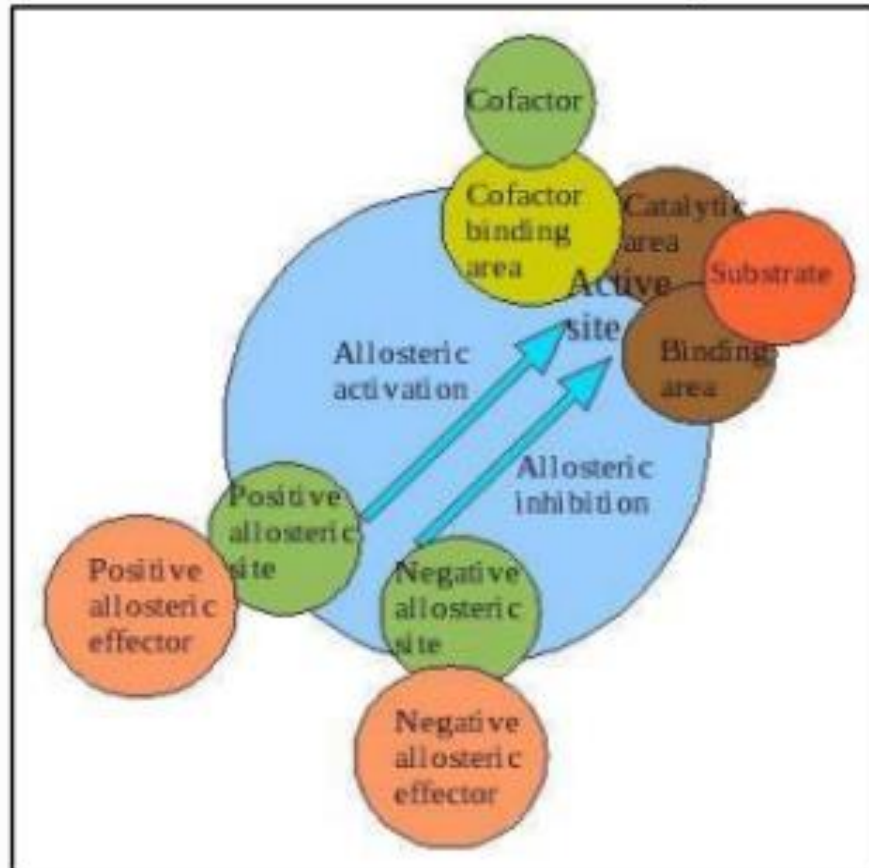

Fig: Allosteric modulation of an enzyme

Regulatory Enzymes

Reversible non-covalent
modification:

Allosteric Regulation

Allosteric
activation

Allosteric
Inhibition

Reversible covalent
modification

Adenylation

Uridylation

ADP-
Ribosylation

Phosphorylation

Methylation

Regulatory Enzyme

- Why we are curious about enzyme regulation???????
- Most metabolic reactions are multi-step cascade processes.
- In each enzyme system there is at least one enzyme that sets the rate of the overall sequence because it catalyzes the rate limiting reaction.

Regulatory Enzyme

- These regulatory enzymes exhibit increased or decreased catalytic activity in response to certain signals.

Allosteric Enzymes

- **Allosteric enzymes** are a class of Regulatory enzymes.
- **Definition:** A type of enzyme regulation by the reversible non-covalent binding of regulatory molecules to the enzyme.
- Regulatory molecules are called **allosteric modulators** or **allosteric effectors** .
- Allosteric enzyme has **additional conformations** induced by the binding of modulators.
- Conformational changes induced by the allosteric modulators can produce **more active** or **less active** forms of enzyme.

Cont'd

- Allosteric modulators may be **inhibitory** or **stimulatory**.
- Two types of Allosteric enzymes based on the nature of modulator:
 - Homotropic Allosteric Enzymes
 - Hetrotropic Allosteric Enzymes
- In most cases, the **substrate** itself act as the modulator
- Allosteric enzymes having the substrate and modulators are the same are called **homotropic allosteric enzymes**
- Binding of modulator causes conformational changes in the enzyme.

Feedback inhibition

- Feedback inhibition is a specific type of allosteric enzymatic activity regulation mechanism in the cells.
- **Definition:** in some multi enzyme pathways, the regulatory enzyme is specifically inhibited by the end product of the pathway whenever the concentration of the end product exceeds the cells requirements.



ALLOSTERIC INHIBITION

Heterotropic Inhibition: The effector may be different from the substrate, in this case effector is said to be heterotropic effector. For example the feedback mechanism.

•Feed back inhibition

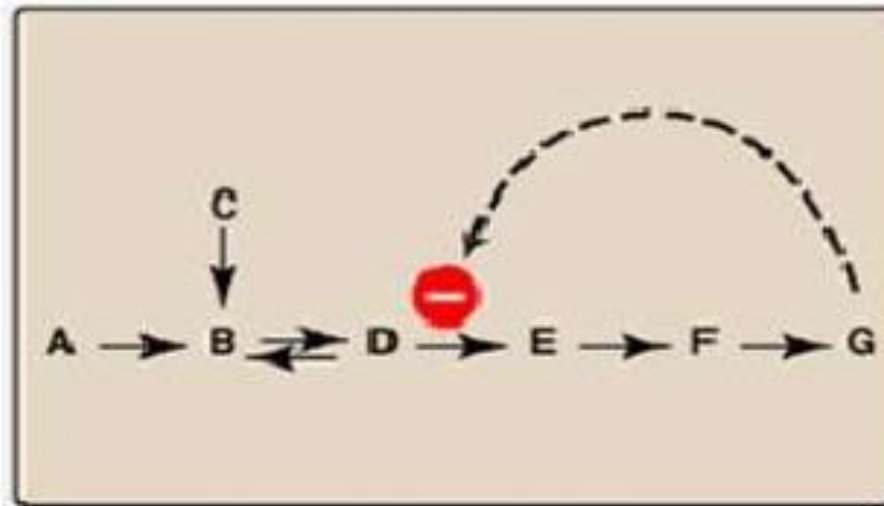

Fig: Feedback inhibition of a metabolic pathway.

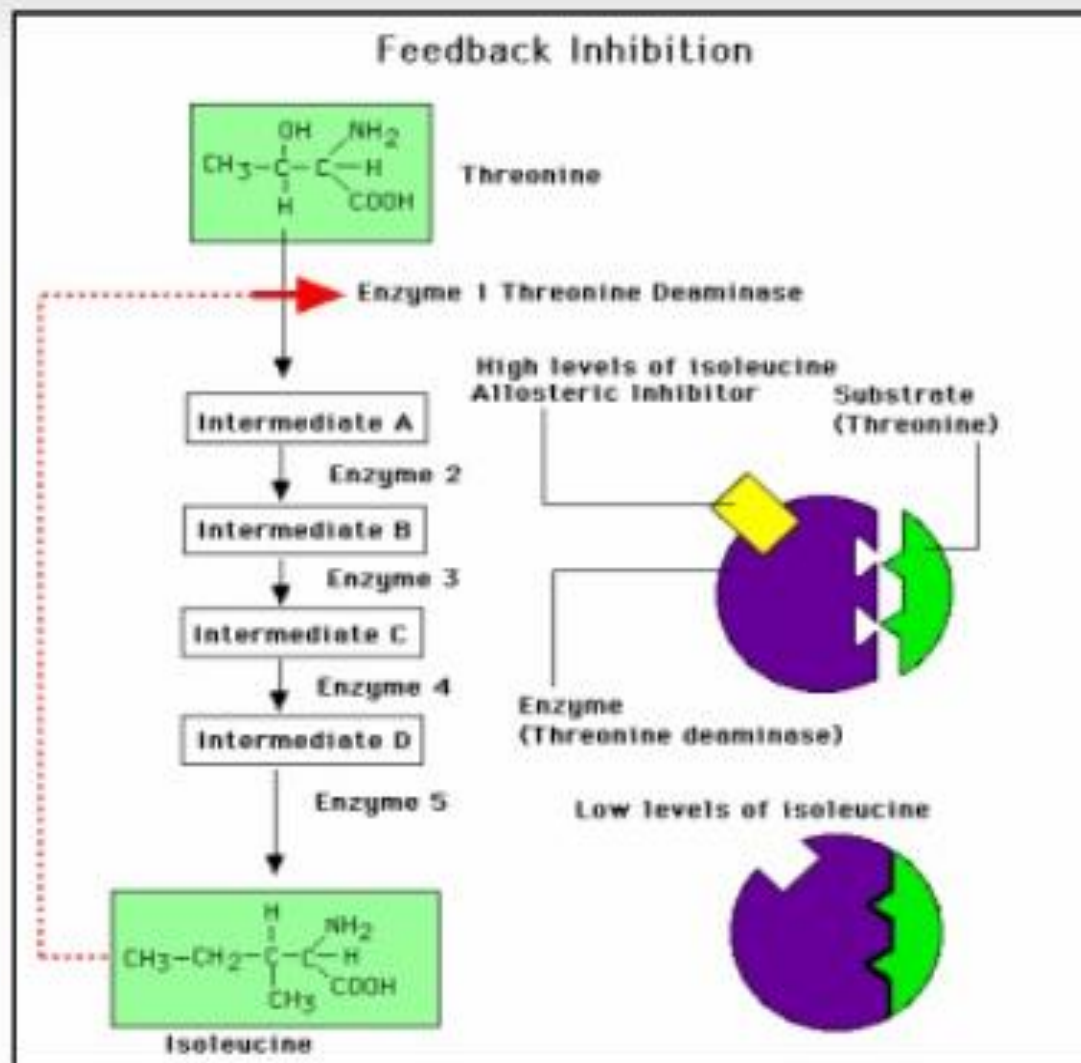
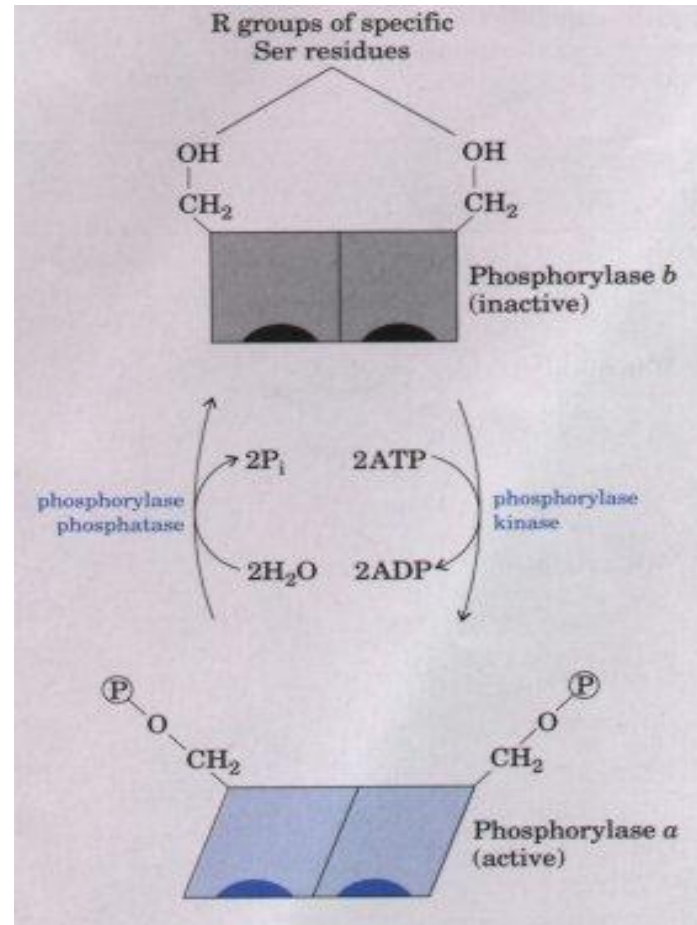
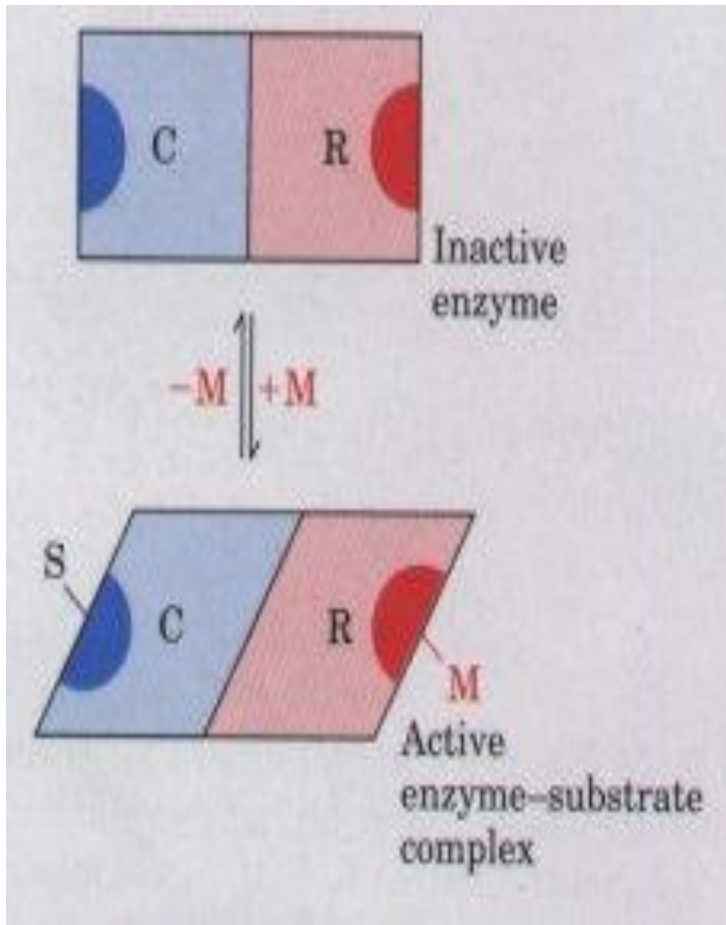

Fig: Example of Feedback Inhibition



SIGMOID CURVE OF ALLOSTERIC ENZYME:

Allosteric Enzyme Kinetics: Sigmoid Curve instead of Hyperbola.

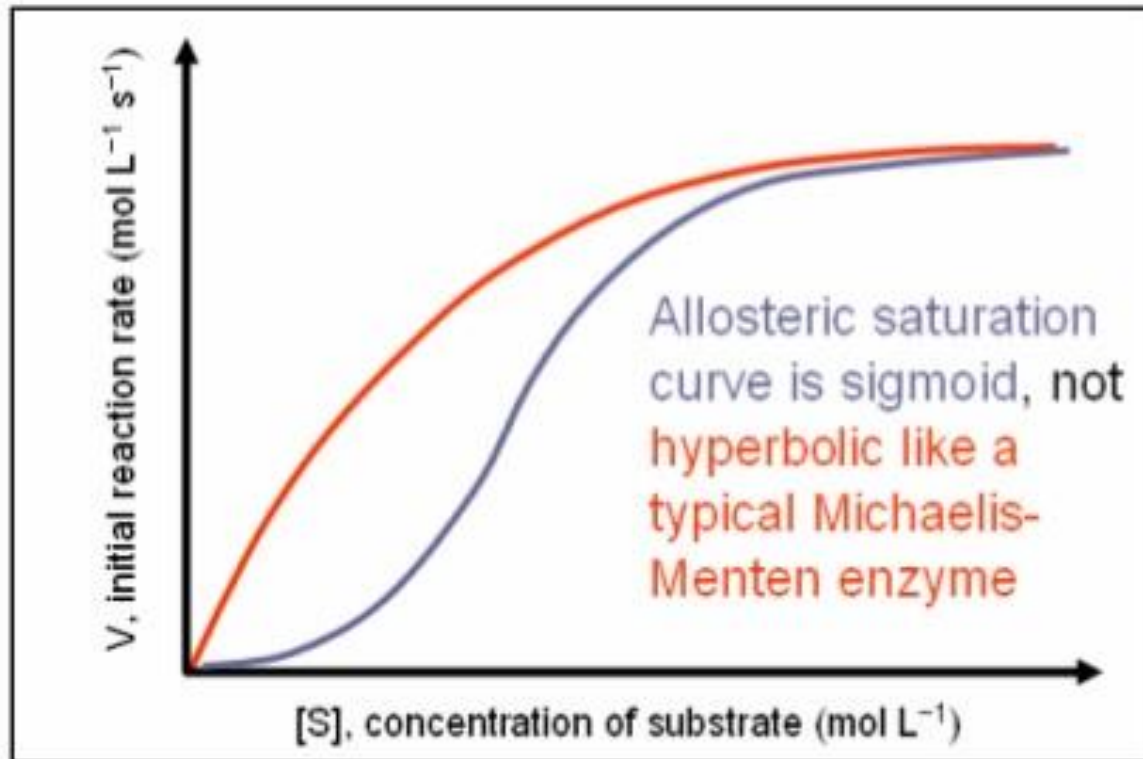
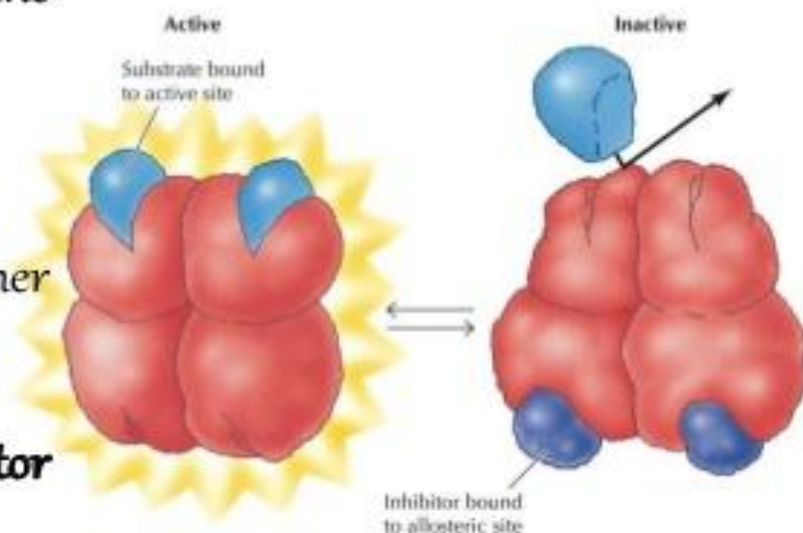
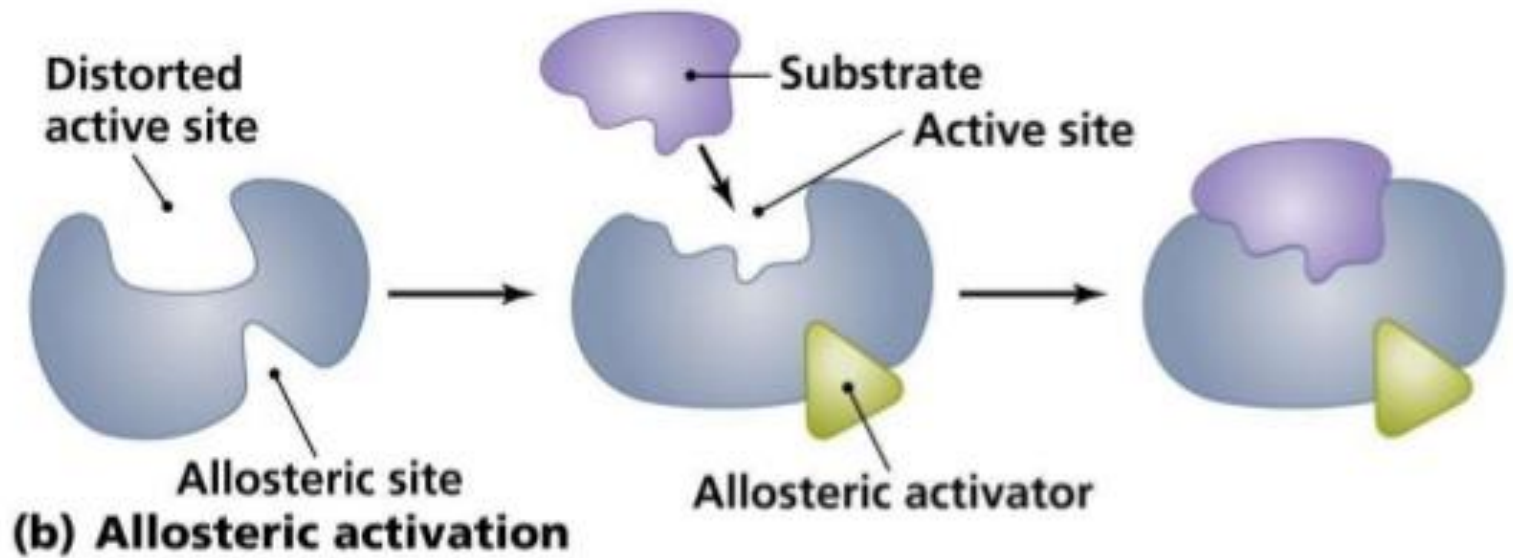
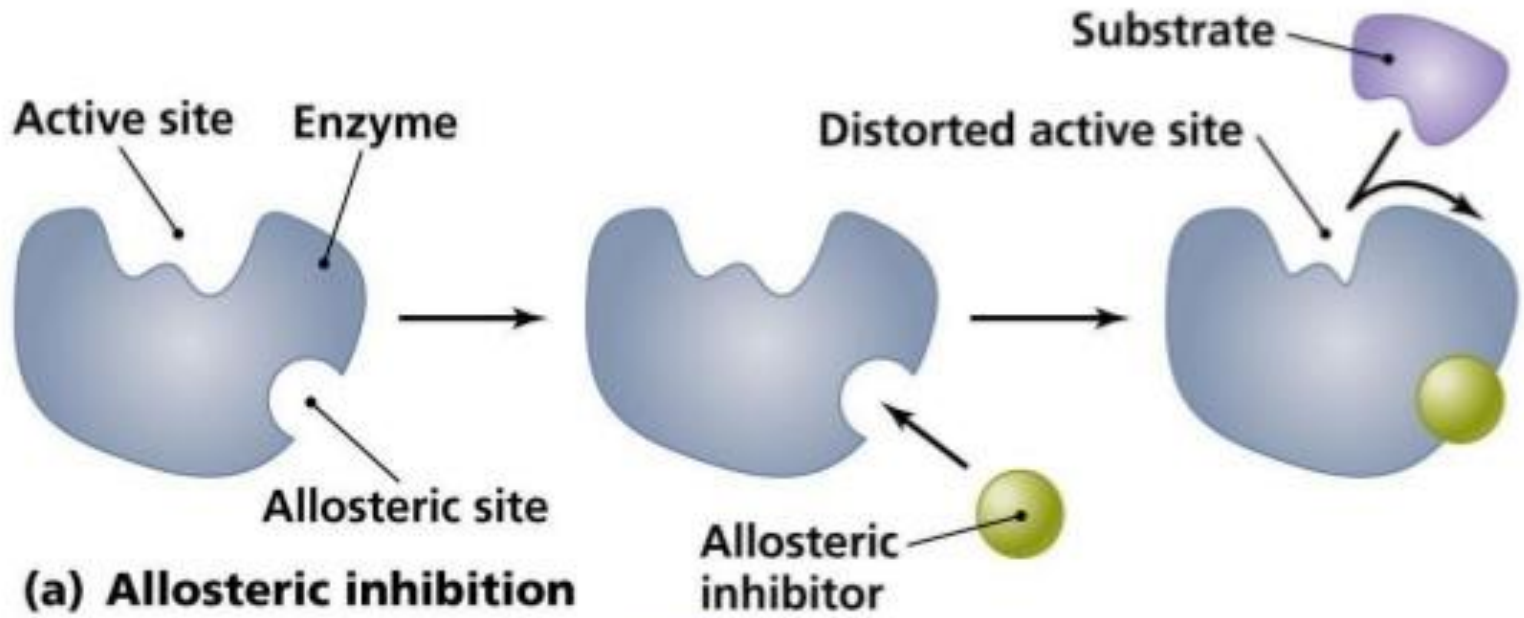

Figure: Sigmoid Curve Of Allosteric Enzyme (Initial Reaction Rate Vs. Concentration Of Substrate)

Allosteric Enzymes

- **Allosteric enzymes** are those having "**other shapes**" or conformations induced by the binding of modulators.
- These enzymes have **two receptor sites**.
- One site fits the **substrate** like other enzymes.
- The other site fits an **inhibitor or activator molecule**.
- Allosteric enzymes are very important in **feedback regulation**.





Allosteric Inhibition

Allosteric inhibition is a class of enzyme inhibition in which an allosteric inhibitor inhibits enzyme activity by binding to the allosteric site of the enzyme.

ATCase as a catalyst

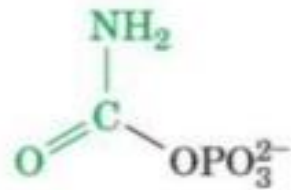

Carbamoyl phosphate

+

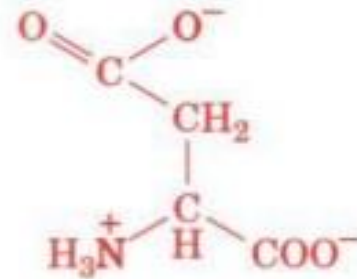

Aspartate

↓ aspartate
transcarbamoylase

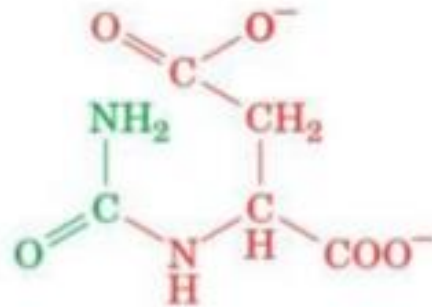

N-Carbamoylaspartate

+



- Allosteric enzymes show **relationships** between V_o and $[S]$ that **differ** from normal **Michaelis-Menten behavior**.
- They exhibit **saturation** with the **substrate** when $[S]$ is sufficiently **high**.
- When V_o is plotted against $[S]$ a **sigmoid saturation curve** results.
- The symbol $[S]_{0.5}$ or $K_{0.5}$ is used to represent the substrate concentration giving half maximal velocity.

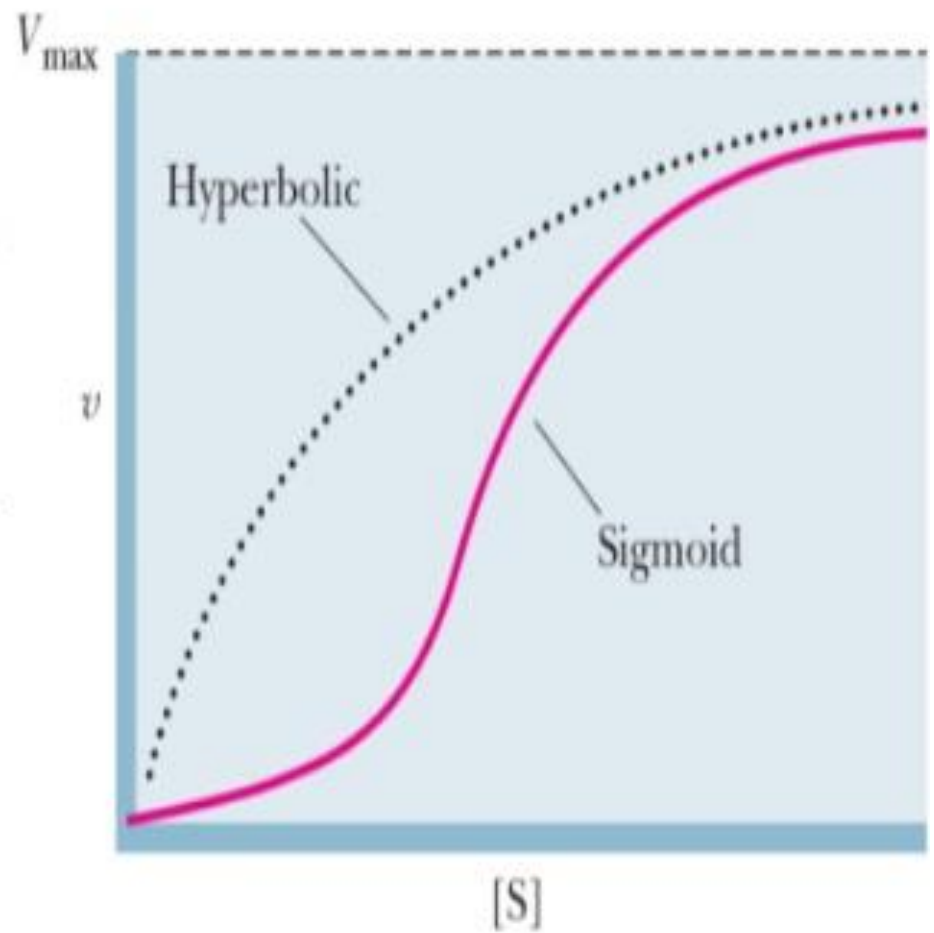

- **Sigmoid kinetic behavior** generally reflects **cooperative interactions** between multiple protein subunits.
- The principles are similar to those for **cooperativity** in **oxygen binding** to the non-enzyme **protein hemoglobin**.
- The **substrate** can function as a positive modulator (an **activator**) because the subunits act cooperatively.
- The **binding** of **one molecule** of the substrate to one binding site greatly **enhances** the **binding** of **subsequent substrate molecules**.

- The sigmoidal dependence of V_o on $[S]$ reflects subunit cooperativity, and has inspired two models to explain these cooperative interactions.
- In the concerted (symmetry model), proposed by **Jacques Monod** and colleagues in **1965**, an allosteric enzyme can exist in only **two conformations**, active and inactive
- All subunits are in the active form or all are inactive.
- In the **second model (the sequential model)**, proposed by **Koshland** in **1966**, there are still two conformations, but subunits can undergo the conformational change individually.
- Binding of substrate increases the probability of the conformational change.

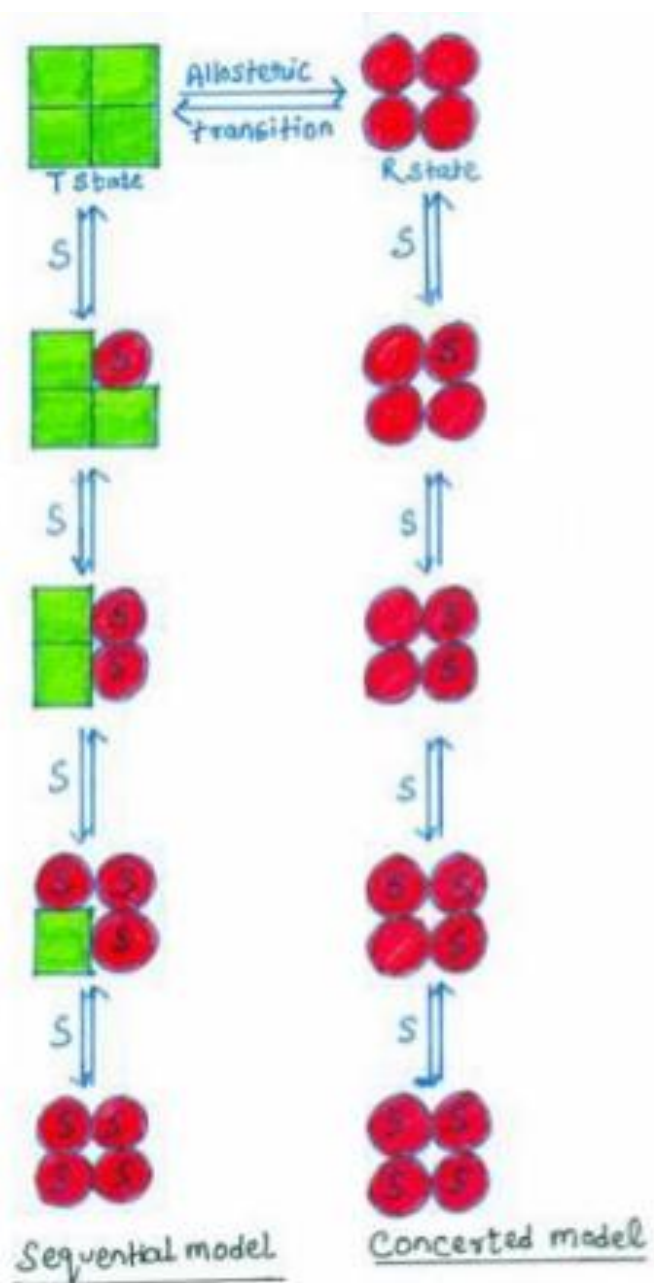

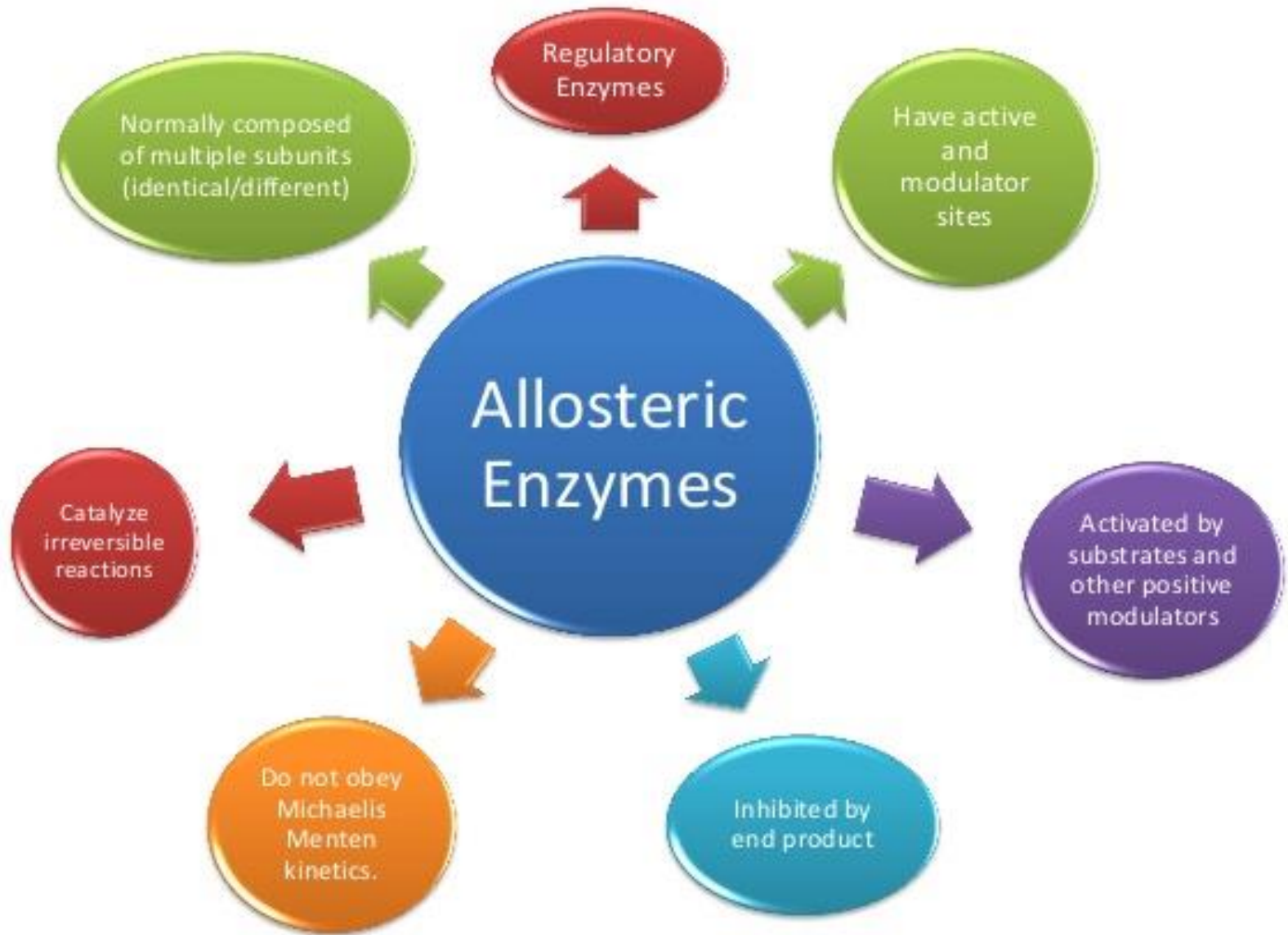

ATCase as an allosteric enzyme

- ✓ **Aspartate transcarbamoylase (ATCase)** is an **allosteric enzyme** which has **12 polypeptide chains** organized into catalytic and regulatory subunits.
- ✓ The enzyme catalyzes the first step in the **synthesis of pyrimidines**.
- ✓ The enzyme functions to catalyze the **condensation** of **aspartate** and **carbamoyl phosphate** to form **N-carbamoylaspartate** and **orthophosphate**.
- ✓ The enzyme ultimately catalyzes the reaction that will yield **cytidine triphosphate (CTP)**.
- ✓ This allosteric enzyme is unique in that for **high concentration** of the final product **CTP**, the enzyme **activity** is **low**.
- ✓ However, for **low concentrations** of the final product **CTP**, the enzymatic activity is **high**.

(A)

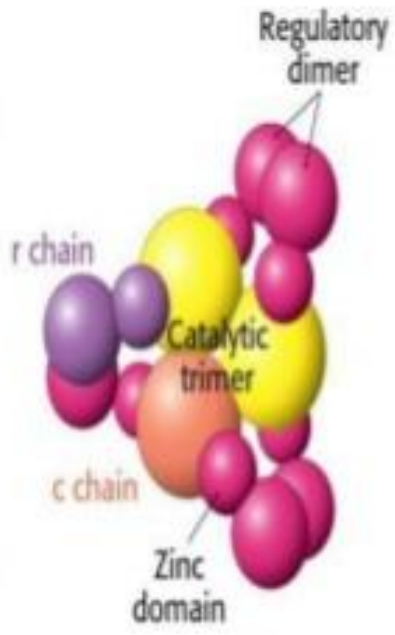
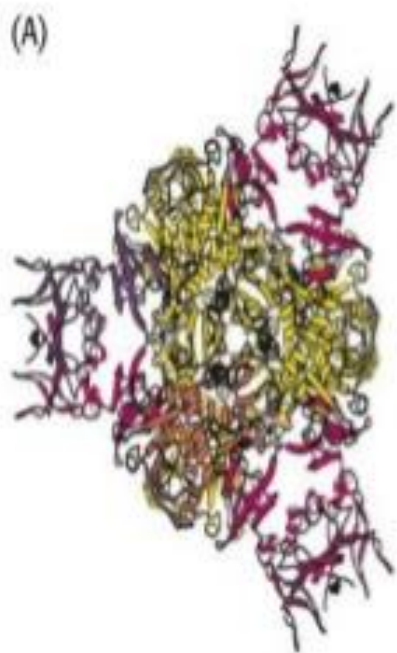

Carbamoyl phosphate
+
Aspartate

ATCase

N-Carbamoyl aspartate

I
N
H
I
B
I
T
I
O
N

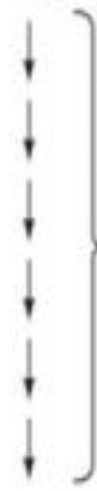

6 enzymatic
reaction steps

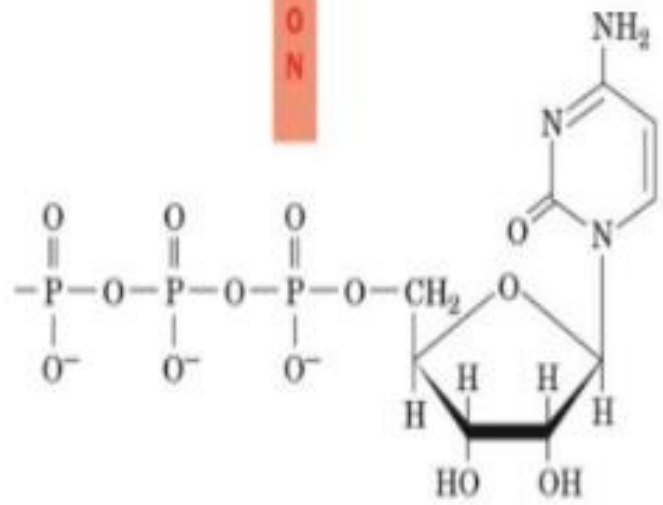

Cytidine triphosphate (CTP)

(a) Inactive T state

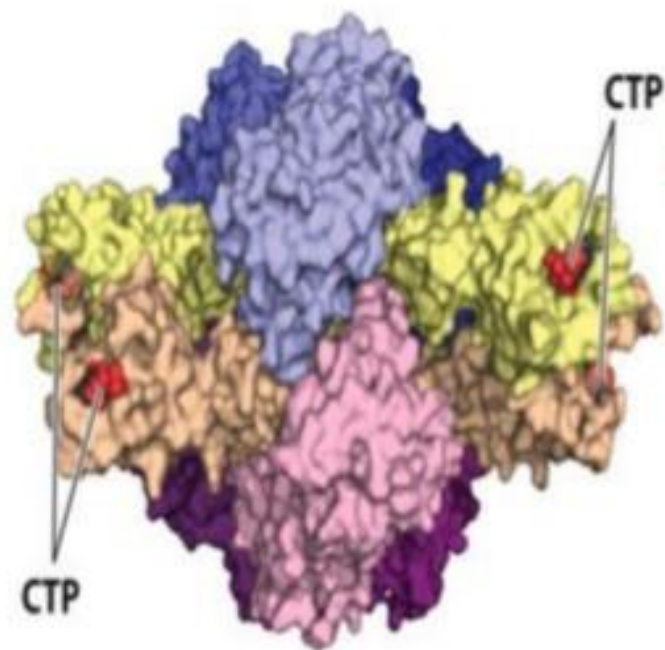

(b) Active R state

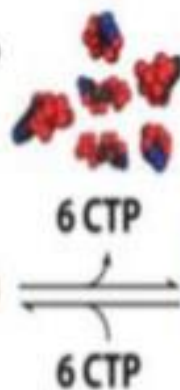
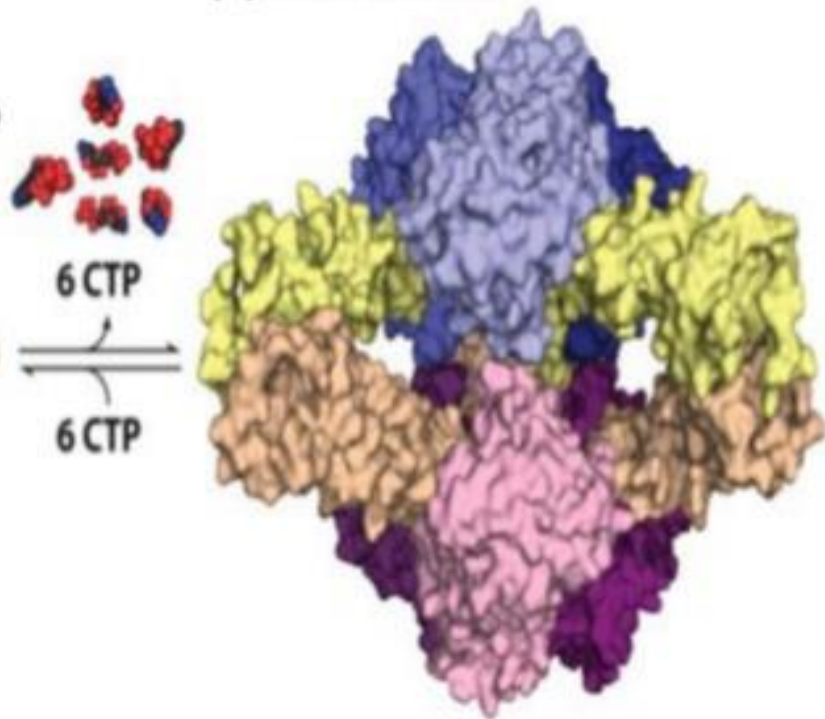

Effect of ATP and CTP on ATCase

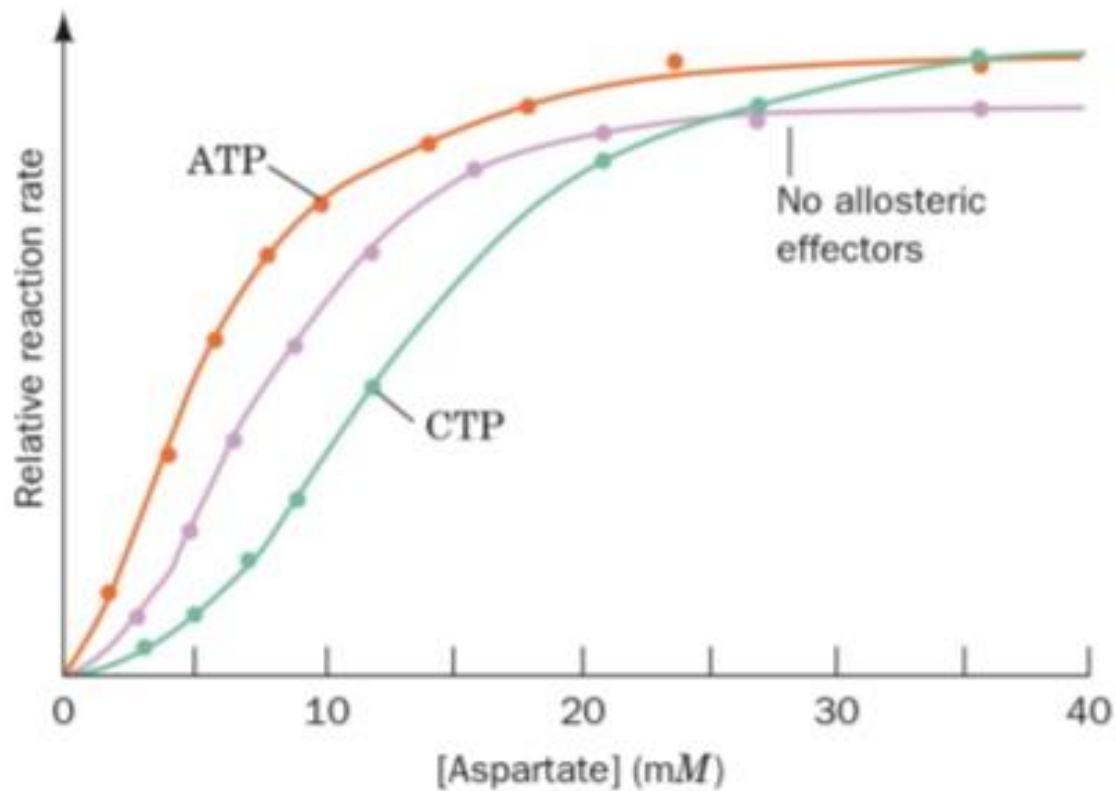

PALA and ATCase

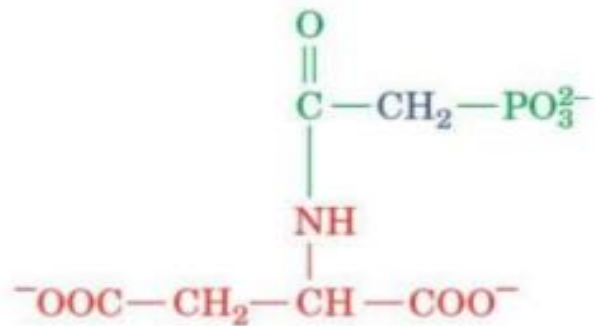

**N-(Phosphonacetyl)-
L-aspartate (PALA)**

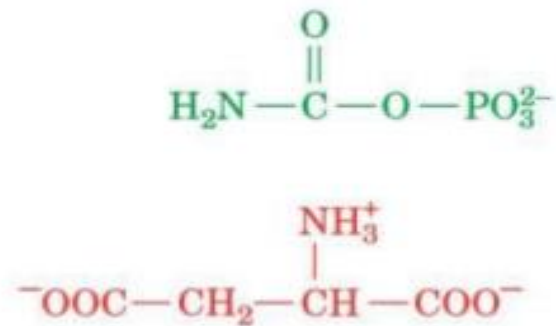

**Carbamoyl phosphate
+
Aspartate**

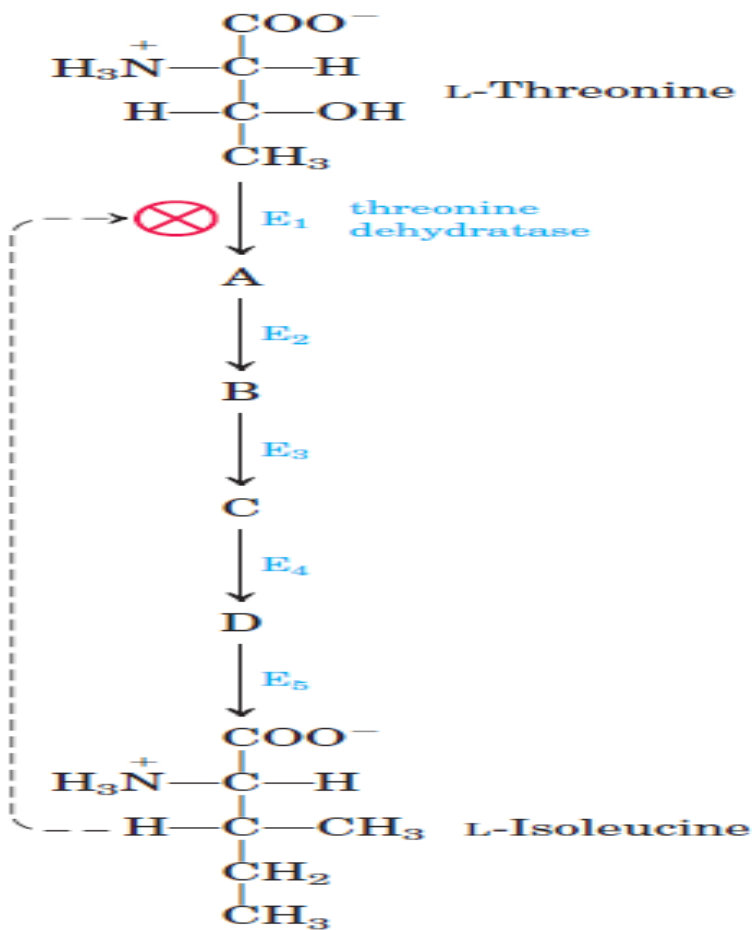
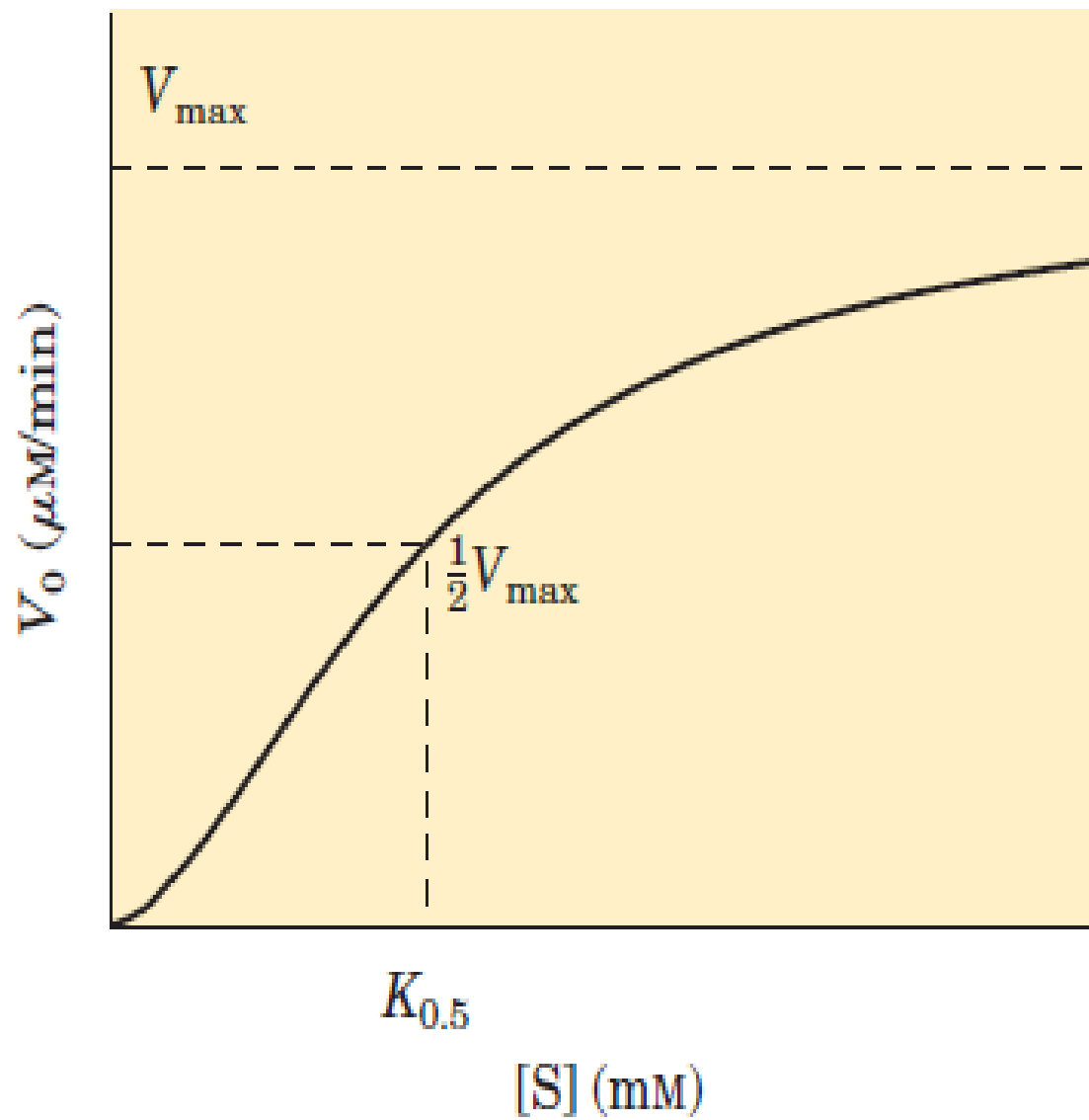
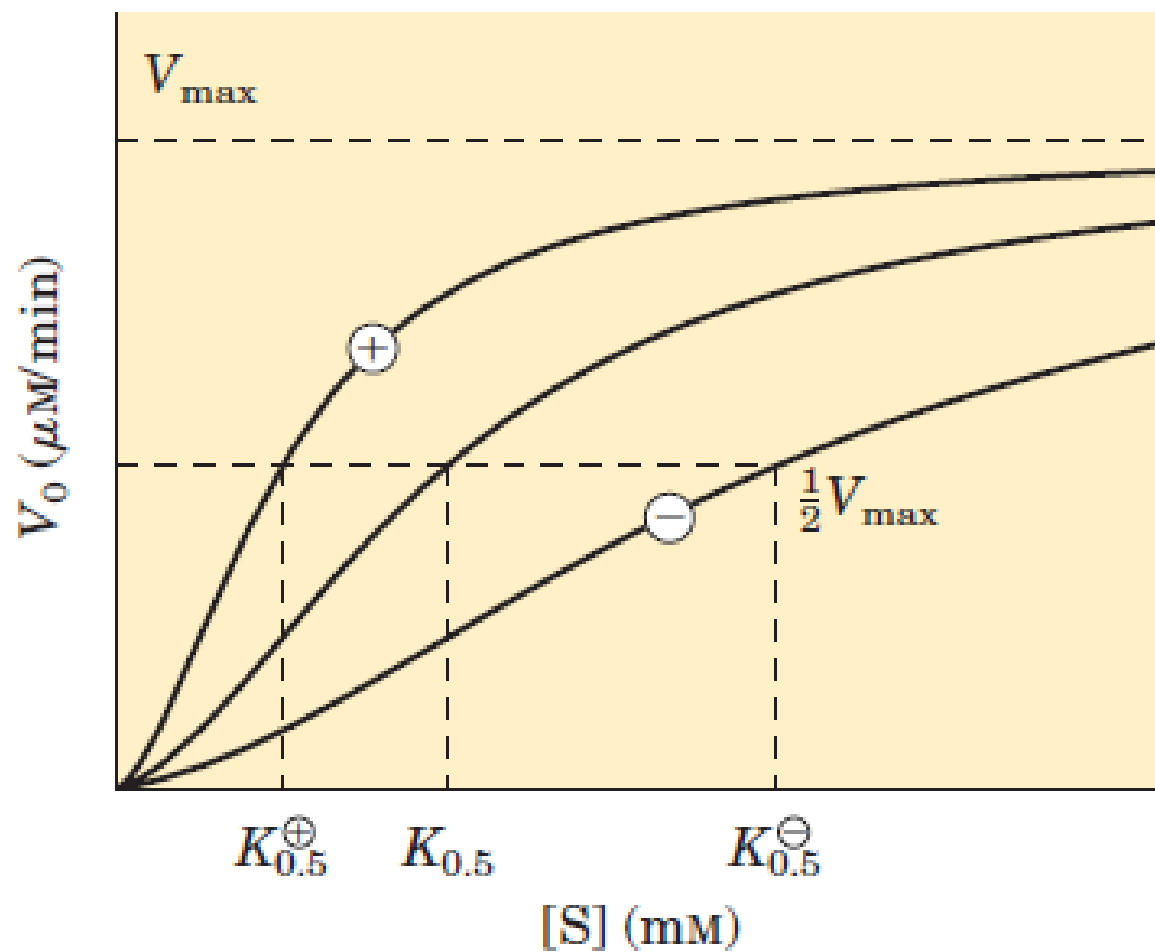

FIGURE 6-28 Feedback inhibition. The conversion of L-threonine to L-isoleucine is catalyzed by a sequence of five enzymes (E₁ to E₅). Threonine dehydratase (E₁) is specifically inhibited allosterically by L-isoleucine, the end product of the sequence, but not by any of the four intermediates (A to D). Feedback inhibition is indicated by the dashed feedback line and the ⊗ symbol at the threonine dehydratase reaction arrow, a device used throughout this book.

(a)



(b)



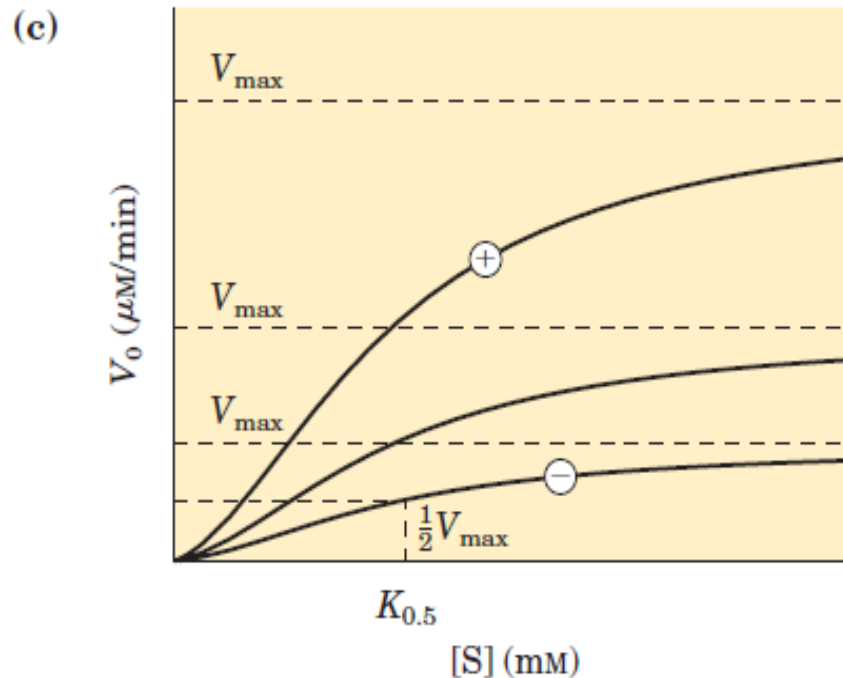

FIGURE 6-29 Substrate-activity curves for representative allosteric enzymes. Three examples of complex responses of allosteric enzymes to their modulators. (a) The sigmoid curve of a homotropic enzyme, in which the substrate also serves as a positive (stimulatory) modulator, or activator. Note the resemblance to the oxygen-saturation curve of hemoglobin (see Fig. 5-12). (b) The effects of a positive modulator (+) and a negative modulator (-) on an allosteric enzyme in which $K_{0.5}$ is altered without a change in V_{max} . The central curve shows the substrate-activity relationship without a modulator. (c) A less common type of modulation, in which V_{max} is altered and $K_{0.5}$ is nearly constant.

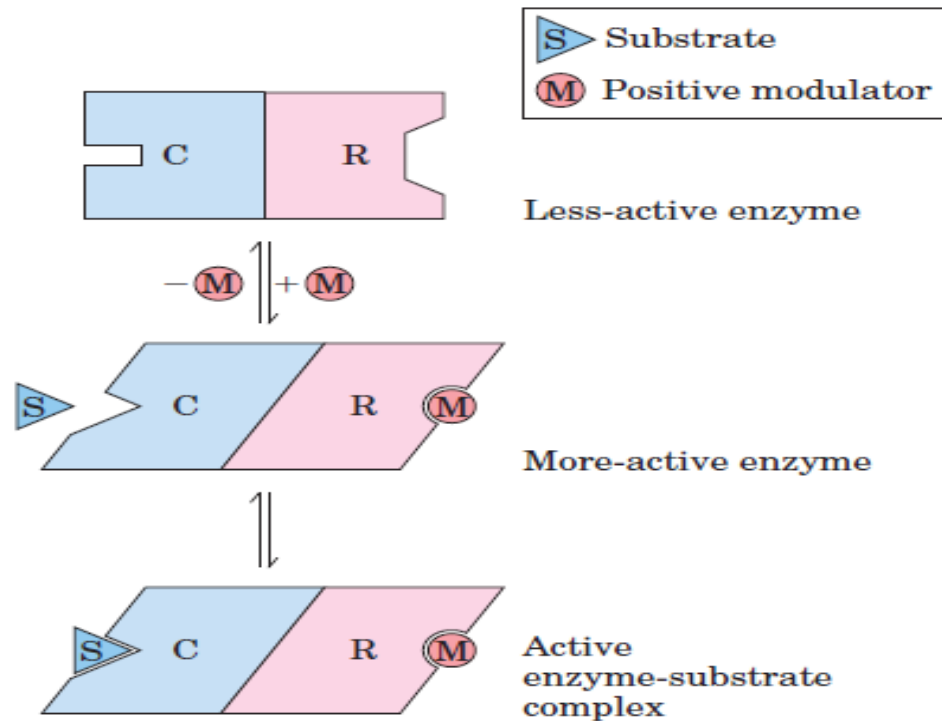

FIGURE 6-26 Subunit interactions in an allosteric enzyme, and interactions with inhibitors and activators. In many allosteric enzymes the substrate binding site and the modulator binding site(s) are on different subunits, the catalytic (C) and regulatory (R) subunits, respectively. Binding of the positive (stimulatory) modulator (M) to its specific site on the regulatory subunit is communicated to the catalytic subunit through a conformational change. This change renders the catalytic subunit active and capable of binding the substrate (S) with higher affinity. On dissociation of the modulator from the regulatory subunit, the enzyme reverts to its inactive or less active form.

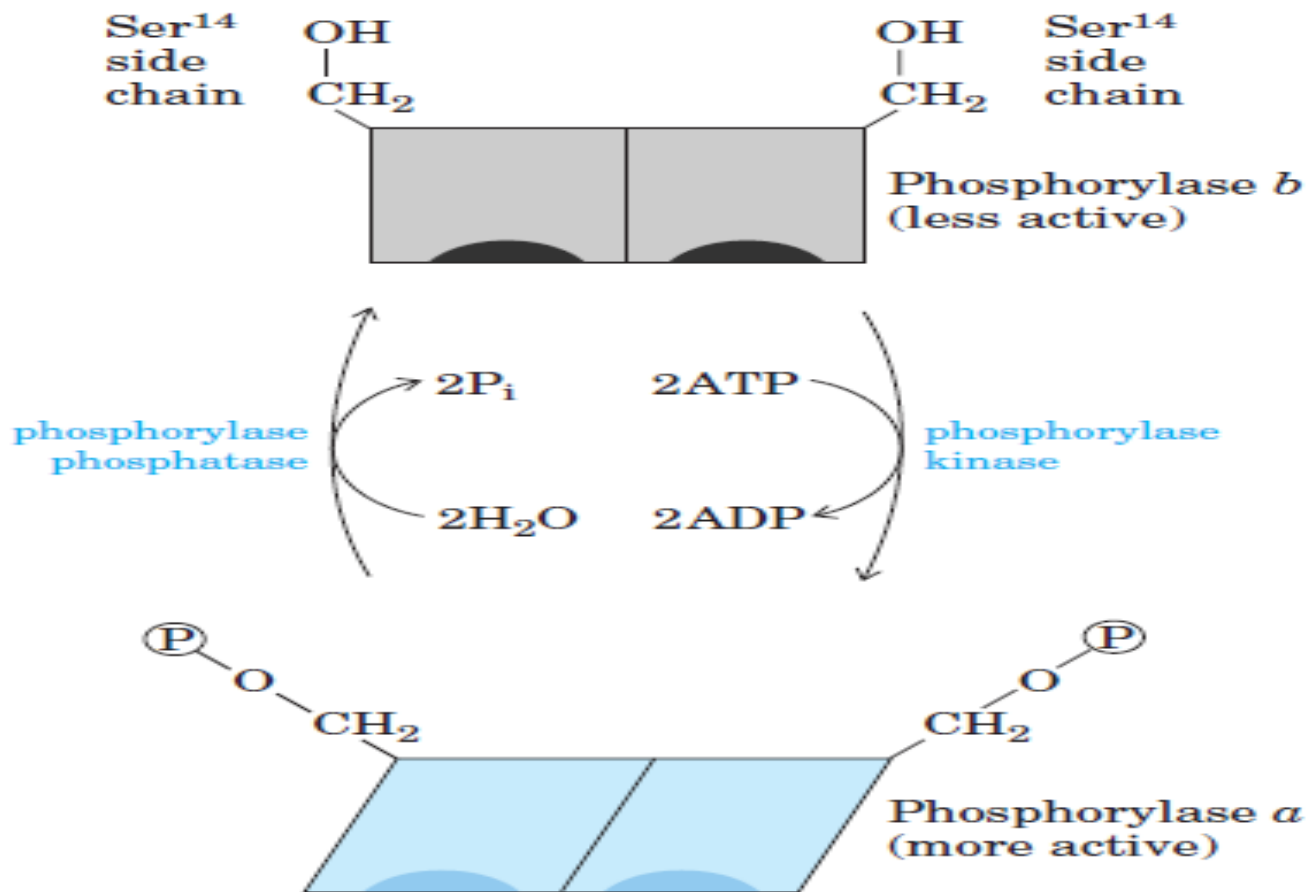

FIGURE 6-31 Regulation of glycogen phosphorylase activity by covalent modification. In the more active form of the enzyme, phosphorylase *a*, specific Ser residues, one on each subunit, are phosphorylated. Phosphorylase *a* is converted to the less active phosphorylase *b* by enzymatic loss of these phosphoryl groups, promoted by phosphorylase phosphatase. Phosphorylase *b* can be reconverted (reactivated) to phosphorylase *a* by the action of phosphorylase kinase.

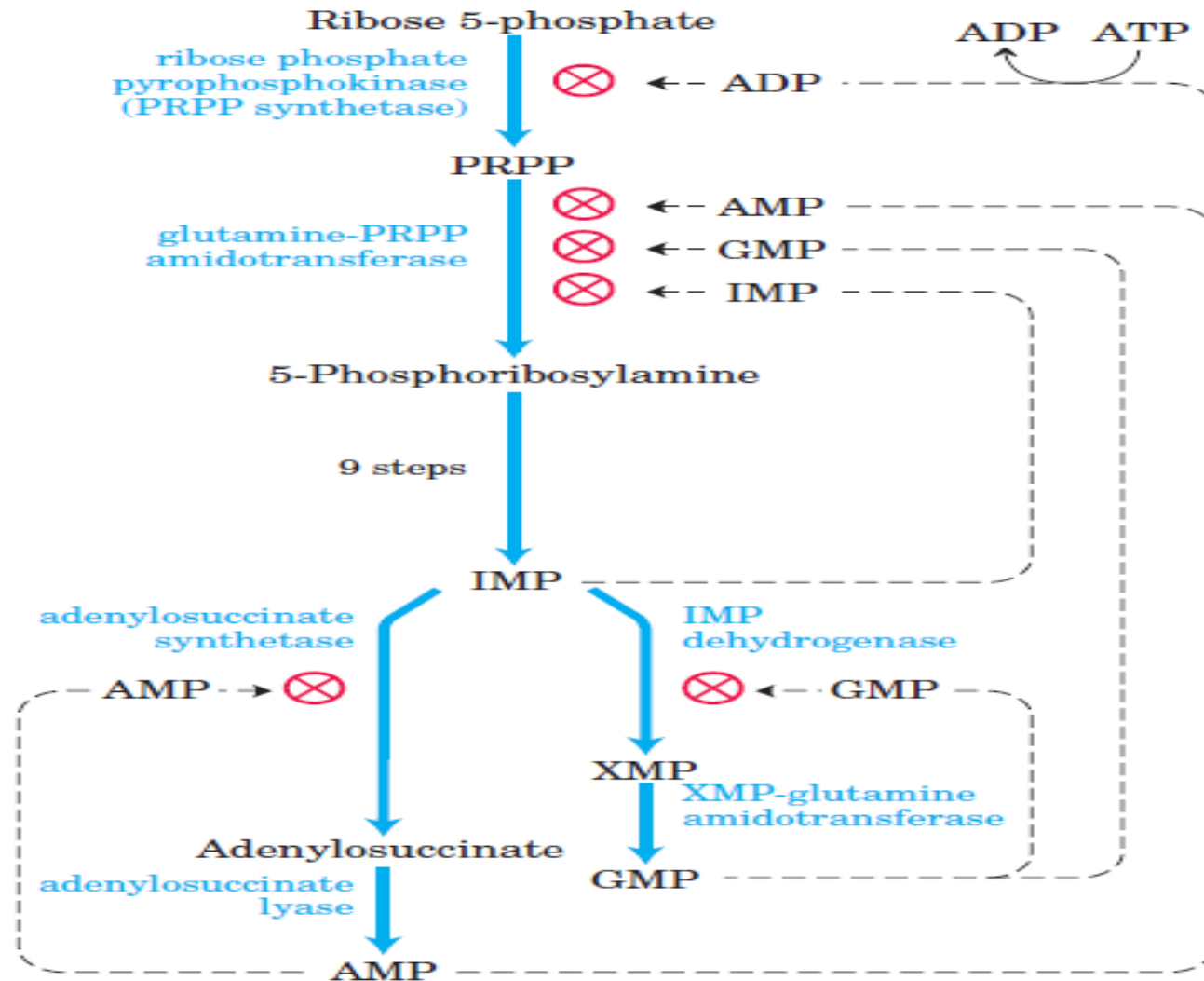
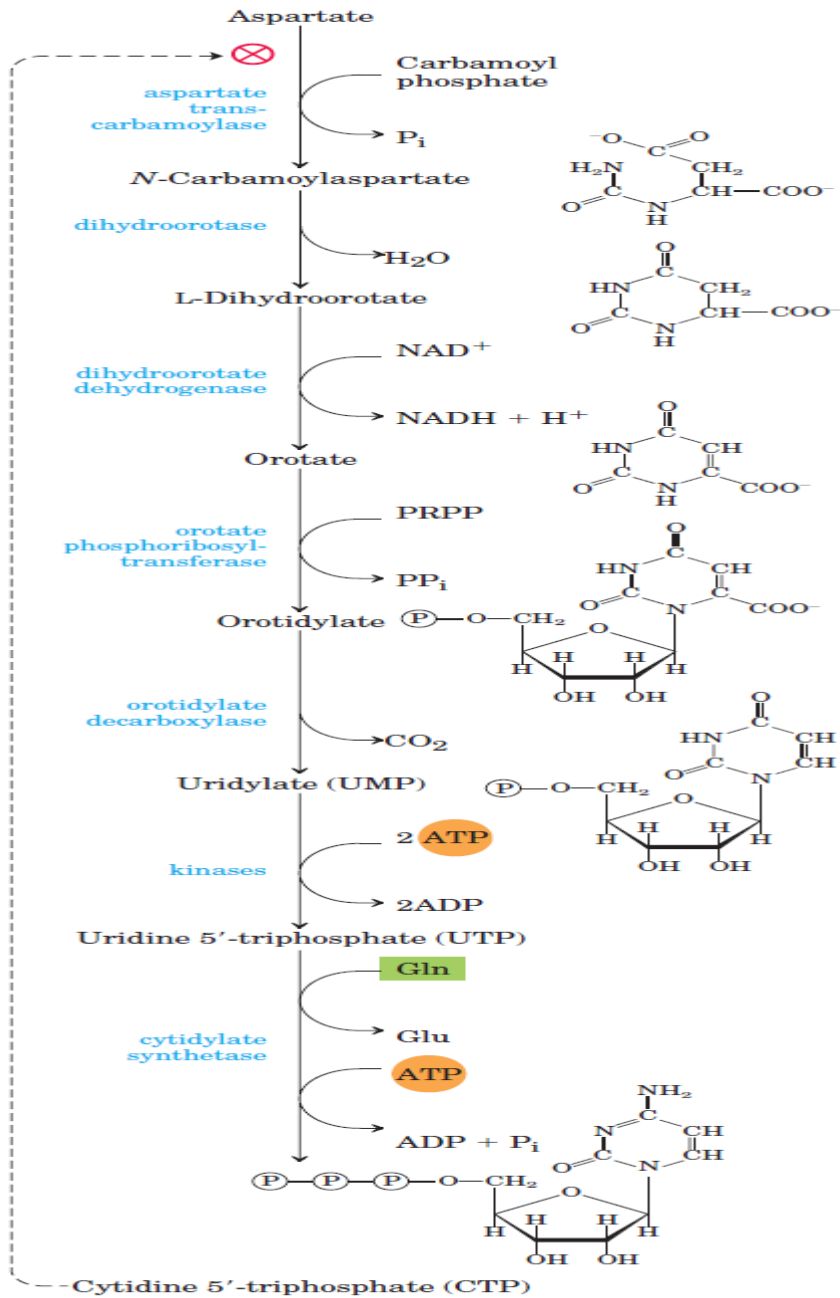

FIGURE 22-35 Regulatory mechanisms in the biosynthesis of adenine and guanine nucleotides in *E. coli*. Regulation of these pathways differs in other organisms.



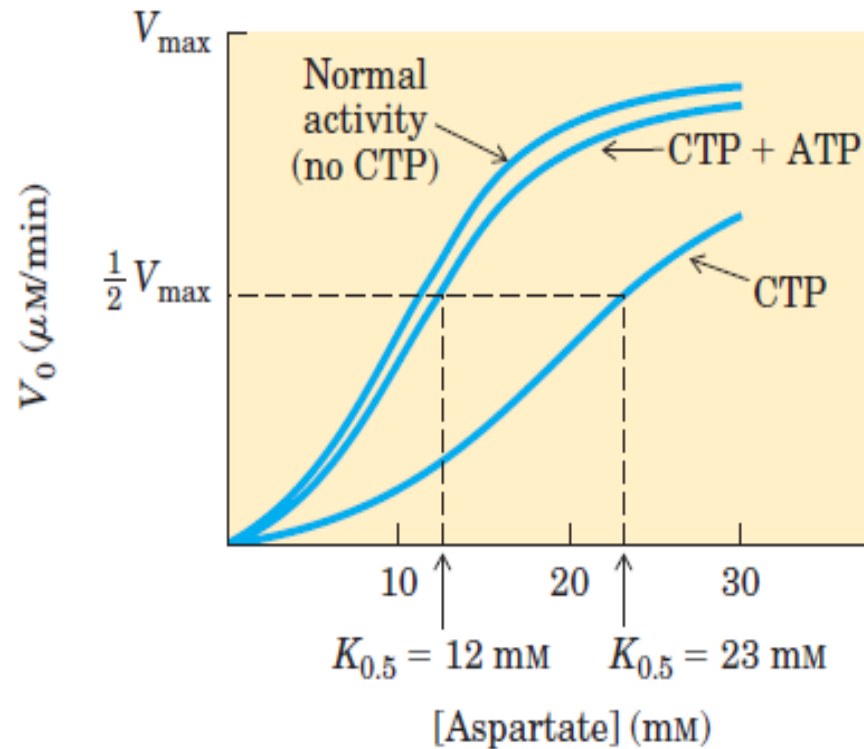
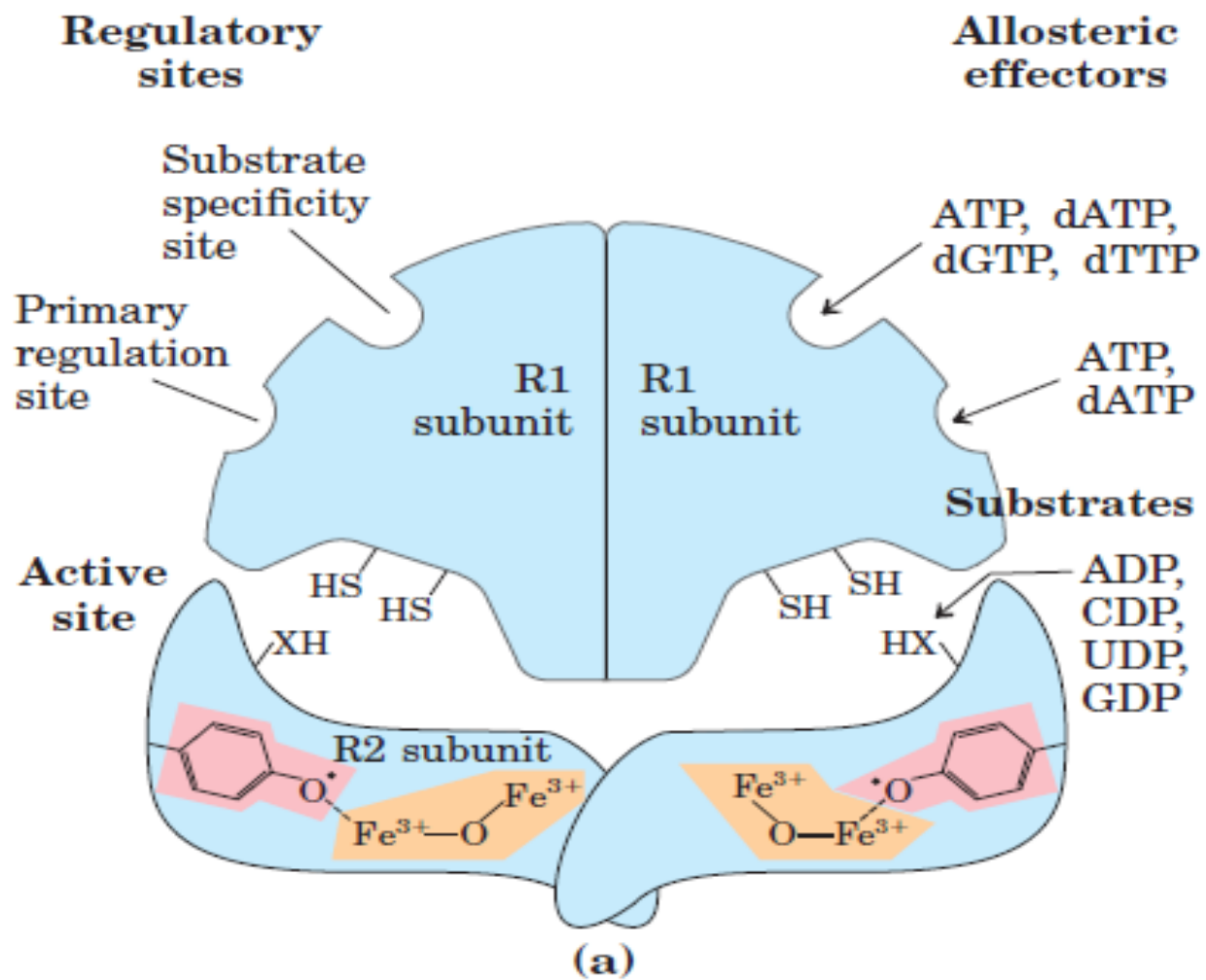

FIGURE 22-38 Allosteric regulation of aspartate transcarbamoylase by CTP and ATP. Addition of 0.8 mM CTP, the allosteric inhibitor of ATCase, increases the $K_{0.5}$ for aspartate (lower curve) and the rate of conversion of aspartate to *N*-carbamoylaspartate. ATP at 0.6 mM fully reverses this effect (middle curve).



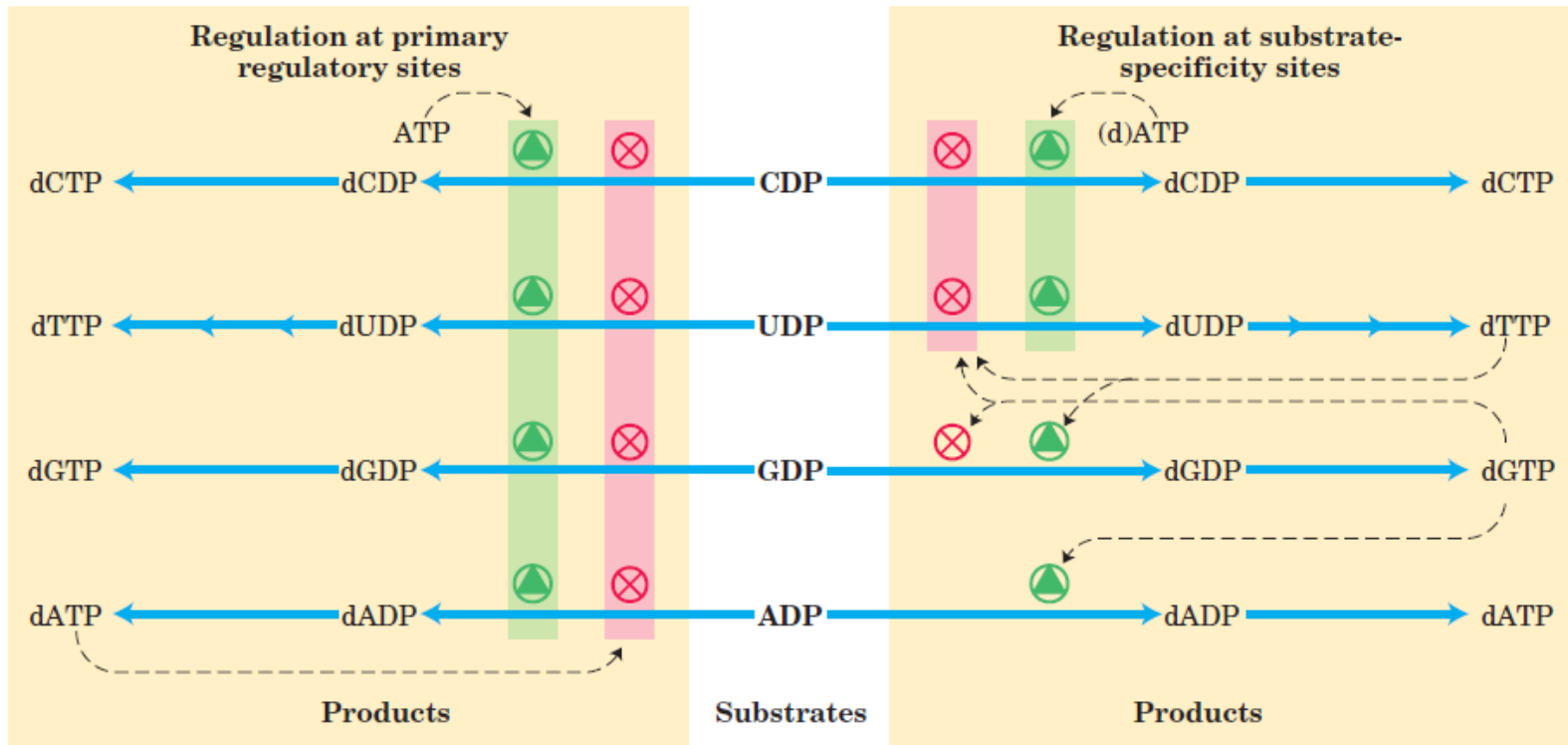

FIGURE 22-42 Regulation of ribonucleotide reductase by deoxynucleoside triphosphates. The overall activity of the enzyme is affected by binding at the primary regulatory site (left). The substrate specificity of the enzyme is affected by the nature of the effector molecule bound

at the second type of regulatory site (right). The diagram indicates inhibition or stimulation of enzyme activity with the four different substrates. The pathway from dUDP to dTTP is described later (see Figs 22-43, 22-44).

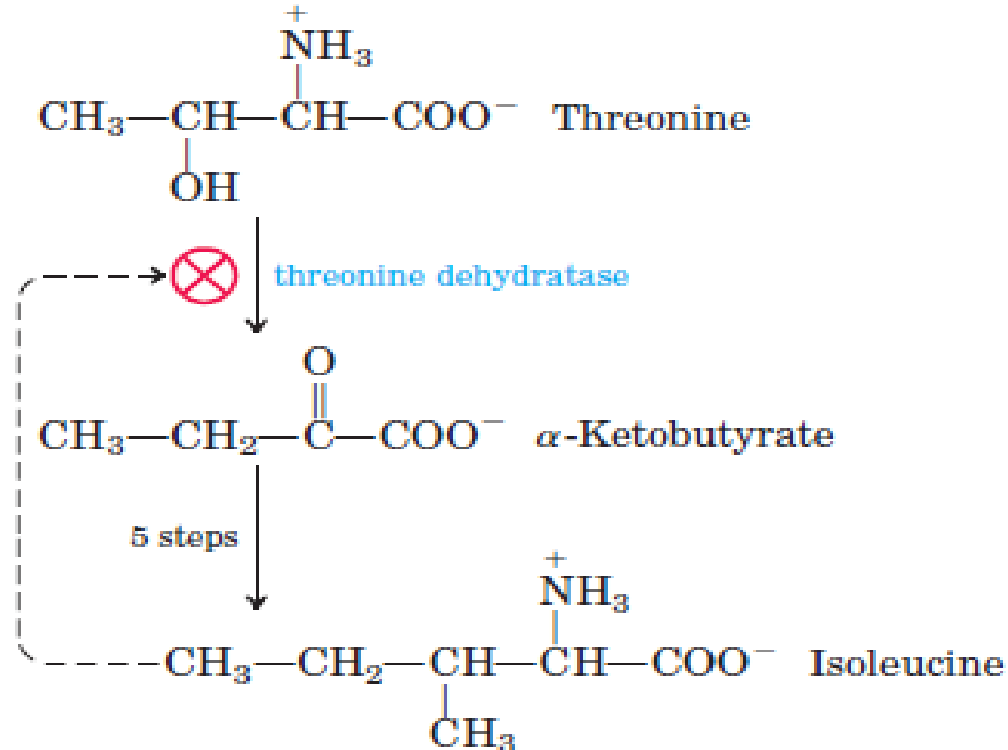

FIGURE 22-21 Allosteric regulation of isoleucine biosynthesis. The first reaction in the pathway from threonine to isoleucine is inhibited by the end product, isoleucine. This was one of the first examples of allosteric feedback inhibition to be discovered. The steps from α -ketobutyrate to isoleucine correspond to steps (18) through (21) in Figure 22-15 (five steps because (19) is a two-step reaction).

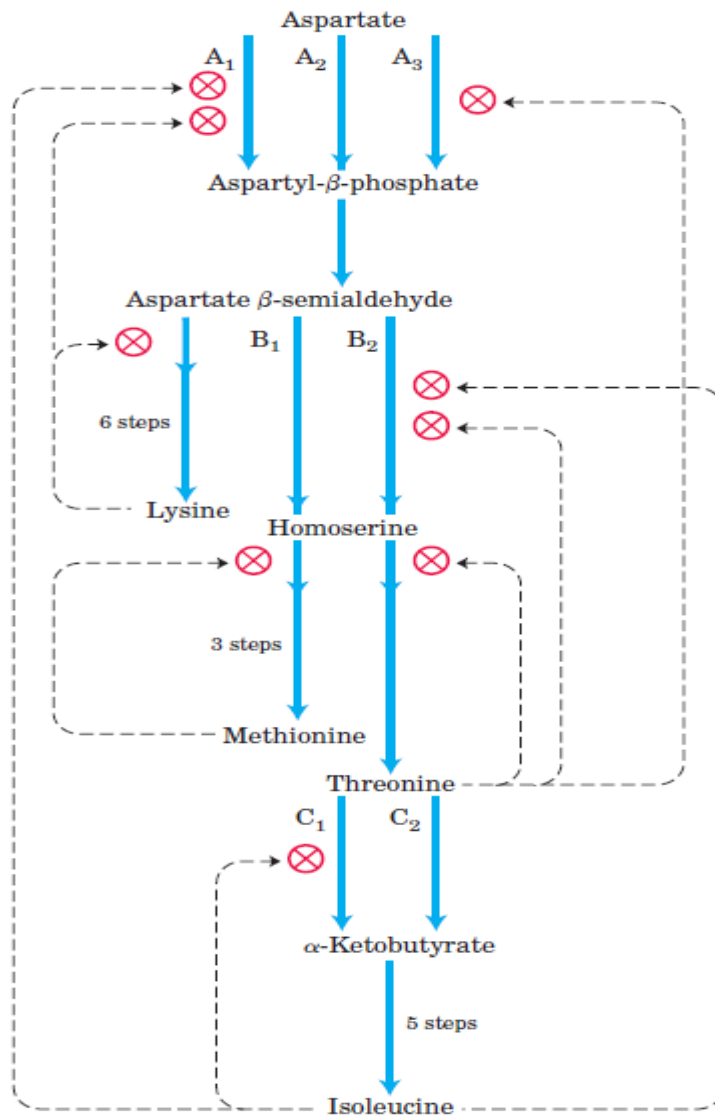
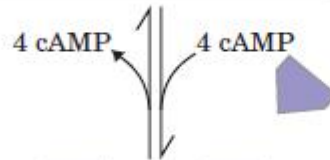
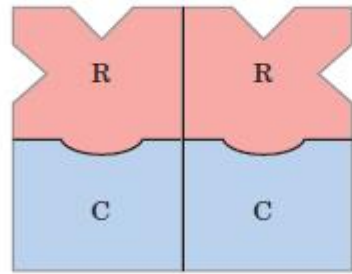

FIGURE 22-22 Interlocking regulatory mechanisms in the biosynthesis of several amino acids derived from aspartate in *E. coli*. Three enzymes (A, B, C) have either two or three isozyme forms, indicated by numerical subscripts. In each case, one isozyme (A_2 , B_1 , and C_2) has no allosteric regulation; these isozymes are regulated by changes in the amount synthesized (Chapter 28). Synthesis of isozymes A_2 and B_1 is repressed when methionine levels are high, and synthesis of isozyme C_2 is repressed when isoleucine levels are high. Enzyme A is aspartokinase; B, homoserine dehydrogenase; C, threonine dehydratase.

Inactive PKA

Regulatory subunits:
empty cAMP sites

Catalytic subunits:
substrate-binding
sites blocked by
autoinhibitory
domains of R subunits



Regulatory subunits:
autoinhibitory
domains buried

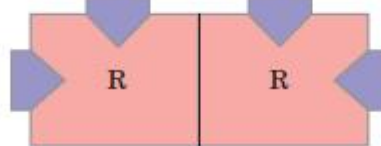

Active PKA

Catalytic subunits:
open substrate-
binding sites

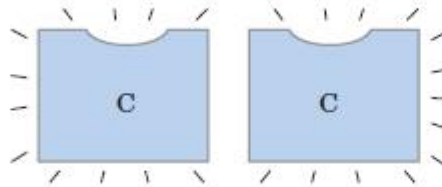

(a)

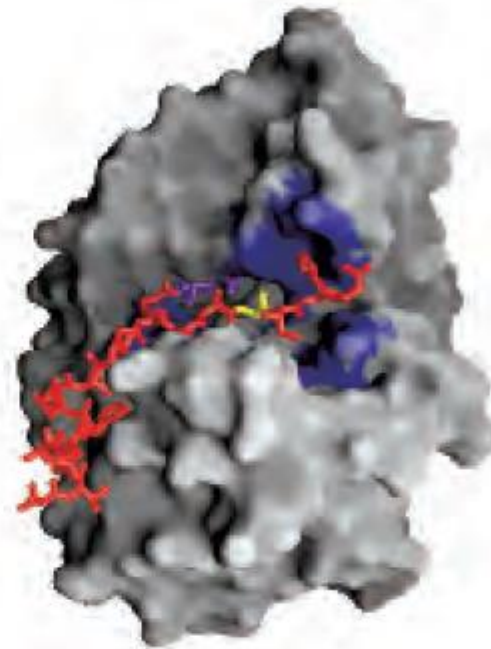

(b)

FIGURE 12-15 Activation of cAMP-dependent protein kinase, PKA.

(a) A schematic representation of the inactive R_2C_2 tetramer, in which the autoinhibitory domain of a regulatory (R) subunit occupies the substrate-binding site, inhibiting the activity of the catalytic (C) subunit. Cyclic AMP activates PKA by causing dissociation of the C subunits from the inhibitory R subunits. Activated PKA can phosphorylate a variety of protein substrates (Table 12-3) that contain the PKA consensus sequence $(X\text{-Arg-(Arg/Lys)-X-(Ser/Thr)-B})$, where X is any

residue and B is any hydrophobic residue), including phosphorylase b kinase. (b) The substrate-binding region of a catalytic subunit revealed by x-ray crystallography (derived from PDB ID 1JBP). Enzyme side chains known to be critical in substrate binding and specificity are in blue. The peptide substrate (red) lies in a groove in the enzyme surface, with its Ser residue (yellow) positioned in the catalytic site. In the inactive R_2C_2 tetramer, the autoinhibitory domain of R lies in this groove, blocking access to the substrate.

T state

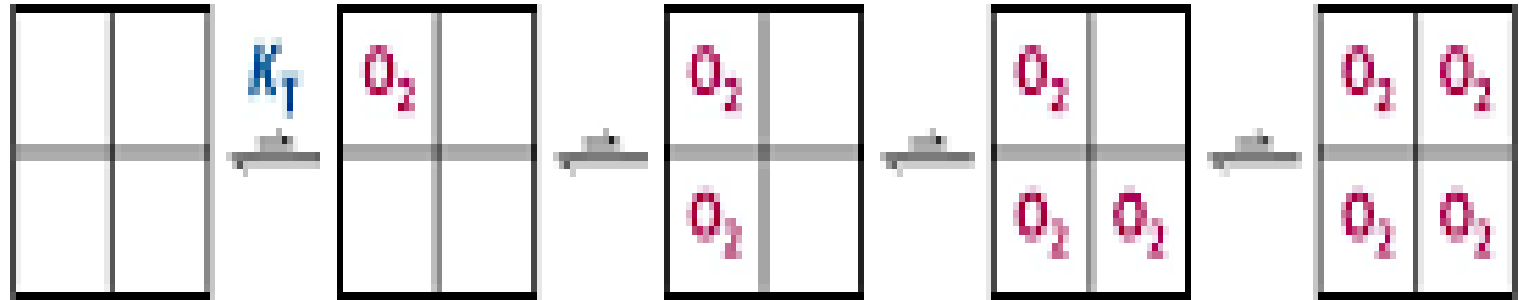

**T state
strongly
favored**

**R state
strongly
favored**

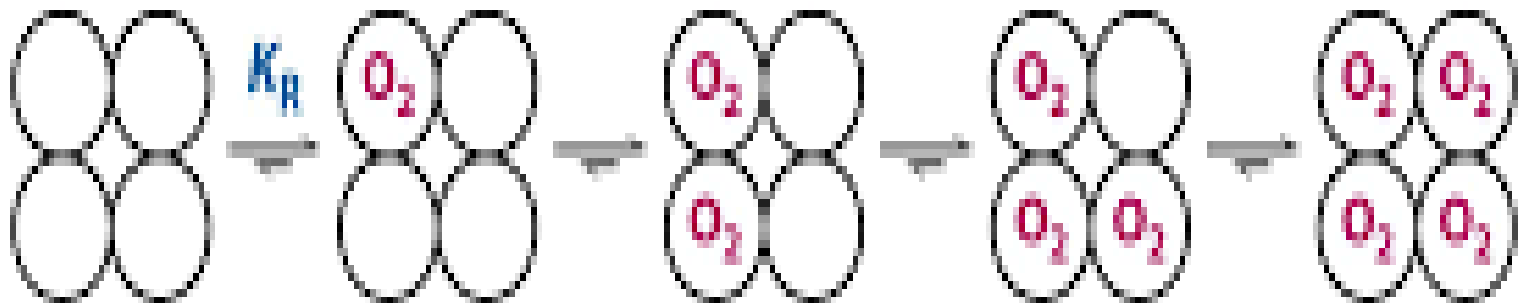

R state

MWC MODEL

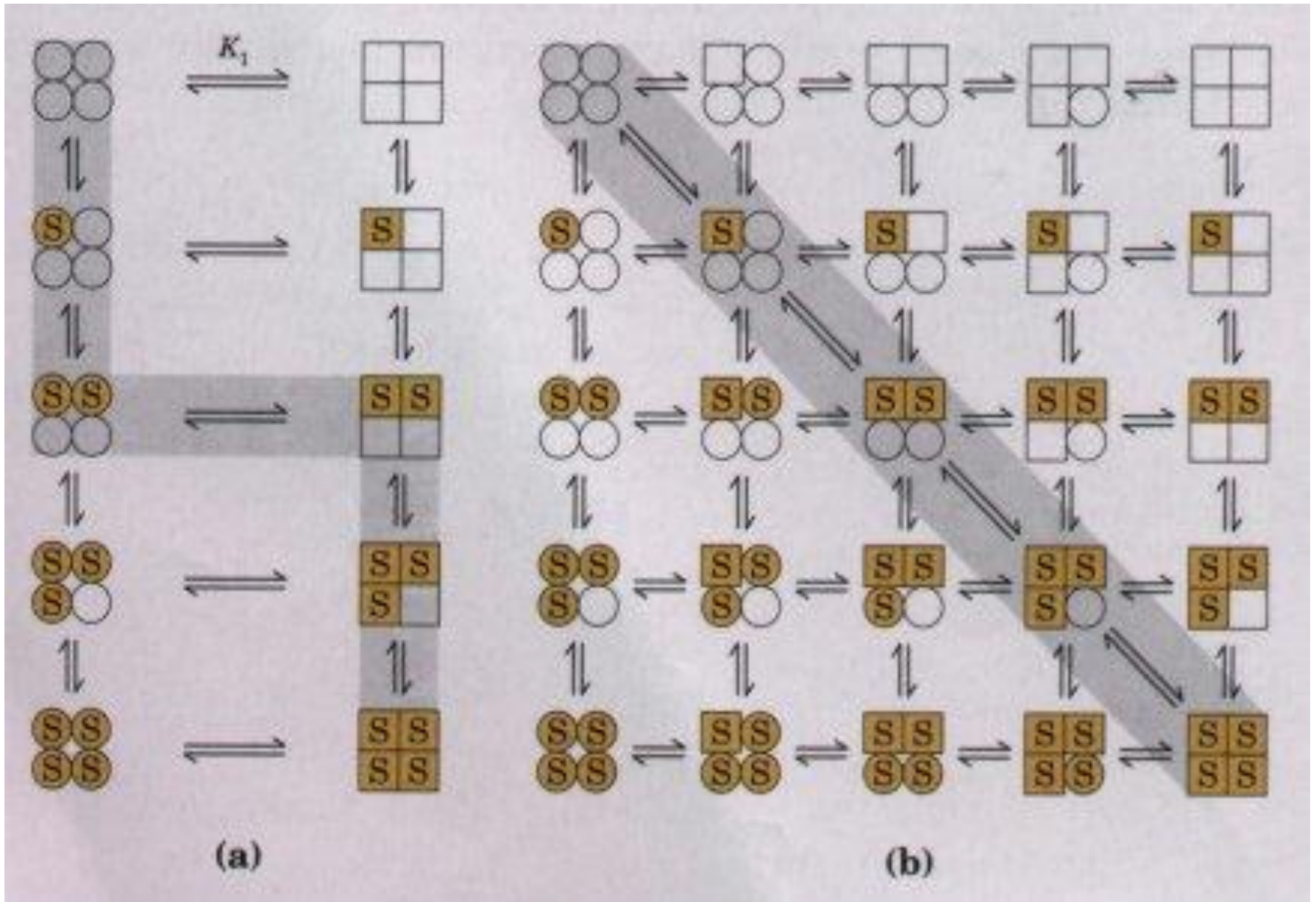

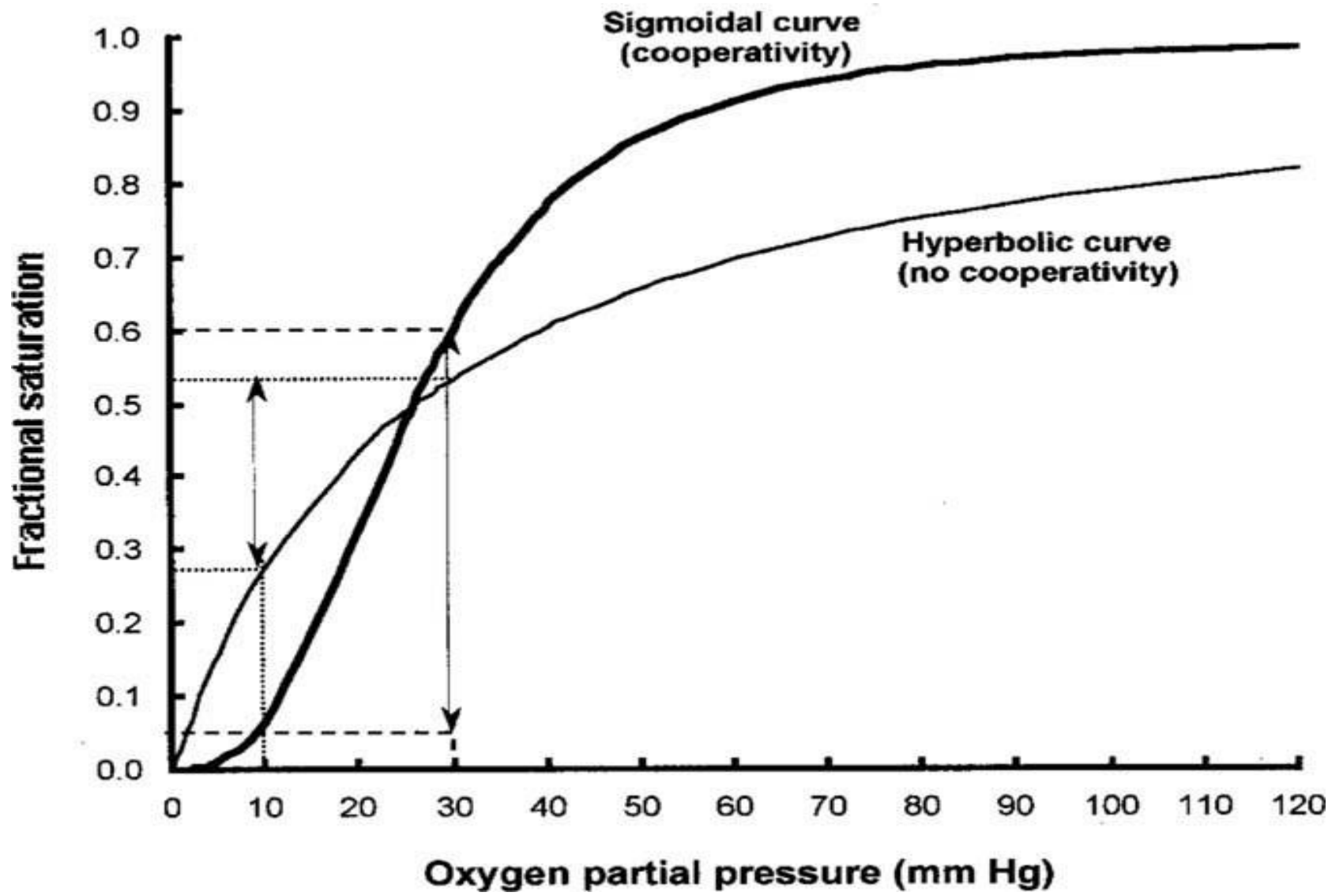

MONOD-WYMAN-CHANGEUX (MWC) MODEL

KOSHLAND- MEMETHY-FILMER(KNF) MODEL

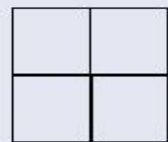

MWC: Two state concerted

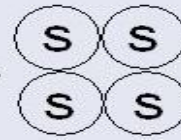
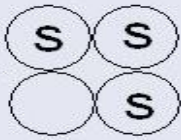
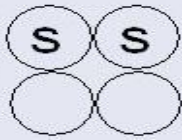
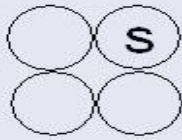
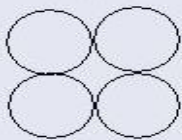

KNF: One state sequential

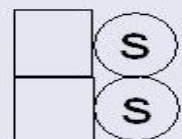

Allosteric Regulation

- Regulating an enzyme's activity with a molecule that binds to the enzyme at a site removed from the active site
- The players:
 - Allosteric enzyme: has an allosteric site
 - Allosteric site: a specific binding site on the enzyme that is not the active site
 - Effector: a regulator that can activate or inhibit by the enzyme by binding to an allosteric site

Allosteric Enzyme

- Most are constructed of two or more polypeptide chains (subunits)
- Each subunit has its own active site
- Allosteric sites are often located where subunits join
- Protein oscillates between an active and an inactive conformation

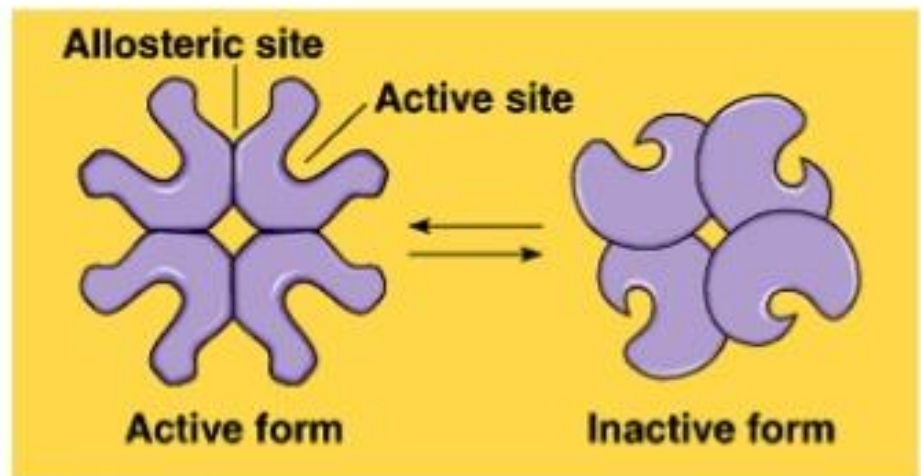

Effector: Allosteric Regulators

- Effectors change enzymatic activity by binding weakly to an allosteric site
 - Allosteric **activator**: stabilizes the conformation that has a functional active site
 - Allosteric **inhibitor**: stabilizes the conformation that lacks an active site (inactive form)
- Often works through cooperativity

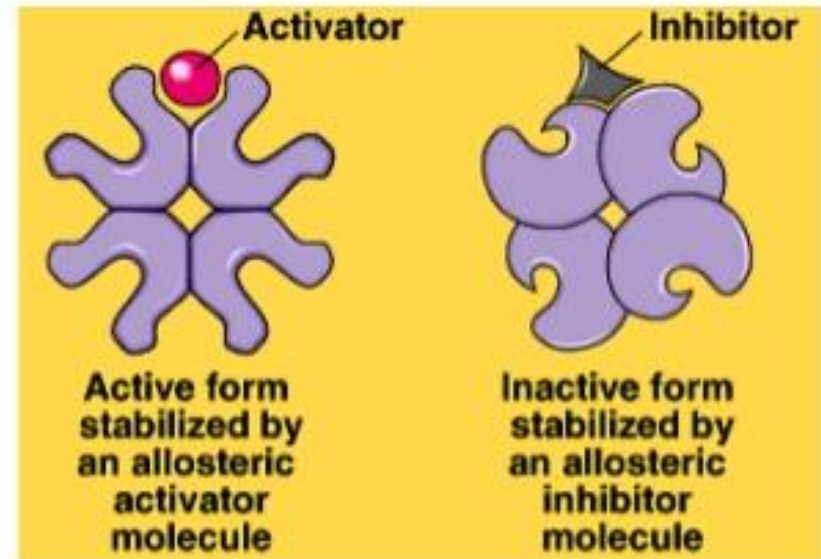

Cooperativity

- Binding of a molecule (substrate or effector) stabilizes a conformational change on all the other subunits
- Can result in an increase or decrease in substrate affinity
- Can only occur in enzymes with multiple subunits

Cooperativity

- Example of positive cooperativity: substrate binding to one active site stabilizes conformational changes at all the other subunits
- Example of negative cooperativity: some forms of allosteric inhibition

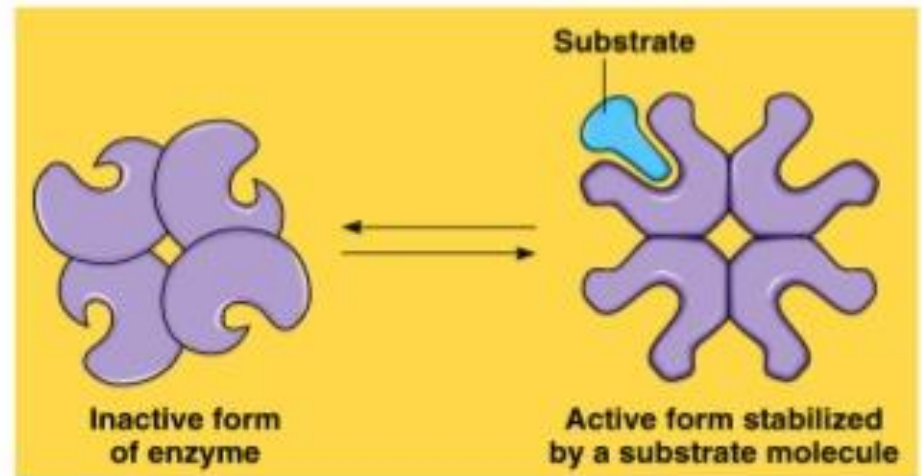

What is Oxygen binding?

Oxygen binding is the binding of an oxygen molecule to a specific functional protein for either transport or storage *in vivo*.

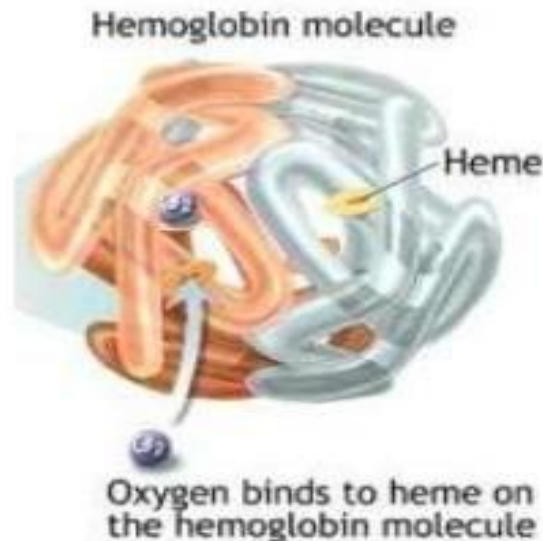

Hemoglobin (Hb)

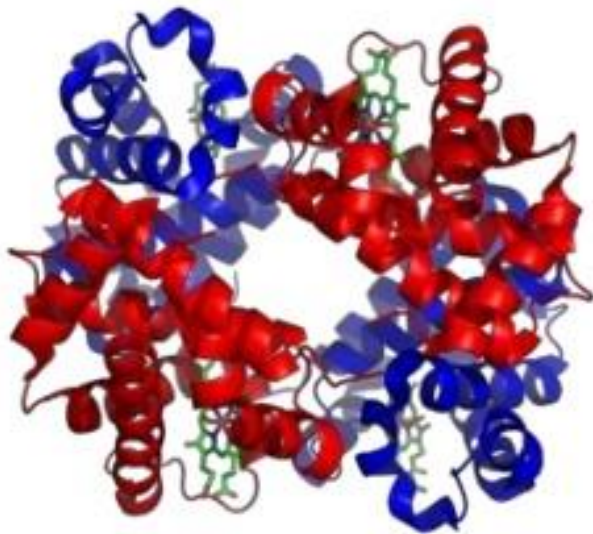

- Tetrameric, two alpha chains and two beta chains
- binds a total of 4 oxygen molecules
- carries O_2 from lungs to tissues
- cooperative binding of O_2
- required to increase the solubility of O_2 in blood

The Heme group

- Example of a prosthetic group
- Heterocyclic ring containing 4 pyrrole rings
- Central atom is Fe^{2+} (usual oxidation state)
- Proximal Histidine is important in transducing the binding event to protein.

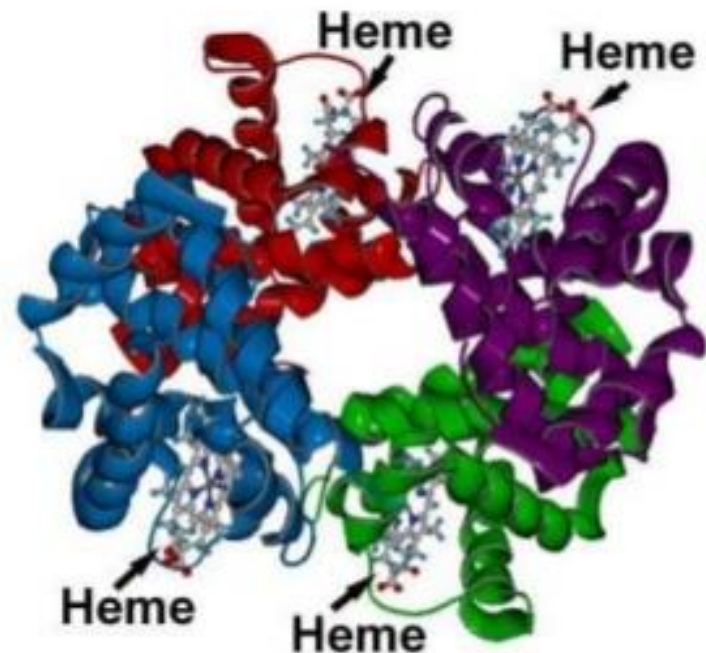

Ligands

a **ligand** (from the Latin **ligandum**, *binding*) is a substance (usually a small molecule), that forms a complex with a biomolecule to serve a biological purpose.

In a narrower sense, it is a signal triggering molecule, binding to a site on a target protein.

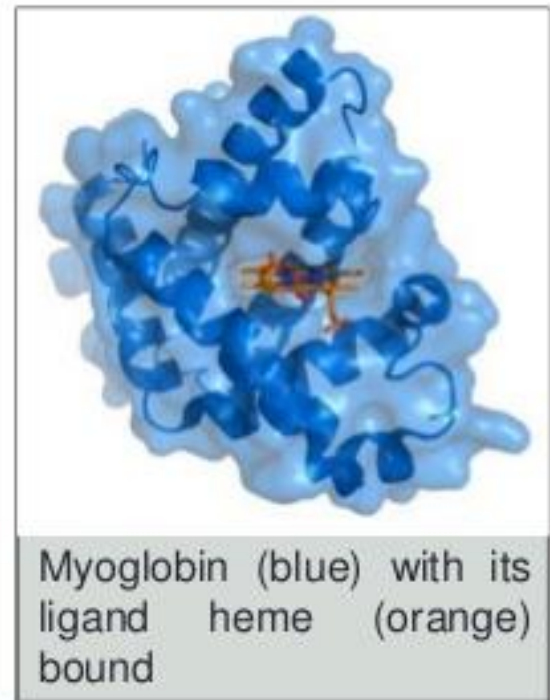

Mechanism of positive cooperativity in Hemoglobin

- Binding of O₂ to Fe moves proximal Histidine residue and its attached helix (F)
- Helix F adjusts conformation by movement of a b subunits (hinge and helix ratchet)
- Alters conformation of Iron (Fe) at un-liganded sites.

Allosteric effect

Allosteric effects occur when the binding properties of a macromolecule change as a consequence of a second ligand binding to the macromolecule and altering its affinity towards the first, or primary, ligand.

Types of Allosteric effects

I. If the two ligands are the same (*e.g.* oxygen) then this is called a **homotropic allosteric** effect.

II. If the two ligands are different (*e.g.* oxygen and BPG), then this is called a **heterotropic allosteric** effect.

Allosteric effect

- Macromolecules that have **multiple ligand binding sites** (*e.g.* Hb), allosteric effects can generate cooperative behavior.
- Allosteric effects are important in **the regulation of enzymatic reactions**.
- Both allosteric activators (which enhance activity) and allosteric inhibitors (which reduce activity) are utilized to control enzyme reactions.

Allosteric effect

Allosteric effects require the presence of two forms of the macromolecule.

1. One form, **T or tense state**, binds the primary ligand (*e.g.* oxygen) with low affinity.
 2. The other form, **R or relaxed state**, binds ligand with high affinity.
- The T and R states are in equilibrium with each other.
 - In the case of positive cooperativity the fraction of T states exceeds that of the R state.

Transition from T to R

Change from T to R states may occur:

- In unison via the **Monod-Wyman-Changeux** (MWC) model
- Sequentially via the **Koshland** (KNF) model

Monod-Wyman-Changeux (MWC) model

A concerted model for the basis of cooperativity in multimeric binding proteins,

In the absence of a ligand (oxygen in the case of hemoglobin) the subunits exist in a T-form.

The ligand may bind to as many as two monomers in this conformation, at which point all four monomers convert from T-form to R-form.

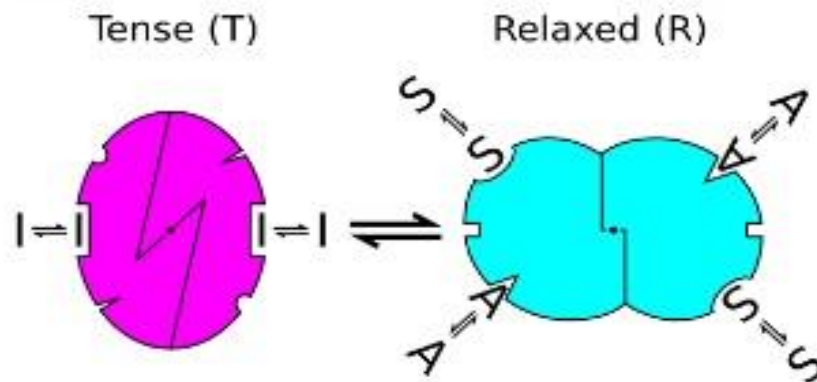

Koshland (KNF) model

- The binding of the ligand causes conformational change.
- Although the subunits go through conformational changes independently (as opposed to in the MWC model).
- The switch of one subunit makes the other subunits more likely to change, by reducing the energy needed for subsequent subunits to undergo the same conformational change.

Oxygen binding curves

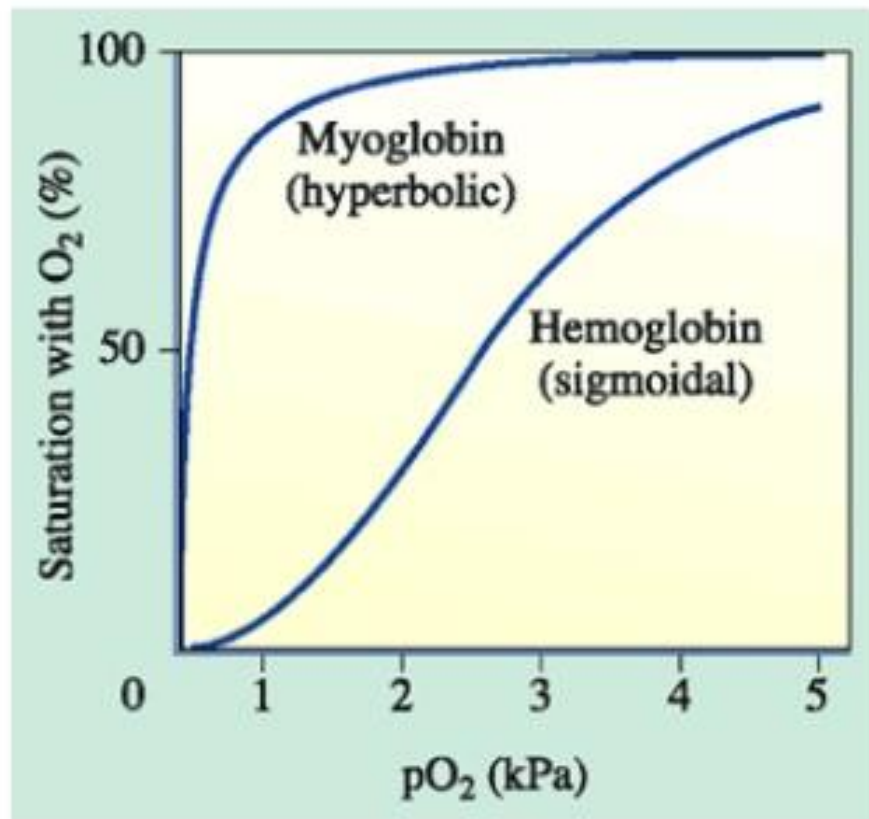

The Oxygen binding curves of Myoglobin and Hemoglobin with respect to the percent saturation of O₂ and pressure.

Hill Plot

- When the cooperativity is moderate (that is in reality), the experimental data often still well modelled by this equation BUT h will no longer be equal to the number of binding sites (h may not be an integer)

Possibilities:

- $h = 1.0$ no cooperativity (same as the MM equation)
- $n > h > 1.0$ positive cooperativity
- $h = n$ completely cooperative
- $h < 1.0$ negative cooperativity

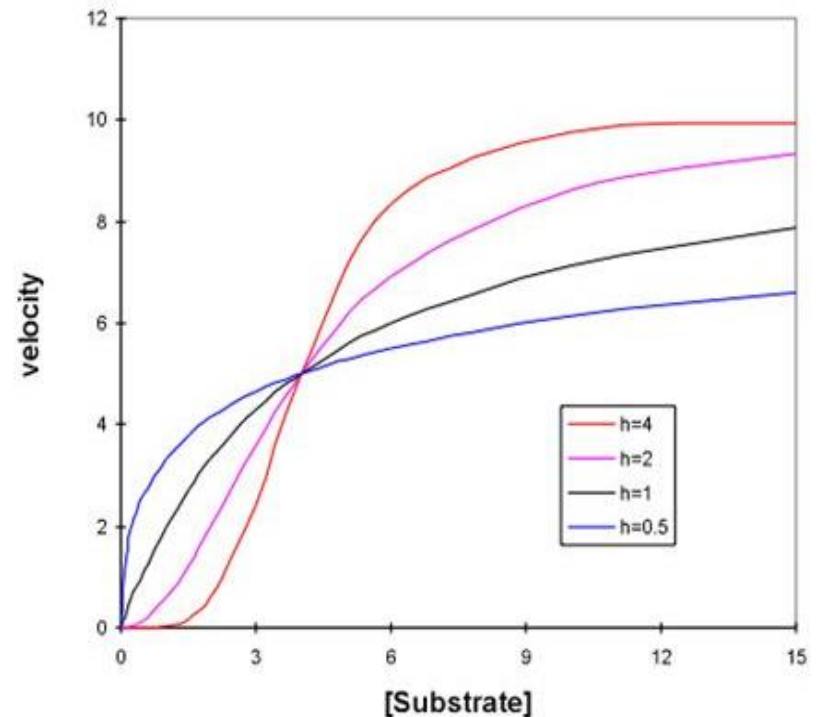

Hemoglobin, Cooperativity, and The Hill Equation

E = enzyme, S = ligand, n = small number



O₂ is considered a ligand

$$1. \quad K = \frac{[E][S]^n}{[ES_n]} \quad 2. \quad Y_S = \frac{n[ES_n]}{n([E] + [ES_n])}$$

Fractional Saturation **bound/total**