

# Microscope

Presented by  
R.Parthasarathy

# TERMS AND DEFINITIONS

## Principle

Microscopy is to get a magnified image, in which structures may be resolved which could not be resolved with the help of an unaided eye.

## Magnification

- It is the ratio of the size of an object seen under microscope to the actual size observed with unaided eye.
- The total magnification of microscope is calculated by multiplying the magnifying power of the objective lens by that of eye piece.

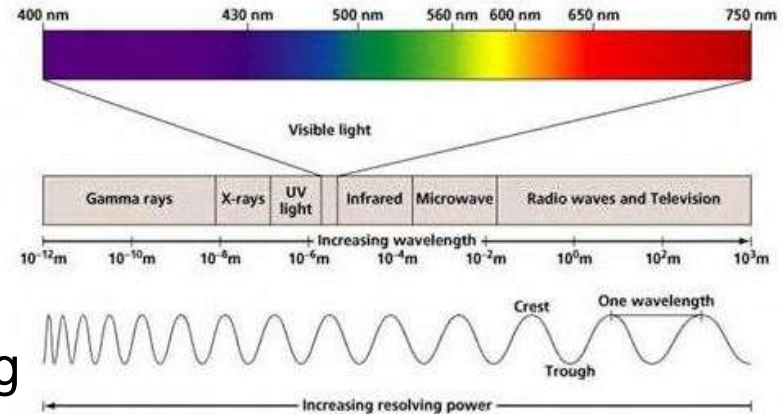

## Resolving power

- It is the ability to differentiate two close points as separate.
- The resolving power of human eye is 0.25 mm
- The light microscope can separate dots that are  $0.25\mu\text{m}$  apart.
- The electron microscope can separate dots that are 0.5nm apart.

# TERMS AND DEFINITIONS

## Limit of resolution

It is the minimum distance between two points to identify them separately.

It is calculated by Abbé equation.

$$\text{Resolving power (R.P.)} = \frac{\text{Wavelength of light in nm}}{2 \times \text{Numerical aperture of objective lens}}$$

Limit of resolution is inversely proportional to power or resolution. If the wavelength is shorter then the resolution will be greater.

## Working distance

- It is the distance between the objective and the objective slide.
- The working distance decreases with increasing magnification.

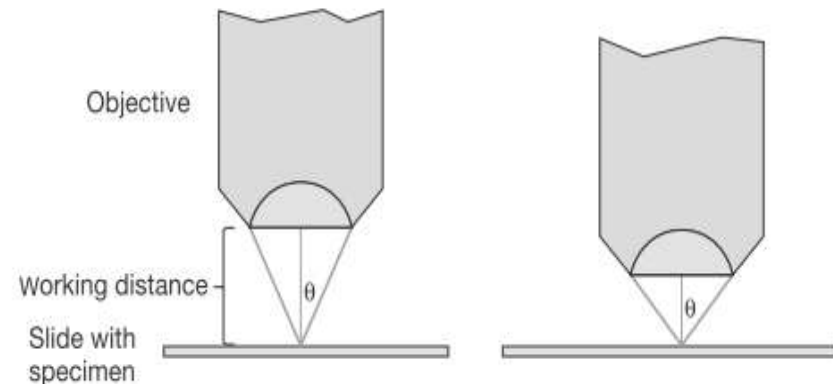

# TERMS AND DEFINITIONS

## Numerical aperture(NA)

The numerical aperture of a lens is the ratio of the diameter of the lens to its focal length.

NA of a lens is an index of the resolving power.

NA can be decreased by decreasing the amount of light that passes through a lens.

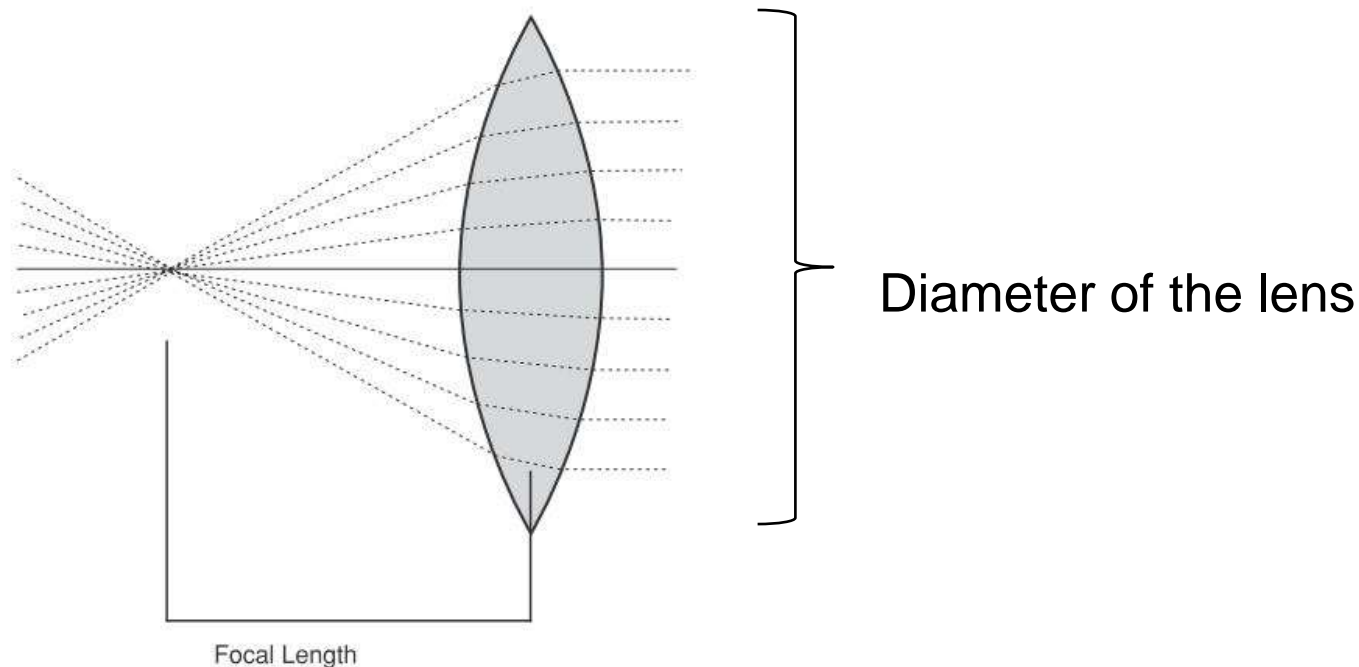

# Light microscope

- In 1590 F.H Janssen & Z.Janssen constructed the first simple compound light microscope.
- In 1665 Robert Hooke developed a first laboratory compound microscope.
- Later, Kepler and Galileo developed a modern classroom microscope.
- In 1672 Leeuwenhoek developed a first simple microscope with a magnification of 200x – 300x.
- He is called as Father of microscopy.
- The term microscope was coined by Faber in 1623.



Designed for medical students in the late 19th Century, this Wenham-style binocular microscope, designed and built by Henry Crouch typifies advancements of the period.

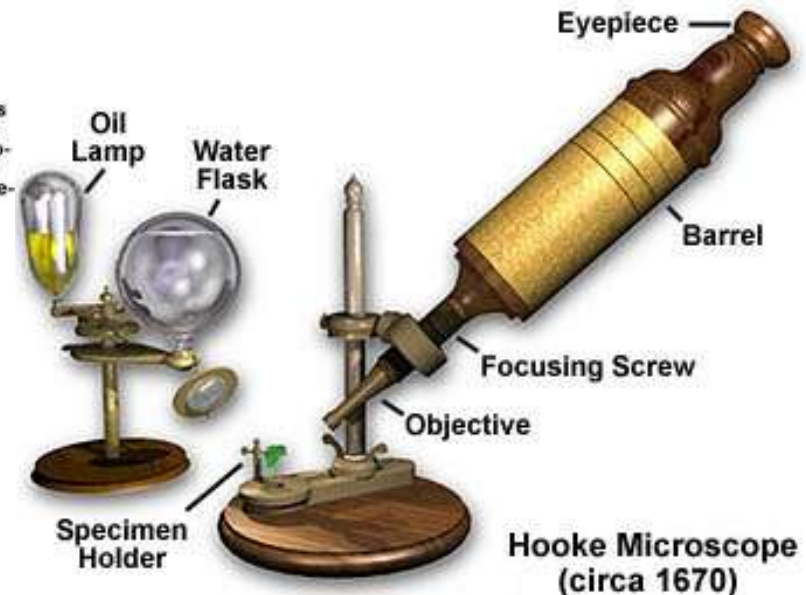

Hooke Microscope (circa 1670)

# Light microscope

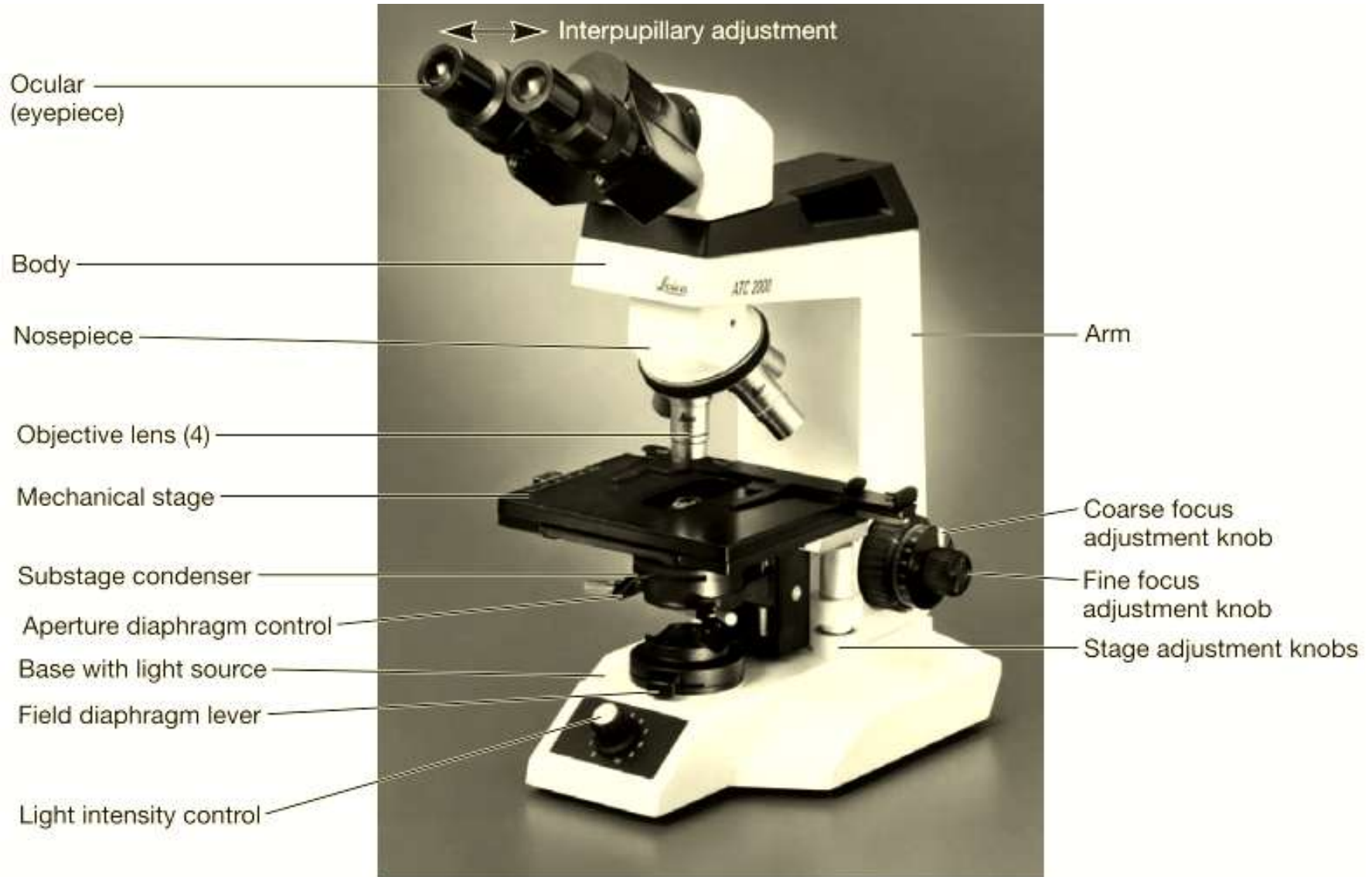

# Light microscope

## Parts of microscope

- **Illuminator** - This is the light source located below the specimen.
- **Condenser** - Focuses the ray of light through the specimen.
- **Stage** - The fixed stage is a horizontal platform that holds the specimen.
- **Objective** - The lens that is directly above the stage.
- **Nosepiece** - The portion of the body that holds the objectives over the stage.
- **Iris diaphragm** - Regulates the amount of light into the condenser.
- **Base** - Base supports the microscope which is horseshoe shaped.
- **Coarse focusing knob** - Used to make relatively wide focusing adjustments to the microscope.
- **Fine focusing knob** - Used to make relatively small adjustments to the microscope.
- **Body** - The microscope body.
- **Ocular eyepiece** - Lens on the top of the body tube. It has a magnification of 10x normal vision.

# Light microscope

Objective			
PROPERTY	LOW POWER	HIGH POWER	OIL IMMERSION
Magnification of objective	10x	40-45x	90-100x
Magnification of eyepiece	10x	10x	10x
Total magnification	100x	450 – 450x	900 – 1000x
Numerical aperture	0.25 – 0.30	0.55 – 0.65	1.25 – 1.4
Mirror used	Concave	Concave	Plane
Focal length (Approx)	16 mm	4 mm	1.8 – 2 mm
Working distance	4 – 8 mm	0.5 – 0.7 mm	0.1 mm
Iris diaphragm	Partially closed	Partially opened	Fully opened
Position of condenser	Lowest	Slightly raised	Fully raised
Maximum resolution(Approx)	0.9 $\mu\text{m}$	0.35 $\mu\text{m}$	0.18 $\mu\text{m}$



# Light microscope

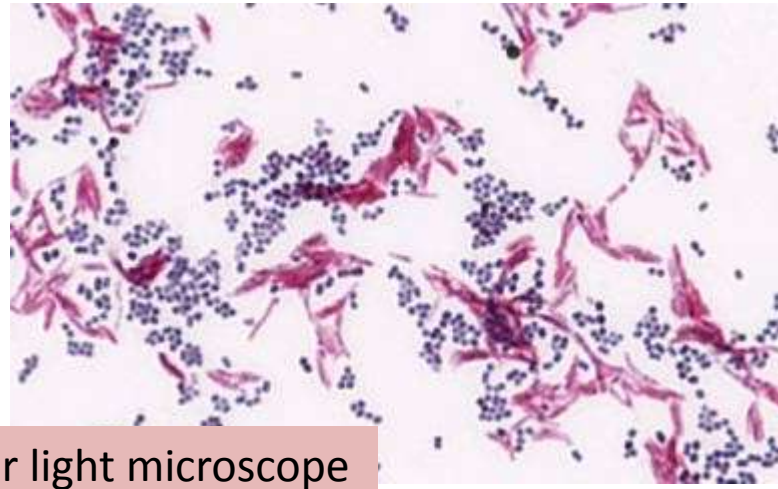

Bacilli and cocci under light microscope

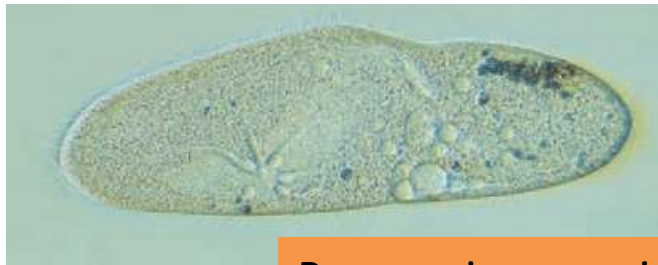

Paramecium specimen



# Dark field microscope

A bright-field microscope can be adapted as a dark-field microscope by adding a special disc called a stop to the condenser.

The stop blocks all light from entering the objective lens except peripheral light that is reflected off the sides of the specimen itself. The resulting image is a brightly illuminated specimens surrounded by a dark (black) field.

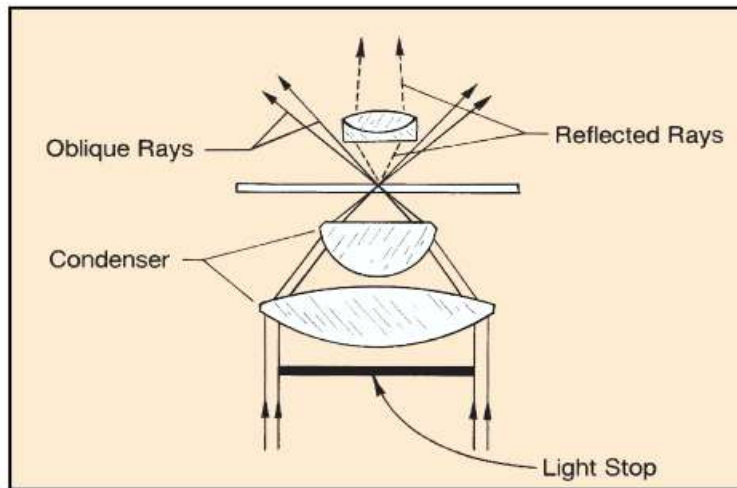

**Figure 2.3** The star diaphragm allows only peripheral light rays to pass up through the condenser. This method requires maximum illumination.

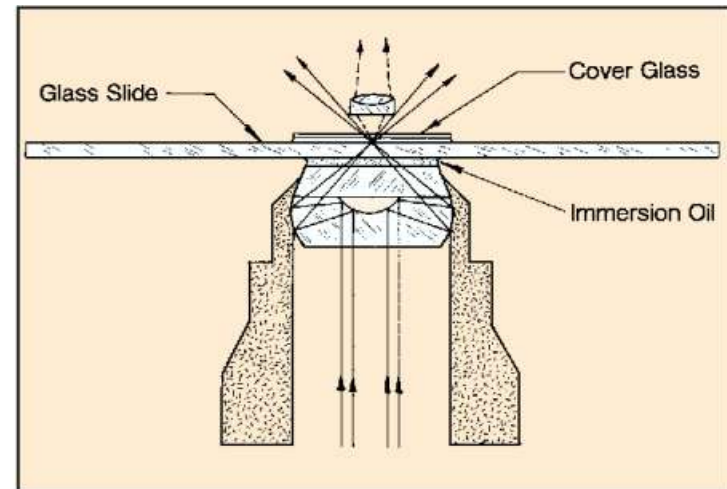
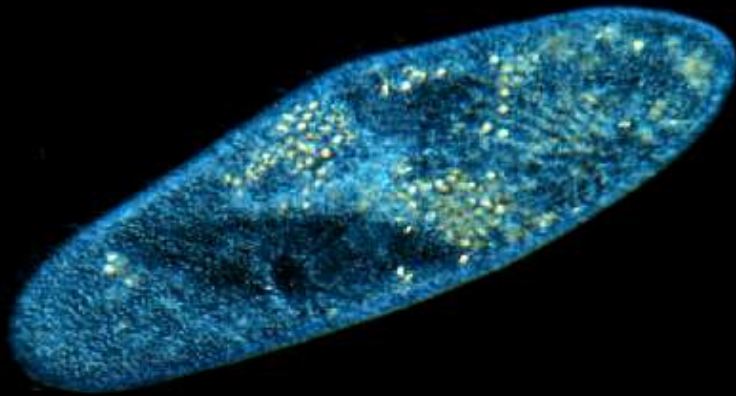

**Figure 2.4** A cardioid condenser provides greater light concentration for oblique illumination than the star diaphragm.

## Uses:

This microscope is used to study spirochetes in the exudates form leptospiral or syphilitic Infections.

# Dark field microscope



Paramecium

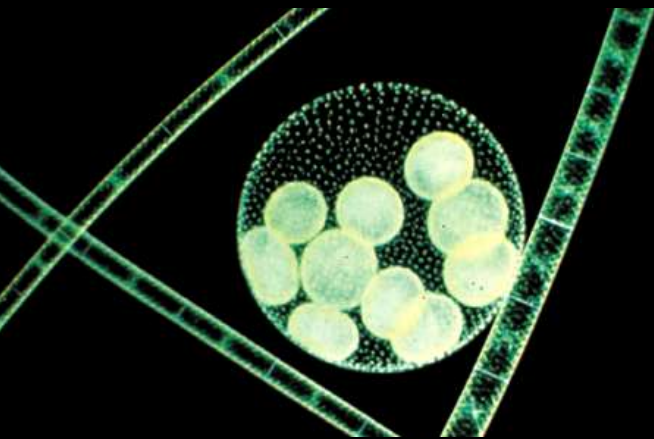
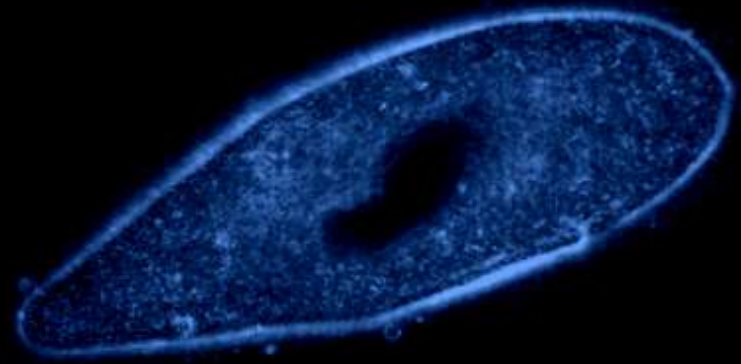

Volvox and Spirogyra



Treponema vincenti

# Phase contrast microscope

In 1935 F.Zernike produced the phase contrast microscope. Phase-contrast microscope is also called as zernike microscope.

Phase-contrast microscope uses a special condenser and objective lenses.

This condenser lens on the light microscope splits a light beam and throws the light rays slightly out of phase. The separated beams of light then pass through and around the specimen, and small differences in the refractive index within the specimen show up as different degrees of brightness and contrast.

## Uses:

Phase-contrast microscopy is especially useful for studying microbial motility, studying eukaryotic Cells, determining the shape of living cells, and detecting bacterial components such as endospores and Inclusion bodies that contain poly--hydroxyalkanoates (e.g., poly-hydroxybutyrate), polymetaphosphate, sulfur, or other substances.

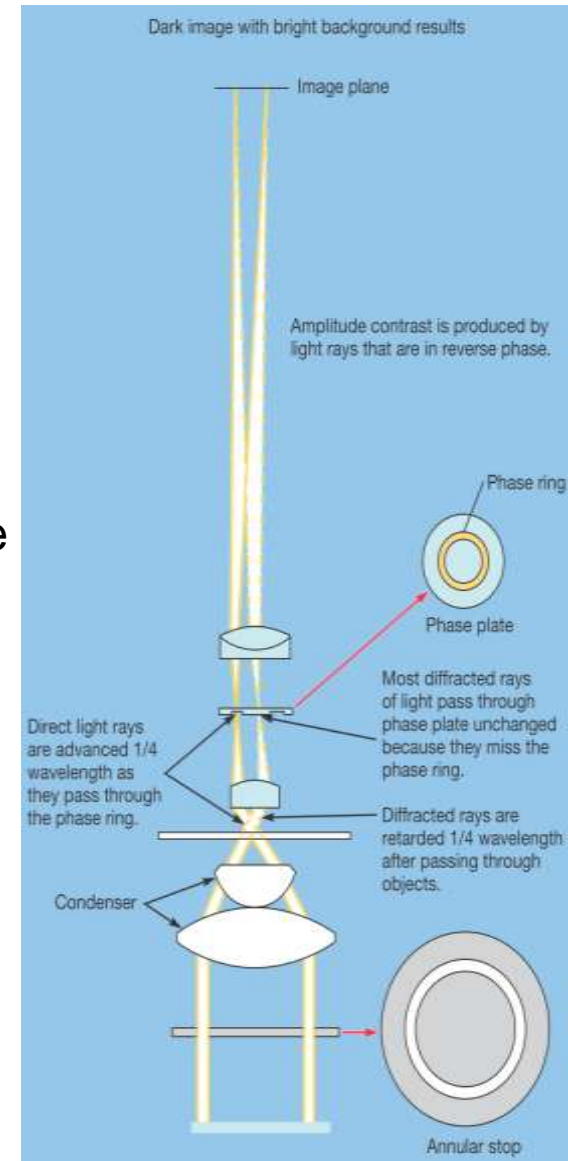

# Phase contrast microscope

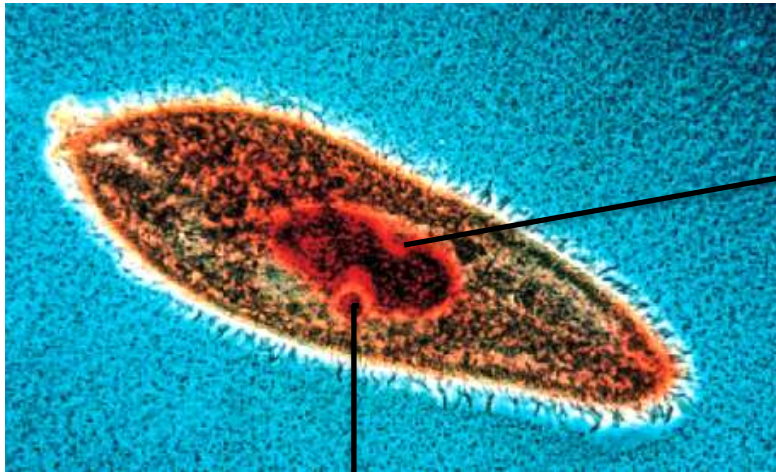

Macronucleus

Micronucleus

Paramecium

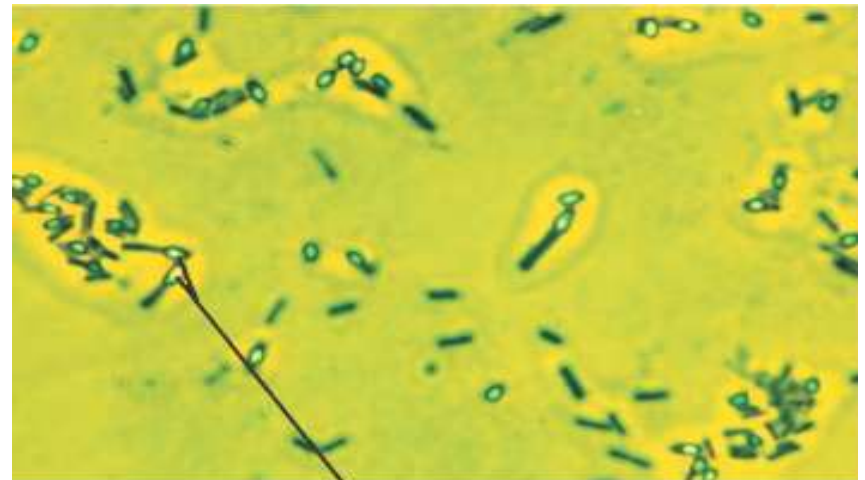

Bacterial spores

# Phase contrast microscope



(c) *Pseudomonas*: phase-contrast microscopy

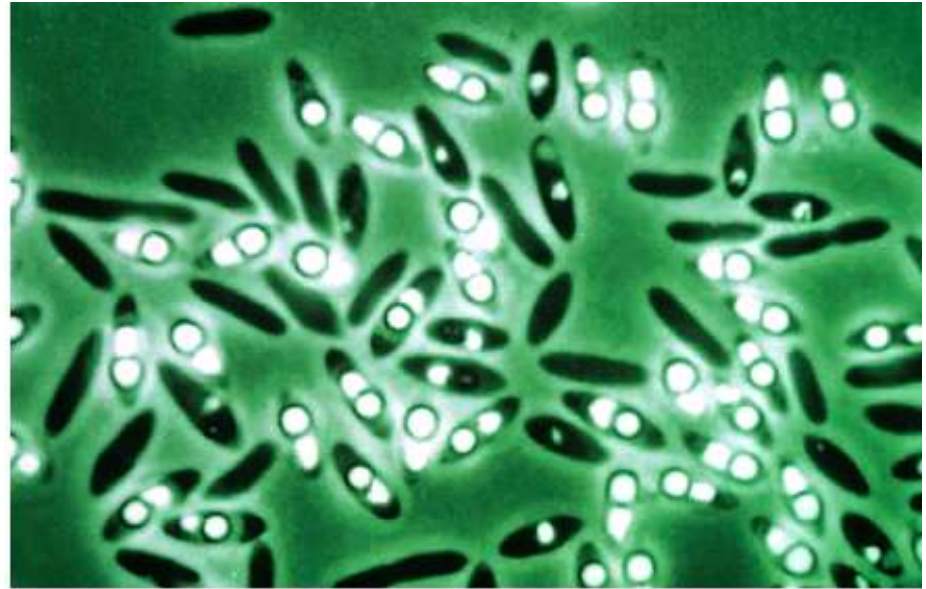

(d) *Desulfotomaculum*: phase-contrast microscopy



*Rhodospirillum rubrum*

# Fluorescence microscope

It was developed by Haitinger and coons

A fluorescence microscope differs from an ordinary brightfield microscope in several respects.

It utilizes a powerful mercury vapor arc lamp for its light source.

A darkfield condenser is usually used in place of the conventional Abbé brightfield condenser.

It employs three sets of filters to alter the light that passes up through the instrument to the eye.

Microbiological specimen that is to be studied must be coated with special compounds that possess the quality of fluorescence. Such compounds are called fluorochromes.

AuramineO, acridine orange, and fluorescein are well-known fluorochromes.

Fluorochrome	Uses
Acridine orange	Stains DNA; fluoresces orange
Diamidino-2-phenyl indole (DAPI)	Stains DNA; fluoresces green
Fluorescein isothiocyanate (FITC)	Often attached to antibodies that bind specific cellular components or to DNA probes; fluoresces green
Tetramethyl rhodamine isothiocyanate (TRITC or rhodamine)	Often attached to antibodies that bind specific cellular components; fluoresces red

# Fluorescence microscope

## Uses:

It is used to study the substance like chlorophylls, riboflavin, vitamin A, collagen which have the property of auto fluorescence.

Some cellular components like cellulose, starch, glycogen, protein and Y chromosome can be made visible under this microscope by staining them with fluorochromes.

It used to identify Y chromosome to determine sex, determination of microbial cells in the infected tissue and to study the structure of proteins.

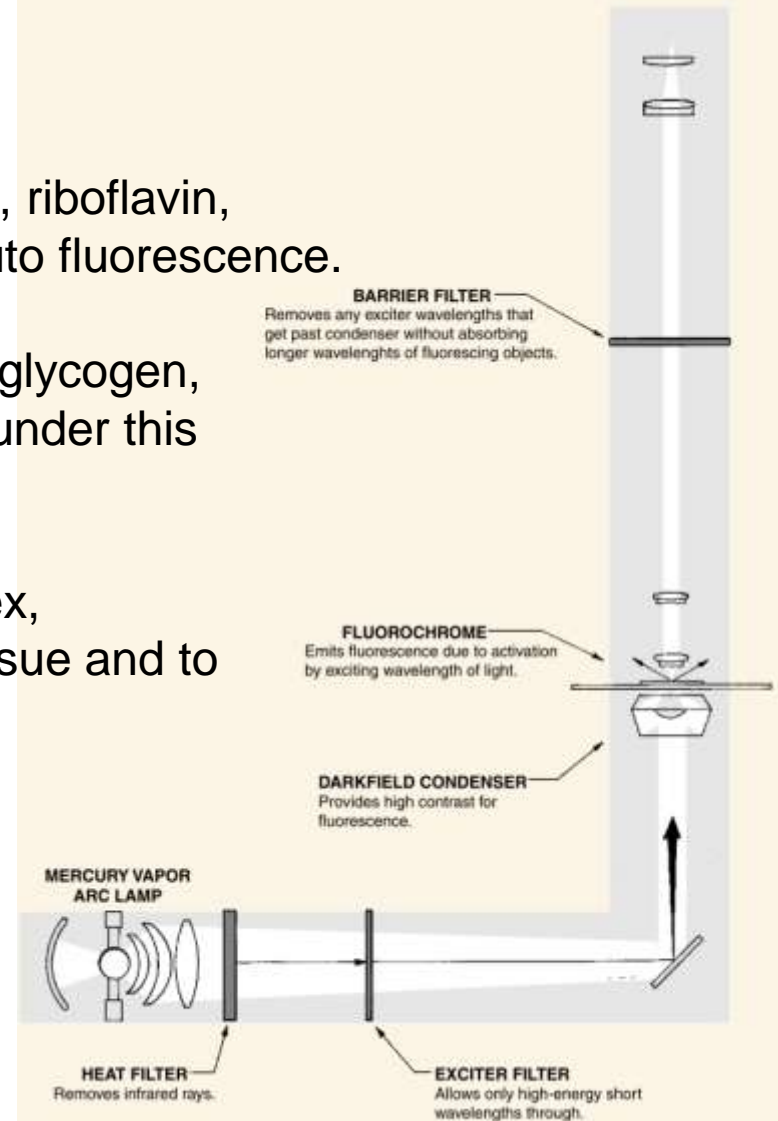



# Fluorescence microscope

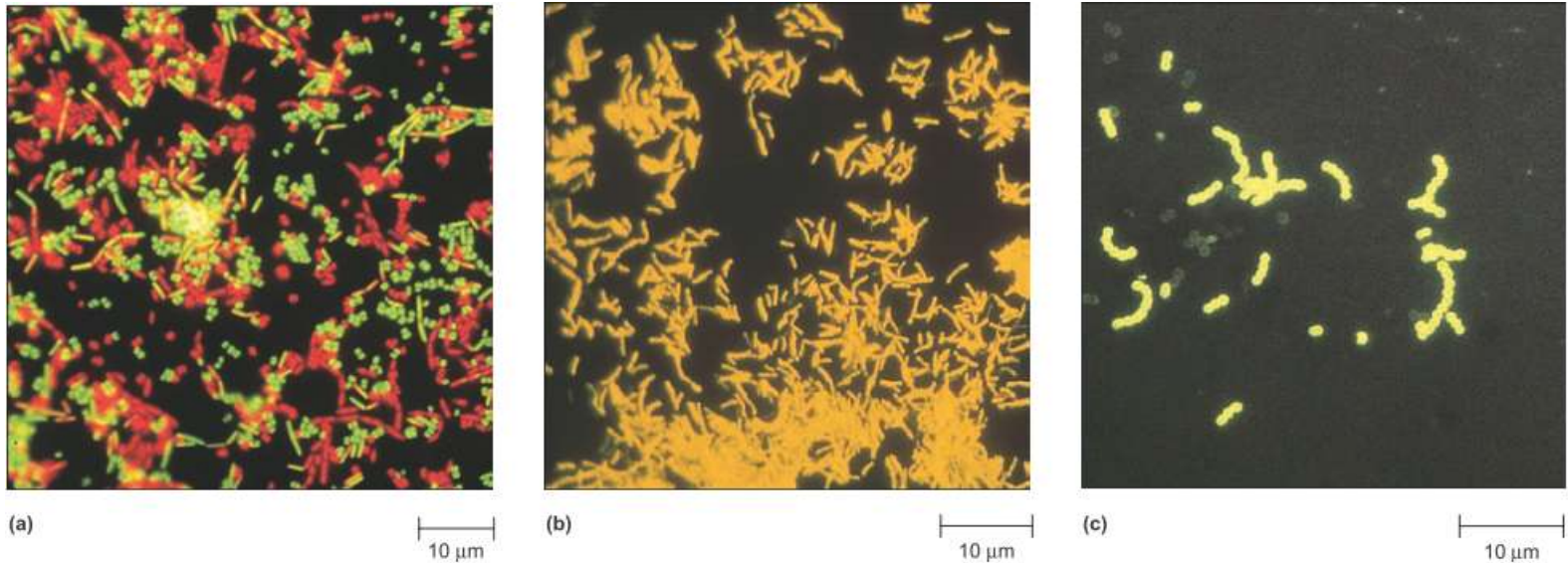

**Figure 2.13** Fluorescent Dyes and Tags. (a) Dyes that cause live cells to fluoresce green and dead ones red; (b) Auramine is used to stain *Mycobacterium* species in a modification of the acid-fast technique; (c) Fluorescent antibodies tag specific molecules. In this case, the antibody binds to a molecule that is unique to *Streptococcus pyogenes*.

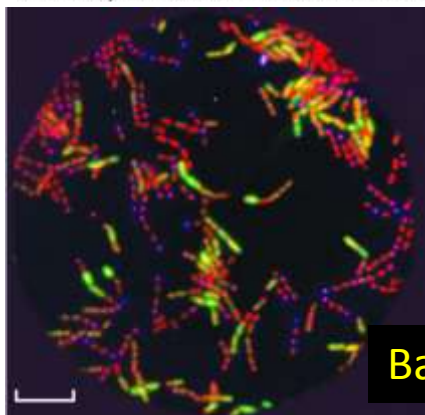

**Bacillus subtilis**

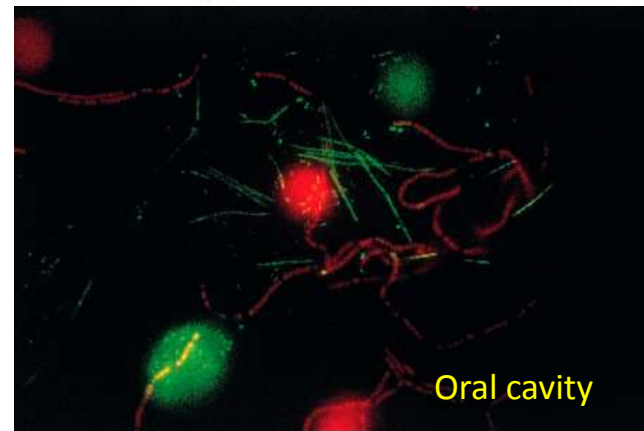

**Oral cavity**

# Electron microscope

In 1932 Knoll and Ruska invented first electron microscope.

The electron microscope uses a beam of electrons rather than visible light.

The magnified image is visible on a fluorescent screen and can be recorded on a photographic film.

The drawback of the electron microscope is specimen are killed in order to view the cells or organisms.

Images produced by electrons lack color, electron micrographs are always shades of black, gray, and white.

Two general forms of EM are the transmission electron microscope (TEM) and the scanning electron microscope (SEM).

**Transmission electron microscope** are the method of choice for viewing the detailed structure of cells and viruses.

This microscope produces its image by transmitting electrons through the specimen.

Because electrons cannot readily penetrate thick preparations, the specimen must be sectioned into extremely thin slices (20–100 nm thick) and stained or coated with metals that will increase image contrast.

The darkest areas of TEM micrographs represent the thicker (denser) parts, and the lighter areas indicate the more transparent and less dense parts.

# Electron microscope(TEM)

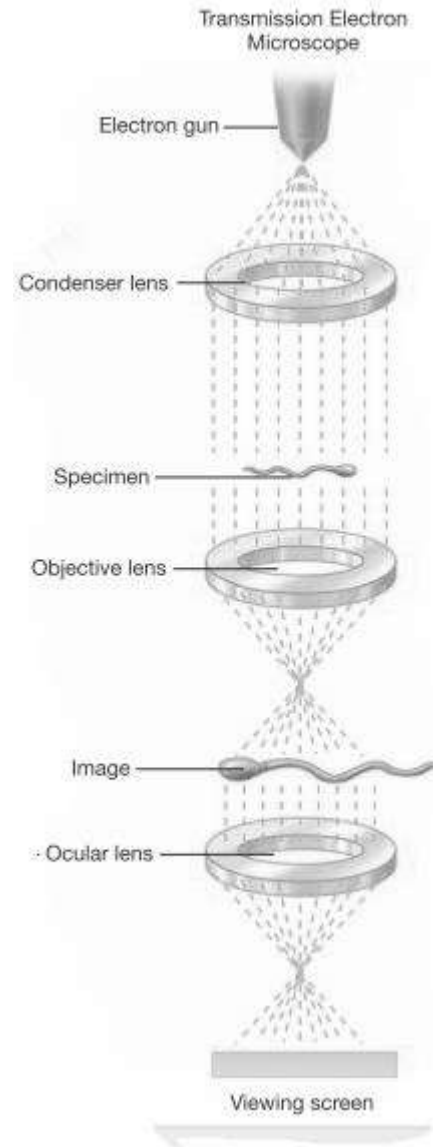

# Electron microscope(TEM)

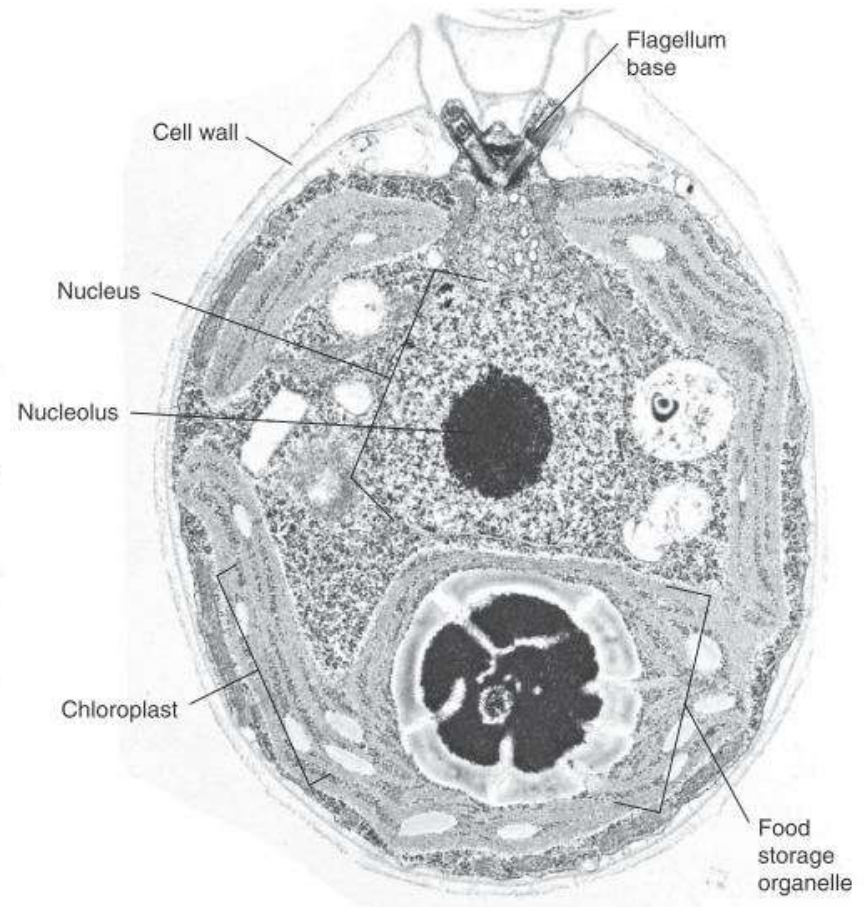
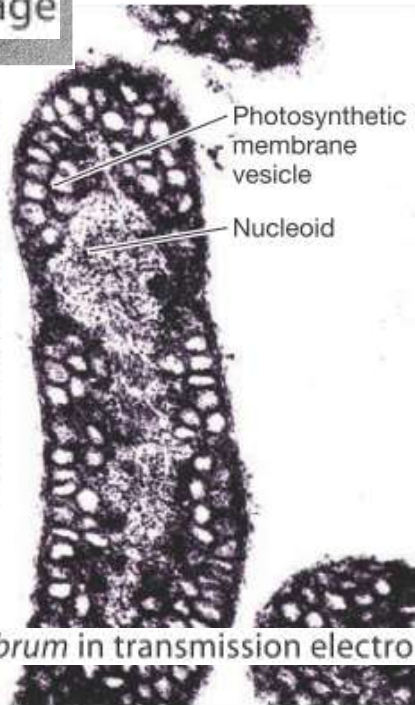
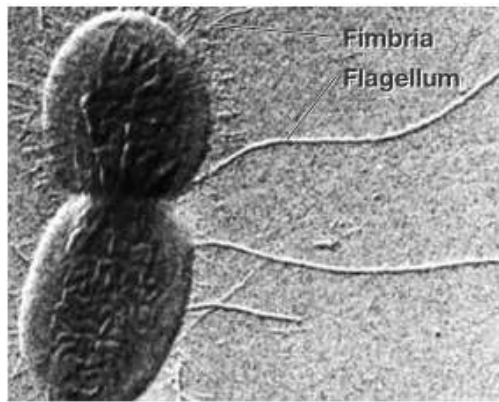
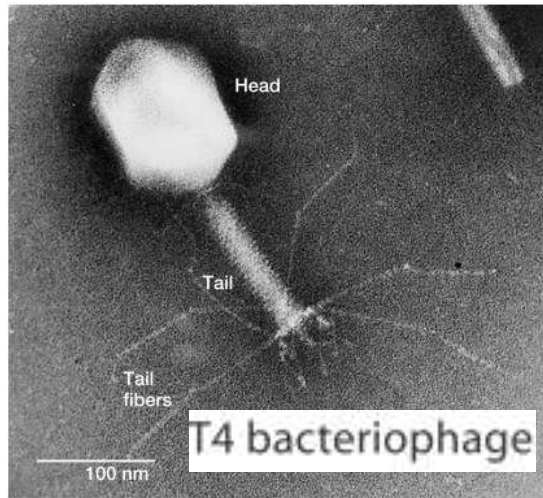

A thin section of *R. rubrum* in transmission electron microscope ( $\times 100,000$ )

# Electron microscope(SEM)

The specimen is placed in the vacuum chamber and covered with a thin coat of gold. The electron beam then scans across the specimen and knocks loose showers of electrons that are captured by a detector. An image builds line by line, as in a television receiver. Electrons that strike a sloping surface yield fewer electrons, thereby producing a darker contrasting spot and a sense of three dimensions.

The resolving power of the conventional SEM is about 10 nm and magnifications with the SEM are limited to about 20,000x.

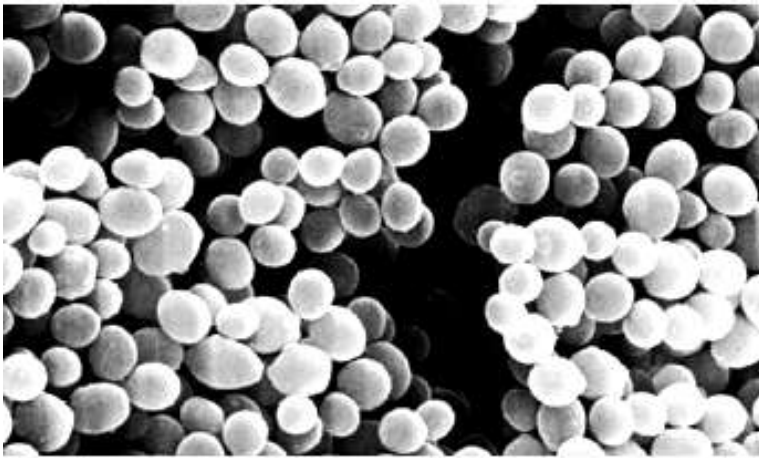

(a) *S. aureus*



(b) *Cristispira*

**Figure 2.24** Scanning Electron Micrographs of Bacteria. (a) *Staphylococcus aureus* ( $\times 32,000$ ). (b) *Cristispira*, a spirochete from the crystalline style of the oyster, *Ostrea virginica*. The axial fibrils or periplasmic flagella are visible around the protoplasmic cylinder ( $\times 6,000$ ).

# Electron microscope(SEM)

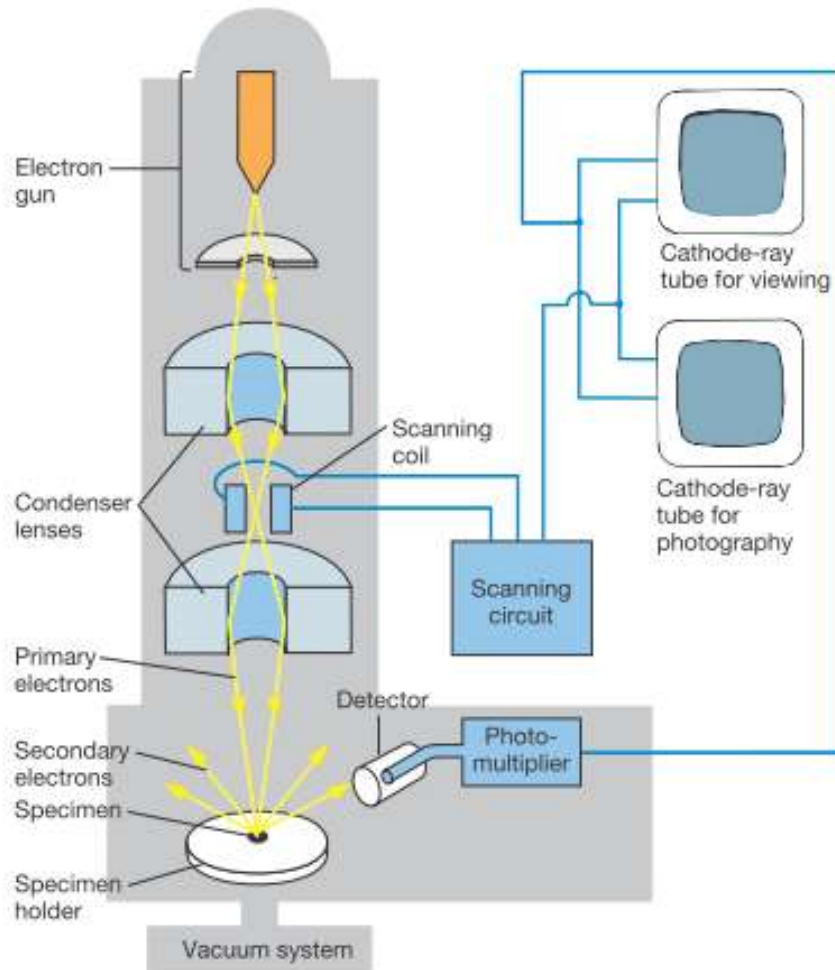

SEM

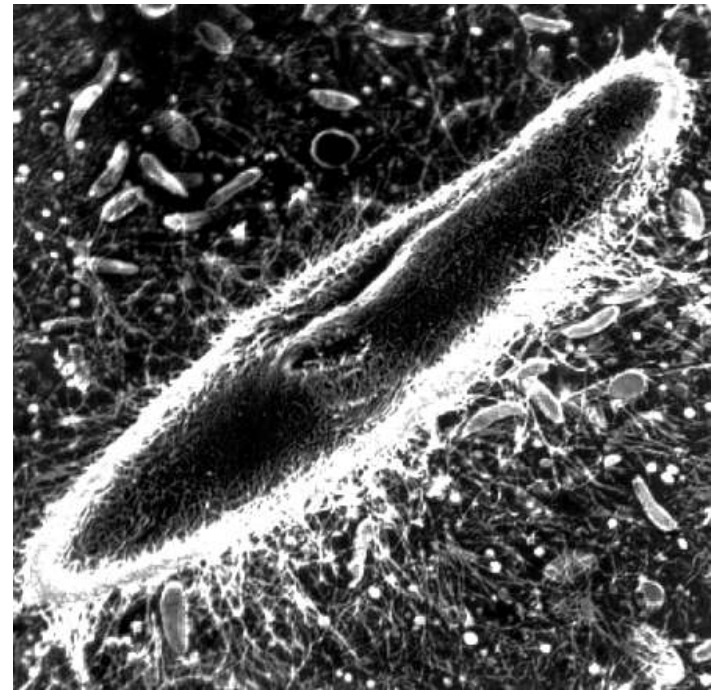

Paramecium

# Light Vs Electron microscope

Characteristic	Light or Optical	Electron (Transmission)
Useful magnification	2,000×	1,000,000 or more
Maximum resolution	200 nm	0.5 nm
Image produced by	Visible light rays	Electron beam
Image focused by	Glass objective lens	Electromagnetic objective lenses
Image viewed through	Glass ocular lens	Fluorescent screen
Specimen placed on	Glass slide	Copper mesh
Specimen may be alive	Yes	No
Specimen requires special stains or treatment	Not always	Yes
Colored images produced	Yes	No

# Uses

Microscope	Important Features
<b>Visible light as source of illumination</b>	
Bright-field	Common multipurpose microscope for live and preserved stained specimens; specimen is dark, field is white; provides fair cellular detail
Dark-field	Best for observing live, unstained specimens; specimen is bright, field is black; provides outline of specimen with reduced internal cellular detail
Phase-contrast	Used for live specimens; specimen is contrasted against gray background; excellent for internal cellular detail
<b>Ultraviolet rays as source of illumination</b>	
Fluorescent	Specimens stained with fluorescent dyes or combined with fluorescent antibodies emit visible light; specificity makes this microscope an excellent diagnostic tool
<b>Electron beam forms image of specimen</b>	
Transmission electron microscope (TEM)	Sections of specimen are viewed under very high magnification; finest detailed structure of cells and viruses is shown; used only on preserved material
Scanning electron microscope (SEM)	Scans and magnifies external surface of specimen; produces striking three-dimensional image



Thank you