

CMOS Process

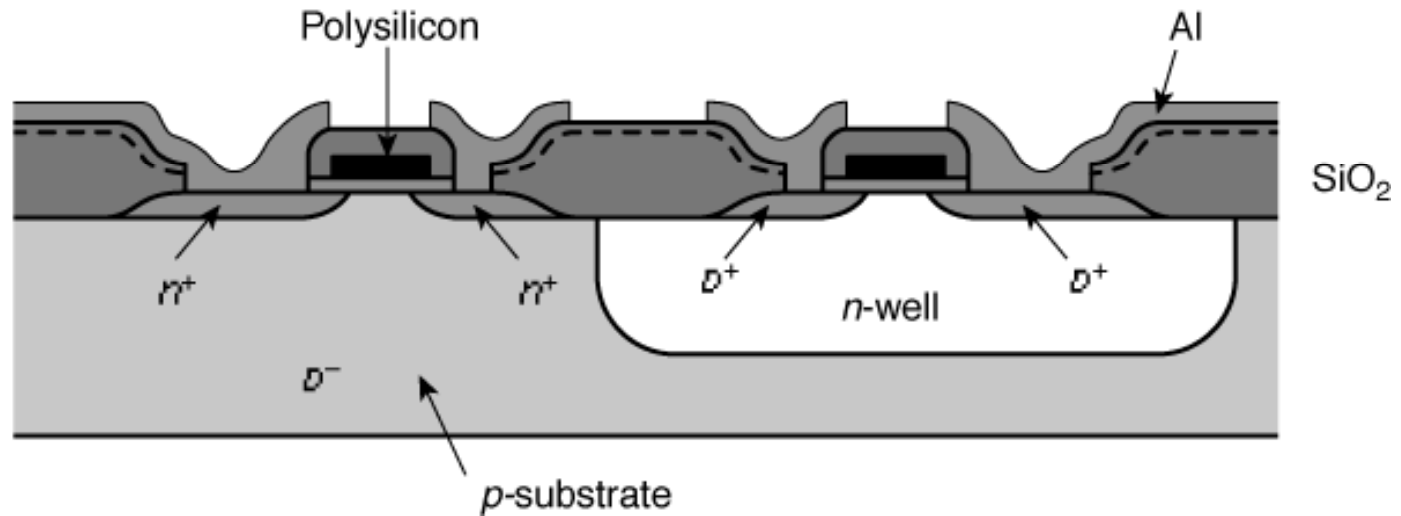

A Modern CMOS Process

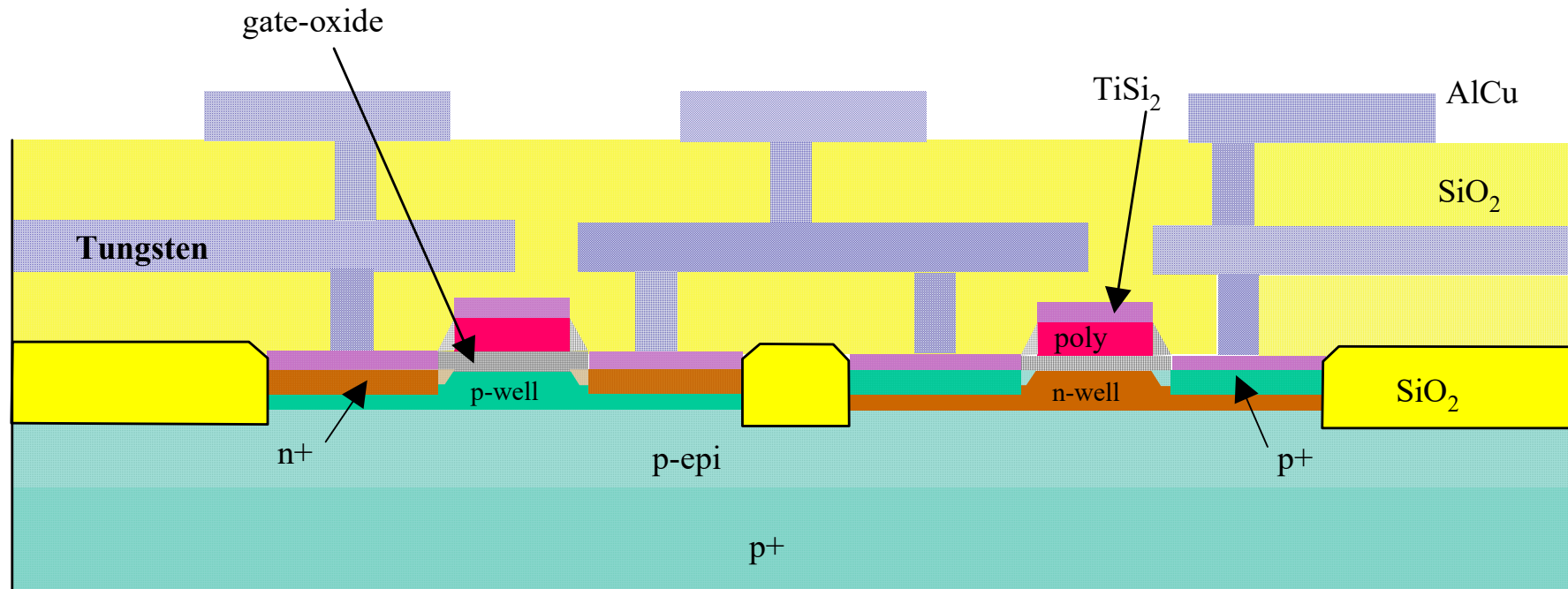

Dual-Well Trench-Isolated CMOS Process

Circuit Under Design

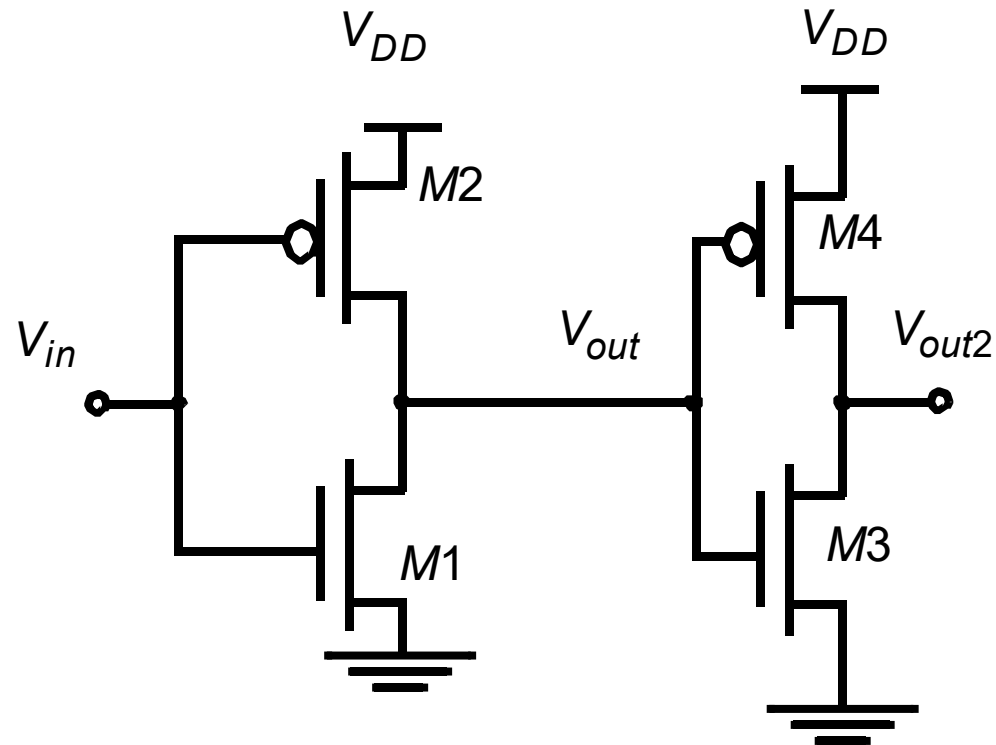

Its Layout View

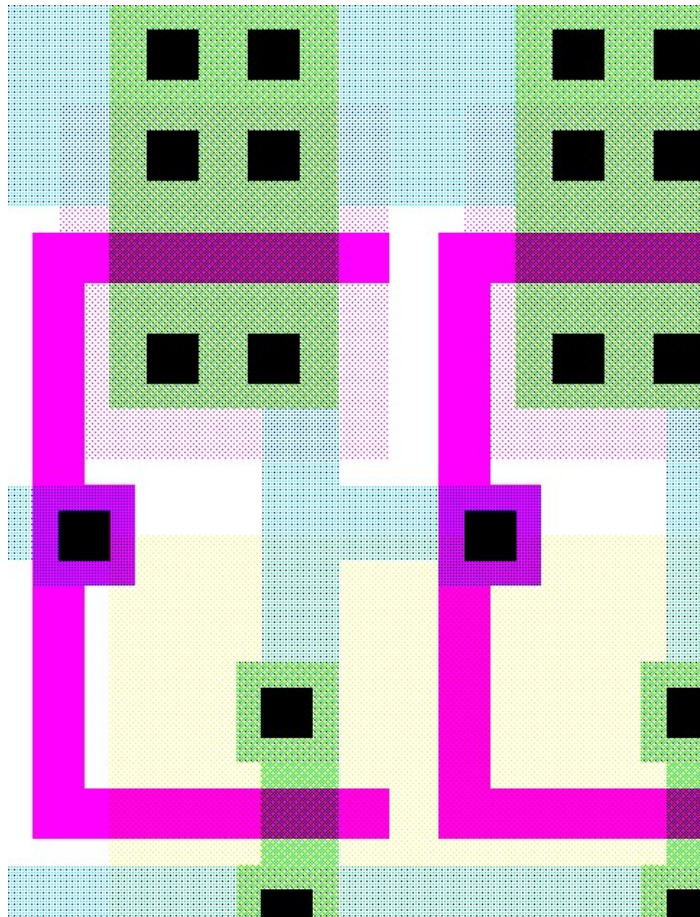

The Manufacturing Process

For a great tour through the IC manufacturing process and its different steps, check

<http://www.fullman.com/semiconductors/semiconductors.html>

Photo-Lithographic Process

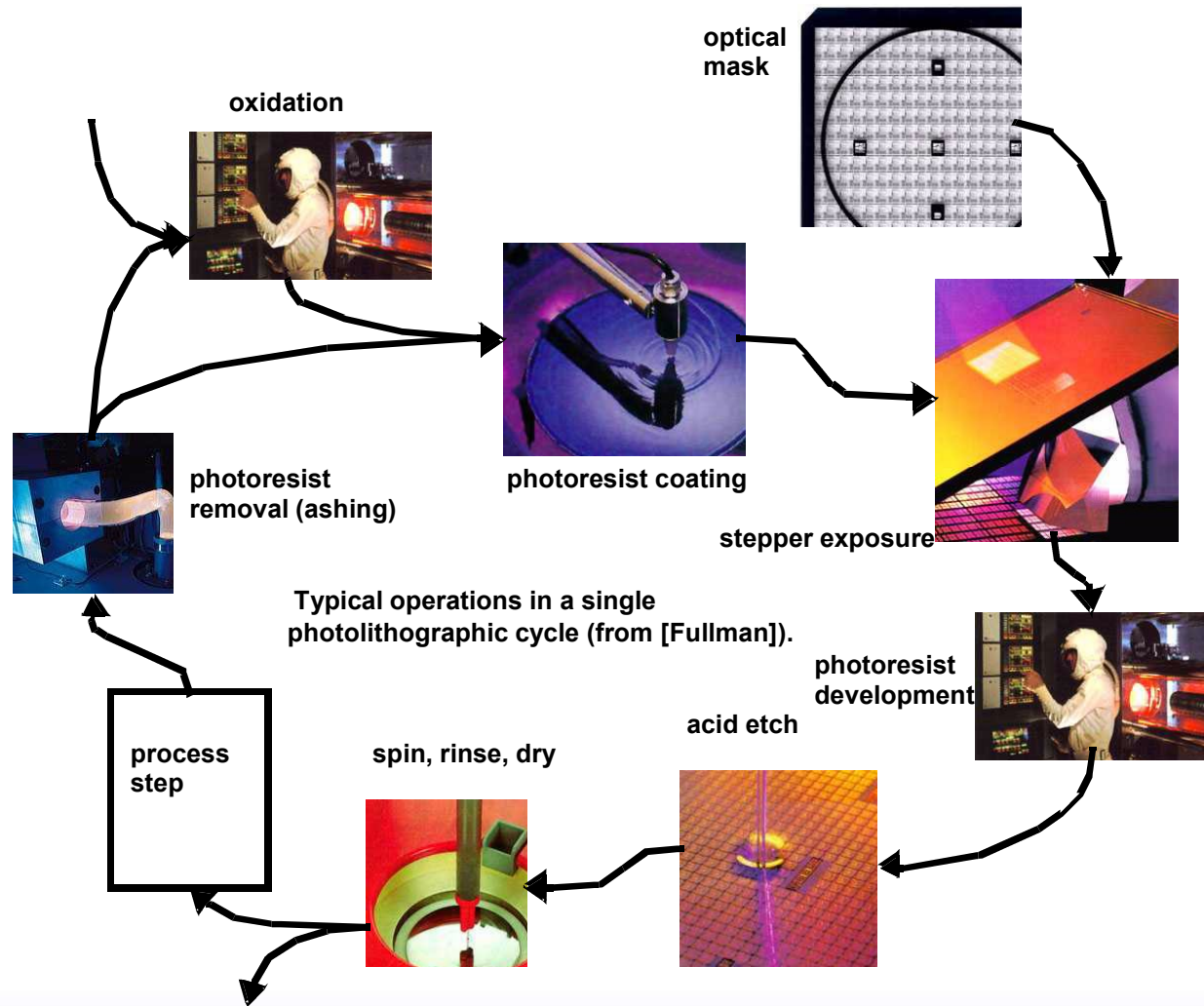

Patterning of SiO₂

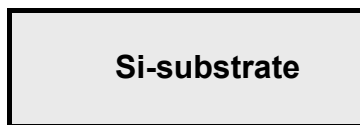

(a) Silicon base material

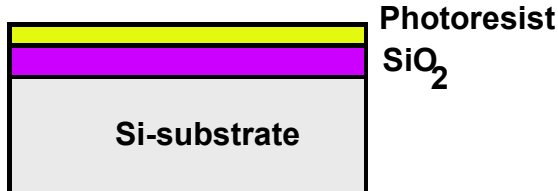

(b) After oxidation and deposition of negative photoresist

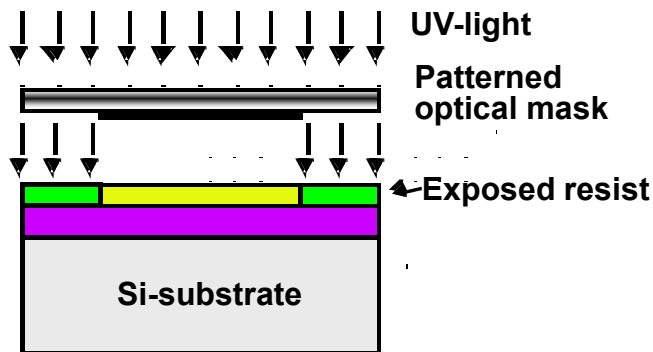

(c) Stepper exposure

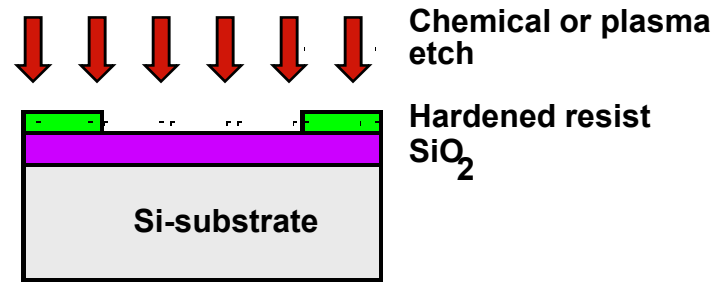

(d) After development and etching of resist, chemical or plasma etch of SiO₂

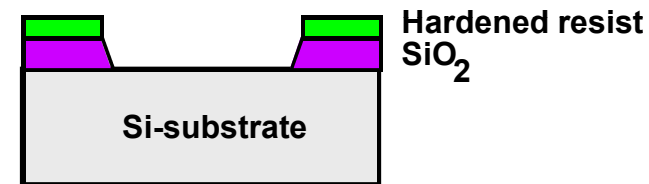

(e) After etching

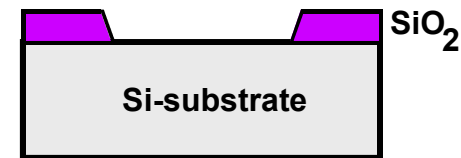

(f) Final result after removal of resist

CMOS Process at a Glance

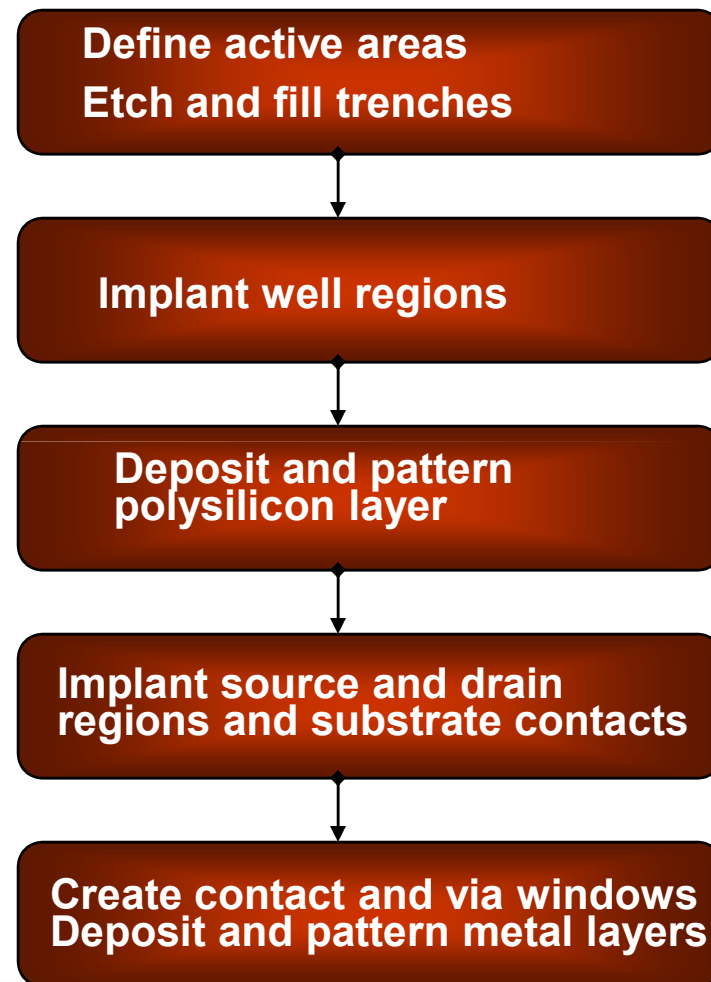

CMOS Process Walk-Through

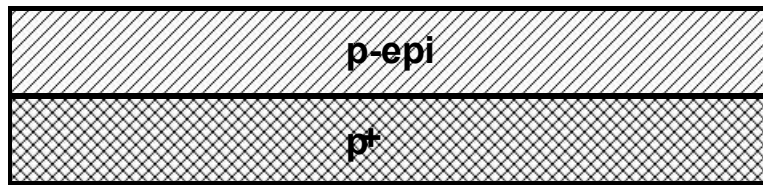

(a) Base material: p+ substrate with p-epi layer

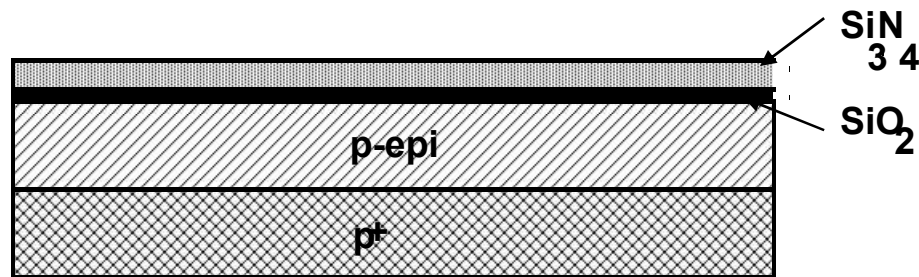

(b) After deposition of gate-oxide and sacrificial nitride (acts as a buffer layer)

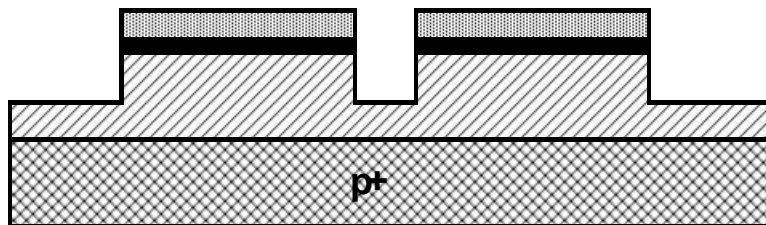

(c) After plasma etch of insulating trenches using the inverse of the active area mask

CMOS Process Walk-Through

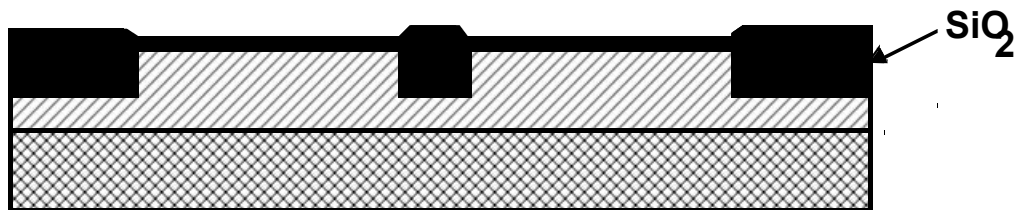

(d) After trench filling, CMP planarization, and removal of sacrificial nitride

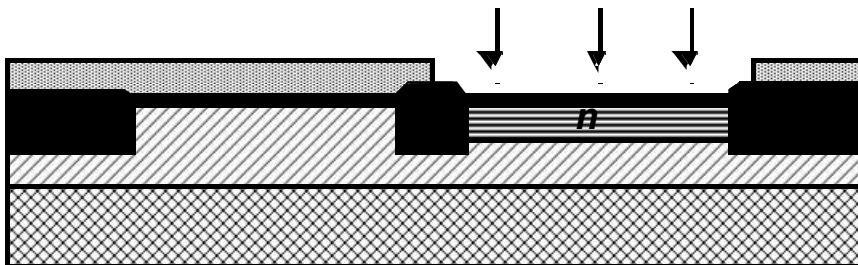

(e) After n-well and V_{Tp} adjust implants

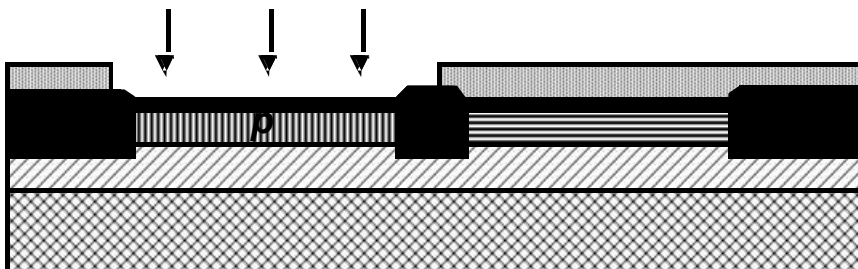

(f) After p-well and V_{Tn} adjust implants

CMOS Process Walk-Through

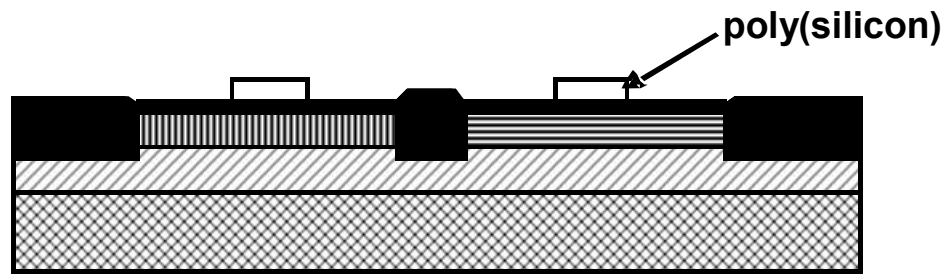

(g) After polysilicon deposition and etch

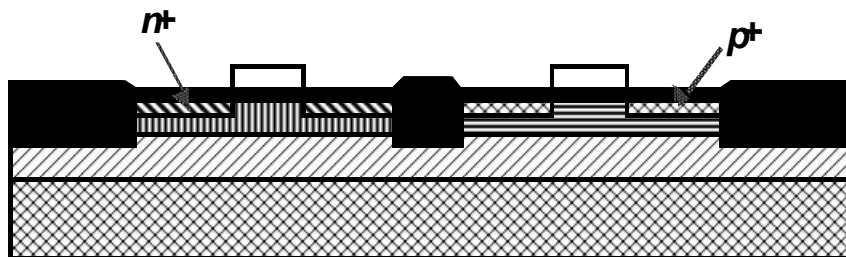

(h) After n^+ source/drain and p^+ source/drain implants. These steps also dope the polysilicon.

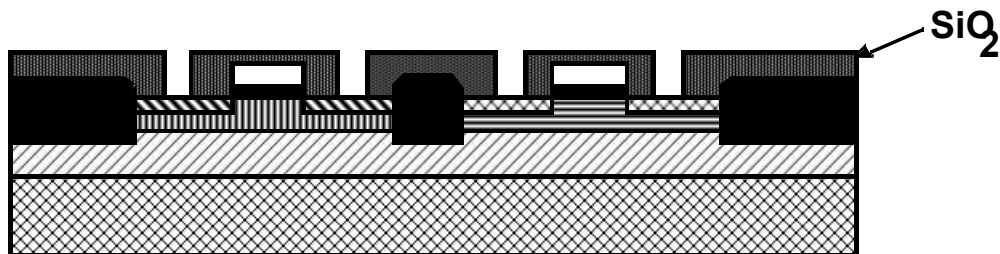

(i) After deposition of SiO_2 insulator and contact hole etch.

CMOS Process Walk-Through

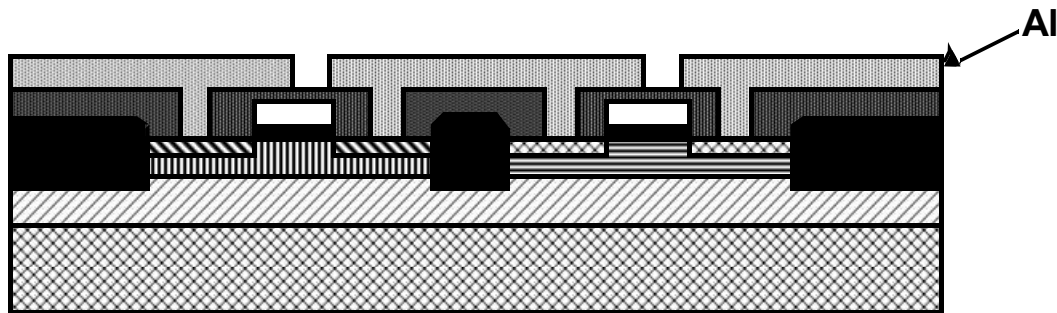

(j) After deposition and patterning of first Al layer.

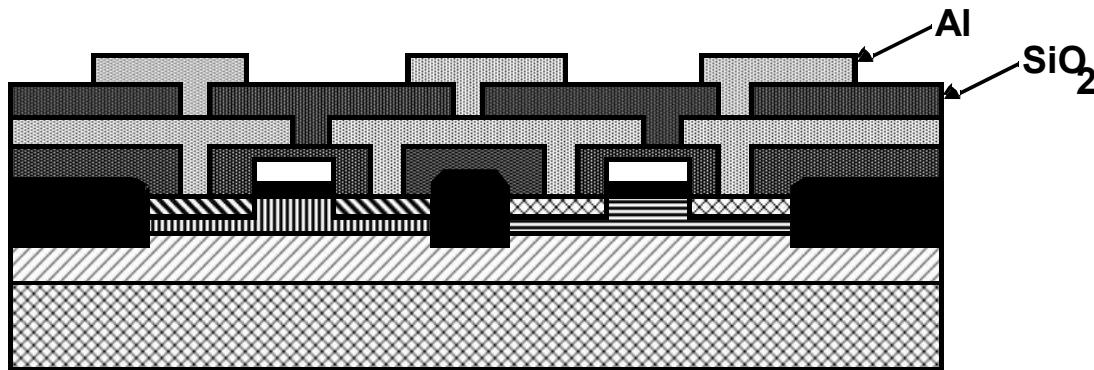

(k) After deposition of SiO_2 insulator, etching of via's, deposition and patterning of second layer of Al.

Advanced Metallization

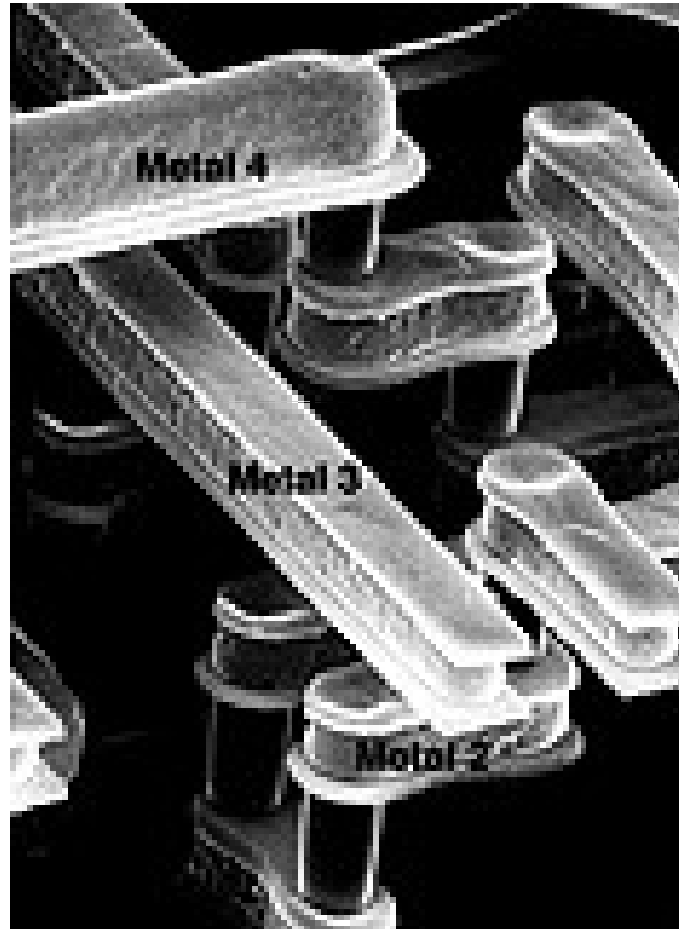

Advanced Metallization

