

Derivation of I/V Characteristics

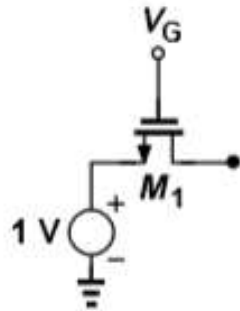

- If $V_{DS} \ll 2(V_{GS} - V_{TH})$, the device is operating in “deep triode region.”
- In this region, a MOSFET can operate as a resistor whose value is controlled by the overdrive voltage.
- Unlike bipolar transistors, a MOS device may be on even if it carries no current.

Derivation of I/V Characteristics



- For example, given the topology on the left and that

- $\mu_n C_{ox} = 50 \mu\text{A}/\text{V}^2$,
- $W/L = 10$,
- $V_{TH} = 0.3 \text{ V}$,

$$R_{on} = \frac{1}{50 \mu\text{A}/\text{V}^2 \times 10 (V_G - 1 \text{ V} - 0.3 \text{ V})}$$

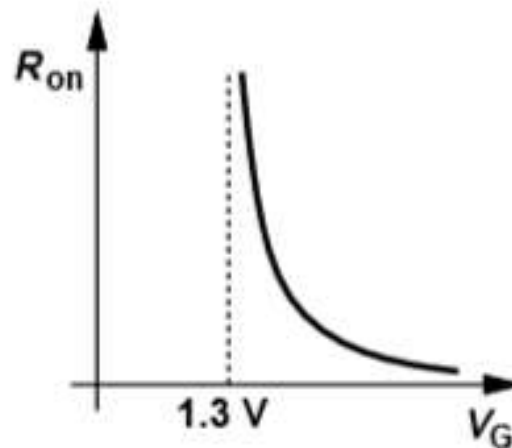

Derivation of I/V Characteristics

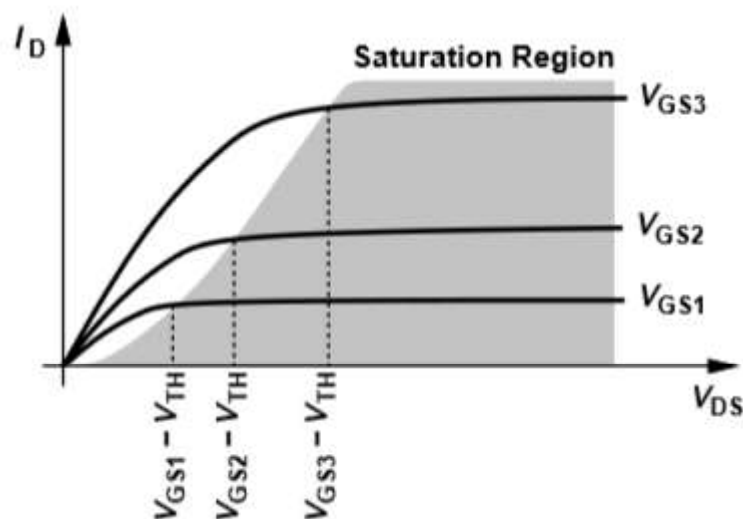

- In reality, if $V_{DS} > V_{GS} - V_{TH}$, I_D becomes relatively constant and we say that the device operates in “saturation region.”
- $V_{D,sat} = V_{GS} - V_{TH}$ denotes the minimum V_{DS} necessary for operation in saturation.

Derivation of I/V Characteristics

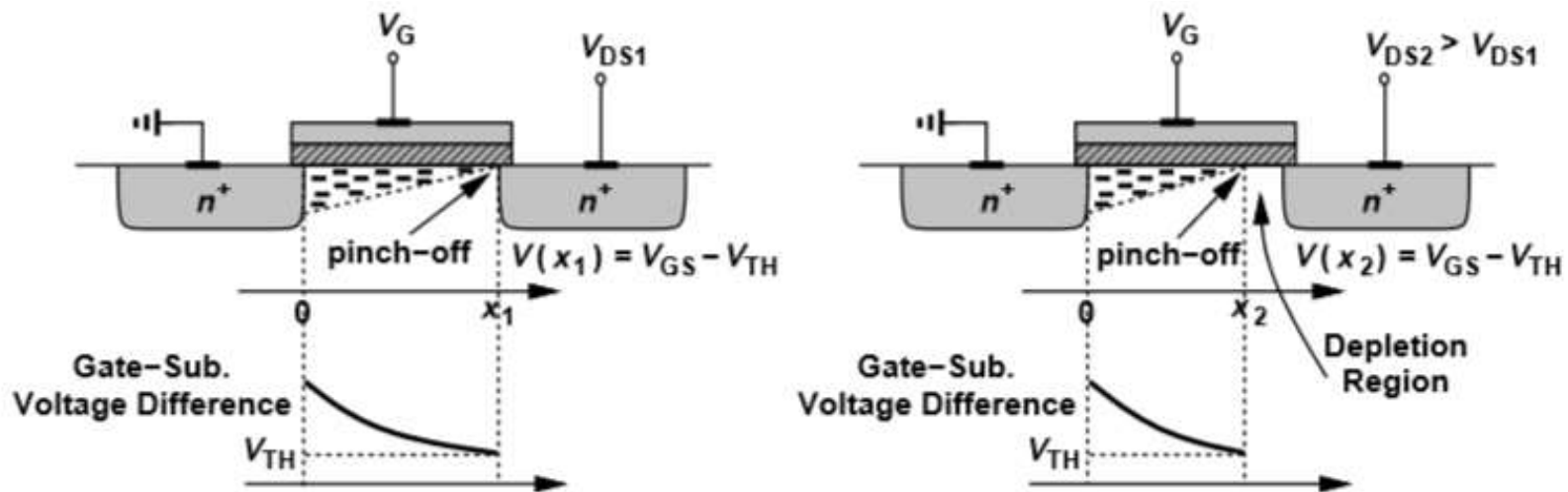

- If V_{DS} is slightly larger than $V_{GS} - V_{TH}$, the inversion layer stops at $x \leq L$, and the channel becomes “pinched off.”
- As V_{DS} increases, the point at which Q_D equals zero gradually moves towards the source.
- At some point along the channel, the local potential difference between the gate and the oxide-silicon interface is not sufficient to support an inversion layer.

Derivation of I/V Characteristics

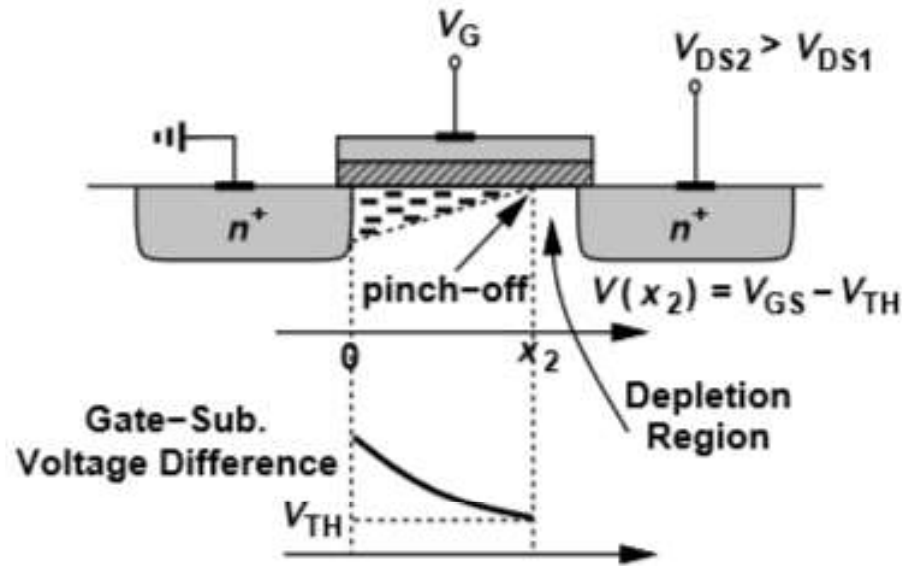

- Electron velocity ($v = I/Q_d$) rises tremendously as they approach the pinch-off point (where $Q_d \rightarrow 0$) and shoot through the depletion region near the drain junction and arrive at the drain terminal.

Derivation of I/V Characteristics

$$V_{GS} = \sqrt{\frac{2I_D}{\mu_n C_{ox} \frac{W}{L'}}} + V_{TH}$$

- Since the integral becomes

$$\int_{x=0}^{x=L'} I_D dx = \int_{V=0}^{V=V_{GS}-V_{TH}} WC_{ox}\mu_n[V_{GS} - V(x) - V_{TH}]dV.$$

$$I_D = \frac{1}{2}\mu_n C_{ox} \left(\frac{W}{L'}\right) (V_{GS} - V_{TH})^2.$$

-
- I_D is relatively independent of V_{DS} if L' remains close to L .
- The device exhibits a “square-law” behavior.

Derivation of I/V Characteristics

- For PMOS devices, the equations become
 - $I_D = -\mu_p C_{ox} \frac{W}{L} \left[(V_{GS} - V_{TH}) V_{DS} - \frac{1}{2} V_{DS}^2 \right]$.
 - $I_D = -\frac{1}{2} \mu_p C_{ox} \frac{W}{L'} (V_{GS} - V_{TH})^2$.
- The negative sign shows up due to the assumption that drain current flows from drain to source, whereas holes in a PMOS flow in the reverse direction.
- V_{GS} , V_{DS} , V_{TH} , and $V_{GS} - V_{TH}$ are negative for a PMOS transistor that is turned on.
- Since the mobility of holes is about $\frac{1}{2}$ the mobility of electrons, PMOS devices suffer from lower “current drive” capability.

Derivation of I/V Characteristics

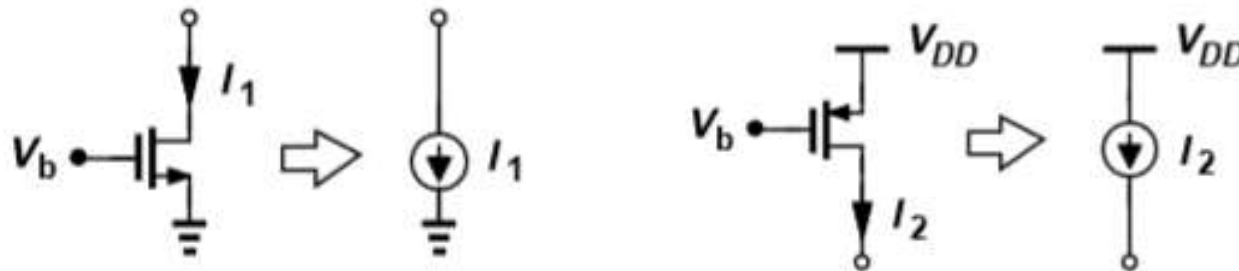

- A saturated MOSFET can be used as a current source connected between the drain and the source.
- NMOS current sources inject current into ground while PMOS current sources draw current from V_{DD} .

Derivation of I/V Characteristics

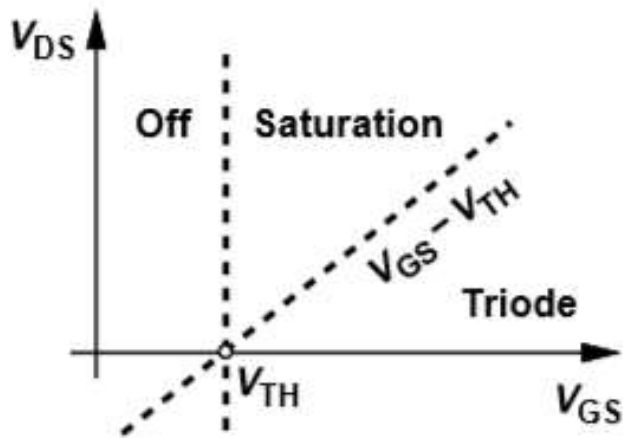

- $V_{DS} = V_{GS} - V_{TH} = V_{D,sat}$ is the line between saturation and triode region.
- For a given V_{DS} , the device eventually leaves saturation as V_{GS} increases.
- The drain is defined as the terminal with a higher (lower) voltage than the source for an NMOS (PMOS).

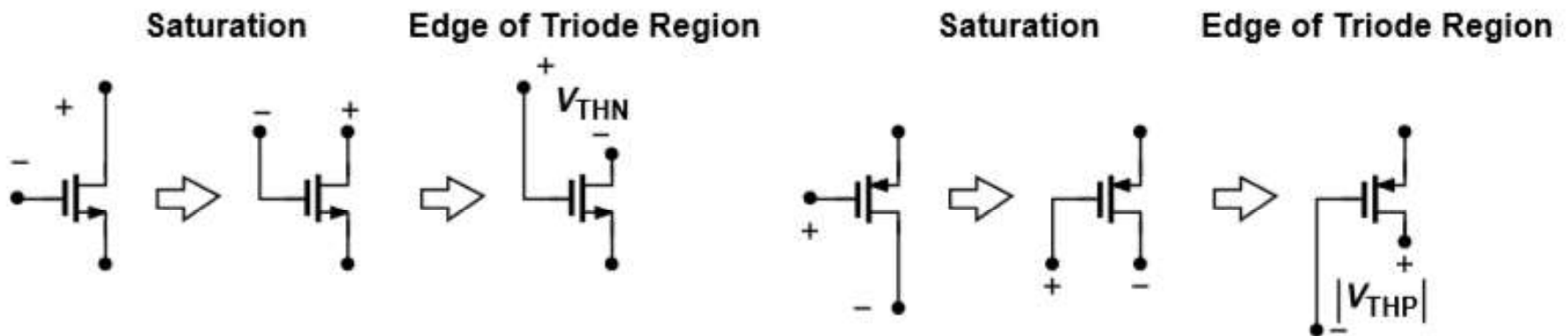

MOS Transconductance

$$\begin{aligned} g_m &= \left. \frac{\partial I_D}{\partial V_{GS}} \right|_{V_{DS} \text{ const.}} = \mu_n C_{ox} \frac{W}{L} (V_{GS} - V_{TH}) \\ &= \sqrt{2\mu_n C_{ox} \frac{W}{L} I_D} = \frac{2I_D}{V_{GS} - V_{TH}}. \end{aligned}$$

- **Transconductance (usually defined in the saturation region) is defined as the change in drain current divided by the change in the gate-source voltage.**
- **g_m represents the sensitivity of the device since a high value implies a small change in V_{GS} will result in a large change in I_D .**
- **Transconductance in saturation region is equal to the inverse of R_{on} in the deep triode region.**

MOS Transconductance

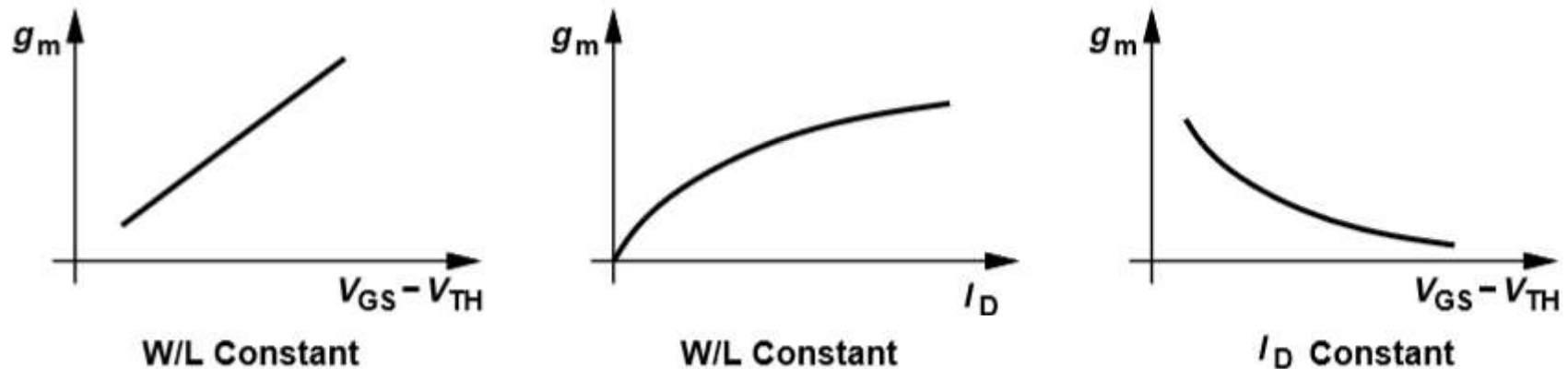

- Each expression for transconductance is useful in studying its behavior.
- Drain current and overdrive voltage are *bias* values.
- If a small signal is applied to a device with defined bias values, we assume the signal amplitude is small enough that the variation in transconductance is negligible.

MOS Transconductance

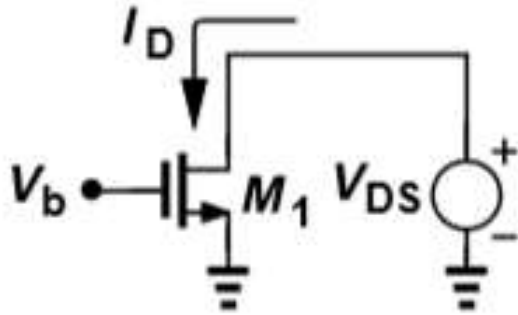

- To find the transconductance for the topology on the left with respect to V_{DS} ,
 - So long as $V_{DS} \geq V_b - V_{TH}$, M_1 is in saturation, so I_D is relatively constant, and therefore so is g_m .
 - When M_1 enters triode region

($V_{DS} < V_b - V_{TH}$),

$$g_m = \frac{\partial}{\partial V_{GS}} \left\{ \frac{1}{2} \mu_n C_{ox} \frac{W}{L} \left[2(V_{GS} - V_{TH})V_{DS} - V_{DS}^2 \right] \right\} = \mu_n C_{ox} \frac{W}{L} V_{DS}.$$

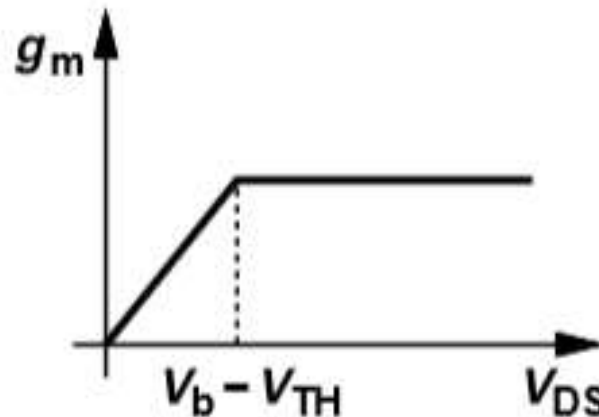

MOS Transconductance

- For PMOS,

$$\begin{aligned}g_m &= -\mu_p C_{ox} (W/L) (V_{GS} - V_{TH}) \\ &= -2I_D / (V_{GS} - V_{TH}) \\ &= \sqrt{2\mu_p C_{ox} (W/L) I_D}.\end{aligned}$$