

# Market Milk

*Latha Sabikhi*

*Y. Kotilinga Reddy*

2016

*Market Milk*

*Latha Sabikhi*

Dairy Technology Division  
NDRI, Karnal

*Y. Kotilinga Reddy*

Dairy Technology Department  
SVVU, Tirupati

Living in the favourable and unfavourable situation is called  
"PART OF LIFE",  
But smiling in all those situations is called  
"ART OF LIFE".

EDITOR

*AgriMoon.Com*

**MARKET MILK**  
**Course Outline 4 (3+1)**

**Module 1: Introduction and history of dairy development in India**

Lesson 1. Dairying in India - Distinctive features

Lesson 2. Dairy development in India - Before and after Operation Flood

**Module 2: Milk production and consumption**

Lesson 3. Data - Milk production and consumption

**Module 3: Clean milk production**

Lesson 4. Practices related to animal and milking personnel

Lesson 5. Milking process and environment

**Module 4: Procurement of milk**

Lesson 6. Milk collecting systems and pricing policies

Lesson 7. Preservation of raw milk

Lesson 8. Lactoperoxidase - Thiocyanates (LP) system

Lesson 9. Transportation of raw milk

**Module 5: Physico-chemical, microbiological and nutritional properties of milk**

Lesson 10. Physical properties and composition of milk

Lesson 11. Macro components of milk - Fat and lactose

Lesson 12. Macro components of milk - Protein

Lesson 13. Micro components of milk

Lesson 14. Microbiology of raw milk

Lesson 15. Nutritional properties of milk

**Module 6: Common dairy operations**

Lesson 16. Reception of milk

Lesson 17. Chilling and storage of milk

Lesson 18. Filtration and clarification

Lesson 19. Separation of milk - Theory and methods

Lesson 20. Separation of milk - Cream separators

Lesson 21. Bactofugation

Lesson 22. Standardization of milk

Lesson 23. Homogenization - Definition and theories

Lesson 24. Homogenization - Types and operation of homogenizers

Lesson 25. Homogenization - Effect on milk properties

Lesson 26. Principles of heat treatment

Lesson 27. Kinetic parameters of heat induced changes

Lesson 28. Principle and methods of pasteurization

Lesson 29. Heat exchangers - Plate and tubular type

Lesson 30. Working of HTST pasteurizer

Lesson 31. Sterilization - Definition, purpose and methods

Lesson 32. Ultra-high temperature process

Lesson 33. UHT milk - Homogenization, packaging and defects

## **Module 7: Processed milk varieties**

Lesson 34. Legal standards and variants of market milk

Lesson 35. Special milks

## **Module 8: Cleaning and sanitization**

Lesson 36. Common dairy detergents and their properties

Lesson 37. Dairy sanitizers and their properties

Lesson 38. Cleaning and sanitization protocols - CIP and SIP

Lesson 39. Tests for detergents and sanitizers

## **Module 9: Packaging of milk**

Lesson 40. Packaging - materials and process

## **Module 10: Quality assurance in milk processing**

Lesson 41. Quality assessment of raw milk

Lesson 42. Detection of preservatives, neutralizers and adulterants

Lesson 43. Chemical quality of milk - Fat, SNF, TS and acidity

Lesson 44. Microbiological quality of milk

## **Module 11: Indian food regulation in global scenario**

Lesson 45. Quality and safety regulations

## *Module 1. Introduction and history of dairy development in India*

### **Lesson 1**

### **DAIRYING IN INDIA - DISTINCTIVE FEATURES**

#### **1.1 Introduction**

Milk is the substance created by nature to feed the mammalian offspring. All species of mammals produce milk for this purpose. Several centuries ago, perhaps as early as 6000-8000 BC, ancient man learned to domesticate species of animals for obtaining their milk for consumption. These included cows, buffalos, sheep, goats and camels, all of which are still used in various parts of the world for the production of milk for human use. The ancient Indian scriptures provide ample proof of dairying being an integral part of life in the olden days.

Dairying in India is considered an implement for social change. The nation's milk supply comes from millions of small producers, dispersed throughout the rural areas. These farmers maintain an average herd of one or two milch animals, comprising cows and/or buffalos. The animals' nutritional requirements are largely met by agricultural waste and byproducts. Milk production in India is dominated by small and marginal landholding farmers and by landless labourers who, in aggregate, own about 70 percent of the national milch animal herd. This pattern is in sharp contrast to that in the advanced countries of the world which practice specialized dairy farming. This small scale and scattered production creates a serious problem in marketing of milk. Organized dairying on the pattern of developed countries is conspicuous by its absence in India. Although the major challenge for the dairy sector is to increase milk production, policies must become more market-oriented.

#### **1.2 Milk Production**

India ranks first in respect of cattle and buffalo, second in goat and third in sheep population in the world. As per 2008 data, India has more than 175 million cattle which are about 13% of the global cattle population ([www.fao.org](http://www.fao.org)). Of these, nearly 23 million are crossbred, comprising nearly 13% of the total cattle population. The country has nearly 99 million buffalo population, which is about 55% of the world buffalo population. However, in spite of this large cattle wealth and India's position as the highest producer of milk, productivity per animal is only 987 kg/lactation as compared to the world average of 2038 kg/lactation ([www.dahd.nic.in](http://www.dahd.nic.in)). The typical size of animal holding is only 1 to 5 due to poor economic conditions. Milch animals are reared mainly through the utilization of crop residues in India, thus making milk production subsidiary activity to agriculture. In the advanced dairying countries, milk is produced from comparatively fewer, but high producing animals. In countries such as Denmark and Israel, though the total number of bovine population has steadily declined over the past decade, the total milk production has gone up, thus pointing to increased productivity of animals.

The trend of the past two decades indicates that global milk production has grown only by 0.78% as against the growth rate of 4.07% in India. India has the distinction of being the largest milk producer in the world, with 110.04 million tonnes (MT) of milk produced in 2009 ([www.fao.org](http://www.fao.org)), despite very low productivity per animal. Cow milk (44 MT) accounts for about 40% of the milk produced in India, while buffalo milk (61 MT) makes up about 56% and other milch animals such as goat, sheep and camel account for the remaining 4%. The highest cow milk production was

registered by USA accounting for a share of 15% in the world, whereas buffalo milk production was the highest in India with a global share of 68%.

India is among the world's largest and fastest growing market for milk and milk products, the market size in value terms being USD 47.6 billion (INR 2000 billion) growing at nearly 7.5% annually. In India, along with Oceania and USA, where milk is produced at competitive prices, prospects for future growth seem bright during the current century. India is able to produce milk at very competitive prices on global basis owing to the use of crop residues for rearing the animals. Owing to this, huge opportunities exist in the export of milk and value added milk products to neighboring countries where domestic production cannot meet demand. As subsidies on agriculture commodities have to be withdrawn as per the directives of the World Trade Organization (WTO), most of the exporting nations of European Union were compelled to readjust their economies by curtailing milk production.

### 1.3 Dairy Animals

Domesticated cattle are usually classified into two major groups namely zebu (*Bos indicus*- Fig. 1.1) and European (*Bos taurus* - Fig. 1.2). Most of the cattle indigenous to the tropics belong to the zebu species.



**Fig. 1.1 Zebu cattle**



**Fig. 1.2 European cattle**

The term humped cattle is frequently used as a synonym to zebu cattle because the external trait which most clearly separates zebu from European type cattle is the hump over the shoulders. Zebu cattle are well adapted to the tropical environments, mainly owing to a high degree of heat tolerance, partial resistance to ticks and thus to the many tick-borne diseases occurring in tropical countries, low nutritional requirements due to small size, low metabolic rate, and may ensure more efficient digestion at low feeding levels. However, the potential for milk production is poorly developed in most zebu cattle and therefore, the milk yield is low. Zebu animals are late maturing, both physiologically and sexually, and heat symptoms are weaker than in European cattle. The fat and solids-not-fat content of milk is higher in zebu cattle than in most European dairy breeds. Some of the well known indigenous breeds of milch cattle are Sahiwal, Red Sindhi, Tharparkar, Hariana and Kankarej. For small and marginal farmers and in conditions where feed resources are limited, upgradation of non-descript stock could be done by utilizing superior germplasm of indigenous breeds. Systematic efforts to increase milk production in tropical

countries by crossbreeding with European dairy breeds dates back to early years of the last century. Exotic breeds namely Jersey, Holstein-Friesen, Brown Swiss and Red Dane were employed for the venture. The milch bovine population in the country as per the 2003 Livestock Census is nearly 116 million, of which buffalos, indigenous and crossbred cows comprise 44, 45 and 11% respectively ([www.nddb.org](http://www.nddb.org)). In India, most of the milk produced (~ 56%) is buffalo milk. In the hot and humid climate of the country, the water buffalo contributes more to milk production than the cow because of its inherent ability to thrive under the adverse climatic conditions. Buffalo population has increased at a faster rate than cattle, confirming the pivotal role the buffalo plays in the agricultural economy of Indian sub-continent. Buffalos are known to be more efficient converters of poor quality roughages and crop residues into a valuable milk commodity. The Murrah (Fig. 1.3) is known to be the best milk yielding breed among buffalos.



**Fig. 1.3 Murrah buffalo**

## 1.4 Milk Consumption

The role and consumption pattern of milk in the traditional diet varies widely in different regions of the world. The tropical countries have not been traditional milk consumers, whereas in Europe and North America, traditionally milk and milk products have been parts of the diet. The total milk consumption (as fluid milk and processed products) per person varies widely from highs in Europe and North America to lows in Asia. However, as the various regions of the world become more integrated through travel and migration, these trends are changing, a factor which needs to be considered by product developers and marketers of milk and milk products in various countries of the world.

In tropical countries where high temperatures and lack of refrigeration has led to the inability to store fresh milk, milk has conventionally been preserved through means other than refrigeration. These include immediate consumption of warm milk after milking, boiling milk, or use of fermentation and drying to convert milk to more stable products. Even within regions such as Europe, the custom of milk consumption has varied greatly.

\*\*\*\*\* 😊 \*\*\*\*\*

## Lesson 2

### DAIRY DEVELOPMENT IN INDIA - BEFORE AND AFTER OPERATION FLOOD

#### 2.1 Introduction

History of dairy development in India can be divided into two distinct phases: pre- and post-Operation Flood. The Defence Department under the British rule established military dairy farms to ensure the supply of milk and butter to the colonial army. The first of these farms was set up in Allahabad in 1913, followed by Bangalore, Ooty and Karnal. These farms were well maintained and used improved milch animals. Some herd improvement practices such as artificial insemination was also followed.

However, this did not have much impact on the civilian consumers. With the growth of the population in urban areas, consumers had to depend on milk vendors who kept cattle in these areas and sold their milk, often door-to-door. As a result, several cattle sheds came into existence in different cities, which led to environmental problems. As the main objective of the milk vendors was to maximize profit, they started increasing the lactation period. Consequently, these high-yielding cattle developed sterility problems, which considerably reduced the number of calvings. Once the cattle became unproductive, they were sold to slaughterhouses, thus systematically draining the country of its genetically superior breeds.

The onset of the Second World War gave momentum to private dairies with some modernized processing facilities. In the metros of the then Bombay, Calcutta, Madras and Delhi, and some large towns, processed milk, table butter and ice-cream were available, though on a limited scale. Polsons, Keventers and the Express Dairy were some of the pioneer urban processing dairies. However, these dairies were more concerned with cornering more milk and profit making than improving the breeds of milch animals. Therefore, despite some modernized processing facilities, dairying remained unorganized.

Modernization of the dairy industry became a priority for the government after first Five-Year Plan in 1951 and it was put in place. The goal was to provide hygienic milk to the country's growing urban population. At the outset, 'milk schemes' were set up in large cities. The government implemented programmes such as the Integrated Cattle Development Project (ICDP), Key Village Scheme (KVS) and several others to stimulate milk production. However, milk production remained more or less stagnant owing to the absence of a stable and remunerative market for milk producers. During the two decades between 1951 and 1970, the annual growth rate in milk production was just about 1% although the state governments tried out different policies to develop dairying. These strategies included establishing dairies run by their own departments, setting up cattle colonies in urban areas and organizing milk schemes. Almost invariably, dairy processing plants were built in cities rather than in the milksheds where milk was produced, leading to establishment of cattle colonies in the then Bombay, Calcutta and Madras. These government projects found organizing rural milk procurement and running milk schemes economically extremely difficult. No attention was paid to create an organized system for procurement of milk, which was left to contractors and middlemen. Milk's perishable nature and relative scarcity gave the milk vendors considerable advantage.

The government-run dairy plants extended buffalo milk by reconstituting large quantities of relatively cheap, commercially imported milk powder to bring down the milk price.



Consequently, the domestic milk production decreased. The government dairies were meeting barely one-third of the urban demand, while the rural milk producers squirmed in the clutches of the traders and the moneylenders. The establishment and prevalence of cattle colonies resulted in a major genetic drain on the rural milch animal population, which would never be replaced. City dairy colonies contributed to environmental degradation, while the rural producers derived no incentive in increasing milk production.

## 2.2 The Co-operative Movement

The strategy for organized dairy development in India was actually conceived in the late 1960s, within a few years after the establishment of National Dairy Development Board (NDDB) in 1965. NDDB was established by an Act of Parliament with the objectives of promoting dairy cooperatives, financing dairy infrastructure through loans and grants and providing technical and managerial support to the dairy cooperative societies. The Operation Flood programme (OFP) was conceived by the NDDB and endorsed by the government. However, in 1969, when the Government of India approved the OFP and its financing through the monetization of World Food Programme-gifted commodities, it was found that the statutes under which NDDB was registered did not provide for handling of government funds. Therefore, in 1970 the government established a public-sector company, the Indian Dairy Corporation (IDC). The IDC was given responsibility for receiving the project's donated commodities, testing their quality, their storage and transfer to user dairies as well as receiving the dairies' payments. Thus the financial and promotional aspects were the responsibility of the IDC while the entire technical support for OFP was provided by NDDB.

OFP was set up with the objectives to enhance milk production, increase the rural income and to ensure reasonable price to the farmers for the milk they produce. OFP was implemented in three phases. The first phase (1970-1980) was financed by the sale of 1,26,000 MT of skimmed milk powder (SMP) and 42,000 MT of butter oil gifted by the European Union (then European Economic Community - EEC) through the World Food Programme. The programme involved organizing dairy cooperatives at the village level, creating the physical and institutional infrastructure for milk procurement, processing, marketing and production enhancement services at the union level and establishing dairies in India's major metropolitan cities. The main thrust was to set up dairy cooperatives in India's best milksheds, linking them with the four main cities of Bombay, Calcutta, Delhi and Madras, in which a commanding share of the milk market was to be captured. Thus, eighteen of India's premier milksheds were linked with consumers in India's four major metropolitan cities. In achieving that goal, the first phase of Operation Flood laid the foundation for India's modern dairy industry, an industry that would ultimately meet the country's need for milk and milk products.

Operation Flood's Phase II (1981-85) integrated the Indian Dairy Association-assisted dairy development projects being implemented in some Indian states into the overall programme. About US\$ 150 million was provided by the World Bank, with the balance of project financing obtained in the form of commodity assistance (2,16,584 MT of SMP, 62,402 MT of butter oil and 16,577 MT of butter) from the EEC. The milksheds increased from 18 to 136 and 290 urban markets expanded the outlets for milk. A self-sustaining system of 43,000 village cooperatives covering 4.25 million milk producers was established by the end of 1985. Domestic milk powder production in the established dairies increased from 22,000 tons in the pre-project year to 140,000 tons by 1989.

Phase III (1985-1996) of Operation Flood enabled dairy cooperatives to expand and strengthen the infrastructure required to procure and market increasing volumes of milk. It was funded by a World Bank credit of about US\$ 365 million and Rs. 226.5 crore worth of food aid (75,000 MT of SMP and 25,000 MT of butter oil/butter) from the EEC. Veterinary first-aid health care services,

feed and artificial insemination services for cooperative members were extended, along with intensified member education. More emphasis was given to research and development in animal health and animal nutrition. To avoid any duplication in their activities or overlap of functions, IDC and NDDB were eventually merged into a newly constituted NDDB by an Act of Parliament passed in October, 1987. The Act designated the NDDB as an institution of national importance and accorded it the same autonomy of operation that it had been bestowed with earlier.

India currently has 133349 village dairy cooperatives federated into 177 milk unions and 15 federations that procured on an average 25.1 million litres of milk every day. These village dairy cooperatives have nearly 13.9 million farmers as members ([www.nddb.org](http://www.nddb.org), 2008-09 figures). These cooperatives form part of the National Milk Grid which today links the milk producers in villages throughout India with consumers in over 700 towns and cities bridging the gap between the seasonal and regional variation in the availability of milk while at the same time ensuring a remunerative returns to the producers and quality milk and milk products at a reasonable price to the consumers. The future thrust areas of NDDB include strengthening the cooperative business, enhancing productivity, improving quality and building a National Information Network.

\*\*\*\*\* 😊 \*\*\*\*\*

*Module 2: Milk production and consumption*

**Lesson 3**

**DATA - MILK PRODUCTION AND CONSUMPTION**

**Table 3.1. Milk production in selected countries (million tonnes)**

<b>Region/ Country</b>	<b>1999</b>	<b>2001</b>	<b>2003</b>	<b>2005</b>	<b>2007</b>	<b>2009</b>
World	570.73	589.75	614.77	645.33	671.31	696.55
Australia	10.49	10.87	10.08	10.09	10.35	9.39
China	11.24	14.52	21.87	32.02	37.11	40.55
Denmark	4.66	4.55	4.68	4.58	4.60	4.81
France	25.63	25.67	25.42	25.71	24.55	24.22
Germany	28.36	28.21	28.56	28.49	27.94	28.69
India	78.24	83.42	86.66	95.62	102.92	110.04
Ireland	5.12	5.38	5.30	5.38	5.20	5.37
N. Zealand	10.88	13.12	14.35	14.64	15.84	15.22
Netherlands	11.17	10.97	11.08	10.85	10.75	11.47
UK	15.01	14.71	15.01	14.47	14.45	13.24
USA	73.80	74.99	77.29	80.25	84.19	85.86

*Source: <http://faostat.fao.org>*

**Table 3.2. Continents - Species-wise milk production - 2009 (million tonnes)**

<b>Region/ Continent</b>	<b>Cow</b>	<b>Buffalo</b>	<b>Goat</b>
World	580.48	90.33	15.13
Africa	27.65 (4.76)	2.64 (2.92)	3.21 (21.22)
America - North	94.07 (16.21)	-	-
America - Central	14.18 (2.44)		0.17
America - South	59.18 (10.20)	-	0.18 (1.12)
Asia	150.19 (25.87)	87.48 (96.85)	8.91 (58.89)
Europe	208.95 (36.00)	0.22 (0.24)	2.47 (16.33)
Oceania	24.67 (4.25)	-	0.04 (0.26)

Figures in parentheses indicate the global share in per cent

**Table 3.3. State-wise annual milk production ('000 tonnes)**

<b>Region/ State</b>	<b>2002-03</b>	<b>2003-04</b>	<b>2004-05</b>	<b>2005-06</b>	<b>2006-07</b>	<b>2007-08</b>	<b>2008-09</b>
<b>All India</b>	86159	88082	92484	97066	100869	104840	108463
<b>South</b>							
A&N Islands	26	25	24	20	23	24	26
Andhra Pradesh	6584	6959	7257	7624	7939	8925	9570
Karnataka	4539	3857	3917	4022	4124	4244	4538

# Market Milk

Kerala	2419	2111	2025	2063	2119	2253	2541
Lakshadweep	2	1	1	2	2	2	2
Pondicherry	37	40	41	43	45	46	46
Tamil Nadu	4622	4752	4784	5474	5560	5586	5673
<b>West/ Central</b>							
D&N Haveli	8	8	4	5	5	5	4
Daman & Diu	1	1	1	1	1	1	1
Goa	46	48	57	56	57	58	59
Gujarat	6089	6421	6745	6960	7533	7911	8386
Madhya Pradesh	5343	5388	5506	6283	6375	6572	6855
Maharashtra	6238	6379	6567	6769	6978	7210	7455
<b>North</b>							
Chandigarh	43	44	43	46	46	47	47
Delhi	296	299	303	310	289	282	285
Haryana	5124	5221	5222	5299	5367	5442	5745
Himachal Pradesh	773	786	870	869	872	874	884
J & K	1389	1414	1422	1400	1400	1498	1498
Punjab	8173	8391	8554	8909	9168	9282	9387
Rajasthan	7789	8054	8310	8713	9375	9436	9491
Uttar Pradesh	15288	15943	16512	17356	18095	18861	19537
Uttarakhand	1079	1188	1195	1206	1213	1221	1230
<b>East</b>							
Bihar	2869	3180	4743	5060	5450	5783	5934
Chhattisgarh	804	812	831	839	849	866	908
Jharkhand	952	954	1330	1335	1401	1442	1466
Orissa	941	997	1283	1342	1431	1625	1672
West Bengal	3600	3686	3790	3891	3982	4087	4176
<b>North-east</b>							
Arunachal Pradesh	46	46	48	48	49	50	24
Assam	705	727	739	747	751	752	753
Manipur	69	71	75	77	77	78	78
Meghalaya	68	69	71	73	75	77	77
Mizoram	15	15	16	15	16	17	17
Nagaland	58	63	69	74	67	45	53
Sikkim	45	48	46	48	49	49	49
Tripura	79	84	86	87	89	91	96

**Table 3.4. Projections of milk production**

Region/ Country	Production, 2007 (million tonnes)	Growth rate (%)	Future projections (million tonnes)		
			2010	2015	2020
World	671.31	2.1	714.50	792.74	879.54
India	102.92	3.2	113.12	132.42	155.00
USA	84.19	1.9	89.08	97.87	107.53
China	37.11	3.1	40.67	47.38	55.19
Germany	27.94	-0.1	27.86	27.72	27.58
France	24.55	-0.2	24.40	24.16	23.92
N. Zealand	15.84	4.9	18.28	23.23	29.50
UK	14.45	-0.02	14.44	14.43	14.41
Netherlands	10.75	0.2	10.82	10.92	11.03
Australia	10.35	0.5	10.51	10.77	11.04
Pakistan	33.23	6.0	39.58	52.96	70.88

**Table 3.5. Farmgate price (Rs/kg) of milk in selected countries (2008)**

Country	CM	BM
Australia	18.39	-
Bulgaria	20.34	29.46
Canada	29.80	-
China	40.71	-
Denmark	25.15	-
Egypt	23.02	27.55
France	23.83	-
Germany	22.19	-
India	13.93	18.31
Israel	27.04	-
Italy	24.94	35.50*
Netherlands	24.22	-
New Zealand	20.24	-
Pakistan	13.32	12.53
Poland	19.32	-
Switzerland	31.92	-
UK	21.08	-
USA	20.49	-

CM - cow milk, BM - buffalo milk, \* - 2007 prices

**Table 3.6. Per capita consumption of liquid milk (g/day)**

Region/ country	1999	2001	2003	2005	2007
World	123.29	123.29	126.03	130.13	137.29
Africa	68.49	73.97	73.97	72.80	77.53
America - North	265.75	295.89	268.49	293.91	326.84
America - Central	209.13	218.60	228.05	229.71	229.93
America - South	254.80	243.84	243.84	262.02	273.10
Asia	73.97	73.97	82.19	87.97	96.49

Europe	268.49	252.06	249.32	260.98	254.62
Oceania	249.32	208.22	197.26	224.20	272.47
Australia	350.69	295.89	279.45	251.01	318.72
China	19.18	24.66	38.36	59.40	73.46
India	117.81	109.59	112.33	105.18	110.95
New Zealand	145.21	136.99	134.25	171.71	148.54
Pakistan	238.36	235.62	235.62	229.76	255.22
UK	328.77	339.73	339.73	327.48	326.56
USA	317.81	378.08	323.29	315.22	351.42

**Table 3.7. Per capita consumption of selected milk products (kg)**

Country (year)	Liquid Milk Drinks (L)	Cheeses (kg) (2007)	Butter (kg) (2007)
Argentina	65.8 (2005)	8.04	1.07
Australia	106.3 (2005)	10.05	3.86
Austria	80.2 (2006)	22.32	5.34
Canada	94.7 (2005)	12.73	2.51
China	8.8 (2005)	0.23	0.11
EU -25 countries	92.6 (2006)	16.74	3.95
Finland	183.9 (2006)	16.09	3.80
France	92.2 (2006)	24.48	8.26
Germany	92.3 (2006)	20.72	6.35
Greece	69.0 (2006)	30.44	1.10
India	67.0 (2003)	N/A	2.65*
Ireland	129.8 (2006)	10.41	2.60
Italy	57.3 (2006)	21.83	2.77
Mexico	40.7 (2006)	2.16	0.71
Netherlands	122.9 (2006)	19.44	3.30
New Zealand	90.0 (2005)	4.92	9.33
Norway	116.7 (2006)	15.74	2.53
Spain	119.1 (2005)	9.07	0.96
Sweden	145.5 (2006)	17.68	2.69
Switzerland	112.5 (2006)	19.24	5.97
UK	111.2 (2005)	11.15	3.11
United States	83.9 (2006)	14.86	2.02

\* Includes ghee.

**Table 3.8. World - Per capita availability of milk (g/day)**

Country	1999	2001	2003	2005	2007	2009*
World	258.88	260.71	265.16	285.72	278.93	279.44
Australia	1526.25	1543.51	1397.13	1366.32	1366.59	1208.19
China	24.44	31.15	46.39	67.16	76.92	82.15
Denmark	2399.77	2327.51	2377.01	2309.86	2304.77	2409.16
France	1154.47	1143.94	1120.19	1119.64	1056.19	1064.37
Germany	946.68	939.32	949.61	946.91	928.97	956.62
India	217.29	223.64	224.51	239.56	249.56	251.65

Ireland	3740.50	3843.45	3700.42	3670.55	3467.09	3258.54
N .Zealand	7877.94	9365.91	9927.34	9907.95	10501.86	9774.64
Netherlands	1936.64	1876.38	1871.15	1811.74	1777.37	1893.96
UK	693.56	674.80	684.31	655.90	651.39	587.00
USA	723.94	721.10	730.22	743.83	765.59	747.58

\* On the basis of population projections made in 2008

**Table 3.9. India - Per capita availability of milk (g/day)**

Region/ State	2002-03	2003-04	2004-05	2005-06	2006-07
All India	230	231	233	241	246
<b>South</b>					
A&N Islands	195	183	165	135	155
Andhra Pradesh	231	238	250	260	269
Karnataka	229	190	194	197	200
Kerala	203	173	169	171	172
Lakshadweep	87	43	45	64	76
Pondicherry	101	107	108	108	117
Tamil Nadu	198	198	204	231	232
<b>West/ Central</b>					
D&N Haveli	97	95	45	53	54
Daman & Diu	17	16	10	11	13
Goa	91	93	110	105	100
Gujarat	321	330	344	349	374
Madhya Pradesh	236	233	233	262	259
Maharashtra	172	172	176	178	182
<b>North</b>					
Chandigarh	127	127	115	116	124
Delhi	57	56	54	54	48
Haryana	647	643	631	628	633
Himachal Pradesh	339	337	378	373	370
J & K	365	363	364	353	325
Punjab	895	898	917	943	961
Rajasthan	368	371	376	387	408
Uttar Pradesh	245	250	254	262	267
Uttaranchal	339	365	364	361	358
<b>East</b>					
Bihar	92	100	147	154	163
Chhattisgarh	103	102	103	103	101
Jharkhand	94	92	127	126	131
Orissa	68	71	92	95	100
West Bengal	120	120	124	126	126
<b>North-east</b>					
Arunachal Pradesh	112	109	114	113	114
Assam	71	71	72	72	70
Manipur	85	85	90	92	82
Meghalaya	78	78	81	82	82

Mizoram	45	44	46	43	45
Nagaland	78	83	90	96	86
Sikkim	222	231	221	232	230
Tripura	66	68	70	70	71

**Table 3.10. Average milk yield of species of cows and buffaloes in India**

Breed		Origin	Milk yield (kg/year)	
			Village	Commercial farms
Indian cattle ( <i>Bos indicus</i> )	Sahiwal	Punjab, Haryana, U.P, Delhi, Bihar, M.P	1350	2100
	Gir	Gir forest areas of South Kathiawar	900	1600
	Tharparker	Jodhpur, Kutch, Jaisalmer	1660	2500
	Red Sindhi	Punjab, Haryana, Karnataka, Tamil Nadu, Kerala, Orissa	1100	1900
	Kankrej	Gujarat	1300	3600
	Ongole	Nellore, Krishna, Godavari, Guntur (AP)	1500	
	Haryana	Karnal, Hisar, Gurgaon (Haryana), Delhi, western M.P	1140 - 4500	
Foreign cattle ( <i>Bos taurus</i> )	Holstein Friesian	Holland	7200-9000	
	Jersey	Island of Jersey (Great Britain)	5000-8000	
	Brown Swiss	Switzerland	5250	
	Ayrshire	Scotland	4840	
Crossbred cattle	Karan Fries	NDRI, Karnal	3700 (8338)*	
	Karan Swiss	NDRI, Karnal	3355 (7096)*	
	Sunandini	Kerala	2900	
	Frieswal	PDC, Meerut	2970	
Buffalo	Murrah	Haryana, Delhi Punjab	1560	
	Jaffarabadi	Kathiawar (Gujarat)	1800-2700	
	Surti	Gujarat	1700-2500	
	Nagpuri	Nagpur, Wardha, Akola, Amravathi, Yeotmal (Maharashtra)	1030-1500	

\* Best yield at NDRI (Karnal) in parentheses

Source: ICAR (1978); Banerjee (1999); Annual Reports, NDRI (Karnal);

www.indg.in - India Development Gateway (Nov, 2008 data)

\*\*\*\*\* 😊 \*\*\*\*\*



### Lesson 4

#### PRACTICES RELATED TO ANIMAL AND MILKING PERSONNEL

##### 4.1 Introduction

Milk is the most nutritious and complete food for new born infants and adult human beings. It is, therefore, a perfect growth medium for innumerable microorganisms including pathogens. Some common milk-borne infections and the pathogens causing them are listed in Table 4.1. Milk is also a potential source for chemical contaminants such as antibiotics and pesticides. The term 'clean milk' refers to raw milk from healthy animals, that has been produced and handled under hygienic conditions, that contains only a small number of harmless bacteria, is free from hazardous chemical residues and that possesses a good keeping quality without being heat-treated. As the raw milk quality prevailing in India is not good, there is much scope for the improvement in the quality of milk produced by making quality strategies for the post-production handling of milk.

The two basic principles that ensure safe handling of raw milk are 1) avoiding or minimizing contamination at various stages of handling raw milk and 2) reducing the growth and activity of microorganisms in raw milk. Knowledge of the possible unhygienic practices that lead to the gross contamination of milk will be useful in realizing the seriousness of the situation and in recommending strategies to improve it. Table 4.2 enlists the possible sources and extent of contamination that can occur in milk.

The possible undesirable practices that are prevalent may broadly be classified into four categories:

- Practices related to the animal: unhealthy animal, unclean body and udder of the animal
- Practices related to the milking personnel: unhealthy milker, unclean hands and clothes of the milker, unhygienic personal habits of the milker
- Practices related to the milking process: incomplete milking, wrong milking procedure, unclean vessels for milk collection
- Practices related to the environment: poor housing and feeding of the animal, unhygienic surroundings

Some of the common practices to ensure clean milk production are discussed below in detail.

##### 4.2 Practices Related to the Animal

###### 4.2.1 Health of the animal

- The animals should be examined periodically for udder and other infections.
- Infected animals should be treated by a qualified veterinarian.
- Animals suffering from infectious diseases should be isolated. Sanitary precautions to prevent and control the diseases should be adopted.
- Milk of the infected animal should never be pooled with the bulk milk until the animal recovers from the illness fully.

**Table 4.1 Common milk-borne infections**

No.	Infection	Causative pathogen	Disease/ disorder	Possible source of entry
1	Food infection	<i>Salmonella typhi</i> and related species	Typhoid, salmonellosis (food poisoning)	Dung
		<i>Shigella dysenteriae</i>	Shigellosis (dysentery)	Faecal contamination
		<i>Streptococcus</i> sp. (enterococci)	Septic sore throat, scarlet fever, food poisoning	Faecal contamination
2	Food intoxication: Bacterial	<i>Staph. aureus</i>	Food poisoning	Human beings
		<i>Cl. botulinum</i>	Botulism (food poisoning)	Soil, water, inadequate processing
		<i>E. coli</i>	Summer diarrhoea	Faecal contamination
		<i>V. cholerae</i>	Cholera	Water
	Fungal	<i>Aspergillus flavus</i>	Aflatoxicosis	Poor storage & handling
		Other toxigenic mold spp.	Mycotoxicosis	
3	Toxic infection	<i>Bacillus cereus</i>	Food poisoning	Soil, water, inadequate processing
		<i>Cl. perfringens</i>	Gas gangrene	Soil, water, inadequate processing
4	Other milk-borne disorders (uncertain pathogenesis)	<i>Aeromonas</i> spp.	Food poisoning	Water
		<i>Proteus</i> spp.		Human intestinal tract, soil, water
		<i>Klebsiella</i> spp.		Enteric sources
		<i>Pseudomonas</i> spp.		Soil, water of cold regions
		<i>Citrobacter</i> spp.		Soil, water, sewage
5	Some other important pathogens	<i>Listeria monocytogenes</i>	Listeriosis	Soil, human beings
		<i>Yersinia enterocolitica</i>	Diarrhoeal disease	Water
		<i>Campylobacter jejuni</i>		Dung
		<i>Vibrio parahaemolyticus</i>		Water
6	Other milk-borne diseases: - Bacterial	<i>Mycobacterium tuberculosis</i>	Tuberculosis	Humans
		<i>Brucella abortus</i>		

**Table 4.2. Bacterial contamination of milk as influenced by different sources**

S.No.	Source of contamination	Bacterial count	
1	Exterior of the cow	(10 <sup>6</sup> /g faeces or dirt)	
	Fresh cow faeces	0.16 - 634	
	Faeces after 48 h drying at 37°C	500 - 10,000	
	Dirt from coat of clean cows	17.8	
	Dirt from dirty cows	184.3 - 4595	
2	Udder contamination	(counts/ml milk)	
	Acute mastitis	Several hundred million	
	Sub-clinical mastitis	1,000 to 3 million	
3	Different stages of milking	(counts/ml milk)	
	Foremilk	5,989	
	Middle milk	557	
	Strippings	415	
4	Different milking practices	(counts/ml milk)	
	Wet milking (with water)	102,107	
	Dry milking	6,450	
	Fat milking	5,030	
5	Effect of wiping udder with damp cloth	(counts/ml milk)	
		Open top pail	Small top pail
	Dirty cows (manure removed once a week)	22,677	17,026
	Dirty cows (manure removed once in 6 months)	86,212	24,439
	Dirty cows (manure removed twice a week, udder & teats clean)	6,160	2,886
	Dirty cows (manure removed daily, udder & teats washed)	4,947	2,667
	Clean cows (manure removed daily, bedded, udders not washed)	8,681	6,306
6	Cleaning & sweeping during milking	(counts/ml milk)	

\*\*\*\*\* 😊 \*\*\*\*\*

**Lesson 5**  
**MILKING PROCESS AND ENVIRONMENT**

**5.1 Practices Related to the Milking Process**

**5.1.1 Udder washing**

- All udder washing and cleaning should be done gently so as not to damage the orifices and clefts between the quarters of the udder.
- For all washing, two buckets (one with plain water and a second, which carries the disinfecting solution) with two separate cloths for both the purposes are required. A third bucket with a mild detergent solution and a third cloth is recommended for wiping the teats after milking.
- The first wash with tepid water should remove all dirt particles from the udder. A gentle detergent solution may be employed to remove persistent dirt. If the dirt is wiped off with a wet cloth, the cloth should be wrung outside the bucket.
- During severe winters, lukewarm water is recommended for udder washing to avoid chills. This also conditions the animal to let down the milk. The temperature of the wash water should be below 55°C.
- Addition of hypochlorite solution (500 ppm) helps to disinfect the udder. Solutions of quaternary ammonium compounds (200 to 400 ppm) are better substitutes due to their less harmful effect on tissues. Under Indian conditions, the easily available Dettol or Savlon may be diluted as per the manufacturers' instructions and used to disinfect the udder and teats.
- After washing, these organs should be dried before milking. A different wash cloth as well as drying cloth is recommended for each cow. The towel used should also be washed after each milking and disinfected by boiling from time to time.
- Disposable paper towels may be used instead of cloth. However, under the Indian conditions, these may be impractical.
- The udder and teats should be wiped with clean cloth dipped in detergent solution after milking.

**5.1.2 Hygienic practices during milking**

- The milking should be complete, with no milk left in the udder after milking.
- The first few ml of milk should be discarded, as this contains a large number of microorganisms.
- This forestripping should be collected in a cup or a utensil and not thrown on the floor, so that flies and other insects may not be attracted towards it.
- Milking should be done with full hands, quickly and completely, followed by stripping, if so required. Milking operation should be complete in 7-8 minutes. In farms with more than 8 high-yielding cows, it is preferable to use a milking machine. If the herd exceeds 100, a separate milking parlour will ensure better hygiene.
- Unhygienic practices such as dipping the fingers in milk and then wetting the teats to soften them should not be permitted.
- Milking with the full hands and not with the knuckles is preferred as the latter leads to more chances of teat injury.

- Sick cows should be milked at the end to prevent infection.
- The animals should be dried off 60-70 days before calving.

### 5.1.3 Hygiene of milking utensils

- All milking utensils should be of uniform size.
- They should have small mouths to avoid external contamination.
- They should be made of a non-rusting and non-absorbent material such as aluminium or galvanized iron. Stainless steel would be ideal, but for the cost considerations. The use of vessels such as empty dalda tins, pesticide/insecticide containers, teapots etc. should be avoided.
- The utensils should be free from dents, cracks and crevices.
- The utensils should be scrubbed and cleaned before and after each milking.
- The detergents and chemicals used should be non-injurious to health, and non-abrasive to hands. At farm level, use of washing soda coupled with exposure to sunlight or rinsing with scalding water or use of detergents-cum-disinfectants such as iodophors is recommended.
- The cleaned vessels should be placed inverted for complete drainage of water after milking, so as to avoid contamination from bacteria of the air, insects, rodents, mosquitoes, reptiles etc.
- In villages where milk collection is carried out by co-operative societies, the use of community milking byres/parlours with facility to clean and disinfect udders/teats as well as milking equipments under the supervision of the society officials is recommended.
- Milk should immediately be transferred from the barn to an appropriate place.

## 5.2 Practices Related to the Environment

### 5.2.1 Hygiene of milking environment

The places, where housing, feeding and milking of the animals are done, need special care in order to minimize contamination of the milk. In the animal house system, the animals are housed during winter and milked in the same building. This system has been practiced in temperate countries for many years, the extent of its adoption varying in different countries according to climatic conditions. The animal house is a specialized building, which should be carefully designed and constructed so as to provide comfortable and healthy housing facility for the cows and at the same time to enable them to be milked in clean conditions.

The animal house should be situated at an appropriate site. Water should be available in plenty and drainage facilities must be there. There should be ample ventilation in the shed with enough space to house all the animals. Proper drainage system is an essential feature of every animal house to facilitate collection and disposal of liquid wastes so as to prevent contamination of milk. There should be isolation boxes or separate accommodation for sick animals and animals about to calve.

### 5.3 Feeds and Milk Contamination

Clean milk production must also ensure that feedstuffs offered to animals are not a potential source of contamination. Proper nutrition can decrease new mammary infection rates by improving the animal's immunity. The usefulness of antibiotics and drugs against mastitis and other diseases in animals have rendered them almost indispensable in veterinary medicine. The administration of these substances, however, results in the secretion of their residues into milk. The consumption of such contaminated milk has physiological and technological implications. Once antibiotics and drugs find their way into milk, it is difficult to get rid of them. Heat

treatment is not usually effective. Processes such as ultrafiltration (UF) can help considerably, to reduce the antibiotic load of milk. Use of specific enzymes (such as penicillinase to inactivate penicillin) may be useful in salvaging all components of the contaminated milk, albeit, at some extra cost. However, under the Indian scenario, the best and more economical method would be to follow stringent preventive measures listed below.

- Antibiotic administration to infected animals should only be done under veterinary supervision.
- Clinical cases should be treated as soon as they occur.
- Cases of sub-clinical mastitis should be treated at herd level at the beginning of the dry period.
- Each preparation of antibiotic used for the treatment of milch animals should be tested for determining the maximum interval before all traces are secreted.
- The appropriate withholding time, usually 72 h should be observed.
- Regular monitoring of the raw milk supplies by means of suitable test method and penalties for the delivery of contaminated milk is essential. (Unfortunately, there are not enough inexpensive farm level tests that may be used to detect extremely low levels of residues that sophisticated tests are capable of detecting).

The use of pesticides to control any pest, including unwanted species of plants or animals during the production, storage, transport, distribution and processing of food, agricultural commodities and animal feeds leads to the retention of these products or their derivatives in the product. Such residues pose serious threat to public health by entering into the milk when these materials containing pesticides are used as cattle feed. Organochloropesticides (OCP) including DDT (dichlorodiphenyl trichloroethane), BHC (benzene hexachloride), chlordane, heptachlor, aldrin, dieldrin, endosulphan are fat soluble, persistent and not readily excreted by the animals except into milk. Being insoluble in aqueous media, they are unavailable for microbial degradation or detoxification. They remain stored in the animal body fat for long periods in an unchanged form. These pesticides are metabolized at the time of lactation or stress and transported into the milk. The toxicological effects of consuming food products containing pesticide residues include cellular and genetic damage to animals and human beings, blindness, tumerogenic effects, damage of liver function, premature onset of labour, intra-uterine growth retardation and infant mortality.

\*\*\*\*\* 😊 \*\*\*\*\*

### Lesson 6 MILK COLLECTION SYSTEM AND PRICING POLICIES

#### 6.1 Introduction

In most of the developed countries, production of milk is confined to rural areas, while demand is mostly urban in nature. Hence, the milk has to be collected and transported from production points to processing including chilling centers and distributions points in cities.

In rural India, milk production is largely a subsidiary activity to the agriculture in contrast to organized dairying in Western countries. Small farmers and landless labourers usually maintain 1-3 milch animals. As a result, small quantities of milk are produced, in a scattered manner all over the country. This situation makes the task of milk collection complex.

With the growth of the organized dairy industry in India, a trend towards establishing modern farms has gained momentum for milk production with a herd of 100-300 cows/buffalo in line with the practice adopted in advanced countries. These farms have the facilities of machine milking and bulk milk cooling.

#### 6.2 Milkshed

It is the geographical area from which a city dairy receives its fluid milk supply. The allocation of definite milk sheds to individual dairies for the purpose of developing the same is now being considered in India.

#### 6.3 Rural Milk Collection

##### 6.3.1 Undertaking extensive surveys in the milkshed area to establish a dairy plant

Availability of milk at various collection points is ascertained based on

- the number of animals
- future potential of milk availability, and
- the presence of the competitors

##### 6.3.2 Route planning

- Taking into account milk availability,
- Road access to collection points and their distance from the site of the dairy plants.

##### 6.3.3 Planning the location of the primary collection and chilling centers

#### 6.4 Type of Systems

In India, four systems of milk procurement (viz., Direct, Contractor, Agent and Co-operative systems) are popular. The organized sector with 575 processing plants and milk product factories in the Co-operative, Public and Private sectors has not captured major share in the milk trade which is still dominated by the traditional sector. It has been estimated that about 67% of total milk production is marketed, out of which 51% is the share of traditional channels and remaining 16% is through the organized sector. The low capital demands of traditional systems make it hard to replace. The organized dairies collect milk through one or combination of the following systems:

## 6.4.1 Direct system

In this system, organized processor (Public, Co-operative or Private) collects milk directly from the producers by establishing village procurement centres.

## 6.4.2 Contractor system

The processors purchases milk from the contractor according to the terms of contract such as quality, quantity, price, etc.

## 6.4.3 Agent system

The processor appoints agents to procure milk in particular area. Payment for the milk is made directly to the producers while the agent gets the commission.

## 6.4.4 Co-operative system

At the village level, the farmers form a co-operative society, which establishes the milk collection centres'. The society collects milk twice a day and delivers it to the milk collection centres where the milk is weighed, tested and the price paid to farmers. The payment is based on fat content or fat + SNF content in the milk. The village society supplies/sells milk to its own District co-operative dairy plant. It transports milk in cans by trucks or through insulated road milk tankers, preferably via a chilling centre. Besides milk collection, the society also provides the technical input services such as the A.I, veterinary aid; concentrated cattle feed and fodder seeds. They also give counselling to the society members to enhance milk production.

## 6.5 Chilling Centres/Bulk Milk Cooling Centres

If the dairy plant is far away from the collection centre, then the collected milk is first brought to a centralized chilling centre/ bulk milk cooling unit. Here, milk is cooled to 4°C and stored in insulated storage tanks of 5000-20,000 L capacity. Subsequently, the chilled milk is transported in insulated Road milk tanker to the dairy plant. The transportation of milk from the chilling centre to the dairy plant usually takes place once a day.

## 6.6 Efficiency of Systems

Each system has its own merits and demerits. The efficiency of any system can be measured through analysis of various indicators like:

- Regularity in milk collection
- Efficiency of milk collection in lean months to the milk collected in flush months
- Quality of milk procured
- Cost of milk procurement

## 6.7 Problems of Milk Procurement

In order to make plants financially viable and sustainable, the procurement system has to be such that the plant runs efficiently. The principal problems in milk procurement which have a direct bearing on capacity utilization and operational efficiency are well recognized. The major problems listed below demand managerial skills to ensure adequate milk supplies to dairy plants, throughout the year:

- Perishable nature of commodity, improper cleaning of milking vessels, hind quarters of animals, udder of the animal and the barn.
- Commitment for lifting small surpluses of milk from thousands of farmers.
- Wide fluctuations in milk output based on seasons.



- Procurement of milk from farmers – members and non-members of the co-operative societies, problem of payment of price and sharing of inputs.
- Lack of infrastructural facilities like cooling at village level, unreliable electricity supply, non-availability of spare parts of machinery. Due to these about 2-5% of milk received is C.O.B. positive especially in summer.
- Poorly developed roads and transportation systems cause undue delay in milk procurement
- Cost of chilling and transportation is high.
- Procurement problems are more specific to hilly regions, drought prone areas, tribal areas, forest, etc.
- Quality of raw milk; chemical and microbiological hazards; cleaning of milking utensils and sanitation of milking areas.
- Problem of adulterants, neutralizers, preservatives, pesticides, antibiotics and other additives in raw milk.
- Unhealthy competition among vendors, contractors, co-operative milk unions and other agencies engaged in milk procurement; administrative demarcation of zones under MMPO for each plant is of no practical help.

## 6.8 Pricing Policy for Raw Milk

The price of raw milk determines the level of profit, so it plays a crucial role in encouraging milk producers' to produce more milk per animal and per household. Productivity, composition and marketable surplus of milk vary from animal to animal, season to season and place to place. A good pricing policy for raw milk collection has to take care of three variations as given under.

### 6.8.1 Seasonal variation

This is due to seasonality in calving, availability of green fodders and climatic stress. From the pricing point of view, there are four seasons:

- Flush - November to February
- Transitory to lean - March and April
- Lean - May to August
- Transitory to Flush - September and October.

### 6.8.2 Compositional variation

Fat and SNF are two major constituents of milk which are considered for price fixation. The '2-axis pricing policy' gives importance to both fat and SNF; the per Kg (rate) price of fat and SNF are fixed in that ratio at which these occur naturally i.e. around 2/3 of fat per kg price for each kilogram of SNF. This type of pricing discourages adulteration. Basic price is fixed for basic composition and for each 0.1 additional value, bonus is added and for shortfall deductions are made.

### 6.8.3 Spatial variation

Price of agricultural commodities varies from region to region. Milk producers near cities get more price than those located far off. Procurement cost of milk can be minimized by getting more milk from nearby areas or obtaining milk from existing milk shed areas.

## 6.9 Rational milk pricing policy

- A guaranteed price and market to the producers' throughout the year
- A regular supply of wholesome milk at a reasonable price to the consumers

- An attractive margin of profit to the milk processors and product manufacturers

## 6.10 Fixing the price from producer's viewpoint

The price should be related to the cost of milk production. The system must ensure a fair margin of profit to the producers. Due consideration has to be taken about seasonal variations in production (supply) and demand, consumer's price index based on market trends.

## 6.11 Fixing the price from milk processor's viewpoint

Price fixation should consider the following:

- The stage of operation of the plant
- Plant capacity utilization
- The market objective of the plant
- Consideration of the size of the population that is to be covered by the milk scheme
- Distribution of people in different occupational and income groups that are to be served
- Total cost of transportation, processing/manufacturing and distribution

## 6.12 Pricing Systems

Various pricing systems functioning in the country for milk procurement are given below:

### 6.12.1 Pricing on fat content

A very large section of dairy industry is buying the milk on fat basis, disregarding the SNF content of milk. This is practiced by most private dairies. The advantage involves discouraging adulteration with water or separated milk or, mixing of cow milk with buffalo milk. A disadvantage of this system is that it discourages production of cow milk. The price paid per kg of fat was Rs. 425/- in 2011.

### 6.12.2 Pricing on volume or weight

This method is also known as flat rate. It saves time and is simple to calculate but encourages adulteration i.e. watering or skimming. It is popular in the unorganized sector.

### 6.12.3 Pricing on total milk solids

The traditional milk traders generally price the milk on the basis of total milk solids. They consider the yield of Khoa to be produced from the milk to be purchased. This system encourages partial skimming or adulteration with cheaper non-milk solids.

### 6.12.4 Pricing on species of milch animal

In this system, consideration is given to the species of animal from which the milk is obtained i.e. cow or buffalo. Normally buffalo milk fetches more price than cow milk. This system encourages the adulteration of buffalo milk with water or cow milk.

### 6.12.5 Pricing as per cost of milk production

The price should be related to the cost of milk production and ensure a fair margin of profit to the producer. It should take into account the seasonal variation in production and demand.

## 6.12.6 Pricing according to the use of milk

This practice is followed mainly for milk products. Milk procurement for a specialized dairy product such as cheese requires selection of raw milk by avoiding mastitis, colostrum, late lactation, and antibiotic-free milks. The milk should be free from detergents, sanitizers, pesticides, insecticides, aflatoxins, mycotoxins, heavy metals and even off-flavours.

## 6.12.7 Two-axis pricing of milk

Liquid milk plants have a differential pricing system for flush and lean months based on the fat and SNF content of milk, with provision for the payment of a premium for a higher fat and SNF content than the specified standard. According to this pricing policy, the price of milk is calculated by fixing a predetermined rate for fat and SNF. This system discourages adulteration and provides a common pricing approach to both cow and buffalo milk. The requirement by Food Safety and Standards Rules (FSSR) - 2011 (erstwhile PFA) for cow milk is 3.0% - 4.0% fat and 8.5%-9.0% SNF while those for buffalo milk 5.0%-6.0% fat and minimum 9.0% SNF throughout country. This is done with a view to encourage the milk production through high-yielding indigenous and cross breeds and to give adequate incentive for production of cow milk. In this context, National Dairy Development Board (NDDB) has suggested the 'two-axes milk pricing' policy.

## 6.13 Two Axes Formula

India has been producing large quantities of buffalo milk when compared with any other country. This milk being rich in fat content always attracted good price in comparison to cow milk. The fat portion being visible (giving thickness), separable (yielding cream) and measurable (in percentage) made it easier to decide milk price.

### 6.13.1 Kilo fat system

A system based on 'kilo fat' became a practice for purchase of buffalo milk. Under this system, an amount in rupees per kg of fat means an amount payable on that quantum of milk which would yield one kg of fat. For example, when the rate per kg fat is Rs. 425, it means that the said amount will be paid for 16.66 L of buffalo milk with 6% fat (minimum standard):

$$1 \text{ kilo (1000gm) fat} \div 60 \text{ gm/L (6\%)} = 16.66 \text{ L}$$
$$\text{On this basis, the price per L works out to: Rs } 425 \div 16.66 = \text{Rs } 25.51/\text{L}$$

If cow milk with 3.5% fat (min standard) were to be purchased under kg fat system, it would fetch Rs 7.70 per L as shown below:

$$1000 \text{ gm} \div 35 \text{ gm/L (3.5\%)} = 28.57 \text{ L}$$
$$\text{Rs } 425 \div 28.57 = \text{Rs. } 14.87/\text{L}$$

This works out to 58% of the rate paid for buffalo milk, an injustice to cow milk producer.

### 6.13.2 Double axes pricing

With a view to pay for buffalo milk and cow milk on the rationale of their two components, viz. fat and SNF, a system was devised called as Double-axis milk pricing. The purchase rate for fat and SNF are determined based on previous experience or ruling market prices/ consumer

appreciation for buffalo milk fat (white ghee) vis-à-vis cow milk fat (yellow ghee) and for buffalo milk SNF vis-à-vis cow milk SNF (i.e. SMP). Accordingly, the difference between prices paid for buffalo milk and cow milk is reduced. Suppose the rate of Rs. 425 per kg fat (which can neither be purchased nor it is the selling rate for ghee normally) is translated into Rs. 190 per kg fat and Rs. 158 per kg SNF, then the purchase price for buffalo milk and cow milk is determined as shown below:

**Table 6.1 Purchase price for buffalo milk and cow milk**

Type of Milk	Fat	SNF	Rs./L
Buffalo milk (%)	6.0	9.0	25.62
Rate (Rs./kg)	190	158	
Amount (Rs./L)*	11.40 (= 60×19.0)	14.22 (= 90×15.8)	
Cow milk (%)	3.5	8.5	20.08
Rate (Rs./kg)	190	158	
Amount (Rs./L)*	6.65 (= 35×19.0)	13.43 (= 85×15.8)	

\*Calculated in grams per L of milk × price per grams of component.

In this way, the cow milk is paid to the extent of 78% of the rate for buffalo milk. This also matches with 80% TS in cow milk compared to buffalo milk.

Note:

- A ready reckoner can be prepared depending on actual rates decided from season to season. For every 0.1 % increase in fat and SNF, the value per L can be worked out for buffalo/cow milk.
- In above calculation, volume to weight conversion has not been considered. For calculation of kg fat/kg SNF, the milk volume is to be multiplied by specific gravity and the weight thus arrived is multiplied by fat or SNF % and then divided by 100. However, under the Anand Pattern, farmers are paid on volume and the DCS is paid on weight basis. Hence, the above calculations holds good and serves as a guideline to pay the farmers.
- Incentives for quality milk production are sometimes given in form of premium price offered based on microbiological tests such as MBR and Resazurin Reduction.

#### 6.14 Milk Collection Centre

The information collected in the survey form has to be analyzed to understand the pattern of dairying in that village for establishing the milk collection centre. These include:

- The breeds of cows and buffaloes
- The number of animals in milk and dry
- The level of animal husbandry practices
- Lactation period
- Availability of green and dry fodder
- Artificial insemination

#### 6.15 Daily Routine in Milk Collection Centre

- Organoleptic testing of milk wherein stale, sour, adulterated milk shall be rejected.
- The timing of milk collection shall have to be adhered to

- Milk procurement should be in both the shifts (morning and evening). Unless cooler or bulk cooler is used at the Milk collection centre (MCC), milk should be transported to the dairy in each shift.
- The farmers should be trained to carry milk in clean vessels, and the milk cans at the MCC should be cleaned adequately.
- The milk samples should be tested for fat content and SNF. A trained person should be assigned such task and should be supervised.
- The route vehicle should reach the dairy dock at an interval of every 20 min. All the vehicles should report in such a fashion that the milk reception is over within the stipulated time.

## 6.16 Raw Milk Reception Dock

- The milk cans are loaded on conveyor in a specific sequence and each can is inspected for abnormal colour, taste, smell, etc.
- A sample is immediately checked for Clot-on-Boiling (COB) test and the milk is received MCC-wise and samples are drawn for further testing in the laboratory. These samples are checked for acidity, MBRT, and for adulterants like sugar, starch, urea, soda, water, preservatives, etc.
- The results of milk weight, fat and SNF percentage are communicated to the MCCs through the transport vehicles on a 'truck sheet'. It brings information filled in by the MCCs regarding the vehicle arrival and departure time, number of milk cans sent and complaints, if any. Potassium dichromate is usually used to preserve the sample for analysis.
- If the acidity of the collected milk is more than 0.15% lactic acid (LA), it should be treated as sour milk. Methylene Blue Reduction Test (MBRT) of the raw milk at the time of reception should be minimum 30 min.

## 6.17 Equipment at the Milk Collection Centre

- Milk collection tray
- Milk strainer
- Milk sampler
- Sample bottles
- Sample bottle tray
- Milk measures: 2 L/ 1 L/ 0.5 L/ 0.2 L
- Plunger
- Al alloy/plastic milk cans
- Plastic bucket and mug

## 6.18 Equipment and Glassware for Milk Testing

- Gerber centrifuge
- Butyrometers with stand
- Butyrometers shaking rack
- Lactometer with jar
- Thermometer
- Milk pipettes with stand
- Acid bottle with tilt measure
- Alcohol bottle with tilt measure
- Lock stopper
- Jerry cans for acid/ alcohol

## 6.19 Registers

- Pass books/monthly cards
- Purchase registers
- Testing note book
- Payment registers
- Members' registers
- Cash book
- General ledger
- Dead stock register

## 6.20 Sophisticated Equipments used in Milk Collection Centers

### 6.20.1 Electronic milk tester

This instrument measures fat percentage, which is displayed quickly and accurately on a digital readout. It follows the system of dilution, mixing, homogenization and photometric measurement. It requires small volume of milk sample and can perform 120-150 tests per hour with auto zero facility. Its fat measuring range is 0 to 13%.

### 6.20.2 Electronic SNF tester

This instrument is designed to perform 100 tests per hour and it gives instant digital display without the help of a chart or table. It does not require any chemical and is microprocessor-based. Its SNF measuring range is 0 to 12%. It can be used in conjunction with Electronic Milk Fat Tester.

### 6.20.3 Portable milk analyzer

This instrument is designed to measure fat (0.5 to 12%), SNF (6 to 12%), protein (2 to 5%), density / corrected lactometer reading (20-40) and added water (0-60%) for milk sample in about a minute. It does not require chemicals and is suitable for cow, buffalo and mixed milks. It works on ultra-sound technology and is useful in field as well as in laboratory.

### 6.20.4 Infra red milk analyzer (Milko-Scan)

It was J.D.S. Goulden of the National Institute for Research in Dairying, Reading, England who demonstrated in 1961 that the difference spectrum of water and homogenized milk at 5.73, 6.46, 7.9 and 9.6  $\mu$  could be used to estimate percentages of fat, protein, solids-not-fat and lactose in milk.

#### 6.20.4.1 Principle

The infrared milk analyzer measures absorptions of infrared energy by carbonyl groups (at 5.7  $\mu$ ) in the ester linkages of fat molecules, by peptide (6.46  $\mu$ ) linkages amino acids in protein molecules, and by hydroxyl groups (9.6  $\mu$ ) of lactose molecules. The method is specific for measurement of intact fat, protein and lactose in milk. SNF is estimated by adding a constant to instrument values for protein and lactose, making this method more accurate and less time consuming than direct determination with the instrument.

#### 6.20.4.2 Apparatus

A prototype infrared milk analyzer (Mark I IRMA) was developed in 1964 by the research and development section of Sir Howard Gruble Parsons, England. Development of the Mark 2 IRMA began in 1966. It had an improved optical design, automatic sampling and analysis combined with the various types of automatic reporting equipment. These instruments were the split beam, dual cell type which compared the infrared absorption of the sample to that of water at specific wave lengths selected by the prism or diffraction grating. The major limitations of these instruments

were relatively long light path, complex optical system, relatively unstable infrared energy source, poor signal- to-noise ratio, moisture-sensitive detector, sensitivity to scattering, and outdated electronics (transistors and tubes) which were susceptible to decay. Most of these limitations were due to the state of art at the time the instruments were developed and, regardless of these factors, they worked well and were accurate enough to establish and serve in milk analysis.

In 1975, Foss Electric Co., introduced the first single cell, dual wavelength infrared milk analyzers (Milko-Scans 203 and 300). They used optical filters to isolate the specific wave lengths absorbed by fat, proteins, and lactose and reference wavelengths not absorbed by these components, thus eliminating the need for a diffraction grating. This approach was implemented to reduce water displacement and scattering effects. A number of other changes also were made, such as reducing the number of mirrors, shortening the light path, using lower energy and more stable infrared source, and using solid state electronics. The use of a single cell makes the instrument more susceptible to water vapour, and to circumvent this problem, it is provided with a moisture-proof compartment. These instruments also use automatic electronic corrections for cross interference effects and are capable of assessing one of two additional variables, either water or total solids.

The milko-scan 100 series represents a second generation of the single cell, dual wavelength instruments manufactured by Foss Electric Company. A number of changes were incorporated in this instrument based on the experience gained with the Milko-Scans 203 and 300. Some of the changes incorporated were removing the servo comb, reducing the number of mirrors from 9 to 2, using a thermostatted filter housing, relocating the chopper, improving transmission characteristics of the filters, and using an improved detector. All primary instrument-signals are processed electronically to apply the cross corrections which are set directly into the instrument. Like the Milko-Scan 203, the Milko-Scan 104 is capable of determining fat, protein, lactose, and water or total solids. But it is semiautomatic rather than a completely automatic instrument.

### 6.20.5 Electronic weighing scales

These weighing scales are available in various capacities from 2 kg to 500 kg.

### 6.20.6 Raw milk reception dock (RMRD) automation system

This system takes care of reception of milk in cans coming from several villages. The system is modular in nature, flexible and can be upgraded. It draws a milk sample and premixes it automatically and collects it in a bottle, which is sent to laboratory. After weighing, the milk is drained automatically into dump tank and the drain valve gets closed automatically. The weighing and milk testing data are displayed with single key operation.

The system involves Windows Server 2000/2003 Pentium IV, Windows 98 ME/XP nodes for milk testing station and weighing station, Milko-Scan or Electronic Milk Tester and networking accessories. The system provides various outputs viz. truck sheet, milk collection report, time management report, analysis report and a summary report.

### 6.20.7 Bulk milk cooling tanks

These tanks when loaded with milk can cool it down from 30°C to 4°C in 3 h. The tanks are available in 250 L, 500 L, and 2 to 5 KL capacity. The integral condensing unit is hermetically sealed and uses R-22 refrigerant. These are built with stainless steel and with agitator assembly, on/off switches for agitator and, cooling and digital display of temperature. A model is available which claims that it senses the quantity of milk in tank and proportionately switches on the required refrigeration system, saving energy.

\*\*\*\*\* 😊 \*\*\*\*\*

**Lesson 7**  
**PRESERVATION OF RAW MILK**

**7.1 Introduction**

Milk leaves the udder at body temperature of about 38°C. The bacterial load may grow rapidly and bring about curdling and other undesirable changes if milk is held at the ambient temperature. Freshly drawn raw milk should be promptly cooled and held at 4°C till processing to preserve it against bacterial deterioration.

**7.2 Importance of Chilling of Milk**

Normally milk contains bacteria coming from the animal's udder, milk vessels and handling persons. When the milk leaves the udder, bacteria grow well at the ambient temperature (20-40°C) and milk starts deteriorating. Bacterial growth factor goes down to 1.05 at 5°C and 1.00 at 0°C. Critical temperature for bacterial growth is 10°C. The growth factor at 10°C is 1.80 which rises to 10.0 at 15°C. Hence freshly drawn raw milk should be promptly cooled to 5°C or below and held at that temperature till it is processed.

**7.3 Methods of Chilling**

**7.3.1 Can immersion**

The milk from pails is poured directly into cans through a strainer. The cans of milk are gently lowered into a tank holding cold water. The water level in the tank should be lower than the level of milk in cans to prevent water entering into the milk. In this method, a much smaller refrigeration unit is needed. The cans are kept cooled at the desired temperature (5-7°C) and the capacity of the unit is 200-280 litres of milk.

**7.3.2 Surface cooler**

The milk is distributed over the outer surfaces of the cooling tubes from the top by means of a distributor pipe and flows down in a continuous thin stream. The cooling medium mostly chilled water is circulated in the opposite direction through inside of the tubes. Cooled milk is collected below in a receiving trough, from which it is discharged.

**7.3.2.1 Advantages**

- Transfers heat rapidly and efficiently
- Relatively in-expensive
- Aerates the milk and thus improves the flavour

**7.3.2.2 Disadvantages**

- Requires constant attention of flow rate.
- Greater chances for air-borne contamination
- Cleaning and sanitation is not very efficient.
- There is slight evaporation loss.

**7.3.3 Immersion cooler**

Evaporating unit of a refrigeration unit is submerged directly into cans. Evaporator coil is fitted with an agitator. Milk is agitated for quick and proper transfer of heat from milk to refrigerant.



### 7.3.4 Rotor freeze

In this system, evaporating unit cools the water which in turn cools the milk in can. Several cans of milk can be cooled at a time. The milk cans are placed over the water tank and connected with chilled water circulation system which has specially designed can covers that are attached with chilled water pipe.

### 7.3.5 Cabinet cooler

It has a series of surface coolers installed close together in a vertical position. Capacity of cabinet cooler to cool the milk depends upon the number of sections in surface coolers. This type of cooler requires very small floor space for installation.

### 7.3.6 Bulk milk cooler

Bulk tank coolers are run by mechanical refrigeration system which cools the milk rapidly. These coolers maintain the temperature automatically during storage. Milk can be poured directly from milking pails into the tanks. This method is suitable for handling 500-2500 L milk/day. It is widely used at village level milk collection centers in India. From the Bulk milk cooler (BMC), the milk is pumped to the insulated tankers for transportation to dairy plants. The BMC uses horizontal or vertical cylindrical tanks with inner jacket and insulated body on the other side. There is provision of inner shell of the tank or direct expansion refrigerant coil for cooling. Milk is directly poured into the tank or pumped into the tank. Milk remains in contact with the inner shell of the tank cooling it to 4°C. The agitator is provided for uniform cooling.

### 7.3.7 Plate chiller

It is widely used for large scale cooling of milk (5000 to 60,000 L/day) at the chilling centers. They are highly efficient, compact and easily cleaned. In chiller, the gasketed plates are tightly held between the frames. These plates are so arranged that a flow passage for milk exists on one side of plate and chilled water on the other side. There is a counter-current flow between the milk and chilled water through the alternate plates. It helps in efficient transfer of heat from the milk to the cooling medium resulting in quick chilling of milk. The chilled milk flows from the plate cooler to the insulated storage tank at 4°C. A mechanical refrigeration system with Ice Bank Tank - IBT is needed.

### 7.3.8 Internal tubular cooler

It is a continuous cooling system consisting of a stainless steel tube of about 2.5 - 5.0 cm in diameter surrounded by a similar tube, forming a concentric cylinder. Several such tubes may be connected in series to obtain sufficient cooling. The cooling medium flows in opposite direction to the milk flow.

### 7.3.9 Vat/tank cooling

For batch cooling, small volume is desirable. It consists of a tank within the tank, with the space between the two being used for circulating the cooling medium by pump. An agitator is provided for efficient agitation.

## 7.4 Milk Chilling Centre

Due to scattered milk production by the small farmers and lesser number of organized dairy farms, the milk chilling centers are the alternative solution to the collection and chilling of milk.

### 7.4.1 Objectives

- To preserve the quality of raw milk supplies.

- To enable transportation of milk to the dairy plant without spoilage.

## 7.4.2 Location

This is guided by:

- Adequate milk production
- Adequate potable water supply
- Proximity to a good road or railway station
- Electricity supply
- Sewage disposal facilities

## 7.4.3 Major items of equipment

- Milk weighing tank/ pan and electronic weighing balance
- Drop or dump tank with cover
- Can washer
- Milk pump
- Plate cooler
- Storage tank
- Refrigeration unit
- Cold room
- Milk testing unit

## 7.4.4 Operational procedure

On arrival of the milk to the milk chilling center, the milk is graded for acceptance/payment, weighed, sampled for testing, cooled and stored at a low temperature (5°C) till dispatch to the processing dairy plant.

\*\*\*\*\* 😊 \*\*\*\*\*

Lesson 8  
LACTOPEROXIDASE-THIOCYANATE (LP) SYSTEM

8.1 Introduction

The perishable nature of milk makes it necessary to exercise extra care to preserve it. The tropical (hot and humid) climate of India further aggravates the problem. Milk meant for long distance transportation is always refrigerated to maintain its quality. However, refrigeration may not always be possible or available due to economic and/or technical reasons. Therefore the need to have a suitable alternative to refrigeration has been felt since long. An FAO/WHO Expert Panel on Milk Quality suggested addition of hydrogen peroxide (H<sub>2</sub>O<sub>2</sub>) as an alternative. This was not popular for several reasons, mostly related to the proper control of its usage.

- Milk of poor quality could be disguised and passed off as good quality milk
- Higher concentration of H<sub>2</sub>O<sub>2</sub> is toxic

Research conducted in the 1960s on colostrum in Sweden led to the discovery of naturally occurring enzymes and their positive effect on preservation systems. One such enzyme was lactoperoxidase (LP).

- It is an oxido-reductase enzyme
- It occurs in milk, saliva, tears, cervical mucus
- It is a single polypeptide chain with a molecular weight of 77,000 – 100,000.

Cow milk has 1.4 units/ml of LP, whereas buffalo milk has 0.9 units/ml. The amount of LP required for preservation is 0.5-1 mg/l, much lower than its concentration in cow milk (30 mg/l). It is a relatively heat resistant enzyme which retains sufficient activity even after pasteurization. Thiocyanate is widely distributed in animal tissues and secretions. Its level is dependent on dietary habits and lifestyle (for example, smokers have a higher level of thiocyanate in their system). Thiocyanate is the product of detoxification of thioaminoacids and cyanides and is secreted in urine with a half life of elimination of 2.5 days under normal renal function. Bovine milk has 2-15 ppm thiocyanate, though higher values have also been reported.

Lactoperoxidase can oxidise thiocyanate ions in the presence of H<sub>2</sub>O<sub>2</sub>, which is not normally present in milk. Even if present, it is in minute quantities, as a result of bacterial activity.

The LP-thiocyanate system can be explained with the following chemical reactions:

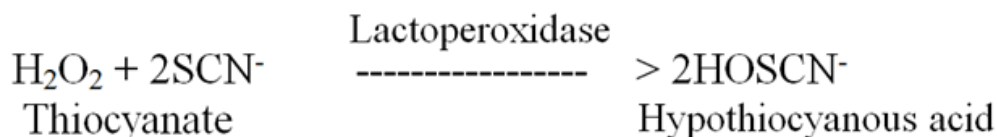

Hypothiocyanous acid dissociates into hypothiocyanite at the pH of milk

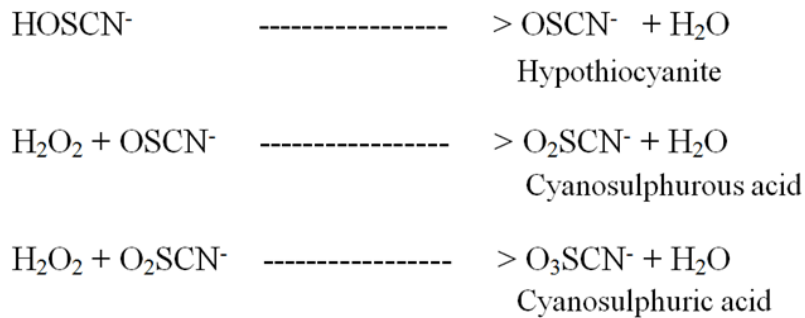

There are other end products besides these, such as sulphate, ammonia and carbon dioxide. The intermediary products of the LP-thiocyanate reaction are implicated in bacteriostatic and bactericidal activities.

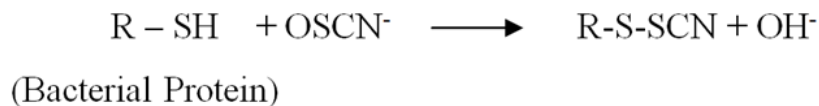

The presence of large quantities of sulphhydryl groups (-SH) such as those occurring in boiled milk would reduce/eliminate the antibacterial effect because the OSCN<sup>-</sup> ions would then attach to these freely available groups. Raw milk has very few SH- groups and therefore, the LP-system is most effective in raw milk.

### 8.2 Effect of LP System against Bacteria

The bacteriostatic/ bacterioacidal effect of the LP system is species- and strain- specific. In a mixed flora dominated by mesophilic bacteria, the effect is largely bacteriostatic. The system exhibits bacteriocidal effect on some Gram negative organisms such as *Pseudomonas* sp. and *E. coli*. In case exogenous H<sub>2</sub>O<sub>2</sub> is present, the effect may also be bacteriostatic. The LP system has an impact on the glycolytic enzymes and hence, the metabolic activity is adversely affected. Lysis occurs due to leaking of bacterial contents.

- Owing to the bacteriostatic effect, it is not possible to hide poor quality of milk. The high bacterial counts will be revealed during plating, MBRT etc.
- The antibacterial oxidation products are not heat stable. The stability is temperature dependent, leading to complete destruction by pasteurization.
- The oxidation products are not stable at neutral pH. Any surplus will decompose to thiocyanate.
- The preservation effect is directly proportional to the thiocyanate concentration, provided equimolar concentration of H<sub>2</sub>O<sub>2</sub> is present. In practice small quantities of thiocyanate is added to make up the concentration
- The quantity of H<sub>2</sub>O<sub>2</sub> to be added must be monitored. If excess quantity is added (for example, 300-800 ppm), lactoperoxidase is inactivated and preservation effect is then largely due to H<sub>2</sub>O<sub>2</sub>.

### 8.3 Method of Adoption

The LP system may be used when technical, economic and/or practical reasons do not permit chilling. It is not recommended for the use of individual farmers. It should be practiced only at collection centers with proper cleaning and sanitizing facilities. The manpower deputed to handle the system should be given adequate training. The dairy that receives the milk should monitor the system. Appropriate detection methods should be set up to avoid foul practices. The LP system does not eliminate the need for the normal clean milk production methods that are adopted at farm levels. It does not exclude the need for pasteurization before consumption

The preservation effect is temperature-dependent. The preservation effect under laboratory and field experimental conditions for stored milk which had been produced hygienically are listed in Table 8.1.

**Table 8.1. Preservation effect of LP system at different temperatures**

Temp. of milk (°C)	Duration of preservation (h)
30	7-8
25	11-12
20	16-17
15	24-26

## 8.4 Practical Application

1. At the village collection centre, each clean and washed milk can should be given a 3 min chlorine rinse (400 ppm) immediately before milk is poured into it.
2. Sodium thiocyanate (NaSCN) should be added @ 14 mg/l milk and mixed well for a minute with a plunger.
3. Sodium percarbonate (precursor of H<sub>2</sub>O<sub>2</sub>) should be added @ 30 mg/l milk and stirred well for 2-3 min.
  - This sequence of addition should be followed because the enzyme action starts when H<sub>2</sub>O<sub>2</sub> added and is completed within 5 min of addition of H<sub>2</sub>O<sub>2</sub>.
  - This rate of addition will provide 75 ppm of NaSCN and 50 ppm of H<sub>2</sub>O<sub>2</sub> as percarbonate.
  - The LP activation must be done within 2-3 hours of milking
4. After 10 hours of milking (or 7 hours of first treatment), a booster dose of 35 ppm H<sub>2</sub>O<sub>2</sub> (~ 20 mg sodium percarbonate per litre milk) should be mixed into milk.
5. To make the practice easy, the quantities of NaSCN and sodium percarbonate for a certain volume of milk (say 40 l) should be distributed to collection points in prepacked quantities, say for a few weeks at a time.

## 8.5 Monitoring the Practice

The usage of the system can be monitored through acidity, MBRT, Resazurin reduction test, total viable count and analysis of thiocyanate concentrations.

## 8.6 Effect on Milk Quality

- Field trials conducted in Kenya, Sudan, Mexico, Sri Lanka, Pakistan and India report that untreated milk spoiled within two hours whereas treated milk was preserved for different durations depending on the temperature of milk.
- There was no difference on the preservation effect of cow and buffalo milk.
- The quality of initial milk was, in all cases, proportional to the time taken for spoilage.
- A strong bacteriostatic effect was reported on mesophilic and thermophilic bacteria and also spores.
- Total and proteolytic psychrotrophs were also affected.

\*\*\*\*\* 😊 \*\*\*\*\*

**Lesson 9**  
**TRANSPORTATION OF MILK**

**9.1 Introduction**

In rural India milk production is largely a subsidiary activity to agriculture in contrast to organized dairying in western countries. Small farmers and landless labourers usually maintain one to three milch animals. As a result, small quantities of milk are produced by each of the dairy farmers who are widely spread all over the country. This situation makes the task of milk collection and transportation complex. For efficient transportation, planning of routes by means of extensive survey is most important. In this connection, one must consider the availability of milk, road access to the milk collection points and their distance from the site of the dairy plant. The collected milk is generally filled in cans for transportation to the chilling center or directly to the milk plant. Milk must be brought to the chilling or dairy plant within three hours of milking.

**9.2 Transportation of Milk**

The milk should be transported to the dairies under chilled conditions ( $< 4^{\circ}\text{C}$ ) to prevent bacterial growth. In India, raw milk collected at various collection centers in the rural areas is dispatched to the dairy plant in two ways:

**9.2.1 Transporting milk through cans**

Suitable when milk volume handled is low.

**9.2.2 Transporting milk through tankers (2000 to 10,000 liters of chilled milk)**

This method is useful especially for transporting chilled milk from bulk milk coolers or chilling centers. Refrigerated/insulated tanker (Fig. 9.1) is important for transporting market milk, butter milk and other perishable dairy products.

**9.3 Advantages of Tanker Over Cans**

- quick mode of transportation
- low transport cost per liter
- better temperature control
- less risk of contamination
- time and labors savings
- overall savings in detergents

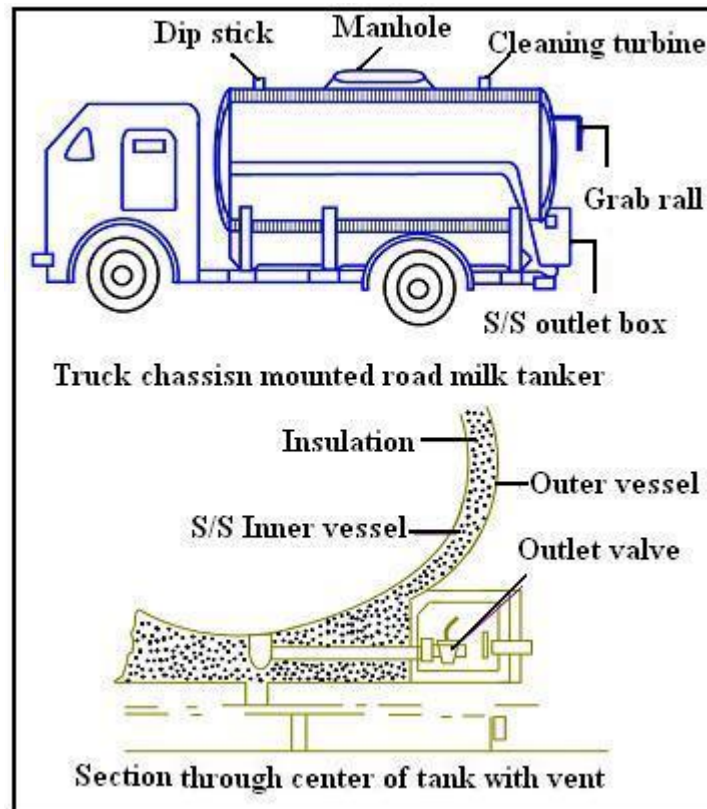

Fig. 9.1 Road tanker

## 9.4 Transport Systems in India

### 9.4.1 Short distances

1	Head load (15 – 20 kg)	(3 – 8 km) - mostly important in hilly areas
2	Shoulder sling (40 kg)	10-12 km
3	Bullock cart (300 – 400 kg)	12 km
4	Tonga (250-350 kg)	> 12 km
5	Cycle (40 kg)	15 km or more
6	Cycle rickshaw (150-200 kg)	10 km
7	Boat (40-200 kg)	2-8 km
8	Auto rickshaw (250-500 kg)	> 15 km

### 9.4.2 Long distances

1	Truck motors (1-3 tones)	80 km
2	Road tankers (5 tones)	> 80 km
3	Railway wagon (> 11 tones)	> 80 km

#### Note

- The tankers or wagons should be suitably insulated so as to permit not more than 1-1.5°C rise in temperature up to 12 h of journey.
- The wagons should be well insulated and solid CO<sub>2</sub> maybe used.

## Module 5. Physico-chemical, microbiological and nutritional properties of milk

### Lesson 10

## PHYSICAL PROPERTIES AND COMPOSITION OF MILK

### 10.1 Introduction

Milk is a complex biological fluid consisting of seven main components: water, fat, protein, sugar (lactose), minerals, vitamins and enzymes. It is a white opaque fluid in which fat is present as an emulsion, protein and some mineral matters in colloidal suspension and lactose together with some minerals and soluble proteins in true solution. The opacity of milk is due to its content of suspended particles of fat, proteins and certain minerals. The colour varies from white to yellow depending on the carotene content of the fat. Milk has a pleasant, slightly sweet taste, and pleasant odour. It is an excellent source of calcium, phosphates and riboflavin.

### 10.2 Physical Properties of Milk

#### 10.2.1 Colour and optical properties

Milk appears turbid and opaque owing to light scattering by fat globules and casein micelles. Optical properties are influenced by the manner of scattering of light by the molecules. Light scattering occurs when the wavelength of light matches the magnitude of the particle. Thus, smaller particles scatter light of shorter wavelengths and vice versa. Skim milk appears slightly blue because casein micelles scatter the shorter wavelengths of visible light (blue) more than the red. Beta-carotene, the carotenoid precursor of vitamin A, is responsible for the creamy colour of cow milk. The greenish tinge in whey is due to the presence of riboflavin. Refractive index of milk is an optical property and ranges from 1.3440 to 1.3485 at 20°C. The relation between solids content of milk and refractive index is linear, and the contributions of the several constituents is additive.

#### 10.2.2 Flavour of milk

The natural sweet flavour of milk is due to the combined effect of its components. Off-flavours are very quickly developed in milk owing to several factors. The feed consumed by animals may lead to some undesirable flavours. Bacterial growth in milk causes fruity, barny, malty or acid flavours. Enzyme activities also may lead to unnatural flavours, rancidity due to lipase action being a classic example. Oxidative reactions may cause a cardboard flavour in milk. Processing of milk may produce cooked flavours.

#### 10.2.3 Specific gravity and density

Milk is heavier than water. The specific gravity of cow milk varies from 1.018 to 1.036 and of buffalo milk from 1.018 to 1.038. Though specific gravity varies with temperature, (lower at higher temperature and vice versa), the rate of this variation is not uniform.

The density of milk varies within the range of 1.027 to 1.033 kg/cm<sup>3</sup> at 20°C. The density of milk is used to estimate the solids content, to convert volume into mass and vice versa and to calculate other physical properties such as dynamic viscosity. It is dependant on temperature at the time of measurement, temperature history of the sample, composition of the sample (particularly fat content) and inclusion of air.



## 10.2.4 Viscosity

Viscosity of milk depends on the temperature and the amount and state of dispersion of the solid constituents, mainly casein and fat. Viscosity of the whole milk at 25°C is about 2.0 cP. Cooler temperatures increase viscosity due to the increased voluminosity of casein micelles whereas temperatures above 65°C increase viscosity due to the denaturation of whey proteins. An increase or decrease in pH of milk also causes an increase in casein micelle voluminosity. The effect of agitation on viscosity is not uniform. Sometimes, agitation causes partial coalescence of the fat globules, hence increasing the viscosity and at other times, agitation may disperse fat globules that have undergone cold agglutination, leading to a decrease in viscosity.

## 10.2.5 Surface Tension

The surface activity of milk is related to proteins, fat, phospholipids and fresh fatty acids present in it. Homogenization and heat sterilization increase the surface tension of milk. Milk has a surface tension of 50 dyne/cm at 20°C.

## 10.2.6 Freezing and boiling points of milk

The freezing points of cow and buffalo milk vary from -0.512 to -0.572°C and from -0.521 to -0.575°C respectively. Freezing point of milk is mainly used to determine added water. The boiling point of milk is 100.17°C.

## 10.2.7 Acidity and pH

Freshly drawn milk has a pH value in the range of 6.5 to 6.7 and contains 0.14 to 0.18% titratable acid calculated as lactic acid. There is no developed acidity in freshly drawn milk, the slightly lower than the neutral pH being attributed to the presence of carbon dioxide, citrate, casein etc.

## 10.2.8 Heat stability of milk

Heat stability is defined as the length of time required to induce coagulation at a given temperature or the temperature required to induce coagulation in a given time. The stability of milk system at the high processing temperatures to which milk is exposed for the manufacture of certain products is very important. Caseins and salt balance of milk governs its heat stability. Added citrates, phosphates and calcium have a great impact on the heat stability.

## 10.3 Composition of Milk

Factors that influence the chemical composition of milk are individuality of the animal, breed variation, seasonal changes, weather, age and health of the animal, managerial practices including nature and quality of feed, stage of lactation, the quarter of the udder of the animal from which milk is drawn, different fractions of milking etc. Tables 10.1 and 10.2 summarize the composition of milk.

**Table 10.1 Average composition of milk of different mammals (%)**

Species	Water	Fat	Protein	Total solids	SNF	Lactose	Ash	Energy (kcal)
Buffalo	82.76	7.38	3.60	17.24	9.86	5.48	0.78	102
Camel	87.68	5.38	2.98	12.32	6.94	3.26	0.70	72
Cow	86.61	4.14	3.58	13.39	9.25	4.96	0.71	71
Donkey	88.98	2.53	2.01	11.02	8.49	6.07	0.41	55
Goat	87.10	4.25	3.52	12.90	8.65	4.27	0.86	69
Human	87.43	3.75	1.63	12.57	8.82	6.98	0.21	68
Mare	89.07	1.59	2.69	10.93	9.34	6.14	0.51	48
Sheep	81.16	7.90	5.23	18.84	10.94	4.81	0.90	111
Whale	44.62	42.20	10.90	55.38	13.18	1.31	0.97	429

Average compiled from various sources

**Table 10.2 Average composition of milk of selected breeds of cows (%)**

Breed	Total solids	Fat	Protein	SNF	Lactose	Ash
<b>Indian breeds</b>						
Red Sindhi	13.83	4.90	3.42	8.93	4.81	0.70
Gir	13.19	4.73	3.32	8.46	4.48	0.66
Tharparkar	13.42	4.55	3.36	8.87	4.83	0.68
Sahiwal	13.58	4.55	3.33	9.03	5.04	0.66
Jersey	14.73	5.37	3.73	9.36	4.93	0.70
Friesian	12.06	3.40	3.13	8.66	4.86	0.67
Crossbred	13.46	4.50	3.37	8.96	4.92	0.67
<b>Foreign breeds</b>						
Holstein	12.23	3.54	3.29	8.69	4.68	0.72
Brown Swiss	13.31	3.99	3.64	9.32	4.94	0.74
Ayrshire	12.75	3.95	3.48	8.80	4.60	0.72
Guernsey	13.94	4.72	3.75	9.22	4.71	0.76
Jersey	14.71	5.13	3.98	9.58	4.83	0.77
Shorthorn	12.94	4.00	3.32	8.94	4.89	0.73

Average compiled from various sources

Fresh milk contains 84–87% water in which all other constituents of milk are dissolved and in which are dispersed two different systems, namely fat globules enclosed within their protective membrane as an oil-in-water emulsion, and protein, containing casein molecules and insoluble salts in a colloidal suspension.

\*\*\*\*\* 😊 \*\*\*\*\*

## Lesson 11

### MACRO-COMPONENTS OF MILK - FAT AND LACTOSE

#### 11.1 Fat

Fat is the most commercially significant and most variable constituent of milk. Fat content varies from breed to breed and also among individuals of the same breed, the variation being caused by many factors. Most of the (> 95%) milk fat exists in the form of globules of 0.1-15  $\mu$  diameter (cow milk fat -  $\sim$  3-8  $\mu$ , buffalo milk fat -  $\sim$  4-10  $\mu$ ). A thin membrane (8-10 nm thick) covers these liquid fat droplets. The properties of this membrane are vastly different from both milk fat and plasma. The fat globule membrane is rich in phospholipids and also contains lipoproteins and other glycerides. These phospholipids are involved in the oxidation of milk. The membrane decreases the lipid-serum interface to very low values, 1-2.5 mN/m, preventing the globules from immediate flocculation and coalescence, as well as protecting them from enzymatic action. Fat comprises of different glycerides of low melting point. The composition of fat varies with the feed plan, nutrition, stage of lactation, breed and species, the first being the most important.

The size and number of fat globules vary depending on the breed of the animal and method of milking. The globules become smaller and more numerous as lactation advances. Machine milking produces fat globules of more uniform size than hand milking. Homogenization reduces the fat globules to a small size and reduces the tendency of separation during storage. The larger the size of the globules, the quicker they rise as cream to the top of the milk and easier it is to churn such cream into butter. For this reason buffalo milk fat is more easily churned into butter than cow milk fat. The milk of animals in advance lactation is less suitable for being churned into butter. Milk containing small globules is, however, more suitable for cheese making, since less fat is lost in whey. Milk fat is quite bland in taste and imparts smoothness and palatability to fat-containing dairy products.

In milk fat, butyric, caproic, caprylic and capric acids, present in high proportions, are characterized by strong odours and flavour. These volatile acids are not present in such high proportion in other naturally occurring fats. The fatty acid content of milk fat can also be influenced by the amount and type of feeds consumed, stage of lactation and breed of the animal. Milk fat also contains cholesterol, thus differentiating it from vegetable fats, which contain phytosterols. Milk contains 0.1 to 0.23% phospholipids, viz. lecithin, phosphatidyl serine, sphingomyelin, inositol, cerebrosides etc. Some of these phospholipids serve as antioxidants in prolonging the shelf-life of ghee.

The colour of fat depends upon its carotene content and varies with the species, breed and feed of the animal. The yellow colour of cow milk is due to the carotene. Buffalo milk does not contain carotene. Ghee from cow fed on an abundant green fodder is more yellow than when fed on dry food. Similarly some breeds such as Jersey and Guernsey may produce milk deep yellow in colour.

Saturated fatty acids (no double bonds), such as myristic, palmitic and stearic constitute two thirds of milk fatty acids. Oleic acid is the most abundant unsaturated fatty acid in milk with one double bond.

### 11.2 Lactose

Lactose is the major milk sugar or carbohydrate. Fresh milk also contains other carbohydrates in small amounts, including glucose, galactose, and oligosaccharides. Lactose is present in true solution and, therefore, goes into whey when caseins are separated. Lactose constitutes 4.8 to 5.2% of milk, 52% of milk SNF, and 70% of whey solids. Lactose can be quickly fermented by micro-organisms to lactic acid and is, therefore, essential in the manufacture of cultured dairy products like cheese, dahi and butter-milk. It contributes to the nutritive value of milk and milk products, and is responsible for the texture and miscibility of some milk products. Lactose imparts colour and flavour to dairy products heated to high temperatures. Sucrose is six times sweeter than lactose.

Lactose is a disaccharide made up of two monosaccharides, glucose and galactose (Fig. 11.1). Lactose is hydrolyzed by the enzyme  $\mu$ -galactosidase (lactase), the results being the two monosaccharides, increased sweetness and depressed freezing point. People suffering from lactose intolerance lack this enzyme and therefore, cannot digest lactose. This sugar crystallizes in an alpha form and results in the defect called sandiness in ice cream.

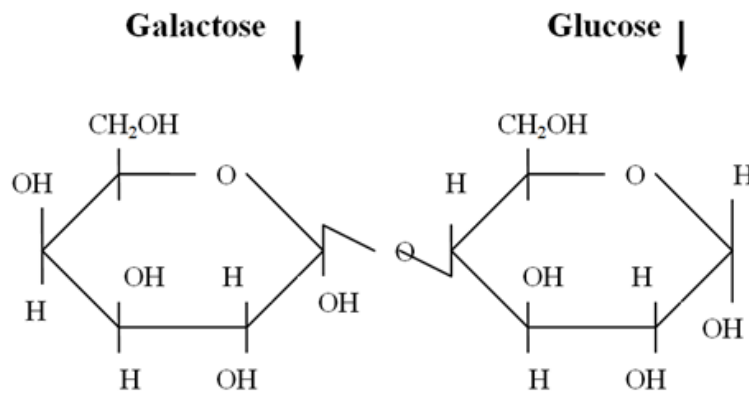

Fig. 11.1 Molecular structure of lactose

\*\*\*\*\* 😊 \*\*\*\*\*

**Lesson 12**  
**Macro-components of milk - Protein**

**12.1 Milk Proteins**

The caseins, whey proteins and non-protein nitrogen (NPN) make up the nitrogen content of milk (76%, 18% and 6% respectively). Table 12.1 lists the proteins in milk. The minor proteins associated with the fat globule membrane are not included here. The Rowland fraction method facilitates the separation of caseins, whey proteins and NPN. Casein precipitates at pH 4.6 and is thus separated from whey nitrogen. Total proteins may be separated from whey NPN at pH 5 with sodium acetate and acetic acid.

**Table 12.1 Concentration of proteins in milk\***

<b>Protein</b>	<b>Quantity (g/L)</b>	<b>Quantity (% of total protein)</b>
<b>Total protein</b>	33	100
<b>Total casein</b>	26	79.5
Alpha s1	10	30.6
Alpha s2	2.6	8.0
Beta	9.3	28.4
Kappa	3.3	10.1
<b>Total whey proteins</b>	6.3	19.3
Alpha lactalbumin	1.2	3.7
Beta lactoglobulin	3.2	9.8
Proteose peptone	0.8	2.4
Immunoglobulins	0.7	2.1

\*Average values derived from different sources

**12.1.1 Caseins**

Casein constitutes about 80% of the total proteins present in milk. In fresh milk, casein is held in colloidal suspension. Casein contributes in a big way to the viscosity and white colour of milk. Free casein is almost insoluble in water but is rapidly dissolved by dilute alkalis. Casein in milk can be precipitated with dilute acids, salts or rennet. All caseins precipitate at pH 4.6. Casein particles are termed as 'casein micelles'. Biologically, casein serves as a carrier for calcium and phosphate to nurture the young calf and form a clot in the stomach to aid easier digestion. The micelle also contains citrate, minor ions, lipase and plasmin enzymes, and entrapped milk serum. Caseins can be further classified into three major groups as alpha (?), beta (?) and kappa (?). Alpha casein is further sub-divided into ?s1 and ?s2 fractions. Table 12.2 lists the major casein fractions in milk.

**Table 12.2 Major casein fractions\***

<b>Fraction</b>	<b>Molecular weight</b>	<b>Amino acid residues</b>	<b>Quantity (% of total casein)</b>
Alpha s1	23000	199	35-40
Alpha s2	25000	207	10-12
Beta	24000	209	33-38
Kappa	19000	169	10-15

\*Average values derived from different sources

### 12.1.2 Whey proteins

The greenish-yellow clear liquid that separates out of milk after precipitation of caseins at pH 4.6 is called whey and the proteins contained therein are whey proteins. These globular proteins are more water soluble than caseins and are prone to heat denaturation. Denaturation increases their water holding capacity. Native whey proteins have good gelling and whipping properties. The principle fractions of whey proteins are detailed in Table 12.3.

**Table 12.3 Major whey protein fractions\***

Fraction	Quantity (% of total whey protein)
Beta lactoglobulin	50-55
Alpha lactalbumin	20-25
Immunoglobulins	10-15
Bovine serum albumin	5-10
Lactoferrin	1-2
Lactoperoxidase	0.5
Lysozyme	< 0.1

\*Average values derived from different sources

Beta-lactoglobulins comprises approximately half the total whey proteins. It is coagulated by heat, which is why colostrum curdles when heated. It binds fat-soluble vitamins making them more available to the body and provides an excellent source of essential and branched chain amino acids. These help prevent muscle breakdown and spare glycogen during exercise. Beta-lactoglobulins may also be helpful in controlling certain liver conditions such as cirrhosis.

Alpha lactalbumin is not coagulated by rennet or acids but is precipitated by heat. The extent of coagulation depends on temperature of holding, salt concentration and pH of milk. It is the primary protein found in human breast milk and is a good source of essential amino acids (particularly tryptophan) and branched chain amino acids. This is the only whey protein component capable of binding calcium.

The immunoglobulins provide protective effect to the offspring against enteropathogenic micro-organisms. It is the predominant whey protein component found in colostrum. Bovine milk contains only traces of IgA. Bovine serum albumin is a large sized protein with a good essential amino acid profile and fat binding properties. Lactoferrin is an anti-oxidant that naturally occurs in many body secretions such as tears, blood, breast milk, saliva and mucus. It is a red-coloured iron-chelating protein. It inhibits enteropathogenic organisms due to its ability to bind iron. Iron is an essential nutrient often required for bacterial growth. Lactoperoxidase and lysozyme are enzymes that have antibacterial activities. The latter exhibits immunity-enhancing properties. Although lysozyme from egg white had found more industrial applications in the past, it has now been recognized that the enzyme isolated from human or bovine milk has far greater lytic activity compared to egg lysozyme.

### 12.1.3 Milk enzymes and non-protein nitrogenous (NPN) substances

Some indigenous enzymes that have been isolated from milk are lipase, aryl esterase, alkaline phosphatase, acid phosphatase, xanthine oxidase, peroxidase, protease, amylase, catalase and lactase. The most significant group is the hydrolases, comprising of lipoprotein lipase, plasmin and alkaline phosphatase. Milk contains some NPN substances that constitute about 5 percent of

the total nitrogen in milk. Some examples of this group are amino acids, creatine, urea, uric acid, creatinine and hipuric acid.

For Agriculture related Books, News,  
Recruitment, Information and Events etc Visit  
at  
[www.AgrMoon.Com](http://www.AgrMoon.Com)

**Lesson 13**  
**MICRO COMPONENTS OF MILK**

**13.1 Vitamins**

Vitamins are organic substances that are essential to normal life processes, but cannot be synthesized by the body. They occur in very small concentrations in both plants and animals. Milk is a good source of vitamins (Table 13.1). Milk contains the fat soluble vitamins A, D, E, and K. As milk fat is an important dietary source of vitamin A, low fat products are normally supplemented with this vitamin. The content of Vitamin D, which also aids in the absorption of calcium, is influenced by the feed of the animals. Milk is a fair source of vitamin E. It is also a fairly good source of water soluble B vitamins such as thiamine (B<sub>1</sub>), riboflavin (B<sub>2</sub>), niacin (B<sub>3</sub>), pantothenic acid (B<sub>5</sub>), pyridoxine (B<sub>6</sub>) and cyanocobalamin (B<sub>12</sub>). Milk is, however, a poor source of vitamin C (ascorbic acid). The little quantity of vitamin C that is present in raw milk is very heat-labile and easily destroyed by pasteurization.

**Table 13.1 Vitamin content of fresh milk (per 100 g)**

Vitamin	Quantity		Unit
	Cow milk	Buffalo milk	
Vitamin A	28	53	µg
Thiamin (B <sub>1</sub> )	0.044	0.052	mg
Riboflavin (B <sub>2</sub> )	0.183	0.135	mg
Niacin (B <sub>3</sub> )	0.107	0.091	mg
Pantothenic Acid (B <sub>5</sub> )	0.362	0.192	mg
Pyridoxine (B <sub>6</sub> )	0.036	0.023	mg
Cyanocobalamin (B <sub>12</sub> )	0.44	0.36	µg
Vitamin C	0.0	2.3	mg
Vitamin D	40	ND	IU
Vitamin E	0.06	ND	mg
Vitamin K	0.2	ND	µg
Biotin	3.5	6	µg
Folate	5	ND	µg

Average derived from different sources, ND - no data available

**13.2 Minerals**

All 22 minerals considered essential to the human diet are present in milk (Table 13.2). Milk is an important source of dietary calcium, magnesium, phosphorus, potassium, selenium, and zinc. In milk, approximately 67% of the calcium, 35% of the magnesium, and 44% of the phosphate are bound to salts within the casein micelle and the rest are soluble in the serum phase. Milk contains very small amounts of copper, iron, manganese and sodium. Other minerals such as aluminium, boron, zinc, cobalt, iodine, fluorine, molybdenum, nickel, lithium, barium, strontium and silica are also present in milk, but in minute amounts.



**Table 13.2 Mineral content of milk (per 100 g)**

Mineral	Quantity		Unit
	Cow milk	Buffalo milk	
Arsenic	2-6	ND	µg
Calcium	113	169	mg
Chloride	90-110	ND	mg
Chromium	0.8-1.3	ND	µg
Cobalt	0.05-0.13	1.15	µg
Copper	0.011	0.046	mg
Fluoride	3-22	ND	µg
Iodine	26	1.3	µg
Iron	0.03	0.12	mg
Magnesium	10	31	mg
Manganese	0.003	0.018	mg
Molybdenum	1.8-12	ND	µg
Nickel	0-0.5	ND	µg
Phosphorus	91	117	mg
Potassium	143	178	mg
Selenium	3.7	ND	µg
Silicon	75-700	ND	µg
Sodium	40	52	mg
Tin	4-50	ND	µg
Vanadium	Tr-31	ND	µg
Zinc	0.40	0.11	mg

Average derived from various sources, ND – no data available

### 13.3 Lactoferrin

Lactoferrin (LF) is a single-chain, metal-binding glycoprotein. It is a red coloured iron-binding protein and may also mediate some effects of inflammation and have a role in regulating various components of the immune system. It has antibacterial, antifungal, anti-endotoxin, and antiviral activities. It inhibits enteropathogenic organisms due to its ability to bind iron, as iron is an essential nutrient often required for bacterial growth. It promotes the growth of beneficial bacteria such as bifidobacteria. Lactoferrin is an anti-oxidant that naturally occurs in many body secretions such as tears, blood, breast milk, saliva and mucus. Lactoferrin in milk might play a role in iron absorption and/or excretion in newborns, as well as in promotion of intestinal cell growth. Its level in human milk is about 1 g/L and in human colostrums, about 7 g/L. As the levels of this protein in cow milk is only about one-tenth of that in human milk, this has caught the attention of those involved in designing human milk replacement formulae.

### 13.4 Lactoperoxidase

Lactoperoxidase is an oxido-reductase enzyme that occurs in milk, saliva, tears, cervical mucus. It is a single polypeptide chain with a molecular weight of 77,000 – 100,000. It is a relatively heat resistant enzyme whose activity remains sufficient even after pasteurization. Cow milk has 1.4 units/ml of lactoperoxidase, whereas buffalo milk has 0.9 units/ml. The thermal stability of buffalo milk lactoperoxidase is higher than that of cow milk. Lactoperoxidase has been widely researched for its ability to preserve raw milk. The amount of this enzyme required for preservation is 0.5-1 mg/L, much lower than its concentration in cow milk (30 mg/L).

## 13.5 Lysozyme

Lysozyme is an enzyme that is abundantly present in the mucosal membranes that line the human nasal cavity and tear ducts. It can also be found in high concentration in egg white. Lysozyme destroys bacterial cell walls by hydrolyzing the polysaccharide component of the cell wall. Human milk contains 0.4 g/L of lysozyme, an enzyme that contributes to antibacterial activity in human milk. Lysozyme content of buffalo milk is 15.2  $\mu\text{g}/100\text{ ml}$  which is lower than cow milk. Although lysozyme from egg white had found more industrial applications in the past, it has now been recognized that the enzyme isolated from human or bovine milk has far greater lytic activity compared to egg lysozyme.

\*\*\*\*\* 😊 \*\*\*\*\*

**Lesson 14**  
**MICROBIOLOGY OF RAW MILK**

**14.1 Introduction**

Microorganisms are microscopic, mostly single-celled organisms capable of rapid reproduction under proper growth conditions. Some of them are helpful and serve useful functions such as producing chemical changes that are desirable in the production of fermented dairy products such as cheese and yogurt. Others can cause milk and its products to spoil and make them inedible, thus causing the dairy industry great losses. Microorganisms termed as pathogens can be harmful to health and are important from the safety and public health point of view.

Milk in the mammary gland is normally sterile though bacteria are present in mammary glands of unhealthy animals. Once the milk leaves the udder, microflora from the exterior of the udder, coat of the animal, atmosphere, utensils and workers easily pass into the milk. Therefore, even under extremely clean conditions, freshly drawn milk may have a few thousand bacteria. Conditions of storage, pre-processing activities and unhygienic practices may further add to the bacterial load. The microbial content of milk is a very good indicator of the sanitary quality and conditions of production.

**14.2 Thermophilic Bacteria**

Thermophilic bacteria can grow in milk held at elevated temperatures (55°C or higher), including pasteurization temperatures. The species that grow in higher temperatures include *Bacillus* species which enter milk from various sources in the farm, or from poorly cleaned equipment in the processing plant. When the milk is held at high temperatures for long periods, these bacteria rapidly increase in numbers and may cause flavour defects, curdling or problems related to legal standards for microbiology. Thermophilic bacteria are enumerated by Standard Plate Count with plate incubation at 55°C.

**14.3 Thermoduric Bacteria**

Thermoduric bacteria can survive exposure to temperatures considerably above their maximal temperature for growth. In the dairy industry, the term is applied to those organisms which survive, but do not grow, at pasteurization temperature. They usually include species of *Micrococcus*, *Streptococcus*, *Lactobacillus*, *Bacillus* and occasionally some gram-negative rods. The sources of contamination are poorly cleaned and sanitized utensils and equipment on farm and processing plants. These bacteria contribute to significantly higher Standard Plate Count on pasteurized milk. The thermoduric count has been used in the dairy industry primarily as a test of hygienic practices and sanitary conditions maintained. It is also a means for detecting sources of contamination in products.

**14.4 Psychrotrophic Bacteria**

The terms psychrotropic or psychrophilic mean 'cold-loving' and microorganisms which play a significant role in biological processes in low-temperature environments are classified under this group. Psychrophilic species such as *Pseudomonas*, *Flavovacterium*, *Alcaligenes*, *Acinetobacter*, and *Bacillus* can grow rapidly at 7°C and below. They are generally non-pathogens and are rarely present in the udder. They can cause off-flavours (fruity, stale, bitter, putrid, rancid) in dairy products. The counts of these bacteria in milk depend upon sanitary conditions prevailing during production and the time-temperature combination of milk storage before processing. The effect of

psychotropic bacteria on the shelf life of pasteurized milk is largely dependent on number present after packaging, the rate of growth, the storage period, and the biochemical activity of the organisms.

### 14.5 Lactic Acid Bacteria (LAB)

When milk is held at ordinary temperature, it curdles or putrefies within a few hours owing to the rapid growth of bacteria. The lactic acid forming bacteria (those fermenting lactose into lactic acid) are important because they sour the milk. Some acid-forming bacteria maybe useful, such as those used as starter cultures in cultured dairy products such as dahi, yogurt and cheese and some harmful, such as those causing curdling and spoilage of milk. Some of the bacteria significant in dairy industry are listed in Figure 14.1.

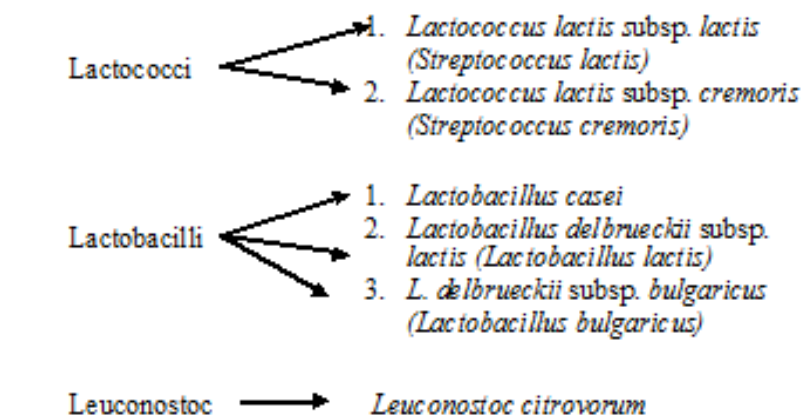

Fig. 14.1 Lactic acid bacteria significant in dairy industry\*

\*Old names in brackets

### 14.6 Spoilage Organisms

Microbial spoilage of milk denotes the degradation of protein, carbohydrates, and fats by microorganisms and/or their enzymes. Coliforms (e.g. *Escherichia coli*) are facultative anaerobes that grow optimally at 37°C. They also can cause rapid spoilage of milk because they are able to ferment lactose with the production of acid and gas, and are able to degrade milk proteins. As they are destroyed by pasteurization treatment, their presence in processed milk is indicative of post-pasteurization contamination. Psychotropic organisms play a major role in the spoilage of milk. Although most psychrotrophs are destroyed by pasteurization, some like *Pseudomonas* sp. *Alcaligenes* are of economic value, since they produce a high bacterial count during storage and may also create a ropy milk condition. *Pseudomonas fluorescens*, *Pseudomonas fragi* can produce proteolytic and lipolytic extracellular enzymes which are heat stable and capable of causing spoilage. They are capable of producing heat resistant proteases and lipases, which are capable of surviving even UHT processing. Some organisms that can survive pasteurization temperatures and grow at refrigeration temperatures are *Bacillus*, *Clostridium*, *Corynebacterium*, *Arthrobacter*, *Lactobacillus*, *Microbacterium*, *Micrococcus* and *Streptococcus*. These organisms may be detected by their characteristic morphology or by plate count incubated at refrigeration temperatures.

Some other groups of acid-forming bacteria that are significant in dairy field include two important groups of *Streptococcus*. One of these groups found in high heat-processed milk and milk products produces acid and gas with objectionable proteolysis (*Streptococcus liquifaciens*). The second group causing rapid curdling of milk include gas-forming (*Aerobacter aerogenes*, *Bacillus polymyxa*, *Clostridium butyricum*), ropy or slimy milk-forming (*Alcaligenes viscosus*) or sweet-curdling (*Bacillus cereus*) bacteria. Milk may also be fermented by yeasts (*Saccharomyces delbrueckii*, *Candida mycoderma*) and moulds (*Cladosporium*, *Penicillium*, *Rhizopus*).

## 14.7 Pathogenic Organisms

Clean milk production practices, hygienic handling and storage of milk, thermal processing practices such as pasteurization have decreased the incidence of milkborne diseases such as tuberculosis, brucellosis and typhoid fever. Milk is pasteurized primarily to eliminate any pathogenic organism which may be present so as to make it safe for human consumption.

However, pathogens such as *Bacillus cereus*, *Listeria monocytogenes*, *Yersinia enterocolitica*, *Salmonella spp.*, *Escherichia coli* O157:H7 and *Campylobacter jejuni* are known to survive pasteurization. Molds (*Aspergillus*, *Fusarium* and *Penicillium*) may produce mycotoxins which can be a health hazard. These organisms may enter into milk from an infected animal or by contamination from various sources such as infected food handlers.

\*\*\*\*\* 😊 \*\*\*\*\*

**Lesson 15**  
**NUTRITIONAL PROPERTIES OF MILK**

**15.1 Introduction**

The primary function of milk in nature is to nourish and provide immunological protection for young mammals. Milk provides excellent support towards human nutrition, as it contains balanced quantities of required nutrients such as protein, fat, carbohydrate, minerals, and vitamins. The energy value of milk of selected mammals is detailed in Table 15.1. Milk has a mildly sweet and pleasant flavour which is of wide appeal and is relished by most people and hence is innately palatable. The digestibility of milk is high, which makes it an ideal food for children, adults, invalids and convalescing patients. Milk is an economical source of energy and furnishes almost all essential dietary constituents required for normal physiological functions. It supplies body-building proteins, bone-forming minerals and health-giving vitamins and furnishes energy-giving lactose and milk fat. Besides supplying certain essential fatty acids, it contains the above nutrients in an easily digestible form. All these properties make milk an important food for pregnant and lactating women, growing children, adolescents, adults, invalids, convalescents and patients alike.

**Table 15.1 Energy value of milk of selected breeds of animals (in 100 g)**

<b>Nutrients</b>	<b>Buffalo</b>	<b>Cow</b>	<b>Goat</b>	<b>Sheep</b>	<b>Human</b>
Energy kcal *	97 (406)	60 (251)	69 (289)	108 (452)	70 (293)
Energy from carbohydrate	20.4 (85.5)	17.7 (74.1)	17.4 (72.9)	20.9 (87.6)	27.1 (113)
Energy from fat	60.6 (254)	28.6 (120)	36.4 (152)	61.5 (258)	38.5 (161)
Energy from protein	16.0 (67.0)	13.7 (57.6)	15.2 (63.6)	21.5 (107)	4.4 (18.4)

\*Figures in parenthesis denote the value in kilo Joules

*Source: www.nutritiondata.com*

**15.2 Milk Fat**

Since milk fat stays in the stomach longer than do carbohydrates and proteins; they improve satiety value of diet. It is a carrier of the fat-soluble vitamins A, D, E and K. The short chain fatty acids are unique of milk lipids and are digested and absorbed quickly. The position of double bond linkages along the carbon chain in polyunsaturated fatty acids (PUFA) is of great nutritional importance. Milk lipids also contain phospholipids, which are vital part of brain and nervous tissues. They are extremely important as intermediary substance of fat metabolism. Conjugated linoleic acids (CLAs) are a group of naturally occurring isomers of linoleic acid and are of great interest with respect to their anticarcinogenic effect. CLAs also exhibit several biological activities such as immunomodulation, reduction in atherosclerosis, increase in bone mass and muscle mass.

**15.3 Milk Sugar**

Lactose stimulates the growth of lactobacilli in the large intestine; these organisms synthesize many of the B vitamins. Lactose improves the absorption of several important minerals like

calcium, phosphorus and magnesium. It yields one molecule each of glucose and galactose upon hydrolysis, both of which are convertible into glycogen in the human body. Galactose is necessary for the synthesis of the galactosidases of brain and medullar sheaths of nerve tissues and myelin-formation of cerebrosides in infants. Lactose is digested and absorbed from the intestine very slowly. The low solubility of lactose also makes it less irritating to the stomach and intestinal musoca than the highly soluble sugars. It thus makes milk valuable in diets during treatment of ulcers of the stomach and duodenum.

### 15.4 Milk Proteins

Fifty percent of recommended daily allowance of protein for adults may be derived from one liter of milk. Casein has a protein efficiency ratio (PER) of 2.89–3.10. Milk proteins are of high biological value as they contain all the essential amino acids in amounts and proportions required to support growth and perform numerous functions within the body. A comparison of amino acid constituents of milk with those of common foods is given in Table 15.2. Proteins contribute to building and repair of body, participate in muscular contraction, act as antibodies in the body's immunological defense mechanism, and supply energy.

**Table 15.2 Essential amino acids content of some common foods (mg/g)**

Amino Acids	Maize	Rice	Beans	Milk
Arginine	290	640	280	220
Cystine	100	100	60	50
Histidine	160	190	150	170
Isoleucine	289	279	355	407
Leucine	810	513	537	626
Lysine	180	235	464	496
Methionone	120	220	80	160
Phenylalanine	290	350	260	320
Theronine	249	233	271	294
Tryptophan	38	64	58	90
Tyrosine	240	300	210	300
Valine	319	416	319	483
Protein digestibility (%)	80	96	64	100

*Source: Mahindru (1982); Gopalan et al. (1989)*

Whey proteins function as binder and transporter of retinol and significantly enhance retinol uptake. It also is a carrier of antibodies, hence possessing immunological properties. à-lactalbumin is readily digestible and is anticarcinogenic. Antimicrobial components of milk such as immunoglobulins provide passive immunity against enteric and respiratory bacteria and viruses. Colostrum has a very high concentration of immunoglobulins, facilitating quick transfer of immunity to the young born calf.

### 15.5 Minerals

All the known essential minerals other than iron and magnesium are present in milk in varying quantities. Milk is an out standing source of calcium and phosphorus, the two major bone building elements. The absorption of calcium from milk is high and is promoted by the presence of lactose, the amino acids lysine and arginine, citric acid and vitamin A, all of which are present in milk in generous amounts. Fortification of milk with vitamin D is helpful in increasing calcium

absorption. Although the quantity of iron in milk is less, it is present in readily soluble form and is, therefore, completely absorbed from the intestine than is iron from other iron-rich foods. The iodine content of milk is highly variable and its concentration in milk is dependent on the kind of feed. Because of the wide variety of minerals in milk, it can play an important role in making diets satisfactory in mineral content. A comparison of the mineral contents in milk and some common foods is made in Table 15.3.

**Table 15.3 Mineral content of few common foods (mg/100g)**

Food	Calcium	Phosphorus	Iron	Magnesium	Sodium	Potassium	Copper	Zinc
Cabbage	39	29	0.4	31	7	240	0.02	0.3
Cauliflower	22	64	1.1	18	53	138	0.13	0.4
Maize	30	310	3	40	51.7	15.1	nil	nil
Potato	13	50	0.8	30	11	247	0.18	0.53
Rice	6.5	3.9	0.25	101	10.9	154	0.37	nil
Wheat	280	345	3.08	132	20	31.5	0.51	2.2
Milk	125	90	0.1	12	51	160	0.1	3.8

*Source: Gopalan et al. (1989)*

### 15.6 Vitamins

Milk supplies all vitamins essential for human nutrition and health. Vitamin A and its precursors are necessary for good vision, aid in keeping the skin clear and smooth and help keep mucous membranes healthy and resistant to infection. Bovine milk, particularly colostrum, has high level of vitamin A activity as retinol. Milk contains small amount of vitamin E, which functions as an antioxidant preventing the oxidation of carotenoids, vitamin A and PUFA and as an aid in preventing muscular dystrophy. Vitamin D, although is present in low concentration, is useful in the absorption of calcium and phosphorus. Milk also contains vitamin K that is required for synthesis of pro-thrombin and hence is useful in normal blood clotting. Milk is a fair supplier of vitamin B complex. One litre of milk supplies the daily recommended requirement of riboflavin, which aids in oxygen uptake and helps in adapting the eye to light. Milk is a good source of thiamine which is required for normal appetite and digestion. Milk also contains sufficient vitamin B<sub>12</sub> and folic acid, both of which are necessary for synthesis of red blood corpuscles and nucleic acids. A comparison of the vitamin content in milk and some common food materials is listed in Table 15.4.

**Table 15.4 Vitamin content of some common foods items (per 100g)**

Food	Carotene (mcg)	Thiamine (mg)	Riboflavin (mg)	Niacin (mg)	Folic acid (mg)	Vit. C (mg)	Vit. D (IU) (mg)
Egg	600	0.1	0.4	0.1	70.3	nil	18
Maize	32	0.11	0.17	0.6	nil	6	nil
Potato	24	0.1	0.101	1.2	3	17	nil
Rice	Nil	0.21	0.05	3.8	8.9	nil	nil
Wheat	29	0.49	0.17	4.3	35.8	nil	nil
Milk	180	0.05	0.19	0.1	8.5	2	2.4

*Source: Gopalan et al. (1989)*



Lesson 16  
RECEPTION OF MILK

16.1 Introduction

The handling of milk inside the plant is the key element in maintaining its quality. On arrival of milk is graded for acceptance/ ejection, weighed, sampled for testing, cooled and stored under refrigeration until next unit operation for preliminary processing in the dairy plant.

16.2 Milk Reception

Milk may be delivered to the dairy plant in cans or tankers (road or rail). The milk received in these systems has to be sampled, graded, emptied, measured (weight or volume) and bulked to provide continuous supply of milk to the pasteurizer.

In the absence of mechanical aids, the cans are off-loaded manually to the tipping point, where the lids/covers are removed and the milk inspected. They are then tipped manually and both cans and lids pass on to a can-washer via a 'Drip saver' or 'Drain rack'. Where a higher throughput is required, the procedure is mechanized and the cans are unloaded directly from the truck onto the conveyor (power-driven or by gravity roller) and the tipping, sampling and weight recording may be completely automatic.

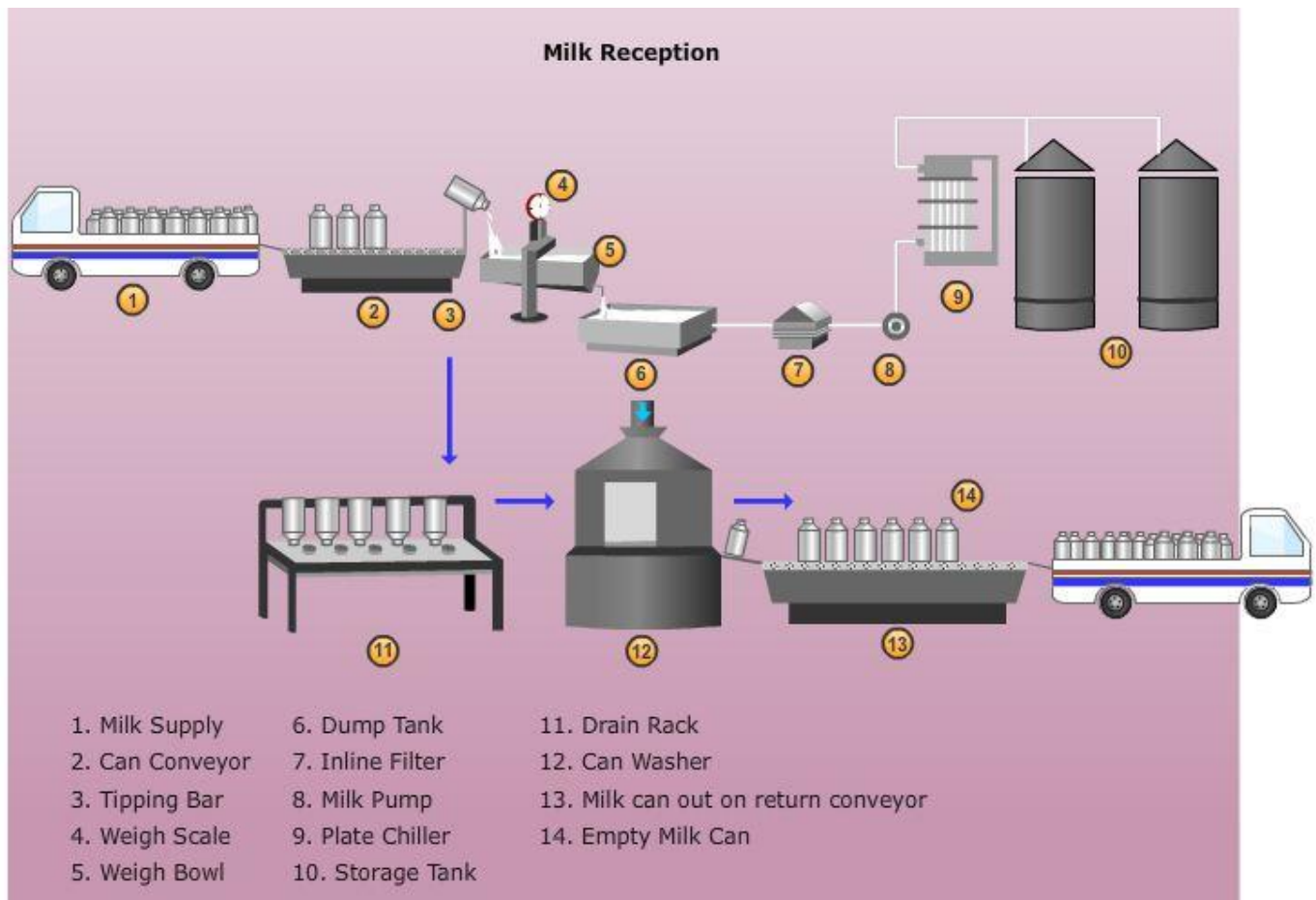

The milk is tipped into the weigh tank/pan. Such weigh tank is suspended from a weighing machine, the dial displaying the weight. Two weigh tanks may be used for quick reception. The discharge valve has a large diameter to permit rapid emptying. The milk is discharged into a 'Dump tank' placed immediately below the weigh pan. From here milk may be pumped continuously to a raw milk storage tank, normally situated at a height to enable gravity flow to the pasteurizing plant.

The reception of milk from large rail or road tankers is primarily a matter of providing a covered area under which emptying and subsequent cleaning can take place. The tanker outlet must be connected to sanitary piping. The milk may be removed by a milk pump, placed at a level lower than the tanker, or a compressed air line may be connected to the top of the tanker and the milk forced out by pneumatic pressure. Cleaning and sanitization of the tanker should follow immediately after emptying is complete. The measurement of milk delivered by tankers is carried out using a weigh bridge or flow-meter.

If milk is received from chilling centers, it has already been graded, weighed, sampled and cooled. It may be weighed and sampled again, or the center's report may be used. The latter procedure applies especially to tanker deliveries.

Milk reception should be done in a planned manner to avoid delay in processing. If the milk is received continuously during the scheduled period, operations in the plant will not be interrupted and employees in the various sections will be fully occupied. The aim should be to complete milk reception within 3-4 hours, especially in tropical countries. Delay in processing may lead to deterioration of milk awaiting dumping, increase labor costs and may increase the operating cost of the can-washer.

Market milk requires milk of a prime quality (from the standpoint of aesthetic quality, health, flavor, sanitation, keeping quality). The quality of the incoming milk greatly influences the quality of the processed milks (or manufactured products).

It is well known that the sanitary quality of milk on the RMRD depends on its background on the farm, viz. healthy cows, clean milk production, clean utensils, prompt cooling and refrigerated transport. However, there is a need for systematic and thorough inspection of all milk supplies every day by conscientious and experienced milk graders.

When milk is received at the dairy plant, it should be at 5°C or below. The milk should be clean, sweet, possessing pleasant flavor, free from off-flavors and reasonably free from extraneous material viz., antibiotics, pesticides and other chemicals or metals. Abnormal milk should not be accepted. Acid development is objectionable even from standpoint of heat stability.

### **16.3 Milk Reception Operations**

The operation of receiving milk may be subdivided into Unloading, Weighing, Sampling, Grading and Testing.

#### **16.3.1 Unloading**

The truck carrying the filled cans is brought alongside the unloading platform. The milk cans are then unloaded manually. The milk cans are then assembled for grading in a definite order, according to each supplier, viz. the contractor or patron. If a milk tanker is used, it is first properly positioned so that pipe fitting connections can be made conveniently in the Tanker bay.

## 16.3.2 Grading

It is well known that the quality of the finished product depends on that of the raw material used. This refers to the classification of milk on the basis of its quality, for price-fixation. The milk grader is the key man for the proper selection of milk. The principle of grading is based on organoleptic (sensory) tests such as those for appearance, smell (odor), and taste, acidity sediment etc. are included under platform tests.

Note - The term 'Platform Tests' includes all tests which are performed to check the quality of the incoming milk, to decide regarding its acceptance/rejection. They are performed on each can/tanker of milk with the objective of detecting milk of inferior or doubtful quality, preventing it from being mixed with high grade milk.

The technique of grading milk is as follows:

### 16.3.2.1 Milk tanker (road/rail)

The grading has already been done at the milk collection-cum-chilling centre. As milk is chilled (< 5°C), it is not possible to detect off-odors. The appearance is noted, as testing of raw milk is usually avoided. After thoroughly mixing it for 5-10 min, a sample is taken for laboratory testing.

### 16.3.2.2 Milk can

The main tests applied to each can of milk consist of appearance, smell and temperature (touch); other tests such as taste (seldom carried out with raw milk) and sediment might be used to substantiate the initial findings. Tests involving time, laboratory facilities and special techniques are done by the quality control technician, for which a sufficiently large sample is taken.

## 16.3.3 Platform tests

### 16.3.3.1 Appearance

Observing each can of milk for any floating extraneous matter, off color, or partially churned milk. The milk should be normal in color, free from churned fat globules and reasonably free from any floating extraneous material.

### 16.3.3.2 Smell (Odour)

This furnishes an excellent indication of the organoleptic quality of milk that can be ascertained quickly (in seconds). In making the test, the cover of each can is removed, inverted and raised to the nose. The headspace in milk can is smelled. By replacing the lid and shaking the can vigorously, the test may be repeated. An experienced milk grader with a 'trained nose' decides the acceptance/rejection of the milk. The milk should be free from any off flavors.

### 16.3.3.3 Temperature

The temperature at which milk is delivered is often an indication of its quality. A daily check on the temperature of milk is helpful in keeping check on the quality of milk. With practice, the grader can tell with a high degree of accuracy whether the milk is sufficiently cold by touching the side of the can. A temperature of 5°C or below is satisfactory.

### 16.3.3.4 Sediment

The sediment test shows the visible foreign matter contained in the milk. It need not be made daily, but should be carried out often. For this purpose a reliable sediment tester (such as an off-the-bottom sediment tester) is used. Any method by which maximum sediment is obtained should be considered satisfactory. A low sediment is desirable. Sediment test is performed to judge the

cleanliness of milk. There is no correlation between the amount of sediment and the bacteriological quality of milk. Measured quantity of milk is filtered or centrifuged and checked for sediment. A good quality milk gives no visible dirt whereas poor quality milk shows dark or blackish deposits on the filter pad. The milk is graded for its quality on the basis of BIS standards.

**Table 16.1 BIS standards for sediment test**

Sediment (mg)	Grade
0.0	Excellent
0.2	Good
0.5	Fair
1.0	Poor
2.0	Very Poor

### 16.3.3.5 Acidity

'Natural' or 'apparent' acidity of milk is desirable which does not adversely affects its heat stability. However, 'developed acidity' (Natural + Developed = Titratable acidity) adversely affects the quality of milk which cannot be processed in pasteurizer.

### 16.3.3.6 Lactometer reading

The addition of water to milk results in lowering its density. Hence, this test is applied for detection of adulteration of milk with water. The reading for cow and buffalo milk should be about 28 to 30 and 30 to 32 respectively, when measured at 15.5°C.

## 16.4 Sampling

The importance of securing an accurate and representative sample of milk for chemical and bacteriological analysis cannot be over-emphasized. While strict precautions regarding sterility of the stirrer, sampler, container etc. are required for obtaining a bacteriological sample, dryness and cleanliness of the above equipment should be sufficient for a chemical sample. The first pre-requisite of sampling is thorough mixing of milk. This can be done with a plunger or stirrer (agitator), operated manually or mechanically for milk contained in cans or tankers, as the case maybe. With the former, a representative sample may be taken after dumping the milk in the weigh tank, whereby it gets mixed in so thoroughly that a representative sample may be taken without further mixing.

Samples may be: individual, composite (mixture of two or more individual lots of milk), drip (representing the entire day's supply), etc. Samplers may be dipper-tube or proportionate (also known as milk thief), automatic vacuum, drip etc.

**Table 16.2 Characteristics of milk samplers**

Type	Principle	Advantage	Disadvantage	Remarks
Dipper	Secure 10-15 ml milk.	(i) Fairly fast and easy to work with. (ii) Quite accurate when milk is mixed adequately before sampling.	Inaccurate when wide variations exist in milk lots, both in quality and quantity.	Most commonly used. Most useful for cream.
Proportionate	Secures aliquot portion of milk.	Most accurate	(i) Cumbersome to use. (ii) Larger sample bottle needed.	Not so commonly used (not so useful for cream).
Automatic Vacuum	Secure aliquot portion by vacuum automatically	(i) Very fast in operation. (ii) Very accurate.	Expensive.	Increasingly used in large market milk plants and product factories.
Drip	Milk collects in drops in the sample bottle (which is kept under refrigeration)	Helpful in fat and SNF accounting of the total intake.	Not useful for individual sampling.	Useful in large product factories.

The composite milk sample must not spoil by the time it is analyzed. This is accomplished by use of a preservative. It is wise to place the preservative in an empty bottle before milk is added. A wide mouthed glass bottle with a rubber stopper is suitable for keeping composite samples of milk or cream. The common preservatives used are as follows:

**16.4.1 Mercuric chloride or corrosive sublimate**

This is very poisonous. It may be added in the form of tablets, which are colored (usually bright red) to avoid the milk to be mistaken for food for consumption.

**16.4.2 Formalin**

This is a 40% solution of formaldehyde. Being liquid it is very convenient to handle. However, it interferes with the fat test.

**16.4.3 Potassium dichromate**

This is not as effective as the above two, but is easy to handle in dairy plants because it is available in tablet form.

Note - The composite samples should be stored in a cool place away from direct sunlight. Each bottle should be properly labeled.

### 16.5 Weighing

This is an essential step in accounting for milk receipts, disposal and making payments for milk. The milk from cans is dumped into the weigh tank, either manually or mechanically. The tank is mounted on scales and the scale dial set at zero when the tank is empty. Automatic printing of the weight is now becoming a practice.

The milk in tankers (road or rail) may be measured by volume by passing it through a flow meter, and its measurement converted into weight by multiplying volume with density ( $m = d \times v$ ). In case of road milk tankers weigh-bridge can be used to determine its weight (weight of tanker when full - weight when empty). The characteristics of measuring by weight and by volume have been shown in table below:

**Table 16.3 Measurement of milk by weight vs. volume**

Method	Characteristics
By Weight	<ol style="list-style-type: none"><li>1. Gives accurate reading, regardless of foam or temperature.</li><li>2. Involves considerable initial expense for both apparatus and its installation.</li><li>3. Involves problems with maintenance.</li></ol>
By Volume	<ol style="list-style-type: none"><li>1. Not so accurate, as affected foam and temperature, both influencing density.</li><li>2. Lower initial expense.</li><li>3. Poses maintenance problems</li><li>4. Sanitation needs to be exercised</li></ol>

### 16.6 Testing

Further testing is needed in case of 'doubtful quality' prior to its acceptance for processing. The Quality control laboratory of the dairy plant performs the requisite analyses. A record of the chemical and bacteriological quality of all accepted milk has to be maintained for making payments and for ISO records. (For testing methods, refer Bureau of Indian standards: BIS: 1479, (Part-I), 1960, (Part-II), 1961, (Part-III), 1962). The common quality control tests have been given in table below:

Table 16.4 Quality control tests for milk and their significance

S.No	Name of Test	Purpose	Remark
1.	Acidity	To determine final acceptance/rejection of milk taking COB into consideration	Applied as such or in a modified form, as a platform test.
2.	Ethanol (Alcohol)	To determine the heat-stability of milk.	Applied as a platform test.
3.	Alcohol-Alizarin	To have an idea of heat-stability and pH of milk.	Applied as a platform test.
4.	COB (Clot-on-boiling)	To determine heat stability of milk.	Applied as a platform test.
5.	Dye -reduction test (MBR or Resazurin)	To determine the extent of bacterial contamination and growth in milk	Resazurin applied as a platform test.
6.	DMC; Direct Microscopic Count	To identify the types of micro-organisms present in milk.	Applied as a laboratory test.
7.	SPC (Standard Plate Count)	To determine the extent of bacterial contamination in milk	Applied as a laboratory test.
8.	Lactometer	To detect a dilution of milk with water.	Applied as a platform test.
9.	Freezing Point	To detect a dilution of milk with water.	Applied as a laboratory test.
10.	Fat and SNF	To make payment for milk received.	Applied as a laboratory test.

\*\*\*\*\* 😊 \*\*\*\*\*

**Lesson 17**  
**CHILLING AND STORAGE OF MILK**

**17.1 Introduction**

The first operation in a dairy plant is reception, chilling and storage of milk. Raw milk is pumped from the dump tank to the storage tank through a filter and chiller. The purpose of storage tank is to hold milk at low temperature so as to maintain continuity in milk processing operations and prevent any deterioration in quality during holding and processing period.

The milk may arrive at a chilling centre or dairy plant in cans. After unloading the cans, milk is chilled and stored in storage tanks. Storage tanks are used to store raw or even pasteurized milk. Milk may be held in chilled condition ( $< 5^{\circ}\text{C}$ ) in the tank for up to 72 hours between reception and processing. Normally the milk storage capacity should be equivalent to one day's intake.

**17.2 Objectives of Storage Tanks**

- To maintain milk at a low temperature so as to prevent any deterioration in quality prior to processing/product manufacture.
- To facilitate bulking of raw milk supply, which will ensure uniform composition
- To allow for uninterrupted operation during processing and packaging
- To facilitate standardization of the milk

**17.3 Storage Tank**

Storage tanks enable milk to be stored for longer period of holding. They must be designed for easy cleaning and sanitization, preferably through CIP process. Storage tanks consist of a stainless steel inner shell, a layer of insulation, an outer jacket and necessary fittings for inspection control and cleaning. The tanks should be insulated or refrigerated so that they can maintain the required temperature throughout the holding period. Glass wool, Thermocol, Corkboard, Foam glass or Styrofoam can be used for insulation. Corkboard or foam glass is used in the lower portions of the tank where the insulations may carry a part of the load. Agitation must be adequate for homogeneous mixing, but gentle enough to prevent churning and incorporation of air. In many storage tanks, chilled water circulation system is provided to maintain the temperature of milk. All closed type of tanks must be equipped with a manhole round (diameter  $\sim 450$  mm) or oval shaped to permit access to the interior for cleaning and inspection.

For foam-free entry of milk, a curved filling pipe, which guides the milk towards the wall is used. It is better to fill the tank from below, i.e., by the lowest outlet pipe. The storage tanks containing raw chilled milk or standardized pasteurized milk are usually located on the first floor. This allows feeding to the milk pasteurizers or even gravity filling of milk. Now-a-days, big sized silos, usually of  $> 1.0$  lakh litres capacity are installed in the dairies on the ground floor only. They are very useful in storing skim milk for feeding to the powder plants. In the dairy industry, rectangular tanks are less preferred as compared to cylindrical tanks, because cleaning of sharp corners (in rectangular ones) is difficult. Secondly, the agitation effect does not reach the extreme corners of rectangular tanks.



### 17.4 Types of Storage Tank

Storage tanks can be classified on the basis of their shape and other features.

#### 17.4.1 Insulated storage tanks

These tanks merely stores the milk at a temperature at which it is filled. In most cases, depending upon the quality of insulating material, there is tendency of rise in the temperature of milk with long storage. These tanks are made up of a stainless steel inner shell, a layer of insulation (thermocool and glass wool) and an outer jacket of stainless steel or mild steel ( Fig.17.1, 17.2)

#### 17.4.2 Refrigerated tanks

It has built-in refrigerating facilities so that stored milk is chilled as and when required. This additional feature of maintaining the desired temperature is an added advantage in these tanks. In refrigerated tanks, the hollow space between the inner and outer shells is used for circulating the cooling medium (chilled water or brine solution).

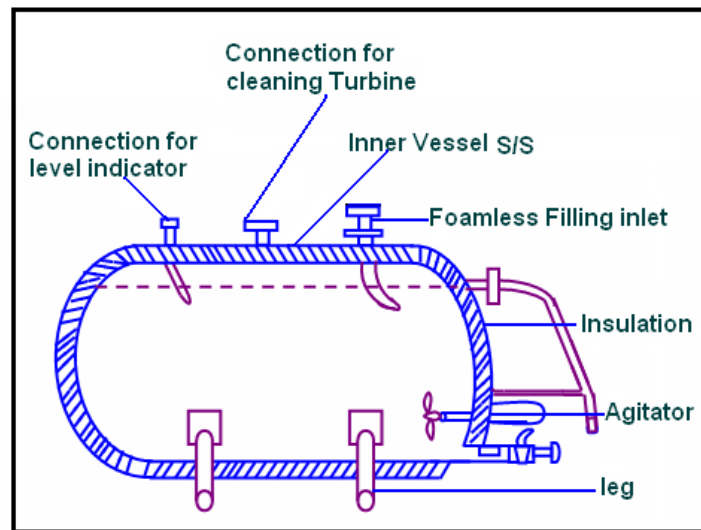

Fig. 17.1 Horizontal milk storage tank

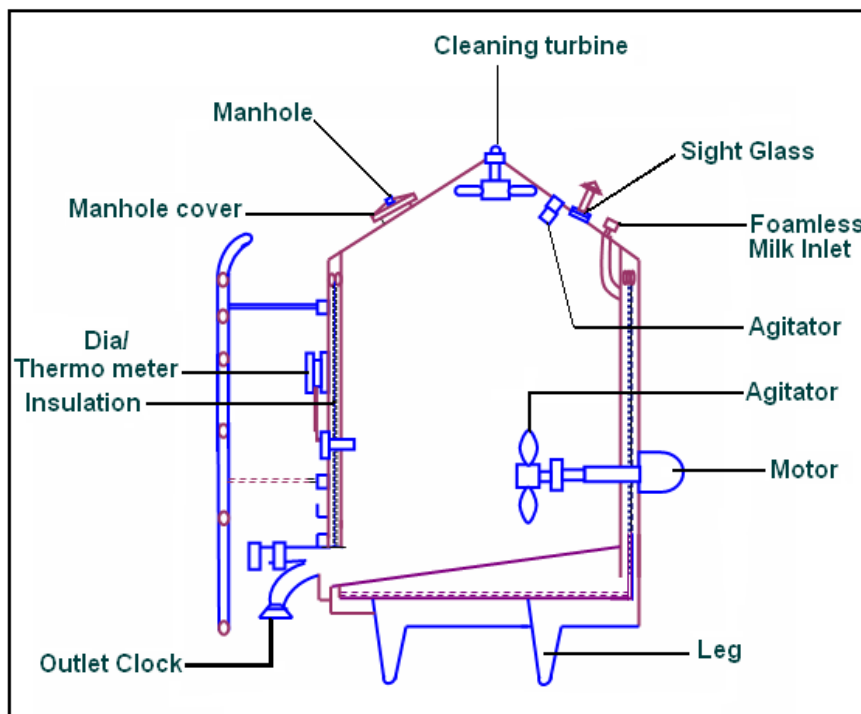

Fig. 17.2 Vertical milk storage tank

### 17.4.3 Horizontal or vertical tanks

Horizontal tanks require more floor space than vertical ones, but need less headspace. For handling small volumes, horizontal tanks (5,000 to 15,000 litre capacity) may be used. Now-a-days, milk is stored in vertical storage tanks of one lakh litre capacity or more, commonly known as silos. These are vertical cylindrical tanks, installed outside the building. In these silos, milk feeding is from same discharge valve installed near the bottom (Fig 17.3).

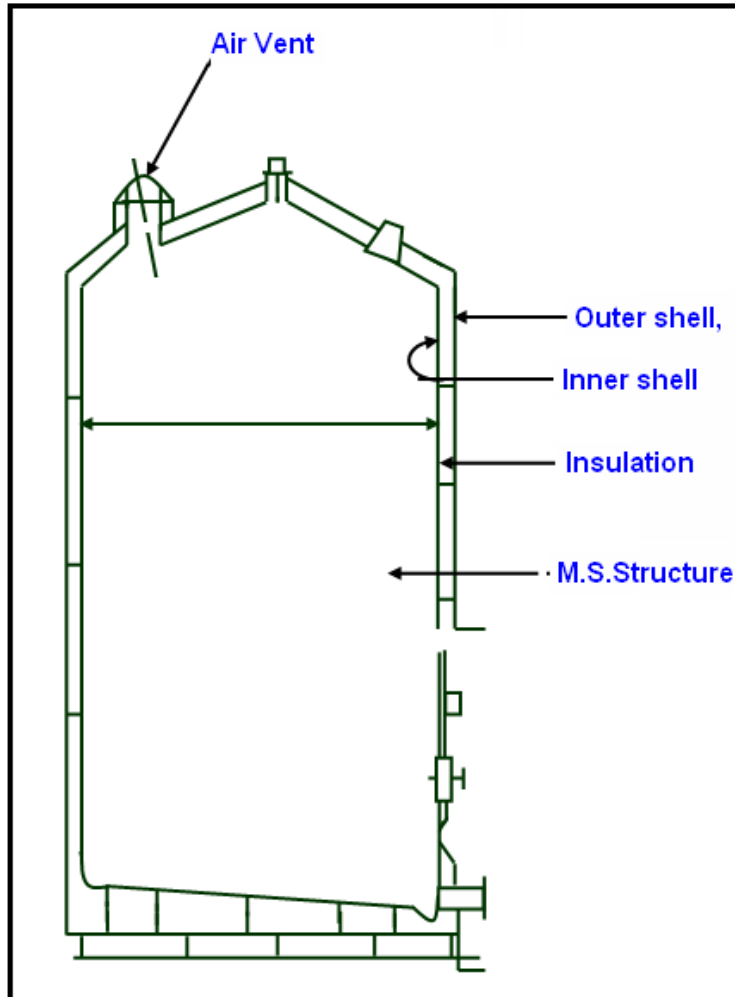

Fig. 17.3 Sectional elevation of insulated milk silo

## 17.5 Chilling Equipments

### 17.5.1 Surface cooler

It can be either an individual unit or cabinet type. The latter consists of two or more individual units, compactly assembled and enclosed in a cabinet. It is usually larger than those used on the farm/chilling centre.

### 17.5.2 Plate chiller

It is widely used for large scale cooling of milk of 5000 to 60,000 lit./ day at the chilling centers. They are efficient, compact and easily cleanable. In chiller the gasket plates are tightly held between the plates. These plates are so arranged that milk flows on one side of plate and cooling medium (usually chilled water) on the other. There is a counter current flow between the milk and the chilled water through alternate plates. It helps in efficient transfer of heat to the cooling medium resulting in quick chilling of milk. The chilled milk flows from the plate cooler to the insulated storage tank at 4°C. A mechanical refrigeration system (IBT) is needed.

## 17.5.3 Internal tubular cooler

It is a continuous cooling system consisting of a stainless steel tube about 2.5 – 5.0 cm in diameter surrounded by a similar tube, forming a concentric cylinder. Several such tubes may then be connected in series to obtain sufficient cooling. The cooling medium flows counter current to the milk flow.

## 17.5.4 Vat/tank cooling

It is suitable for batch cooling, especially of small quantity. It consists of a tank within the tank, with the space between the two being used for circulation of the cooling medium, by either pump or main pressure. An agitator is provided to agitate the milk for rapid cooling.

\*\*\*\*\* 😊 \*\*\*\*\*

## Lesson 18 FILTRATION AND CLARIFICATION

### 18.1 Introduction

During handling of milk on farm and its transportation, certain visible particles and dirt may gain access into the milk which may be removed by either filtration or centrifugal clarification.

Filtration/clarification equipment has been designed for both cold and warm milk. Since fluidity of warm milk is more, its separation process is more efficient. However, warming of milk for this purpose requires additional equipment. It also poses the risk of bacterial growth unless handled properly. Handling at higher temperatures may also affect creaming property of the milk besides dissolving some of the extraneous matter.

### 18.2 Pre-heating

This term refers to heating of milk before the operation which follows immediately. The milk is pre-heated to about 35-40°C using plate or tubular heater for efficient filtration/clarification. Pre-heating becomes essential, if the incoming milk is cold. As the temperature of the milk increases, the viscosity of milk decreases resulting in more efficient filtration/clarification.

### 18.3 Straining

The practice of straining milk was introduced to remove some of the large particles of foreign material such as straw, hair, insects, grass, dirt, flies, etc., so that the visible sediment in milk might be reduced. The straining in the ordinary sense is accomplished on the dairy farm by means of pieces of cloth, cotton, wire gauge or specially prepared strainers/strainer pads.

### 18.4 Filtration

Filtration of milk is carried out to remove visible sediment (foreign matter) from the milk to improve the aesthetic quality of milk. This may be removed either by filtration or centrifugal clarification. While filtration removes suspended foreign particles by straining process, clarification removes the same by centrifugal force. There are two types of filters or clarifiers viz., those that operate with cold milk and those that operate with warm milk. The advantages of filtration are that preheating is not essential and there is less likelihood of soluble dirt going into the solution. However, the major disadvantage is the flow of milk is slow. Broadly there are two types of filters.

#### 18.4.1 Tubular sieve

It removes dirt by sieving and is placed in the inlet pipe in the processing section. This permits the removal of coarser particles only.

#### 18.4.2 Important features of a filter

- A filter cloth or pad of the desired pore size is used that can retain the smallest particle.
- A frame or support to compress and hold the margins of cloth or pad, so that milk can pass through pores
- A perforated metal or other support for the cloth or pad which will not tear or break under the pressure of milk

- An enclosure to confine both the filtered and unfiltered milk in closed system fitted suitably with inlet and outlet connections for sanitary piping
- A continuous operation is essential to handle large volumes of milk; 2 or more filters may be used without interruption.

For cold filtration, an in-line filter may be installed in the milk receiving line between the raw milk dump tank, unloading pump and chiller or raw milk storage tank. Warm milk filters may be installed in the pasteurization circuit.

In order to achieve the desired filtration effect, the filter material must have pores of 25 - 100  $\mu$ . The smaller the pores, the greater are the separation effect and filtration time. For a filtration installation with a flow of 10,000 L/h, we can assume 1 - 2 h time with pores size of 45  $\mu$  and pores size of 100  $\mu$  up to 10 h. Changing of filter after every 6 h of operation is recommended.

The filter consists of stainless steel body wherein a filter with a small pore nylon cloth is placed and closed with a tight fitting lid (Fig18.1). Milk passes from the top to bottom. After 3 - 4 h of operation, the filter bag must be cleaned. For a continuous process, a double filter must be installed. This would enable cleaning of one filter while the other is being used. The flow of milk when using such type of filter can be up to 15000 L/h.

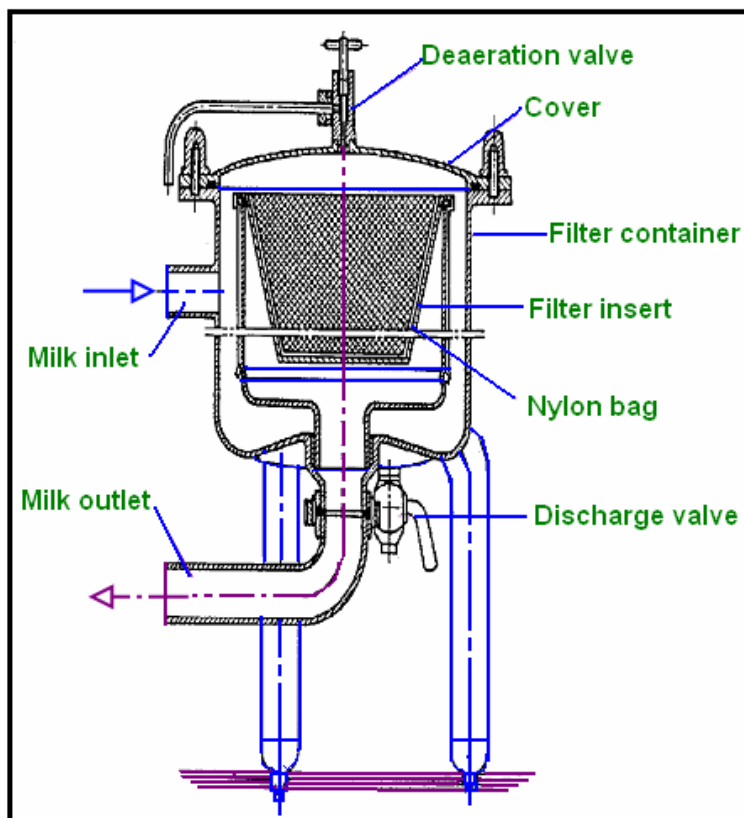

Fig. 18.1 Milk filter

## 18.5 Clarification

Clarification is more efficient than filtration for the removal of dirt and foreign matter from milk. Clarification removes leucocytes, udder tissues, other large cells and fine dirt. The objective of clarification is to improve the appearance and marketability of milk.

## 18.5.1 Milk clarifier

In general, the clarifiers are quite similar to cream separator. The difference between clarifier and cream separator are as follows:

- In clarifiers there is only one inlet and one outlet. In cream separator there is one inlet and two outlets (cream and skim milk).
- The discs in the clarifier are smaller in diameter to provide a large space for the accumulation of sludge than separators.
- The milk distribution holes are at the outer edge of the disk in the clarifier but near the axis of rotation in the separators.

## 18.5.2 Clarification process

In a clarifier, the ratio of bowl diameter to disc diameter is greater than in cream separator, resulting in a larger sludge space. In most clarifiers, 10 - 20 discs have no holes and on their surface are 6 - 12 baffles with a thickness of 1-3 mm which are evenly spaced. These baffles determine the disc distance and influence the flow pattern. Raw milk is pumped through central pipe through the rotating bowl via a distributor and passed through the small opening into the sludge area. The dirt separation takes place in the disc assembly where milk is enclosed by two adjacent baffles between discs. One baffle leads to rotation whereas the other baffle leads to the flow to the center. The dirt particles which have a higher specific gravity are separated by the centrifugal force. The clarified milk rises to the outer surface of the distributor and reaches the baffle and ejects out. The pressure is about 5.4 bars. The amount of sludge is influenced by:

- The amount of foreign matter
- Condition of the udder
- Stage of lactation
- The bacterial count and acidity of the milk
- The clarifying temperature
- The speed of the bowl
- Amount of milk run through the bowl

A clarifier may be operated depending on the size of the machine, for a period ranging from 2 - 8 h for cold milk (5 - 10°C) and 1-4 h for warm milk (57°C), without cleaning.

## 18.5.3 Location of clarifier

Clarifiers can be located in any one of the following ways:

### 18.5.3.1. Cold clarification

- Between the storage tank and the pasteurizer
- Between the receiving room and the storage tank. This arrangement is applicable only in those plants where a steady receiving operation is maintained.

### 18.5.3.2. Warm clarification

- Between the pre-heater and the pasteurizer.
- Between the regeneration section of high temperature short time (HTST) pasteurizer and heating section.
- Between the final heater and the holding tube of the HTST pasteurizer.

18.5.3.3. *Difference between cold and warm milk clarification*

a) Cold milk clarification

- Efficiency is lower since viscosity of milk is high.
- Operation time is more because less free casein particles are thrown out as slime.
- Quality of the processed milk is better as dirt is removed from the milk.

b) Warm milk clarification

- Efficiency is higher due to lower viscosity of milk.
- Running time is reduced because of rapid free slime build-up
- Operation of the entire system is more critical with a high pressure drop through the clarifier on one side of the pump and suction on the other side.

18.5.4 **Factors affecting clarification**

18.5.4.1 *Viscosity*

The viscosity of milk is an important factor to be considered in clarification, since the suspended foreign particles are removed by centrifugal sedimentation. Settling of particles by centrifuging depends upon their size, density and viscosity of the fluid in which they are suspended.

18.5.4.2 *Temperature*

In general, the viscosity of liquid decreases as the temperature increases. Hence, milk is usually heated to a temperature of 32-35°C before it is subjected to clarification. A high temperature must be avoided as it adversely affects the creaming property of milk.

18.5.4.3 *Bowl speed*

The higher the speed, the better is the efficiency as the centrifugal force is directly influenced by the speed of the bowl.

18.5.4.4 *Microbial load*

The type and state of microbe influences the efficiency of clarification. The bacterial spores being denser are thrown into the slime more easily.

18.5.5 **Effect of clarification on the bacterial quality**

Since a large number of microbes are thrown into the clarifier 'slime', there will be fewer microbes in clarified milk. Due to the breaking up of the clumps of bacteria during the process, there may be an apparent increase in the plate count of clarified milk. Hence, it apparently seems that the plate count of milk is higher after clarification, while the actual number of organisms in the clarified milk is considerably lower.

**Table 18.1 Composition of clarifier slime**

Water	67.3 %
Fat	1.1%
Protein	25.9%
Ash	3.6%
Lactose	2.1%

Separator slime is usually considered to be identical with clarifier slime. The removal of slime does not affect the composition of milk, since the loss of solids resulting from clarification is usually  $\leq 0.01\%$ . Neither filtration nor clarification improves the keeping quality of milk.

For Agriculture related Books, News,  
Recruitment, Information and Events etc Visit  
at  
[www.AgrMoon.Com](http://www.AgrMoon.Com)



Lesson 19

SEPARATION OF MILK - THEORY AND METHODS

19.1 Introduction

Cream is a fatty product of milk, and creams of different fat contents can be prepared by the separation of milk fat from non fat solids portion of milk. Market creams for retail sale are made to different fat contents according to intended use. Cream is a richly flavored product, which makes it desirable for use in applications such as desserts, cakes and some chocolate confectionery. It is also used in some beverages like coffee and cream liqueurs.

In dairy industry, the process of separating milk into cream and skim milk is known as separation. Cream comprises of fat concentrate in milk. Milk fat can be removed in the form of cream and the remaining portion is serum referred to as skim milk. The skim milk contains predominantly SNF and is having very little fat.

19.2 Principles of Cream Separation

Separation of cream can be done either by gravity (*malai*) or by applying the centrifugal force. Separation of milk is possible because of difference in density between the fat (0.93) and the skim milk (1.036). When the milk fat in the form of globules rises to the surface of the milk, the globules maintain their identity at the temperature below their melting point, thereby forming fat concentrate referred to as 'Malai'.

19.2.1 Separation of cream by gravity

Separation is brought about by the force of gravity and the rate of separation is determined by Stoke's law.

A solid particle or liquid droplet moving through a viscous fluid medium under the influence of gravity will eventually attain a constant velocity. This is called sedimentation velocity and is denoted as  $V_g$  ( $g$  = force of gravity). The value of sedimentation velocity is calculated by the equation

$$V_g = d^2(P_p - P_l) \frac{g}{18\eta}$$

Where:

$d$  = particle diameter

$P_p$  = particle density

$P_l$  = density of liquid

$\eta$  = viscosity of fluid

$g$  = gravitational force

19.2.2 Separation of cream by centrifugal force

When a mass is made to revolve in a circular path around its axis, a kind of force is generated, which is called centrifugal force. This force throws the heavier portion away from the centre. Simultaneously, there is another force called centripetal force, which acts on the lighter portion and attracts it towards the centre. Separation is completed by leading these two portions from the bowl through different outlets. The centrifugal acceleration created in the centrifuge is specified as  $r\omega^2$ ,

where,  $r$  = radius and  $\omega$  = angular velocity

Substituting the value of centrifugal acceleration, we derive the sedimentation velocity (V) of every particle in centrifuge

$$V = r^2(ds - df) \frac{K.R.N^2}{\eta}$$

Where:

V = velocity of movement of a single fat globule

r = radius of fat globule

ds = density of skim milk

df = density of fat

N = speed of bowl (r.p.m)

R = distance of fat globule from the axis of rotation

K = constant

n = viscosity of skim milk

### 19.3 Method of Separation

Separation of milk can be carried out by the following methods

- By gravity
- By centrifugal force

#### 19.3.1 Separation by gravity

Earlier, this technique was used in dairies to separate fat from milk. Milk was left in a vessel where, after some time (hours), the fat globules aggregate and float on the surface forming a layer called '*malai*' on top of the milk. There are two types of gravity separation as discussed below:

##### a) *Shallow pan method*

The milk is poured into the pans, immediately after milking. The pans, which are four inches deep, are placed preferably in a cool place. Skimming is done at the end of 24 h, and by this time, the milk below the cream is coagulated. Skim milk from the shallow pan system contains 0.5-1.5% fat.

##### (b) *Deep setting method*

In this method, milk is set in 20 inches deep cans which are 8"-15" in diameter, maintained at 8-10°C. Glass strips are inserted in the wall of the can, one near the bottom and other near the top, to absorb cream. Due to low temperature better quality product results. After 12-14 h of storage, the fat layer from the top is skimmed off leaving skim milk in the container.

### 19.4 Advantages of Centrifugal Separation over Gravity Separation

- Speed of separation is greater (instantaneous) for centrifugal separation.
- Bacteriological quality of cream and skim milk is superior in centrifugal separation than gravity separation.
- Greater fat percentage of cream is possible using centrifugal separation (25-80%) vs. gravity separation (10-25%).
- Fat recovery in cream is 99-99.5% for centrifugal separation. Such value for gravity separation is about 75% or so.

\*\*\*\*\* 😊 \*\*\*\*\*

Lesson 20

SEPARATION OF MILK - CREAM SEPARATORS

20.1 Introduction

Centrifugal separation is a type of sedimentation process, applied for solid-concentration, clarification and liquid-liquid separation with simultaneous separations of solids. There are around 450 designs of centrifuges made of 1200 varieties of materials. The bowls are available with discs from 10 to 250 in numbers. The disc spaces vary from 0.3 to 1 mm. Similarly, density difference which could be operated upon varies from 20 to 400 kg/m<sup>3</sup>. Concentration and washing of finely dispersed solids is often carried out for the processing of relatively high concentrated suspensions (about 25% by vol). Centrifuges have now capacities as high as 45,000 L/h. The concentration of suspension in the exit stream is as low as 0.04% by volume.

Centrifugal cream separators are similar to centrifugal clarifiers in that they consist of a stack of conical discs housed in a separator bowl and rotated at high speed by an electric motor driving either through friction coupling or a direct drive coupling. The distribution holes in each disc are vertically aligned and milk is fed to the base of the disc stack to pass up through the holes.

20.2 Separation by Centrifugal Force

Centrifugal separation is the most commonly used method in modern dairies. In this method, milk is fed into the rapidly spinning bowl, at the centre of the discs. Milk distributes itself in the space between the parallel discs rotating at high speed creating centrifugal force. The heavier of the two products, namely, the skim milk is thrown to the periphery of bowl, whereas the lighter one, i.e., fat gathers in the central portion. The incoming milk forces the separating layers from the bottom and out at the top of the bowl. Two passages are provided at the top of the bowl for skim milk and cream to pass out of the bowl (Fig.20.1).

Regulating the cream discharge opening (affecting the flow) by adjusting the cream screw, we can maintain the desired fat % in cream. The ideal temperature for separation is 35°- 45°C. Some amount of dirt present in the milk may also be separated during the process and get deposited in the space between the outer edge of the discs and the inner surface of the bowl shell. This slime is removed when the unit is shut down for cleaning, after milk is separated. This limited running time of separators leads to the development of a mechanism for automatically removing the solid material (dirt and cellular material, bacteria) without having to interrupt the operation of the machine. Such separators are called 'Self-desludging' or "self-cleaning" separators. Cold separation results in more fat loss than in warm milk separator.

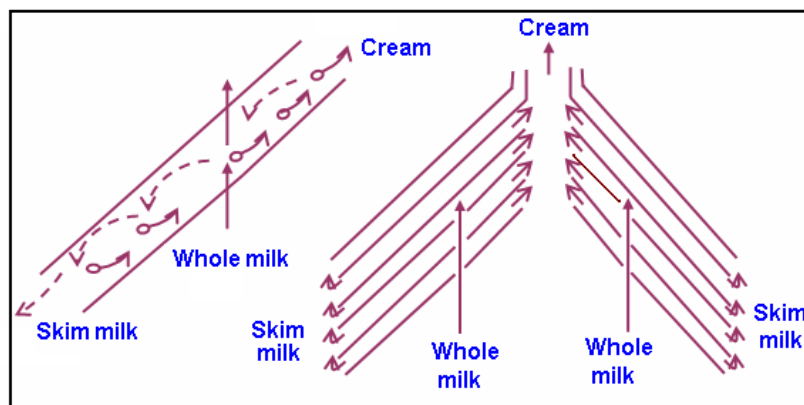

Fig. 20.1 Flow of cream and Skim milk in the space between discs in a centrifugal separator

## 20.3 Important Components of a Separator

### 20.3.1 Bowl and disc assembly

The bowl is the key component. It consists of an outer shell within which a large number of cone-shaped discs are housed. The construction is such that a very small space ( $< 0.5$  mm) is provided between each pair of discs (Fig. 20.2).

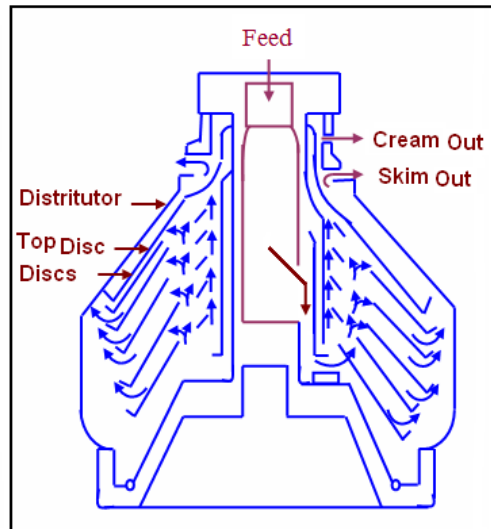

Fig. 20.2 Cross Section of Centrifugal Separator

It is very important that the bowl is accurately balanced and suspended over the spindle to ensure freedom from vibration. Milk is introduced to vertical aligned distribution holes in discs at a certain distance from edge of discs from start. Under influence of centrifugal force, the particles and droplets of milk will begin to settle either outward or inward in separation channels radially according to their densities related to continuous medium. There are up to 120 discs arranged one over other, angle of inclination being  $45-60^\circ$  to the horizontal. Outward diameters are 200-300 mm. Disc are generally made up of stainless steel and wall thickness will be 0.4 mm. The number of discs in a cream separator relates to its capacity. The space between discs allows the milk to flow through narrow gaps in laminar flow thereby ensuring the separation. Larger gaps between discs are necessary if there is a danger of clogging. Bowl discs used revolve at rpm of 5500-6000 and separate milk at mass flow rate of 20,000 liters per hour. The space between the discs must be increased if the cream of high fat content is to be obtained. In a normal cream separator, we can expect clogging if fat in cream is above 55-60%. The required high fat content can be obtained only after subjecting the cream again for fat separation.

### 20.3.2 Product inlet arrangement

Fully enclosed power driven units use a constant pressure pump with float balance arrangement at the pump suction, to maintain constant head. Milk enters the separator through a pipeline at the bottom of the machine and travels upwards through the hollow space in the spindle. Since the operation takes place in a sealed compartment, there is no possibility of foaming.

### 20.3.3 Product outlet arrangement

Separate outlets for skim milk and cream are provided on top of the bowl. The cream outlet is near to the centre of the rotating spindle and the serum outlet is at a lower position than cream outlet.

## 20.3.4 Cream regulating screw

For small capacity units, a screw arrangement is provided on the cream line, within the top disc. By manipulation of this screw, the passage of the cream could be varied to raise or decrease the fat content of cream. In the case of large capacity units, a regulating/back pressure valve is provided on the cream outlet line.

The cream screw can also be used for standardization of the fat content of the milk to any desired level below that of the fat content of the feed.

## 20.3.5 Driving motor

For rotating the bowl at the desired high speed, a gear arrangement is provided to increase the speed of bowl as compared to the speed of driving motor (about 1440 rpm). To lubricate the gears, a closed lubrication system is incorporated within the gear assembly.

\*\*\*\*\* 😊 \*\*\*\*\*

## Lesson 21 BACTOFUGATION

### 21.1 Introduction

Bactofugation is the process of removal of microorganisms from milk using centrifugal force. It is a special form of separation of microorganisms, mainly spore formers (Bacilli/Clostridia) to enable milk to be sterilized at lower temperature-time combinations. Most of the microorganisms are inactivated by pasteurization. However, the highly heat resistant spores survive pasteurization. They can lead to significant quality defects in hard cheese, semi-hard cheese or long-life products due to proteolysis, lipolysis and gas formation. Therefore, bactofugation is mainly used in the manufacture of these products. The objectives of bactofugation are as follows:

- To improve hygienic quality of milk
- To avoid heat resistant bacteria without resorting to excessive heating
- To ensure exceptionally high degree of bacteriological purity in milk.

It removes bacteria, both living and dead, from treated substances whereas traditional heat treatment kills bacteria and leaves them in food. The microorganisms involved in causing milk spoilage, reducing the quality of powder and butyric fermentation thereby causing late blowing of cheese, are mostly spore formers. Bactofugation is important in foodstuffs infected with bacteria containing thermostable endotoxins.

### 21.2 Bactofuge

Bactofuge are special nozzle clarifying separator with high separation precision that can remove microorganisms from milk based on their density difference (skim milk - 1.036; bacteria - 1.07 - 1.13 g/cm<sup>3</sup>).

#### 21.2.1 Design

Separated micro-organisms are concentrated on the periphery of the bowl and the small portion of such discharged milk, highly enriched with the bacteria (bactofugate) is thrown outside via nozzles, and then collected in the sludge discharge pipe. The bactofugate which still corresponds to 2-3 % of the treated milk may be sterilized separately and added back to the bactofuged milk to avoid the losses of milk solids (Fig. 21.1).

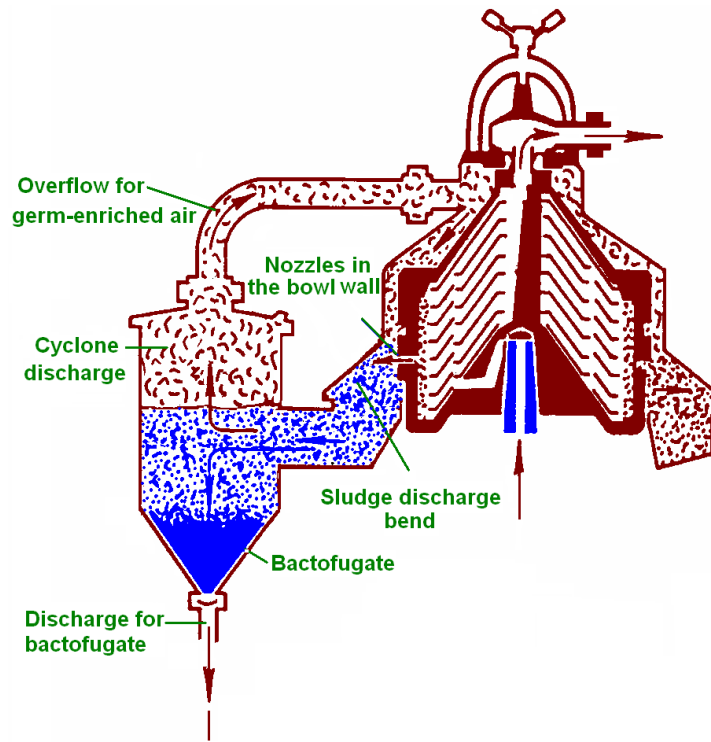

Fig. 21.1 Hermatic bactofuge

### 21.3 Bactotherm process

Clarified and standardized milk is pumped into a plate heat exchanger, where it is heated to a temperature of 60-75°C prior to being fed to the bactofuge. The centrifugal acceleration is increased to 10,000g. The slurry of bacteria (bactofugate) is discharged continuously through nozzles due to their greater specific weight. It is about 3% of the feed by volume and represents a reduction in total bacteria by approximately 50-60%. The bactofugate stream is UHT processed (130 -140°C for 3-4 seconds) and remixed in the normal stream. This time- temperature profile is sufficient to inactivate all spores. The sterilized bactofugate is re-chilled in the plate heat exchanger and can be added back to the de-aerated milk or discharged separately for other suitable applications (Fig 21.2). Continuous recycling of the sterilized bacterial concentrate into the milk avoids losses of products. There are many other applications of the Bactotherm process such as butter oil separation, high fat cream, and other non-dairy applications. For each product, the geometry of the bowl could be altered to suit the product.

Advantages:

- Use of bactofuged cheese milk prevents swelling in certain cheeses which may be caused by heat resistant butyric acid bacteria. Removal of bacteria without pasteurization enables cheddar cheese production with more typical cheese flavor.
- In powders, it reduces the count of microbes and allows significant removal of heat resistant bacteria.
- The severity of heat treatment can be reduced in sterilized milks.
- In cream, defects caused by heat resistant *Bacillus cereus* can be avoided.

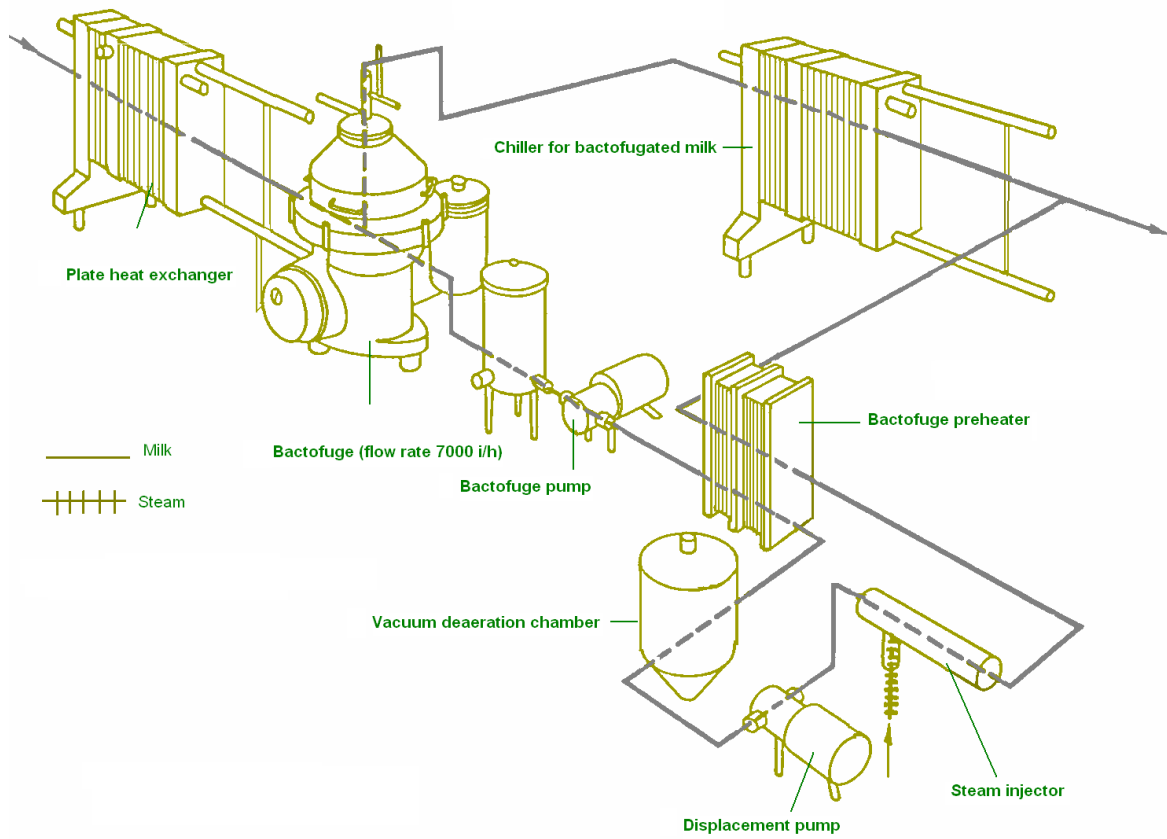

Fig. 21.2 Flow sheet of the Bactotherm process

\*\*\*\*\* 😊 \*\*\*\*\*



**Lesson 22**  
**STANDARDIZATION OF MILK**

**22.1 Introduction**

Many dairy processes require standardization of the chemical composition of milk meant for market purpose or milk products manufacture. Standardizing milk might require control of only one component (usually fat) while allowing the others to vary or control two or more components simultaneously.

**22.2 Standardization**

It may be defined as the adjustment of one or more of the milk constituents to a nominated level. In market milk industry, this normally involves reducing the butterfat content by addition of skim milk or through the removal of cream.

**22.2.1 Objectives**

- To comply with the legal requirements for particular milk/ dairy products.
- To provide the consumer with a uniform product.
- To ensure economics in production.

Addition of skim milk increases the volume of milk available for sale and removal of cream allows the production of other value added dairy products such as table cream, butter or other high fat products.

**22.3 Methods of Calculation**

For standardization of milk or cream for product manufacture, usually the proportions of the various ingredients of known composition to be mixed, is required to be estimated. This can be done by:

- Pearson's Square method
- Algebraic equations

**22.3.1. Pearson's square method**

Draw a square and place in the centre of it the desired fat percentage. Place at the left hand corners of the square, the fat percentage of the materials to be mixed. Next, subtract the number in the centre from the larger number at the left hand side of the square and place the remainder at the diagonally opposite right hand corners. The number on the right hand side now represents the number of parts of each of the original materials that must be blended to have the desired fat content in resultant mix. The number at the upper right corner refers to the parts of material whose fat test was placed at the upper left corner and the number at the lower right corner refers to the parts of material whose fat test was placed at the lower left corner. If the numbers on the right are added, the sum obtained will represent the parts of the finished product.

## Examples

### Problem 1

600 kg of cow milk testing 4% fat is to be standardized to toned milk by removing 33% fat cream. Calculate the amount of toned milk.

### Solution

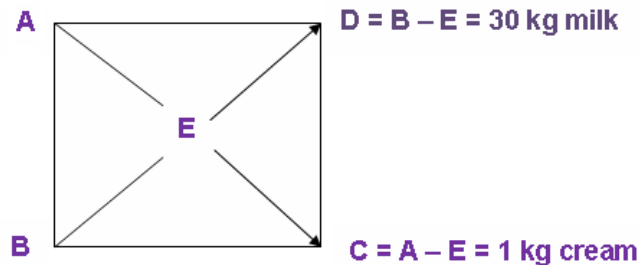

A = Fat percentage of cow milk = 4%

B = Fat percentage of cream = 33%

E = Fat percentage of toned milk = 3%

### Calculation

30 kg of cow milk requires removal of 1 kg of cream

So, 1 kg of milk requires removal of  $1/30$  kg of cream

Therefore, 600 kg milk will require removal of  $(1/30 \times 600) = 20$  kg cream

So, the amount of toned milk will be  $(600 - 20) = 580$  kg.

### Proof Sheet:

In order to check the accuracy of calculations made, put the calculated values of various raw materials in the below given format and check:

Ingredients	Quantity (kg)	Fat (%)	Fat (kg)
Cow milk	600.0	4.0	24.0
Cream	20.0	33.0	6.6
Toned milk (Difference)	580.0	-	17.4

In the product, fat required =  $580 \times (3/100) = 17.4$  kg

Hence proved, because the required value is equal to the calculated value (in the table).

**Problem 2**

1000 kg of double toned milk (DTM) is to be prepared by mixing whole milk, testing 5.5% fat and skim milk testing 0.2% fat. Calculate the amount of whole milk and skim milk required.

**Solution**

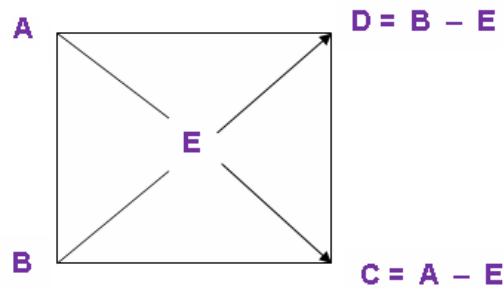

A = Whole milk fat content = 5.5 %

B = Skim milk fat content = 0.2 %

E = Required percentage of fat in double toned milk = 1.5%

So,  $C = A - E = 5.5 - 1.5 = 4.0$  kg skim milk

$D = E - B = 1.5 - 0.2 = 1.3$  kg whole milk

**Calculation**

DTM quantity = 4 kg + 1.3 kg = 5.3 kg

To prepare 5.3 kg of DTM, whole milk required = 1.3 kg.

Therefore, to prepare 1000 kg of DTM, whole milk required will be =  $(1.3/5.3) \times 1000 = 245.28$  kg whole milk

To prepare 5.3 kg of DTM, skim milk required is 4 kg.

So, to prepare 1000 kg of DTM, we require -  $(4/5.3) \times 1000 = 754.72$  kg skim milk

The required quantity of whole milk is 245.28 kg and the skim milk is 754.72 kg for preparation of 1000 kg of DTM.

**Problem 3**

200 kg milk testing 7.2% fat is to be standardized to 4.5% fat by addition of skim milk testing 0.1% fat. Calculate the amount of skim milk required?

A = Fat in whole milk = 7.2%

B = Fat in skim milk = 0.1%

$C = A - E = 7.2 - 4.5 = 2.7$  kg skim milk

$D = E - B = 4.5 - 0.1 = 4.4$  kg whole milk

E = Fat percentage of standardized milk, 4.5%

**Solution**

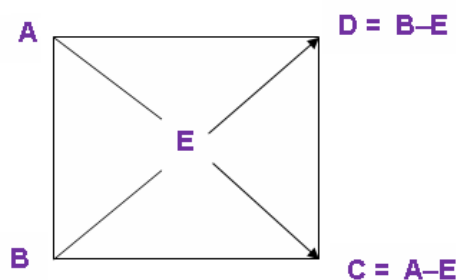

Here, fat % of given milk A = 7.2

Fat % of skim milk B = 0.1%

Fat % of standardized product E = 4.5%

So, C = A - E = 7.2 - 4.5 = 2.7 kg of skim milk

D = E - B = 4.5 - 0.1 = 4.4 kg of whole milk

So, here standardized milk is prepared by mixing whole milk and skim milk

E = C + D = 2.7 + 4.4 = 7.1 kg of standardized milk.

To prepare 7.1 kg of standardized milk, given whole milk required is 4.4 kg.

So, to prepare 200 kg of standardized milk, it requires  $(4.4/7.1) \times 200 = 123.94$  kg whole milk.

7.1 kg of standardized milk requires 2.7 kg skim milk.

So, to prepare 200 kg of standardized milk, it requires  $(2.7/7.1) \times 200 = 76.00$  kg skim milk.

The required quantity of skim milk is 76.00 kg for preparation of 200 kg of standardized milk testing 4.5% fat.

### 22.3.2 Algebraic equations

In this method, we should know the composition of the products to be mixed, the final product and the quantity of any one product. Mass balance equations are formed and solved.

The formula for determining the quantities of skim milk and raw milk on this basis is as follows:

- Skim milk (kg) = kg standard milk required  $\times$  (% fat in raw milk - % fat in standard milk)
- Whole milk (kg) = kg standard milk required  $\times$  (% fat in standard milk - % fat in skim milk)

#### Problem

Prepare 500 kg milk testing 3.0% fat and 8.5% SNF. You are provided with whole milk having 5.0% fat and 9.0% SNF and skim milk powder having 0.5% fat and 96.0% SNF.

#### Solution

Let the quantity of the whole milk = X kg

Quantity of SMP = Y kg

Quantity of water = Z kg

Fat equation:

$$\frac{5.0 \times X}{100} + \frac{0.5 \times Y}{100} = \frac{3 \times 500}{100} \quad \text{or} \quad 5X + 0.5Y = 1500 \quad (1)$$

SNF equation:

$$\frac{9 \times X}{100} + \frac{96 \times Y}{100} = \frac{8.5 \times 500}{100} \quad \text{or} \quad 9X + 96Y = 4250 \quad (2)$$

$$X + Y + Z = 500$$

Now, solving equations (1) and (2) by 5, we get,

$$5X \times 9 + 0.5Y \times 9 = 1500 \times 9 \quad (3)$$

$$\text{or} \quad (5 \times 9)X + 4.5Y = 13500 \quad (4)$$

$$9X \times 5 + 96Y \times 5 = 4250 \times 5$$

$$\text{SNF required} = 500 \times (8.5/100) = 42.5 \text{ kg}$$

Hence proved, because the required values are equal to the calculated values (in the table).

## 22.4 Methods of Standardization

There are three methods for standardization. These are batch, continuous and automatic standardization. They all involve the separation of whole milk into skim milk and cream and then proceeding for blending the required quantities only.

### 22.4.1 Batch standardization

It is a process most commonly used in the dairies. Raw milk is held in a silo and its fat content is evaluated. Some quantity of milk is removed and separated into skim milk and cream. The amount of skim milk or cream required is determined by the calculation (or from charts) and then added to the bulk milk under continuous agitation. The bulk milk is retested to check whether the fat content is as per the desired figure or not. If it is not, further adjustments are made until the batch is standardized correctly. The demerits of batch standardization are the time taken for agitation, testing and final mixing.

### 22.4.2 Continuous standardization

Continuous standardization employs an inline sampler in association with a testing device, which samples, measures and displays the fat content every 20 seconds. The operator observes the fat content displayed and adjusts the values to blend skim milk or cream into the milk line, before the sampling point, to alter the fat content to the required level.

### 22.4.3 Automatic standardization

It is an extension of the continuous process. The separator is replaced by a microprocessor/controller unit linked to the sampler/tester system. The microprocessor/controller unit has information about the desired fat content and flow rates of the whole and skim milk. It receives signals from the sampler/tester system and responds by opening or closing a valve, which regulates the amount of skim milk added to the whole milk. The merits of this automatic process are time and labour savings and ensure more accurate standardization than other methods. Standardization depends on correct sampling, accurate testing of fat content, efficient separation and the correct amount of skim milk or cream needed.

## 22.5 Tri-Process Machine

Tri-process machine is designed to clarify, separate, standardize milk in a single unit. The general construction is similar to that of standard cream separator. The tri-process separator has external valves in the discharge lines of cream and skim milk. A precise needle valve is fixed in the outlet for cream, which controls the cream flow rate. There is a bypass line connected from the cream discharge line to the skim milk discharge line. This bypass line has a needle valve which would control the flow of the cream coming in the bypass line. A cream meter is installed in the cream outlet line.

For standardization of milk to the desired fat content, the needle valve in the bypass line is adjusted to such a position that the bypass cream when mixed with the skim milk would result in the desired fat % in the standardized milk.

\*\*\*\*\* 😊 \*\*\*\*\*

**Lesson 23**

**HOMOGENIZATION - DEFINITION AND THEORIES**

**23.1 Introduction**

Homogenization implies mechanical treatment to break fat globules into smaller size of 2  $\mu\text{m}$  or less and uniformly disperse them in milk. Homogenization in the dairy industry is used principally to prevent or delay the formation of a cream layer in full cream milk by reducing the diameter of the fat globules. After homogenization, size of fat globules becomes less than 2  $\mu\text{m}$ . The average size of milk fat globule in milk is 2-12  $\mu\text{m}$ . The number of fat globules is 3-4 billion in a milliliter of milk.

In the past, pasteurized milk usually was not homogenized, although the flavor of the milk becomes fuller by homogenization. A certain amount of cream was permitted to form to show the consumer clearly the full cream character of milk. Sterilized milk, evaporated or condensed milk and cream are generally homogenized.

**23.2 History**

Homogenization was introduced by Buttenberg (1903) of Germany, and later developed in 1904 in London and the milk produced by this process was known as 'Gaulin milk'.

**23.3 Definition**

Homogenization can be defined as the process in which fat globules in milk are broken down to a size small enough to prevent the formation of a cream layer. Homogenizer is a machine, which disintegrates the fat globules of milk.

According to the United States Public Health Services (USPHS), 'homogenized milk is one that has been treated in such a manner as to ensure the break-up of the globules to such an extent that after 48 hours of quiescent storage, no visible cream separation occurs in milk and the fat percentage of the milk in the upper 10% portion, i.e., in the top 100 ml of milk in a quart bottle or of proportionate volumes in containers of other sizes, does not differ by > 10% of itself from the fat percentage of the remaining milk, as determined after thorough mixing'.

The number of fat globules in homogenized milk is about 10,000 times greater than those in unhomogenized milk. The size of fat globule is reduced to < 1 micron, while normal fat globule size averages 2 - 12  $\mu\text{m}$  in milk. The number of fat globules will be increased, but total volume of fat globules will remain almost same. The surface area of newly formed smaller fast globules is increased by 4-6 folds.

**Table 23.1 Purpose of homogenization in different products**

Milk, cream, condensed milk	Prevention of cream
Coffee cream	Separation, improvement in flavour, increased whitening power, increase in viscosity
Yoghurt	A more stable gel
Ice cream mix	Reduced fat separation during freezing; higher overrun attained
Whole milk powder	Lower free fat content in powder. Better flowability of powder
Cheese (Soft types)	Increased cheese yield. Superior flavor

### 23.4 Merits of Homogenization

- No formation of cream layer/plug
- Fat will not churn
- Thick body and rich appearance
- Produces soft curd, easily digestible
- Less susceptibility to oxidation

### 23.5 Demerits

- Increased cost of production
- Fat from returned homogenized milk is difficult to salvage.
- Sediment is greater
- May produce rancidity if temperature is not kept adequately high.

### 23.6 Principles of Homogenization

In raw milk, the diameter of the fat particles varies from 2 to 12  $\mu$ , while a diameter of about 2  $\mu$  or less is required to keep the fat from rising in stored condition (Fig 23.1). The milk is forced at high pressure through a narrow slit (spring loaded valve), which is only slightly larger than the diameter of the globules. The velocity of milk in the narrow slit can be 100 - 200 m/s. This can cause high shearing stresses, cavitations and micro-turbulence. The globules becomes deformed, wavy and then breakup (Fig 23.2).

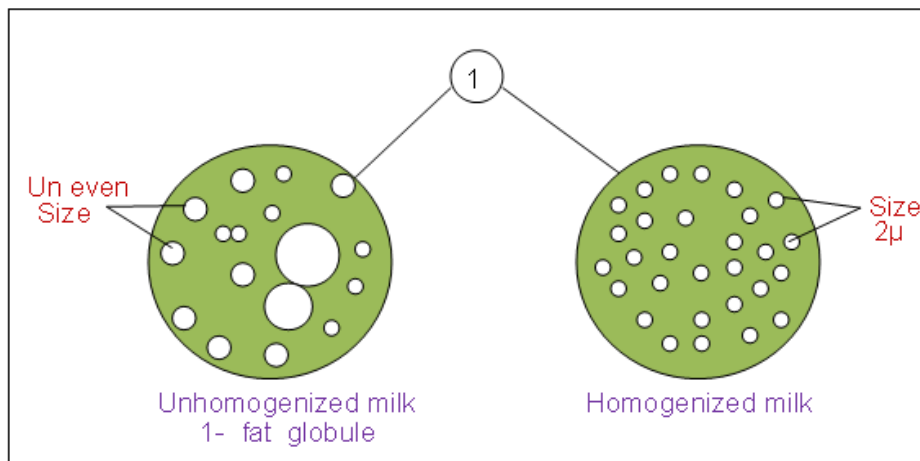

**Fig 23.1 Effect of homogenization on fat in milk**

### 23.7 Homogenizer

The homogenizer consists of a high pressure, reciprocating pump driven by a powerful motor, and a back pressure device i.e. homogenizer head. It is equipped with a set of valves and valve pressure screws that enable the exposure of liquid products to very high pressures. To withstand the high pressure and velocity and to prevent the wearing of the head, a special metal alloy 'stellite', which is noted for its hardness, is used for making the homogenizer valve. The power source is an electric motor built into the unit. The motor drives the crank and piston assembly either by a pulley or by a set of gears, both of which greatly reduce rpm to provide a suitable speed for the pistons. The gears, cranks, and drive shafts run in an oil bath. The pistons (commonly three sometimes five or seven in number) are usually straight rods giving a small displacement. The pistons extend from the crank shaft in the crank housing, into the pressure chamber in the homogenizer head. Each piston passes through a packing gland especially designed both to prevent product leakage, despite high operating pressures and to facilitate sanitation. The parts of homogenizer head are precisely ground and made to fit together in correct position in order to avoid any leak. The wear and tear of homogenizer head is also frequently checked because if there is any shell gap the fat globules may escape through it and lower the efficiency of homogenization.

### 23.8 Process

The high velocity of milk confers high kinetic energy. The energy is dissipated into heat and since the passage time through the slit is small ( $< 0.1$  m/s), the average energy density is very high. Such high energy densities lead to very intense turbulence (Reynolds number  $> 40,000$ ). The pressure fluctuations are not desirable.

When the flow velocity in the valve slit is at its maximum, local pressure is less than zero. A negative pressure may cause cavitations (i.e. the formation and sudden collapse of vapor bubbles). The collapsing process creates huge shock waves, which may disrupt particles. The degree to which this happens in homogenizers varies. In most cases, globule disruption primarily is caused by turbulent eddies. The small globules do not rise to the top of milk but remains suspended in the milk or rise very slowly. Immediately after the globules are broken down, they show a tendency to cluster and rise to the top of the milk. Two-stage homogenization prevents this. The second stage breaks up any clusters, thus ensuring better dispersion on the fat throughout the milk.

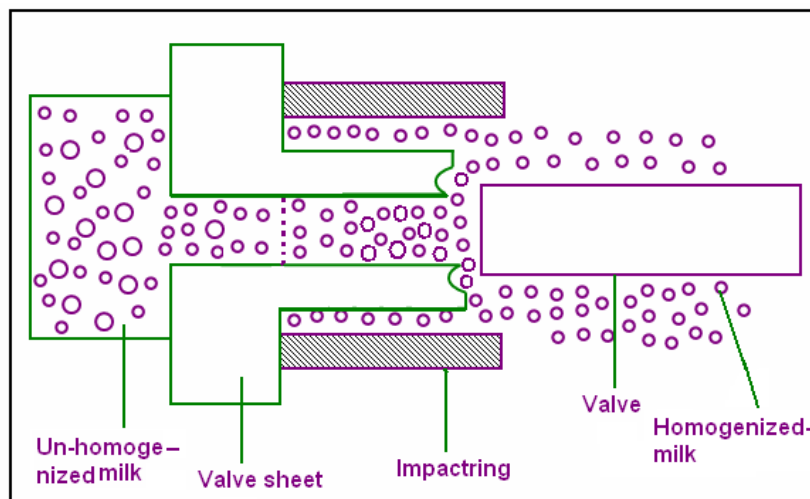

Fig 23.2 Homogenization of Milk



## **23.9 Theories of Homogenization**

### **23.9.1 Shattering & impact**

The fat globules are shattered by impinging them on the retaining valve or impact ring.

### **23.9.2 Explosion**

With the release of high pressure, the fat globules explode.

### **23.9.3 Shearing & grinding**

The fat globules are subjected to unequal forces as milk flows at different velocities in a fluid stream. As a result of the shearing action between globules, it deforms the fat globules beyond its yield point.

### **23.9.4 Cavitation**

The vapor bubbles or cavities are formed within the medium and as they collapse subsequently, energy in the form of shock waves is released breaking up of fat globules.

### **23.9.5 Attenuation**

The fat globule disruption is attributed to violent changes in the velocities of milk as it passes through the unit rendering a fragmentation slight effect on the mean particle size.

\*\*\*\*\* 😊 \*\*\*\*\*

**Lesson 24**

**HOMOGENIZATION - TYPES AND OPERATION OF HOMOGENIZERS**

**24.1 Types of Homogenizer**

**24.1.1 High pressure homogenizer**

This type of homogenizer consists of single acting triplex pump with each cylinder having suction and discharge valves. The discharge valve of each pump empties into a common discharge pipe, in which a special valve is placed. The pressure ranges between 35 – 350 bar (500-5000 psi) depending on the type of construction of the valve.

**24.1.2 Low pressure-rotary type homogenizers**

Usual operating pressures are below 35 bar (500 psi). The construction is so designed that milk is subjected to grinding and shearing action.

**24.1.3 Sonic vibrators**

The milk is subjected to high frequency vibration in a device called sonic vibrator or oscillator. The machine consists of a flat disc actuated by an electric magnet located over an anvil containing a hole, through which milk enters. The milk passes through the space between the disk and an anvil, and the vibrating action of the disk against the film of milk hammers the fluid at high frequency.

**24.2 Details of homogenization**

Homogenizers can be single-stage, double-stage or even multi-stage type. Single-stage homogenizers are equipped with only one homogenizing valve. A homogenizing valve usually consists of a valve, valve seat and an impact ring. These are held within a valve body. On the other hand, double-stage homogenizers are equipped with an additional homogenizing valve (Fig. 24.1).

Commercial milk homogenizers are high pressure reciprocating pumps, each having a sanitary head upon which is mounted a homogenizing valve or valves. Homogenizers have 3, 5 or 7 pistons driven by an eccentric shaft through connecting rods and cross heads. The pump head contains a section manifold with passages connecting to the individual cylinders. Each cylinder has suction and a discharge valves, either poppet or ball type. The valves are spring loaded in some models.

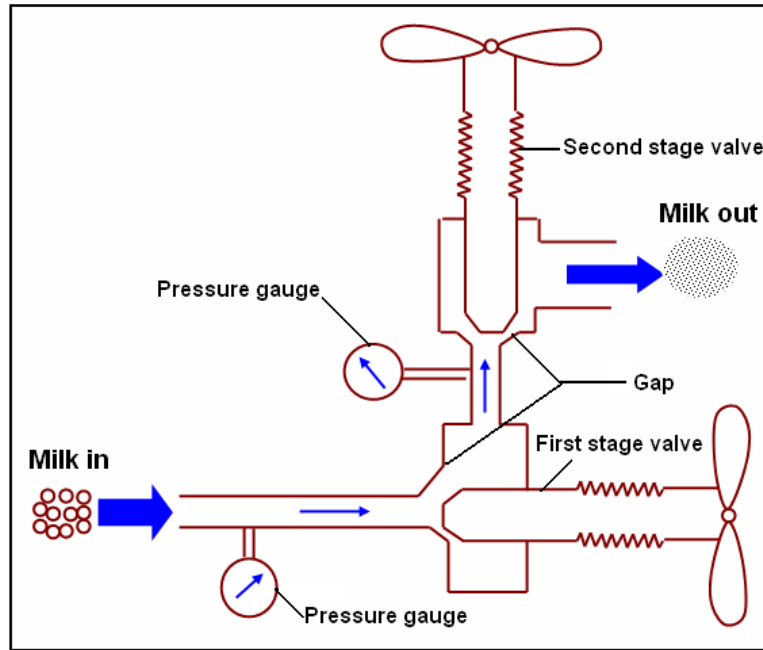

Fig. 24.1 Diagram of two-stage homogenizer valve

The homogenizing valve accomplishes its intended function by restructuring the product flow area which results in the pressure commonly known as "the homogenizing pressure." The degree of homogenizing effect can be controlled by regulating this pressure, or corrected by the restriction to flow. A pressure gauge is used to indicate the pressure. Generally, double-stage homogenizers are used and pressure of 140 bar (2000 psi) and 35 bar (500 psi) in the first and second stages respectively are maintained.

### 24.3 Factors Affecting Homogenization

#### 24.3.1 Homogenization pressure

In a single-stage homogenizer, usually 140 - 175 bar (2000-2500 psi) pressure is sufficient for milk having up to 6.0% fat. Higher pressure may increase the tendency of the milk to curdle when cooked, due to the increased destabilizing effect on milk proteins. For milk on milk products with > 6 % milk fat, two-stage homogenization is needed to prevent fat clustering pressure of 140 bar (2000 psi) and 35 bar (500 psi) in the first and second stage respectively are applied in two-stage homogenization.

Table 24.1 Effect of homogenization pressure

Homogenizing pressure (bar)	0	50	100	200	400
Temperature rise (°C)	0	1.2	2.5	5	10
No. of fat globules ( $\mu\text{m}^{-3}$ )	0.015	2.8	6.9	16	40
Average diameter ( $\mu\text{m}$ )	3.3	0.71	0.47	0.31	0.21
Maximum diameter ( $\mu\text{m}$ )	1.0	3.2	2.4	1.6	1.1
Specific surface area ( $\text{m}^2 \text{ml}^{-1}$ of milk)	0.08	0.38	0.56	0.85	1.2

#### **24.4.2 Stage of homogenization**

For milk with more than 6% fat, two stage homogenization is better. If the broken up fat globules have a tendency to agglomerate after the first homogenizing stage (150-200 bar), they can be re-dispersed employing 20-40 bar in the second stage.

#### **24.4.3 Temperature of homogenization**

The enzyme lipase should be inactivated prior to homogenization by pre-heating milk to a temperature of 60°C or above. At this temperature fat is already in molten condition. In routine practice, the milk is heated to 65-70°C (149-158°F) for homogenization.

#### **24.4.4 Fat content**

Homogenization becomes less effective with increasing fat content. When the fat content is high, raising the temperature improves homogenization efficiency. When the fat content is high, the newly created total fat globule surface is so large that the material (plasma protein) becomes insufficient to form new membranes on fat.

### **24.5 Efficiency of Homogenization**

#### **24.5.1 Degree of homogenization**

The degree of homogenization is defined as the ratio of the volume of fat with fat globules diameter of  $< 0.7 \mu$  to the total fat content of milk or cream. The value of  $0.7 \mu$  was based on the fact that fat globules with smaller diameter do not form clumps because they break up again due to Brownian movements.

#### **24.5.2 Farrall index**

It is a widely accepted microscopic method for determining the homogenization efficiency. This index may be defined as the number of fat globules having  $< 2 \mu$  in diameter. The efficiency of homogenization is apparently based on the number of fat globules larger than  $2 \mu$  (if any), as measured under specified conditions.

### **24.6 Operation of the Homogenizer**

#### **24.6.1 Before starting the homogenizer, the following points should be checked**

- Water is turned on to lubricate and cool the pistons.
- Pressure controls are checked to see that they are in idling position.
- Check availability of the product to the machine.
- Check during starting of the machine whether the oil pressure records  $> 1 \text{ kg/cm}^2$ ; otherwise the starter will trip.

#### **24.6.2 Starting of homogenizer machine**

- The motor is started.
- The homogenizer is run on water for about 5 min., then it is stopped and the water drained off by slackening the inlet union, which is tightened subsequently.
- The machine is checked for any leaks.

- The homogenizer is provided with milk supply by adjusting the 3-way valve accordingly.
- As soon as the machine starts pumping at full capacity, the pressure adjusting handle of the second stage valve is adjusted to the desired pressure, followed by adjusting the first stage pressure. This can be observed in the single pressure gauge provided.
- The product discharge from the machine is diverted back till the desired homogenizing pressure is obtained.
- When normal operation is attained, the bypass valve is turned to direct the product flow into the processing system.

Note: In some homogenizers, there might be provision to release the air from the machine.

### 24.6.3 Closing down the homogenizing operation

- At the end of the run, the product flow is diverted.
- As soon as the product to be homogenized is emptying out, the water is filled into the hopper for flushing.
- The first stage valve pressure and subsequently the second stage valve pressure are released in that sequence.
- The homogenizer can now be cleaned by switching over to the cleaning sequence.
- After the cleaning is over, the homogenizer is stopped.

### 24.6.4 Precautionary measures

- The homogenizer should never be run dry. Adequate feed must be maintained at all times to prevent starving of the machine.
- Before the homogenizer is put to use again, the strainer from the inlet chamber should be removed, cleaned and refitted.
- The homogenizer should always be started with both homogenizing valve handles in released position.
- The pressure should be built up gradually.
- While the homogenizer is running, the 3-way valve on the product delivery line should never be closed; otherwise it may result in severe damage to the machine.

### 24.7 Maintenance of Homogenizers

- The oil level should be inspected daily for maintaining desired level.
- Periodic check-up of the lubricating system must be done. Change the lubricating oil before 500 operating hours or 6 months or sooner, when it becomes emulsified.
- Inspect oil seals for preventing any chance of mixing of water with oil.
- Leakage can be prevented by tightening the nuts or couplings, inserting or replacing gaskets or replacing the pistons.
- The homogenizer gauges should be checked periodically for accuracy against a standard gauge.
- The homogenizer valves must be regularly inspected and if required, they should be lapped with a fine abrasive for perfect sealing.
- While dismantling the valves, care must be taken to avoid scratches. They must be kept on a rubber mat.

\*\*\*\*\* 😊 \*\*\*\*\*

**Lesson 25**  
**HOMOGENIZATION - EFFECT ON MILK PROPERTIES**

**25.1 Introduction**

Homogenization prevents phase separation of fat into cream layer during storage and enhances the richness of mouth feel as well as due to an increased surface area. It involves physical changes in milk protein, resulting in lower curd tension and possibly increased digestibility due to faster coagulation in the stomach.

**25.2 Effect of Homogenization on Physico-Chemical Properties of Milk**

**25.2.1 Reduction of fat globules size**

Reduction of fat globule size to  $< 2 \mu$  prevents formation of cream layer and increases the surface area of the fat above 6 times.

**25.2.2 Whiter milk**

Homogenization of milk increases its whitening power due to an increase in the number and surface area of the fat globules. Adsorption of casein micelles and serum proteins on newly created fat globules surface increases scattering of light thereby causing whiter appearance.

**25.2.3 Physiology of nutrition**

Homogenization has been reported to improve the digestibility of milk due to increase in the number and surface area of the fat globules.

**25.2.4 Flavour of milk**

Homogenized milk has a uniform flavour throughout. It tastes richer, smoother and creamier than unhomogenized milk due to an increase in the surface area of the fat globules which are uniformly distributed in milk.

**25.2.5 Sensitivity to lipase**

Homogenized milk is more susceptible to enzymic activities, especially lipase action, than unhomogenized milk. Lipase can cause rancidity rapidly in homogenized raw milk.

**25.2.6 Susceptibility to oxidation**

Homogenized milk is more susceptible to oxidized flavours caused by natural or artificial light than unhomogenized milk. To prevent development of off-flavours, homogenized milk must be packaged in opaque containers, such as cartons, plastic containers or coloured bottles.

## 25.2.7 Sediment on storage

Homogenized milk may develop dark sediment at the bottom of the container after standing for 24 h. This is due to settling of cells, foreign matter and casein particles. In unhomogenized milk, these particles are usually held by the fat globules. To prevent the sediment formation, homogenized milk must be filtered or clarified, preferably before homogenization.

## 25.2.8 Bacterial count

There will be an apparent increase in bacterial count after homogenization due to the break-up of clumps and colonies of organisms.

\*\*\*\*\* 😊 \*\*\*\*\*

**Lesson 26**  
**PRINCIPLES OF HEAT TREATMENT**

**26.1 Introduction**

In the dairy industry, thermal processing is accepted terminology to describe heat treatment required to eliminate/minimize chances of spoilage of milk and occurrence of food borne illness there-from. Pasteurization is one type of thermal processing designed for a specific pathogenic microorganism, but it does result in a shelf stable product without refrigeration. Thermal treatment is the transfer of heat energy into milk. Such heat treatment of milk consumes a lot of energy. The objective of the heat treatment is to completely inactivate all microorganisms and most of the enzymes contained in milk. Primarily, heat treatment is a hygiene-oriented activity within the entire framework of processing. On the other hand, it is a dominant factor for improving the shelf life of all fresh milk products and is a legal obligation. The most common thermal process is pasteurization.

**26.2 Pasteurization**

It is the thermal inactivation of microorganisms at temperatures around 72-78°C for specific time period, which improves the hygienic quality of milk and achieves a certain level of preservation.

The main objective is to kill pathogens to avoid health hazard. At the same time, a significant reduction in the total bacterial count is accomplished increasing the shelf life of milk and milk products made thereof. Apart from the hygiene aspect, gentle heat treatment must be achieved which results in time-temperature profiles meeting the following requirements:

- The percent destruction of microorganisms has to be > 99%; for pathogenic germs, it must be 100%.
- Milk must be treated gently in order to retain the nutrients and vitamins to the maximum possible extent as well as preserving its organoleptic quality.
- Process economics must be profitable, and the installation cost must be low.

Other processes that can decrease the microbial population in milk include bactofugation.

Other methods include:

- Radiation with UV, X-rays or gamma-rays.
- Ohmic heating. This is the advanced thermal processing method where in the milk, which serves as an electrical resistor, is heated by passing electricity through it. Electrical energy is dissipated into heat, which results in rapid and uniform heating. Ohmic heating is also called electrical resistance heating, joule heating, or electro heating.
- High-pressure process, using pressures of 2000-6000 bar at temperatures of 40-~60°C.
- Ultrasound process.
- Microwave treatment.

The last process is a very interesting one for the thermal treatment of foods. During heating with microwaves, the product is exposed to an electromagnetic field having a frequency of 800-3000



Hz. The heat is caused by the rotation of the dipoles and oscillation of ions in the food. The microwave energy is created by transforming a current in a generator magnetron or klystron, from which the microwaves are fed through a rectangular channel (to conduct the waves) into an applicator and heat treatment unit. The product enters the sealed and protected chamber, and the microwaves are fed into it (with an antenna, slit and/or other sharp inserts and other facilities for distributing the microwaves), and penetrate the food evenly.

These processes are not yet widely applied. Their main disadvantage is their low inactivation effect, legal barriers, and high costs.

## 26.3 Influence of Heat Treatment on Milk

The inactivation effect and the chemical-physical, nutritional and organoleptic changes in milk during heat treatment are characterized by the following parameters:

- Temperature and time profile
- Type of microorganisms and the initial level of contamination
- Acidity of milk
- Flow conditions and heat transfer in the installations

## 26.4 Time and Temperature

Regarding microorganism inactivation, there is a nearly logarithmic relationship between temperature and time for a given range. If temperature is increased by 10°C, the bacterial count is reduced to 1/10th of the initial level. If we assume that for a total inactivation of the microorganisms in milk at 100°C the time required is 30 minutes, then we can obtain the following residence time if temperature is raised by 10°C:

$$100^{\circ}\text{C} = 30 \text{ min} \quad 130^{\circ}\text{C} = 1.8 \text{ s}$$

$$110^{\circ}\text{C} = 3 \text{ min} \quad 140^{\circ}\text{C} = 0.18 \text{ s}$$

$$120^{\circ}\text{C} = 0.3 \text{ min or } 18 \text{ s}$$

The quotient, which expresses the decrease in inactivation time when the temperature is increased by 10°C is called the  $Q_{10}$  factor. This value indicates how much time would be required for complete germ inactivation when the temperature is raised by 10°C. The  $Q_{10}$  factor for non-spore forming microorganisms is 9-13, whereas for spore formers it is about 30. If a type of bacteria is inactivated at 11.5 times more rapidly at 90°C than at 80°C, then the  $Q_{10}$ -factor is 11.5. The velocity of chemical reactions in milk increases by a factor of 2-4, when temperature is increased by 10°C; the physical changes increase by a factor of about 2.

Another indicator for complete inactivation (sterility) is the F-value.

## 26.5 Changes in Milk Components

The relatively low  $Q_{10}$  values for chemical and physical modifications appear to permit very high heat treatment for a short time; however, we have to consider modification in the milk components even with temperatures slightly above 70°C with residence time of a few seconds.

With increasing temperatures and residence times, whey proteins are modified; e.g., the solubility decreases to such an extent that they coagulate with casein at a pH of 4.6. Another consequence of the heat treatment of proteins is the liberation of sulfhydryl groups (-SH groups), thus increasing

the anti-oxidative properties of milk, leading to the development of 'cooked taste'. At the same time, we observe a percent decrease in whey proteins and a quantitative increase in casein. In particular, we observe complex formation between  $\beta$ -casein and  $\beta$ -lactoglobulin, resulting in an additional protective colloidal effect.

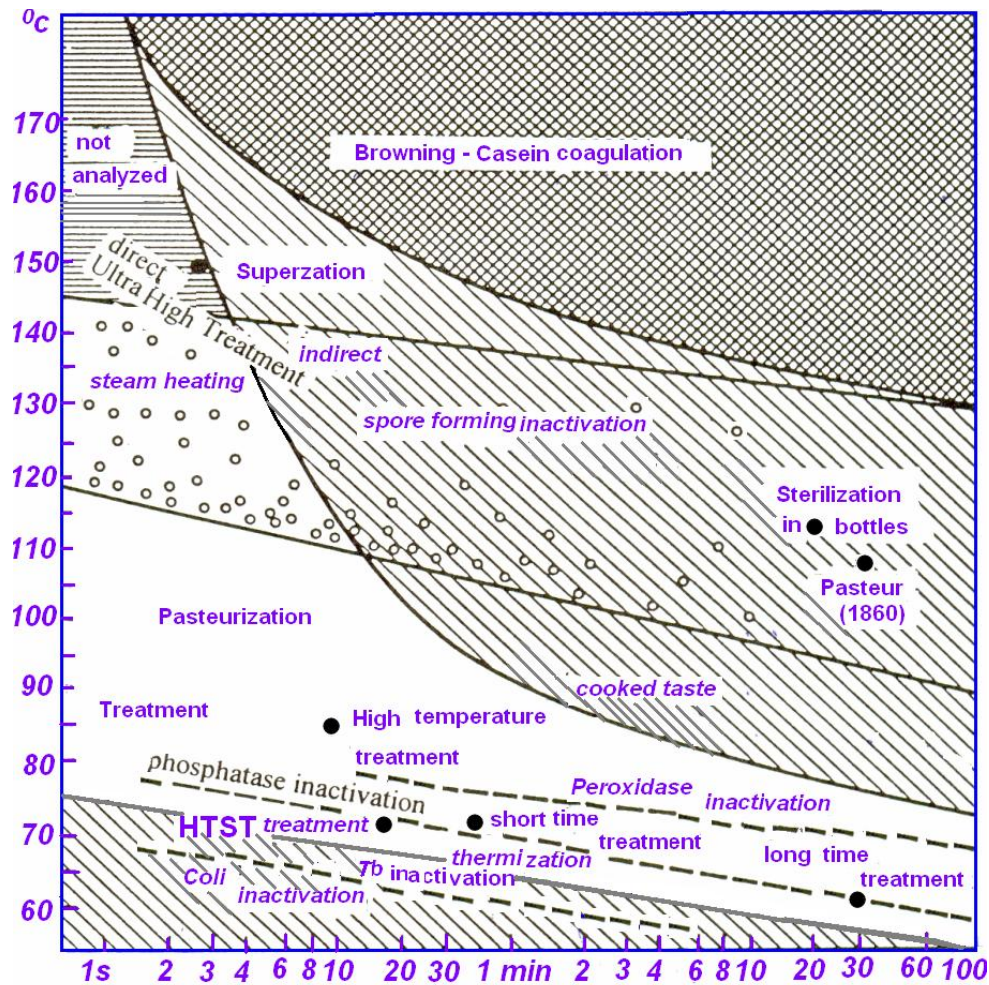

Fig. 26.1 Influence of the heat treatment process on milk quality

This results in delayed release of the peptides when rennet is added to cheese milk. Hence, cheese milk should be pasteurized at minimum temperature-time combination suggested for milk. Casein remains nearly unchanged at normal pasteurization temperature.

A firm gel is formed due to the concomitantly increased water-binding capacity of the heat denatured proteins culminating in reduced syneresis, which is favorable in the manufacture of yogurt/dahi.

The heat treatment also leads to disturbance in the salt equilibrium in milk. Soluble calcium and phosphorus are bound in the form of calcium phosphate, which precipitates on the casein micelle. This activity is reversible up to a temperature of 80°C; at higher temperatures, calcium precipitates and forms stone-like deposits on the heat exchanger surface.

Longer residence times at temperatures >100°C can lead to complex compounds between casein and lactose. The observed browning is due to Maillard reaction. At this temperature, nearly all enzymes are inactivated, and vitamin losses of 20-30% are observed. But even at lower temperatures, significant vitamin degradation occurs, especially of B complex vitamins.

Heat treatment has only a minor effect on fat. Only the membranes of the fat globules with their heat-sensitive protein compounds experience some modifications, influencing the agglomeration of fat globules and their creaming.

### 26.6 Germ Inactivation

The germ inactivation effect depends largely on the type of microorganisms present in milk. Most of the vegetative forms, especially the lactic acid bacteria, and pathogens are destroyed at temperatures of 70-90°C and residence time of a few seconds to few minutes. Excluded are the thermophilic lactic acid bacteria which can survive slightly higher temperatures and the spores of surviving bacilli/Clostridia; temperatures > 100°C are necessary for their destruction. The time required for germ inactivation is a function of the total count, and the initial count determines the total count of the milk which is to be treated

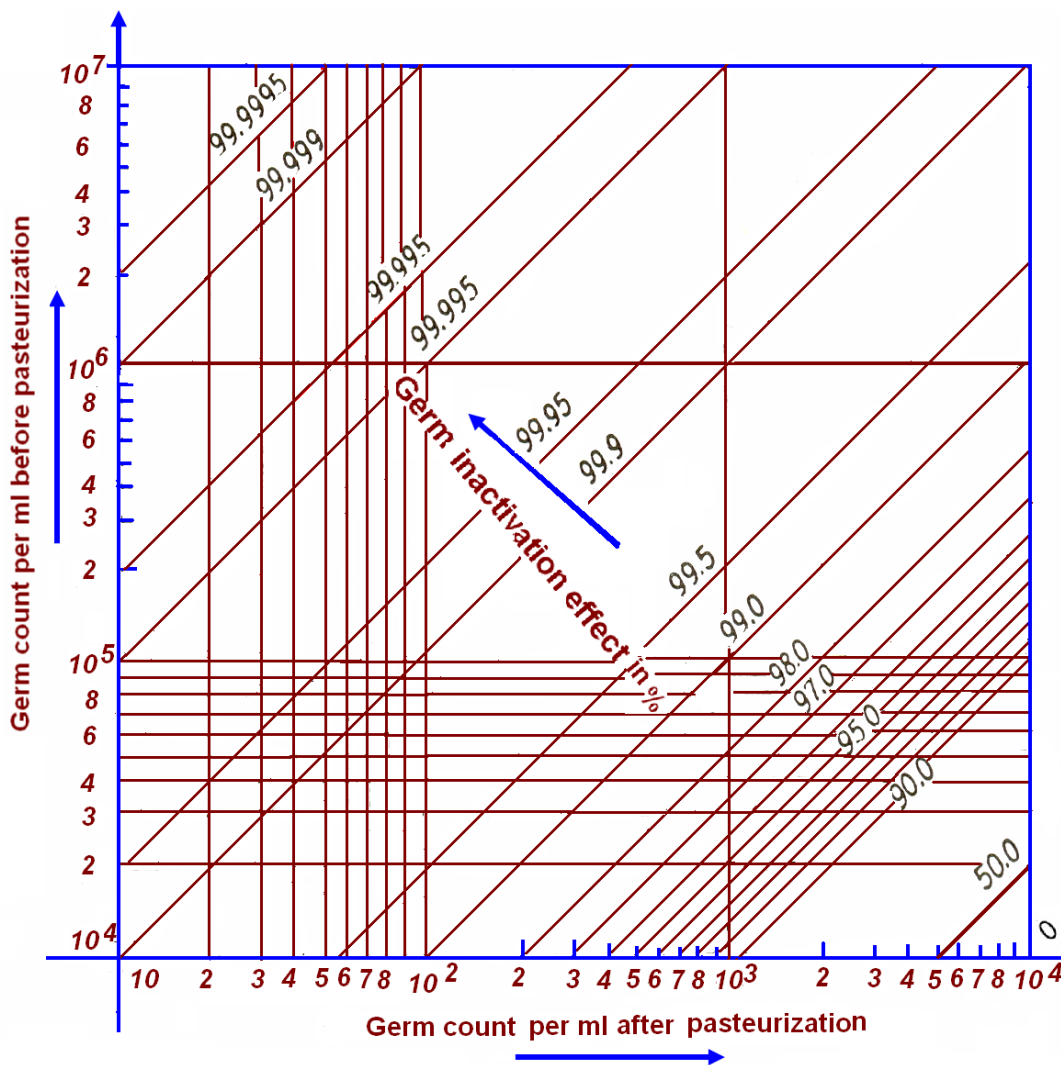

Fig. 26.2 Germ Inactivation effect during pasteurization

### 26.7 Heat Treatment Processes

The holding time at a specific temperature is a function of the residence time in the heating where milk reaches the preset temperature due to heat transfer as well as residence time in a post heating holding section, where no heat transfer takes place. The time-temperature combinations of the heating process for milk are shown graphically in Fig. 26.2. The short time treatment guarantees relatively gentle heat treatment and is the most widely applied system. Due to the large-scale

handling requirements of milk, the low-temperature long-time (LTLT) treatment is without any industrial significance. The high-temperature short-time (HTST) treatment is a relatively gentle process and is the most widely applied system.

**Table 26.1 Heat treatment processes**

Type	Temperature range (°C)	Holding time	Percent Inactivation	Assessing efficacy of heat treatment	Remarks
Thermization	57-68	15 – 20 s	< 95	Phosphatase positive	Thermization process for raw milk and cheese milk
Batch method	62-65	≥ 30 min	95	Phosphatase negative	Batch wise heating
Short time	71.7-74	≥ 15 s	99.5	Phosphatase negative	Pasteurization with indirect heat transfer
High heat	85-90	0 - 25 s	99.9	Peroxidase negative	Pasteurization with indirect heat transfer
High pasteurization	115 – 125	2 – 5 s	99.99	Peroxidase negative	High heat with direct steam injection in heating section
Ultra-high heat	135 - 150	2 – 10 s	100	Peroxidase negative	With direct or indirect heat transfer
Sterilization	110 -118	15 - 25 min	100	Turbidity negative	Indirect heat transfer

Thermization is used mainly for heat treatment of raw milk in order to stabilize its quality during long storage by inactivating psychrotrophic microorganisms.

The high heat process is used mainly for heating of cream. It is also used eventually for a very low quality of raw milk. The high heat process with direct steam injection is used in order to increase the shelf life of fresh milk under conditions similar to those for the short-time process. This process is also used for cheese milk and milk concentrates for long-shelf-life products.

### 26.8 Time-Temperature Profiles for Heating

Ultra high temperature (UHT) process leads to organoleptic changes in milk without changing the nutritional value significantly. Direct or indirect heating is used for preparing UHT milk. Sterilization is used only, when filled products must be preserved for a period longer than 5 months at ambient temperature. Heat treatment can also be used in combination. A thermization or a short-time heat treatment can be used before applying a high-heat pasteurization, ultra-high heat treatment or sterilization (Fig. 26.3). Sterilization leads to a completely sterile product. The high-heat pasteurization and ultra-high heat treatment achieves ‘commercial sterility’; i.e., the product is free of live microorganisms, except for few spore formers.

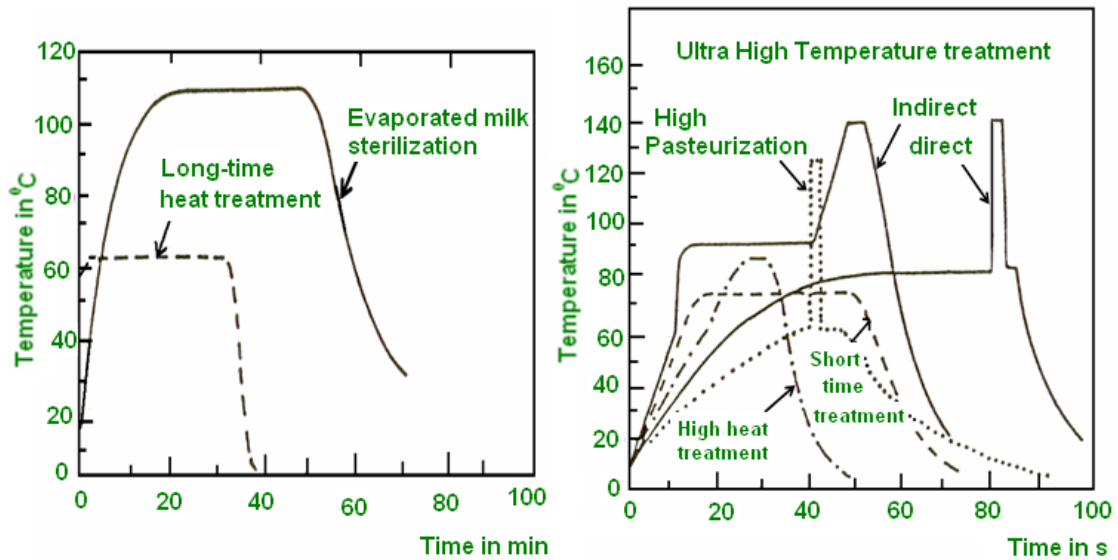

Fig. 26.3 Time-temperature profiles for heating process

### 26.9 Control of Heat Treatment

Ensuring adequate heat treatment must be established in two different ways. One way is by recording the temperature; the chart shows the date of processing which should be kept for two years. For short shelf stable products, the storage period for the records is shortened to two months after expiry or minimum shelf life date.

The second test is alkaline phosphatase test. Raw milk contains alkaline phosphatase. It is destroyed at the temperature necessary for efficient pasteurization. When milk containing phosphatase is incubated with p-nitro-phenyl di-sodium orthophosphate, the liberated para-nitro-phenyl gives a yellow color under the alkaline conditions of the test. The color is a measure of the phosphatase content of the milk sample. Therefore, if phosphatase is present, it indicates that the milk has not been heated to right temperature or got contaminated after the heating process by raw milk. If the high heat pasteurization is done properly, the enzyme peroxidase (inactivated at temperatures ? 85°C) would not show any activity in test. If HTST pasteurization is applied, the enzyme alkaline phosphatase would be completely inactivated (inactivated at temperatures? 71°C).

\*\*\*\*\* 😊 \*\*\*\*\*

**Lesson 27**

**KINETIC PARAMETERS OF HEAT INDUCED CHANGES**

**27.1 Introduction**

To establish the thermal processing schedule, the thermal destruction rate of the test microorganisms must be determined under the conditions that normally prevail in the container so that an appropriate heating time can be determined at a given temperature. Furthermore, since packaged foods cannot be heated to process temperature instantaneously, data on the temperature dependence of the microbial destruction rate are also needed to integrate the destruction effect through the temperature profile under processing conditions.

Microorganisms are destroyed by heat when microbial proteins coagulate and enzymes required for their metabolism are inactivated. The exact molecular mechanism underlying the thermal death of microorganisms is not clear, but it is believed to be due to thermal denaturation of the secondary and tertiary structures of macro-molecular cellular organizations (DNA, membrane proteins etc.) which renders them biologically inactive.

Heat treatment, necessary to kill microorganisms or their spores, varies with the kind of organisms, their state and their environment during heating. Several terms are used to denote heat resistance of the spores, viz. D-value, Z-value, Q<sub>10</sub>, sterilizing effect, etc.

**27.2 D-Value (Decimal Reduction Time)**

It is the time in minutes necessary at a specific temperature (?) to reduce the number of organisms to 1/10 of the original value.

**27.3 Z-Value**

It is an increase in temperature necessary for obtaining the same lethal action at 1/10th of the time.

**27.4 F<sub>0</sub> Value**

F is thermal death time (minutes) of an organism at 121°C and F<sub>0</sub> value indicates F value when Z equals 18. It is a total integrated lethal effect and is used to measure microbial severity of a thermal process. It allows the comparison of different thermal processes which have been carried out under different operating conditions. F<sub>0</sub> value for low acid foods is 3 and for milk puddings is 4 to 10. Ex: F<sub>0</sub> value is 10 minutes at 121°C which is equivalent to 1 minute at 131°C. This is expressed as lethality (L) that is the number of minutes at a reference temperature that would have the same sterilizing effect as one minute at experimental temperature. So the higher F<sub>0</sub> value indicates greater heat treatment to obtain sterilization and higher Z value indicates filter slope of TDT curve and it becomes more difficult to kill the organism.

### 27.5 Q<sub>10</sub> -Value

It refers to an increase in the kinetics of reaction (faster reaction takes places) when the temperature is increased by 10°C.

$$Q_{10} = \frac{\text{Rate of reaction at } T^{\circ}\text{C} + 10^{\circ}\text{C}}{\text{Rate of reaction at } T^{\circ}\text{C}}$$

$$Z (^{\circ}\text{C}) = \frac{10}{\log Q_{10}}$$

### Q<sub>10</sub> Values

Chemical reactions: 2 - 4

Inactivation of microorganisms: 10 and 30

<b>Q<sub>10</sub> Values</b>	<b>Process</b>
1.8 – 4	Chemical reactions (Maillard)
8 – 12	Reduction in the number of spores
10 – 20	Destruction of microorganisms
10 – 100	Denaturation of protein

Temperature range of 120 – 160°C:

Q<sub>10</sub> value for Bacillus stearothermophilus ----- 13.2

Q<sub>10</sub> value for Maillard reaction ----- 3.6

$$\text{Sterilizing effect} = \log \frac{(\text{Initial concentration of spores})}{(\text{Final concentration of spores})}$$

Spores of Bacillus subtilis and Bacillus stearothermophilus are most common and the most resistant mesophilic and thermophilic species in milk likely to survive processing. In the 110-125°C range, the rate of spore destruction of Bacillus stearothermophilus increases about 11 times for each 10°C rise in temperature, i.e. Q<sub>10</sub> = 11. Other Bacillus spores, such as Bacillus subtilis are more sensitive (Q<sub>10</sub>=30). In the range of 95 - 120°C, the Q<sub>10</sub> browning is 3. In the plot of the ratio of bactericidal (sporicidal) effect to browning effect versus temperature, the ratio does not change much until the temperature reaches about 135°C. At 140 and 150°C, the bactericidal effects are about 1,500 and 5,000 times greater, respectively. Therefore, if milk is treated in the UHT range of 135 - 150°C for a few seconds, it is possible to obtain a product virtually free from spores and with minimal browning. The color of this product is similar to that of HTST milk. Likewise these values for enzymes, nutrients and food quality are much smaller compared to that required for bactericidal effect.

**Thermal Destruction Data**

<b>Factor</b>	<b>D (121°C)</b>	<b>Z (°C)</b>
Colour compound	10 – 20	20 – 60
Vitamins	120 – 1200	25 – 45
Enzymes	1 – 5	6 – 60
Microbial spores	0.2 – 4	6 – 12
Heat resistant strains	0.5	6 – 12
Food quality	5 – 500	8 – 18

The results demonstrate that the range of time – temperature combinations used for UHT milk (130-150°C) are located in areas combining optimal conditions for inactivation of microorganisms with the lowest possible influence on the physical and chemical properties of milk.

The higher the processing temperature, the shorter is the time needed for effective sterilization. The relationship between the time and temperature to have effective sterilization is shown below (Fig 27.1):

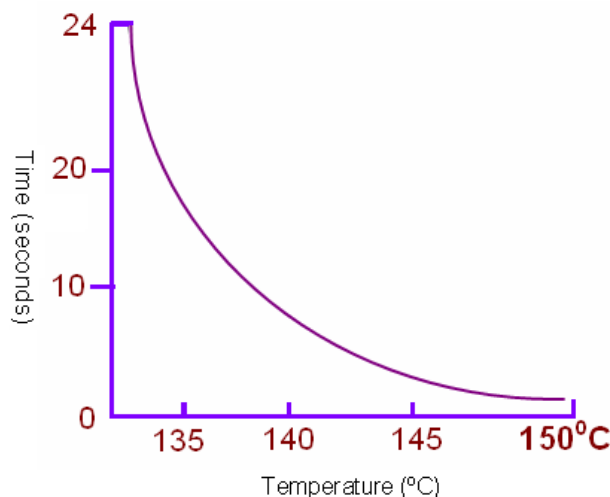

**Fig. 27.1 Time-temperature combination for effective sterilization**

Over the whole of this temperature range, the time required is short, of the order of a few seconds and cannot possibly be obtained with any in-container sterilizing process. This means that the process must be performed in a continuous flow heat exchanger. The holding time is fixed by the volume of holding tube. The mean flow time will be given by the volume of the tube divided by the flow rate of product passing through it.

\*\*\*\*\* 😊 \*\*\*\*\*



**Lesson 28**  
**PRINCIPLE AND METHODS OF PASTEURIZATION**

**28.1 Introduction**

The word pasteurization is derived from the name of an eminent French scientist Louis Pasteur (1860), who found that heating certain liquids specially wines to a high temperature improved their keeping quality. Pasteurization came into use on a commercial scale in the dairy industry shortly after 1880 in Germany and Denmark. This process is widely employed in all branches of dairy industry. Heat treatment destroys microorganisms present in milk. Further, a more or less complete inactivation of enzymes occurs, depending on temperature and treatment time. In order to retain as many sensory and nutritive properties of the raw materials as possible, different heating methods have been developed to destroy pathogenic organisms (pasteurization) or destroy all microorganisms and inactivate enzymes (sterilization).

**28.2 Definition**

According to International Dairy Federation (IDF), pasteurization can be defined as 'a process applied to a product with the object of minimizing possible health hazards arising from pathogenic microorganisms associated with milk by heat treatment, which is consistent with minimal chemical, physical and sensory changes in the product'.

In general, the term pasteurization as applied to market milk refers to the process of heating every particle of milk to at least 63°C for 30 min or 72°C for 15s or to any temperature-time combination which is equally efficient, in a properly operated equipment. After pasteurization, the milk is immediately cooled to 5°C or below.

**28.3 Importance of Pasteurization**

- To render milk safe for human consumption by destroying all the pathogenic microorganisms.
- To improve the keeping quality of milk by killing almost all spoilage organisms (88-99%).

**28.4 Drawbacks of Pasteurization**

- It may encourage slackening of efforts for hygienic milk production and may mask low quality milk.
- It diminishes the cream line or cream volume.
- Pasteurized milk may increase the renneting time.
- It fails to destroy bacterial toxins
- In India, pasteurization is not necessary as milk is invariably boiled on receipt by the consumer

**28.5 Time-Temperature Combination for Specific Requirements**

All pathogenic organisms are destroyed by pasteurization, except spore forming organisms. The thermal death point of tuberculosis germs (*Mycobacterium tuberculosis*) is slightly higher than

that for inactivation of phosphatase enzyme. Pasteurization is carried out at a heat treatment temperature above that for phosphatase inactivation and yet below that for cream line reduction. The pasteurization ensures complete destruction of pathogens, a negative alkaline phosphatase test and least damage to the cream line which is shown in the table below:

**Table 28.1 Time and temperature for specific purposes**

Purpose	Temp. to be kept for 30 minutes	Temp. to be kept for 15 seconds
To kill tubercle bacilli	58.9°C	70.0°C
To destroy phosphatase	61.1°C	71.1°C
Pasteurization requirements	61.7°C	71.7°C
Cream line reduced	62.2°C	72.2°C

## 28.6 Methods of Pasteurization

### 28.6.1 Low-temperature long-time (LTLT)/Batch pasteurization

Milk is heated, held and cooled in the inner vessel. The space between vessel and the outer casing forms a jacket, through which the heating or cooling medium is circulated. To heat the milk, hot water or low-pressure steam is circulated through the jacket and milk is continuously agitated for rapid and uniform heating. The heating process could be manually or automatically controlled. The milk is heated to a minimum of 62.7°C and held at this temperature for minimum 30 min. It is then cooled as rapidly as possible to 4°C. A cooling medium is circulated in the jacket for chilling the milk, but more often the heated milk is discharged to a surface cooler where a film of milk flows down the corrugated metal plates or series of interlocked tubes. A cooling medium such as brine or chilled water is circulated on the other side of the plates or through the tubes (Fig.28.1).

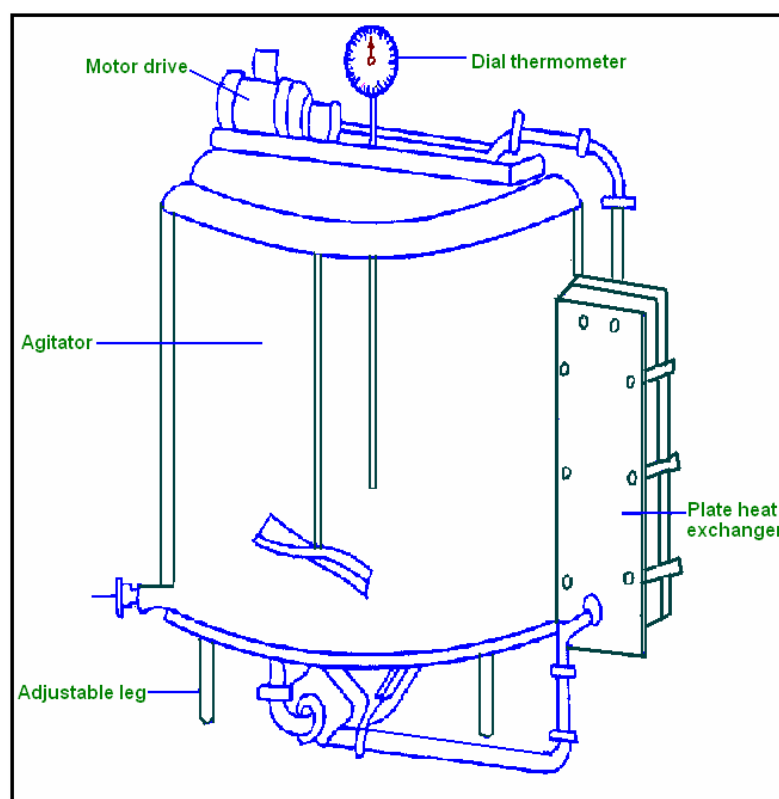

**Fig. 28.1 Multipurpose vat with inner view**

The LTLT pasteurizer may be of three types:

### 28.6.1.1 Water - jacketed vat

This is double-walled around the sides and bottom of the vat in which hot water or steam under partial vacuum circulates for heating, and cold water for cooling. The outer wall (lining) is usually insulated to reduce heat loss. The heat-exchange takes place through the wall of the inner lining. The difference between temperature of the hot water and the milk is kept to a minimum. The milk is agitated by slowly revolving paddles/propellers. When heating, the vat cover is left open for escape of off-flavors; and when holding, the cover is closed. During the holding period, an air space/foam heater (steam or electrically heated) prevents surface cooling of milk.

Advantage: Flexibility in usage - multipurpose vat.

### 28.6.1.2 Water-spray type

A film of water is sprayed from a perforated pipe over the surface of the tank holding the product which is continuously agitated. A rapidly moving continuous film of water provides rapid heat transfer.

### 28.6.1.3 Coil-vat type

The heating/cooling medium is pumped through a coil placed in either a horizontal or vertical position, while the coil is turned through the product. The turning coil agitates the product (but additional agitation may be necessary).

Disadvantage: Coils are difficult to clean.

## 28.7 High-temperature short-time (HTST) pasteurization

This was first developed by A.P.V. Co. in the United Kingdom in 1922. It is the modern method of pasteurizing milk and is invariably used where large volumes of milk are handled. The HTST pasteurizer gives a continuous flow of milk which is heated to 72°C for 15s and then promptly cooled to 5°C or below.

### 28.7.1 Advantages

1. Capacity to heat treat milk quickly and adequately, while maintaining rigid quality control over both the raw and finished product
2. Less floor space required
3. Lower initial cost
4. Milk packaging can start as soon as milk is pasteurized
5. Easily cleaned and sanitized (system adapts itself to CIP)
6. Lower operating cost (due to regeneration system)
7. Reduced milk losses
8. Development of thermophiles is not a problem
9. Automatic precision controls ensure proper pasteurization.

### 28.7.2 Disadvantages

1. The system is not well-adapted to handling small quantities of liquid milk products
2. Gaskets require constant attention for possible damage and lack of sanitation
3. Complete drainage is not possible (without losses exceeding those from the holder system)

4. Margin of safety in product sanitary control are so narrow that automatic control precision instruments are required in its operation
5. Lethal effect on high-thermoduric bacteria in raw milk is not as great as compared to LTLT system
6. Accumulation of milk-stone in the heating section.

### 28.7.3 Milk flow

The following steps or stages are involved as milk passes through the HTST pasteurizer:

1. Balance tank
2. Pump
3. Regenerative heating
4. Heating
5. Holding
6. Flow diversion valve (FDV)
7. Regenerative cooling
8. Cooling by chilled water or brine.

An arrangement for incorporation of the filter/clarifier, homogenizer, etc., in the circuit is also made possible. There is some variation in the use or order of these steps in different milk processing plants.

### 28.7.4 Functions of specific parts

#### 28.7.4.1 *Float-controlled balance tank (FCBT)*

Maintains a constant head of the milk for feeding the raw milk pump; also receives milk diverted by FDV (if at all diverted).

#### 28.7.4.2 *Pump*

Either a rotary positive pump between the regeneration and heating sections (USA), or a centrifugal pump with a flow control device to ensure constant output, after FCBT (UK and Europe) is used.

#### 28.7.4.3 *Plates*

The Plate Heat Exchanger (PHE) (also called Paraflow) is commonly used in the HTST system. The PHE is a compact, easily cleaned unit. Its plates may be used for heating, cooling and regeneration. These plates are supported in a press between a terminal block in each heating and cooling sections. The heat moves from a hot to a cold medium through stainless steel plates. A space of approximately 3 mm is maintained between the plates by a non-absorbent rubber gasket or seal which can be vulcanized to them. The plates are numbered and must be properly assembled. They are tightened into place, and designed to provide a uniform, but somewhat turbulent flow for rapid heat transfer. Raised sections (corrugations) on the plates in the form of knobs, diamonds and channels, help provide the turbulent action. Greater capacity is secured by adding more plates. Ports are provided in appropriate places, both at the top and bottom of the plates, to permit both the product and the heating/cooling medium to flow without mixing.

## **28.7.4.4 Filter**

Filter units are connected directly to the HTST system, placed after the pre-heater or regenerative (heating) section. These units, using 40-90 nylon mesh cloth are usually cylindrical in shape. Usually two filters are attached; when one is being used, other can be subjected to cleaning. This permits continuous operation.

## **28.7.4.5 Regeneration**

The raw chilled incoming milk is partially and indirectly heated by the heated outgoing milk (milk-to-milk regeneration). This adds to the economy of the HTST process, as the incoming milk requires less heating by hot water to raise its temperature to pasteurization temperature in the heating section.

## **28.7.4.6 Heating**

The preheated milk from regeneration section passes through heating section of HTST, where it is heated to 72°C or more with the help of hot water from hot well. Thereafter, the heated milk enters into the holding section (plates/tube).

## **28.7.4.7 Holding**

The holding tube ensures that the milk is held for a specified time, not less than 15s., at the pasteurization temperature of 72°C or more.

## **28.7.4.8 Flow diversion valve (FDV)**

This routes the milk after holding section. If the milk is properly pasteurized, it flows forward through the unit. In case the milk is not heated to the set heating temperature, it is automatically diverted by the FDV back to the Float Controlled Balance Tank (FCBT) for reprocessing. It is usually operated by air pressure working against a strong spring. If the temperature of heated milk falls below set temperature, air pressure is released and the valve snaps shut immediately. When the temperature is regained, air pressure builds up and the valve opens up for the forward flow to occur. The system is so arranged that any failure of electricity moves the valve in the diverted position.

## **28.7.4.9 Regeneration (cooling)**

The pasteurized hot outgoing milk is partially and indirectly cooled by the incoming cold milk (milk-to-milk regeneration). This again adds to the economy of the HTST process. In fact, when pre-cooled (raw) milk is received, regeneration efficiency is 90% and above which obviates cooling using well water altogether.

## **28.7.4.10 Control panel**

Contains instruments, controls, FDV-mechanism and holding system, all centralized in one moisture-proof panel. The lower half of the panel forms an air-insulated chamber which carries the holding tube.

**28.7.4.11 Automatic control devices**

These include (a) steam pressure controller, (b) water temperature controller and (c) milk temperature recorder.

**28.7.4.12 Steam pressure controller**

Maintains a constant hot water temperature for heating milk accurately to the required pasteurization temperature. It acts as a reducing valve in the steam supply line to give a constant steam pressure.

**28.7.4.13 Water temperature controller**

Regulates the amount of steam entering the hot water circulating system.

**28.7.4.14 Milk temperature recorder**

Records the temperature of milk leaving the holding tube/plate. This is an electric contact instrument that operates either a FDV or a milk pump, automatically preventing milk from leaving the holding section at temperatures below the one set in the control panel. Both the frequency and duration of the flow diversion (if at all) and the temperature of milk leaving the heating section are recorded in the thermograph (recording chart) by means of two different colored pens.

**28.7.4.15 Hot water**

Circulates hot water through the heating section of the machine to maintain the correct milk heating temperature within very fine limits.

**28.7.4.16 Pressure in the system**

The normal pressures maintained in the HTST system are:

**Table 28.2 Normal Pressure maintained in the HTST System**

Pasteurized milk	15 psi
Raw milk	14 psi
Heating/cooling medium	12 to 13 psi

**28.8 Testing of Holding Time**

The holding time is calculated between the points at which the heated milk leaves the heating section and reaches the FDV. The efficiency of pasteurization in the HTST system depends on attaining the requisite temperature along with the desired holding time. Hence, the latter should be checked periodically. Several methods are used for determining the holding time, viz. the electrical conductivity method (of a salt solution); the dye injection method; the electronic timer method; etc. The requirements for heat treatment and modifications which can occur in milk, time-temperature profiles have been established for heat treatment processes.

### 28.9 Devices for Controlling the Heat Treatment Process

1. Automatic temperature control and recording devices.
2. Automatic safety device to avoid insufficient heating of the milk (bypass installation) with recording device for time/temperature and valve position for the flow, as well as passage and recirculation of the milk or cleaning.
3. Safety device with automatic recording against unplanned blending of pasteurized or sterilized milk with non-heated milk based on pressure increase after the heating or holding section of the heat exchanger.

The most widely used installation for the heat treatment of milk is plate heat exchanger. For reason related to the flow conditions, tubular heat exchangers are used when operating at temperature level  $>100^{\circ}\text{C}$ .

For Agriculture related Books, News,  
Recruitment, Information and Events etc Visit  
at  
[www.AgrMoon.Com](http://www.AgrMoon.Com)

## Lesson 29 HEAT EXCHANGERS - PLATE AND TUBULAR TYPE

### 29.1 Introduction

The plate heat exchanger has found wide application in pasteurization and sterilization. It consists of a series of plates, terminals between the plates and a head terminal on to which the plates are pressed with the end terminal. For installation, cleaning and changing of plate rubbers, the plates and intermediate terminals can easily be moved backwards and forwards on carrying bars in a frame. Liquids can be passed in and out of the plant via the intermediate, head and end terminals. The liquid can flow alternately with a colder or warmer medium through the plates in such a manner that one plate occurs in zones close to walls because of low rates of flow.

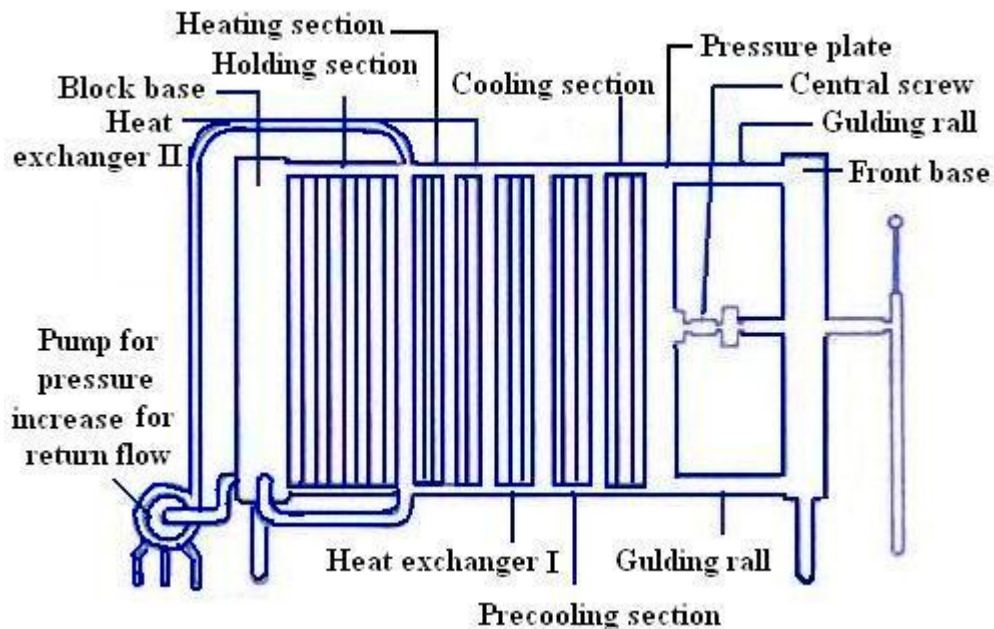

Fig. 29.1 Plate Heat exchanger for short time heating of milk

### 29.2 Design and Operating Principle of a Plate Heat Exchanger

The configuration of the individual sections of a plate heat exchanger is shown in the figure (Fig.29.1). Several heat exchange plates are assembled and are installed section wise in a frame. In many cases, plate heat exchangers for short-time heating have no holding section, but they have a tubular holding pipe besides the plate heat exchanger. This makes it possible to keep plate heat exchanger very small and space efficient. Ultra-high heat treatment plate heat exchangers are designed in a modular form.

### 29.3 Heat Exchanger Plates

Heat exchanger plates (Fig. 29.2) are made from stainless steel and have a heating surface of 0.2-0.4 m<sup>2</sup>. A relatively large surface, considering the overall dimensions, is achieved by the fishbone-like pressed surface pattern. At the same time, very good turbulence is achieved between the plates (Fig. 29.3), thus creating nearly identical heat transfer conditions for all product particles,



and a different thermal load is excluded. Close to the passage openings and between the distances, holders are shaped into the plates, which maintain a uniform distance between the plates. Additional longitudinal-shaped cams in the area of the inlet serve for good product distribution over the entire surface of the plate.

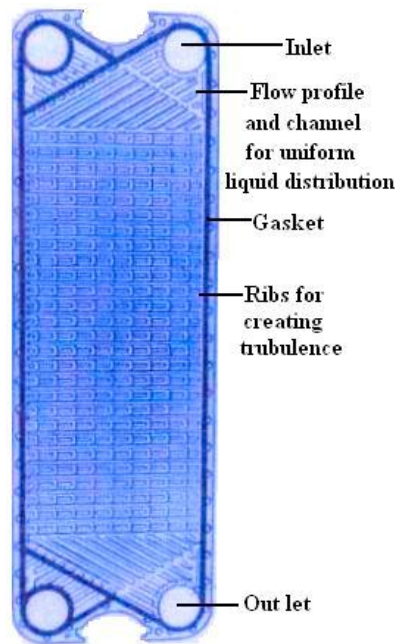

**Fig. 29.2 Heat exchanger plate**



**Fig. 29.3 Turbulence between plates**

Sealing the flows from each other and from the outside is done on the periphery of the plates and around the inlet/outlet openings with profiled gaskets, which are glued into the correspondingly shaped grooves. Further the plates are set up for hydrodynamic reasons in such a way that the inlet and outlet for the media are on the same side of the plate. This means that the inflow of the medium is on one side and the outflow is on the other side, resulting in simplified piping connections and reduced assembly costs. In each section, wherever there is heat transfer, one medium enters through the inflow and a second exits into the return flow.

In order to have a uniform fluid velocity between the plates and fluid distribution over the entire plate surface, the fluid velocity of the media must be 20 – 25 m/s. This fluid velocity depends among other things, on the flow rate and pressure drop. As the pressure drop decreases with longer distance, considerable pressure differences can be observed between the inflow and the outflow.

### 29.4 Connecting Plates

They are installed between the plate assemblies of the individual sections and separate them from each other. Connecting points, which can be replaced in most cases, permit the connection to other installations (Fig. 29.4 and 29.5).

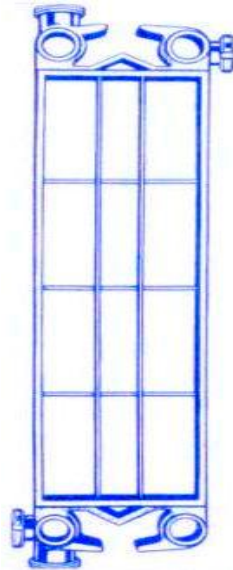

Fig. 29.4 Connecting plate

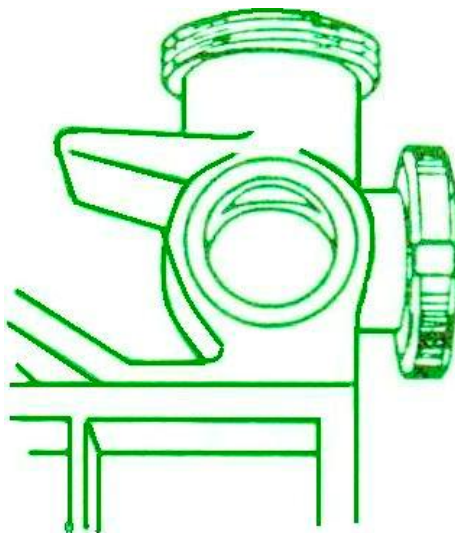

Fig. 29.5 Connecting corner

#### 29.4.1 Flow patterns and circuits

A flow is formed between two plates of a plate assembly. By sequencing the various plates, flow patterns and stages are established in a section. Parallel flow patterns form one stage. The stages are installed in series in a section. The number of parallel flows per stage and the serial stages are chosen according to circumstances; the heating and holding section should not be modified by the operator. A simple flow pattern is shown in figure (Fig. 29.6).

### 29.5 Heating in a Plate Heat Exchanger

Heating is done with either steam or hot water, which is made by using steam. Constant pressure and temperature conditions in the steam supply pipes are the basis for a non interrupted process. The choice of a correctly calculated pipe diameter of the steam pipe lines and effective pressure control are the basis for constant conditions. For heating purposes, saturated steam (no superheated steam) is used, which should have the quality of a wet steam (2-8% water content). Pressure should be 0.96 to 1.96 bar.

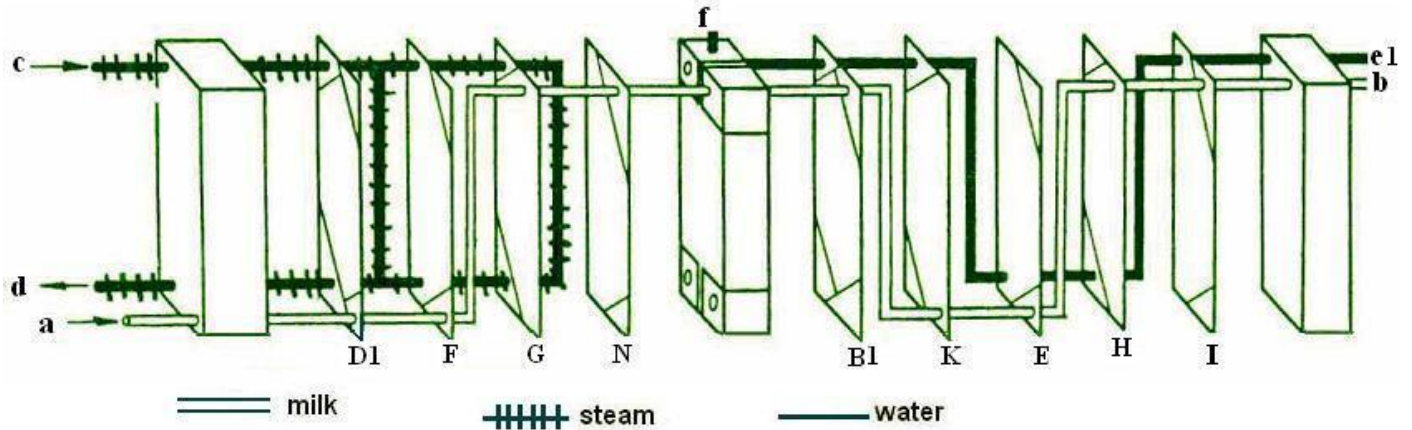

Fig. 29.6 Heat exchange and flow directions in heat exchanger

a) Milk inlet, right side b) Milk outlet, right side c) Steam inlet, left side d) Condensate outlet, left side e) Water inlet, left side f) Water outlet left top 01, F, G and so on indicate the plates, 1...4 and 5 ... 9 the number of plates.

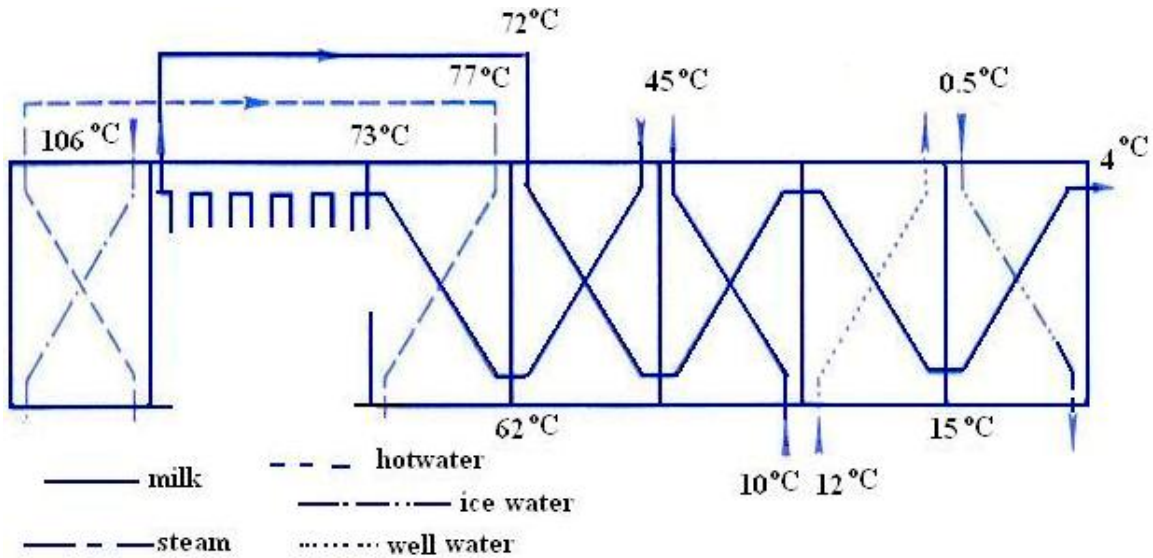
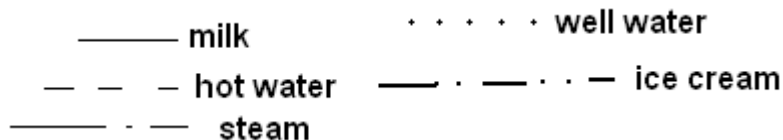

Fig. 29.7 Heat supply to a plate heat exchanger for short time heat treatment



Heat supply to a plate heat exchanger for short-time heat treatment

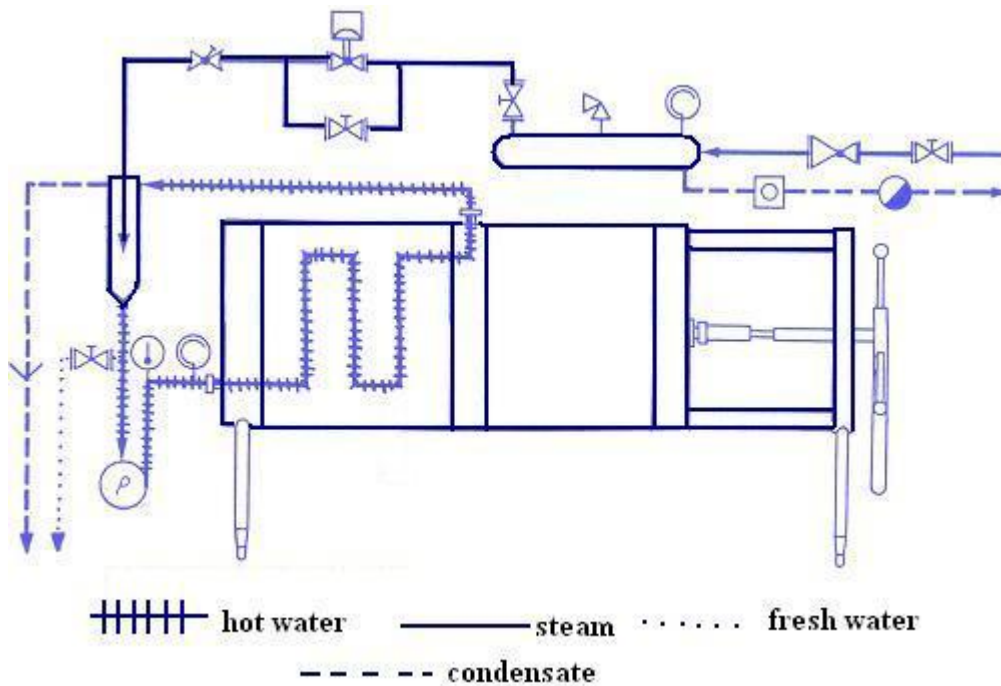

Fig. 29.8 Heat supply to a plate heat exchanger for short-time heat treatment

1. Steam distribution
2. Mixing battery
3. Plate heat exchanger

Steam injection is used in plate heat exchangers both for the high-heat process and for heating cream. Due to the relatively wide differences between the steam temperature and the product temperature as well as the high steam temperatures ( $> 100^{\circ}\text{C}$ ), the risk of burning milk is high and therefore enhanced depositions in the heating section must be considered (Fig 29.7). Short-time heating and thermization use hot water, which can be obtained in three different ways:

1. In a separate section of the plate heat exchanger
2. In a mixing nozzle
3. In a hot water battery

The flow in figure (Fig. 29.8) shows that the pressure-reduced steam passes through a membrane valve into the hot water mixing battery, where it is mixed with water. The membrane valve controls the steam quantity as a function of the set temperature and the valve is actuated pneumatically, adjusting the hot water temperature accordingly. The steam distributor can be eliminated if wet steam can be supplied directly from the steam boiler, as wet steam cools down along its way in the steam pipes. Steam is dried by pressure reduction; it does not superheat.

### 29.6 Tubular Heat Exchangers

In tubular heat exchangers, milk products flow through tubes which are heated or cooled externally (Fig 29.9 and 29.10). The flow can be more easily controlled in the case of single tube than in a bundle of tubes. The advantage of a bundle of tubes is that larger heat exchange surface can be fitted economically into a smaller space. The spirally arranged single tube tubular heater, consisting of coaxial double tubes saves space and can be used for sterilizing milk. The milk can pass through the following stages in a continuous stream:

Preheating by means of the return flow of milk through the annular space. Heating with hot water or steam. Holding at pasteurizing or sterilizing temperature. Cooling by giving up heat to the incoming milk. Cooling with chilled water or brine.

A separator is often inserted between the preheater and the heater and a homogenizer before or after the heater.

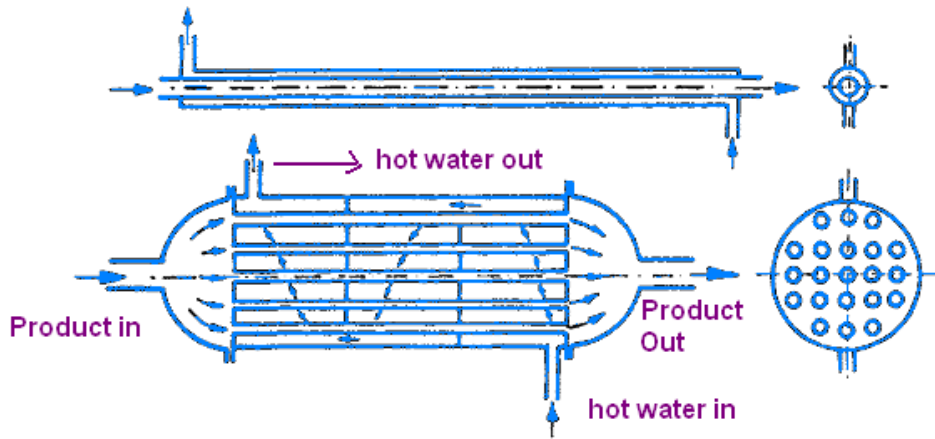

Fig. 29.9 Tubular heat exchanger

The fact that tubular heat exchanger can only be cleaned by flow through methods (usually 1% HNO<sub>3</sub> and 1% NaOH,) is a disadvantage. Deposits on the heating surfaces cannot be seen and are hardly removable by mechanical means.

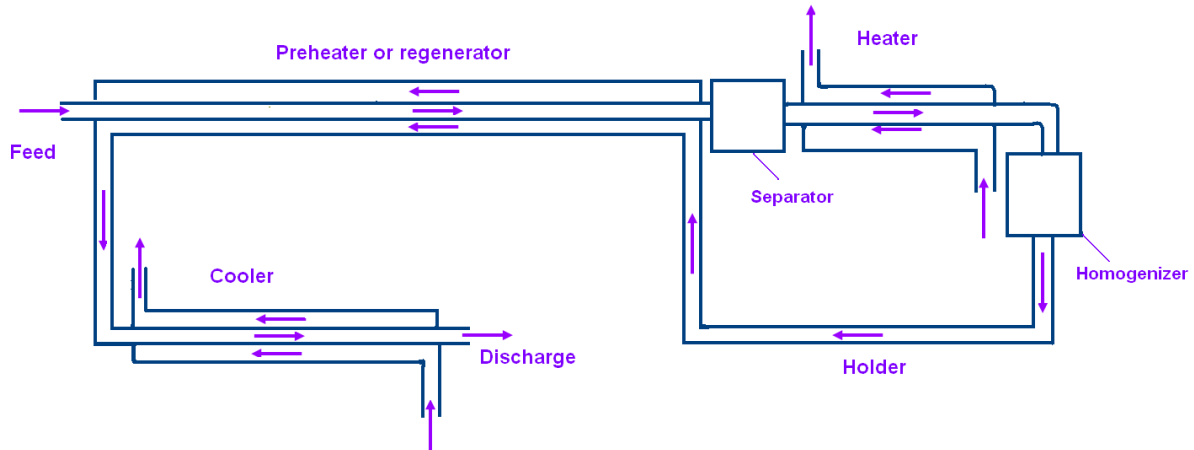

Fig. 29.10 Heating plant with tubular heater

With this type of heat exchanger it is, however, possible to work at high pressures which are of advantage when high temperatures are to be used. Sealing problems do not arise.

Lesson 30  
WORKING OF HTST PASTEURIZER

30.1 Introduction

HTST method is also called 'continuous flow' or 'flash' pasteurization. It is modern method of milk pasteurization and is invariably used where large volume of milk is handled. This system gives a continuous flow of milk, which is heated to 72°C for 15s and promptly cooled to 5°C or below.

30.2 Operation of HTST Pasteurizer

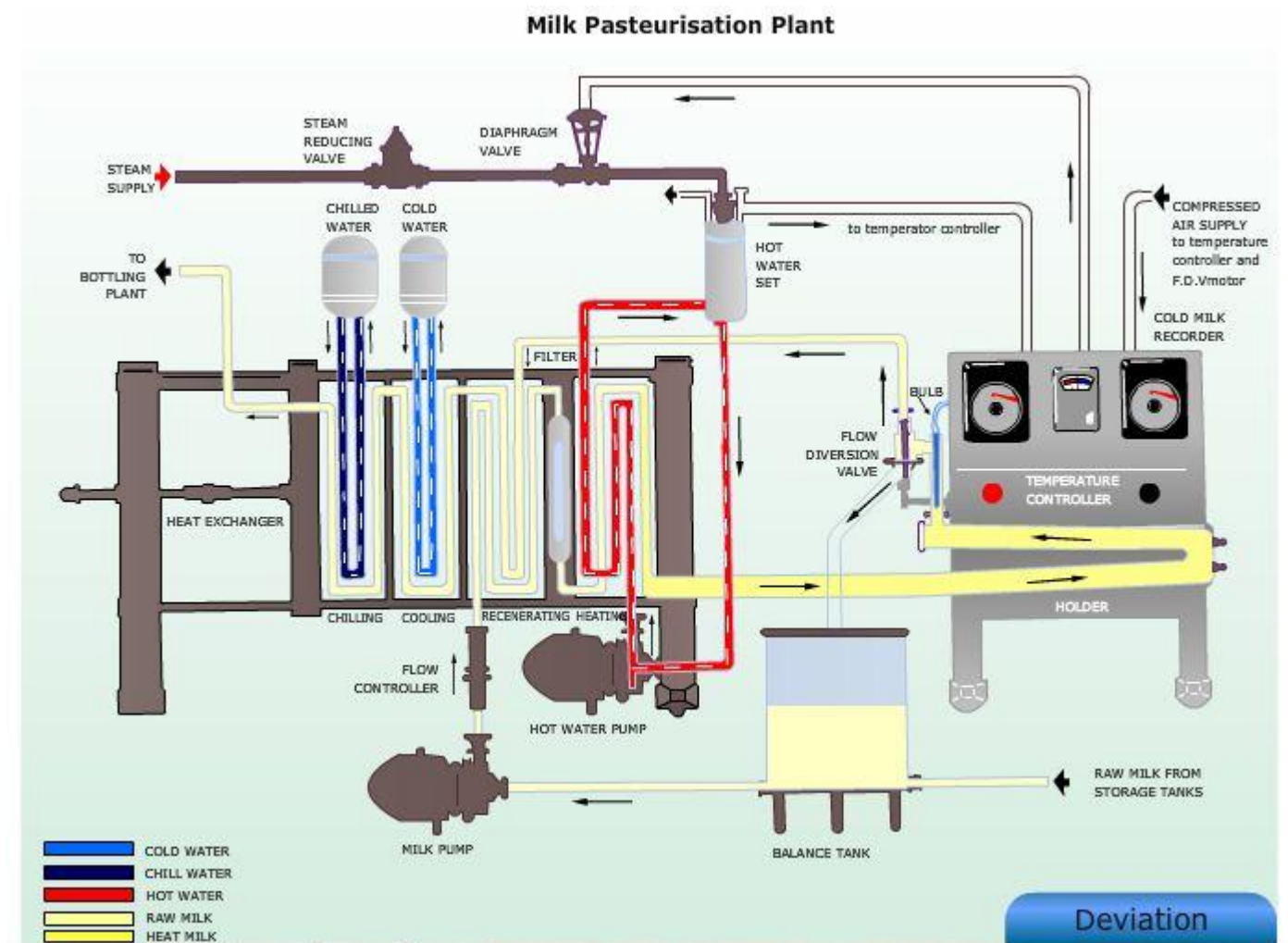

Fig. 30.1 Milk pasteurizer plant

30.2.1 Initial preparation

1. The plant must be sterilized.
2. All water remaining in the plant must be drained.
3. Clean filter clothes/nylon filters should be fitted in the filter.

30.2.2 Steps for starting the pasteurizer

1. Start the air compressor.
2. Switch on the control panel mains.
3. Fill the hot water tank, start the hot water pump and inspect the tank after 2-3 min for the level.
4. Open the air vents.
5. Start flow of the milk to the float controlled balance tank by starting milk pump.
6. Close the air vents when the milk comes out from them.
7. Set the temperature controller at pasteurization temperature (minimum 71.7°C) and adjust the air reducing valve so that the supply gauge registers 1.76 kg/cm<sup>2</sup> pressure.
8. Turn on the steam to the hot water system via 'solenoid valve' for controlling steam passage into the heater.
9. Turn on the chilled water/brine as soon as forward flow takes place. Once the chilling temperature is reached, the plant will set itself to forward flow.

Note: The diluted milk that comes out first should not be collected in the balance tank.

### 30.2.3 Steps for shutting down the plant

1. Ensure availability of sufficient water in the storage tank (approximately, equal to the capacity of the plant).
2. As the last milk leaves the balance tank, tip in the water from the tank.
3. When the last portion of water leaves the balance tank, turn the 3-way valve at the finished milk outlet so that the flow is diverted to the floor.
4. Place a hose in the balance tank and flush the plant thoroughly with water until the discharge from outlet becomes clear.
5. Turn off the chilled water in the cooling sections.
6. Shut off the steam supply.
7. Admit cold water to the hot water tank and run until the plant is cold.
8. Stop the milk and hot water pumps.
9. Turn off the air supply and the main electric switch at the panel.

### 30.3 Maintenance of Milk Pasteurizers

1. The pasteurizer should be inspected every day for any leakage and for ensuring cleanliness.
2. The filter cloth or filter bag must be changed at regular intervals.
3. Periodical inspection of individual plate surface and gaskets must be done when the pasteurizer is dismantled for manual cleaning.
4. Any loose or broken gasket must be replaced, using proper adhesive.
5. The face of the plate bar and the tightening spindle should be kept lightly coated with grease.
6. All air-operated equipment should be supplied with clean dry air.
7. All recording instruments, thermometers etc. must be checked for accuracy, periodically.

### 30.4 Efficiency of Pasteurization

Alkaline Phosphatase test is carried out to determine whether milk has been properly pasteurized or not. The test is based on the detection of the activity of enzyme phosphatase, which is present in raw milk, but is completely inactivated at the temperature-time adopted for efficient pasteurization. Enzyme phosphatase is more resistant than the most heat-tolerant vegetative pathogenic bacteria.

When milk containing phosphatase (in active form – raw or underpasteurized) is incubated with, p-nitro phenyl disodium ortho phosphate, it hydrolyses the substrate liberating para-nitro phenol

which gives yellow colour under alkaline conditions of the test. The intensity of the yellow color present is directly proportional to the activity of phosphate present in the milk. The presence of yellow color indicates inefficient pasteurization or post-pasteurization contamination with raw milk. Such mixing of raw and pasteurized milk can take place in the regeneration section of HTST pasteurizer.

### 30.5 Vacuum Pasteurization

The process of heat treatment under vacuum in stainless steel chamber is known as Vacreation. Machine used for vacuum pasteurization is known as Vacreator, which is the registered trademark of M/s. Murray Deodorizers Ltd., New Zealand

### 30.6 Purpose of Vacuum Pasteurization

1. To kill bacteria including pathogens.
2. Inactivate enzymes.
3. Remove undesirable odours and flavours
4. Remove oxygen

#### 30.6.1 Use of vacreator

This equipment is generally used for vacuum treatment of milk or cream. It was mainly developed for treatment of aged and sour cream meant for butter making. It is an effective means of removing off-flavors particularly due to feed.

#### 30.6.2 Principle of vacuum pasteurization

Principle of vacreation is mixing milk/cream with steam under pressure and immediately followed by sudden and spontaneous expansion into a finely divided state with a chamber maintained at reduced pressure. This process effects separation of off-flavors along with water vapor due to sudden transition from a compressed state to the expanded state. At the same time, instantaneous cooling effect of the product is an important factor in preserving the desirable characteristics of the product, even when high temperature is adopted.

#### 30.6.3 Constructional and operational details

The vacreator consists of three or five stainless steel vessels connected to one another for steam heating and vacuum treatment with continuous product flow (Fig. 30.1). The first chamber is the pasteurizing chamber. This chamber is operated under vacuum (10-23 cm Hg) which maintains a corresponding temperature of 90-96°C. The cream or milk is admitted at the top through a spray pass and falls in a fine shower through expanded steam. Dry saturated steam is passed from the top along with milk or cream. Then, the product and some free steam are passed from the bottom of this chamber to the top of the second chamber. It enters this chamber tangentially and spirals in a thin film to the bottom.

The temperature of this chamber is maintained at 82 - 71°C under a vacuum of 37-50 cm Hg. Under the influence of high vacuum, the product releases a part of the steam as water vapor, which was condensed into it in the pasteurizing chamber. By controlling the amount of steam used, steam distillation occurs. The effect of steam distillation at this stage is to accelerate evaporation and remove undesirable flavor substances. The vapor resulting from evaporation and steam distillation passes over into the condenser, carrying with it volatile off-flavors. From the



second chamber, the product is drawn into the third chamber maintained under still higher vacuum through a second uptake pipe. The product temperature in this chamber is between 38-46°C by maintaining a vacuum of 70-67 cm Hg. In this chamber, remaining water and off-flavor are removed, upon reaching the bottom of the third chamber, the product is discharged by means of a multi-stage centrifugal pump.

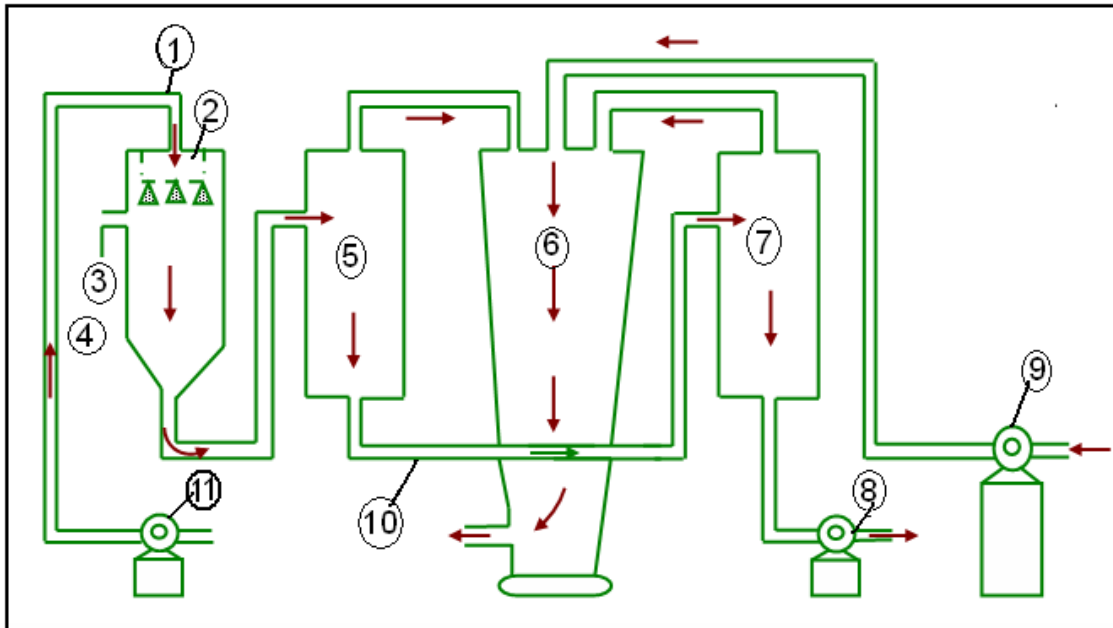

1. Feed in pipe 2. Perforated pan 3. Dry saturated Steam 4. Pasteurizing Chamber  
5. Second Chamber 6. Vapour Condensor 7. Third Chamber 8. Multistage discharge pump 9. Water pump 10. Uptake pipe 11. Feed pump

Fig. 30.2 Vacreator or vacuum pasteurizer

\*\*\*\*\* 😊 \*\*\*\*\*

**Lesson 31**  
**STERILIZATION - DEFINITION, PURPOSE AND METHODS**

**31.1 Introduction**

According to Food Safety and Standards Rules-2011, the term 'sterilization' when used in association with milk, means heating milk in sealed container continuously to a temperature of either 115°C for 15 min or at least 130°C for a period of one second or more in a continuous flow and then packed under aseptic condition in hermetically sealed containers to ensure preservation at room temperature for a period not less than 15 days from the date of manufacture.

Ultra-high temperature processing has been designed to give a commercially sterile product which is free from pathogens and provides little chance of spoilage during transportation and storage under recommended conditions. In contrast to pasteurized milk which may or may not be homogenized, it is essential to homogenize UHT milk so as to prevent formation of a cream plug during extended storage. Various systems exist for the production of UHT milks, each using a different method of heat transfer.

**31.2 Definition**

Sterilized milk may be defined as (homogenized) milk which has been heated to a temperature of 100°C or above for such lengths of time that it remains fit for human consumption for at least 7 days at room temperatures.

Commercially sterilized milk is rarely sterile in the strict bacteriological sense. This is because the requirements for complete sterility conflicts with the consumer's preference for normal color and flavor in the product. The spore-forming bacteria in raw milk, which are highly heat-resistant, survive the sterilization temperature-time employed in the dairy and ultimately lead to the deterioration of sterilized milk.

**31.3 Requirements**

Sterilized milk must:

- i). Keep without deterioration, i.e., remain stable and be of good commercial value for a sufficient period to satisfy commercial requirements;
- ii). UHT processing can be applied to those milk and milk product which can also be processed using HTST process.
- iii). Be free of microorganisms harmful to consumer health, i.e., pathogenic, toxicogenic germs and toxins;
- iv). Be free of any microorganisms liable to proliferate, i.e. it should not show signs of bacterial growth.

## 31.4 Method of In-bottle Sterilization

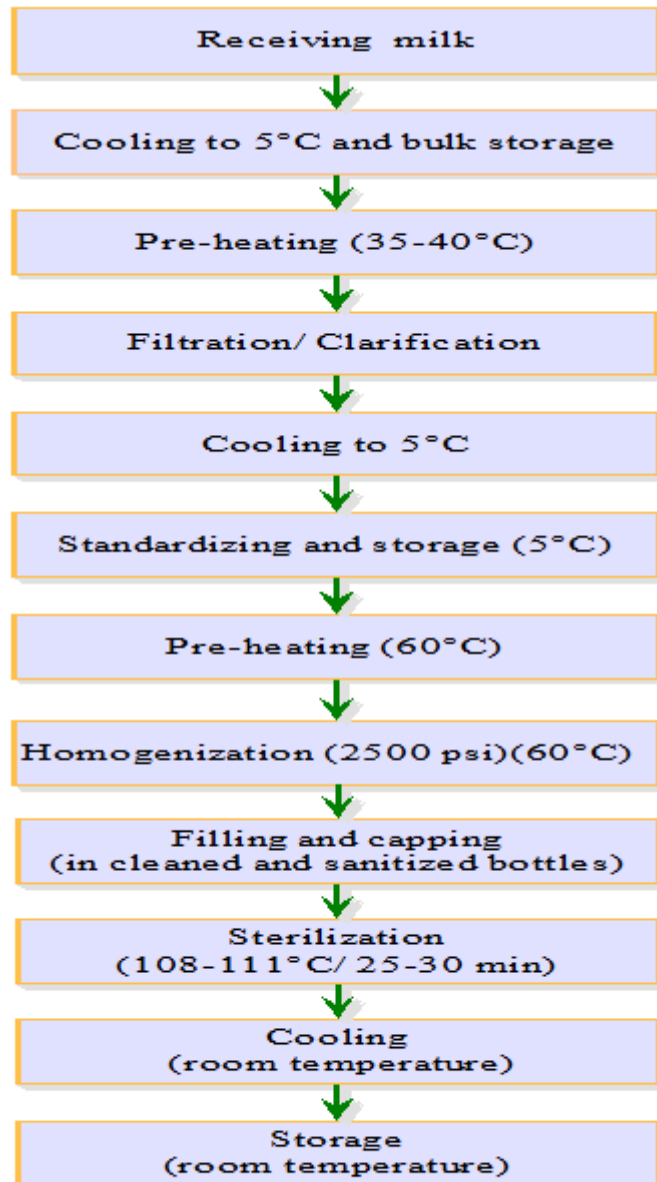

**Fig.31.1 In-bottle sterilization**

The raw milk, on receipt, should be strictly examined by the prescribed physico-chemical and bacteriological tests and only high-quality milk should be used for production of sterilized milk. Care should be taken to accept milk supplies which have no developed acidity and which contain the least number of spore-forming bacteria. The intake milk should be promptly cooled to 5°C for bulk storage in order to check any bacterial growth. Next, it should be pre-heated to 35-40°C for efficient filtration/clarification, so as to remove visible dirt, foreign matters etc., and to increase its aesthetic quality. The milk should again be cooled to 5°C so as to preserve its quality. It should then be standardized to the prescribed percentages of fat and SNF content in order to conform to the legal standards (which may vary from State to State for both cow and buffalo milk). It must be stored at 5°C until processing. The milk should be promptly pre-heated to 60°C for efficient homogenization to prevent any subsequent formation of a cream layer; usually single-stage homogenization is carried out at 2500 psi pressure. The homogenized milk must be clarified so as to remove the sediment formed during the homogenization process. The hot milk from the homogenizer should be filled into the (hot) cleaned and sanitized bottles coming from the bottle

washing machine and then sealed with special caps (of the crown seal type). The filled and capped bottles should then be placed in metal crates for sterilization by the Batch Process, or fed into conveyors for the Continuous Process. Usually the milk is sterilized at 110 - 118°C for 15-25 minutes. The sterilized milk bottles should be gradually cooled to room temperature. Any sudden cooling may lead to bottle breakage. Finally the milk-in-bottles should be stored in a cool place.

### 31.4.1 Advantages

- i) Remarkable keeping quality; does not need refrigerated storage
- ii) no cream layer/plug
- iii) forms a soft digestible curd, and hence useful for feeding of infants and invalids
- iv) distinctive rich flavor
- v) economical to use
- vi) less liable to develop oxidized taints

### 31.4.2 Disadvantages

- i) increased cost of production
- ii) more loss in nutritive value than pasteurization (50 per cent of the vitamin C and 33 percent of vitamin B originally present, are destroyed, and there is a slight reduction in the biological value of the milk proteins)
- iii) Gerber test by normal procedure not so accurate.

## 31.5 Types of Sterilization Process

### 31.5.1. Batch process (In-bottle sterilization)

Milk is first subjected to platform tests, clarified and then standardized. It is then pre-heated and homogenized at 145 kg/cm<sup>2</sup> pressure. Milk is then filled in glass bottles which are sealed with crown caps and sterilized as shown in Fig. 31.2.

### 31.5.2 Bottle and bottling

The milk to be sterilized should promptly be cooled and bottled so as to serve the dual purpose of: (a) protecting the milk against contamination, loss, damage or degradation (due to: microorganisms or insects; exposure to heat, light, moisture or oxygen; spillage, evaporation or pilferage), and (b) helping in the sale and distribution of the milk. The glass bottle is still universally used. It is usually transparent, although in some countries brown bottles have been tried (brown bottles prevent light-induced off-flavours in milk; but on the other hand, the product is not visible for inspection). The glass bottle is generally round, but may also be square in shape (as in the USA); the latter is considered to be more economical as it requires less storage space. Though sturdy, the glass bottles also decrease the pay-load of retail vehicles.

Bottles should be examined for their colour, capacity and strength, before use. The tests include the following: (i) colour and appearance; (ii) shape; (iii) dimensions (height and neck diameter); (iv) weight; (v) serrations; (vi) minimum wall thickness; (vii) nominal capacity; (viii) strength or durability (these consist of thermal shock test, internal pressure test, impact test, polariscope examination, etc.).

In plants of small capacity, milk may be bottled with hand fillers operated manually with a lever and capable of filling 4 to 12 bottles at a time. The caps are then usually applied with a hand

capper. In larger plants, automatic, continuous, mechanical bottle fillers and cappers are used. These are broadly of two types, viz., gravity fillers and vacuum fillers. In the former, the milk flows by gravity into the bottles as they are pressed against the filling valves; in the latter, the bottles are filled by creating a vacuum within them. The milk from the storage tank/pasteurizer usually goes directly into the bowl of the bottle-filling machine, the connecting pipe being equipped with a valve to regulate the flow. Bottle washing operations are so timed in relation to the processing of milk that washed and sanitized bottles arrive at the filler as needed for immediate bottling. There are two principles in filling, viz. level filling and quantity filling. Level filling is quicker and more common; most bottle fillers are designed to fill milk bottles to a pre-determined level; however, a constant low temperature of milk at the time of filling, should be maintained. Quantity filling, although more accurate since it is not affected by either temperature or foam, is slower and hence seldom used.

## 31.6 Bottle Filling

### 31.6.1 Gravity fillers

These consist mainly of six different parts, viz., the drive, bowl, filler valves, carrier, capper and star wheels. The circular bowl receives the milk to be bottled. The level of milk is kept constant by a float valve on the inlet pipe. Filling valves are attached radially to the bottom of the bowl. Bottles are fed by hand or directly from the bottle washer by a conveyor. They are mechanically centered into lifters which are located directly under the filling valves and which revolve with them. These lifters rise automatically as the filler revolves and the mouth of the bottle is forced against a tightly fitting rubber valve. The rising bottle pushes up the valve and the milk flows down into the bottle. As the filling valve almost completes a revolution, the lifter on which the bottle is carried is lowered automatically and the valve closes and remains closed until the next bottle opens it. The filled bottle is then transferred to a capper where it is automatically sealed and the lifter, now in the lowered position, is ready to receive another empty bottle for filling. While the bottle is being filled, the air which is displaced by the incoming milk escapes through a vent tube, which extends from the bottom of the valve sleeve to a point above the milk level in the bowl. The height of the bowl tank is adjusted by the operator to suit the size of bottle that is to be filled. Bottles are automatically discharged from the capper onto a conveyor that delivers them to an accumulating table, from where they may be loaded into crates manually or mechanically.

Advantages: Relatively simple to operate; (ii) maintenance not too complicated; (iii) easily and swiftly cleaned.

Disadvantages: Slow filling and hence limited capacity; (ii) leakage losses high (due to badly sealed bottle, bottle with chipped mouth, faulty valve, etc.).

### 31.6.2 Vacuum fillers

These may be either vacuum-assisted (single-bowl) or straightforward vacuum (double-bowl) types. In the former, the typical gravity bowl, which has open vent tubes and conventional gravity valves, is closed with an air-tight cover. In the latter, there is a rotary bowl and a float bowl. The float bowl is slightly below the level of the tops of the filling head. When the bottle is raised against the rubber ring on the filling head, a seal is formed and air inside the bottle is immediately drawn out through vertical vacuum pipes, and the milk is drawn from the float bowl through the milk pipes to the filling head and is released into the bottle. Foam is drawn off through the vacuum pipes into the vacuum tanks. Excess milk collecting in the vacuum tank automatically goes into the float bowl. Towards the end of the revolution of the filler, the lifters, on which the

bottles are carried, are lowered, and the seal is broken. Any milk remaining in the milk pipe siphons back into the float bowl and that remaining in the vacuum line is drawn back into the vacuum tank.

Advantages: (i) Rapid filling; (ii) will not fill a bottle with a chipped mouth or bad seal, thus saving milk; (iii) no milk drip through faulty valves.

Disadvantages: (i) Maintenance complicated; (ii) relatively complicated to operate; (iii) cleaning more time-consuming.

## 31.7 Caps and Capping

The capping machine is often incorporated into the filler, and in any case, its work must synchronize with it. The milk bottle cap or closure has three main functions: (i) to retain the milk within the bottle; (ii) to protect the pouring lip from contamination; and (iii) to seal the bottle against tampering. (In this case, tampering refers to the removal or replacement of milk from a bottle without this being evident from the appearance of either the bottle or the milk within it.)

The caps may be: (i) Cardboard discs, impregnated with a moisture proof layer (paraffin wax or polythene); (ii) aluminium foil caps; (iii) crown corks. The cardboard discs with separate hoods were the first to be introduced, but are not much used now. The aluminium foil cap is most commonly used. It is either pre-formed or formed-in-place, both types having their advantages and disadvantages. The foil may be 0.05 to 0.15 mm thick and of 50 mm wide. Crown corks generally used for sterilized milk are made of lacquered tin plate, the inner surface of which is lined with water-proof paper/polythene, and are more expensive.

## 31.8 Inspection of Filled Bottles

Before being (manually) placed in crates, filled milk bottles should be inspected for dirt, etc. by rotating them as they are removed from the machine.

## 31.9 De-crating and Re-crating of Bottles

Removing dirty bottles from crates (decrating) and refilling them with bottles of pasteurized milk (re-crating) are among the most back-breaking and labor-consuming operations in the dairy. Both decrating and re-crating machines look the same. The decrator lifts the empty bottles by vacuum-operated rubber-grippers and rejects any that are damaged. The re-crator lifts the filled bottles by compressed-air operated rubber-grippers. In decrating, the crates of empty bottles are at first correctly positioned before lifting, while in re-crating, a special marshalling mechanism allows bottles from the filler to assemble in correctly positioned groups, ready to be picked up for transfer to the crates. This stacks crates containing filled bottles, thereby relieving labor of another back-breaking job.

The crates containing the bottles are placed in steam chest and heated at 115°C for 15 min - an equivalent approved temperature-time combination. The method is suitable only for small operations. It results in flavor and color changes in the sterilized milk due to longer heating.

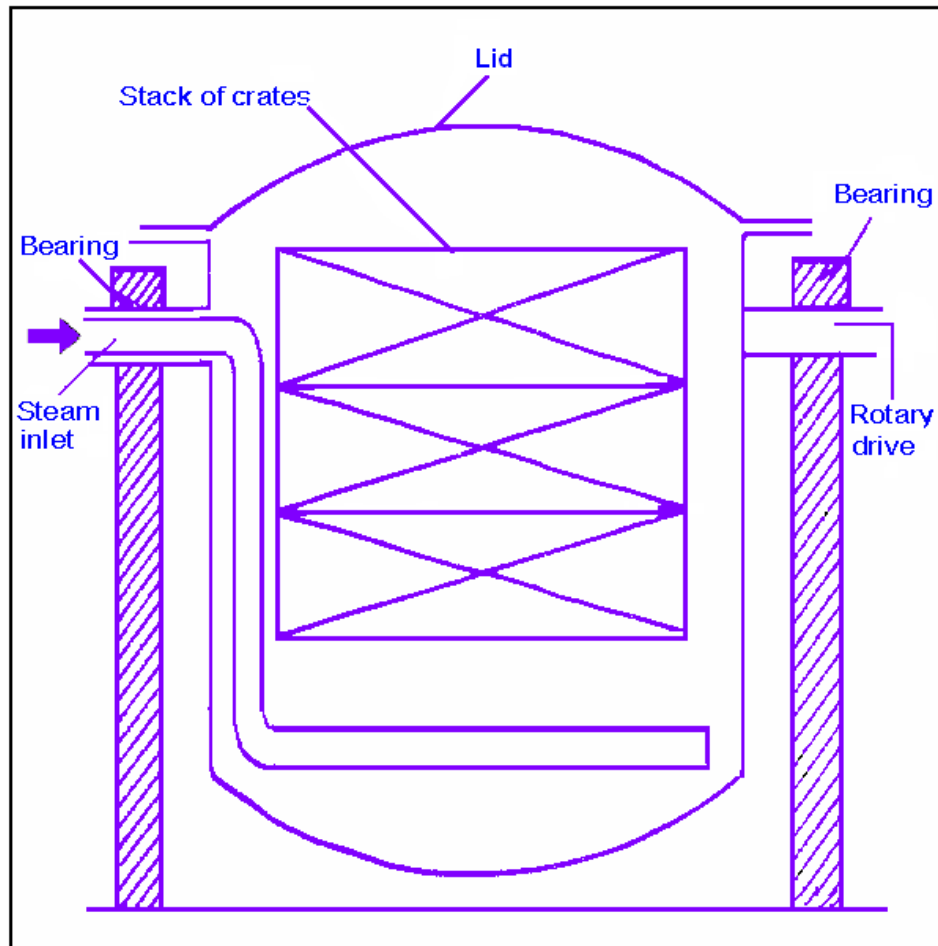

Fig. 31.2 Schematic Diagram of a rotary batch sterilizer

### 31.10 Semi-continuous In-bottle Sterilization

This method is similar to the one described in 31.5.1 except that an arrangement for rotating the crates is provided. The rotation helps in more uniform and efficient heat transfer, thereby minimizing colour and flavor changes. After the heating process is over, the crates containing the bottles are released into a tunnel of cooling air.

#### 31.10.1 Continuous in-bottle sterilization

In this case sealed milk bottles pass continuously on chain conveyors through the pre-heating water and then to the steam chest for the required temperature and time. Thereafter the bottles move through the cooling water and finally to the atmospheric exit. This method is commonly used by the large scale manufacturers of sterilized milk as it helps in efficient energy usage and also for a comparatively better colour and flavour of finished product.

##### 31.10.1.1 Cooling

After heat-treatment in the batch/tank sterilizers, the milk bottles may be cooled in air or water. If cooling is too rapid, the bottles may crack; if too slow there is a danger of browning due to caramelization. In the continuous system, after leaving the sterilizing zone, the bottles enter a column of hot water where the cooling process begins. This is followed by their passage through another tank of water (at a lower temperature than the previous one) for further cooling, and lastly through a shallow tank of cold water for final cooling. The bottles are then automatically discharged and conveyed to a point where they are placed in crates in which they are transferred to the storage room.

### 31.10.2 In-can continuous sterilization

This method is the most commonly used throughout the world. It comprises of a pre-heater, a sterilizer and a cooler with a leaking-can detector at the pre-heater and cooler discharge. The sealed milk cans are passed into a pre-heater where the cans are carried through a spiral path inside a drum filled with hot water. The cans then pass through a can detector to observe any leakage and thereafter are subjected to steam under the pressure for sterilization. Finally the milk cans move through the pressure air cooler and discharged. Recently a continuous milk sterilizing line with high temperature short time operation has been developed. It processes milk for 2 min at 127°C with a resultant improvement in quality mainly in color and flavor.

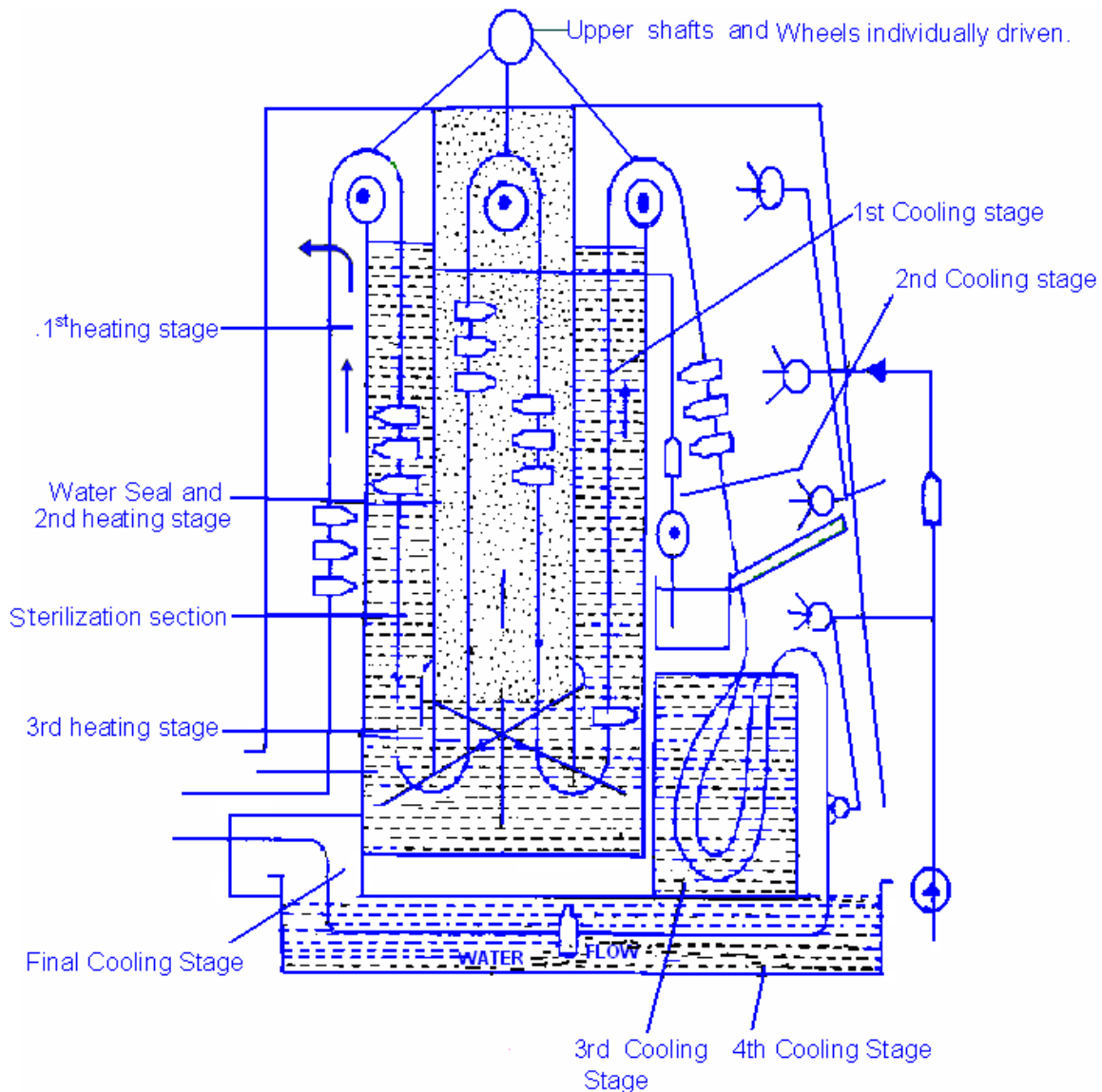

Fig. 31.3 Schematic diagram of a continuous hydrostatic sterilizer

### 31.10.3. Ultra high temperature (UHT) method of sterilization

In these processes, the milk is heated to 135-150°C for a few seconds, generally in a plate or tubular heat-exchanger. The milk, which is almost sterile, is filled into containers and sealed aseptically in a specially designed aseptic packaging system. The packed milk can be stored at room temperature upto a period of six months.



### 31.10.3.1 Distribution

Sterilized milk can be distributed once a week. This is why sterilized milk has great scope in tropical countries where household refrigerators are not commonly available.

### 31.10.3.2 Tests

- Turbidity test - To ascertain sterilization efficiency
- Bacterial count

Note: Phosphatase test is not applicable to sterilized milk.

### 31.10.3.3 Demerit

The most common is browning. Because of this fault, 'Plain' sterilized milk is not so popular. Flavored (and simultaneously colored) sterilized milk is more popular.

\*\*\*\*\* 😊 \*\*\*\*\*

**Lesson 32**  
**ULTRA-HIGH TEMPERATURE PROCESS**

**32.1 Introduction**

It is a modern technique for milk sterilization. Long life or UHT milk originated at Switzerland in 1961. It has a long storage life and greater consumer acceptability than the conventional canned sterilized milk, in which the product suffers greater alterations in flavor, color and nutritional quality. While UHT processing is one way of producing sterilized milk, it is predated in terms of development and commercial application by in-container sterilization methods which also produce long-life products. In-container sterilization processes, in which milk is sterilized in either glass or high density polyethylene bottles, operate at lower temperatures than UHT processes, but for longer times. The process requires a minimum sterilization temperature of 100°C for sufficient time to ensure that the product passes the turbidity test. The test is based on the confirmation of adequate heat treatment by the use of ammonium sulphate to precipitate milk proteins, including heat denatured whey proteins. In-container sterilization may be achieved either by batch processing, in which bottles of milk are heat treated in autoclaves or retorts, or by continuous processing where bottles of milk pass through a sterilizer. Two methods of continuous processing are common: the vertical tower or hydrostatic sterilizer and the horizontal sterilizer.

**32.2 IDF Definition**

A UHT product produced by UHT treatment is packaged in a sterile container under aseptic conditions. Typical temperature-time combination for UHT milk is 132°C for not less than 1 sec and for UHT cream 132°C for not less than 2s.

**Table 32.1 UHT regulations for milk**

Country	Temp (°C)	Time (s)	Remarks
Germany	135-150	Short time	Should keep well for 6 weeks at room temperature
Denmark	135	1 s	Should give negative turbidity test, stable for 14 days at 30°C and 7 days at 55°C
Finland	135	2-3 s	Shelf life of 14 days at 30°C
France	140	1 s	Shelf life of 21 days at 31°C and 10 days at 55°C
Switzerland	130-150	Few s	Storage upto 1 - 4 months

**32.3 Advantages of UHT Milk**

1. UHT treated milk has definite advantage when the distance between producer and consumer is wide.
2. UHT treated milk can be kept for several months without refrigeration, advantageous in warm summers.
3. Temporary surpluses due to seasonal variations can be covered by subjecting milk to UHT treatment
4. Manpower costs are saved
5. Milk can be stored at home all the time. It can be readily available at distant locations and at all odd hours.

### 32.4 Disadvantages

- Flavor of UHT milk is dissimilar to pasteurized milk.
- Chances of formation of deposits within the system particularly in the direct steam system which causes extra operating cost
- Age gelation during storage.
- Higher cost of aseptic packaging
- Sometimes fat separation and sedimentation of insoluble particles may occur during storage.
- Nutritive value is much diminished as compared to pasteurized milk.
- It is expensive.

### 32.5 Quality of Raw Milk for UHT Processing

The milk quality subjecting to UHT processing should meet the following requirements:

Flavor & Taste	_____	Normal and fresh
pH	_____	More than 6.6
Acidity	_____	Less than 0.14% LA
Spore count	_____	200 – 500/ml
72% Alcohol	_____	negative

### 32.6 Types UHT Processing Plant

UHT processing plants can be divided into two principal types, using either direct or indirect heating.

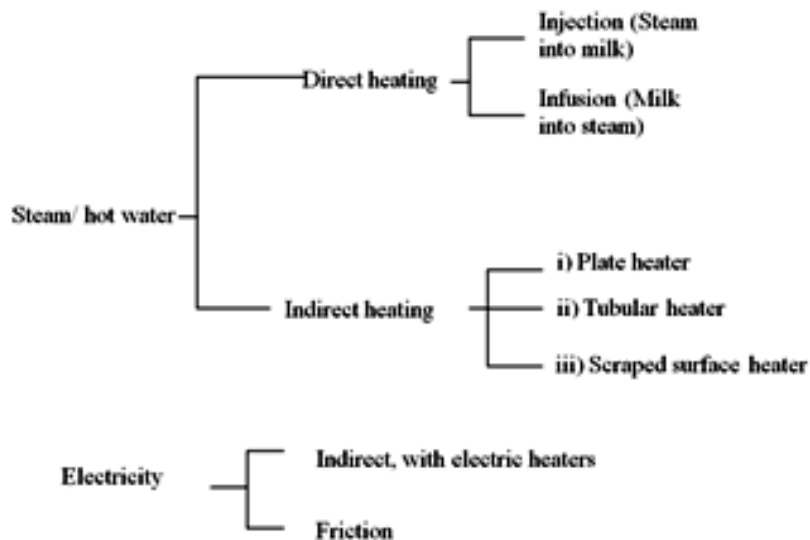

**Fig 32.1 Types of UHT processing plants**

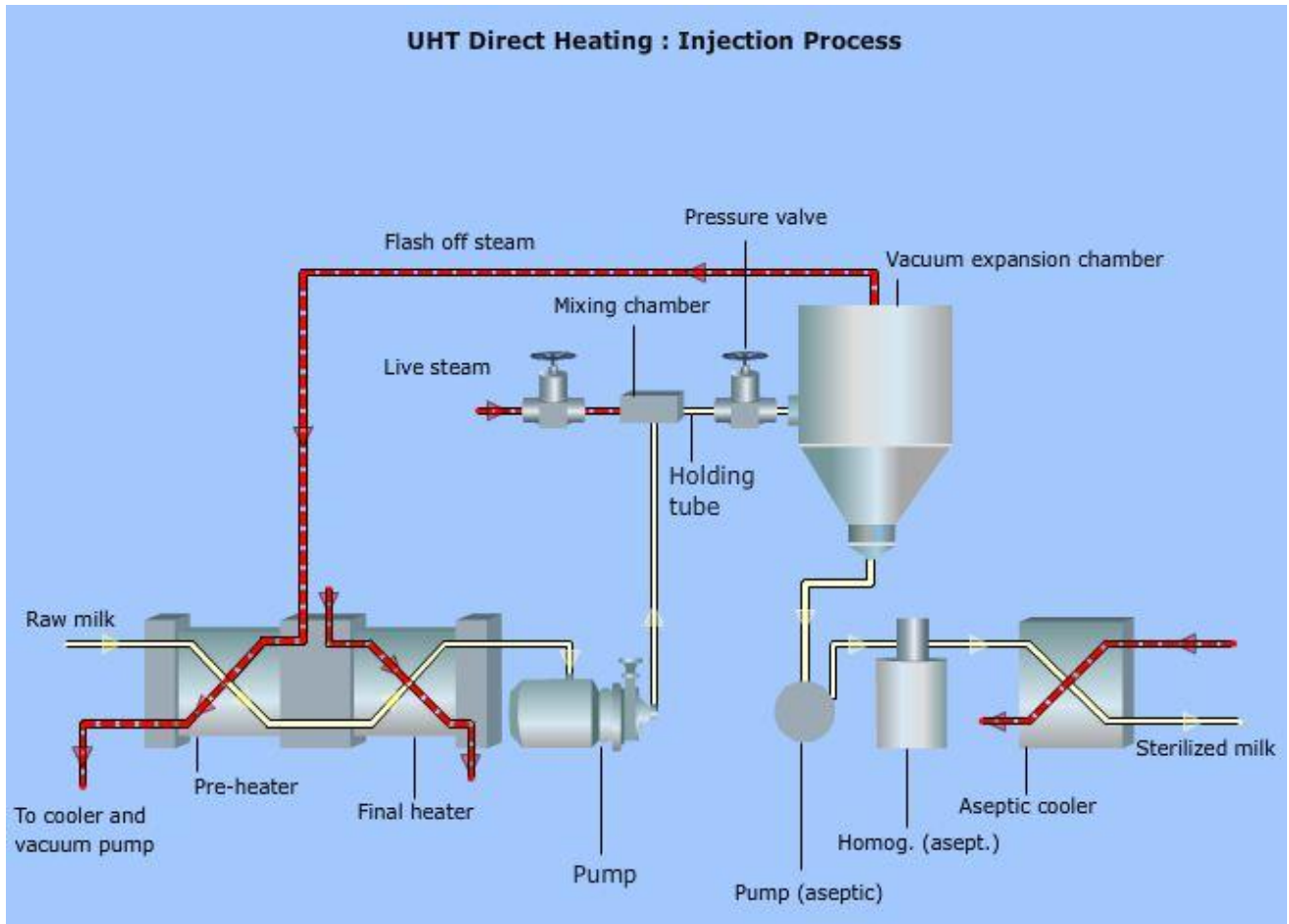

Fig. 32.2 UHT direct heating

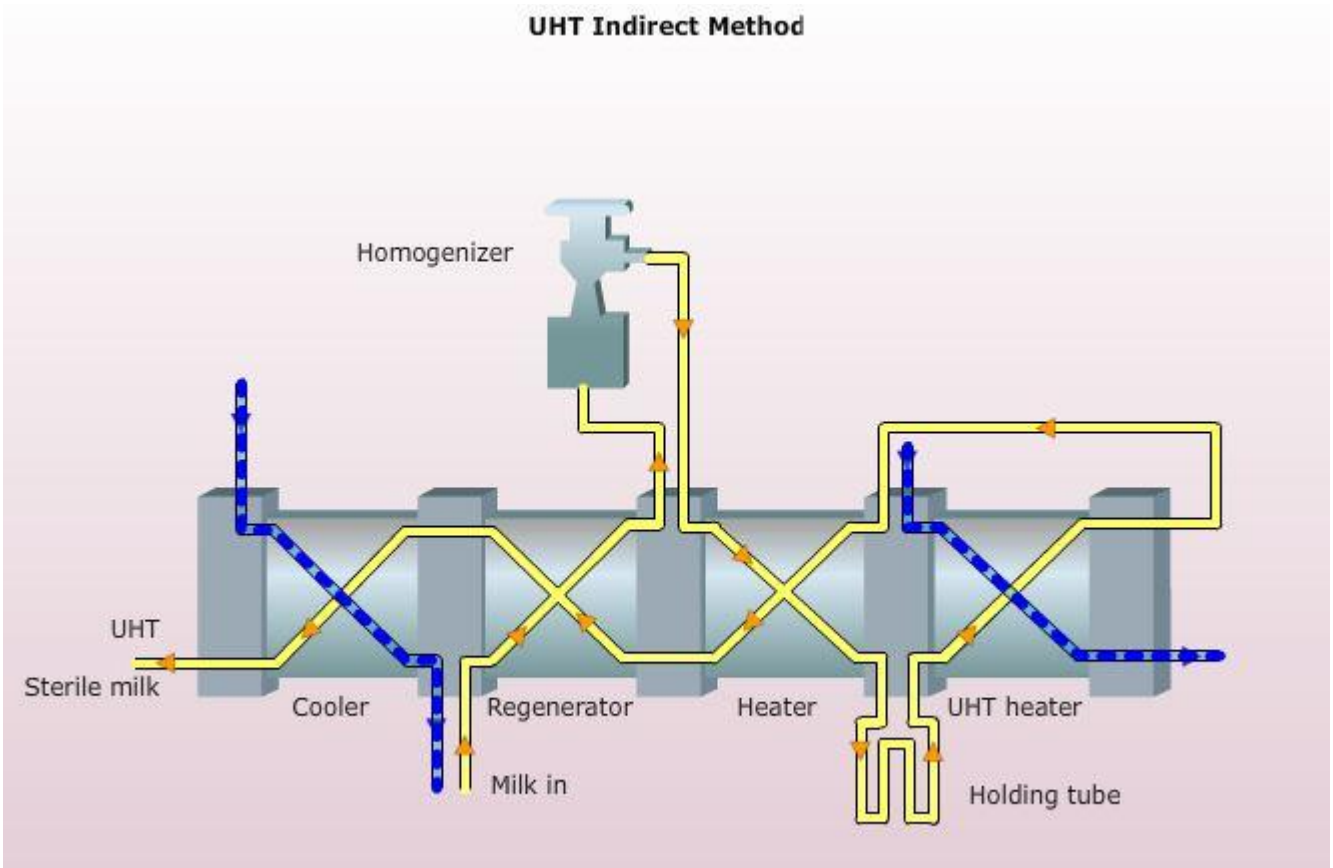

Fig. 32.3 UHT indirect heating

### 32.6.1 Difference between a pasteurizer and UHT plant

- Higher operating pressures are required in order to prevent the milk from boiling at the processing temperatures
- Homogenization step is essential to prevent fat separation during storage
- The plant needs to be sterilized down-stream of the holding tube prior to processing and maintain sterility throughout processing

### 32.6.2. Direct heating with steam injection

The milk flows through a pre-heater and a final heater, where it is heated to approximately 75 – 85°C. Pressure necessary for UHT heating (150°C corresponds to 4.76 bar) is applied by a pressure pump and the milk is intimately mixed with steam in the mixing chamber. The steam immediately condenses in the milk giving up its heat of vaporization and thus heating the milk. The amount of steam used must be such that immediately after mixing, both the milk and the condensate formed are heated to the sterilizing temperature. The mixture then flows through a holding tube (2-4s) which enters tangentially into the vacuum chamber. Close to the entry point, is an adjustable pressure retaining valve which maintains the saturated steam pressure corresponding to the sterilizing temperature. The hot mixture under pressure then expands and causes spontaneous cooling by evaporation. The vacuum is so maintained that exactly the same amount of water evaporates as is incorporated in the form of live steam. The steam released in vacuum chamber is used to preheat the incoming milk when the milk passes through an aseptic path pump, homogenizer and perhaps storage tank to aseptic packaging. The advantage of expansion cooling is that it removes undesirable odorous substances from milk. To maintain constant water content in UHT milk, it is required to maintain accurate temperature control of the milk entering the mixing chamber, in the holding tube and in the expansion chamber. The parameters that are controlled include the milk feed, the steam supply and the vacuum in the expansion chamber.

### 32.6.3. Milk into steam (infusion)

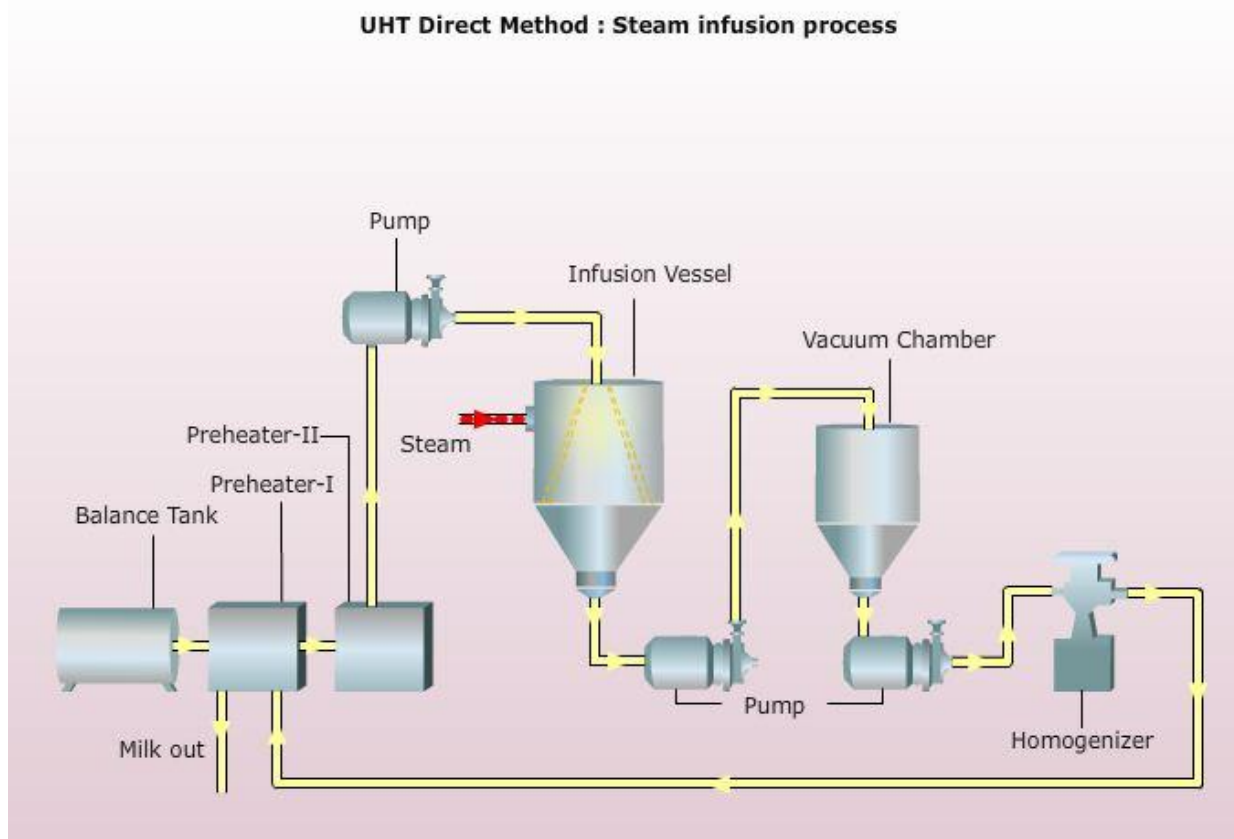

Fig. 32.4 Infusion

The milk is homogenized and falls as a laminar free falling film into a steam pressure vessel, in which milk is heated to the UHT temperature, passes through a holding section and is cooled by expansion. In another method, the milk is atomized to fine droplets, injected into a steam pressure vessel via pressure jets. Milk droplets are more easily heated than a film. But the disadvantage is that the milk can also be sprayed onto the hot wall of the vessel which may allow the milk to leave the heater after holding time of very unequal durations.

### 32.6.4 Advantages

The product never comes in contact with a surface having a temperature above that of sterilization temperature. Therefore, the product retains excellent flavor.

### 32.6.5 Disadvantages

Difficulty to control the holding time exactly. The reason for this includes (i) droplets of milk are heated to sterilization temperature while falling through a steam chamber, (ii) the speed of milk droplets is bound to show variation, (iii) the infusion chamber must always contain a bottom layer of product introducing variation in holding time.

**Table 32.2 Comparison of direct and indirect processes**

Parameters	Direct	Indirect
Capital Cost	High	Low
Complexity	More	Less
Energy Costs	High	Low
a) Regeneration	40-50%	70-90
Heat treatment	Mild	Severe
Length of run	20 h	4-5 h
Sediment	Twice sediment	Less
Rennet/pepsin clotting	Reduced	More reduced
Noise level	Very high	Acceptable level
Flavour loss	High	Low
Water requirement	High	1/5 <sup>th</sup>
Steam quality & supply	Special Extra	-----
Pumps	3+	1 or 2
Deaerator requirement	Not	Yes
Whey protein nitrogen (mg/100mg)	38.8	27.6
Loss of available lysine (%)	3.8	5.7
Loss of Vitamin B <sub>12</sub> (%)	16.8	30.1
Loss of Folic acid (%)	19.6	35.2
Loss of Vitamin E (%)	17.7	31.6
HMF ( $\mu$ mol/L)	5.3	10.0
Cabbage smell (H <sub>2</sub> S)	Less	-----

**Table 32.3 Comparison between plate and tube heat exchanger**

	Plate	Tube
Turbulence	High	Low
Residence time	Short	Long
Equipment size	Small	Large
Temperature & pressure range	Smaller	Larger
Deposits	Less	More
Length of run	Short	Long

## 32.7 Indirect Heating Methods

### 32.7.1. Plate heat exchanger

The milk is pumped into the first heat exchanger where the temperature of milk is raised to about 75 or 85°C and it may or may not be admitted to a holding cell. In the holding cell, the product is kept for 30 seconds to 5 minutes at 80°C depending on the design. The reason for this holding cell is to reduce deposits which would otherwise form in the final heater of the equipment. From the holding cell, the product is sent to a homogenizer which functions as a positive pump and forces the product through the heating section.

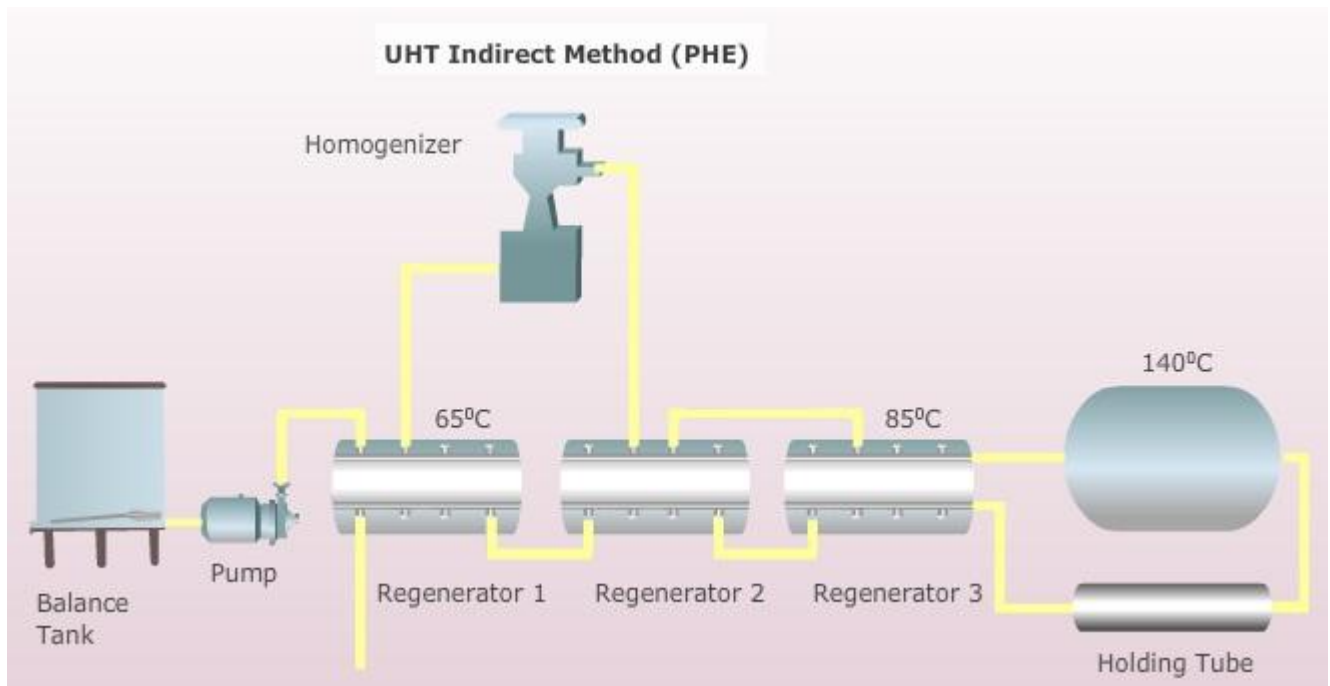

Fig. 32.5 Indirect method PHE

The product enters a second holding cell where temperature regulation is done by a thermo-sensor by regulating the steam supply to the final heating section. The sterilizer is equipped with a flow diversion valve. If the temperature drops below a preset value, the flow is diverted through a separate cooling section and back to the inlet balance tank.

Under normal production conditions, the product is cooled in a final cooler before leaving the plant. The cooling sections are regenerative type. Since whey proteins get denatured at high temperatures, deposits will always form in sterilizing equipments. In order to reduce the amount of deposits, a holding cell is introduced. In this way, the whey protein is carried through the equipment and scaling is diminished. The higher the air content in the product, more is the chance for deposits to form. The air content can be reduced by a de-aeration process and by the holding cell.

#### 32.7.1.1 Advantages of plate heat exchanger

- High induced turbulence to the heating medium and heated product
- High heat transfer rate
- Low temperature difference between heating and heated fluids (low deposit formation)
- Low pressure drops in the product circuit
- Plates can be assembled to give a wide variety of heating and cooling sections.

## 32.7.1.2 Disadvantages

The gaskets set upper limits to the internal pressures that can be used with the heat exchanger.

## 32.7.2 Tubular heat exchanger (Stork) 3rd generation

The product is admitted via a balance tank and reaches the first homogenization head through the regenerative pre-heater and then the final heater. Final heater is designed to have lower energy consumption and ensures low temperature gradient between product and heating medium. For this, a triple tube heater in which steam passes through the centre and outer tubes surrounding the product, which flows through the middle tube. The advantage it offers is rapid heating of the product. Sterilization temperature (138°C) is reached here. After passing the first regenerative cooling section, the product is cooled down to about 75°C and reaches the second homogenization head. After passing the second regenerative cooling, the product is admitted to the final cooler where the temperature is brought down by means of water cooling to filling temperature. This arrangement gives almost twice the heat transfer of a single tube in a heating chamber. Inherent strength of tubes, much higher internal pressures can be withstood during the operation.

Stainless steel tubes do not cause induced turbulence in the product and natural turbulence resulting from high flow velocities is needed to give high heat transfer rates. Pressure drops through the heat exchanger and temperature differentials between heating and heated fluids are therefore higher than with plates.

## 32.7.3 Combined systems

These have plate heat exchangers in the lower temperature sections and tubular sections at the highest temperatures, where the internal pressures are also high.

## 32.7.4 Scraped surface heat exchangers

Scraped surface heat exchangers are suitable for viscous products where satisfactory heat transfer rates cannot be obtained by relying on an induced turbulence from conjujal plates or natural turbulence from high product velocities. The product flows axially inside a stainless steel cylinder, heated from the outside. A rotating shaft on the axis of the cylinder breaks down any stationary layer of viscous product and induces turbulence in the body of the fluid. Scraped surface heat exchangers operate with high differential temperatures between product and heating medium.

## 32.8 Electric Method

### 32.8.1 Indirect with electric heaters

The electricity heats the incandescence spiral resistance elements which are wound round quartz tubes through which the milk passes. The milk heated from 95 - 140°C using a combination of infra-red radiation and heat conduction through the quartz tubes. From the stand point of performance, this sterilizer is therefore simple to a conventional indirectly heated sterilizer.

\*\*\*\*\* 😊 \*\*\*\*\*



**Lesson 33****UHT MILK - HOMOGENIZATION, PACKAGING AND DEFECTS****33.1 Introduction**

For products containing high fat, homogenization must be done to prevent fat separation. In UHT processing, there are two positions for the homogenizers i.e. upstream or downstream. Homogenization may be carried out before or after UHT heating. If the latter arrangement is adopted, it will cost more, since the process has to be carried out aseptically. In order to maintain high quality in UHT processed products – flavour-wise, microbiologically and nutritionally – aseptic packaging becomes a necessity. ‘Aseptic’ in the context of the milk packaging industry means the elimination of microbial recontamination of UHT-processed milk to prolong shelf life at ambient temperature. In spite of all efforts, some defects may occur in the physical properties of UHT milk.

**33.2 Upstream and Downstream Homogenization**

Many UHT plants operate with the homogenizer in the upstream position. In such cases, homogenizers are not in the sterile part of the plant and do not have to operate under aseptic conditions, thereby removing the requirement of incorporating a sterile block. The milk flow rate is controlled by the upstream homogenizer in indirect systems. A variable speed homogenizer may be used to vary the throughput if so desired from the view point of filling requirements. When a de-aerator is provided, equal rates of milk supply and removal from the vessel are maintained by various means depending on the supplier of the system. The drawback of this process is that the higher temperatures used in the processing zone or the high shear rates found in the plate heat exchangers might destabilize the emulsion and affect its stability during storage. It is, however, the best position where stability and sedimentation are not major problems. In case of downstream homogenization, it is necessary to provide a sterile block, wherein the pistons move through an atmosphere of steam. However, this position increases the risk of post-contamination. In all sterilizers of the direct type, homogenization of the product should be done on the down-stream and/or sterile side. The downstream location of the homogenizer in the direct heating systems is needed to minimize certain texture defects. Also fat tends to agglomerate upon direct heating of previously homogenized milk. There is, however, an advantage in homogenization after UHT heating since it prevents or reverses protein-protein and fat globule-protein aggregation. It also retards the formation of sediment comprising of precipitated whey proteins. The homogenizer is made aseptic by providing steam seals.

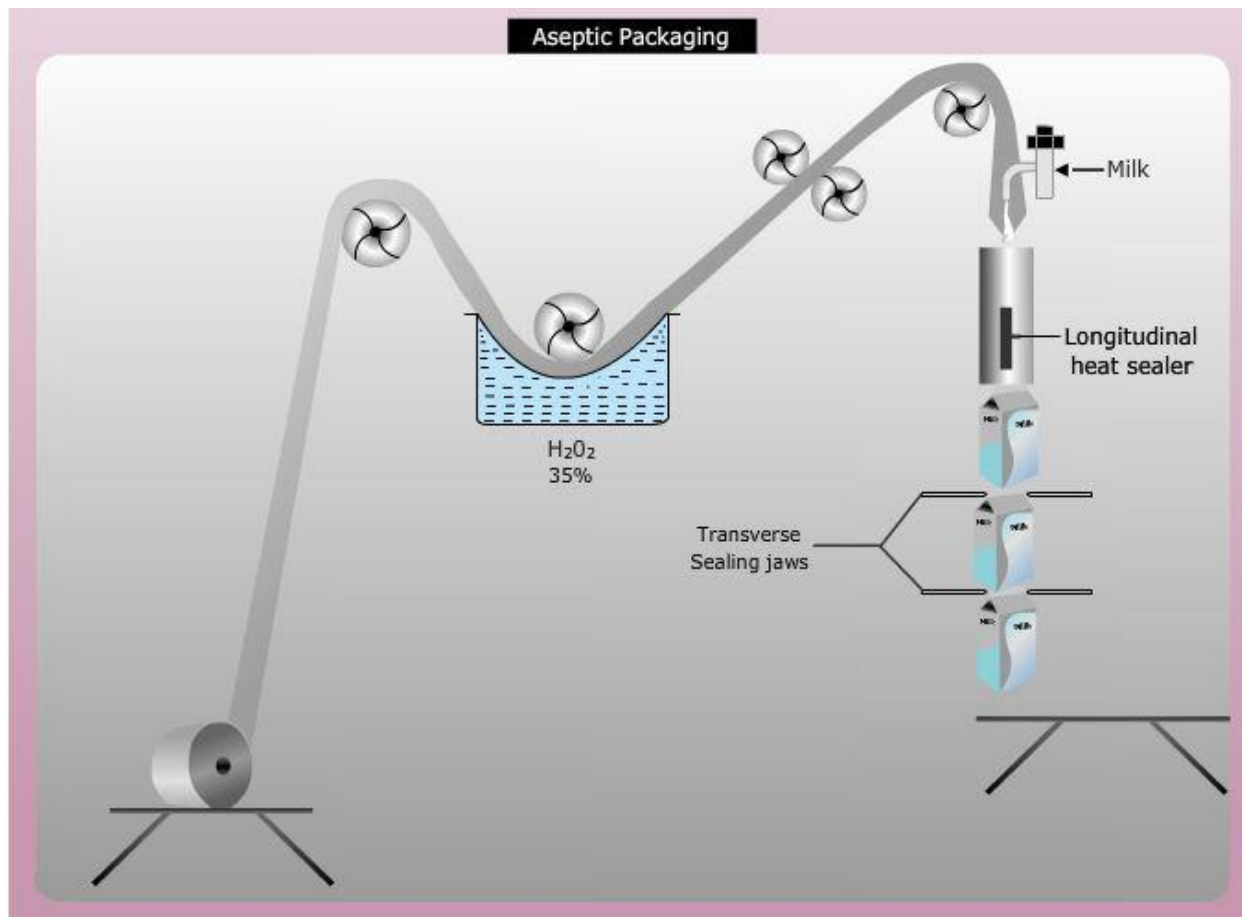

Fig 33.1 Sterilization of packing materials

### 33.3 Aseptic Packaging

Aseptic packaging involves

- sterilization of packaging material
- creation of a sterile environment while forming the container and/or filling the product and
- sealing of containers thus preventing re-infection.

#### 33.3.1 Packaging material

The packaging material is built up in the following way:

Starting from the outside, the material is covered with an external coating which might be either plastic or wax below of which is a layer of printing ink on the paper. The latter may be a twin layer (duplex) or single layer paper. Next we have the laminating layer of plastic material by which the aluminium foil is attached to the paper base.

The aluminium foil has three functions:

- It provides protection against light.
- It provides protection against entry of air.
- It is necessary to achieve satisfactory transversal seams.

On the inside either one or two polyethylene coats are applied (extruded) on top of the aluminium foil depending on the kind of product to be packaged and the extrusion equipments available.

The bacterial contents of the packaging materials food contact surface as found after extrusion in the paper conversion factory have been checked. An average total count of 0.02 to 0.05 microorganisms per cm<sup>2</sup> was found. This comes to about 40 bacteria per 1 L brick carton. The groups of microorganisms present are 20% fungi, 10% yeast and 70% bacteria, mainly micrococci.

### **33.4 Tetra Brick Aseptic Packaging**

The material fed into the machine from a reel of packaging material. Depending on carton size, each reel will give between 2300 (1 L size) and 5,000 (1/2 L size) units. The web travels up the machine. A strip is applied to one edge of the paper. This strip has two functions: to reinforce the longitudinal seam, and to prevent the product from coming in contact with the paper edge. After application of this strip, the material passes through a hydrogen peroxide bath. A pair of pressure rollers removes surplus hydrogen peroxide.

While travelling down, the material is formed into a longitudinally sealed tube. Remaining hydrogen peroxide is evaporated by heat, and the product is admitted. The level of the product remains above the zone where the transversal sealing is done. The product outlet is below the product level in the tube and the tube is sealed transversally. Finally the cartons are given their final shape.

Since the packaging web is a plastic coated material, the material is electrically charged. There is also a certain amount of bacteria in the surrounding air. Again, these bacteria carry electric charges. There will be attraction between the bacteria and the packaging material.

While the paper is travelling up through the air in the packaging room, a certain amount of infection is picked up. The degree and kind of infection vary largely depending on the hygienic conditions in the room. Having gone up the machine, the paper passes through a hydrogen peroxide bath. The peroxide bath contains a solution of hydrogen peroxide, with a concentration of 15 to 20% in the tetrahedron system and about 35% in the aseptic brick system. Packaging material with bacteria on it enters the bath. Some of the bacteria are washed off and some are killed. But there will still be survivors, mostly spores. When the material travels down in the machine, it is formed into a tube.

To prevent re-infection, the tube heat element produces a hot air current which protects the paper from the surrounding air. Simultaneously, hydrogen peroxide vapour escaping from the tube heater zone is channelled to a ventilation system. The tube heater is an electrically powered radiation element working at different temperatures (400- 600°C) depending on the diameter of the tube.

First of all, water is evaporated from the hydrogen peroxide with an increase in both, temperature and concentration of H<sub>2</sub>O<sub>2</sub>. Eventually, the hydrogen peroxide evaporates. The temperature is measured in the inside of the paper tube in the plastic layer. The highest temperature at this point is about 120°C.

The sterilization efficiency of the system is the combined effect of the hydrogen peroxide bath and the time of exposure of the web. During passage from the bath down to the axis, the web passes radially across the face of the disk where excess H<sub>2</sub>O<sub>2</sub> is discharged at the periphery. Product is preheated to about 80°C by tubular regenerators before it enters the sterilizer. It is heated to 130-150°C in about 0.02 sec by friction, the final temperature being determined and controlled by a valve which regulates the product flow rate. Cooling is done by regeneration. Some

homogenization occurs due to the mechanical forces applied to the product. Because of the rapid rate of heating, the friction sterilizer is likely to be similar in performance to the conventional direct heating sterilizers.

## 33.5 Defects in UHT Milk

### 33.5.1 Colour

Milk heated by the UHT process does not undergo browning because the time of heating is too short. On the contrary, such milk often appears whiter than the original milk because soluble proteins and casein micelles are partly disintegrated. In UHT milk, significant browning occurs during storage, particularly at higher temperatures.

### 33.5.2 Flavour

UHT milk after treatment has a hydrogen sulphide odour (cabbage) and a cooked flavour which disappears within 24 hrs. Sulphahydril groups disappear within a few days as a result of oxidation processes. Potassium iodate (10-20 ppm) has been used to reduce the amount of cooked flavour in milk by causing the oxidation of any exposed -SH groups. Potassium iodate also reduces the denaturation of  $\beta$ -lactalbumin. Oxidized or stale flavours appear after the cooked flavour has disappeared owing to the presence of methyl ketones and aldehydes.

### 33.5.3 Texture and structure

#### 33.5.3.1 Fat separation

It is mainly due to inefficient homogenization.

#### 33.5.3.2 Sediment

Formation of sediment is higher in direct heating process. This is due to fat-protein complex formation which increases with increasing homogenization pressure, viscosity and fat, solids and calcium contents as well as decreasing heat stability. Agglomeration of fat/protein in UHT milk can be prevented if the homogenizer is arranged downstream.

#### 33.5.3.3 Age thickening and gelation

UHT milk shows a greater tendency to thicken and coagulate during storage than conventionally sterilized milk and these tendencies are related to the severity of the heat treatment. The gel structure is believed to be caused by casein micelles which will also trap fat globules and whey proteins in a three dimensional net work.

- Casein proteolysis due to enzyme reaction.
- Maillard reaction.

## 33.6 Nutritive Value of UHT Milk

UHT processing causes fairly extensive denaturation of whey proteins. The direct process generally causes less denaturation (60-70%) than the indirect (75-80%) and with both processes the  $\beta$ -lactoglobulin is affected to a much greater extent than the  $\beta$ -lactalbumin. Some slight modification of the milk caseins- size and composition occurs. There are no changes in nutritional

status of lipids, minerals and carbohydrates on UHT processing though there may be some loss of unsaturated fatty acids in triglycerides. Vitamins A, D, E and K are affected very little by UHT processing. Of the B complex vitamins, thiamine, riboflavin, pantothenic acid, biotin, nicotinic acid, vitamin B6 and vitamin B12 suffer no significant loss but up to 20% of folic acid may be destroyed. Processing destroys any dehydroascorbic acid present in milk, but does not affect the content of ascorbic acid.

\*\*\*\*\* 😊 \*\*\*\*\*

### Lesson 34

## LEGAL STANDARDS AND VARIANTS OF MARKET MILK

### 34.1 Introduction

The term 'fluid milk' refers to liquid milk which is used for consumption as well as for conversion into products. Milk is often referred to by one or more processes which are applied to it before it is sold. Toned, double toned, standardized, pasteurized, homogenized, reconstituted, recombined, sterilized and other terms describe fluid milk products which are consumed for drinking or other purposes primarily in home or which are intermediate in the preparation of other milk products for market.

### 34.2 Designations and Standards for Various Market Milk

According to the FSS Rules, 2011 (formerly PFA Rules), the standards for different classes and designations of milk in India are as follows:

### 34.3 Buffalo Milk

The legal standards for buffalo milk stipulate that it may be either raw, pasteurized, boiled, flavoured or sterilized milk containing minimum milk fat of 6% and minimum milk SNF of 9% in the states of Assam, Bihar, Chandigarh, Delhi, Gujarat, Maharashtra, Haryana, Punjab, Uttar Pradesh and West Bengal, whereas in states/Union Territories like Andaman and Nicobar, Andhra Pradesh, Dadra and Nagar-Haveli, Goa, Daman and Diu, Kerala, Himachal Pradesh, Lakshadweep, Tamilnadu, Madhya Pradesh, Manipur, Karnataka, Nagaland, Orissa, Pondicherry, Rajasthan and Tripura, the minimum milk fat is 5% and minimum milk SNF is 9%.

### 34.4 Cow Milk

The legal standards for cow milk prescribe that it may be either raw, pasteurized, boiled, flavoured or sterilized milk containing minimum milk fat of 4% and minimum milk SNF of 8.5% in the states of Chandigarh, Haryana and Punjab whereas in Andaman and Nicobar. Andhra Pradesh, Assam, Bihar, Dadra and Nagar-Haveli, Delhi, Gujarat, Goa, Daman and Diu, Kerala, Himachal Pradesh, Lakshadweep, Tamilnadu, Madhya Pradesh, Maharashtra, Manipur, Karnataka, Nagaland, Pondicherry, Rajasthan, Uttar Pradesh, West Bengal and Tripura the minimum milk fat is 3.5% and minimum milk SNF is 8.5%. However, in Orissa the minimum milk fat is 3% and minimum milk SNF is 9%.

### 34.5 Goat or Sheep Milk

The legal standards for Goat or sheep milk specify that it may be either raw, pasteurized, boiled, flavoured or sterilized milk containing minimum milk fat of 3.5% and minimum milk SNF of 9% in the states of Chandigarh, Haryana, Kerala, Madhya Pradesh, Maharashtra, Punjab and Uttar Pradesh, whereas in Andaman and Nicobar, Andhra Pradesh, Assam, Bihar, Dadra and Nagar-Haveli, Delhi, Gujarat, Goa, Daman and Diu, Himachal Pradesh, Lakshadweep, Tamilnadu, Manipur, Karnataka, Nagaland, Orissa, Pondicherry, Rajasthan, West Bengal and Tripura, the minimum milk fat is 3.5% and minimum milk SNF is 8.5%.

### **34.6 Standardized Milk**

The legal standards for standardized milk stipulate that it is used for liquid milk consumption and should contain minimum milk fat of 4.5% and minimum milk SNF of 8.5% throughout India.

### **34.7 Recombined Milk**

It should contain minimum milk fat of 3% and minimum milk SNF of 8.5%.

### **34.8 Toned Milk**

It should contain minimum milk fat of 3% and minimum milk SNF of 8.5%.

### **34.9 Double Toned Milk**

It should contain minimum milk fat of 1.5% and minimum milk SNF of 9%.

### **34.10 Skim Milk**

It should contain maximum milk fat of 0.5% and minimum milk SNF of 8.7%.

Note:

- When milk is offered for sale without any indication of the class, the standards prescribed for buffalo milk shall apply.

### **34.11 Full Cream Milk**

To cater to the need of growing children and high income group people who wish to purchase the whole buffalo milk, a variant of milk called 'Full Cream Milk' (FCM) with minimum 6.0% fat and 9.0% SNF came into the market.

### **34.12 Toned Milk**

Toned milk refers to milk obtained by the addition of water and skim milk powder to whole milk. In practice, whole buffalo milk is admixed with reconstituted skim milk. Toned milk is the brainchild of Dr. D. N. Khurody who is credited with coining this name. Under his guidance, it was first produced in Mumbai city. Soon after other cities, notably Kolkata, Chennai and Delhi started producing and marketing toned milk (Fig. 34.1)

#### **34.12.1 Legal definition**

Under the FSS Rules (2011), toned milk should contain a minimum of 3.0% fat and 8.5% SNF throughout the country.

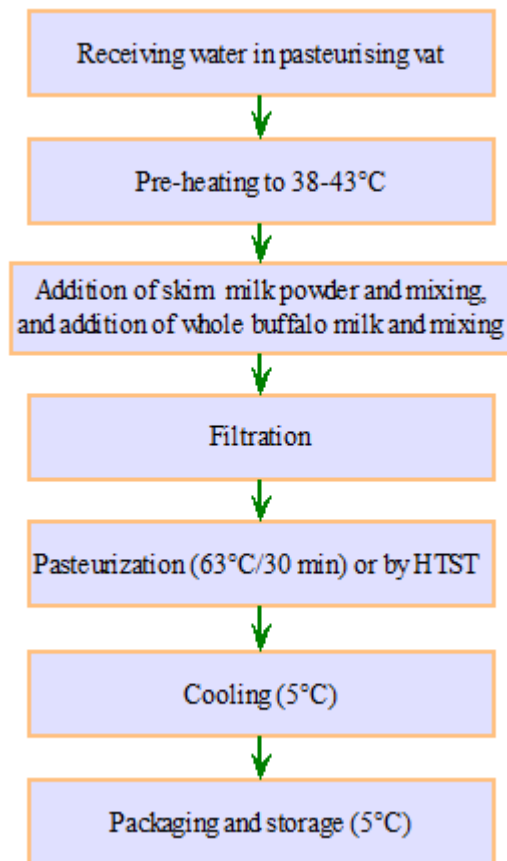

**Fig. 34.1 Flow diagram for manufacture of toned milk**

### 34.12.2 Calculations for toned milk preparation

**Problem:** Given 1500 kg of whole buffalo milk testing 6.5% fat and 9.8% SNF and SMP testing 0.5% fat and 96.5% SNF. Prepare toned milk to contain 3.0% fat and 8.5% SNF.

**Solution:** Let the amount of water and SMP required be  $w$  and  $s$  kg respectively.

Amount of toned milk =  $(1500+w+s)$  kg

The following equations can be formed:

$$[1500 \times 6.5/100] + [s \times 0.5/100] = (1500+w+s) \times 3.0/100 \quad \text{_____ (1) Fat Equation}$$

$$[1500 \times 9.8/100] + [s \times 96.5/100] = (1500+w+s) \times 8.5/100 \quad \text{_____ (2) SNF Equation}$$

Solving the above equation,

$$w = 1724.36 \text{ kg water}$$

$$s = 30.74 \text{ kg SMP}$$

### 34.12.3 Advantages:

1. Increases the supply of milk. The buffalo milk quantity can be increased by 100-150% on the basis of fat content.
2. Reduces the price of milk so as to reach the lower income group of population.
3. It is advantageous for those who are required to consume less fat on health grounds.

### 34.13 Double toned milk

Double toned milk (DTM) is made from cow and/or buffalo milk by adding fresh skim milk or a mixture of water and skim milk powder and/or by removing fat by partial separation, or by doing both. The standard throughout India for this fluid milk is minimum of 1.5% milk fat and 9.0% SNF. Double-toned milk should be pasteurized.



It is probable that DTM cannot be made from cow milk by partial separation alone. The addition of powder is necessary to ensure the required SNF (minimum 9.0%). Since cow milk may have around 8.5% SNF, DTM cannot contain 9.0% SNF. Extra SNF must normally be added in the form of skim milk powder. Buffalo milk would seldom have this difficulty because whole buffalo milk must legally contain at least 9.0% SNF.

### 34.13.1 Nutritive value

The energy value of DTM is about 46 kcal/100 gm. The supplies of essential fatty acids and fat-soluble materials are low in DTM. However, it has a high content of essential amino acids. The method of manufacture is similar to that of toned milk.

\*\*\*\*\* 😊 \*\*\*\*\*

**Lesson 35**  
**SPECIAL MILKS**

**35.1 Standardized Milk**

In this variety, milk fat and SNF content has to be adjusted to a certain predetermined level. Standardization can be done by partially skimming the fat in the milk with a cream separator or by admixing with fresh or reconstituted skim milk in proper proportions. Under the FSS Rules-2011, standardized milk for liquid consumption should contain a minimum of 4.5% fat and 8.5% SNF throughout the country. Standardized milk may be marketed as such or used for making certain milk products.

**35.1.1 Advantages**

1. Ensures milk of practically uniform and constant composition and with good nutritive value to the consumers.
2. The surplus fat can be converted into butter and ghee.
3. Possible to reduce the cost of milk
4. More easily digestible because of reduced fat content.

**35.1.2 Disadvantages**

The initial reaction of the consumer may be that standardized milk is 'thinner' than the whole milk.

**35.1.3 Method of preparation**

The preparation is shown in the form of a flow chart below (Fig. 35.1).

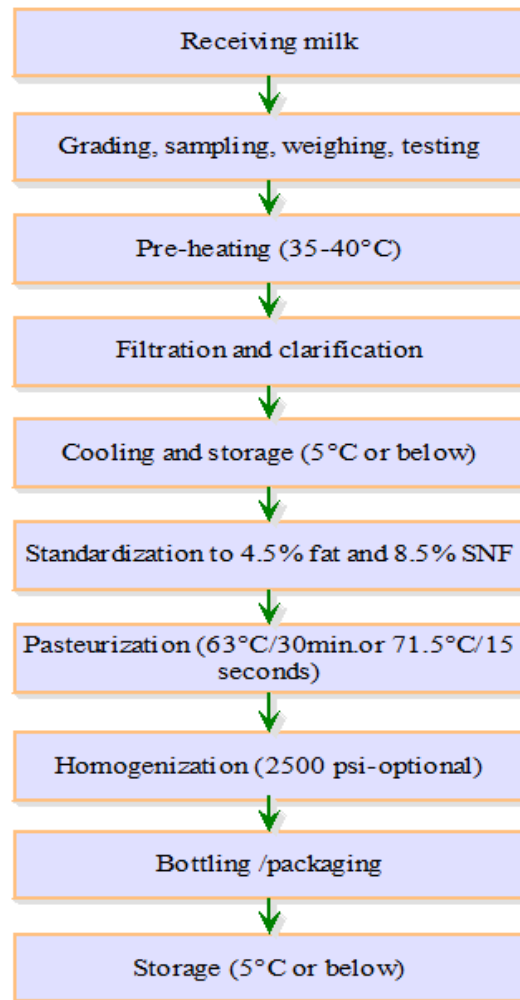

**Fig. 35.1 Flow diagram for preparation of standardized milk**

## 35.2 Flavoured Milk

Adding delectable flavour and befitting colour to milk makes it highly palatable and increases the sale of milk. When the term 'milk' is used, the product should contain a milk fat content at least equal to the minimum legal requirement for specific type of market milk. But, when the fat level is lower (i.e. 1-2%), the term 'dairy drink' may be used. The purpose is:

- to make milk more palatable to those who do not relish it as such
- to stimulate the sale of milk and
- to put skim milk to profitable use

The main types of flavoured milk are

- Chocolate milk/drink
- Fruit flavoured milk/drink
- Sterilized flavoured milk/drink

### 35.2.1 Chocolate milk/drink

In chocolate milk/drink, the following formula may be used:

1. Cocoa powder - 1 to 1.5%

2. Sugar - 7 to 9%
3. Stabilizer - 0.2% (Sodium alginate can be used)
4. Fat level: Milk – legal standards of milk  
Dairy drink - minimum 2% fat

### 35.2.1.1 Method of manufacture

The milk on receipt is standardized, preheated to 35–40°C and filtered/clarified followed by preheating to 60°C and homogenization at 175 bar (2500 psi). To the warm milk, the desired amounts of cocoa powder, sugar and stabilizer are slowly added and stirred so as to dissolve them properly. The cocoa powder may also be added in the form of syrup, and the stabilizer in the form of solution. Homogenization can also be done after addition of cocoa and sugar. But, this has the effect of increasing sedimentation. Stabilizer is usually added to delay or prevent setting of cocoa particles; it also helps in the prevention of cream rise. The mixture is then pasteurized at 71°C/30 min, cooled rapidly to 5°C, bottled and kept under refrigeration (5°C) until used. The bottles are invariably inverted up and down a few times before consumption.

### 35.2.2 Fruit flavoured milk/drink

Permitted fruit flavours/essences together with permitted (matching) colours and sugar are used. The method of preparation is similar to that used for chocolate milk/drink. The common flavours used are strawberry, orange, lemon, pineapple, banana, vanilla etc. Pure fruit juices or syrups can be satisfactorily combined with milk to form milk shakes. However, in order to obtain good results, the following precautions should be taken:

1. No acid (citric or tartaric) should be added to the fruit syrup, as this may cause curdling. The pH of the milk-syrup mixture should be about 5, which is safe from the curdling point of view.
2. Excessively sweet syrups should be avoided. The best sugar content of syrup is 45-55%.
3. Add 1 part of fruit syrup to 5 parts of milk. The fruits, which give good results, are strawberries, orange, lemon, pineapple, blackberry, raspberry and black currant.
4. Care should be taken to see that there is a pleasant blend of sweet fruits and milk flavours.

### 35.2.3 Sterilized flavoured milk

This combines the advantages of both sterilized and flavoured milk/drinks. The method consists of all the steps indicated in the chapter on 'sterilization'. In addition, in between clarification and filling, flavour or essence, permitted (matching) colour and sugar (syrup) are added and mixed into the milk (Fig. 35.2).

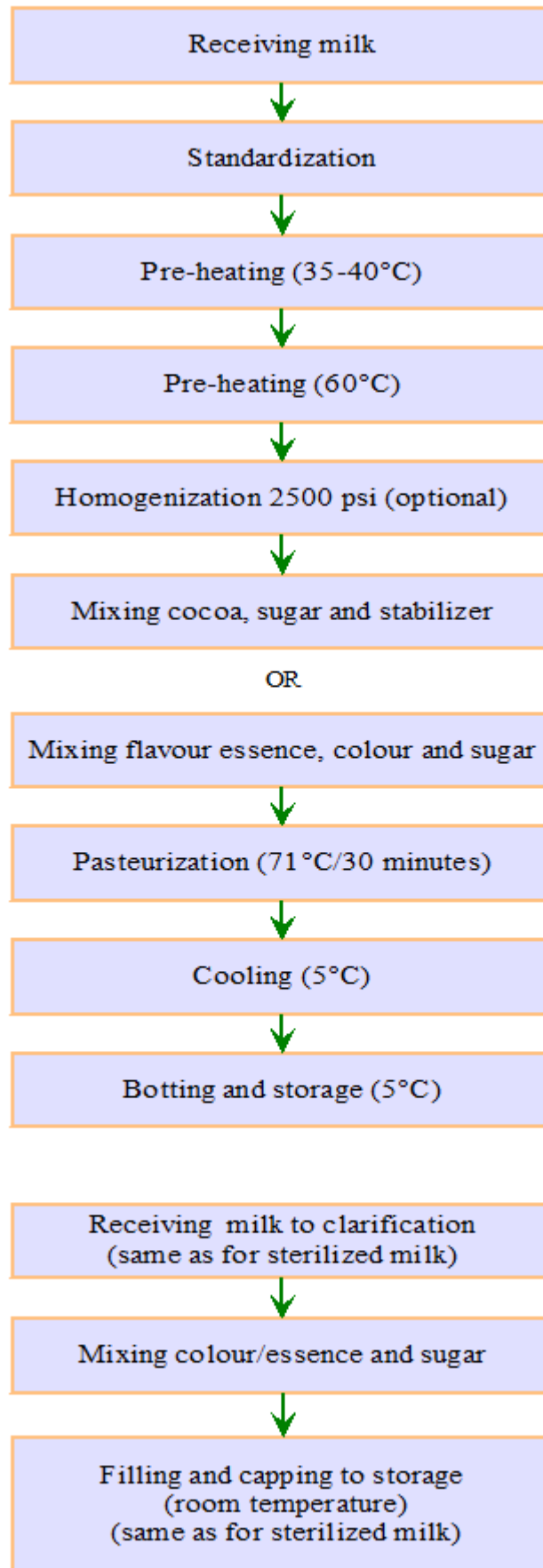

Fig. 35.2 Manufacture of sterilized flavoured milk

### 35.3 Reconstituted Milk

Reconstituted milk may be prepared either from skim milk powder (SMP) or whole milk powder by the addition of water. The composition especially fat:solids not fat ratio is adjusted equal to that of fresh skim milk or fresh whole milk. Whole milk powder possesses problems in reconstitution because of poor wettability. Therefore, reconstitution should be done with care. The temperature of water should be between 40-45°C. After reconstitution, it should be held for sufficient time, preferably for one hour, for proper hydration of powder particles. For greater convenience, instant powder in which wettability is increased by agglomeration, may be used. When skim milk powder is to be used after reconstitution for extending the fluid milk supply, e.g. in preparing recombined or toned milk, low heat SMP should be the choice. Reconstitution equipments involve the use of high speed agitators creating a vortex or a ventury type mixer and pump to speed up dispersion and solution of powder. Preparation of whole milk from whole milk powder after reconstitution is not as common as reconstituted skim milk because of certain special problems. Whole milk powder has poor wettability due to presence of fat, which is hygroscopic to water. The shelf life of whole milk powder is also limited.

#### 35.3.1 Advantages

1. It helps in making up the shortage of fresh milk supplies in developing countries.
2. It is useful for the armed forces posted at far-off places that are difficult to reach.

#### 35.3.2 Method of manufacture

A calculated amount of potable water is received in the pasteurizing vat/tank equipped with an agitator. The water is heated to 38-43°C, while the agitator is kept in motion. A calculated amount of skim milk powder (for reconstituted skim milk) or whole milk powder (for reconstituted whole milk) is slowly added at the time of agitation and the mixture is thoroughly agitated till it dissolves completely. Special powder mixture equipment may be used for this purpose. The mixture is, pumped through a filter, homogenized (in case of reconstituted whole milk), pasteurized at 63°C for 30 min and promptly cooled to 5°C or below until distribution (Fig. 35.3).

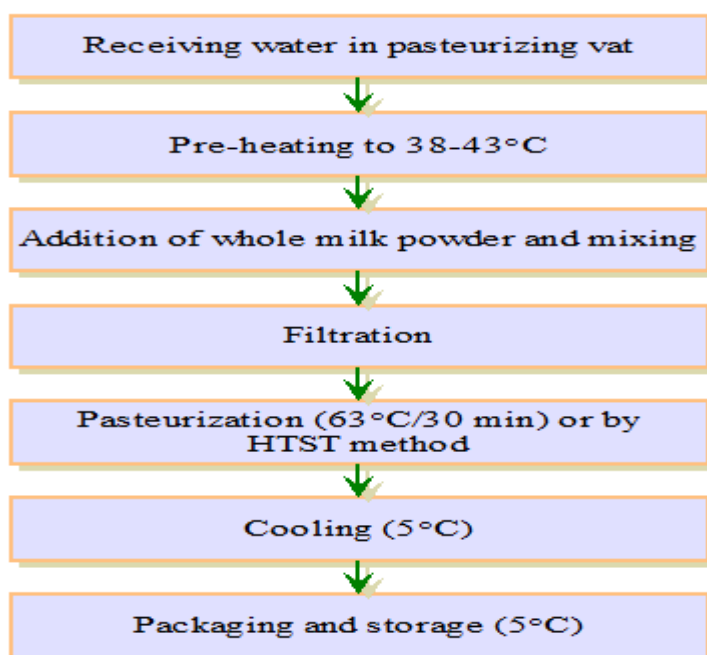

Fig. 35.3 Manufacture of reconstituted milk

Reconstitution is usually done by:

- Funnel or ventury system.
- Tri-blender or dry material-liquid blender system.

### **35.3.2.1 Funnel or ventury systems**

In this system, the water flows through a pipe to a jet which increases the velocity of the water flow. At the time of outlet from the jet, the powder flows from the hopper which is connected with the pipe into the high velocity stream of water. The jet acts as a ventury and creates a little vacuum to suck the powder from the hopper. The pipeline then returns to the holding tank so that the liquid circulates in the system until all the powder has been satisfactorily dissolved. A high speed centrifugal pump is used for re- circulation.

### **35.3.2.2 Tri-blender or dry material-liquid blending system**

In this system, thorough mixing of powder with water takes place in a centrifugal pump as the powder directly falls on to the pump impeller. This system is found to be most effective. The reconstituted skim milk is immediately chilled and stored.

## **35.4 Recombined Milk**

This refers to the product obtained when butter oil (also called anhydrous milk fat), skim milk powder and water are combined in the correct proportions to yield fluid milk. Fat may also be obtained from other sources, such as unsalted butter or plastic cream. The acceptability of recombined milk is influenced by the quality of anhydrous milk fat. Recombined milk serves as a mean of supplying fluid milk in non-dairy areas. The recombining process offers several advantages. It reduces transport cost, eliminates refrigeration, and lowers packaging cost besides helping in the development of local industries. The main market for recombined milk and milk products is in developing countries, where they make up for the milk shortages and also find increasing utilization in emerging situations.

### **35.4.1 Legal Definition**

Under the FSS Rules (2011), recombined milk shall contain a minimum of 3.0% fat and 8.5% SNF throughout the country.

### **35.4.2 Advantages**

- Help in making up for the shortage of fresh milk supplies in developing countries, especially in the lean seasons.
- Help to prevent the rise of the price of liquid milk in cities.

### **35.4.3 Recombination process**

The process for preparing recombined milk is given in Fig. 35.4.

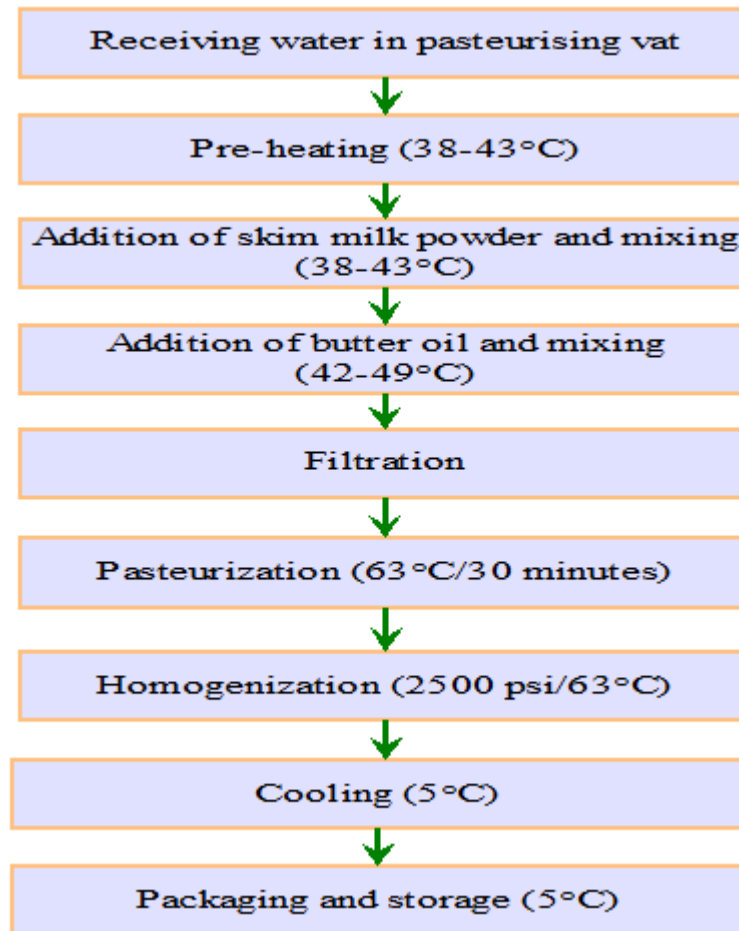

Fig. 35.4 Recombination process

### 35.4.3.1 Mixing of butter fat

The source of butterfat is usually butter-oil or unsalted white butter. The steps involved are:

1. Butter-oil tins are heated to above 50 to 55°C in a tank containing hot water with steam to liquefy the butter-oil.
2. The tins are opened or a few big holes are made on the lids.
3. The liquefied butter-oil is emptied out in the butter vat thoroughly.
4. Butter-oil is pumped to the butter-oil storage tank and heated to about 60 to 65°C.

The butter-oil is then injected into the milk stream at a speed set by a variable speed positive pump immediately prior to the homogenizer, which is connected to the pasteurizer. The milk-butter-oil mixture is homogenized by a two-stage homogenizer at 140 and 35 kg/cm<sup>2</sup>. It is then pasteurized and stored.

### 35.4.3.2 Blending with reconstituted milk

Pasteurized reconstituted skim milk in predetermined quantity enters the storage tank containing the previously processed milk batch (with butter-oil) and are blended. Final standardization is done so as to obtain the desired level of fat and SNF contents.

\*\*\*\*\* 😊 \*\*\*\*\*



**Lesson 36**

**COMMON DAIRY DETERGENTS AND THEIR PROPERTIES**

**36.1 Introduction**

Cleaning and sanitization are the two processes employed in dairy industry to ensure hygiene and product safety. Cleaning refers to the removal of soil from the surface of the equipment, while sanitization implies destruction of all pathogenic and almost all non-pathogenic organisms. Cleaning and sanitization are complimentary processes. Either of these operations alone does not help to achieve the desired result to make the equipment/other surface free from soil and viable organisms.

There are three commonly used classifications for the level of cleanliness: physically clean, chemically clean and microbiologically clean. A physically clean surface is visually cleaned to a satisfactory standard. This normally pertains to nonfood contact areas such as floor cleaning in warehouse areas and yards within the food processing zone. A chemically clean standard is applied to all applications within the food processing area. The plant is cleaned to a standard at which anything in contact with the cleaned surface faces no contamination. A microbiologically clean standard is required for all direct and indirect food contact surfaces. This standard involves a reduction in total viable colonies to an acceptable level, which varies from country to country. Detergents are used in conjunction with disinfectants/ sanitizers to achieve a microbiologically clean surface.

**36.2 Dairy Soil**

During the course of processing, milk constituents deposit on the surface of equipment. These deposits are typically known as 'dairy soil' and consist of milk or milk product residues, which may be more or less modified by the agents that come in contact with it, such as the processing treatment, water or cleaning materials previously used, dust, dirt or other foreign matters. The accumulated dairy soil comprises largely of fat, protein (precipitated, coagulated and baked-on by heat), insoluble calcium salts from water and/or detergent and bacteria. Dairy soils are composed of 42.0 - 67.0% ash, 3.6 - 18.0% fat, 4.5 - 44.0% protein and 2.7-8.7% moisture. Continued deposition of the soil leads to accumulation of larger and harder particles that are known as milk stones.

**36.3 Cleaning**

Cleaning reverses the soiling process and requires a supply of energy usually in the form of mechanical and/or heat energy. While water does most of the cleaning, cleaning compounds or detergents reduce the energy required for soil removal. A detergent is a substance that either alone or in a mixture, reduces the work requirement of a cleaning process. All cleaning protocols involve wetting of soiled surface by bringing the cleaning solution into intimate contact with the soil to be removed followed by displacement of the soil from the surface by solution, emulsification, saponification, peptization and/or mechanical action. The soil removed from the surface is then dispersed or removed in the solution by scattering, deflocculation or emulsification

and finally, the surface is rinsed to prevent re-deposition of the dispersed soil on the cleaned surface. Cleaning may be done by manual means, mechanically or by cleaning-in-place.

## 36.4 Detergents

Detergents assist the processes of washing and cleaning. A good detergent should be highly penetrable, be able to dissolve calcium salts deposited over the surface and keep them remain in solution to check re-deposition, possess moderate foam generation capacity, be non-corrosiveness and have a high bactericidal effect. It should also have the ability to soften water used for washing, good wetting power to assist the water to penetrate the greasy surface besides deflocculating and rinsing properties. It must also be non-corrosive and non-toxic. Although in general detergents are alkaline, acid detergents have to be employed to remove milk stones. Modern detergents are usually mixtures of more than one cleaning compounds. Detergents for use in the dairy industry can be divided into the following four general classes:

### 36.4.1 Alkaline detergents

Alkalis form the bulk of most dairy detergent compounds. The alkalis commonly used are soda, ash, caustic, soda, sodium bicarbonate, sodium metasilicate and trisodium phosphate. Soda ash, trisodium phosphate and sodium metasilicate in the ratio 12:5:3 make a very useful mixture for general cleaning in the dairy. For cleaning of aluminium or aluminium alloy equipment, a mild mixture containing trisodium phosphate, sodium bicarbonate and sodium metasilicate, in the proportion 2:2:1 is used. One part of these mixtures should be dissolved in 200 parts of water. A very good detergent for washing bottles is a mixture of 5-10% calgon (sodium hexametaphosphate) with sufficient caustic soda to give 1.5% alkalinity.

### 36.4.2 Water softeners

Hard water is not suitable for cleaning operations as some ingredients of the cleaning material precipitate the hard salts that adhere to equipment surfaces or settle at the bottom on standing. Hard water also causes spotting and promotes water-stone and milk-stone formation besides possessing soap-destroying and scale-forming properties. Replacing 5-10 parts of soda ash in the detergent mixture with an equivalent proportion of calgon takes care of the hardness in water.

### 36.4.3 Synthetic detergents

They have good surface-active and emulsifying properties and improve wetting or penetrating power by lowering the surface tension of water.

### 36.4.4 Acid cleaners

Acid cleaning agents are used in combination with alkaline agents to remove milk stone deposited on metal surface exposed to heat. Phosphoric acid, diluted with water (140 g in 45.3 kg) is very commonly used.

## 36.5 Selection of Detergents

The selection of detergents in a dairy plant is very important. There is no 'universal detergent' that could be applied to all situations. For example, sodium hydroxide-(caustic-soda)-based detergents, when in contact with aluminium, galvanized and other soft metal surfaces leads not only to rapid corrosion, but also to the release of hydrogen gas, which can form an explosive

mixture with air. Electrical installations and moisture sensitive processes require minimal use of water and therefore, detergents which contain non-toxic and non-tainting alcohols would be needed. The chemical composition of the local water supply will also affect the selection of detergents. With hard water, when alkaline detergents are used at elevated temperatures, there is a chance of scale deposition on plant surfaces. The result is unattractive and, if it occurs on a direct or indirect food contact surface, it may become a source of physical and microbial contamination. Sequestering and dispersing materials are used in alkaline formulations to prevent scale deposition. Several factors specific to individual applications also affect detergent selection. Fermentative applications, for example, will generate carbon dioxide, which will rapidly break down sodium hydroxide to sodium carbonates. These will subsequently precipitate as process generated scale.

In response to these challenges, formulated detergents meant for specific use and based on acids, alkalis or neutral materials have come to the market. Acids are effective in dissolving mineral salts and in the hydrolysis of proteins, while caustic alkalis will break down carbonized deposits and saponify fats and oils. Neutral materials such as sequestrants and surfactants are used to prevent precipitation of water hardness salts in hot or alkaline solutions, and for wetting of soil, soil penetration, soil suspension and surface tension reduction respectively. Table 36.1 lists some of the ingredients found in modern formulated detergents along with their applications.

**Table 36.1 Selected examples of ingredients in formulated detergents**

Detergent type	pH range	Common components in order of importance	Typical applications
Acidic	0-5	Phosphoric acid Nitric acid Sulphuric acid Hydrochloride acid Surfactants Microbiocide	Descalants, formulated acid detergents for low-pH (fermentation) applications, formulated detergents for light soil areas
Alkaline	10-13	Carbonates Silicates Phosphates Caustic sods Sequestrants Surfactants	CIP, tray-and crate-washing, floors
Caustic	13+	Caustic soda or potash Sequestrants Surfactants	CIP, HTST, cleaning, bottle-washing
Additives	1-14	Dependent on application	Added to existing detergent or rinsing applications. Categories include scale control, foam control, microbiostatic control (preservative)
Foam	1-14	Dependent on application	Specialized applications. Contact times not as long as gel but offers better visibility. Air is needed to generate foam either as secondary injection or by venturi action
Gel	1-14	Dependent on application	Specialized applications for long contact times. Materials are either self-gelling on dilution with water or are supplied as neat gels.
Neutral	5-10	Surfactants Phosphates Solvents	Manual hand-cleaning of plant surfaces and utensils, janitorial applications, personal hygiene products

Considering the environmental safety aspects of synthetic detergents, enzyme based cleaners which are biodegradable, less (or non-) toxic, non-corrosive, environmental friendly and with improved cleaning properties and stability in different formulations and sanitization are available in the market now. Proteases, amylases, lipases and cellulases make up the major portion of the market for industrial enzymes in cleaning applications to hydrolyse the respective biological material in dairy soils.



**Lesson 37**  
**DAIRY SANITIZERS AND THEIR PROPERTIES**

**37.1 Introduction**

Sanitization involves destruction of pathogens and minimizing microflora. It is aimed at reducing microorganisms to a level acceptable by public health authorities. Sanitizers are classified as thermal, radiation or chemical.

**37.2 Thermal Sanitizers**

Thermal sanitizers are very effective, their efficacy depending on the extent of microbial contamination, humidity, pH, temperature and time.

**37.2.1 Steam**

Although steam is effective as a sanitizer, its application is limited because of its high cost. By-products of steam condensation can cause hurdles in the cleaning operations. It is also difficult to regulate and monitor contact temperature and time.

**37.2.2 Hot water**

Hot water as a sanitizer is relatively inexpensive, easy to apply and readily available. It is relatively non-corrosive and penetrates into cracks and crevices and can be effective over a broad range of microorganisms. However, the process requires come-up and cool-down time and is, therefore, slow. The energy costs are high. Safety aspects also need to be taken care of. The process also has the disadvantages of forming or contributing to film formations and shortening the life of certain equipment or parts such as gaskets.

Hot-water sanitization is commonly used through immersion (small parts, knives, etc.), spray (dishwashers) or circulating systems. The temperature-time combination required depends on the application. Some typical regulatory requirements for use of hot water in dishwashing and utensil sanitization applications specify immersion for at least 30 sec at 77°C for manual operations, a final rinse temperature of 74°C in single tank and single temperature machines and 82°C for other machines. The Grade A Pasteurized Milk Ordinance specifies a minimum of 77°C for 5 min.

**37.3 Radiation**

Radiation in the form of ultra violet, high-energy cathode or gamma rays destroys microorganisms rapidly. UV rays in the wavelength of 25 Angstrom units has been used extensively in the form of a sterilizing lamp to destroy undesirable organisms for foods on assembly lines, bakeries and other similar applications. UV radiations (contact time just more than 2 min) are very useful on surfaces that are heat sensitive such as flexible packing materials.

### 37.4 Chemical Sanitizers

Chemical sanitizers are also called low-temperature sanitizers. The ideal chemical sanitizer for food contact surface application should have a wide range of activity, destroy microorganisms rapidly, be stable under all types of conditions, be tolerant of a broad range of environmental conditions, be readily soluble and possess some detergency and be low in toxicity and corrosiveness, and be inexpensive. As no available sanitizer meets all of these criteria, it is important to evaluate the properties, advantages and disadvantages of available sanitizer for each specific application. The most commonly used chemical sanitizers in dairy industry are chlorine, iodine and quaternary ammonium compounds (QACs).

#### 37.4.1 Chlorine-based sanitizers

Chlorine compounds are broad-spectrum germicides, which act on microbial membranes, inhibit cellular enzymes involved in glucose metabolism, have a lethal effect on DNA and oxidize cellular protein. Chlorine has activity at a low temperature, is relatively cheap, and leaves minimal residue or film on surfaces. It is non toxic, practically colourless, odourless and tasteless. Commonly used chlorine compounds include liquid chlorine, hypochlorites, inorganic chloramines and organic chloramines. The maximum allowable level for no-rinse applications is 200 ppm available chlorine, but recommended usage levels vary. For hypochlorites, an exposure time of 1 min at a minimum concentration of 50 ppm and a temperature of 24°C are recommended. For each 10°C drop in temperature, a recommended exposure time is doubled. For chloramines, the recommended combination is 200 ppm for one min.

The activity of chlorine is severely affected by factors such as pH, temperature and organic load. It is also relatively resistant to water hardness when compared to other sanitizers, especially the QACs. The major disadvantage of chlorine compounds is corrosiveness, particularly at higher temperatures, to many metal surfaces. Health and safety concerns include skin irritation and mucous membrane damage in confined areas. At low pH (below 4.0), the deadly mustard gas (Cl<sub>2</sub>) can form. Recent concerns also include use of chlorine as a drinking water disinfectant and as an antimicrobial agent in meat products, which may lead to the formation of potentially carcinogenic trihalomethanes (THMs) under appropriate conditions.

#### 37.4.2 Iodine

Iodine sanitizers have been in use since the 1800s. The most active agent, but not too stable, is the dissociated free iodine most prevalent at low pH. Iodine sanitizers exist in many forms, usually with a surfactant as a carrier. These mixtures are called iodophors, which like chlorine compounds, have a very broad spectrum activity against bacteria, viruses, yeasts, molds and protozoans. Recent theories on bactericidal activity of iodine suggest cell wall damage and destruction of microbial enzyme activity although earlier it was thought that it is through direct halogenation of proteins. Generally recommended dosage for iodophors is 12.5 to 25 ppm for one min.

The degree to which iodophors are effective depends on properties of the surfactant used in the formulation. Iodophors are more resistant to organic matter and water hardness than chlorine. However, high pH leads to loss of activity. Iodine has limited solubility in water. It is limited to lower temperature applications, as it vaporizes at 48.8°C. Iodine can also cause staining on some surfaces such as plastics. Although iodine has a long history of use in wound treatment, ingestion of the gas poses toxicity risks in closed environments.

### 37.4.3 Quaternary ammonium compounds (QAC)

Quaternary ammonium compounds (QACs) are neutral disinfectants. QACs are a class of compounds, which have the general structure as depicted in Figure 37.1. The properties of these compounds depend upon the covalently bound alkyl (R) groups, which can be highly varied. The length of the carbon chain of R-group is directly related with sanitizer activity in QACs. Since QACs are positively charged cations, their mode of action is related to their attraction to negatively charged materials such as bacterial proteins.

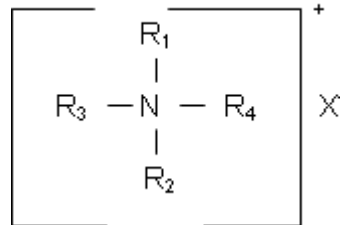

**Fig. 37.1. General structure of QACs**

QACs are readily soluble and non-toxic, non-corrosive and surface active, very sensitive to organic matter (presence of milk solids improves their lethality) and do not affect sensory properties of the product. They are effective against bacteria, yeasts, mold and viruses. Some applications leave a residual antimicrobial film, though this is a disadvantage in the manufacture of cultured dairy products and cheese. QACs are more active against gram positive than gram-negative bacteria. They are not highly effective against bacteriophages. Their incompatibility with certain detergents makes thorough rinsing following cleaning operations essential. Many QAC formulations can cause foaming problems in CIP applications. QACs pose very little toxicity or safety risks under recommended usage and are commonly used as environmental fogs and as room deodorizers. These compounds are active and stable over a broad temperature range. Because they are surfactants, they possess some detergency and are, therefore, less affected by light soil than other sanitizers, though heavy soil decreases activity significantly. QACs are more active at alkaline pH. Most QACs are intolerant to hardness in water. This can be improved by the use of EDTA as a chelator.



**Lesson 38**

**CLEANING AND SANITIZATION PROTOCOLS - CIP AND SIP**

**38.1 Cleaning-In-Place (CIP) Systems**

The manual cleaning of dairy equipments done by people equipped with brushes and cleaning solutions is a laborious and ineffective practice. Cleaning-in-place or CIP refers to cleaning of all sanitary pipelines by circulation. It may be defined as circulation of cleaning liquids through machines and other equipments in cleaning circuits without dismantling the equipment. The high velocity flow of liquid over equipment surface generates mechanical scrubbing effect that dislodges deposits from vessels and pipelines. The majority of cleaning and sterilizing liquids used in CIP systems are alkali or acid based. Automated CIP systems allow accurate dosing of the concentrated cleaning agent, normally into water, to give a low strength solution suitable for cleaning process plant. This solution is used within the plant to clean and sometimes, sterilize the system prior to the next production run. CIP can be carried out with automated or manual systems.

**38.1.1 Single pass systems of CIP**

New cleaning solution is introduced to the plant to be cleaned for each cleaning cycle and then disposed to drain. It would start, in most cases, with a pre-rinse to remove as much soil as possible, followed by the detergent cleaning and a final rinse.

**38.1.2 Recirculation system of CIP**

The cleaning solutions are mixed in external tanks and introduced into the plant to be cleaned. They are recirculated and topped up as required until the cleaning cycle is complete. It is normal to carry out a final rinse after the detergent rinse. Recirculation systems need more initial investment, but use less water and cleaning detergents.

**38.2 Cleaning Cycle**

The sequence of events that are carried out in a dairy through CIP program for different circuits is as follows:

1. Recovery of product residue by drainage
2. Expulsion of non-retrievable residue with water or compressed air
3. Warm water (50-60°C) rinse for 10 min
4. Circulation of alkaline detergent (0.5-1.5% solution) at 75°C for 30 min
5. Warm water (50°C) rinse for 5-8 min
6. Circulation of acidic detergent (0.5-1.0% solution) at 75°C for 20 min
7. Warm water (50°C) rinse for 5-8 min
8. Thermal disinfection (90-95°C) and cooling for 10 min or chemical disinfection with a suitable sanitizer

Soda ash, caustic soda, sodium metasilicate or complex phosphates and a non-foaming surfactant may constitute an alkaline detergent for CIP cleaning. Sufficient hypochlorite solution to produce 25 to 50 ppm available chlorine may be added to help remove milk stones from metal surfaces.



Acid solution may be used every 4 to 7 days in cold milk lines, while acid treatment should be a daily chore in cleaning hot milk lines.

### 38.3 CIP Systems

Generally the CIP station consists of equipment for storage of different cleaning fluids and their distribution to various CIP circuits. Small dairy plants with short communication lines use centralized system by a network of pipes to all CIP circuits in the dairy. De-centralized CIP system (satellite system) is normally prevalent in large dairies where the distance between CIP stations and secondary CIP circuits are extremely large.

### 38.4 Advantages of CIP

The major advantages of implementing CIP are:

1. Guaranteed and repeatable quality assurance
2. Provision of full data logging for quality assurance requirements
3. Reduction in cleaning costs by recycling cleaning solutions
4. Possibility to clean inaccessible areas on equipment
5. Better safety to operators because hazardous cleaning materials are not handled
6. Reduction in time between two production runs. Safety-operators are not required to enter the plant to clean it.
7. Reduction in labour requirements
8. More effective use and control of cleaning materials
9. Reduction in water consumption

### 38.5 Sterilization-In-Place (SIP)

Sterilization-in-place (SIP) refers to a continuous commercial scale operation, where essential units can be sterilized. They are very sophisticated in terms of design, installation and operation and needs highly qualified manpower. In addition, the process equipment, pipe work and steam supply equipment must meet preset specifications for materials and for pressure and temperature resistance. The steam has to be extra pure and must pass through a micro-filter before use. The steam quality and cleanliness must be maintained by the use of pressure-grade stainless steel or Teflon®-lined tubing and appropriately constructed pressure control, shut-off valves and pressure gauges.

### 38.6 SIP Process

Steam under pressure is passed through the entire installation. Air is vented out through vents in the piping or on the equipment. The vents are protected by bacterial filters and remain closed after a suitable period of steaming to allow the steam pressure to build up to a predetermined level. Pressure is maintained for the length of the required period, after which the steam is released through a condenser. The recorded pressure is enough to and must result in achieving the desired time-temperature combination for destruction of all contaminants, as indicated by temperature sensors. The installation is inspected and revalidated at regular intervals to ensure efficiency of the system.

\*\*\*\*\* 😊 \*\*\*\*\*

Lesson 39  
DETERGENTS AND SANITIZERS

**39.1 Introduction**

Detergents and sanitizers are used in the cleaning and maintenance of safety levels in a dairy plant. It is important to monitor the strength of these solutions that are used in the dairy so as to ensure the efficacy of the cleaning programme.

**39.2 Determination of Strength of Washing Solution (Alkalinity Test)**

The strength of washing solution is generally expressed in terms of NaOH as it is often used as such or in combination with other chemicals. Repeated usage of washing solutions in automatic machines generally gets diluted. It is important to maintain the proper alkalinity of detergent solution for efficient cleaning and germicidal effects. An alkali equivalent to 1.5% NaOH is generally used for glass bottles and 0.5% for can washing.

**39.2.1 Qualitative test**

To 10 ml of detergent solution in conical flask, add 12.5 ml of 0.1 N hydrochloric acid and 5 drops of 0.5% phenolphthalein indicator. If the mixture turns red, it indicates alkalinity greater than 0.5% as caustic soda, which is sufficient.

**39.2.2 Quantitative test**

**39.2.2.1 Direct reading method**

This is a quick method that can be used daily. Take 10 ml of detergent solution in a 100 ml conical flask and add 5 drops of phenolphthalein indicator. Titrate with 2.5 N sulphuric acid until solution becomes colourless. The quantity in ml of acid used for titration is a direct indicator of percent alkali as NaOH.

**39.2.2.2 Laboratory method**

Take 5 ml of washing solution in 250 ml volumetric flask and makeup the volume with distilled water. After mixing well, transfer 50 ml of this solution in a 100 ml conical flask, add few drops of phenolphthalein indicator and titrate against 0.1 N sulphuric acid to colourless solution. Record ml of acid used as X. Add few drops of methyl orange indicator and continue titration till appearance of slight pink colour. Note ml of acid used as Y.

$$\% \text{ free caustic} = (X-Y) \times 0.4$$

$$\% \text{ total alkali} = (X+Y) \times 0.4$$

**39.3 Determination of Strength of Sanitizer**

The strength of sodium hypochlorite, which is widely used as a sanitizer in the dairy industry, is expressed in terms of the available chlorine in it. The strength of stock solution of chlorine is about 35% in terms of available chlorine. As the strength of chlorine solution decreases on storage, it is

necessary to check its strength regularly. The method to determine available chlorine in solution is based on reaction between available chlorine from hypochlorite solution and acidified potassium iodide solution, as a result of which iodine is liberated. Available chlorine which is liberated by the addition of acid liberates an equivalent amount of iodine from potassium iodide which produces yellowish brown colour upon titration with sodium thiosulphate solution using starch as indicator.

Stock solution of sanitizer: Weigh 10 g of bleaching powder, convert into paste with small quantity of water and transfer the contents quantitatively to 250 ml volumetric flask using distilled water. Make up the volume and mix well.

Take 10 ml of stock sanitizer solution in a 250 ml volumetric flask and make up the volume with distilled water. To 25 ml of diluted solution in a 250 ml conical flask, add 2 g potassium iodide crystal followed by 10 ml glacial acetic acid. Titrate the contents with 0.1 N sodium thiosulphate until brown colour changes to light straw yellow (Reading X). Add 1 ml of 1% starch solution and continue titration till colour disappears (Reading Y). Record volume of thiosulphate used as V ml (X+Y). Make a blank determination using same reagents and deduct the titre value from V.

1 ml of 0.1 N sodium thiosulphate  $\simeq$  0.003546 g available chlorine

V ml of 0.1 N sodium thiosulphate  $\simeq$  V x 0.003546 (chlorine from 25 ml solution)

Chlorine in 250 ml solution = V x 0.003546 x 250 / 25

= V x 0.03546 (chlorine in 10 ml stock solution)

Chlorine in 250 ml stock solution = V x 0.03546 x 250 / 10

= V x 0.8865 (chlorine in 10 g bleaching powder)

Percent chlorine in bleaching powder = V x 0.8865 x 100/10

= 8.865 V (%).

\*\*\*\*\* 😊 \*\*\*\*\*

### Lesson 40 PACKAGING - MATERIALS AND PROCESS

#### 40.1 Introduction

Milk being extremely perishable product requires suitable packaging to preserve its initial quality for a predetermined length of time. Milk has been packaged in different types of containers throughout the world. Milk is sold in flexible packages like cartons, bags, pouches, plastic bottles, jars etc. The unique advantages offered by the plastic packages are that they have good barrier properties, permit visibility of the contents, are light in weight, can be used for single service, are easy to carry home, are more economical and can be made more attractive. The use of plastic containers eliminates noise normally encountered in the milk bottling plants and during delivery, and also reduces water pollution caused by milk residues and detergents used in the bottle washing process.

At present, only 15% of all milk produced is packaged by the commercial dairy industry and the flexible pouch accounts for approximately 92% of total marketing. Marketing of liquid milk in India is quite difficult, keeping in view the agro-climatic conditions (high ambient temperature) and poor infrastructure for transportation. Concerted efforts are needed to improve overall quality of packaged fluid milk in India, which will prevent colossal wastage of milk due to inferior packaging. In the light of technological advances in India and abroad in the dairy sector, the success of dairy business is deeply anchored in the packaging system. Inadequate packaging leads to rapid degradation of product's quality.

#### 40.2 Definition

Packaging may be defined as a means for protection and prolongation of shelf-life of a particular food item, so that it may be transported without any hassle.

#### 40.3 Purpose

Packaging serves the following purposes:

1. to contain and protect the product during handling and storage thereby increasing shelf life
2. to inform consumers about product quality and facilitate transportation
3. to attract the attention of consumers and increase sale
4. to prevent scope of adulteration (tamper proof system)

The name, trade name, description of food contained in the package, the name and business address of the manufacturer etc. are printed on the package. A statement about the addition of preservative and its class, permitted colouring agent/antioxidant/vitamins, anticaking agent/stabilizing agent/emulsifying agent/minerals, chemical composition of product and the amount of energy supplied by the product, the net weight or number or volume of contents, batch number or code number are also mentioned on the package.

## 40.4 Different Packaging Materials

Common packaging materials for market milk industry are:

(i) Glass (ii) Plastics (iii) Coextruded and multilayered packaging materials

### 40.4.1 Glass

Earlier market milk was distributed in glass bottles. The bottles could be reused after adequate cleaning in a mechanized bottle washing machine. Glasses are generally of two types: (a) transparent and (b) opaque. Glass does not react chemically with the product contained in it. It has excellent barrier property. Besides this, the transparent bottles provide clear visibility of the product inside it. But glasses are brittle in nature, prone to breakage during transportation, handling and even mechanized cleaning. Moreover, they are heavier than plastics/paper packs. Sterilized flavoured milk drinks are still being packaged in heat-resistant glass bottles in India. Presently, flexible polymeric containers have replaced glass bottles for packaging of milk.

### 40.4.2 Plastics

It has made a revival in the packaging industry and is the most popular material for packaging of market milk. Plastic packaging materials include polyolefins, LDPE (Low density polyethylene), LLDPE (Linear low density polyethylene), HDPE (High density polyethylene), HMHD (High molecular high density) polyethylene, BOPP (Biaxially oriented polypropylene) films, PET (Polyethylene Terephthalate) films, MPET (Metallized Polyester) films, MPP (Metallized Polypropylene) films etc.

These are flexible in nature and are mostly used as wrapper or sachets, bags or pouches. It protects the food from microorganisms, insects, etc. It controls humidity of the dairy products. Some of these packaging materials are discussed below:

#### 40.4.2.1 LDPE

Earlier, single layer LDPE film was used. However, there was a lot of wastage of milk and film, due to pin-holes and poor puncture resistance of the film. Later, coextruded double layer LDPE films with lower incidence of pin-holes was adopted that helped to reduce the wastage.

#### 40.4.2.2 Butane LLDPE

In 1970, Butane LLDPE was introduced to the packaging industry. Eventually, it earned popularity over LDPE because of its puncture resistance, better sealing characteristics and mechanical properties. It has four carbon atoms, of which two align themselves to the backbone, while the other two impart improved physical, mechanical and sealing properties.

#### 40.4.2.3 Octane LLDPE

When blended with 50% LDPE, octane LLDPE provides excellent puncture resistance, superior seal strength and is also amenable to low temperature storage. It has eight carbon atoms, of which two align themselves to the backbone and six carbon atoms introduce long and tightly packed branching. The higher the heat seal strength (HSS) of octane LLDPE, lower is the chance for

leakage after packaging and during transportation. Octane LLDPE with excellent hot tack can withstand the load and handle high speed packing with minimal or zero leakage. Hot tack is the strength of a heat seal immediately after sealing while still in a hot condition, i.e. before it has cooled down to ambient temperature and achieved its final strength. It saves the cost of packaging.

#### 40.4.3 Coextruded and multilayered packaging materials (Laminates)

It is a combination of two or more different films. Laminations are done for strengthening the film material, to improve grease-resistance and to increase barrier properties. Some of the laminates are polyethylene/paper, polyethylene/aluminium foil/polyethylene etc.

#### 40.5 Different Packaging Forms

Of the different forms used for milk packaging, flexible pouches dominate with 92% market share and are the easiest, safest and most cost-effective option. The remaining comprises of glass bottle (7%) and Tetra-paks for UHT products (1%).

#### 40.6 Aseptic Packaging

Aseptic packaging refers to a technique in which previously sterilized food is aseptically packaged in a sterile package and hermetically sealed to have prolonged shelf life even under ambient conditions.

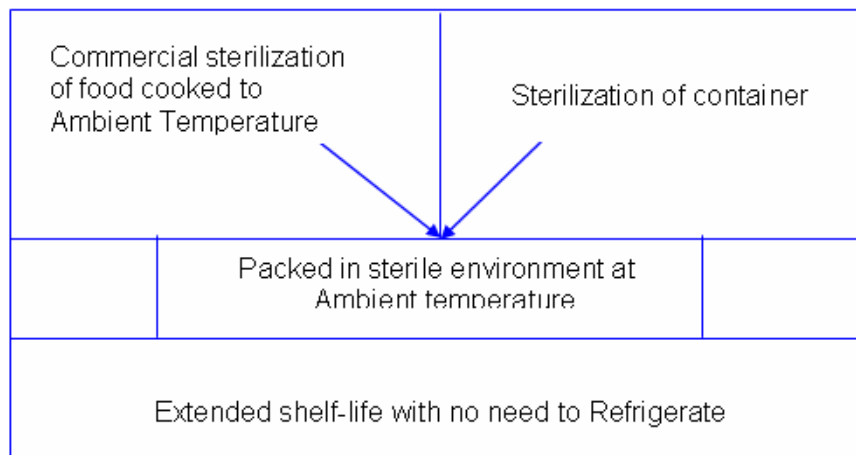

Fig. 40.1 Basic flow of an aseptic process

Aseptic package started in Sweden nearly 50 years ago. Tetra Pak was the first company to introduce the aseptic packaging to the market. Now, more than 80% of the aseptically packed products are from Tetra Pak. The food items remain safe upto 6 months in aseptic package without refrigeration. The Tetra Pak packaging materials comprise of six layers in the following order from the outside: (i) polyethylene (ii) paper (iii) polyethylene (iv) aluminium foil (v) adhesive polymers and (vi) polyethylene, all of which work together to keep the product fresh. The innermost polyethylene layer forms the seal that makes the package liquid tight, while the exterior layer keeps the package dry. The adhesive polymer acts as glue between the aluminium foil and inner polyethylene layer. Aluminium foil (6% of the package) forms a barrier against light and oxygen.

### 40.7 Fino (Fibre pillow) Package

One of the important packages for market milk industry is Fino-aseptic package. Fino is tailored to provide cost-effective alternative packaging to dairy industry by bringing revolutionary improvement in the efficiency and economy of milk distribution.

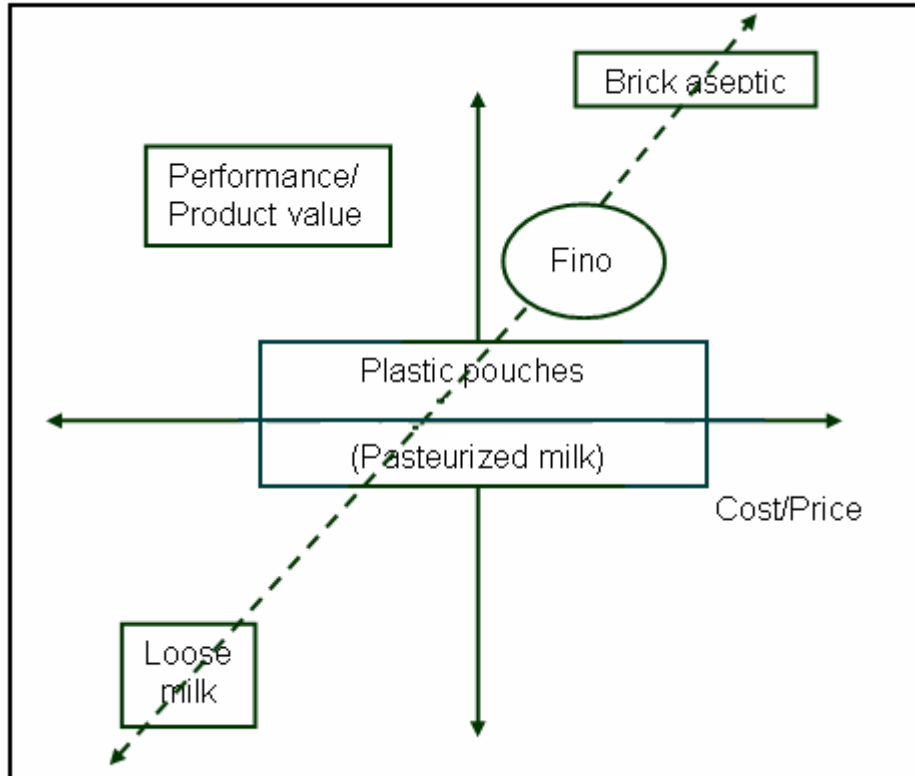

Fig. 40.2 Different alternatives in fluid milk packaging

Fino package is a multilayered fibre based tamper-proof aseptic pack with its shape similar to a plastic pouch. This package has six protective layers to extend the shelf-life of UHT milk, which allows transportation and distribution of milk at ambient temperature.

#### 40.7.1 Fino packaging material

The packaging material for Fino pouch is laminate of paper, aluminium foil and polyethylene. All three components form the six-layer laminate, to provide an effective barrier to microorganisms and external hazards such as sunlight and oxygen. Fino packaging concept is presented in Fig. 40.3.

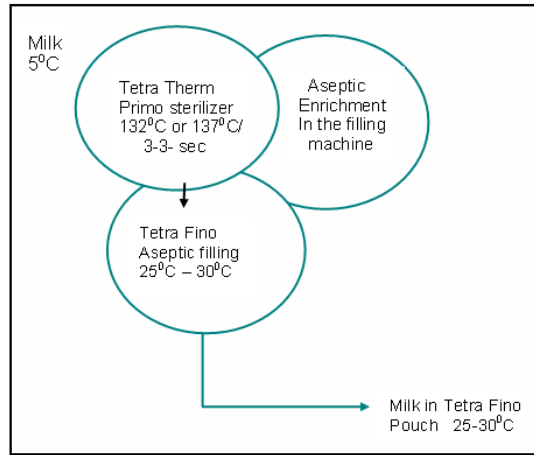
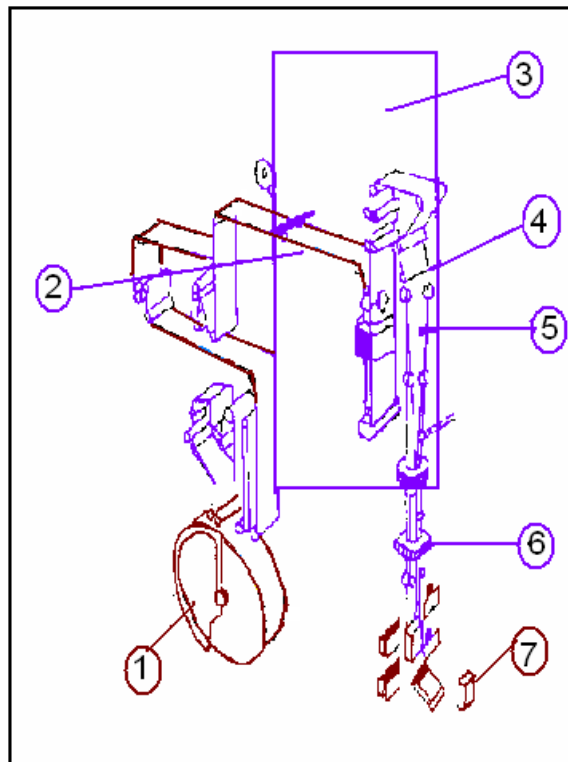

Fig. 40.3. Fino packaging concept

### 40.7.2 Process of filling

There are four sections of filling used in Fino packaging:

1. feeding of the packaging material into the filler
2. application of hydrogen peroxide (H<sub>2</sub>O<sub>2</sub>) - concentration and means to evaporate the same to have no residual traces
3. forming the packaging material tube
4. evaporation of hydrogen peroxide and filling under aseptic environment



1. Continuous paper feed
2. Sterilization of flat packaging material web
3. Few machine parts in the aseptic area
4. Tube formed in a sterile environment
5. Simple filling of the products
6. Package formed and sealed under the product level
7. Tetra fibre pillow

Fig. 40.4 Fino filling machine



## 40.7.2.1 Feeding of the packaging material into the filler

The packaging material is supplied in roll form to the filling machine and travels up to the backside of the machine. A strip is applied to one edge of the packaging material. This strip has two functions: (i) to reinforce the longitudinal seam and (ii) to prevent the product from coming into contact with paper layer.

## 40.7.2.2 Application of hydrogen peroxide

After the initial section, a film of  $H_2O_2$  is applied on the interior side of packaging material (six ply) by a transfer roller system. For this purpose, 35%  $H_2O_2$  is used along with a wetting agent. The purpose of this  $H_2O_2$  bath is to sterilize the packaging film.

## 40.7.2.3 Forming the packaging material tube

The packaging material tube now passes the top of the filling equipment and is formed into a tube on its way down to the tube heater and to the transversal sealing area. During production, sterile air is constantly blown into packaging material tube, creating a sterile air curtain in front of the food contact surface of the packaging material.

## 40.7.2.4 Evaporation of hydrogen peroxide and filling under aseptic environment

Generally, a pair of pressure rollers removes the surplus hydrogen peroxide. While working down, the remaining  $H_2O_2$  is evaporated by heat through tube heater. After the packaging material passes the tube heater element, its surface becomes dry and sterile.

## 40.8 PET (Polyethylene Terephthalate) Packaging

PET bottles give a perfect finish, making the bottles re-closable without leakage. They neither contribute to off-flavour nor impart plastic taste. They are clear, transparent, recyclable, eco-friendly and are available in various design or forms. They have excellent oxygen barrier property. In monolayer PET bottles, the shelf-life of milk may be extended upto 30-90 days. These can be either clear bottles, or for some sensitive flavours, colour may be added for light protection. For UHT milk, shelf-life up to six months can be achieved with PET bottles stored at ambient temperature. However, a light barrier is a must to prevent degradation of milk. For pure white milk, multilayer PET bottles or monolayer bottles with full light barrier are used. Milk fortified with vitamins can be kept safe in multilayered PET bottles, having light and oxygen barrier.

## 40.9 Retort Packaging

It is oldest process and is still used by major dairies to package flavoured milks, which involve filling milk into heat resistant glass/polyethylene bottles and then sealing them with air-tight and pressure resistant caps.

Convert in PDF By:  
*AgriMoon.com Team*

**Lesson 41**

**QUALITY ASSESSMENT OF RAW MILK**

**41.1 Introduction**

Milk being a product of biological origin, is extremely vulnerable to attack by microbes. It is also a good vehicle for additives and adulterants without any apparent changes in its appearance. Thus, milk is prone to several post-secretion changes, some natural and some man-made. Most dairy plants usually follow chemical quality control with the intention of payments to contractors/producers, processing of milk and meeting mandatory requirements for end products.

**41.2 Quality Assessment of Raw Milk**

The quality of dairy products depends upon quality of raw milk used in their manufacture, processing and handling. The poor socio-economic conditions of the rural producers pose serious problems in producing raw milk of good quality, which is further deteriorated during subsequent handling and transportation. The quality of the incoming raw milk is assessed to check its suitability for processing through various quick tests called 'platform tests'. Samples are drawn from the milk supplied by each producer and certain tests performed to assess its acceptability.

**41.2.1 Visual and sensory tests**

Milk received at the dairy plant is thoroughly screened for the presence of any objectionable material floating on top of the container. It is also tested for any objectionable flavour by taking 20-30 ml of milk in the mouth and rolling it in the palate and mouth cavity for assessing taste and flavour, which should be typical of milk.

**41.2.2 Sediment test**

This test assesses the cleanliness of milk received at the dairy plant and is performed by using a sediment tester. A sediment disc is inserted in the space provided and the tester is dipped to the bottom of the can. Milk is collected slowly from different parts of the bottom of the can by pulling the plunger upwards. The sediment tester is then removed and the plunger pressed down to empty the tester. The sediment disc is removed and compared with standard sediment disc. Alternatively, it may also be weighed and compared to the weight of an unused sediment disc. The milk is graded in accordance to standard as per Table 41.1 below.

**Table 41.1 Standards for sediment (BIS)**

Quantity of sediment (mg)	Grade
0.0	Excellent
0.2	Good
0.5	Fair
1.0	Poor
2.0	Very Poor

#### 41.2.3 Clot-on-boiling (COB) test

COB test indicates the suitability of milk for pasteurization and other heat treatment processes. Five ml of milk in a test tube is held over a flame and allowed to boil. The formation of flakes or clots indicates that the milk has high developed acidity and is unsuitable for pasteurization or high heat treatments.

#### 41.2.4 Alcohol test

Milk intended for high heat processing such as condensing and UHT processing has to be highly heat stable. Milk sample (5 ml) is mixed well with equal amount of ethyl alcohol, and observed for formation of flakes or clots. Formation of small flakes indicates that the milk is abnormal either due to high acidity or disturbed salt balance. Such milk is not suitable for high heat treatment.

#### 41.2.5 Alcohol-alizarin test

This test illustrates the suitability of milk for high heat treatment and also gives an idea about its acidity. To 5 ml milk in a test tube is added an equal amount of alcohol-alizarin solution (0.2%). The contents are mixed and observed for formation of flakes and colour and the observations matched with the following table (Table 41.2).

**Table 41.2 Observation chart for Alcohol-alizarin test**

Range of colour	Presence of flakes	Approximate acidity (%)
Brown red	Nil / no	0.16
Red to Yellow	--	0.18 – 0.36
Reddish brown	small	0.20
Yellowish brown	small	0.24
Brownish yellow	large	0.28
Yellow	large	0.36
Violet	-	Alkaline

## Lesson 42

### DETECTION OF PRESERVATIVES, NEUTRALIZERS AND ADULTERANTS

#### 42.1 Introduction

Though addition of any kind of preservative is not legally permitted in India, suppliers add various kinds of preservatives (e.g. hydrogen peroxide, formalin/formaldehyde etc.) to milk in order to increase its shelf life. Similarly, several neutralizing agents (e.g. sodium/potassium hydroxide, sodium carbonate/bicarbonate etc.) are added to mask the developed acidity in milk. Various adulterants such as starch, cane sugar, maltodextrin etc., which are not native to milk, are added to increase or maintain the prescribed levels of SNF and TS. There are several tests designed to detect the presence of such extraneous materials in milk.

#### 42.2 Detection of Common Preservatives

##### 42.2.1 Boric acid and borates

When a strip of turmeric paper is dipped into adulterated milk sample that has been acidified, it turns into characteristic red colour indicating the presence of boric acid and or its salt.

##### 42.2.2 Formalin or formaldehyde

Formalin is added in milk as a preservative, as it checks the rise in acidity. Acidified milk containing formalin or formaldehyde forms characteristic violet colour with ferric salts and other oxidizing agents. There are mainly two tests namely Hehner and Lech tests that are commonly followed.

###### 42.2.2.1 Hehner test

To 10 ml of the milk sample, 0.5 ml of 10% ferric chloride solution is added. Thereafter, 5 ml of concentrated sulphuric acid is added carefully down the side of test tube to form a separate layer without mixing with milk. Presence of a violet coloured ring at the junction of two liquids indicates the presence of formaldehyde.

###### 42.2.2.2 Lech test

To 5 ml of milk in a test tube is added equal volume of concentrated hydrochloric acid containing 1 ml of 10% ferric chloride solution. The contents are heated over a flame for 5 min and the tube rotated or shaken to break the curd. Development of violet colour indicates the presence of formaldehyde.

##### 42.2.3 Hydrogen Peroxide

Hydrogen peroxide acts as an antimicrobial agent thereby, checking the development of acidity. Addition of 2 drops of 2% freshly prepared aqueous solution of paraphenyl diamine hydrochloride to the adulterated milk sample gives intense blue colour, thus indicating the presence of hydrogen peroxide.

## 42.3 Neutralizers

Chemicals such as carbonates or bicarbonates are added to milk in order to disguise developed acidity. To detect their presence, equal quantities of the milk sample and ethyl alcohol are mixed to which are added, few drops of aqueous rosolic acid solution. Presence of rose red colour indicates addition of sodium hydroxide, potassium hydroxide and/or calcium hydroxide while pink colour points to the addition of sodium bicarbonate, potassium carbonate or calcium carbonate.

## 42.4 Detection of Common Adulterants

### 42.4.1 Sugar

Resorcinol produces red colour with sucrose in an acidic medium. To 10 ml of milk in a test tube, one ml of concentrated hydrochloric acid is added and mixed well, followed by addition of one g resorcinol powder. After mixing thoroughly, the tube is placed in a boiling water bath for 5 min. Development of red colour indicates presence of cane sugar in milk.

### 42.4.2 Starch

Iodine solution gives intense blue colour with starches. Three ml of well-mixed milk is boiled over a Bunsen burner. After cooling, one drop of 1% iodine solution is added and mixed well. The appearance of an intense blue or bluish violet colour indicates the presence of added starch.

### 42.4.3 Urea

There are two methods by which added urea can be detected in milk. To 5 ml of well mixed milk sample, 5 ml of para-dimethylamino benzaldehyde solution is added and mixed. The development of an intense yellow colour indicates the presence of urea.

In the second method, 5 ml of 24% TCA solution is added to 5 ml of well-mixed milk sample in a test tube. The contents are filtered through Whatman No. 42 filter paper, and 2% of NaOH solution and 0.5 ml of 2% sodium hypochlorite solution are added to one ml of the filtrate. After thorough mixing, 0.5 ml of 5% phenol solution is added. The development of blue or bluish-green colour indicates the presence of urea.

Recently a strip test for detection of urea has been developed by CCS Haryana Agricultural University, Hisar. This test involving mixing a drop of the test reagent with a drop of milk on a paper strip makes it convenient to detect urea in milk even at household level.

### 42.4.4 Glucose

Glucose is increasingly being used as an adulterant in milk and for the manufacture of synthetic milk. To 1 ml of milk in a test tube, one ml of Barford reagent (24 g cupric acetate dissolved in 450 ml boiling distilled water, 25 ml of 8.5% lactic acid added to the hot solution, cooled and diluted to 500 ml, filtered) is added. The mixture is heated in a boiling water bath for 3 min and cooled for 3 min under ice cold water. On addition of one ml of phosphomolybdic acid reagent (35 g of ammonium molybdate, 5 g of sodium tungstate in a one litre volumetric flask, 200 ml of 10% NaOH and 200 ml of distilled water added, boiled vigorously for 20-40 minutes and cooled followed by addition of 125 ml of concentrated phosphoric acid, volume made up), the formation of deep blue colour indicates presence of glucose.

## 42.4.5 Pond water

Several unscrupulous milk vendors dilute the milk with unclean water waterways such as ponds. To detect its presence, a clean test tube is rinsed with 5 ml of milk sample and decanted. Along the side of test tube, 1-2 ml of 2% diphenylamine solution is added. The appearance of blue colour indicates presence of pond water.

## 42.5 Synthetic Milk

In recent times raw milk has sometimes been adulterated with the so called 'synthetic milk' usually prepared out of vegetable oil emulsified with the help of commonly available commercial detergents and other compounds such as urea, glucose etc. A test has been developed at National Dairy Research Institute, Karnal to detect the presence of anionic detergent as an indicator of synthetic milk in genuine milk.

\*\*\*\*\* 😊 \*\*\*\*\*

Lesson 43  
CHEMICAL QUALITY OF MILK - FAT, SNF, TS AND ACIDITY

**43.1 Introduction**

Chemical tests performed in order to meet the mandatory standards for legal requirements constitute testing for major components of milk and milk products namely, fat, total solids, lactose, protein, moisture, ash etc. Speed, sensitivity and accuracy are key factors for choice of the various existing methods. Rapid instrumental methods have also evolved in the recent past. Therefore, many dairies use instruments such as Milko-tester, Infra-red milk analyzer, Milko-scan, Lactostar etc. for quick analysis of major constituents of milk.

**43.2 Fat Determination**

As the FSS Rules, 2011 (earlier PFA Act) prescribes the minimum level of milk fat for cow and buffalo milk in various regions of the country, it is important to determine fat content of raw milk being received at the dairy. There are two methods of determining fat content of milk namely the Gerber method, based on direct reading and Rose Gottlieb method, which is a gravimetric test. The former is more widely used as it is quicker than the gravimetric method. Figure 43.1 illustrates the Gerber fat testing assembly.

The Gerber test is based on the principle that when a definite quantity of sulphuric acid and amyl alcohol are added to a definite volume of milk, the proteins dissolve and fat is set free from within the globules. This fat remains in the liquid state due to heat produced by the acid. Upon centrifugation, fat being lighter separates on top of the solution as liquid fat column in butyrometer stem.

Ten milliliters of sulphuric acid (Gerber acid) is transferred into milk butyrometer (range 0–10%) using an automatic measure. The milk sample is mixed well and 10.75 ml is slowly transferred from the side of the butyrometer wall taking care not to wet its neck. Thereafter, one ml of amyl alcohol is added and the butyrometer closed with a lock stopper and shaken well. The contents are centrifuged for 5 min at 1100–1200 rpm and the fat that appears as a colourless column read directly on the butyrometer stem.



Fig. 43.1 Gerber fat testing assembly

The theory behind using 10.75 ml milk in the pipette is as follows:

Graduation in the Gerber butyrometer, i.e., 0-10 is calibrated in such a way that each 1% division represents 0.125 ml.

So, if milk has 10% fat, it represents  $0.125 \times 10 = 1.125$  ml of fat.

This is equivalent to 1.25 g of fat (because density of fat = 0.9 mg/ml)

As per this, we should be pipetting 11.25 g of milk, but there are certain impurities due to isoamyl alcohol, which affects the fat reading. These impurities are estimated at 2.5-3% (average  $(2.5+3)/2 = 2.667\%$ ).

So the fat is  $1.125 - (1.125 \times 2.667/100) = 1.095$  g.

According to this we should be pipetting 10.95 g of milk.

This is equivalent to 10.65 ml of milk ( $10.95/1.02547$ , the denominator being the density of milk).

Since 0.1 ml residual milk remains in the glass pipette sticking to the walls, we take 10.75 ml of milk.

### 43.3 Solids-Not-Fat (SNF) Estimation

SNF is the collective term given to the various components of milk other than fat. The SNF content of milk is calculated by determining the specific gravity of milk. Lactometers are used for rapid determination of specific gravity of liquids. The method is based on the law of floatation which states that when a solid is immersed in a liquid it is subjected to upward thrust equal to the weight of liquid displaced by it and acting vertically upwards. Lactometers are variable immersion type hydrometers and calibrated in advance with liquids of known specific gravity. The SNF testing assembly is shown in Fig. 43.2.



**Fig. 43.2 SNF testing assembly**

The sample is mixed well avoiding incorporation of air or foam formation. The temperature of milk sample is adjusted to measuring temperature prescribed for the BIS lactometer ( $27^{\circ}\text{C}$ ). Sufficient milk is poured into the glass or steel cylinder to allow free floating of lactometer. It is then placed in the milk and allowed to float till it stops and assumes a constant level. The lactometer reading and temperature of milk are recorded at the same time. This is the lactometer reading (LR). The corrected value or corrected lactometer reading (CLR) is obtained from the standard table for corresponding temperature. The SNF and/or TS content are calculated using the given formulas.



$$\text{Percent SNF} = \text{CLR}/4 + (0.25 \cdot \text{fat } \%) + 0.44$$

$$\text{Percent Total solids} = \text{CLR}/4 + (1.25 \cdot \text{fat } \%) + 0.44$$

#### 43.4 Acidity Test

While the normal acidity of milk is due to its constituents like casein, citrates, phosphates and carbon dioxide, developed acidity in milk as a result of microbial action makes it unsuitable for high heat processing. Milk acidity is measured by titrating milk against a standard alkali solution using an indicator. Per cent acidity is determined by dividing number of ml of NaOH used with 10 and is expressed in terms of lactic acid. Acidity testing assembly is depicted in Fig. 43.3.



Fig. 43.3 Acidity checking assembly

\*\*\*\*\* 😊 \*\*\*\*\*

Lesson 44  
MICROBIOLOGICAL QUALITY OF MILK

44.1 Introduction

It is necessary to test microbiological quality of milk at a number of points along the chain from producer to consumer for public health and economic considerations.

44.2 Dye reduction Tests

These methods are based on changes produced by bacteria due to their chemical constituents, enzymatic activity or on products of metabolic activity. They are widely used in dairy industry for their simplicity, quickness and low cost. They are helpful in judging the hygienic quality of milk, detecting abnormal milk and grading of raw milk supplies. The basis of the dye reduction tests is the ability of the bacteria to produce enzymes which can transfer hydrogen from a substrate to a redox dye which undergoes change in color. The rate of reduction of color depends upon the enzyme activity which is taken as the index of number of organisms present in milk. The reduction time is inversely related to the bacterial count of the sample. These tests are used for non-refrigerated, bulked raw milk.

44.2.1 Methylene blue reduction test

The redox potential of milk rises by +0.3 V during milking and subsequent handling. At this potential, methylene blue, if added to milk, will be in the oxidized state and will be blue in colour. When milk with dye is kept at a specific temperature, bacterial cells multiply and consume oxygen in the process. This results in decrease in the redox potential of milk and the dye becoming colourless.

To 10 ml milk in a test tube is added 1.0 ml of methylene blue test solution. The test tube is plugged with cotton and placed in water bath at 37°C. The tube is monitored for possible colour changes every 30 min. The time in hours, at which discoloration takes place is noted and compared with suggested standard for grading of milk as below (Table 44.1):

Table 44.1 BIS guidelines for the MBR test

MBR Time (h)*	Milk Quality
5 and above	Very good
3 and 4	Good
1 and 2	Fair
½ and below	Poor

\* Reduction times are noted as whole hours e.g. if the colour disappears between 1.5 and 2.5 h, the result will be noted as 2 h

44.2.2 Resazurin reduction test

As bacteria multiply, they consume dissolved oxygen resulting in the decrease of redox potential of milk. Resazurin acts as an oxidation-reduction indicator. The changes in colour take place in two stages. First the blue colour of resazurin changes to pink, owing to the compound resofurin.

This colour change is irreversible. During the second stage, the resofurin is reduced to hydroresofurin, which is white in colour. The series of colour changes can be compared with standard colour discs in a Lovibond comparator and expressed in terms of disc number (6-10). Depending on the conditions and requirements, the test can be performed for 10 min, one hour or three hours. The former is generally used to weed out poor quality milk at the receiving platform.

A stock solution of resazurin is prepared by dissolving 0.05 g resazurin powder in 100 ml distilled water. The solution is heated for 30 min, cooled and stored in a cool dark place. The test is performed by mixing resazurin bench solution (one ml stock solution diluted to 10 ml with distilled water) with a sample of milk and incubating in a water bath at 37°C for the required period. The colour developed is compared using a resazurin disc. The milk is graded as per standard given in Table 44.2.

**Table 44.2 Standard for resazurin test**

Disc number	Milk Quality	Remarks
4 and above	Satisfactory	Accept milk
3.5 – 1.0	Doubtful	Perform other confirmatory tests
0.5 – 0.0	Unsatisfactory	Reject milk

### 44.3 Microbial Enumeration Methods

Direct methods are used to count cells microscopically or examine the ability of the viable cells to grow and form colonies. They are more sensitive and accurate than indirect methods, but take more time. The most widely used method is the plate count method, where serial dilutions of the sample are plated out on an agar medium in which the organisms grow. The plates are incubated at the appropriate temperature for a period of time (24-72 h). The colonies formed on the plates are counted and the results expressed as colony forming units (cfu) per gram or ml of the sample used for testing.

\*\*\*\*\* 😊 \*\*\*\*\*

*Module 11. Indian food regulation in global scenario*

**Lesson 45**

**QUALITY AND SAFETY REGULATIONS**

**45.1 WTO and Indian Food Industry**

The World Trade Organization (WTO) was formed in 1995 as a replacement for the General Agreement on Tariffs and Trade (GATT) which lasted from 1947 to 1994. The Head Quarters of WTO is at Geneva (Switzerland) and the official languages are English, French and Spanish. It currently has 153 members, of which 117 are developing countries or separate customs territories. WTO is the only global international organization dealing with the rules of trade between nations. It provides a forum for negotiating agreements aimed at reducing obstacles to international trade and ensuring fair deal for all, thus contributing to economic growth and development. Currently, there are 16 agreements to which all WTO members are parties and two agreements to which only some WTO members are parties.

The Codex Alimentarius Commission (CAC) is universally recognized as the international reference for food hygiene standards. The Codex contact Point in India is the Director General of Health Services (DGHS) in the Ministry of Health and Family Welfare. However, the Department of Food Processing Industries is closely associated with the activities of Codex Alimentarius and has made financial provision in subsequent budgets for creating the database, technical examination of various standards in association with experts and coordination as well as participation in international Codex meetings.

The GATT/WTO agreement concerning dairying came into effect from July, 1995 as included in the Agreement on Agriculture (AoA). It emphasizes the need for liberalization of trade so as to have distortion-free markets. The two agreements that enable the enforcement of quality and safety are the 'Technical Barriers to Trade (TBT)' agreement relating to all goods and 'Sanitary and Phytosanitary (SPS)' agreement concerning agricultural products. While the basic objective of the former is to avoid unnecessary obstacles to trade by treating imported products on equal terms with domestically produced goods, the quality aspects of all primary products of plant and animal origin are grouped under the latter. The TBT and SPS guidelines are laid down by member countries at CAC meetings. As it is mandatory that the member countries have to make their national SPS regulations conform to international standards, it is apparent that India will have to improve the quality norms in order to merge with the International context. However, as different countries adopt different quality norms, the homogeneity of food products across countries are not guaranteed. The large numbers of food laws that exist in India and the many agencies/ ministries that implement them also are in contradiction to the theory of equivalence between the National and International standards in the liberalized post-WTO environment.

India and other developing countries are struggling to join the international milieu of quality standards. Lack of hygiene and sanitation is the sole cause for the rejections and bans on Indian exports. Although developing countries are encouraged to attend Codex meetings to set standards, many of these nations do not have qualified manpower for this. In addition, the SPS controls in many developing countries are weak and disjointed and need major organizational

changes. Homogeneity of domestic food standards with the international ones is imperative to gain a place in the international market. These regulations should also be supported by precise and sound scientific reasoning. In the absence of such support in the post-WTO environment, no ban on the entry of imported foods containing ingredients and additives that are not permitted by the FSSR, 2011 (formerly PFA) though approved by the Codex and are being used globally, would be effective.

## **45.2 Regulatory Bodies in India**

The Indian food processing sector maintains its quality parameters through compulsory legislation which specifies minimum standards and certification systems. Legal standards are formulated to exercise control over the quality of foods offered for sale and to safeguard the consumer from health hazards posed by possible adulteration. The three major Indian standards prevalent in the dairy industry are the FSSR, 2011 (formerly PFA), Bureau of Indian Standards (BIS) and Agriculture Produce Grading and Marketing Act (Agmark).

### **45.2.1 Food Safety and Standards Authority of India**

The Food Safety and Standards Rules of India replaces the Prevention of Food Adulteration Act which has been in use since the year 1954 for the protection of consumers against supply of inferior quality or adulterated food. Food Safety and Standards Rules came into effect from August, 2011. The standards have been formulated by the Department Of Health and Family Welfare (Ministry of Health and Family Welfare). The act, as was under PFA, spells out standards of various food articles in terms of minimum quality for safeguarding against harmful impurities and to ensure safety. These are compulsory standards that are obligatory for any food product going into the market. Any violation of the rule can lead to fines and imprisonment.

### **45.2.2 Bureau of Indian Standards**

Bureau of Indian Standards, formerly the Indian Standards Institution (ISI), was established as a statutory body under the Ministry of Consumers Affairs in 1986. BIS specifies standards for goods manufactured in the country in consultation with the experts drawn from manufacturing units, research and technical institutions, purchase organizations and other concerned parties. In the processed food sector, the formulated standards are implemented through voluntary and third party certification systems. These standards are amended suitably from time to time and cover the permitted raw materials and their quality parameters, hygiene rules for manufacturing, packaging and labeling requirements. Manufacturers complying with these standards can obtain 'ISI' or 'BIS' certification and exhibit the same on their product package. The various certification schemes operated by BIS are 1) BIS Product Certification Scheme, 2) Quality Scheme Certification as per IS/ISO 9000 series, 3) Environmental Management System as per IS/ISO 14000 series and 4) Hazard Analysis and Critical Control Point (HACCP) as per ISO-15000.

### **45.2.3 Agmark**

The Agriculture Produce Grading and Marketing Act was first enacted in 1937 to prescribe grade standards for agricultural and allied commodities. The standards came to be known as Agmark standards and are formulated by the Directorate of Marketing and Inspection (DMI), under Ministry of Agriculture (Government of India). Agmark categorizes the commodities into various grades (for example, Special and Standard). Grading under this act is voluntary. Manufacturers who comply with these standards are allowed to use 'Agmark' logo on their products to give the consumers an assurance of quality in accordance with the standards laid down. Three dairy

products (ghee, butter and dairy spreads) are currently graded under this scheme.

#### **45.2.4 Milk and Milk Product Order (MMPO)**

All dairy plants processing more than 10,000 liters of milk per day or handling more than 500 tonnes of milk solids per annum are now required to obtain registration certificates from the competent authority. This was the result of setting up of an Advisory Board in 1992, by the Government of India for guidance on production, sale, purchase and distribution of milk and milk products. Dairy plants processing up to 75,000 L per day or equivalent quantity of milk solids per annum need to be registered compulsorily with the Directorate of Animal Husbandry in respective states, while those handling more than 75,000 L per day have to register with Department of Animal Husbandry of Central Government. This order has also defined milkshed areas, so as to restrict uneven procurement and marketing of milk and set rules for production, hygienic conditions, packaging, labeling, marketing and penalty.

#### **45.2.5 Export (Quality Control and Inspection) Act**

Enacted in 1963 and operated by the Export Inspection Council of India, this act works under the Department of Commerce. It stresses on compulsory inspection of the manufacturers' premises, human hygiene, quality of raw material purchased, hygienic manufacturing practices followed, quality assurance programmes followed, packaging and labeling at the production center for the exportable product. A certificate has to be obtained from the Council before the consignment is cleared for export for each batch. The act covers compulsory pre-shipment examination of a large number of exportable commodities. The quality control and inspection of export product is administered through a network of officials located at the main production centers and port of shipment.

#### **45.3 International Standards in the Indian Context**

The Codex Committee on Milk and Milk products (CCMMP) was established in 1993 to cater to new scientific and technological developments and accordingly revise the existing standards. Eleven standards of Codex have been revised and adopted by the CAC over the years. A few of the altered ones as a consequence of Indian intervention deal with the definition of milk, inclusion of ghee in the standard Milk Fat Product, incorporation of BHA as an antioxidant and removing the restriction of permitting only cow milk as a raw material particularly for cheeses. Concerted efforts by India at the IDF as well as CCMMP led to accepting the suitability of buffalo milk for cheese making. This was a boon to the subcontinent as India and Pakistan account for 92 per cent of the world's buffalo milk. Despite these efforts, several anomalies still exist in the two standards.

#### **45.4 Harmonization of the Indian Standards With International Standards**

The WTO accepts the international food standards/ guidelines/ codes related to food hygiene and sanitation formulated by the codex as the reference points for the global food trade. Most of the national food standards would have to be harmonized with those of codex and the dairy industry would be required to comply with them. In India, the food safety regulations, whether mandatory or voluntary, are implemented by different agencies/ ministries/ departments. Different quality standards as laid down for ghee by FSSR, BIS, Agmark and Codex are presented in Table 45.1. The presence of multiple agencies to implement multiple laws poses a problem of fixing responsibility. It is, therefore, necessary to have uniform and logical approach for regulating the quality of food and for harmonizing with the international regulations.

**Table 45.1 Quality parameters for ghee**

Standards→	Agmark	Codex	BIS	FSSR
Parameters				
Fat (min %)	NM	99.3	99.5	NM
Moisture (% max)	0.3	0.5	0.5	0.5
FFA (% max)	3	NM	0.3	3
Peroxide value (max Meq/kg)	NM	NM	0.8	NM
Cu (max ppm)	NM	0.05	NM	30

\*Source : Deodhar (2001) NM- not mentioned

A task force constituted by the Prime Minister was set up for the constitution of a Food Regulation Authority (FRA) be set up in place of PFA to formulate and update food standards for domestic and export market and to conform to international standards. The task force was given ten specific recommendations which include standard methods of analysis, provision of adequate infrastructure/ laboratories, harmonization of Indian standards with the quality norms of Codex, WTO and FRA governing body for expeditious decisions to replace the Central Committee on Food Standards (CCFS). The Food Safety and Standards Act was introduced in 2006 as a result of these efforts. Later, the Act came into effect as FSSR since August 2011.

BIS is the largest body for formulating standards for various food items and is voluntary. The Ministry of Civil Supplies and Consumer Affairs has brought out a paper for consideration of the Committee of Secretaries (COS) recommending that the BIS should formulate standards for all food items in the country. Several quality control orders such as MMPO, Meat Product Order (MPO) and Vegetable Oils Control Order (VOCO) have been issued under Essential Commodities Act. These orders are mandatory and are primarily meant for regulating the hygienic conditions. All these orders need to be included in a single order, which may later be named as the Food Products Order (FPO). The international guidelines (ISO-17020), which includes 'the general criteria for the operation of various types of bodies performing inspection' as well as Codex standard have been adopted for export inspection and certification systems. The Export Inspection Council (EIC), the official certifying body of the Government of India has been designated as competent authority by the European Commission for marine products and basmati rice. Similar recognition for egg and milk products is awaited.

#### **45.5 Hazard Analysis Critical Control Point (HACCP)**

The HACCP concept has been introduced into the food production systems in order to produce safest possible food items for consumers, considering each and every possible hazard well in advance. Incorporation of the system helps in identifying the potential hazards in the process operations based on viability/proliferation of the contaminants and laying down control measures. It determines the critical control points, defines critical limits and their monitoring and thus guards the food against any food safety hazards. Each organization must develop its own HACCP to suit its individual product line, processing, packaging, storage, distribution and marketing.

#### **45.6 Conclusion**

Dairy processing industry in India is flooded with immense potential in the area of R&D in terms of value addition. The potential gains are many, including higher returns for producers and advantages in terms of health, therapeutic, nutritional and/or gastronomy for the consumers.

However, the Indian Dairy Industry can amass possible benefits by being a global contender in trade only when its products are at par with those available in the rest of the world in terms of price and quality. It is evident from the post-WTO scenario that for sustainability, Indian dairy industry will need to maintain wholehearted commitment to quality management right from the farm to the consumer, shedding its inhibitions and resistance to changes.

\*\*\*\*\* 😊 \*\*\*\*\*

This Book Download From e-course of ICAR

**VISIT FOR OTHER AGRICULTURE BOOKS,  
NEWS, RECRUITMENT, INFORMATION,  
AND EVENTS AT**

**[www.Agrimoon.Com](http://www.Agrimoon.Com)**