

Voltage Source and Current Source

A **Source** is a device which converts mechanical, chemical, thermal or some other form of energy into electrical energy. In other words, the source is an active network element meant for generating electrical energy.

The various types of sources available in the electrical network are voltage source and current sources. A voltage source has a forcing function of emf whereas the current source has a forcing function of current.

Contents:

- [Voltage Source](#)
- [Current Source](#)

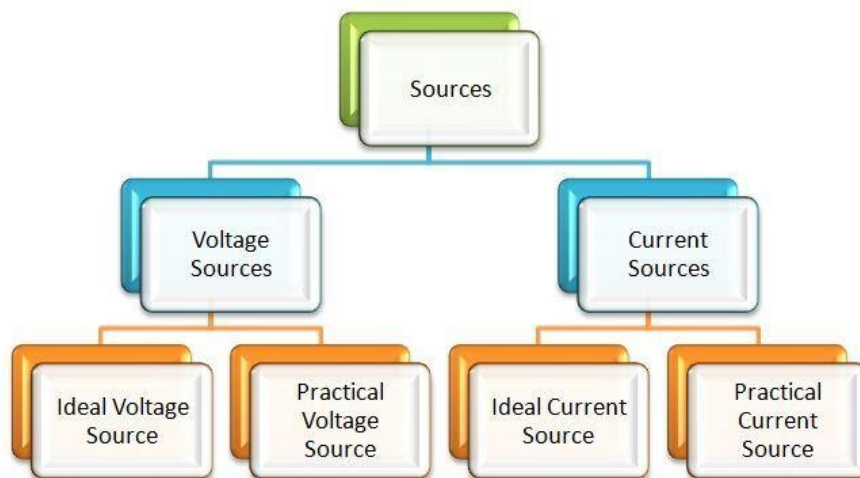

Circuit Globe

The **current and voltage sources** are further categorised as an ideal source or practical source.

Voltage Source

A **voltage source** is a two-terminal device whose voltage at any instant of time is constant and is independent of the current drawn from it.

Such a voltage source is called an **Ideal Voltage Source** and have zero internal resistance.

Practically an ideal voltage source cannot be obtained.

Sources having some amount of internal resistances are known as **Practical Voltage Source**. Due to this internal resistance; voltage drop takes place, and it causes the terminal voltage to reduce. The smaller is the internal resistance (r) of a voltage source, the more closer it is to an Ideal Source.

The symbolic representation of the ideal and practical voltage source is shown below.

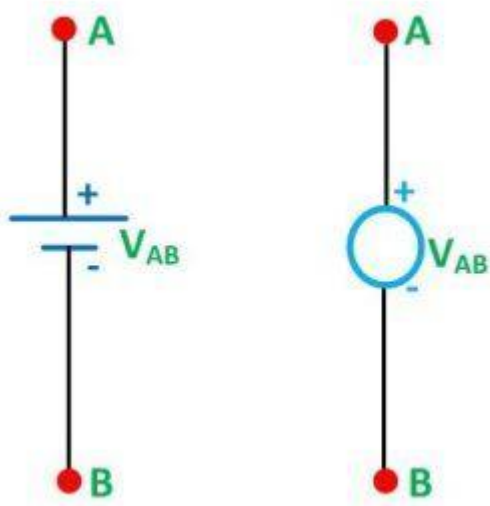

Circuit Globe

Figure A shown below shows the circuit diagram and characteristics of an ideal voltage source:

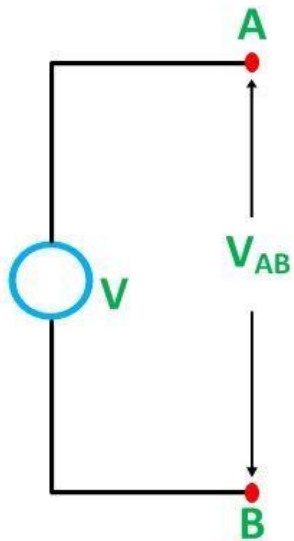
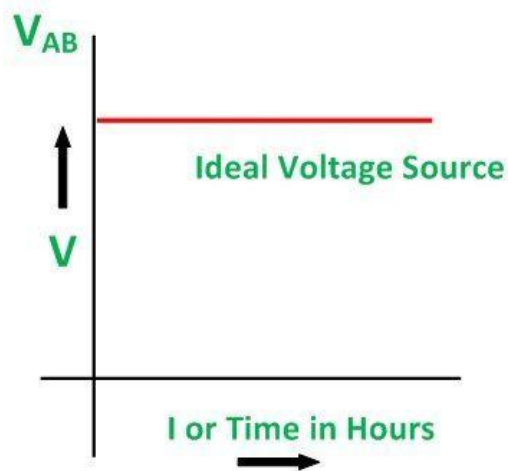

Figure A



Circuit Globe

Figure B

shown below gives the circuit diagram and characteristics of Practical Voltage Source:

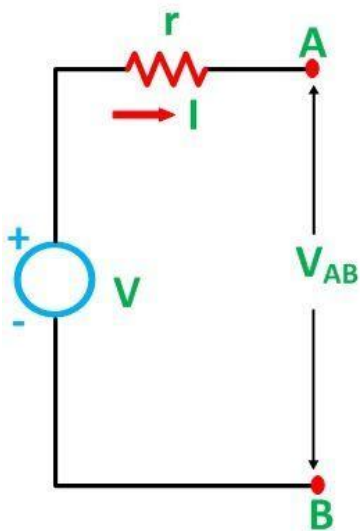
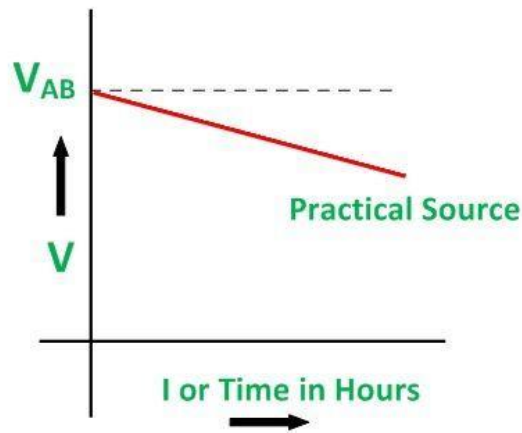

Figure B



Circuit Globe

The example

of voltage sources is batteries and alternators.

Current Source

The current sources are further categorised as Ideal and Practical current source.

An **ideal current source** is a two-terminal circuit element which supplies the same current to any load resistance connected across its terminals. It is important to keep in mind that the current supplied by the current source is independent of the voltage of source terminals. It has infinite resistance.

A **practical current source** is represented as an ideal current source connected with the resistance in parallel. The symbolic representation is shown below:

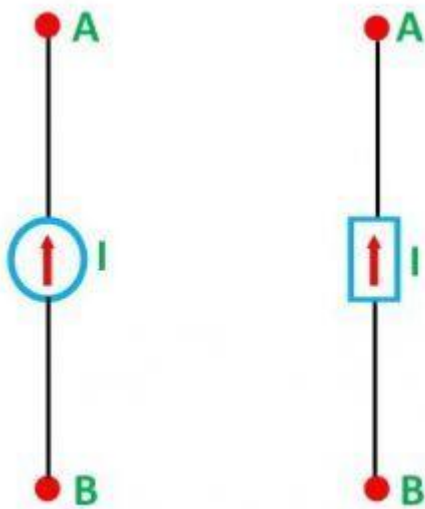

Circuit Globe: Figure C shown below, show its

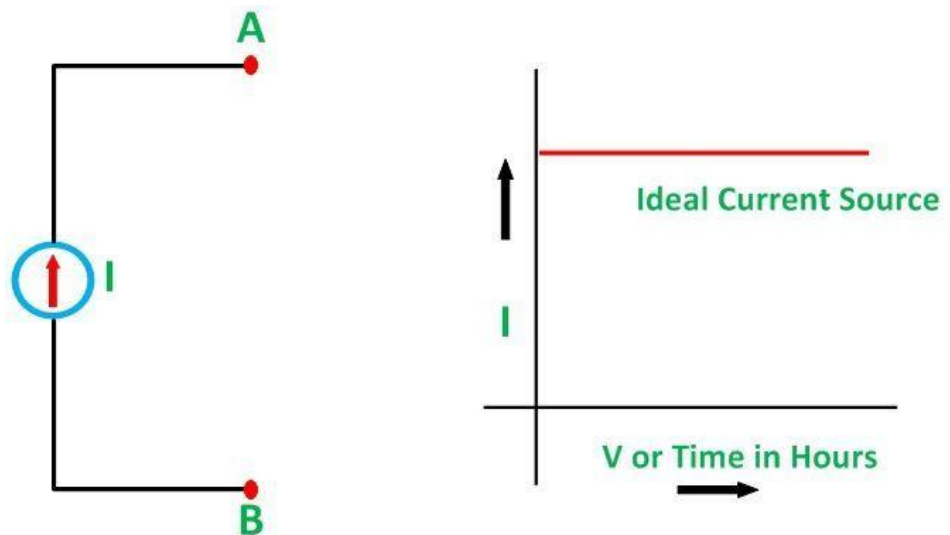

Figure C

Circuit Globe

characteristics.

Figure D shown below shows the characteristics of Practical Current Source.

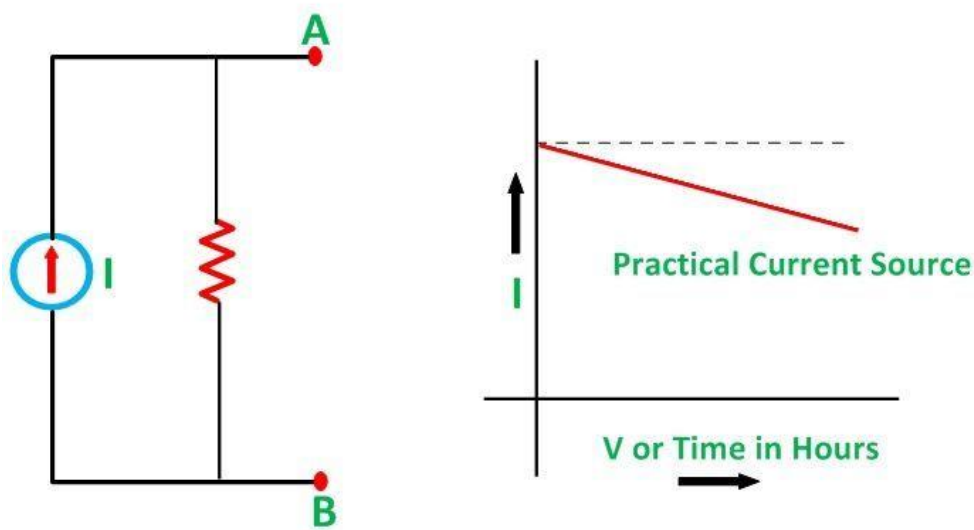

Figure D

Circuit Globe The

example of current sources is photoelectric cells, collector currents of transistors.

Source Transformation

Source Transformation simply means replacing one source by an equivalent source. A practical voltage source can be transformed into an equivalent practical current source and similarly a practical current source into voltage source.

Any practical voltage source or simply a voltage source consists of an ideal voltage source in series with an internal resistance or impedance (for an ideal source this impedance will be zero), the output voltage becomes independent of the load current. Cells, batteries and generators are the example of the voltage source.

For any practical current source or simply current source, there is an ideal current source in parallel with the internal resistance or impedance, for ideal current source this parallel impedance is infinity.

The semiconductor devices like transistors, etc. are treated as a current source or an output produce by the direct or alternating voltage source is called direct and alternating current source, respectively.

The voltage and current source are mutually transferable or in other words the source transformation i.e. voltage to the current source and current to a voltage source can be done. Let us understand this by considering a circuit given below:

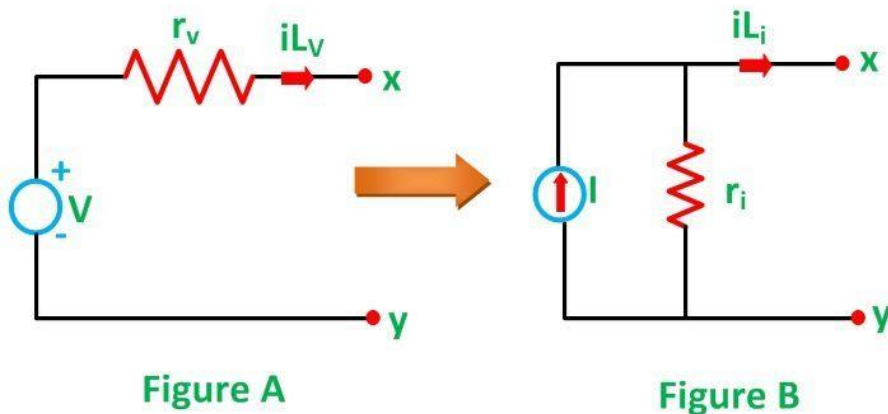

Circuit Globe

Figure A

represents a practical voltage source in series with the internal resistance r_v , while figure B represents a practical current source with parallel internal resistance r_i

For the practical voltage source the load current will be given by the equation:

$$i_{L_v} = \frac{V}{r_v + r_L} \dots \dots \dots (1)$$

Where,

i_{L_v} is the load current for the practical voltage source

V is the voltage

r_v is the internal resistance of the voltage source

r_L is the load resistance

It is assumed that the load resistance r_L is connected at the terminal x-y. Similarly for the practical current source, the load current is given as:

$$i_{L_i} = I \frac{r_i}{r_i + r_L} \dots \dots \dots (2)$$

Where,

i_{L_i} is the load current for the practical current source

I is the current

r_i is the internal resistance of the current source

r_L is the load resistance connected across the terminal x-y in the figure B

Two sources become identical, when we will equate equation (1) and equation (2)

$$\frac{V}{r_v + r_L} = I \frac{r_i}{r_i + r_L}$$

However, for the current source, the terminal voltage at x-y would be $I r_i$, x-y terminal are open. i.e.

$$V = I \times r_i$$

Therefore, we will get,

$$r_v + r_L = r_i + r_L \quad \text{or}$$

$$r_v = r_L$$

Therefore, for any practical voltage source, if the ideal voltage is V and internal resistance be r_v , the voltage source can be replaced by a current source I with the internal resistance in parallel with the current source.

Source Transformation: Conversion of Voltage Source into Current Source

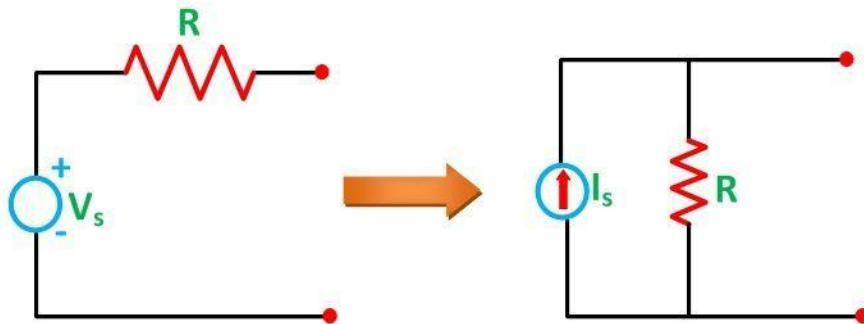

Circuit Globe When the voltage source is connected with the resistance in series and it has to be converted into the current source than the resistance is connected in parallel with the current source as shown in the above figure.

$$\text{Where } I_s = V_s / R$$

Conversion of Current Source into Voltage Source

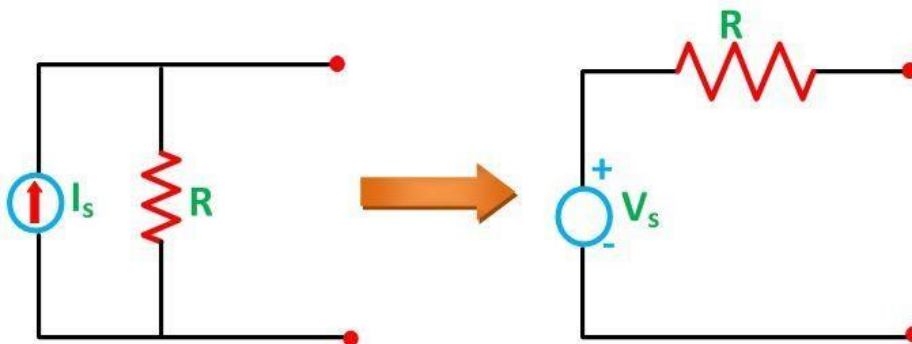

Circuit Globe In the above circuit diagram a current source which is connected in parallel with the resistance is transformed into a voltage source by placing the resistance in series with the voltage source.

$$\text{Where, } V_s = I_s / R$$