

# ALLOSTERIC ENZYMES

**Allosteric enzymes:** Binding of ligands to proteins - Co-operativity, the Hill equation, equilibrium dialysis technique. **Sigmoidal kinetics:** The MWC and KNF models. Significance of sigmoidal behaviour. Allosteric enzymes and metabolic regulation. Study of ATCase- as typical allosteric enzyme.

8 Hr

# INTRODUCTION

## **Enzymes:**

Enzymes may be defined as biocatalysts synthesized by living cells. They are protein in nature, colloidal and thermolabile in character and specific in their action. They are known as catalyst of life. They accelerate the rate of reaction.

**Berzelius** in 1836 coined the term catalysis.

In 1878, **Kuhne** used the word enzyme to indicate the catalysis taking place in the biological systems.

## **Allosteric Enzyme:**

Some of the enzymes possess additional sites, known as allosteric sites (Greek; allo-other) besides the active site. Such enzymes are known as allosteric enzyme. The allosteric sites are unique places on the enzyme molecules; allosteric enzymes have one or more allosteric site.

## History

The term allosteric has been introduced by the two Noble laureates, *MONOD AND JACOB*, to denote an enzyme site, different from the active site, which non competitively binds molecule other than the substrate and may influence the enzyme activity.

## PROPERTIES OF ALLOSTERIC ENZYME

- Allosteric enzyme have one or more allosteric sites
- Allosteric sites are binding sites distinct from an enzyme active site or substrate binding site
- Molecule that bind to allosteric sites are called effector or modulator
- Effector may be positive or negative, this effector regulate the enzyme activity. The enzyme activity is increased when a positive allosteric effector binds at the allosteric site known as activator site. On the other hand, negative allosteric effector bind at the allosteric site called inhibitor site and inhibit the enzyme activity.
- Binding to allosteric sites alter the activity of the enzyme, this is called cooperative binding. Allosteric enzymes display sigmoidal plot of  $V_0$  vs  $[S]$ .

## KINETIC PROPERTY OF ALLOSTERIC ENZYME

*According to the term of conformational changes:-*

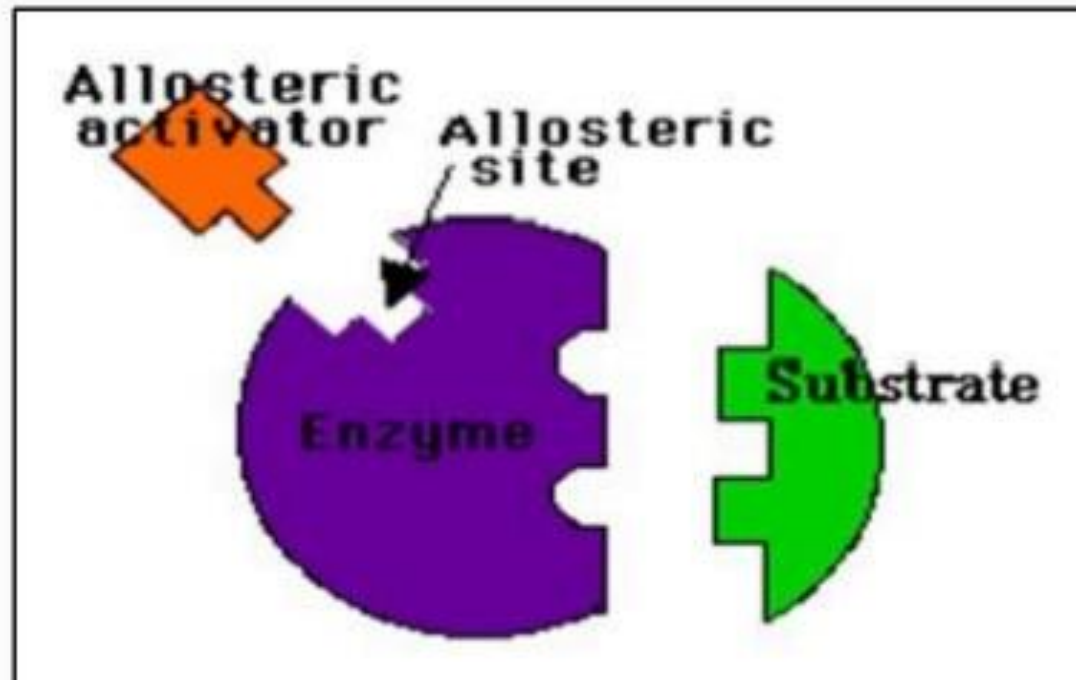
- Most of the allosteric enzymes are oligomeric in nature, the subunit may be identical or different. The non-covalent reversible binding of the effector molecule at the allosteric sites brings about a conformational change in the active site of the enzyme, leading to the inhibition or activation of the catalytic activity.

# MODEL OF ALLOSTERIC REGULATION

Two main model have been proposed to describe the mechnastic basis of enzyme allostery:

- *Concerted model* : Given by MONOD, WYMAN AND CHANGEUX.
- *Sequential model*: Given by KOSHLAND, NEMETHY AND ALLOUS

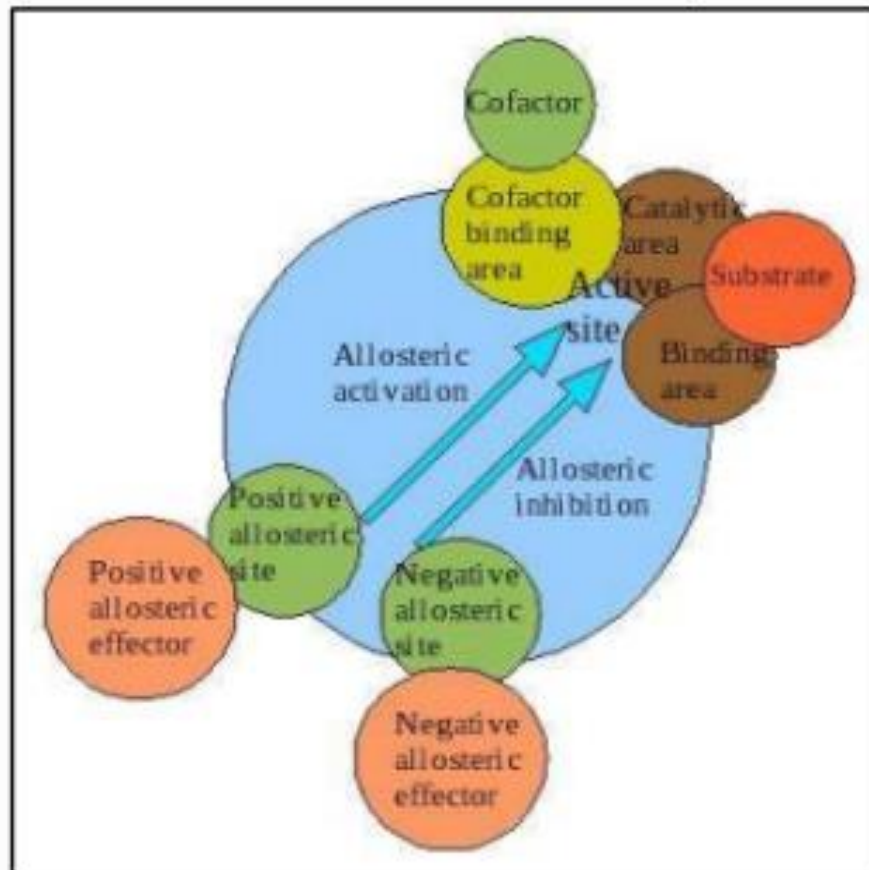
## Why Sigmoid Curve:



# ALLOSTERIC EFFECTOR

It has been suggested that allosteric effectors are:

- *Positive allosteric effector.*
- *Negative allosteric effector.*



**Fig: Allosteric modulation of an enzyme**



# Regulatory Enzymes

Reversible non-covalent  
modification:

## Allosteric Regulation

Allosteric  
activation

Allosteric  
Inhibition

Reversible covalent  
modification

Adenylation

Uridylation

ADP-  
Ribosylation

Phosphorylation

Methylation

# Regulatory Enzyme

- Why we are curious about enzyme regulation???????
- Most metabolic reactions are multi-step cascade processes.
- In each enzyme system there is at least one enzyme that sets the rate of the overall sequence because it catalyzes the rate limiting reaction.

## Regulatory Enzyme

- These regulatory enzymes exhibit increased or decreased catalytic activity in response to certain signals.

# Allosteric Enzymes

- **Allosteric enzymes** are a class of Regulatory enzymes.
- **Definition:** A type of enzyme regulation by the reversible non-covalent binding of regulatory molecules to the enzyme.
- Regulatory molecules are called **allosteric modulators** or **allosteric effectors** .
- Allosteric enzyme has **additional conformations** induced by the binding of modulators.
- Conformational changes induced by the allosteric modulators can produce **more active** or **less active** forms of enzyme.

## Cont'd

- Allosteric modulators may be **inhibitory** or **stimulatory**.
- Two types of Allosteric enzymes based on the nature of modulator:
  - Homotropic Allosteric Enzymes
  - Hetrotropic Allosteric Enzymes
- In most cases, the **substrate** itself act as the modulator
- Allosteric enzymes having the substrate and modulators are the same are called **homotropic allosteric enzymes**
- Binding of modulator causes conformational changes in the enzyme.

# Feedback inhibition

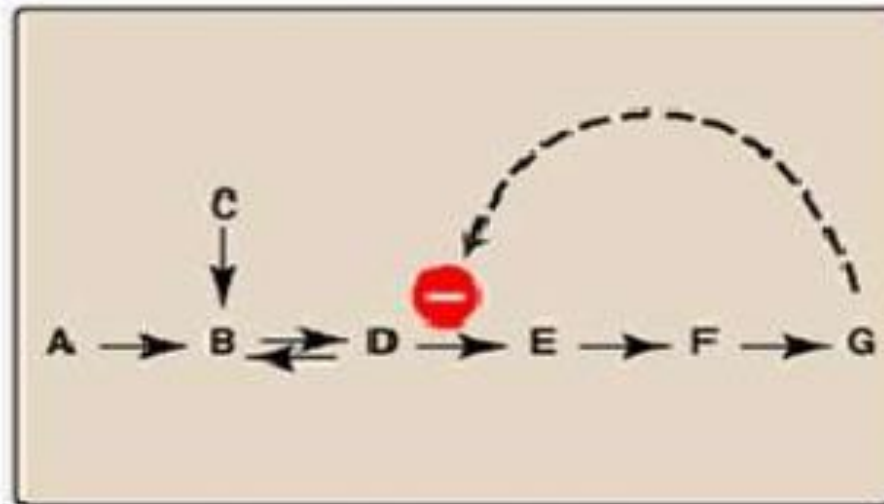
- Feedback inhibition is a specific type of allosteric enzymatic activity regulation mechanism in the cells.
- **Definition:** in some multi enzyme pathways, the regulatory enzyme is specifically inhibited by the end product of the pathway whenever the concentration of the end product exceeds the cells requirements.



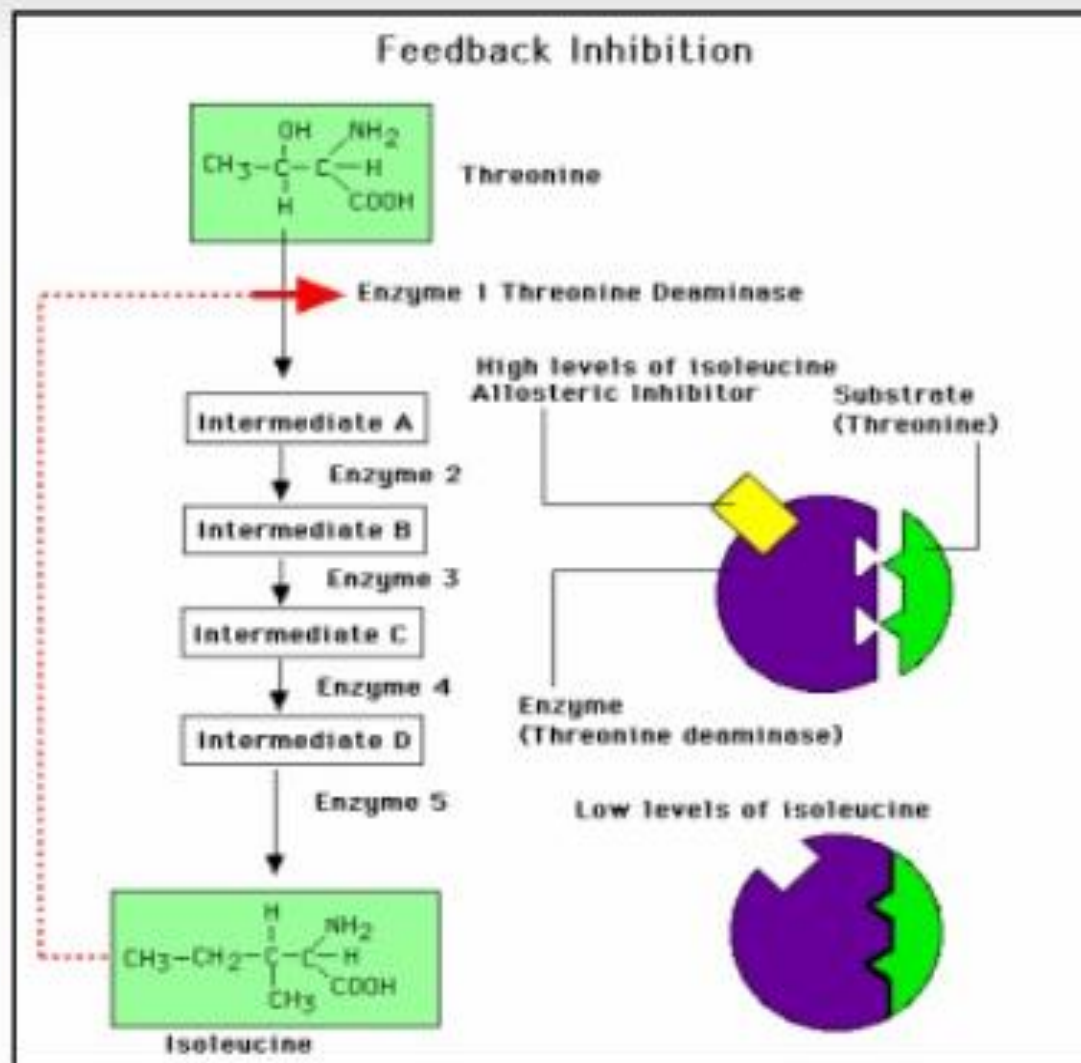
# ALLOSTERIC INHIBITION

**Heterotropic Inhibition:** The effector may be different from the substrate, in this case effector is said to be heterotropic effector. For example the feedback mechanism.

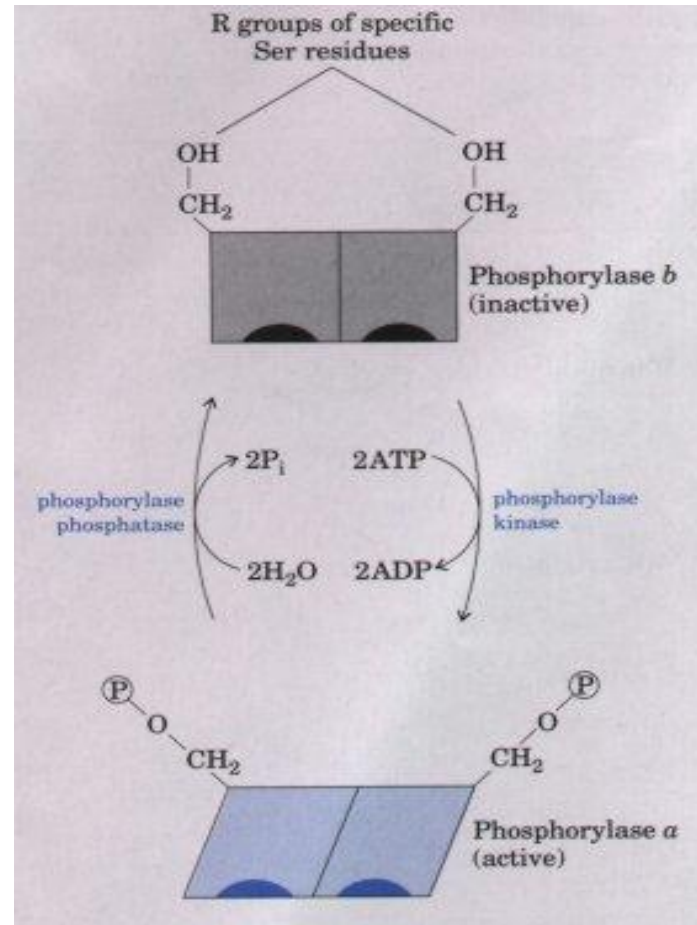
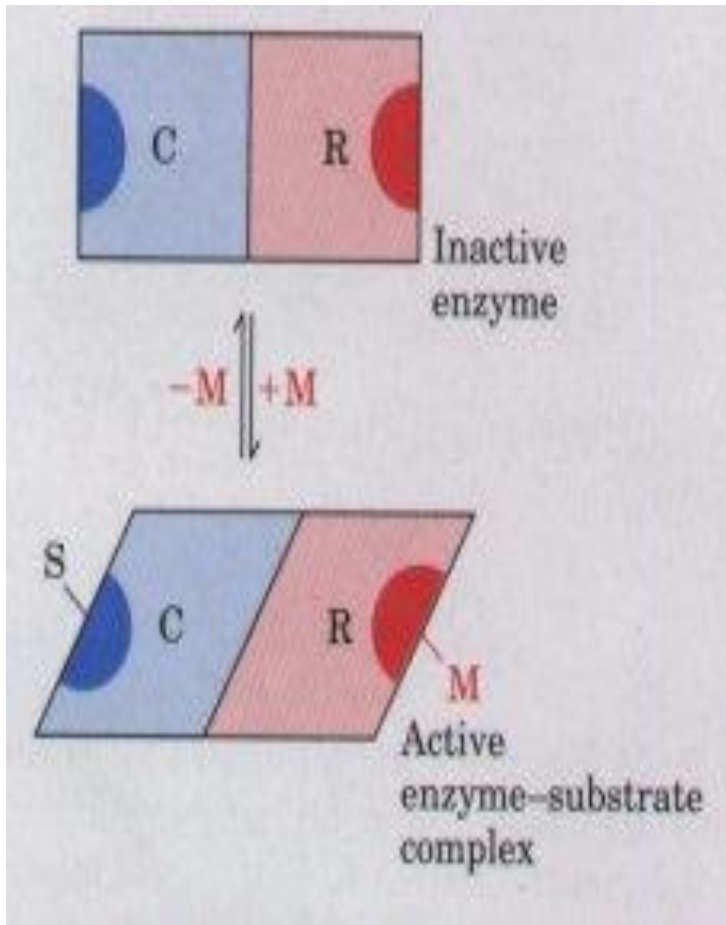
## •Feed back inhibition



**Fig: Feedback inhibition of a metabolic pathway.**



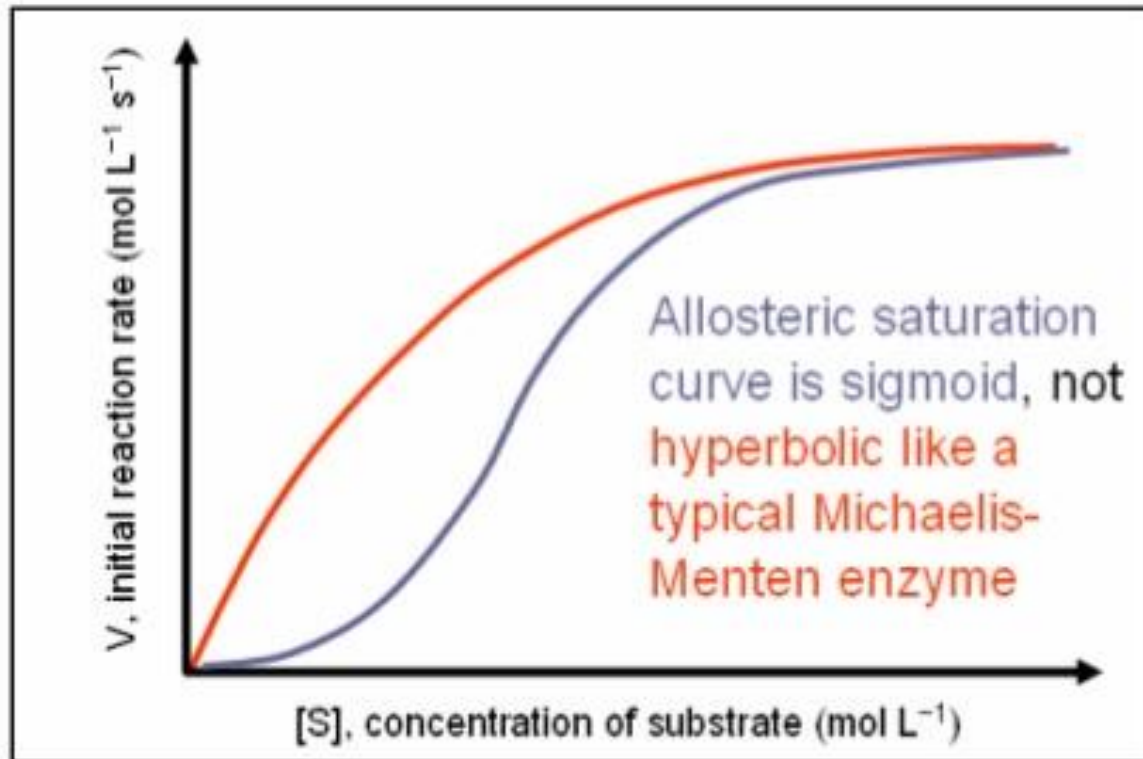
**Fig: Example of Feedback Inhibition**





## SIGMOID CURVE OF ALLOSTERIC ENZYME:

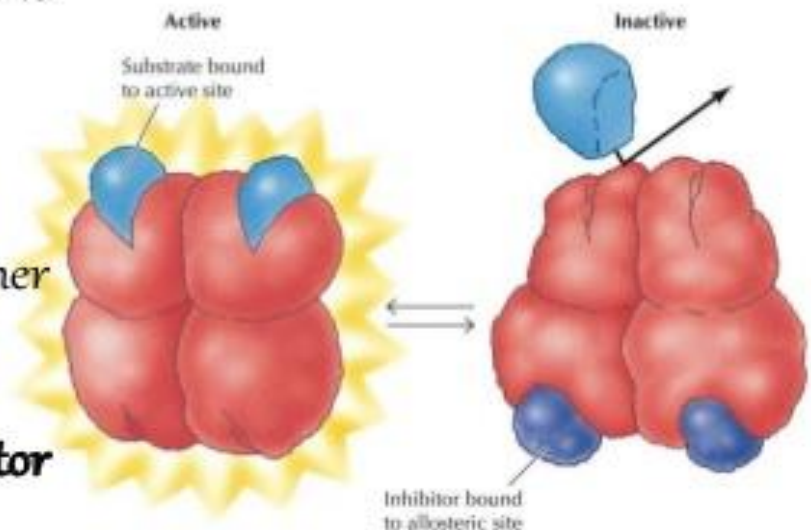
Allosteric Enzyme Kinetics: Sigmoid Curve instead of Hyperbola.

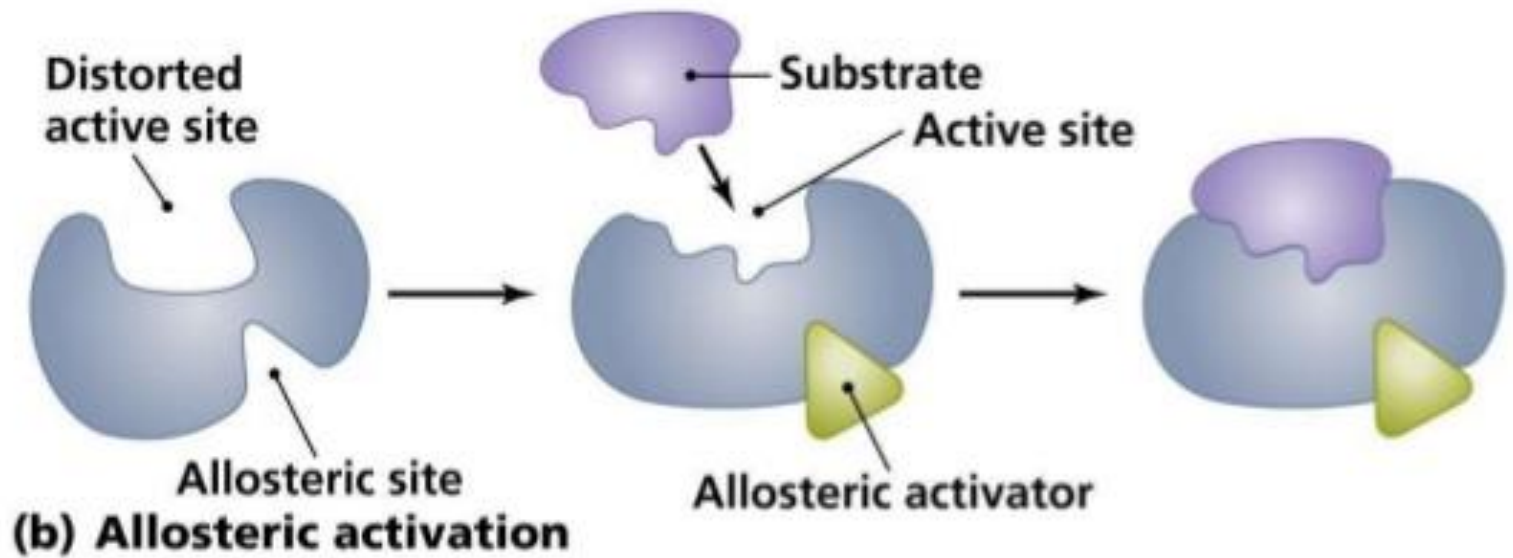
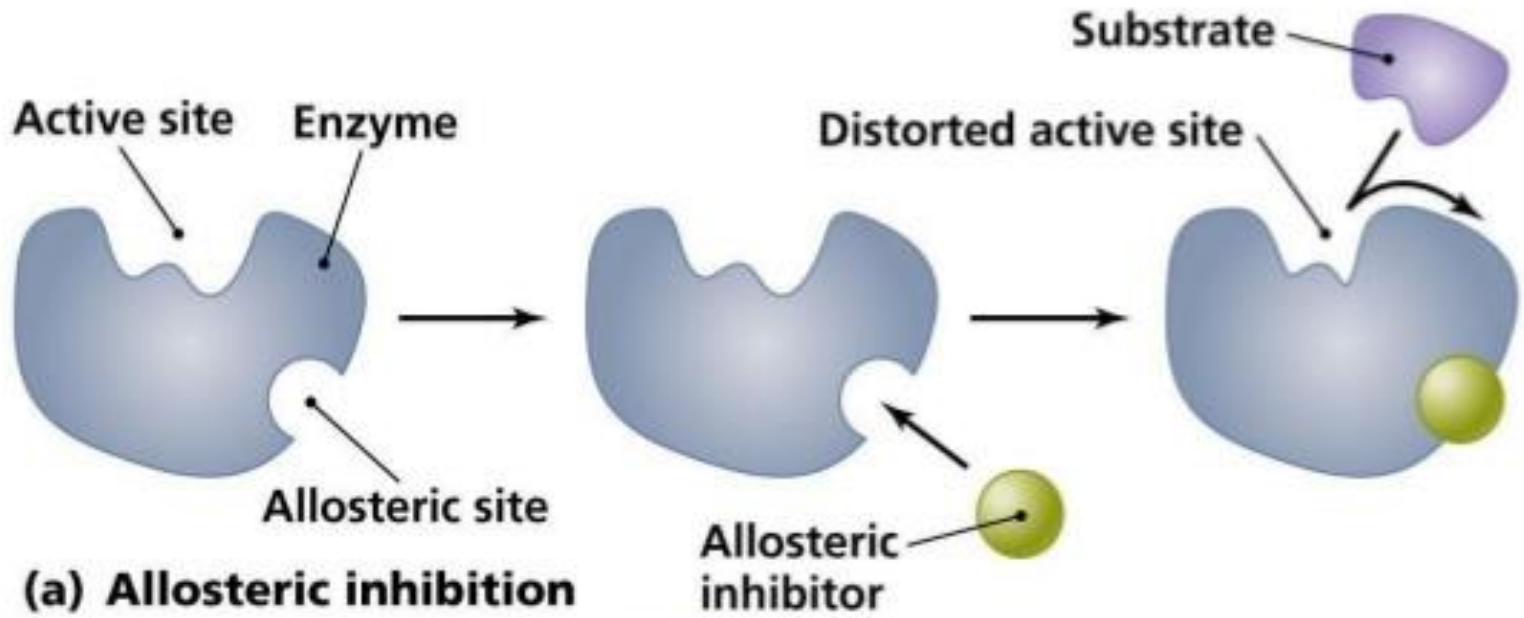


**Figure: Sigmoid Curve Of Allosteric Enzyme (Initial Reaction Rate Vs. Concentration Of Substrate)**

# Allosteric Enzymes

- **Allosteric enzymes** are those having "**other shapes**" or conformations induced by the binding of modulators.
- These enzymes have **two receptor sites**.
- One site fits the **substrate** like other enzymes.
- The other site fits an **inhibitor or activator molecule**.
- Allosteric enzymes are very important in **feedback regulation**.

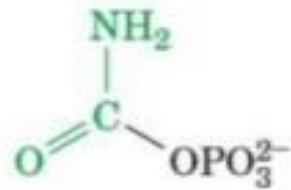




# Allosteric Inhibition

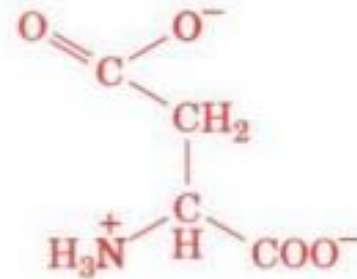
Allosteric inhibition is a class of enzyme inhibition in which an allosteric inhibitor inhibits enzyme activity by binding to the allosteric site of the enzyme.

# ATCase as a catalyst



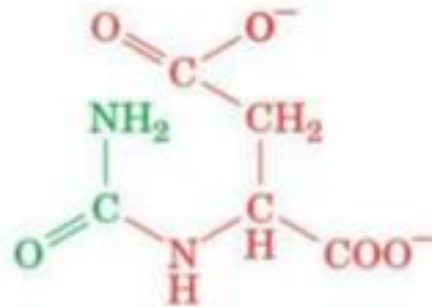
**Carbamoyl phosphate**

+



**Aspartate**

↓ aspartate  
transcarbamoylase

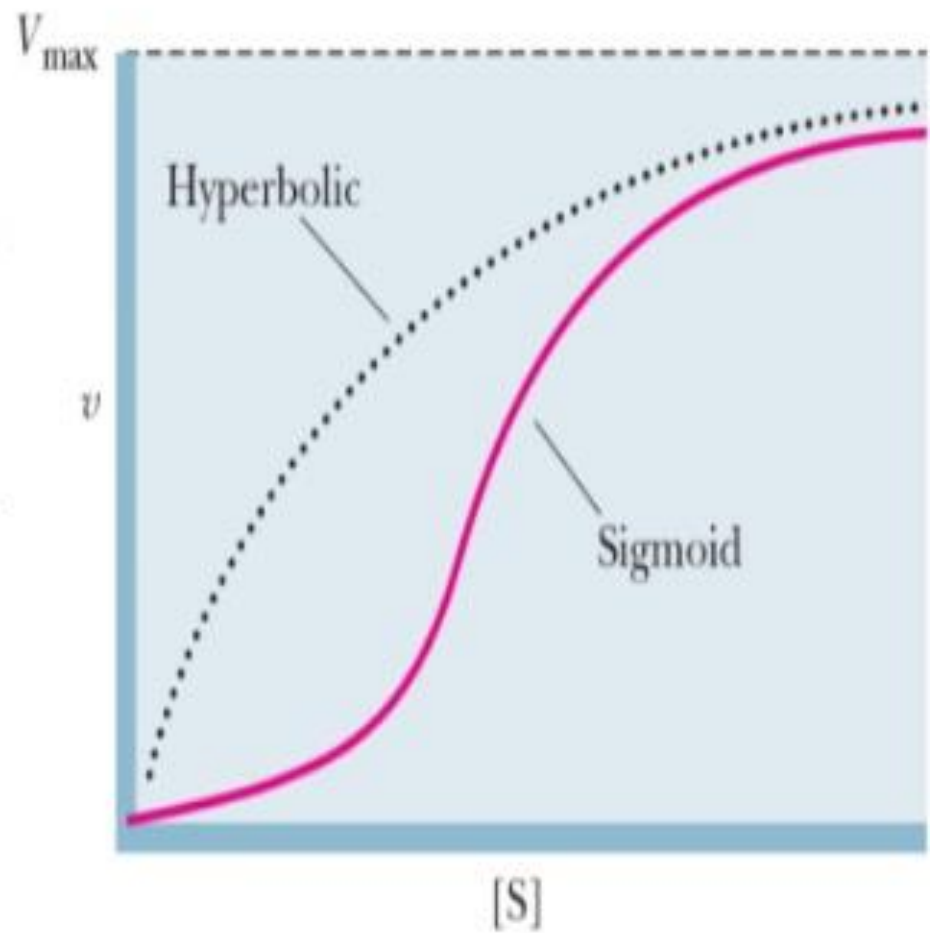


**N-Carbamoylaspartate**

+

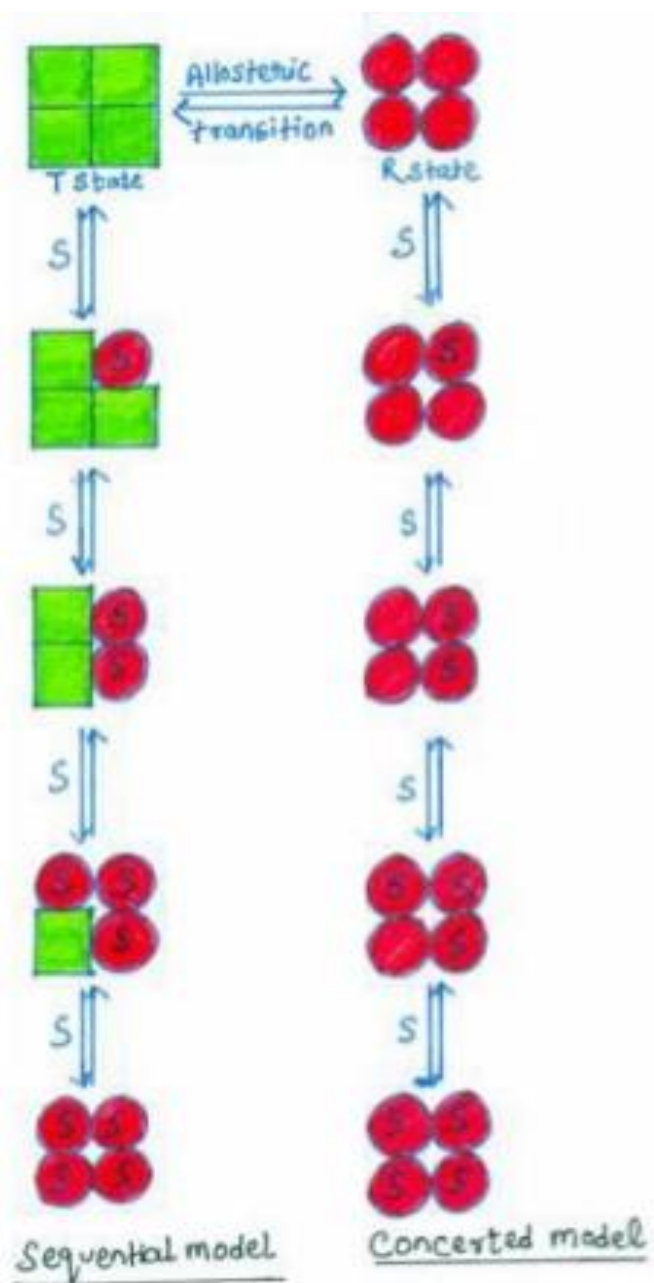


- Allosteric enzymes show **relationships** between  $V_o$  and  $[S]$  that **differ** from normal **Michaelis-Menten behavior**.
- They exhibit **saturation** with the **substrate** when  $[S]$  is sufficiently **high**.
- When  $V_o$  is plotted against  $[S]$  a **sigmoid saturation curve** results.
- The symbol  $[S]_{0.5}$  or  $K_{0.5}$  is used to represent the substrate concentration giving half maximal velocity.

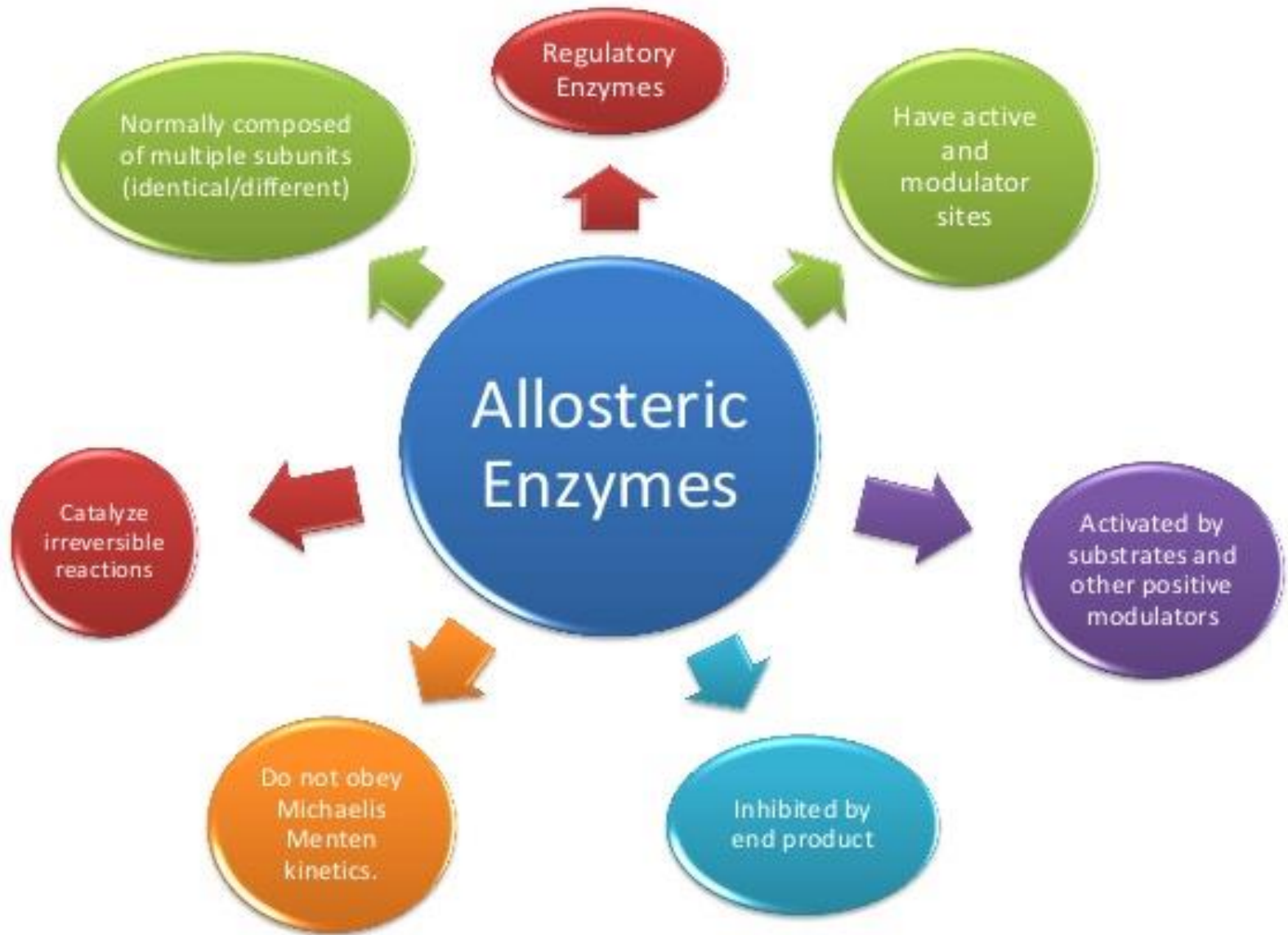


- **Sigmoid kinetic behavior** generally reflects **cooperative interactions** between multiple protein subunits.
- The principles are similar to those for **cooperativity** in **oxygen binding** to the non-enzyme **protein hemoglobin**.
- The **substrate** can function as a positive modulator (an **activator**) because the subunits act cooperatively.
- The **binding** of **one molecule** of the substrate to one binding site greatly **enhances** the **binding** of **subsequent substrate molecules**.

- The sigmoidal dependence of  $V_o$  on  $[S]$  reflects subunit cooperativity, and has inspired two models to explain these cooperative interactions.
- In the concerted (symmetry model), proposed by **Jacques Monod** and colleagues in **1965**, an allosteric enzyme can exist in only **two conformations**, active and inactive
- All subunits are in the active form or all are inactive.
- In the **second model (the sequential model)**, proposed by **Koshland** in **1966**, there are still two conformations, but subunits can undergo the conformational change individually.
- Binding of substrate increases the probability of the conformational change.



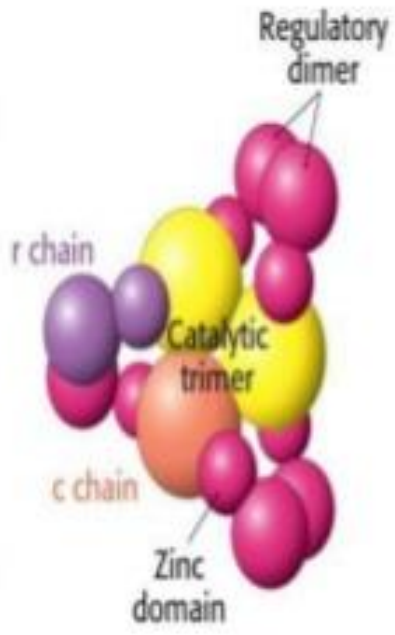
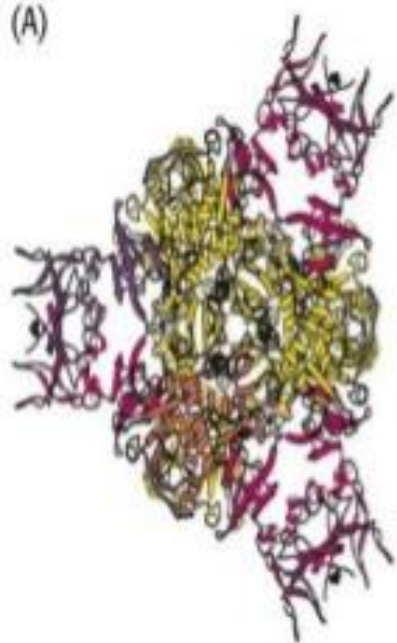




# ATCase as an allosteric enzyme

- ✓ **Aspartate transcarbamoylase (ATCase)** is an **allosteric enzyme** which has **12 polypeptide chains** organized into catalytic and regulatory subunits.
- ✓ The enzyme catalyzes the first step in the **synthesis of pyrimidines**.
- ✓ The enzyme functions to catalyze the **condensation** of **aspartate** and **carbamoyl phosphate** to form **N-carbamoylaspartate** and **orthophosphate**.
- ✓ The enzyme ultimately catalyzes the reaction that will yield **cytidine triphosphate (CTP)**.
- ✓ This allosteric enzyme is unique in that for **high concentration** of the final product **CTP**, the enzyme **activity** is **low**.
- ✓ However, for **low concentrations** of the final product **CTP**, the enzymatic activity is **high**.

(A)

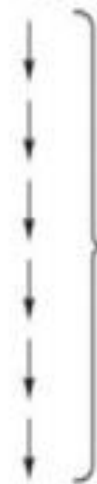


Carbamoyl phosphate  
+  
Aspartate

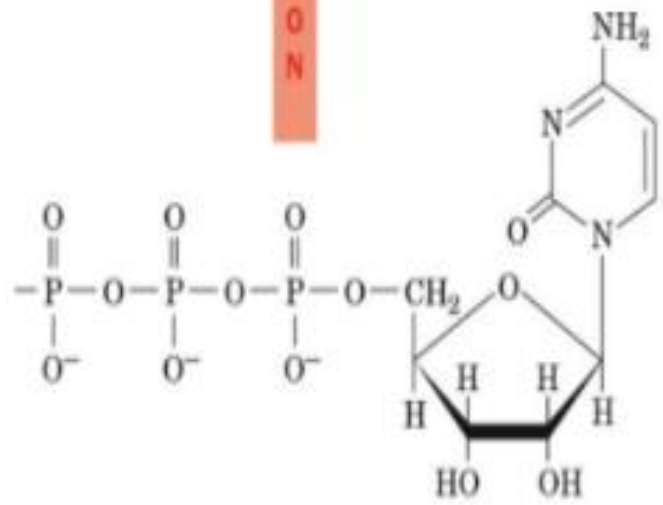
ATCase

N-Carbamoyl aspartate

↑  
I  
N  
H  
I  
B  
I  
T  
I  
O  
N

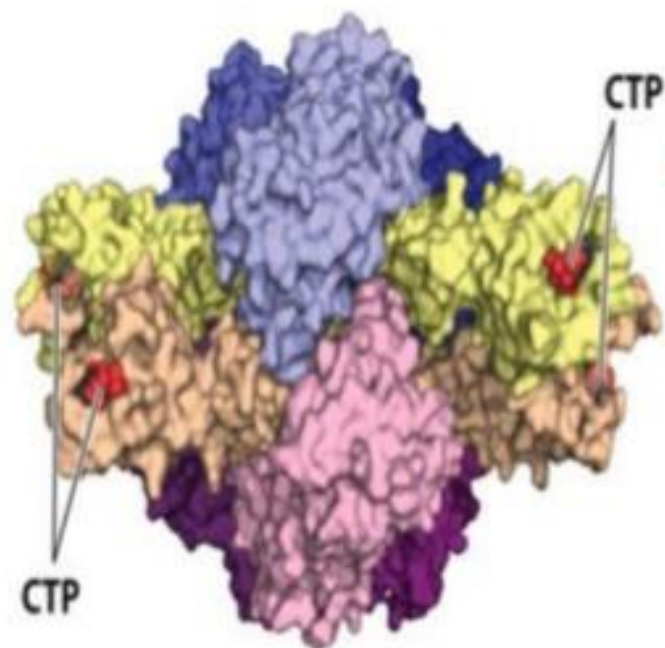


6 enzymatic  
reaction steps

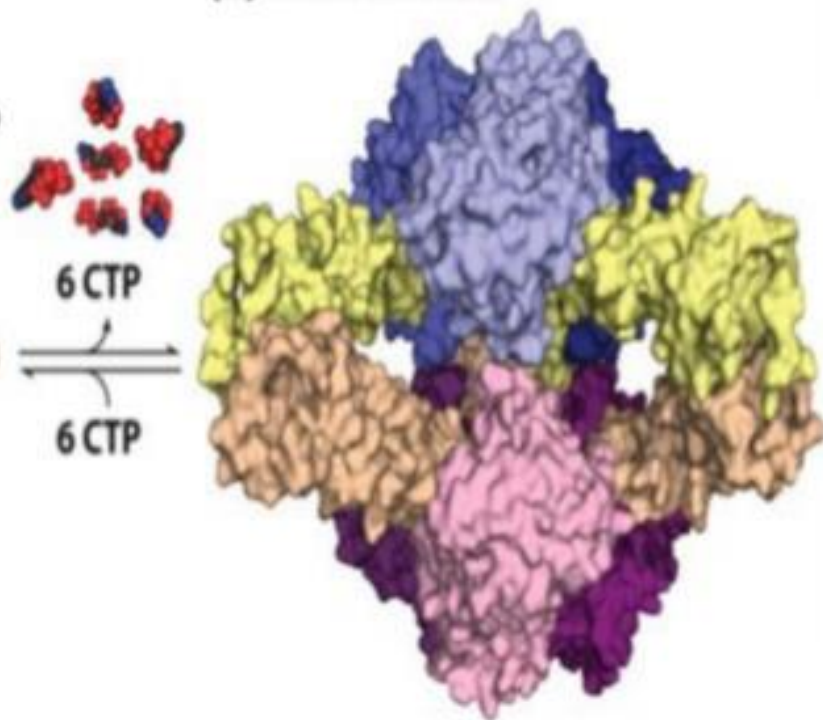


Cytidine triphosphate (CTP)

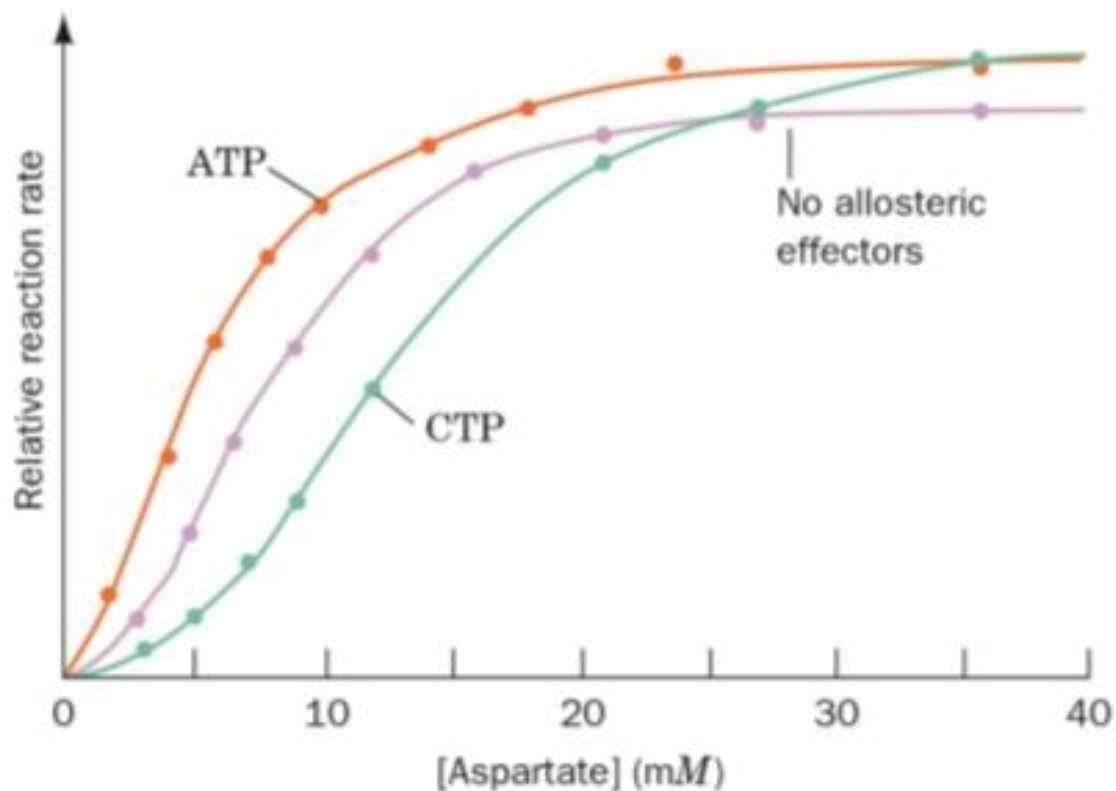
**(a) Inactive T state**



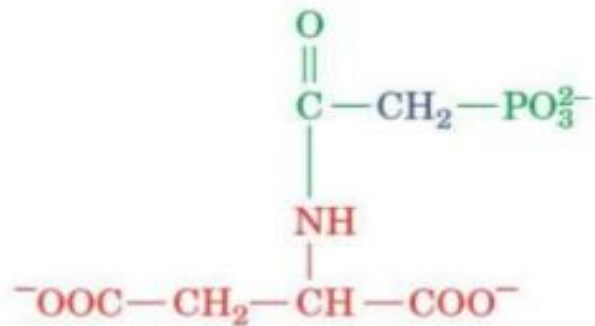
**(b) Active R state**



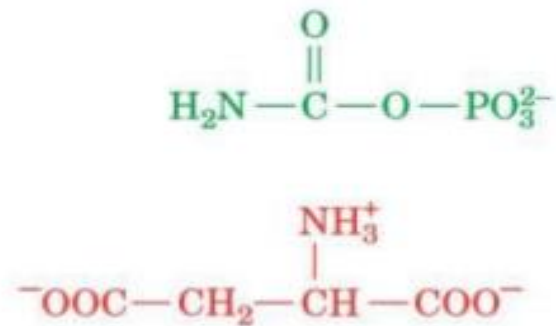
# Effect of ATP and CTP on ATCase



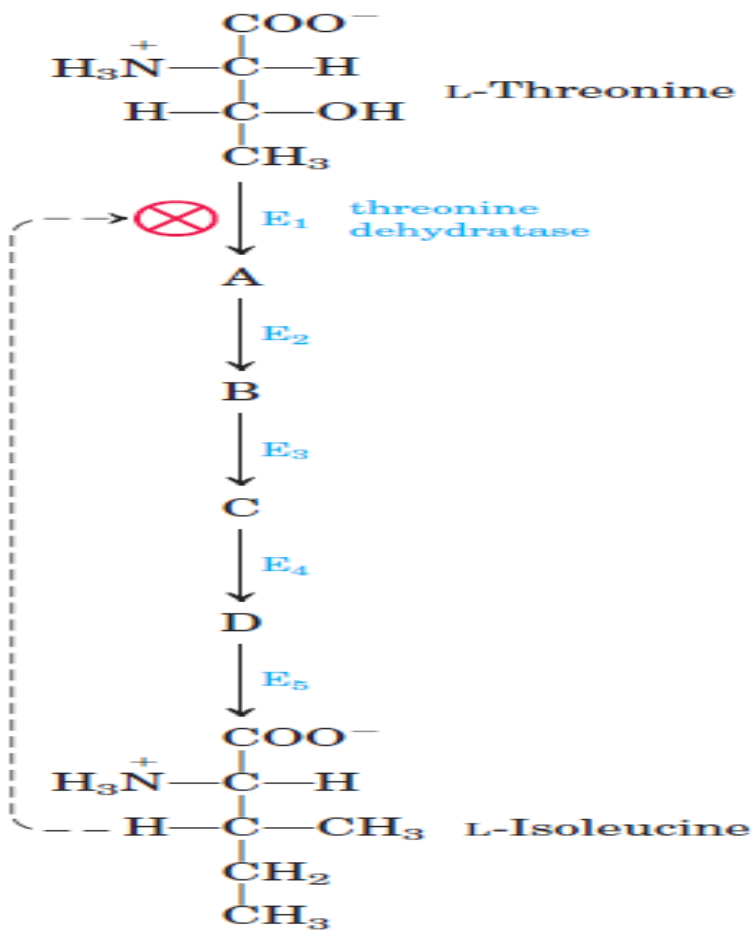
# PALA and ATCase



**N-(Phosphonacetyl)-  
L-aspartate (PALA)**

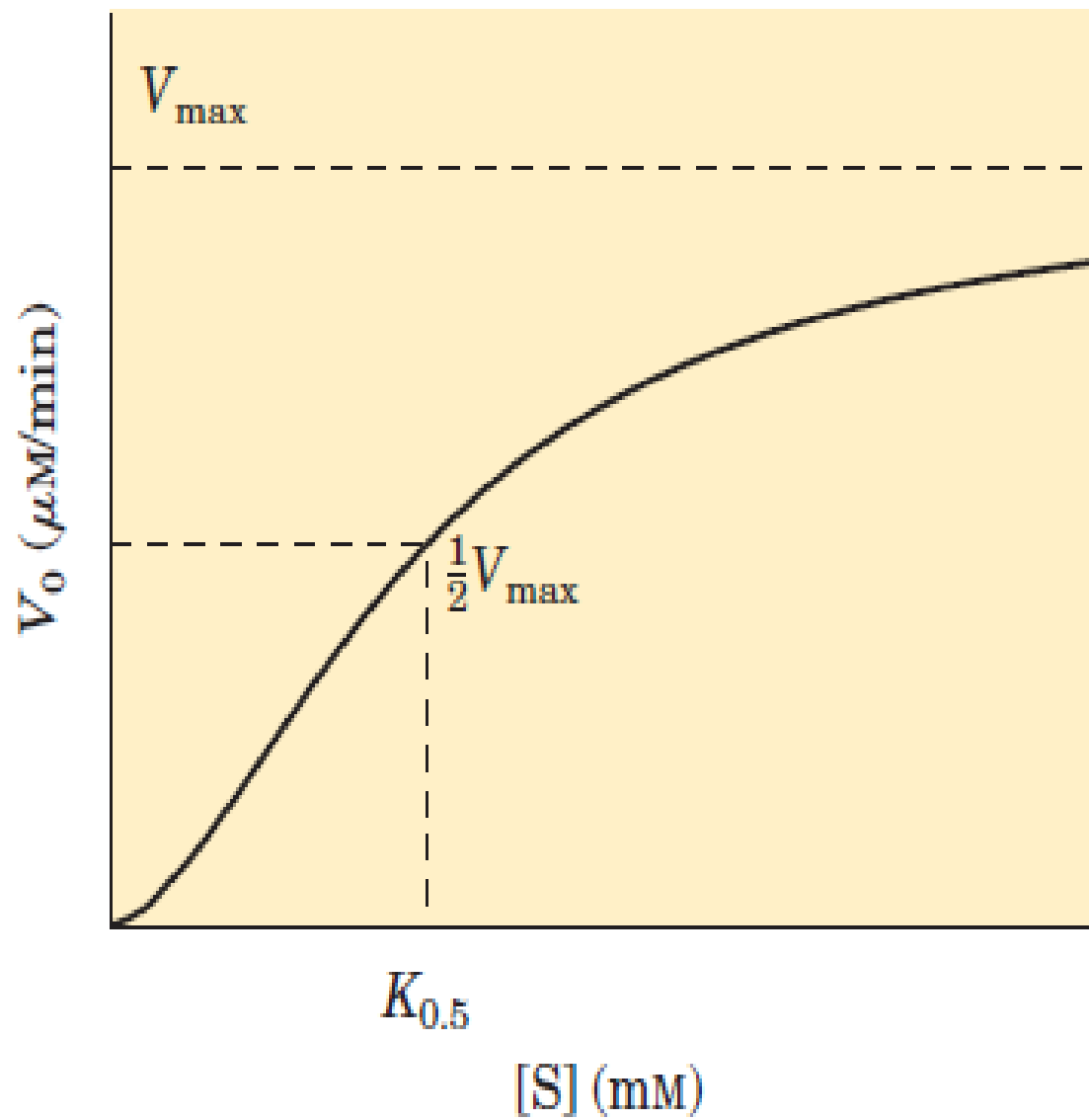


**Carbamoyl phosphate  
+  
Aspartate**



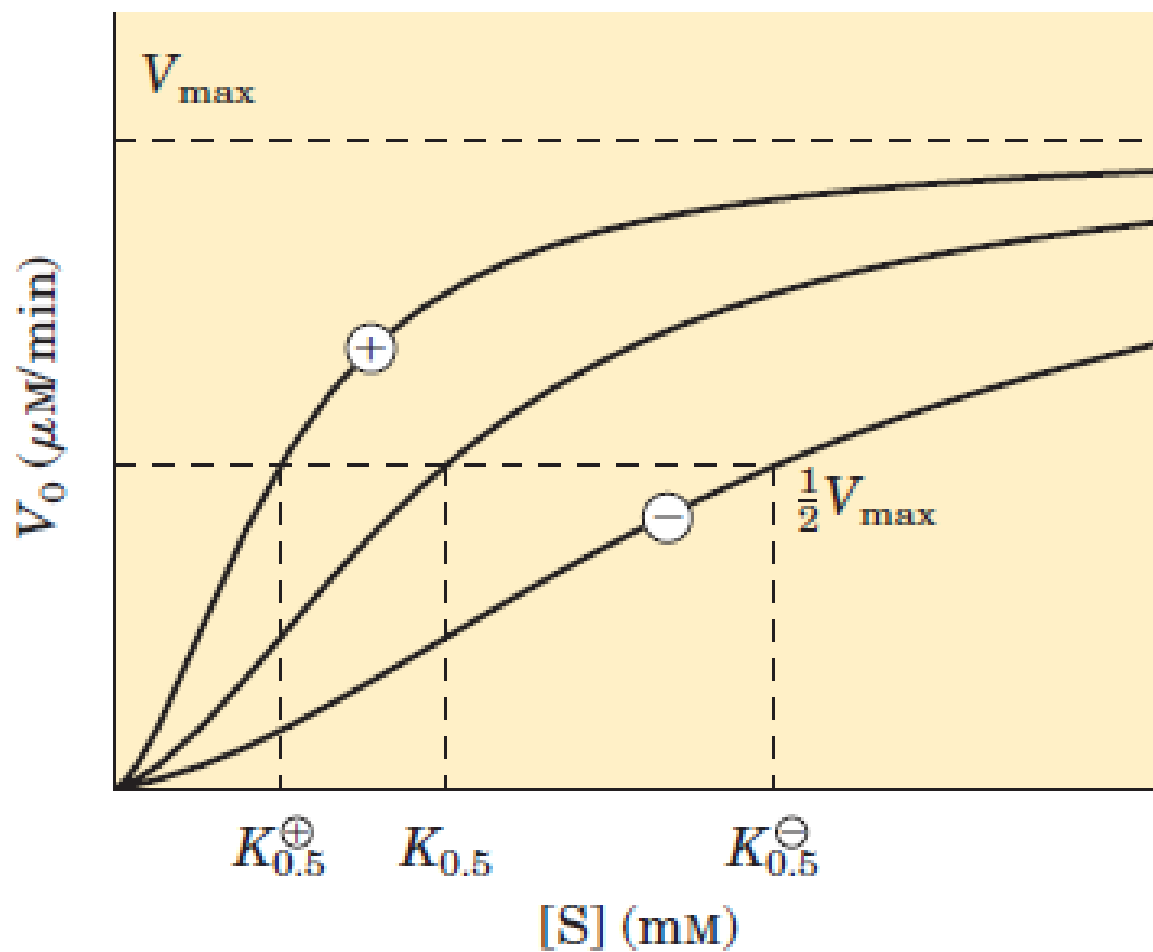
**FIGURE 6-28 Feedback inhibition.** The conversion of L-threonine to L-isoleucine is catalyzed by a sequence of five enzymes ( $E_1$  to  $E_5$ ). Threonine dehydratase ( $E_1$ ) is specifically inhibited allosterically by L-isoleucine, the end product of the sequence, but not by any of the four intermediates (A to D). Feedback inhibition is indicated by the dashed feedback line and the  $\otimes$  symbol at the threonine dehydratase reaction arrow, a device used throughout this book.

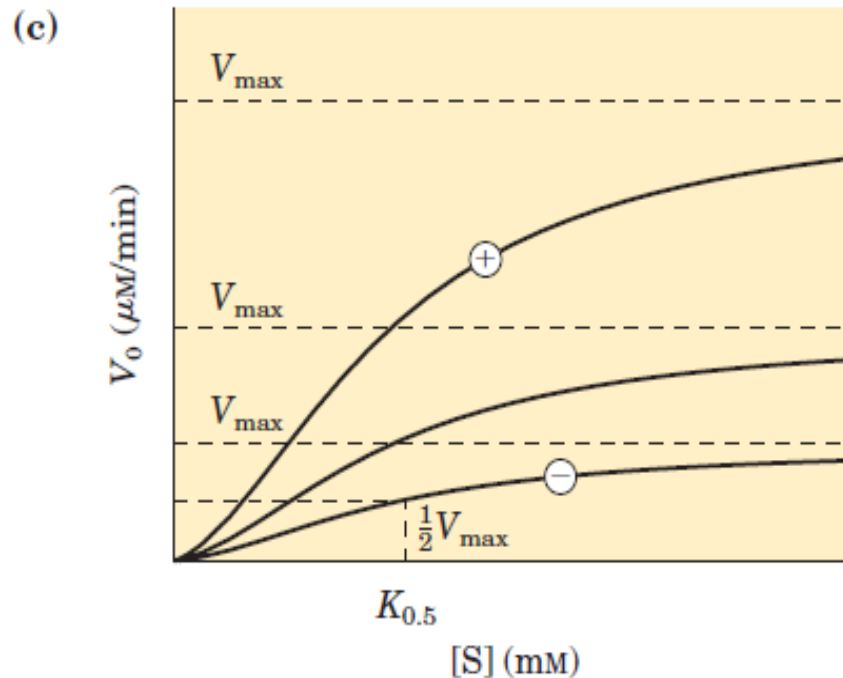
(a)



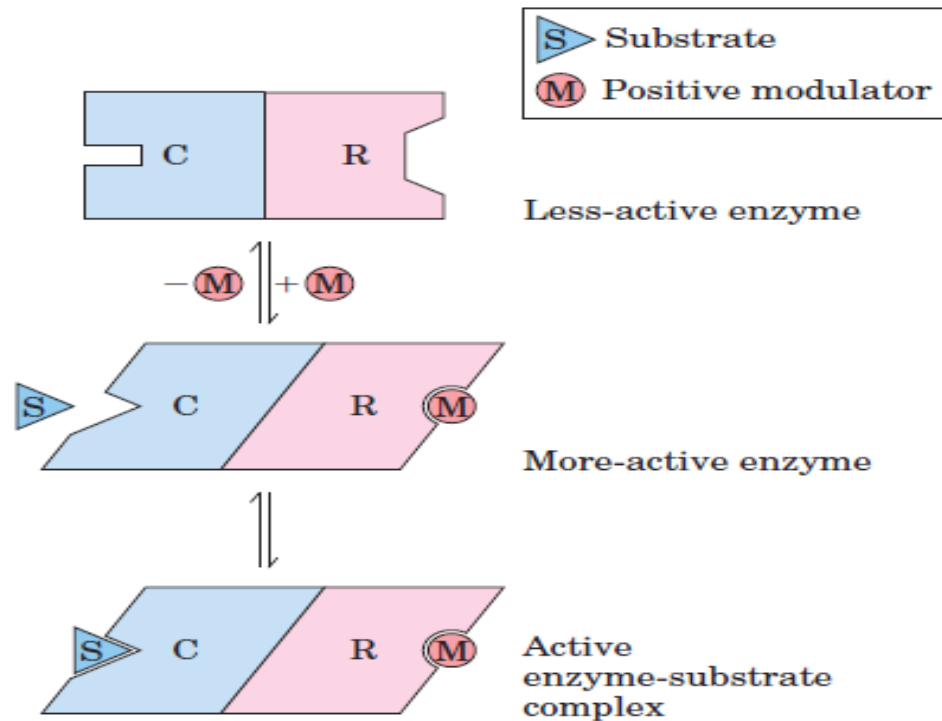


(b)

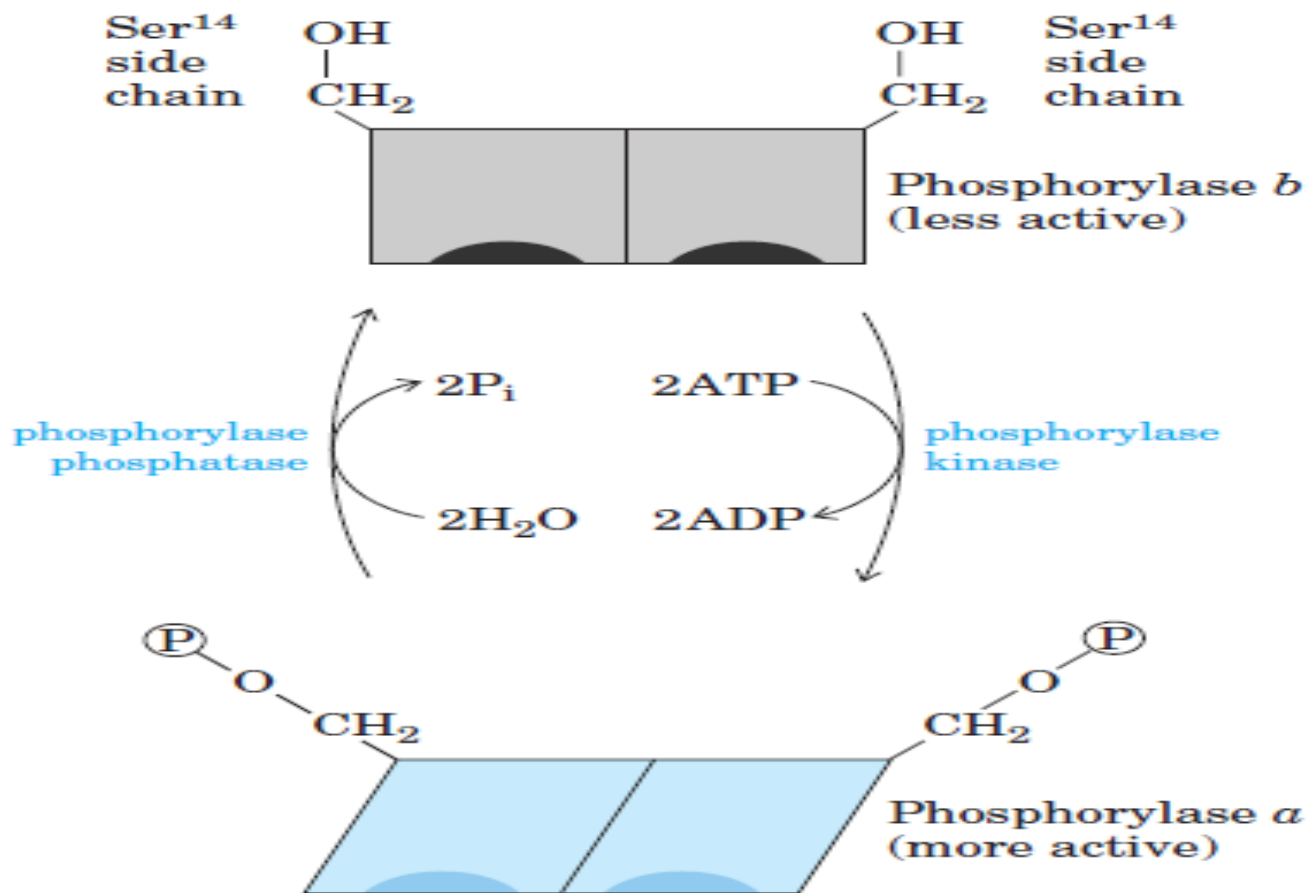




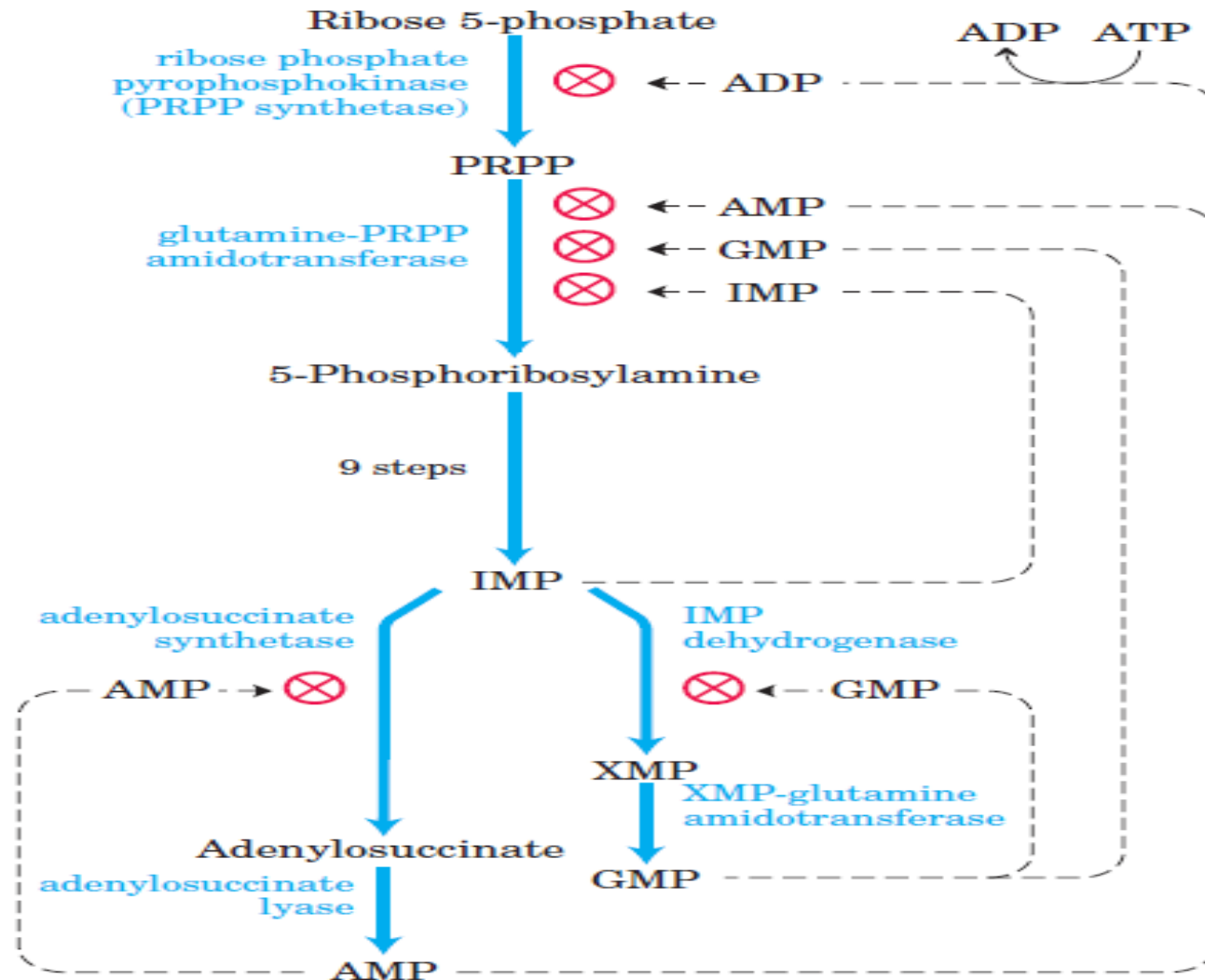
**FIGURE 6-29** Substrate-activity curves for representative allosteric enzymes. Three examples of complex responses of allosteric enzymes to their modulators. (a) The sigmoid curve of a homotropic enzyme, in which the substrate also serves as a positive (stimulatory) modulator, or activator. Note the resemblance to the oxygen-saturation curve of hemoglobin (see Fig. 5-12). (b) The effects of a positive modulator (+) and a negative modulator (-) on an allosteric enzyme in which  $K_{0.5}$  is altered without a change in  $V_{\text{max}}$ . The central curve shows the substrate-activity relationship without a modulator. (c) A less common type of modulation, in which  $V_{\text{max}}$  is altered and  $K_{0.5}$  is nearly constant.



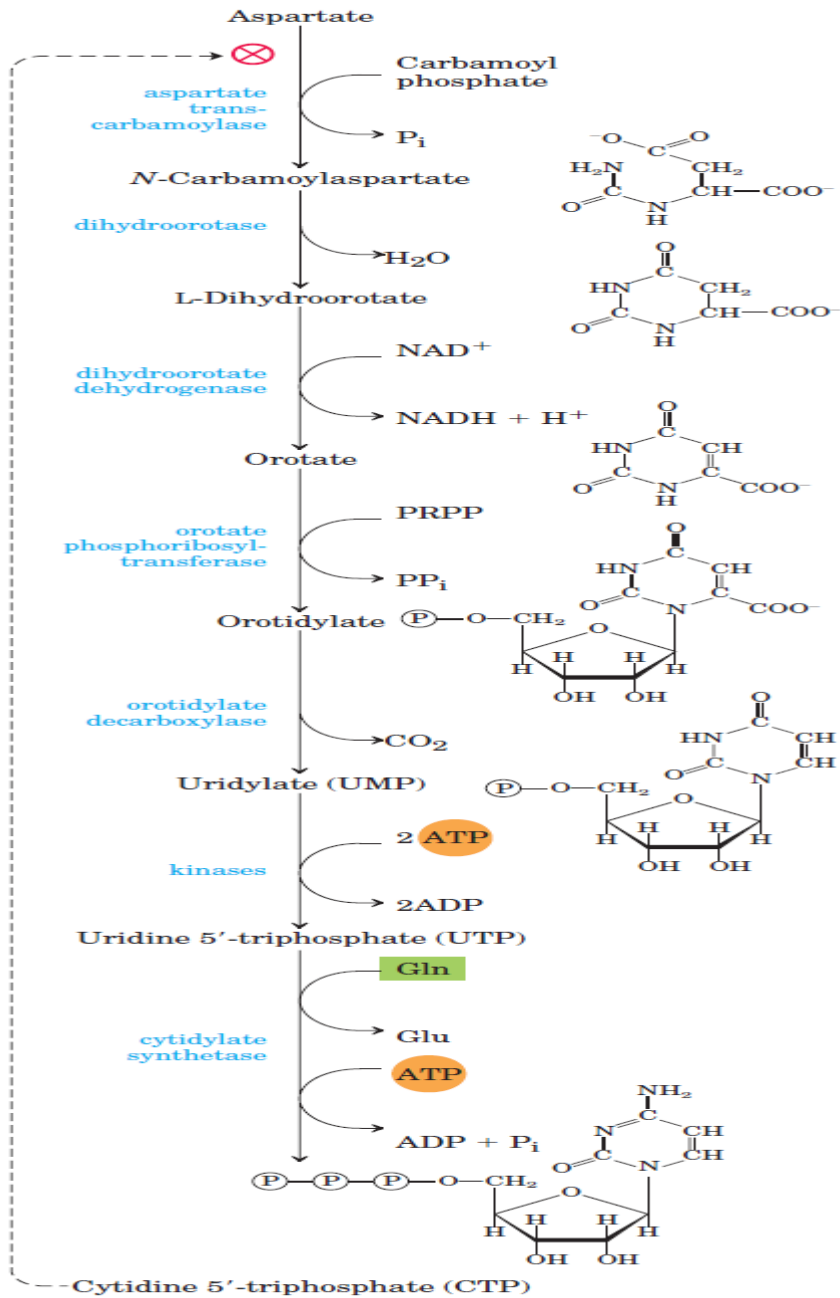
**FIGURE 6-26** Subunit interactions in an allosteric enzyme, and interactions with inhibitors and activators. In many allosteric enzymes the substrate binding site and the modulator binding site(s) are on different subunits, the catalytic (C) and regulatory (R) subunits, respectively. Binding of the positive (stimulatory) modulator (M) to its specific site on the regulatory subunit is communicated to the catalytic subunit through a conformational change. This change renders the catalytic subunit active and capable of binding the substrate (S) with higher affinity. On dissociation of the modulator from the regulatory subunit, the enzyme reverts to its inactive or less active form.

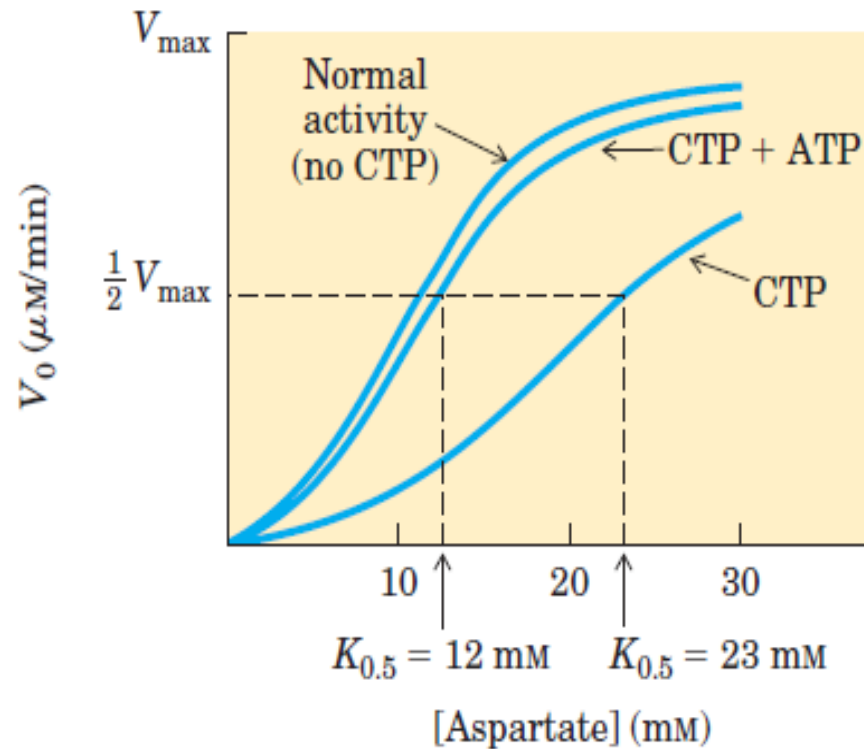


**FIGURE 6-31 Regulation of glycogen phosphorylase activity by covalent modification.** In the more active form of the enzyme, phosphorylase *a*, specific Ser residues, one on each subunit, are phosphorylated. Phosphorylase *a* is converted to the less active phosphorylase *b* by enzymatic loss of these phosphoryl groups, promoted by phosphorylase phosphatase. Phosphorylase *b* can be reconverted (reactivated) to phosphorylase *a* by the action of phosphorylase kinase.

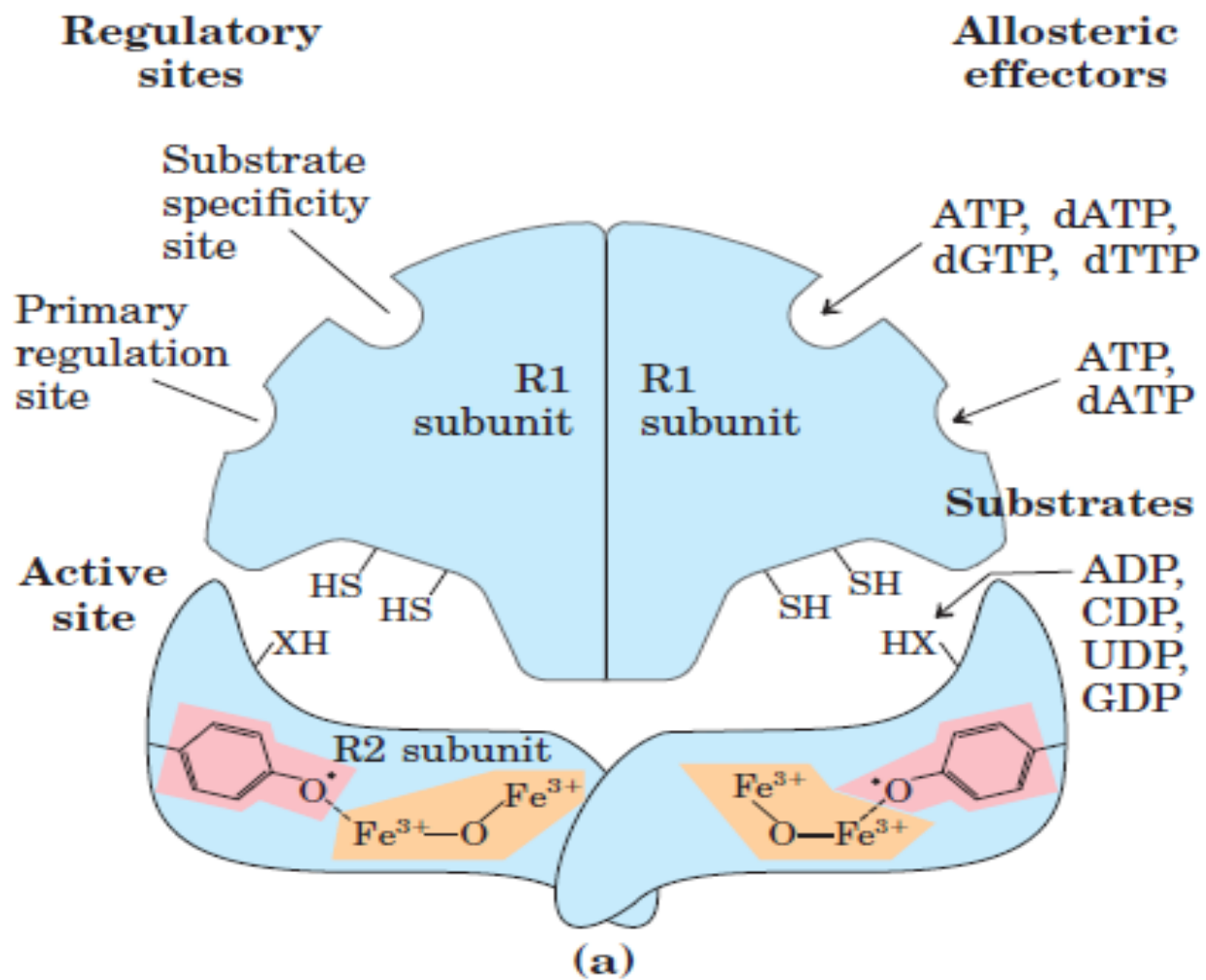


**FIGURE 22-35** Regulatory mechanisms in the biosynthesis of adenine and guanine nucleotides in *E. coli*. Regulation of these pathways differs in other organisms.

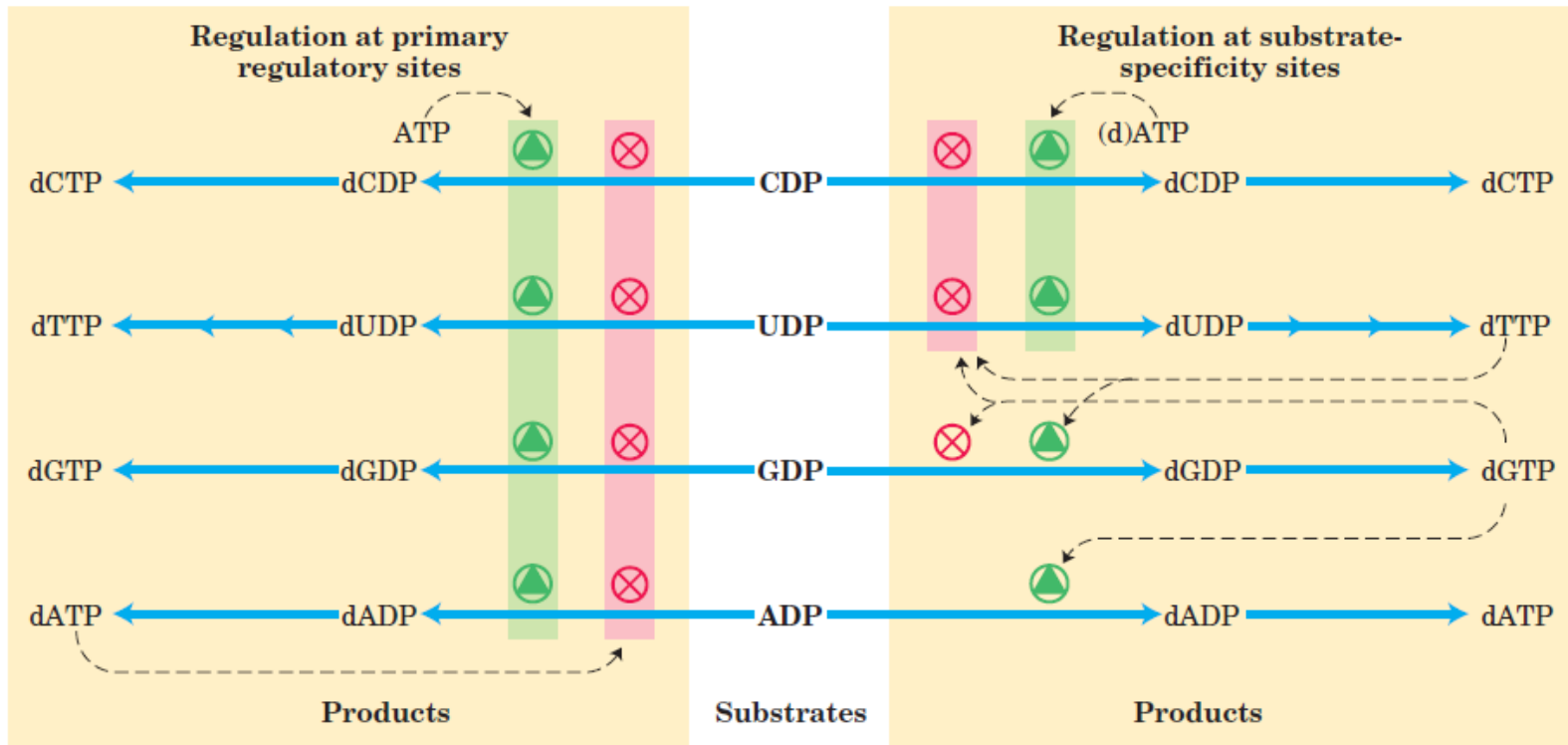




**FIGURE 22-38** Allosteric regulation of aspartate transcarbamoylase by CTP and ATP. Addition of 0.8  $\text{mM}$  CTP, the allosteric inhibitor of ATCase, increases the  $K_{0.5}$  for aspartate (lower curve) and the rate of conversion of aspartate to *N*-carbamoylaspartate. ATP at 0.6  $\text{mM}$  fully reverses this effect (middle curve).

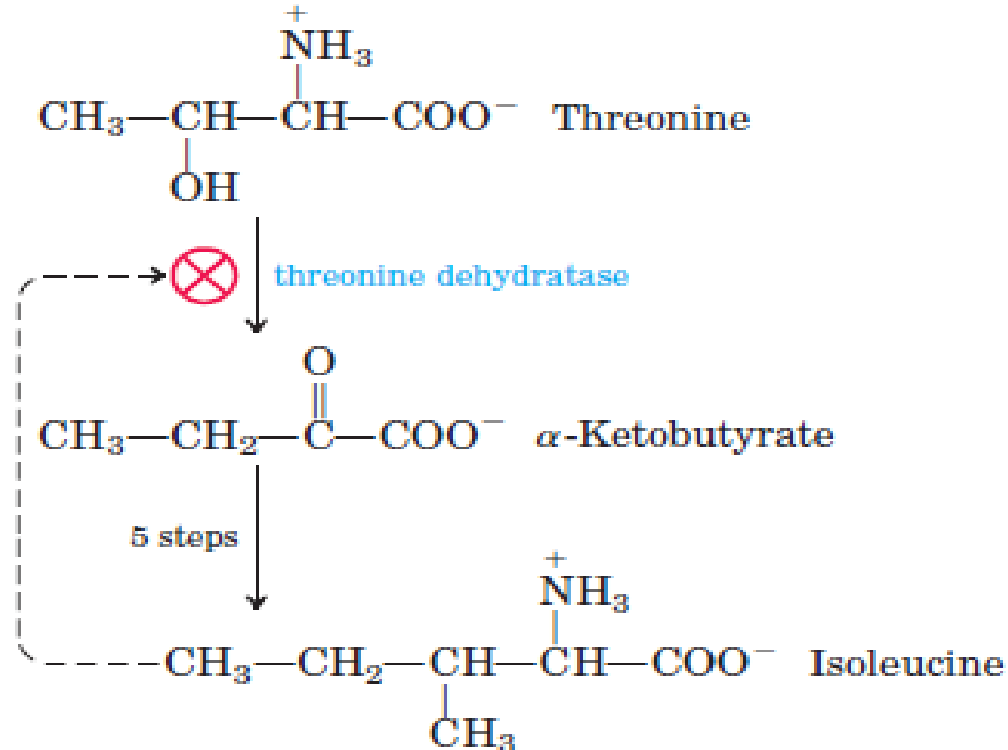




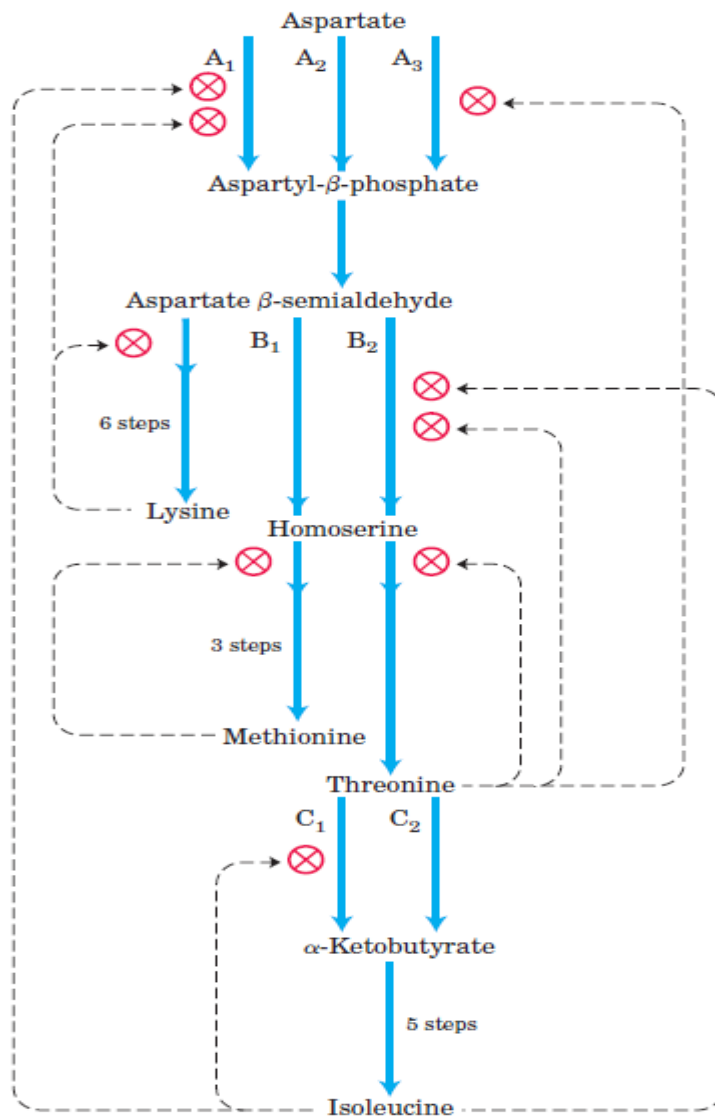


**FIGURE 22-42** Regulation of ribonucleotide reductase by deoxynucleoside triphosphates. The overall activity of the enzyme is affected by binding at the primary regulatory site (left). The substrate specificity of the enzyme is affected by the nature of the effector molecule bound

at the second type of regulatory site (right). The diagram indicates inhibition or stimulation of enzyme activity with the four different substrates. The pathway from dUDP to dTTP is described later (see Figs 22-43, 22-44).



**FIGURE 22-21** Allosteric regulation of isoleucine biosynthesis. The first reaction in the pathway from threonine to isoleucine is inhibited by the end product, isoleucine. This was one of the first examples of allosteric feedback inhibition to be discovered. The steps from  $\alpha$ -ketobutyrate to isoleucine correspond to steps (18) through (21) in Figure 22-15 (five steps because (19) is a two-step reaction).

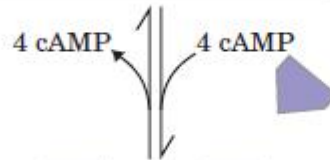
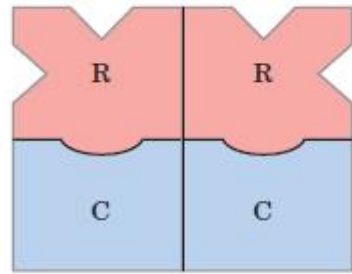


**FIGURE 22-22** Interlocking regulatory mechanisms in the biosynthesis of several amino acids derived from aspartate in *E. coli*. Three enzymes (A, B, C) have either two or three isozyme forms, indicated by numerical subscripts. In each case, one isozyme ( $A_2$ ,  $B_1$ , and  $C_2$ ) has no allosteric regulation; these isozymes are regulated by changes in the amount synthesized (Chapter 28). Synthesis of isozymes  $A_2$  and  $B_1$  is repressed when methionine levels are high, and synthesis of isozyme  $C_2$  is repressed when isoleucine levels are high. Enzyme A is aspartokinase; B, homoserine dehydrogenase; C, threonine dehydratase.

### Inactive PKA

Regulatory subunits:  
empty cAMP sites

Catalytic subunits:  
substrate-binding  
sites blocked by  
autoinhibitory  
domains of R subunits

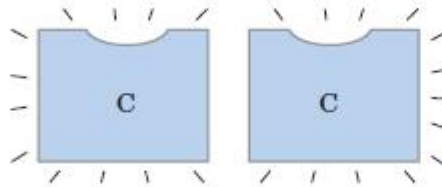


Regulatory subunits:  
autoinhibitory  
domains buried

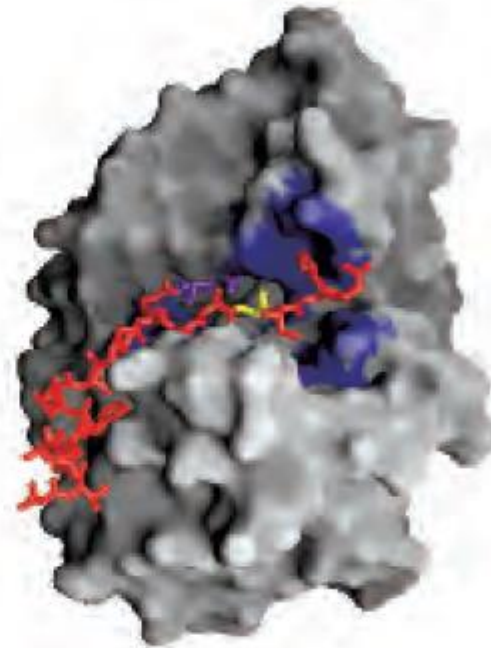


### Active PKA

Catalytic subunits:  
open substrate-  
binding sites



(a)



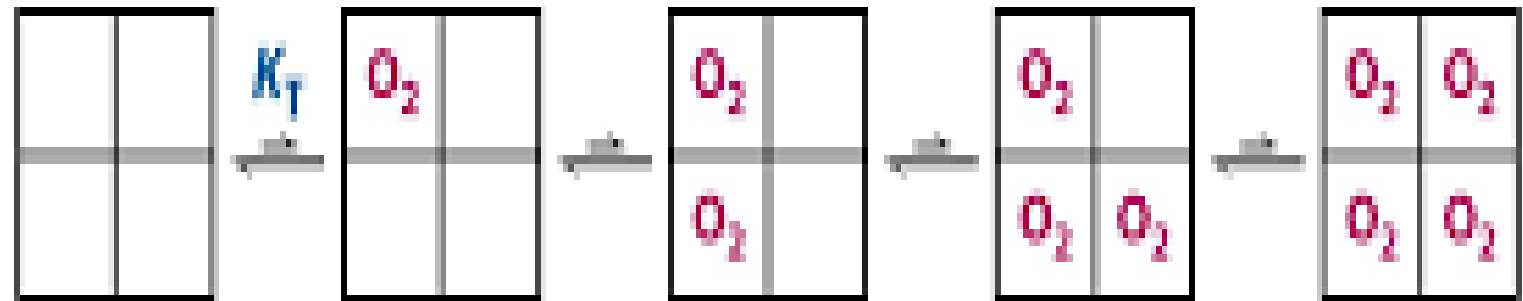
(b)

### FIGURE 12-15 Activation of cAMP-dependent protein kinase, PKA.

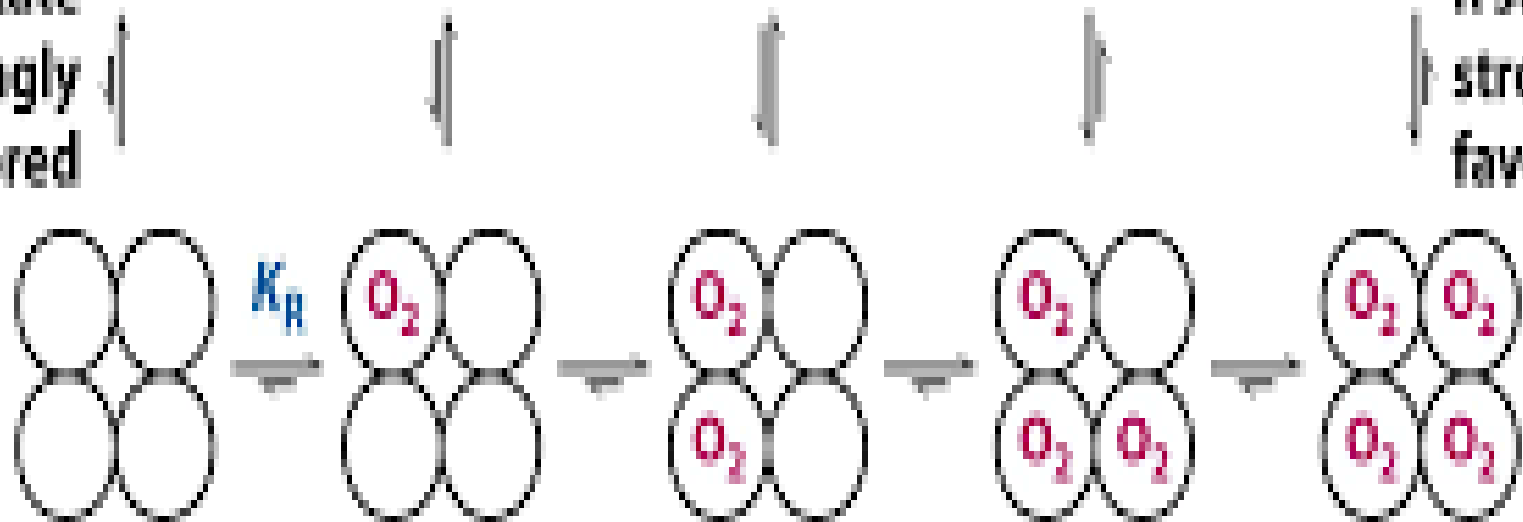
(a) A schematic representation of the inactive  $R_2C_2$  tetramer, in which the autoinhibitory domain of a regulatory (R) subunit occupies the substrate-binding site, inhibiting the activity of the catalytic (C) subunit. Cyclic AMP activates PKA by causing dissociation of the C subunits from the inhibitory R subunits. Activated PKA can phosphorylate a variety of protein substrates (Table 12-3) that contain the PKA consensus sequence (X-Arg-(Arg/Lys)-X-(Ser/Thr)-B, where X is any

residue and B is any hydrophobic residue), including phosphorylase b kinase. (b) The substrate-binding region of a catalytic subunit revealed by x-ray crystallography (derived from PDB ID 1JBP). Enzyme side chains known to be critical in substrate binding and specificity are in blue. The peptide substrate (red) lies in a groove in the enzyme surface, with its Ser residue (yellow) positioned in the catalytic site. In the inactive  $R_2C_2$  tetramer, the autoinhibitory domain of R lies in this groove, blocking access to the substrate.

**T state**



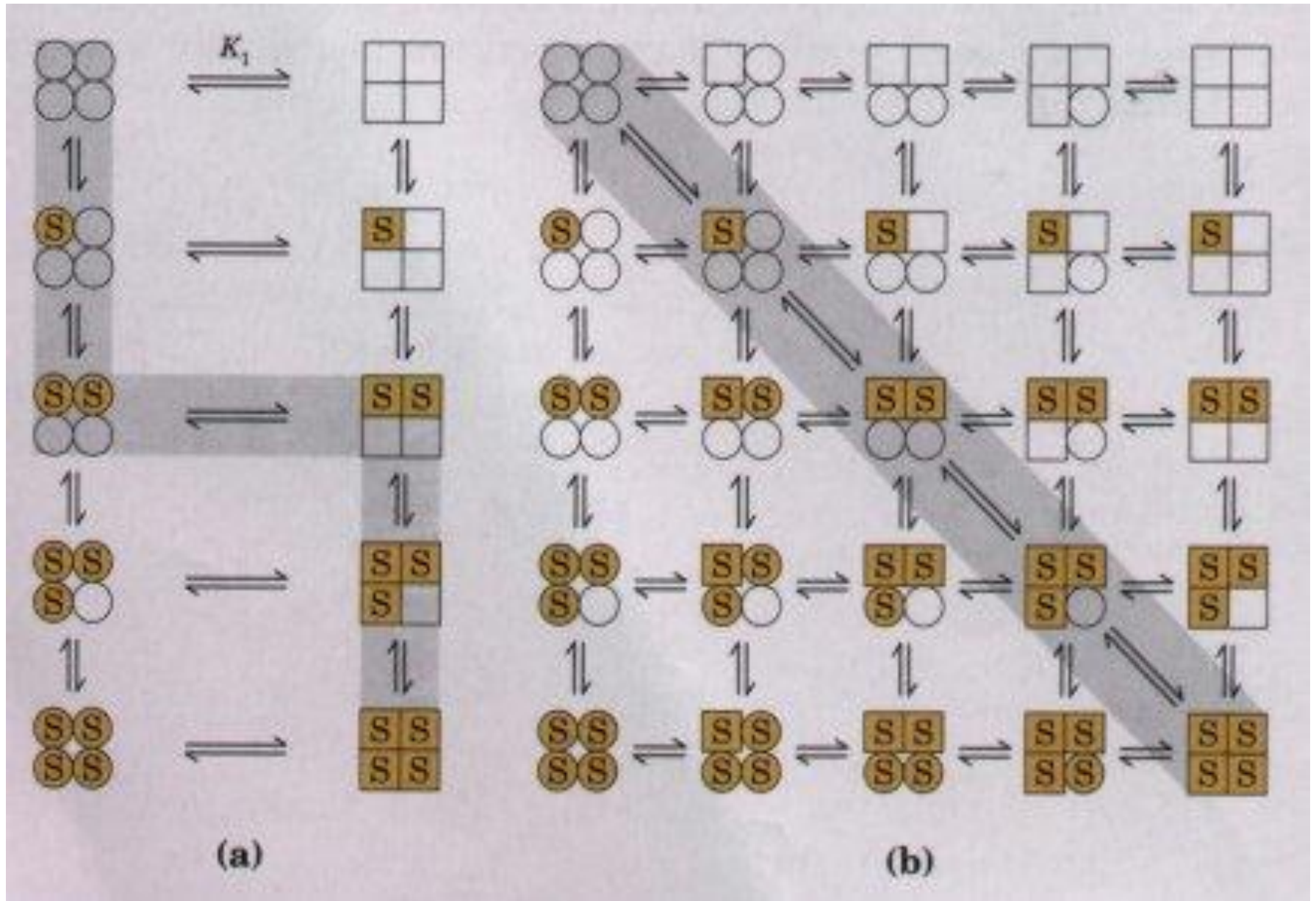
**T state  
strongly  
favored**

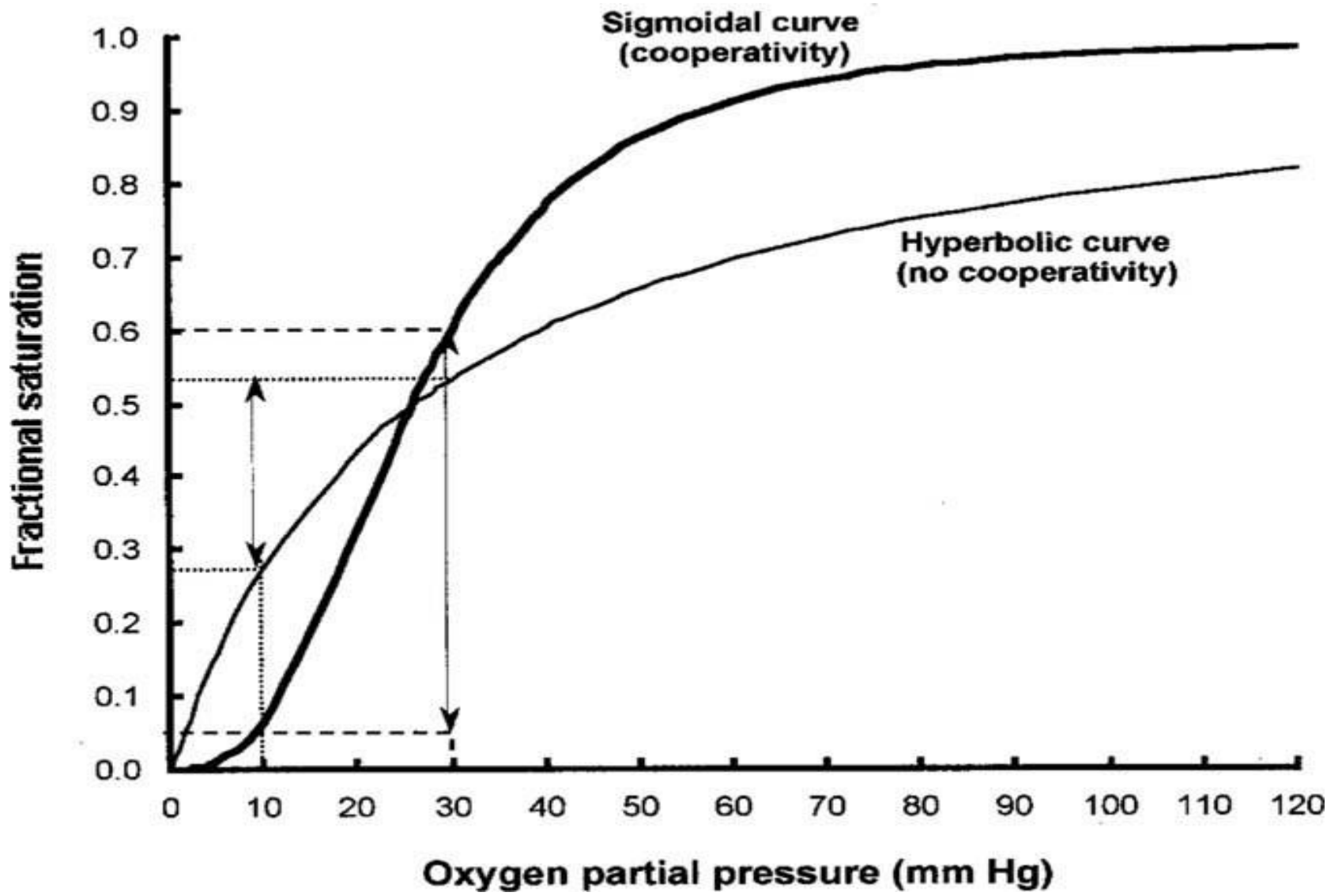


**R state  
strongly  
favored**

**R state**

# MWC MODEL

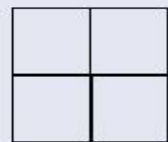




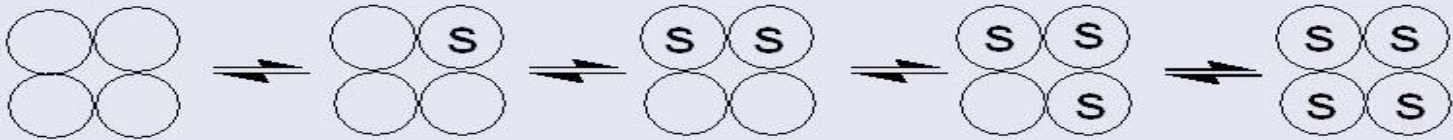


# MONOD-WYMAN-CHANGEUX (MWC) MODEL

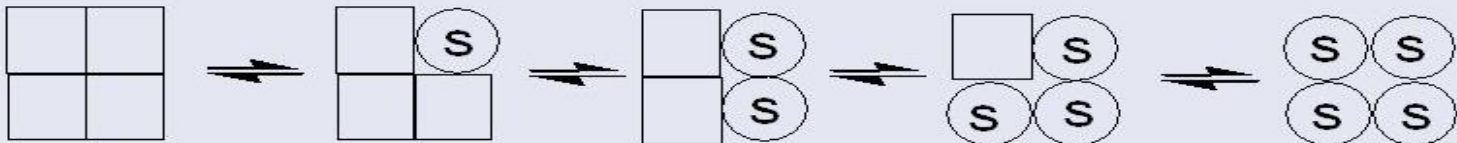
# KOSHLAND- MEMETHY-FILMER(KNF) MODEL



MWC: Two state concerted



KNF: One state sequential



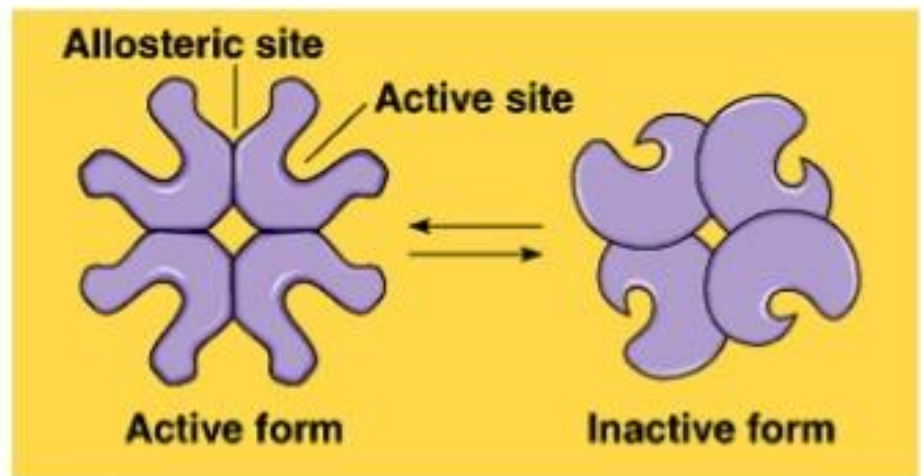
# Allosteric Regulation

---

- Regulating an enzyme's activity with a molecule that binds to the enzyme at a site removed from the active site
- The players:
  - Allosteric enzyme: has an allosteric site
  - Allosteric site: a specific binding site on the enzyme that is not the active site
  - Effector: a regulator that can activate or inhibit by the enzyme by binding to an allosteric site

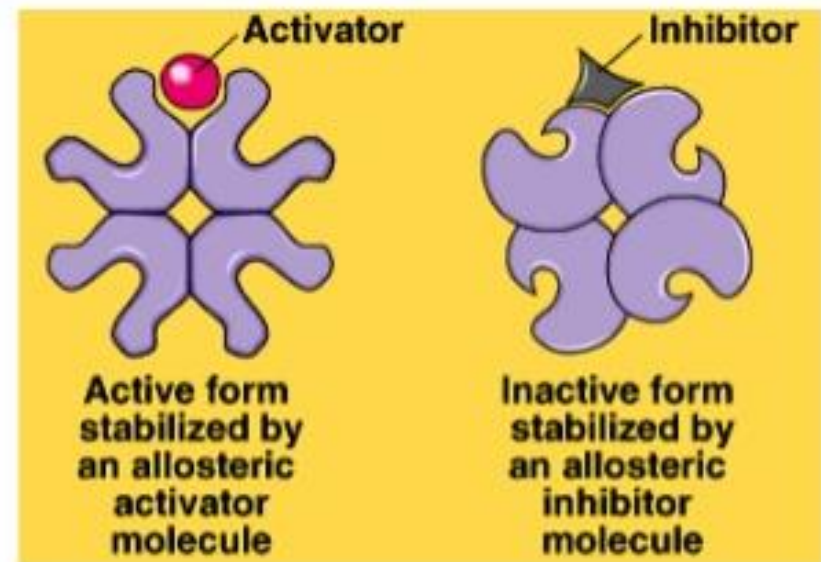
# Allosteric Enzyme

- Most are constructed of two or more polypeptide chains (subunits)
- Each subunit has its own active site
- Allosteric sites are often located where subunits join
- Protein oscillates between an active and an inactive conformation



# Effector: Allosteric Regulators

- Effectors change enzymatic activity by binding weakly to an allosteric site
  - Allosteric **activator**: stabilizes the conformation that has a functional active site
  - Allosteric **inhibitor**: stabilizes the conformation that lacks an active site (inactive form)
- Often works through cooperativity



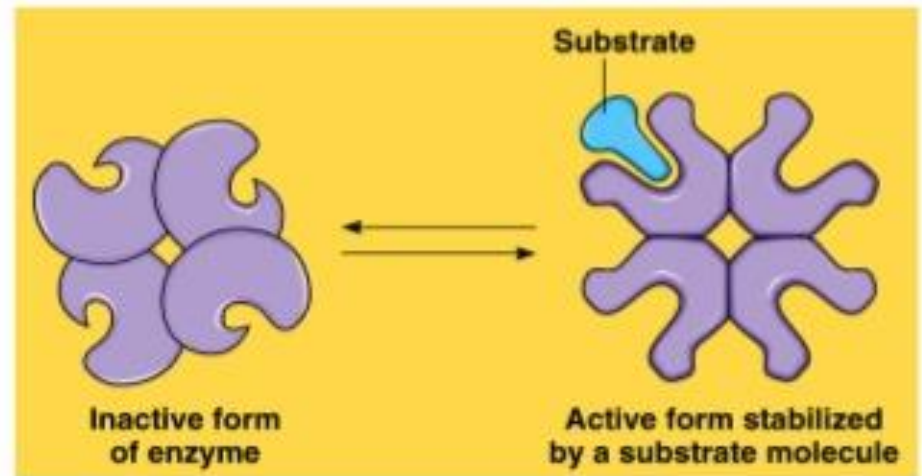
# Cooperativity

---

- Binding of a molecule (substrate or effector) stabilizes a conformational change on all the other subunits
- Can result in an increase or decrease in substrate affinity
- Can only occur in enzymes with multiple subunits

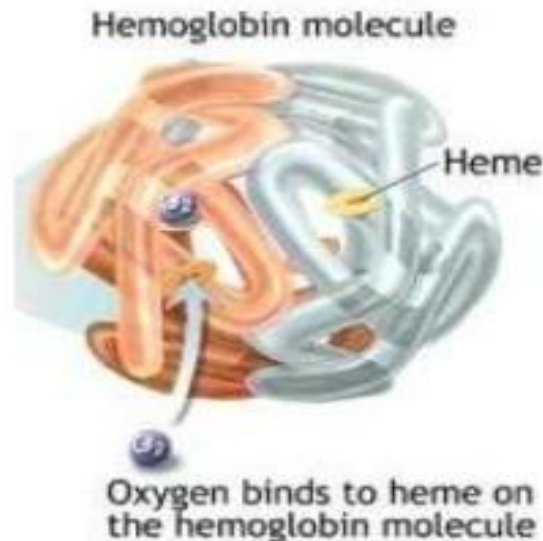
# Cooperativity

- Example of positive cooperativity: substrate binding to one active site stabilizes conformational changes at all the other subunits
- Example of negative cooperativity: some forms of allosteric inhibition

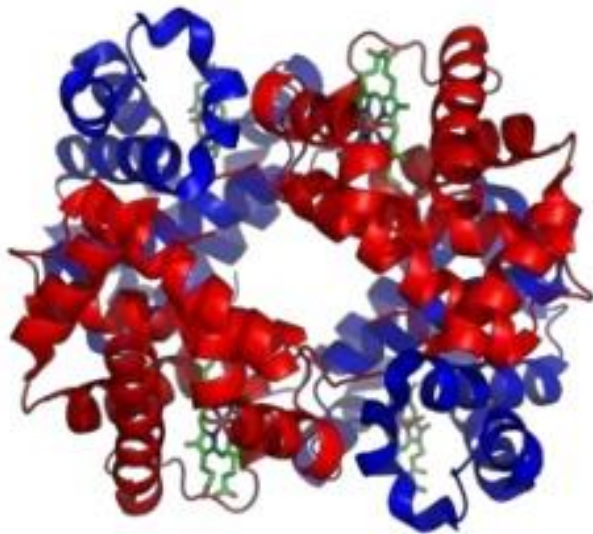


# What is Oxygen binding?

Oxygen binding is the binding of an oxygen molecule to a specific functional protein for either transport or storage *in vivo*.



# Hemoglobin (Hb)

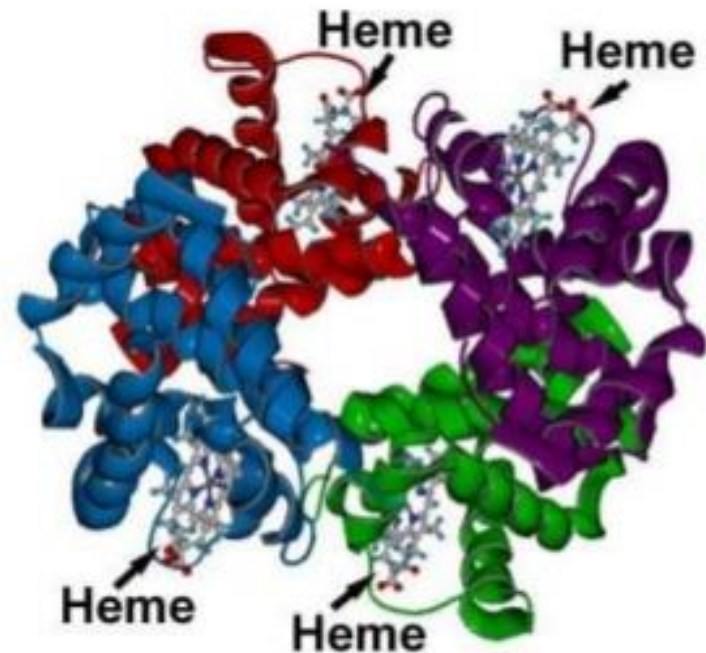


- Tetrameric, two alpha chains and two beta chains
- binds a total of 4 oxygen molecules
- carries  $O_2$  from lungs to tissues
- cooperative binding of  $O_2$
- required to increase the solubility of  $O_2$  in blood



# The Heme group

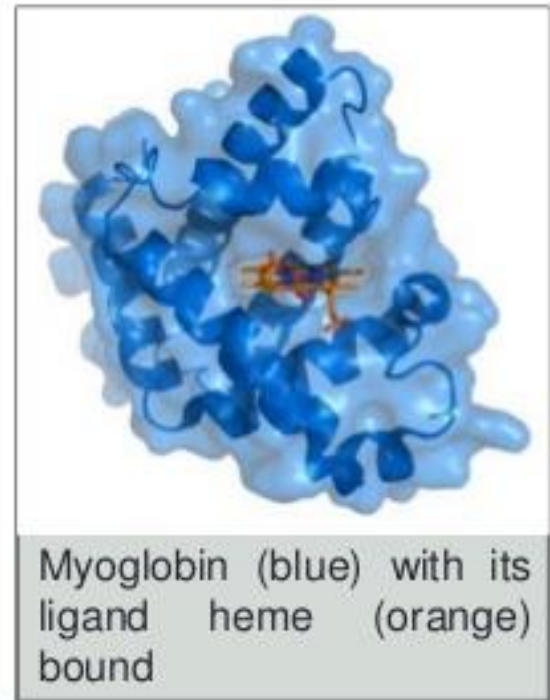
- Example of a prosthetic group
- Heterocyclic ring containing 4 pyrrole rings
- Central atom is  $\text{Fe}^{2+}$  (usual oxidation state)
- Proximal Histidine is important in transducing the binding event to protein.



# Ligands

a **ligand** (from the Latin **ligandum**, *binding*) is a substance (usually a small molecule), that forms a complex with a biomolecule to serve a biological purpose.

In a narrower sense, it is a signal triggering molecule, binding to a site on a target protein.



# Mechanism of positive cooperativity in Hemoglobin

- Binding of O<sub>2</sub> to Fe moves proximal Histidine residue and its attached helix (F)
- Helix F adjusts conformation by movement of a b subunits (hinge and helix ratchet)
- Alters conformation of Iron (Fe) at un-liganded sites.

# Allosteric effect

**Allosteric effects** occur when the binding properties of a macromolecule change as a consequence of a second ligand binding to the macromolecule and altering its affinity towards the first, or primary, ligand.

# Types of Allosteric effects

I. If the two ligands are the same (*e.g.* oxygen) then this is called a **homotropic allosteric** effect.

II. If the two ligands are different (*e.g.* oxygen and BPG), then this is called a **heterotropic allosteric** effect.

## Allosteric effect

- Macromolecules that have **multiple ligand binding sites** (*e.g.* Hb), allosteric effects can generate cooperative behavior.
- Allosteric effects are important in **the regulation of enzymatic reactions**.
- Both allosteric activators (which enhance activity) and allosteric inhibitors (which reduce activity) are utilized to control enzyme reactions.

# Allosteric effect

Allosteric effects require the presence of two forms of the macromolecule.

1. One form, **T or tense state**, binds the primary ligand (*e.g.* oxygen) with low affinity.
  2. The other form, **R or relaxed state**, binds ligand with high affinity.
- The T and R states are in equilibrium with each other.
  - In the case of positive cooperativity the fraction of T states exceeds that of the R state.

# Transition from T to R

Change from T to R states may occur:

- In unison via the **Monod-Wyman-Changeux** (MWC) model
- Sequentially via the **Koshland** (KNF) model

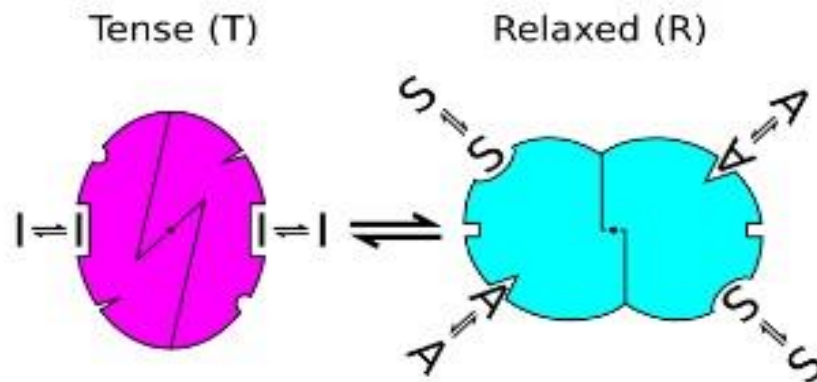


# Monod-Wyman-Changeux (MWC) model

A concerted model for the basis of cooperativity in multimeric binding proteins,

In the absence of a ligand (oxygen in the case of hemoglobin) the subunits exist in a T-form.

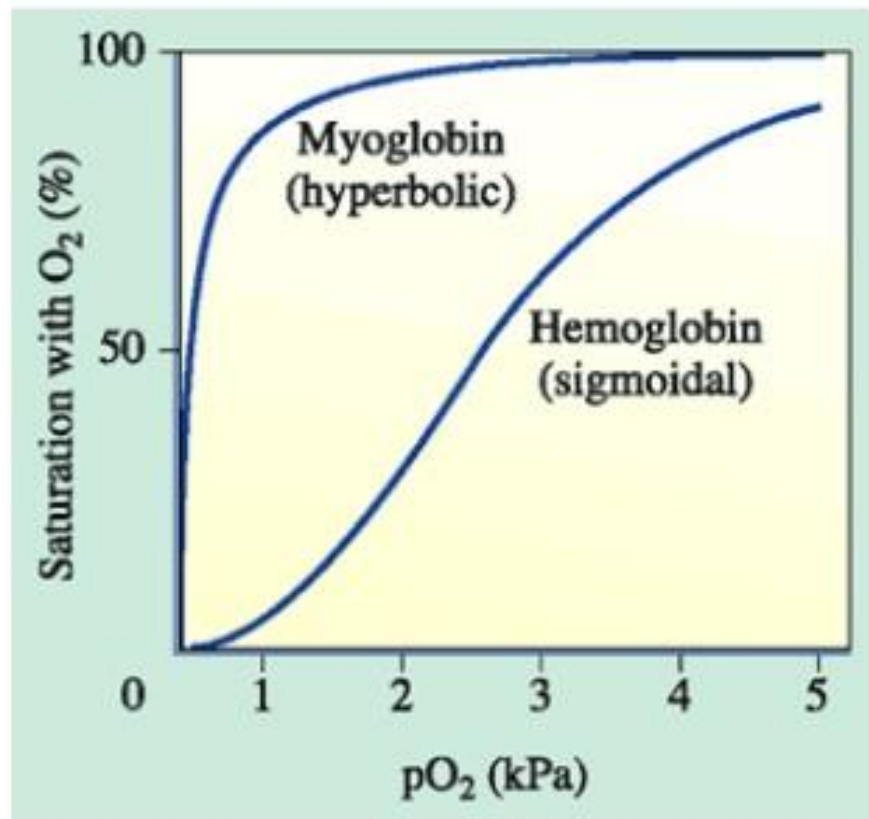
The ligand may bind to as many as two monomers in this conformation, at which point all four monomers convert from T-form to R-form.



## Koshland (KNF) model

- The binding of the ligand causes conformational change.
- Although the subunits go through conformational changes independently (as opposed to in the MWC model).
- The switch of one subunit makes the other subunits more likely to change, by reducing the energy needed for subsequent subunits to undergo the same conformational change.

# Oxygen binding curves



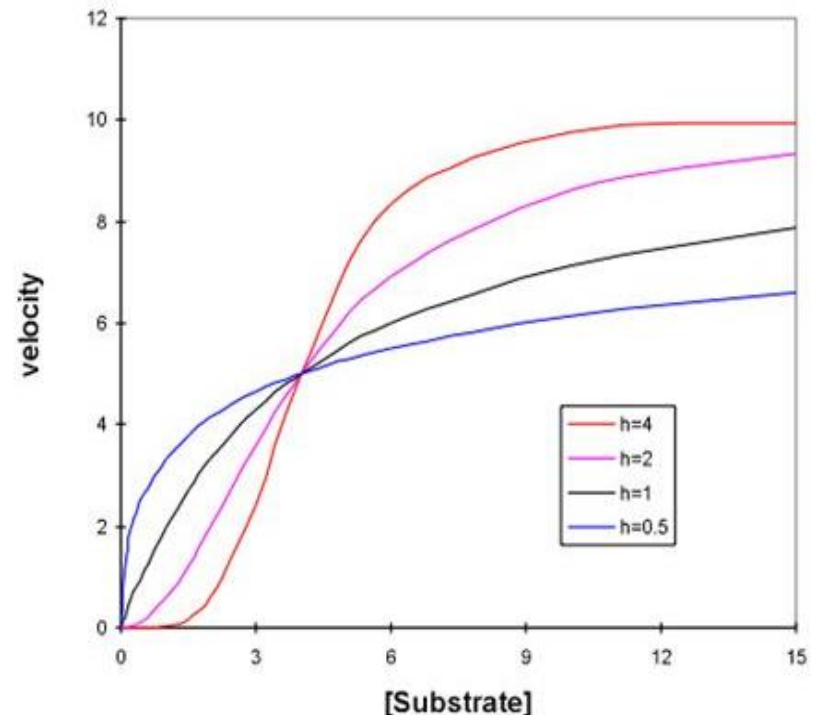
The Oxygen binding curves of Myoglobin and Hemoglobin with respect to the percent saturation of O<sub>2</sub> and pressure.

# Hill Plot

- When the cooperativity is moderate (that is in reality), the experimental data often still well modelled by this equation BUT  $h$  will no longer be equal to the number of binding sites ( $h$  may not be an integer)

## Possibilities:

- $h = 1.0$  no cooperativity (same as the MM equation)
- $n > h > 1.0$  positive cooperativity
- $h = n$  completely cooperative
- $h < 1.0$  negative cooperativity



# Hemoglobin, Cooperativity, and The Hill Equation

E = enzyme, S = ligand, n = small number



**O<sub>2</sub> is considered a ligand**

$$1. \quad K = \frac{[E][S]^n}{[ES_n]} \quad 2. \quad Y_S = \frac{n[ES_n]}{n([E] + [ES_n])}$$

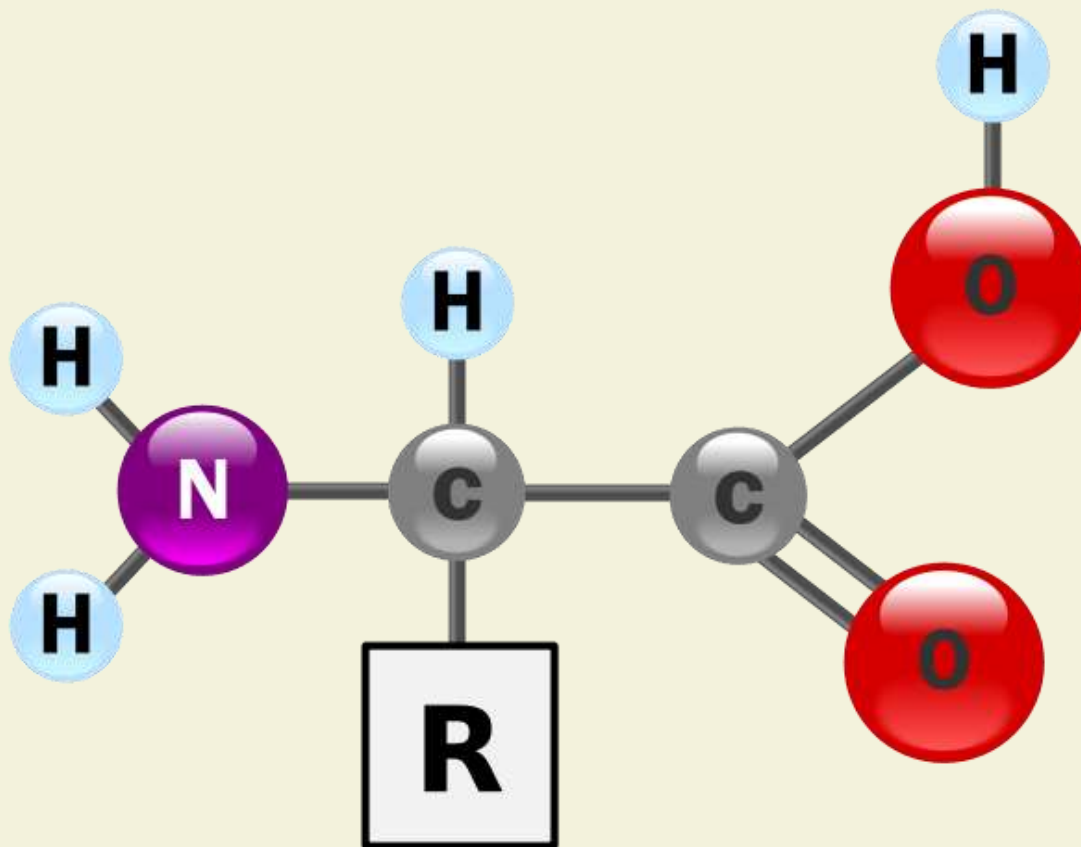
**Fractional Saturation**      **bound/total**

**AMINO ACIDS  
CLASSIFICATION  
AND  
PROPERTIES**

# WHAT ARE AMINO ACIDS.

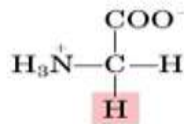
- Amino acids are organic compounds containing
  - amine [- NH<sub>2</sub>]
  - carboxyl [-COOH]
  - side chain [R group]
- The major key elements of amino acids are carbon, hydrogen, nitrogen, oxygen.
- About 500 amino acids are known (though only 20 appear in the genetic code) and can be classified in many ways

# BASIC STRUCTURE[SKELETON]

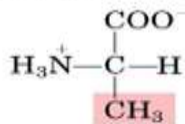




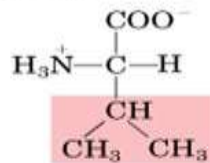
### Nonpolar, aliphatic R groups



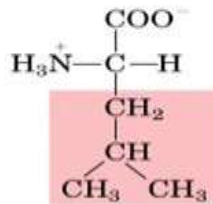
Glycine



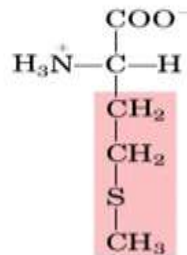
Alanine



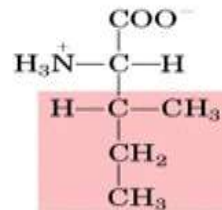
Valine



Leucine

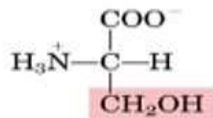


Methionine

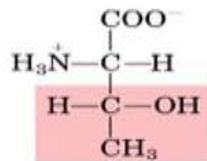


Isoleucine

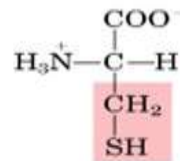
### Polar, uncharged R groups



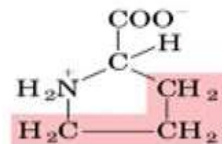
Serine



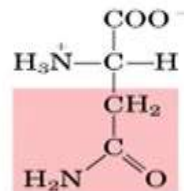
Threonine



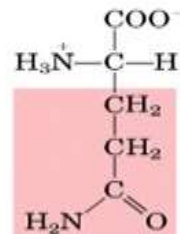
Cysteine



Proline



Asparagine



Glutamine

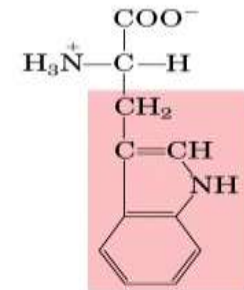
### Aromatic R groups



Phenylalanine

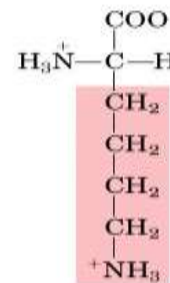


Tyrosine

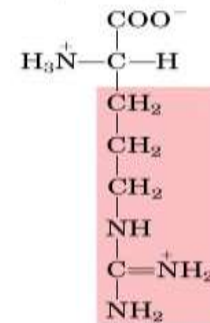


Tryptophan

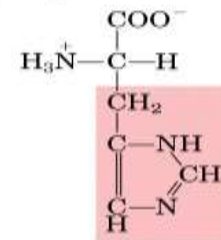
### Positively charged R groups



Lysine

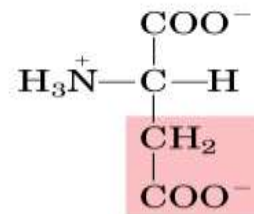


Arginine

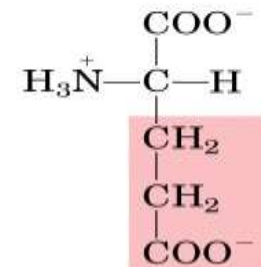


Histidine

### Negatively charged R groups



Aspartate



Glutamate

# NEED FOR CLASSIFICATION

- **Classification of amino acids gives the grouping between 20 acids and a basic outline for grouping.**
- **It makes a clear idea to pick the amino acid type**
- **This is much useful for biochemists for the easy understanding between each amino acids.**

# Classification:

Based on

- R group
- Polarity and R group
- Distribution in protein
- Nutritional requirements
- Number of amino and carboxylic groups

# Based on R-Group

- Simple amino acids:

these have no functional group in their side chain.

Example: glycine, valine, alanine, leucine, isoleucine

- Hydroxy amino acids:

these have a hydroxyl group in their side chain

Eg: serine, threonine

- Sulfur containing amino acids:

have sulfur in their side chain

Eg: cysteine, methionine

- Aromatic amino acids:

have benzene ring in their side chain

Eg: phenylalanine, tyrosine

- Heterocyclic amino acids:

having a side chain ring which possess at least one atom other than carbon

Eg: Tryptophan, histidine, proline

- Amine group containing amino acids:

derivatives of amino acids in which one of carboxyl group has been transformed into an amide group

Eg: Asparagine, glutamine

- Branched chain amino acids:

A **branched-chain amino acid (BCAA)** is an **amino acid** having aliphatic side-**chains** with a **branch**

Eg: leucine, isoleucine, valine

- Acidic amino acids:

have carboxyl group in their side chain

Eg: Aspartic and Glutamic acid

- Basic amino acids:

contain amino group in their side chain

Eg: Lysine, Arginine

- Imino acid:

Amino **acids** containing a secondary amine group

Eg: Proline

# Polarity and R Group

- Amino acids with non polar R group:

these are hydrocarbons in nature,  
hydrophobic, have aliphatic and aromatic groups

[aliphatic R groups]

Eg: Alanine, Valine, Leucine, Isoleucine, Proline.

[Aromatic groups]

Eg: Phenylalanine, Tryptophan,  
Methionine(sulfur)



- Amino acids with polar but uncharged R Group:

these amino acids are polar and possess neutral pH value.

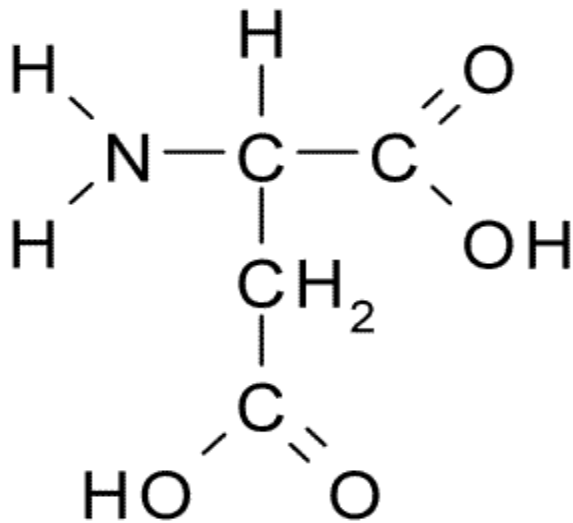
Eg: Glycine, Serine, Threonine, Cysteine, Tyrosine, Glutamine, Asparagine.

- Negatively charged amino acids:

their side chain [R Group] contain extra carboxyl group with a dissociable proton.

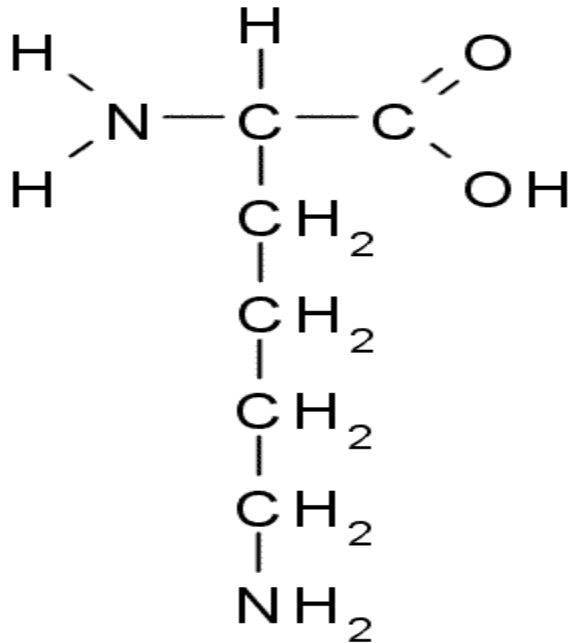
And renders electrochemical behaviour to proteins

Eg: Aspartic acid and Glutamic acid



Aspartic acid

- Positively charged amino acid:  
their side chain have extra amino group  
Rendering **basic** nature to protein,  
Eg: Lysine, Arginine, Histidine.



Lysine

# Distribution in protein:

- Standard protein amino acids:

the amino acids that are used to form proteins,  
recognized by ribozyme autoaminoacylation systems

Eg:

Histidine, isoleucine, leucine, lysine, methionine, phenylalanine, threonine, tryptophan, and valine

- Non standard protein amino acids:

these amino acids are not required to build proteins.

have a vital role as metabolic intermediates.

Eg. Hydroxyproline, Hydroxylysine,  
Carboxyglutamate, Diaminopimelate.

- Non standard non protein amino acid:

These are the derivative of amino acids and have role in metabolism.

Eg: Alpha amino butyrate, Citruline, Ornithine, beta-alanine.

# Based on nutritional requirements:

- Essential amino acids:

**Essential amino acids** cannot be made by the body.

As a result, they must come from food.

The **essential amino acids** are: Arginine, histidine, isoleucine, leucine, lysine, methionine, phenylalanine, threonine, tryptophan, and valine.

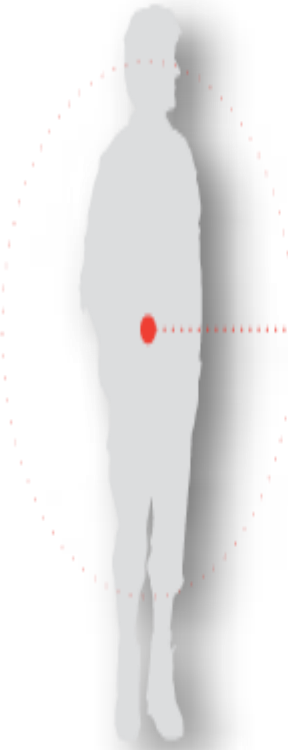
- Non essential amino acids:

An **amino acid** that can be made by humans and so is essential to the human diet.

The **nonessential amino acids**: Alanine, asparagine, aspartic acid, cysteine, glutamic acid, glutamine, glycine, proline, serine, and tyrosine.




## NON ESSENTIAL



Alanine  
Arginine  
Asparagine  
Aspartate  
Cystine  
Glutamic  
Glycine  
Ornithine  
Proline  
Serine  
Tyrosine

## ESSENTIAL

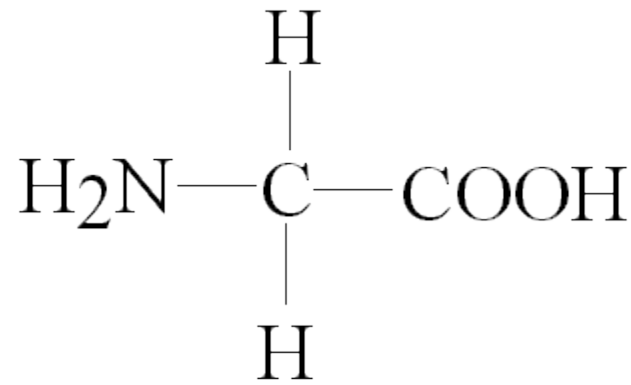


Histidine  
Isoleucine  
Leucine  
Lysine  
Methionine  
Phenylalanine  
Threonine  
Tryptophan  
Valine

On basis of number of amino and carboxylic groups:

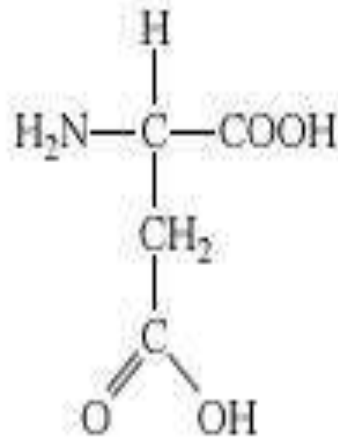
## Monoamino- monocarboxylic amino acids

- glycine, alanine
- proline
- phenylalanine
- methionine
- serine, threonine

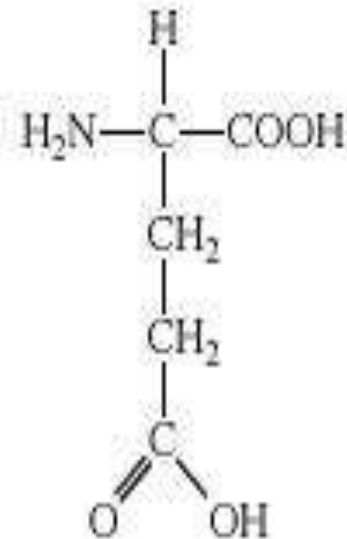


glycine

- Monoamino-dicarboxylic amino acid:  
Aspartic and glutamic acid

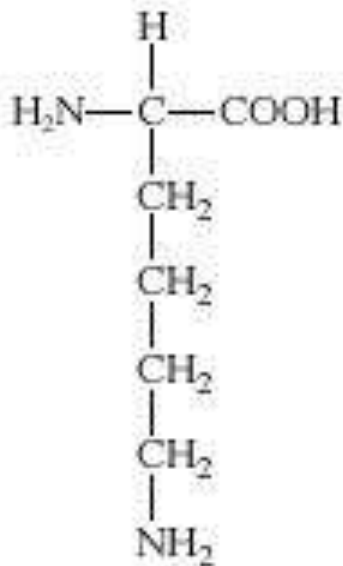


aspartic acid  
(Asp, D, Asx or B)

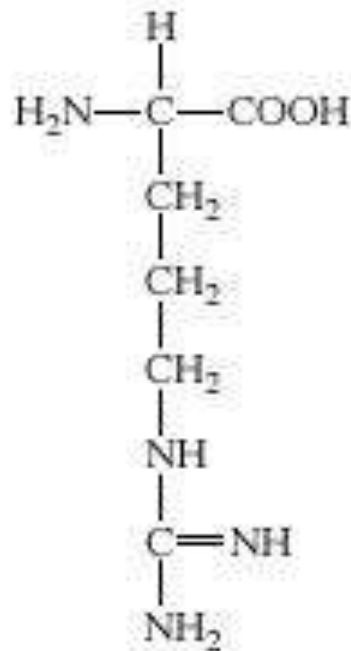


glutamic acid  
(Glu, E, Glx or Z)

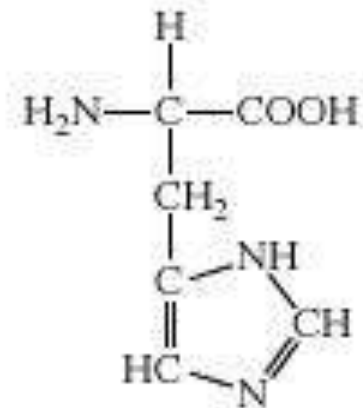
- Diamino-monocarboxylic amino acids:  
Lysine, arginine, histidine.



lysine  
(Lys, K)



arginine  
(Arg, R)



histidine  
(His, H)

# Properties : Physical

- Colourless
- Crystalline in nature
- Tasteless[tyrosine], sweet[glycine, alanine]
- Melting point above 200°C
- Soluble in polar solvent and Insoluble in non polar solvent
- Have absorbance at 280nm

- Mol wt: 100 – 50,000Dt
- All amino acids possess optical isomers due to the presence of asymmetric  $\alpha$ -carbon atoms.
- Some are structurally stable and sterically hindered [Glycine]
- Amino acids [proteins]posses enzymatic activities
- Amino acids exhibit colloidal nature and denaturing property

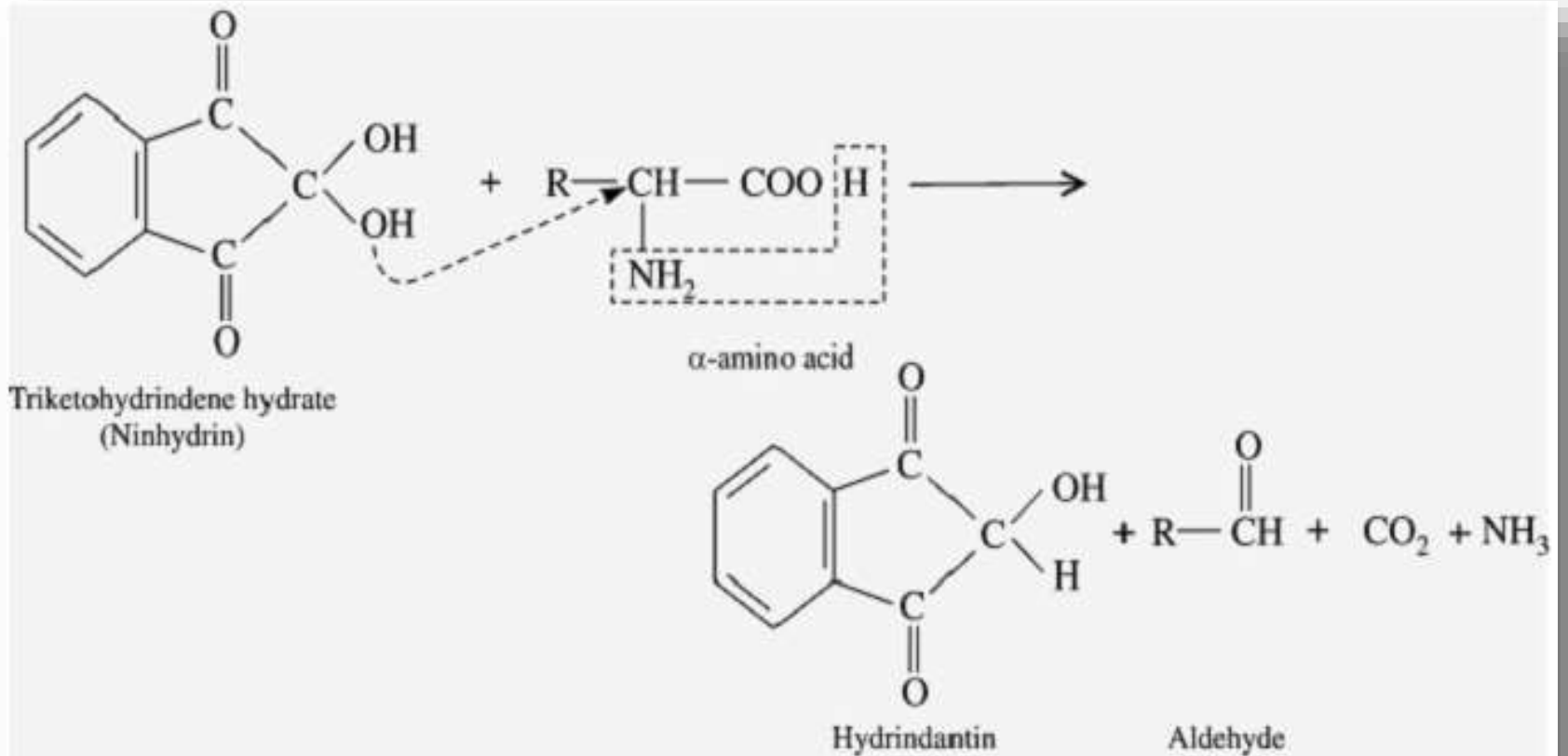
# Chemical properties

- **Decarboxylation:**

The amino acids will undergo decarboxylation to form the corresponding “amines”. Thus amines are produced

- **Histidine** → Histamine + CO<sub>2</sub>
- **Tyrosine** → Tyramine + CO<sub>2</sub>
- **Lysine** → Cadaverine + CO<sub>2</sub>

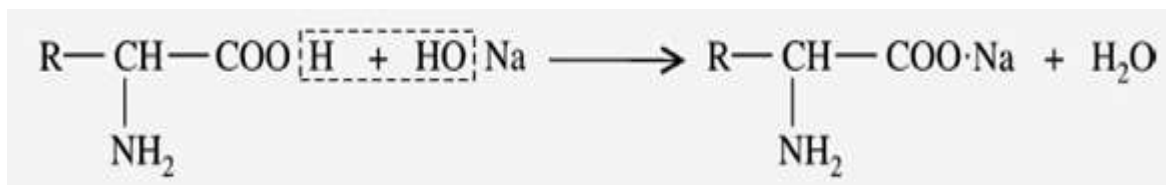
- Reaction with Ninhydrin:





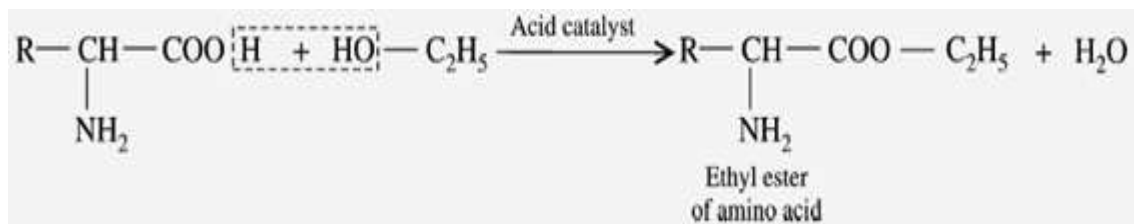
- **Reaction with Alkalies (Salt formation):**

- The carboxyl group of amino acids can release a  $H^+$  ion with the formation of Carboxylate ( $COO^-$ ) ions.



- **Reaction with Alcohols (Esterification) :**

- the amino acids is reacted with alcohol to form, “Ester”. The esters are volatile in contrast to the form amino acids.



- **Reaction with DANSYL Chloride:**

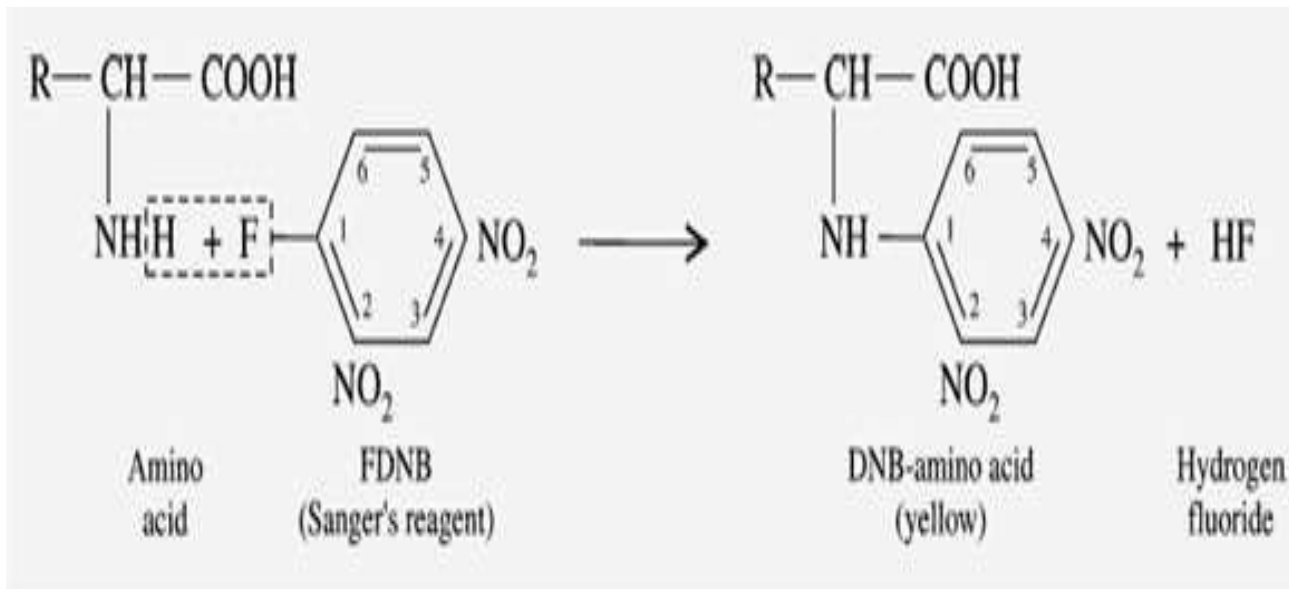
DANSYL chloride means “Dimethyl Amino Naptha Sulphonyl Chloride”.

When the amino acid reacts with DANSYL chloride reagent, it gives a “Flourescent DANSYL derivative

- **Reaction with acylating agents (Acylation):**

When the amino acids react with “Acid chloride” and acid anhydride in alkaline medium it gives “pthaloyl amino acid

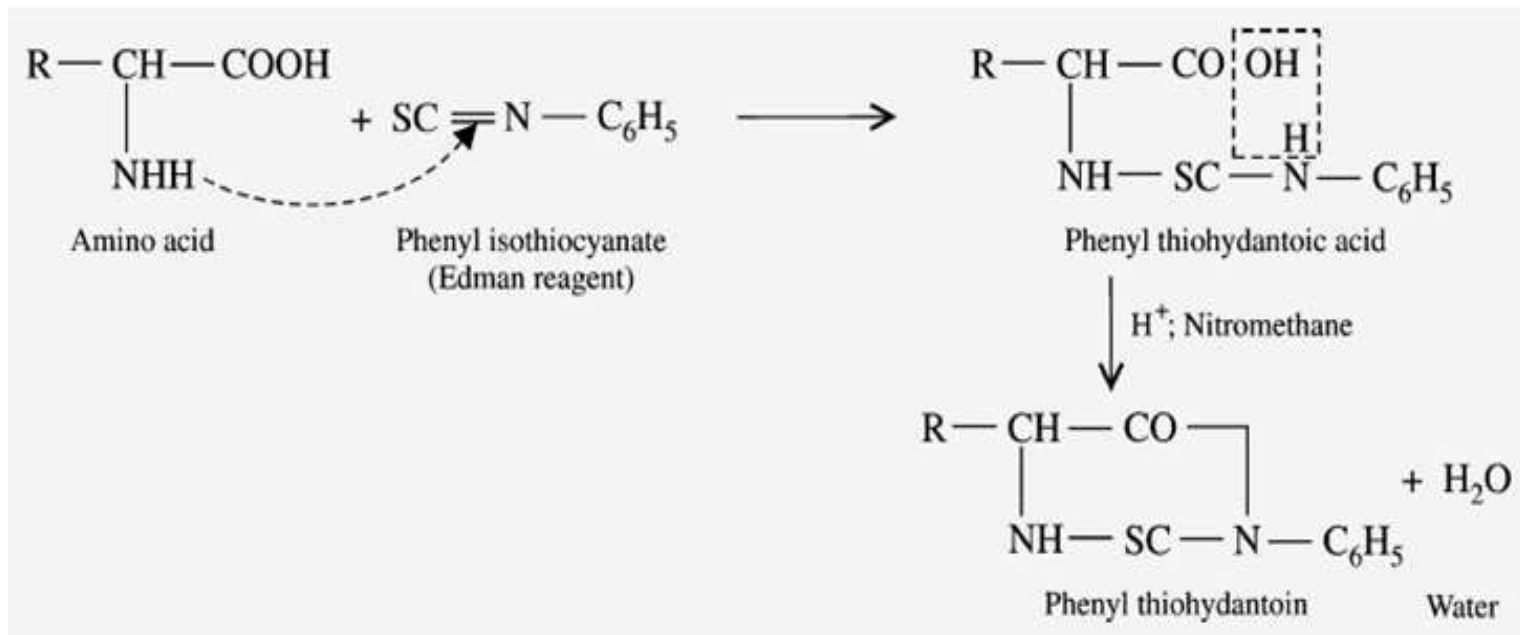
- Reaction with Sanger's reagent:
- "1-flouro-2,4-dinitrobenzene" is called Sanger's reagent (FDNB).sanger's reagent reacts with  $\alpha$ -amino acid to produce Yellow coloured derivative, DNB-amino acid.



- Reaction with Edmann's reagent:

Edmann's reagent is “**phenylisothiocyanate**”. When amino acids react with Edmann's reagent

it gives “***phenyl thiohydantoic acid***” finally it turns into cyclized form “***Phenyl thiohydantoin***” (Edmann's derivative).



- Reference :

- Dr. J.L. Jain – Fundamentals of Biochemistry by Chand publications, New Delhi.

# Fatty acid oxidation- Notes

See how fatty acids are broken down and used to generate ATP.

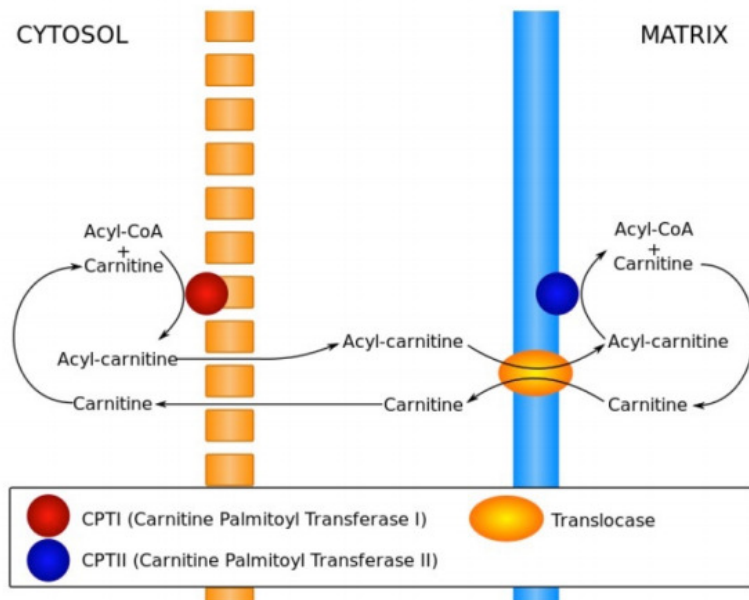
Fatty acids provide highly efficient energy storage, delivering more energy per gram than carbohydrates like glucose. In tissues with high energy requirement, such as heart, up to 50–70% of energy, in the form of ATP production, comes from fatty acid (FA) beta-oxidation.

During fatty acid  $\beta$ -oxidation long chain acyl-CoA molecules – the main components of FAs – are broken to acetyl-CoA molecules.

## **Fatty acid transport into mitochondria**

Fatty acids are activated for degradation by conjugation with coenzyme A (CoA) in the cytosol. The long-chain fatty-acyl-CoA is then modified by carnitine palmitoyltransferase 1 (CPT1) to acylcarnitine and transported across the inner mitochondrial membrane by carnitine translocase (CAT). CPT2 then converts the long chain acylcarnitine back to long-chain acyl-CoA before beta-oxidation.

Breakdown of fats yields fatty acids and glycerol. Glycerol can be readily converted to DHAP for oxidation in glycolysis or synthesis into glucose in gluconeogenesis. Fatty acids are broken down in two carbon units of acetyl-CoA. To be oxidized, they must be transported through the cytoplasm attached to coenzyme A and moved into mitochondria. The latter step requires removal of the CoA and attachment of the fatty acid to a molecule of carnitine. The carnitine complex is transported across the inner membrane of the mitochondrion after which the fatty acid is reattached to coenzyme A in the mitochondrial matrix.



*Figure- Movement of Acyl-CoAs into the Mitochondrial Matrix*

The process of fatty acid oxidation, called beta oxidation, is fairly simple. The reactions all occur between carbons 2 and 3 (with #1 being the one linked to the CoA) and sequentially include the following:

1. dehydrogenation to create FADH<sub>2</sub> and a fatty acyl group with a double bond in the trans configuration;
2. hydration across the double bond to put a hydroxyl group on carbon 3 in the L configuration;
3. oxidation of the hydroxyl group to make a ketone; and
4. thiolitic cleavage to release acetyl-CoA and a fatty acid two carbons shorter than the starting one.

Unsaturated fatty acids complicate the picture a bit (see below), primarily because they have cis bonds, for the most part, if they are of biological origin and these must be converted to the relevant trans intermediate made in step 1. Sometimes the bond must be moved down the chain, as well, in order to be positioned properly. Two enzymes (described below) handle all the necessary isomerizations and moves necessary to oxidize all of the unsaturated fatty acids.

## Enzymes of Beta Oxidation

The reactions of fatty acid oxidation are notable in mirroring the oxidations in the latter half of the citric acid cycle – dehydrogenation of succinate to make a transdouble bond (fumarate), hydration across the double bond to make L-malate and oxidation of the hydroxyl to make a ketone (oxaloacetate). Two of the enzymes of beta-oxidation are notable. The first is acyl-CoA dehydrogenase, which catalyzes the initial dehydrogenation and yields FADH<sub>2</sub>. It comes in three different forms – ones that work on long, medium, or short chain length fatty acids. The first of these is sequestered in the peroxisome of animals whereas the others are found in the mitochondria. Plants and yeast perform beta oxidation exclusively in the peroxisome. The most interesting of the acyl-CoA dehydrogenases is the one that works on medium length fatty acids. This one, which is the one most commonly deficient in animals, has been linked to sudden infant death syndrome.

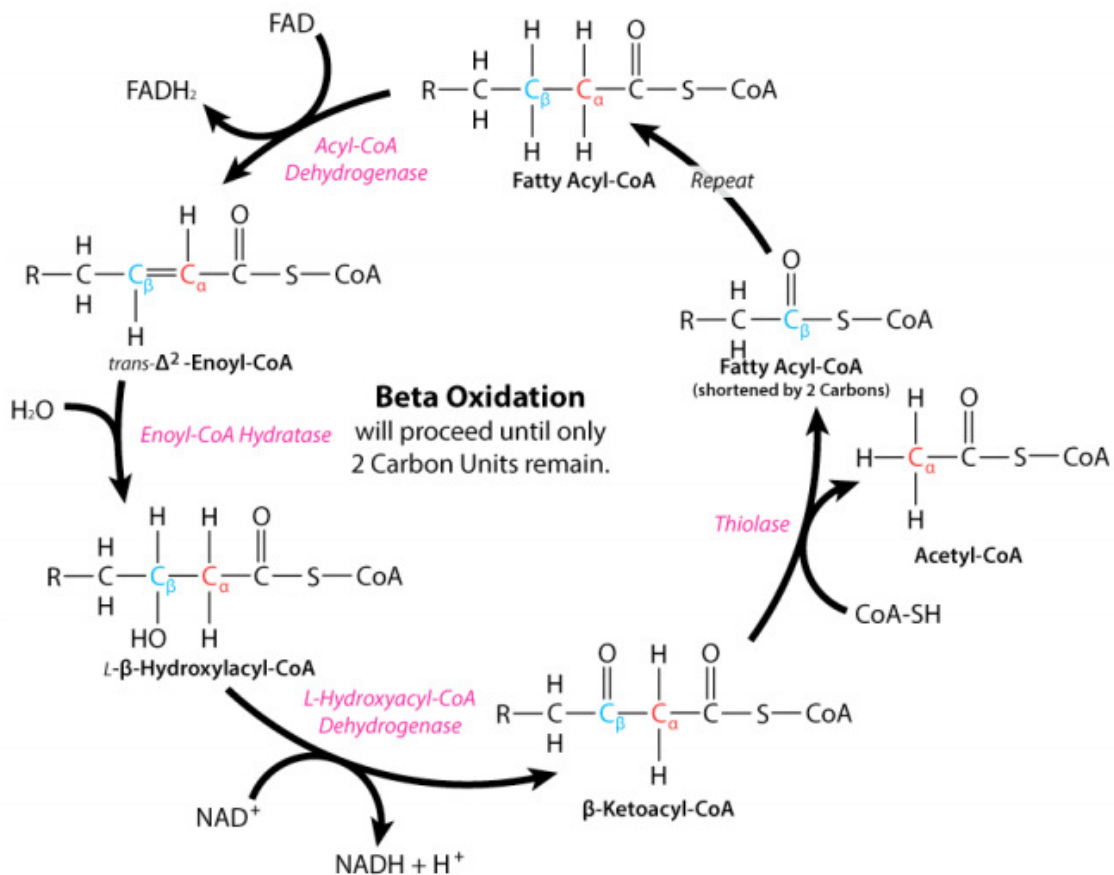


Figure- Beta Oxidation of Fatty Acids



Reactions two and three in beta oxidation are catalyzed by enoyl-CoA hydratase and 3-hydroxyacyl-CoA dehydrogenase, respectively. The latter reaction yields an NADH. The final enzyme of beta oxidation is thiolase and this enzyme is notable in not only catalyzing the formation of acetyl-CoAs in beta oxidation, but also catalyzing the joining of two acetyl-CoAs (essentially the reversal of the last step of beta oxidation) to form acetoacetyl-CoA—essential for the pathways of ketone body synthesis and cholesterol biosynthesis.

### Oxidation of Odd-Chain Fatty Acids

Though most fatty acids of biological origin have even numbers of carbons, not all of them do. Oxidation of fatty acids with odd numbers of carbons ultimately produces an intermediate with three carbons called propionyl-CoA, which cannot be oxidized further in the beta-oxidation pathway. Metabolism of this intermediate is odd. Sequentially, the following steps occur:

1. carboxylation to make D-methylmalonyl-CoA;
2. isomerization to L-methylmalonyl-CoA;
3. rearrangement to form succinyl-CoA. The last step of the process utilizes the enzyme methylmalonyl-CoA mutase, which uses the B12 coenzyme in its catalytic cycle. Succinyl-CoA can then be metabolized in the citric acid cycle.

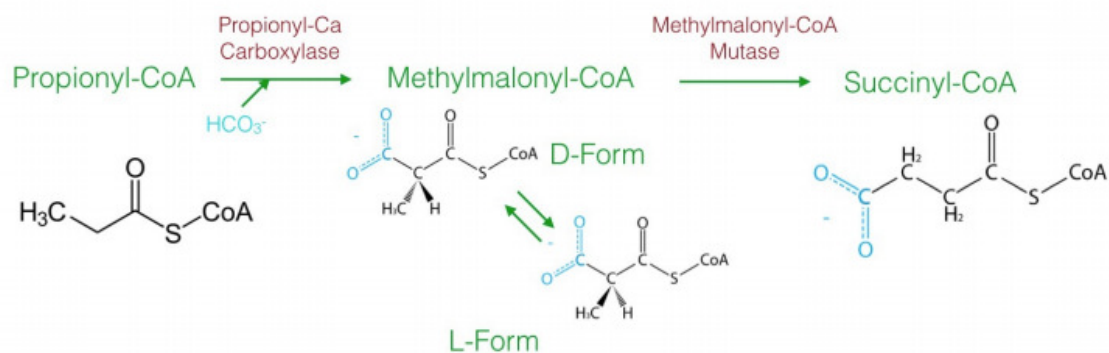
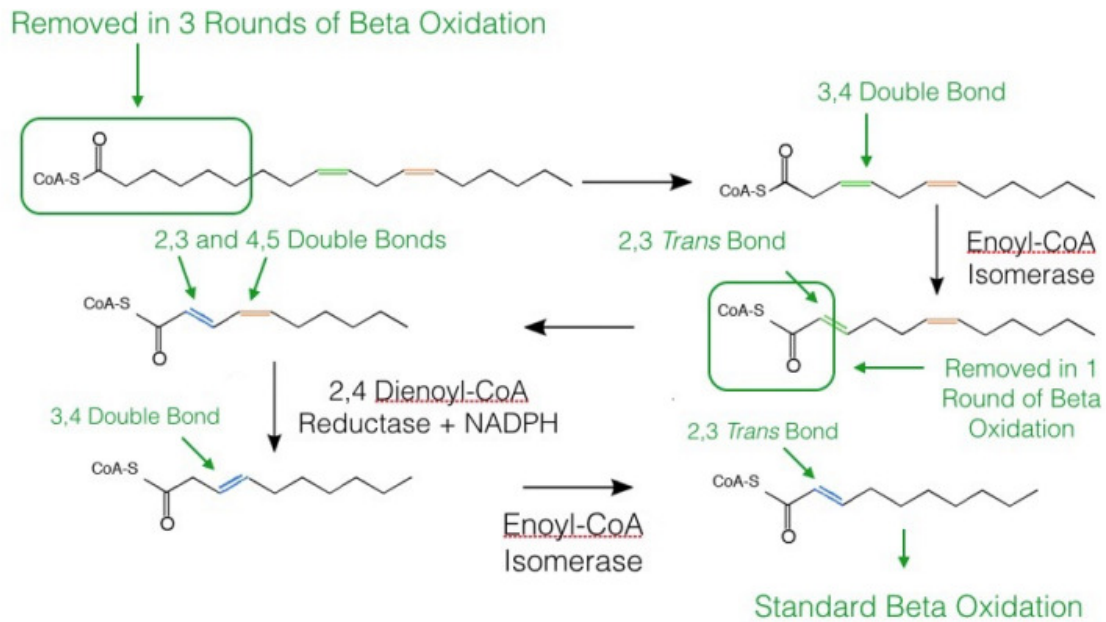


Figure- Odd-Chain Fatty Acid Oxidation

### Unsaturated Fatty Acid Oxidation

As noted above, oxidation of unsaturated fatty acids requires two additional enzymes to the complement of enzymes for beta oxidation. If the beta oxidation of the fatty acid produces an intermediate with a cis bond between carbons three and four, cis- $\Delta^3$ -Enoyl-CoA Isomerase will convert the bond to a trans bond between carbons two and three and beta oxidation can proceed as normal.



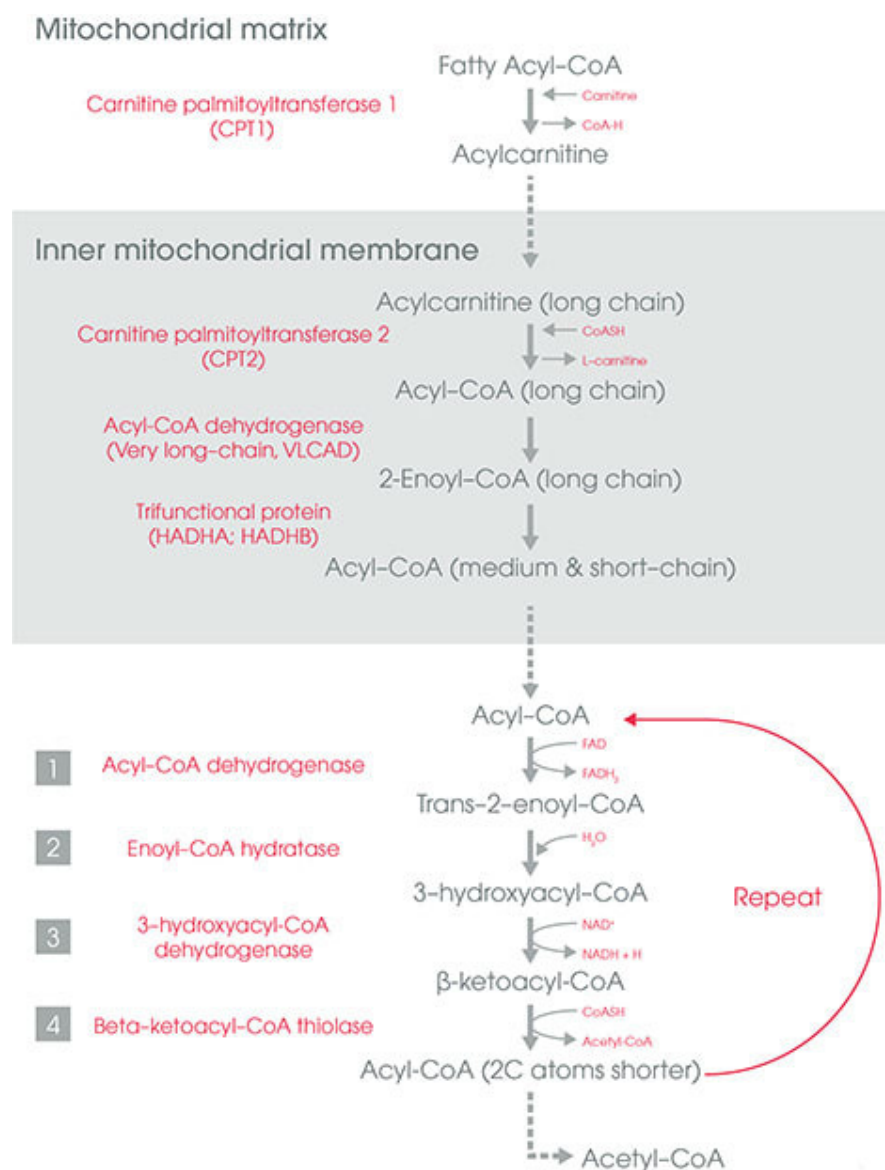
*Figure-Unsaturated Fatty Acid Oxidation*

On the other hand, if beta oxidation produces an intermediate with a cis double bond between carbons four and five, the first step of beta oxidation (dehydrogenation between carbons two and three) occurs to produce an intermediate with a trans double bond between carbons two and three and a cis double bond between carbons four and five. The enzyme 2,4 dienoyl CoA reductase reduces this intermediate (using NADPH) to one with a single cis bond between carbons three and four. This intermediate is then identical to the one acted on by cis- $\Delta^3$ -Enoyl-CoA Isomerase above, which converts it into a regular beta oxidation intermediate, as noted above.

### Alpha Oxidation

Yet another consideration for oxidation of fatty acids is alpha oxidation. This pathway is necessary for catabolism of fatty acids that have branches in their chains. For example, breakdown of chlorophyll's phytol group yields phytanic acid, which undergoes hydroxylation and oxidation on carbon number two (in contrast to carbon three of beta oxidation), followed by decarboxylation and production of a branched intermediate that can be further oxidized by the beta oxidation pathway. Though alpha oxidation is a relatively minor metabolic pathway, the inability to perform the reactions of the pathway leads to Refsum's disease where accumulation of phytanic acid leads to neurological damage.

## Overview



### ***ATP synthesis***

*Acetyl-CoA generated by the beta-oxidation pathway enters the mitochondrial TCA cycle, where is further oxidized to generate NADH and FADH<sub>2</sub>. The NADH and FADH<sub>2</sub> produced by both beta oxidation and the TCA cycle are used by the mitochondrial electron transport chain to produce ATP. Complete oxidation of one palmitate molecule (fatty acid containing 16 carbons) generates 129 ATP molecules.*

# **Buffers, Types of Buffer Solutions, Solutions of Single Substance, Solutions of Mixtures, Importance.**

Dr. Soma Maji

- There is often a need of having a solution whose pH does not change appreciably with a change in conditions.
- A study of such solutions is essential to understand their behavior.
- This will help in utilizing such buffer solutions to resist change in pH for maintaining product stability.

# DEFINITION

- Solutions with stable hydrogen ion concentration and therefore usually with no change in pH which is almost independent of dilution and changing very little with small additions of a strong acid or alkali are called buffers.
- In simple terms it can also be defined as a solution which resists any change of pH when a small amount of a strong acid or a strong base is added to it, is called a buffer solution or simply as a buffer.
- Such as, ammonium acetate, have a tendency to resist any change in its hydronium ion concentration or pH, whenever a small amount of a strong acid or a strong base is added to it.
- Buffer solutions usually consist of a mixture of a weak acid and its salt with a strong base e.g.,  $\text{CH}_3\text{COOH}$  and  $\text{CH}_3\text{COONa}$ , or that of a weak base and its salt with a strong acid e.g.,  $\text{NH}_4\text{OH}$  and  $\text{NH}_4\text{Cl}$ .
- The solution of any salt of a weak acid and a weak base e.g., ammonium acetate, also shows buffering property.

# TYPES OF BUFFERS

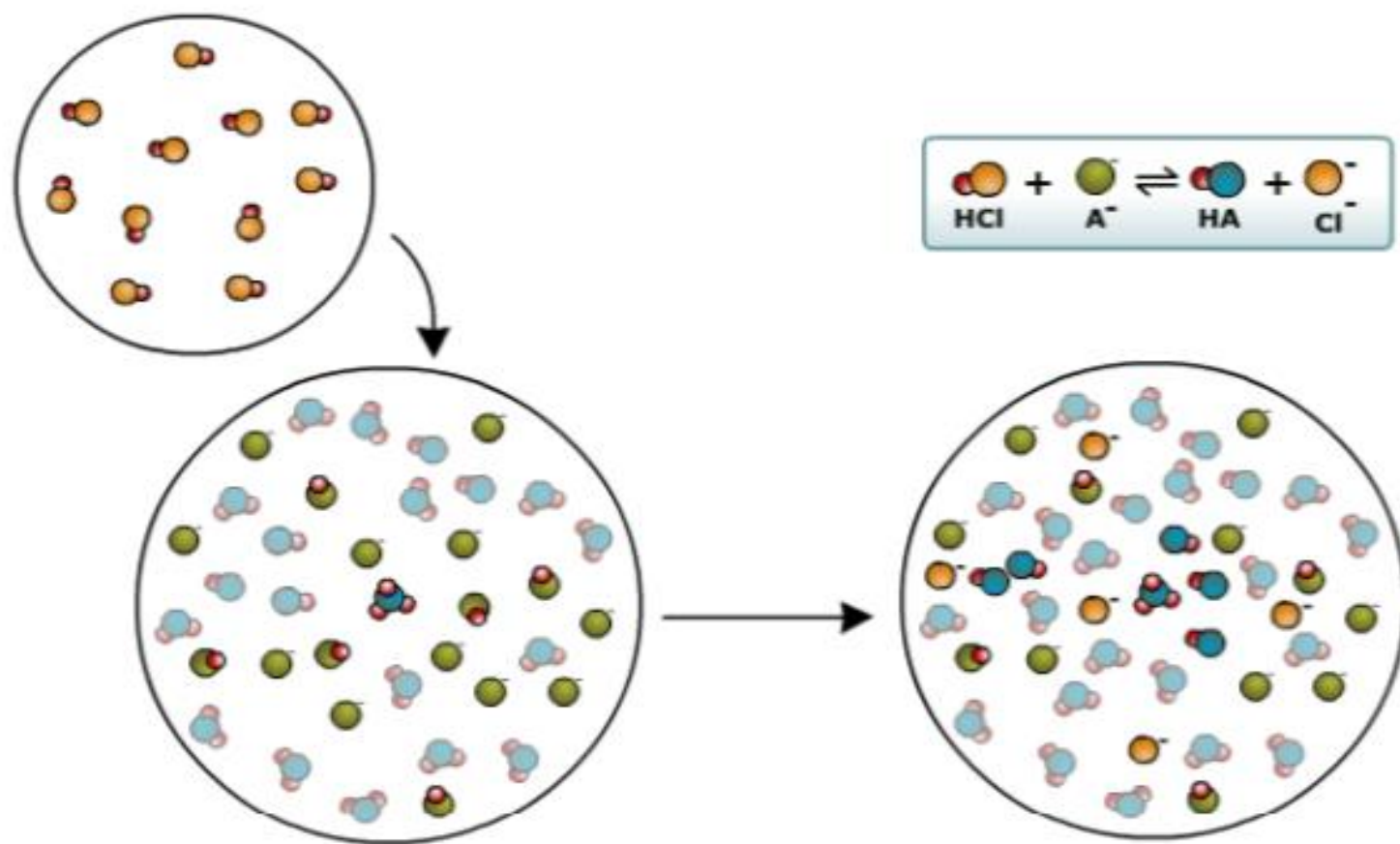
- There are two types of buffers, acid buffer and basic buffer.
- **Acid buffer:** A buffer solution containing large amounts of a weak acid, and its salt with a strong base, is termed as an acid buffer. Such buffer solutions have pH on the acidic side i.e., pH is less than 7 at 298 K. The pH of an acid buffer is given by the equation.  $\text{CH}_3\text{COOH}$  and  $\text{CH}_3\text{COONa}$

$$\text{pH} = \text{pK}_a + \ln \frac{[\text{salt}]}{[\text{acid}]}$$

Where  $K_a$  is the acid dissociation constant of the weak acid



Addition of a strong acid to the buffer solution



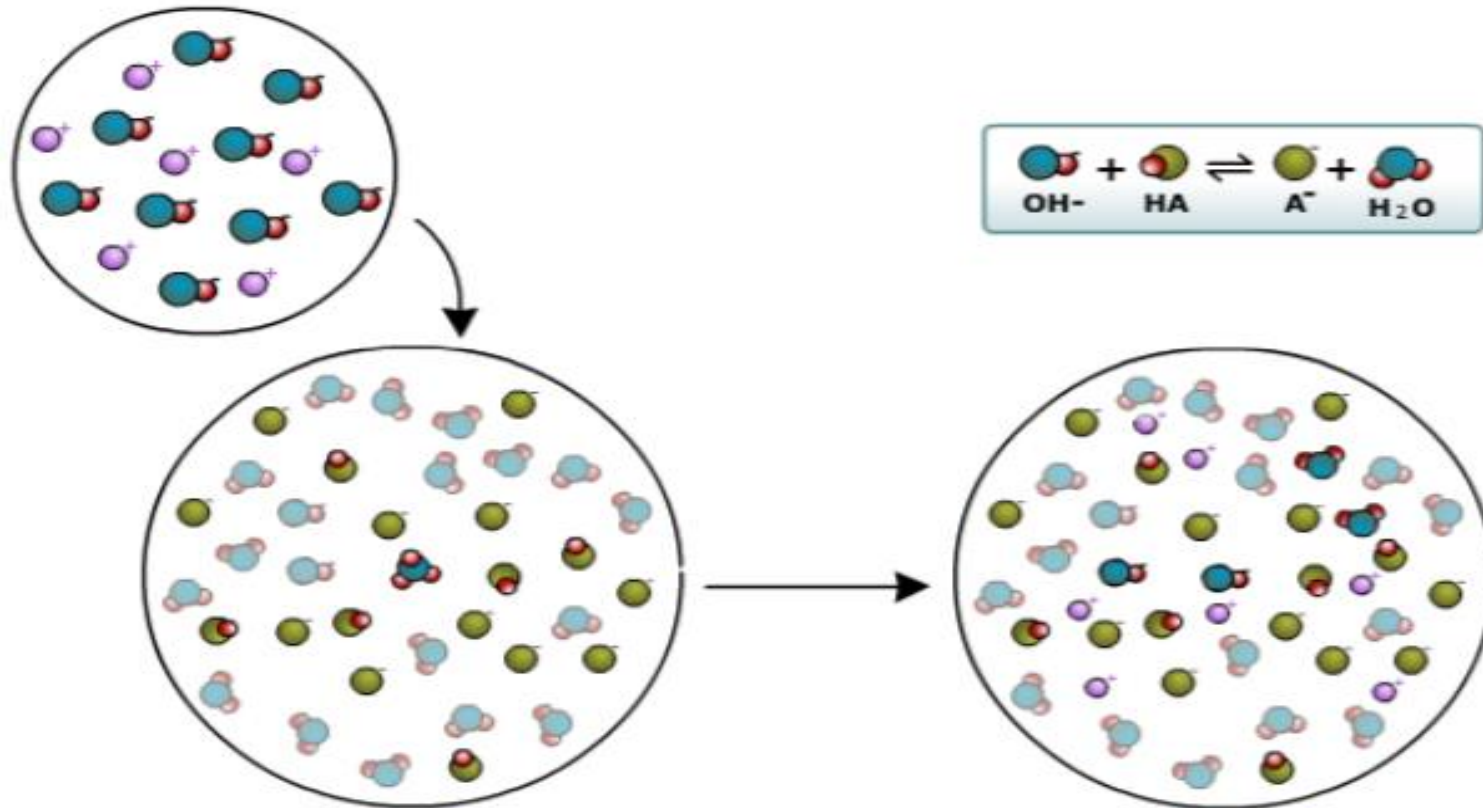
Acid Buffer

- **Basic Buffer:** A buffer solution containing relatively large amounts of a weak base and its salt with a strong acid is termed as a basic buffer. Such buffers have pH on the alkaline side i.e., pH is higher than 7 at 298 K. e.g.:  $\text{NH}_4\text{OH}$  and  $\text{NH}_4\text{Cl}$
- The pH of a basic buffer is given by the equation

$$\text{pOH} = \text{pK}_b + \ln \frac{[\text{salt}]}{[\text{acid}]}$$

Where  $K_b$  is the base dissociation constant of the weak base.

**Addition of a strong base to the buffer solution**



**Base Buffer**

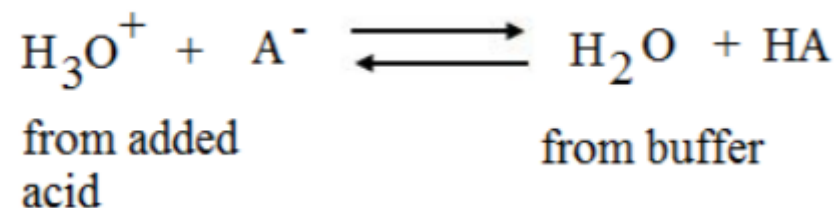
# BUFFER-CAPACITY AND BUFFER-RANGE

- The effectiveness of any buffer is described in terms of its **buffer capacity**.
- It is defined as, 'the number of equivalents of a strong acid (or a strong base) required to change the pH of one litre of a buffer solution by one unit, keeping the total amount of the acid and the salt in the buffer constant.'
- The buffer capacity of a buffer is maximum when acid to salt or base to salt ratio is equal to 1 i.e., it contains equal number of moles of acid (or base) and the salt.
- All buffer solutions remain effective over a small pH range: this pH-range is characteristic of the buffer and is termed as the **buffer-range**.

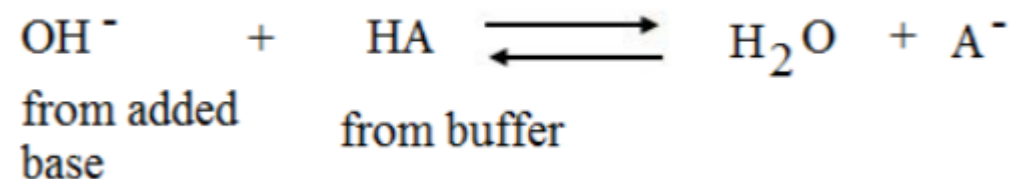
# MECHANISMS

## Action of an acid buffer:

- An acid buffer contains relatively large amounts of a weak acid (HA) and its salt with a strong base (say NaA).
- The buffer solution thus contains large concentration of HA and A<sup>-</sup> (due to the dissociation of the salt), apart from H<sub>3</sub>O<sup>+</sup> and OH<sup>-</sup>.
- An addition of small amount of a strong acid causes the reaction, to proceed in such a direction that an equivalent amount of A<sup>-</sup> combines with H<sub>3</sub>O<sup>+</sup> to give the same amount of undissociated weak acid, HA.
- Thus, the added acid is picked up by the anions (from the salt) present in large concentrations in the buffer. As long as the added strong acid is in smaller amounts, the changes in the concentrations of salt and that of the weak acid, (HA) are small.
- Therefore, the acid to salt ratio does not change appreciably by the addition of strong acid to the buffer solution. As a result, no noticeable change is seen in the pH value of the buffer.

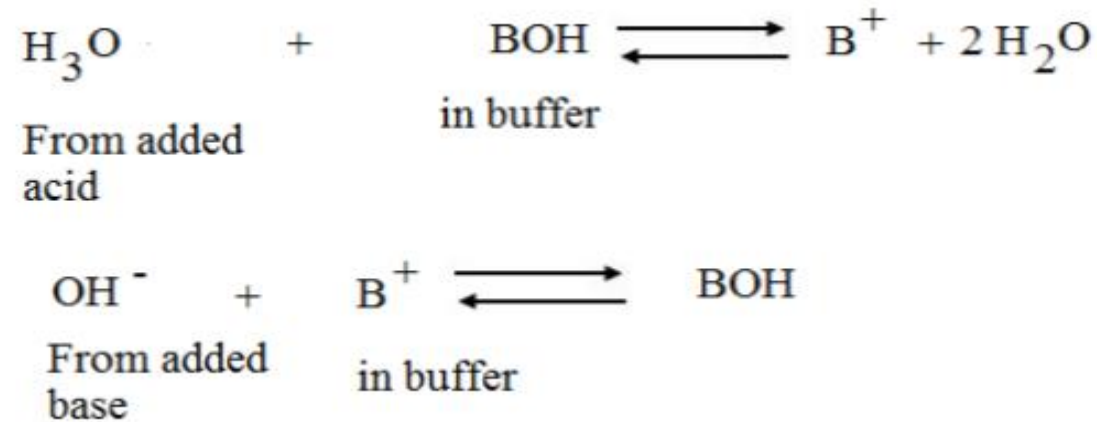


- Similarly addition of a strong base to an acid buffer on the other hand causes the reaction to proceed in the forward direction, resulting in the formation of an equivalent amount of the salt at the cost of the buffer acid.
- As long as the added base is in small amounts, the ratio of weak acid to salt remains virtually unchanged. As a result, no observable change in the pH value is seen.



# Action of basic buffer

- A basic buffer contains a weak base (BOH), and its salt with strong acid (BX). The buffer solution thus contains large amounts of the weak base BOH, and the cation B<sup>+</sup> (coming from the dissociation of the salt BX), in addition to H<sub>3</sub>O<sup>+</sup> and OH<sup>-</sup>. The addition of an acid or a base to the basic buffer causes the following reactions:



The reactions proceed in the forward direction. It is clear that the addition of an acid or a base to any buffer solution does cause a change in the concentrations of the buffer acid (or base) and the salt. But, because of the relatively much larger concentrations of these in the buffer solution, for all practical purposes, the ratio, [Salt] / [Acid] or [Salt] / [Base] remains constant. Hence, the pH does not change.

# IMPORTANCE OF BUFFERS

- Many chemical reactions are affected by the acidity of the solution in which they occur. In order for a particular reaction to occur or to occur at an appropriate rate, the pH of the reaction medium must be controlled.
- Such control is provided by buffer solutions, which are solutions that maintain a particular pH. Biochemical reactions are especially sensitive to pH.
- Most biological molecules contain groups of atoms that may be charged or neutral depending on pH, and whether these groups are charged or neutral has a significant effect on the biological activity of the molecule.
- In all multi cellular organisms, the fluid within the cell and the fluids surrounding the cells have a characteristic and nearly constant pH.
- This pH is maintained in a number of ways, and one of the most important is through buffer systems.



Lecture note- 4  
Organic Chemistry CHE 502

# **CARBOHYDRATES**

Co-Coordinator – Dr. Shalini Singh

DEPARTMENT OF CHEMISTRY  
UTTARAKHAND OPEN UNIVERSITY

---

# UNIT- 7 CARBOHYDRATES-I

---

## **CONTENTS**

- 7.1. Objectives
- 7.2. Introduction
- 7.3. Classification and Nomenclature
- 7.4. Monosaccharides
- 7.5. Mechanism of osazone formation
- 7.6. Interconversion of glucose and fructose
- 7.7. Chain lengthening and chain shortening of glucose
- 7.8 Summary
- 7.9. Model examination questions

---

## ***7.1 OBJECTIVES***

---

After going through this unit you will be able to:

- Define carbohydrates,
- Differentiate and classify the three major groups of carbohydrates,
- Define anomers, mutarotation, configuration and mechanism of osazone formation,
- Describe ether and ester formation,
- Differentiate between reducing and non reducing sugars,
- Define interconversion of glucose and fructose,
- Describe the chain lengthening and chain shortening of aldose
- Discuss about Erythro and threo distereomers conversion of glucose
- Determination of ring size of monosaccharides,

---

## ***7.2 INTRODUCTION***

---

Carbohydrates are a class of naturally occurring organic compounds of carbon, hydrogen and oxygen which are primarily produced by plants. They are extremely widespread in plants comprising upto 80% of dry weight. These are ultimate source of our food. In higher animals the simple sugar glucose is an essential constituent of blood and occurs in a polymeric form as glycogen in the liver and muscle.

In the green plants, carbohydrates are produced by a process called photosynthesis. This process involves the conversion of simple compounds  $\text{CO}_2$  and  $\text{H}_2\text{O}$  into glucose ( $\text{C}_6\text{H}_{12}\text{O}_6$ ) and is catalysed by green colouring pigment chlorophyll present in the leaves of plants. The energy required for this conversion is supplied by sun in the form of sunlight.

Carbohydrates are very useful for human beings. They provide us all the three basic necessities of life i.e., food (starch containing grain), clothes (cellulose in the form of cotton, linen and rayon) and shelter (cellulose in the form of wood used for making our houses and furniture etc.). Carbohydrates are also important to the economy of many nations. For example, sugar is one of the most important commercial commodities.

The term carbohydrates arose because the general formula for most of them could be written as  $\text{C}_x (\text{H}_2\text{O})_y$  and thus they may be regarded as hydrates of carbon. However, this definition was not found to be correct e.g., rhamnose, a carbohydrate, is having the formula  $\text{C}_6\text{H}_{12}\text{O}_5$  while acetic acid having formula  $\text{C}_2\text{H}_4\text{O}_2$  is not a carbohydrate. Simple carbohydrates are also known as sugars or saccharides (Latin: Saccharum; Greek : Sakcharon, Sugar) and the ending of the names of most sugars is -ose. Examples: glucose, fructose, sucrose, maltose, arabinose, etc.

Chemically, carbohydrates contain mainly two functional groups, carbonyl group (aldehyde or ketone) and a number of hydroxyl groups. Accordingly carbohydrates are now defined optically active polyhydroxy aldehydes or polyhydroxy ketones or the compound that can be hydrolysed to either of them.

---

## 7.3 CLASSIFICATION AND NOMENCLATURE

---

### 7.3.1 Classification

Carbohydrates, in general, may be classified into two classes:

- (i) **Sugars.** These are crystalline substances which are sweet and water soluble. For examples, glucose, fructose and cane sugar.
- (ii) **Non-sugars.** These are tasteless, insoluble in water and amorphous. For example. Starch, cellulose, etc.

However, these days Carbohydrates are systematically classified into three major group:

- (a) **Monosaccharides.** The simplest carbohydrates that cannot be hydrolysed into simpler carbohydrates, are called monosaccharides. depending upon whether they contain an aldehyde or keto groups, they may be called aldoses or ketoses. For example, a five carbon monosaccharide having aldehyde group is called aldopentose and six carbon monosaccharide containing a keto group is called keto-hexose. A few examples of monosaccharides are given below:

Aldotetroses. Erythrose and Threose;  $\text{CH}_2\text{OH}(\text{CHOH})_2 \text{CHO}$ .

Ketotetroses. Erythrulose,  $\text{CH}_2\text{OHCOCHOHCH}_2\text{OH}$ .

Aldopentoses. Ribose, arabinose, Xylose and Lyxose.  $\text{CH}_2\text{OH}(\text{CHOH})_3 \text{CHO}$ .

All have a common molecular formula but different structures.

Ketopentoses. Ribulose and Xylulose;  $\text{CH}_2\text{OHCO}(\text{CHOH})_2 \text{CH}_2\text{OH}$ .

Aldohexoses. Glucose, mannose, galactose;  $\text{CH}_2\text{OH}(\text{CHOH})_4 \text{CHO}$ .

Ketohexoses. Fructose, Sorbose etc.  $\text{CH}_2\text{OHCO}(\text{CHOH})_3 \text{CH}_2\text{OH}$ .

- (b) **Oligosaccharides.** These are the carbohydrates which can be hydrolysed into a definite number of monosaccharide molecules. Depending upon the number of monosaccharides that are obtained from them on hydrolysis, they may be called di-, tri- or tetra-saccharides: For example:

Disaccharides: sucrose, lactose, maltose. All these have the same molecular formula  $C_{12}H_{22}O_{11}$ .

Trisaccharides: raffinose ( $C_{18}H_{32}O_{16}$ ).

Tetrasaccharides: stachyose ( $C_{24}H_{42}O_{21}$ ).

(c) **Polysaccharides.** Carbohydrates that yield a large number of molecules (more than ten molecules) of monosaccharides on hydrolysis are called polysaccharides. The common examples are starch, cellulose, glycogen, etc.

### 7.3.2 Nomenclature

Carbohydrates contain hydroxy and aldehydic or ketonic groups. They are named according to IUPAC system of nomenclature

Compound	Common name	IUPAC name
$CH_2OHCHOHCHO$	Glyceraldehyde	2, 3-dihydroxy propanol
$CH_2OHCOCH_2OH$	Dihydroxyacetone	1,3-dihydroxy propanone
$CH_2OH(CHOH)_4CHO$	Glucose	2,3,4,5,6-pentahydroxyhexanal
$CH_2OH(CHOH)_3COCH_2OH$	Fructose	1,3,4,5,6-pentahydroxyhexan-2-one

---

## 7.4 MONOSACCHARIDES

---

The monosaccharides are again classified on the basis of two factors:

(1) By the carbonyl function. Those containing the aldehydic function, -CHO, are called aldoses. Others containing the keto group, -CO-, are called ketoses.

(2) By the number of Carbonyl atoms in the molecule. These monosaccharides containing 3,4,5,6 etc., carbon atoms are designated as trioses, tetroses, pentoses, hexoses, and so on.

Monosaccharides are polyhydric aldehydes and ketones which cannot be hydrolysed into simpler carbohydrates.

### 7.4.1 Structures of monosaccharides

The common monosaccharides are given in table.

Table. Monosaccharides

No of carbon atoms	Class	Molecular formula aldoses	Structural formula	Examples
3	aldotrioses	$C_3H_6O_3$	$CH_2OHCHOHCHO$	Glyceraldehyde
4	aldotetroses	$C_4H_8O_4$	$CH_2OH(CHOH)_2CHO$	Erythrose, Threose
5	Aldopentose	$C_5H_{10}O_5$	$CH_2OH(CHOH)_3CHO$	Arabinose, Ribose, Xylose, Lyxose
6	aldohexoses	$C_6H_{12}O_6$	$CH_2OH(CHOH)_4CHO$	Glucose, galactose, mannose, allose, talose, gulose, iodose, etc.
3	ketotrioses	$C_3H_6O_3$	$CH_2OHCOCH_2OH$	dihydroxyacetone
4	ketotetroses	$C_4H_8O_4$	$CH_2OHCOCHOHCH_2OH$	erythrulose
5	ketopentoses	$C_5H_{10}O_5$	$CH_2OHCO(CHOH)_2CH_2OH$	Ribulose, Xylulose
6	ketohehexoses	$C_6H_{12}O_6$	$CH_2OHCO(CHOH)_3CH_2OH$	Fructose, Sorbose, Tagatose, Psicose

### 7.4.2 Glucose

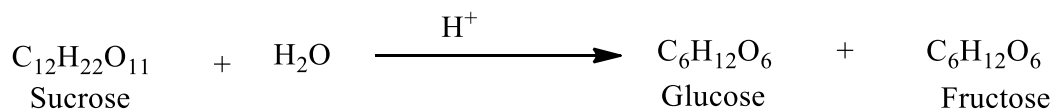
Glucose is most common monosaccharide. It is known as Dextrose because it occurs in nature principally as optically dextrorotatory isomer. Glucose is found in most sweet fruits, especially grapes (20-30%), and honey. It is an essential constituent of human blood. The blood normally contains 65 to 110 mg (0.06 to 0.1%) of glucose per 100 ml. In diabetic persons the

level may be much higher. In combined form glucose occurs in abundance in cane sugar and polysaccharides such as starch and cellulose.

## Preparation of Glucose

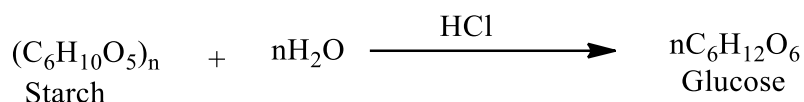
### 1. From sucrose (Cane sugar)

When sucrose is boiled with dilute HCl or H<sub>2</sub>SO<sub>4</sub> in alcoholic solution, glucose and fructose are obtained in equal amounts.



### 2. From Starch

Glucose is produced commercially by the hydrolysis of starch by boiling it with dilute H<sub>2</sub>SO<sub>4</sub> at high temperature under pressure.



In this process, an aqueous solution of starch obtained from corn is acidified with dilute H<sub>2</sub>SO<sub>4</sub>. It is then heated with high pressure steam in an autoclave. When the hydrolysis is complete, the liquid is neutralized with sodium carbonate to pH of 4-5. The resulting solution is concentrated under reduced pressure to get the crystals of glucose.

## Physical properties of glucose

Some important physical properties of glucose are mentioned as under:

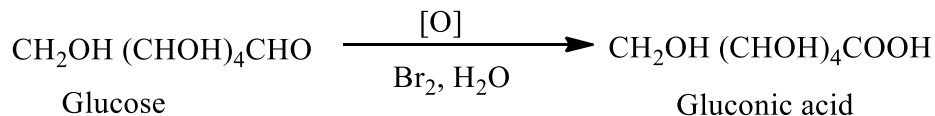
1. It is colourless sweet crystalline compound having m.p. 419 K.
2. It is readily soluble in water, sparingly soluble in alcohol and insoluble in ether.
3. It forms a monohydrate having m.p. 391 K.
4. It is optically active and its solution is dextrorotatory. The specific rotation of fresh solution is + 112° C.
5. It is about three fourth as sweet as sugarcane i.e., sucrose.

## Chemical properties of glucose

Chemical properties of glucose can be studied under the following headings:

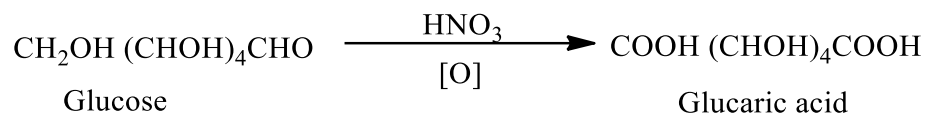
**(A) Reactions of aldehydic group**

1. **Oxidation.** (a) Glucose gets oxidized to gluconic acid with mild oxidizing agents like bromine water



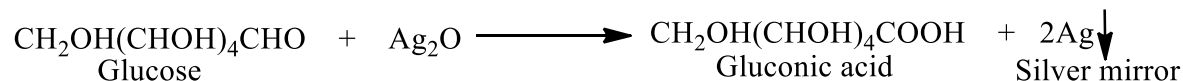
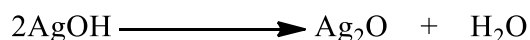
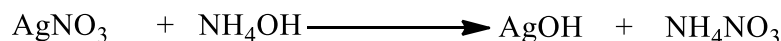
Only-CHO group is affected.

- (b) A strong oxidizing agent like nitric acid oxidizes both the terminal groups viz.  $-\text{CH}_2\text{OH}$  and  $-\text{CHO}$  groups and saccharic acid or glucaric acid is obtained.

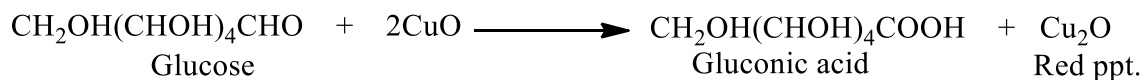
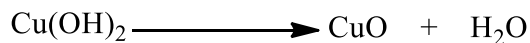
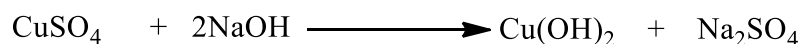


- (d)** Glucose gets oxidized to gluconic acid with ammonical silver nitrate (Tollen's reagent) and alkaline copper sulphate (Fehling solution). Tollen's reagent is reduced to metallic silver (silver mirror) and Fehling solution to cuprous oxide which is a red precipitate.

- (i) With Tollen's reagent

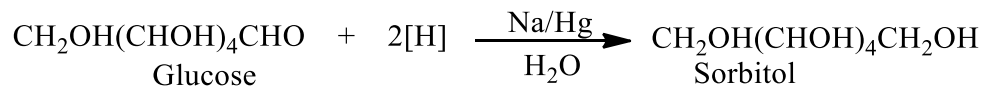


- (ii) With Fehling solution

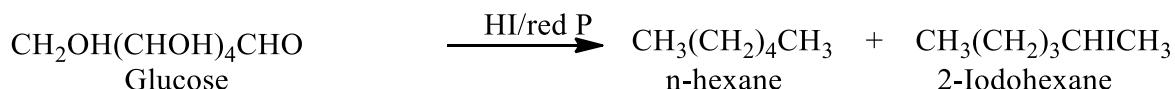




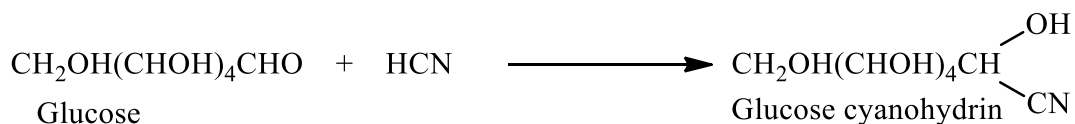
2. **Reduction** (a) glucose is reduced to sorbitol or Glucitol on treatment with sodium amalgam and water.



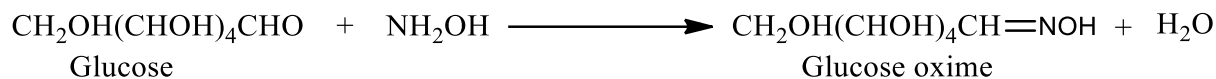
- (b) On reduction with conc. HI and red P at 373 K glucose gives a mixture of n-hexane and 2-iodohexane



3. **Reaction with HCN.** Like aldehydes, glucose reacts with HCN forming cyanohydrins.

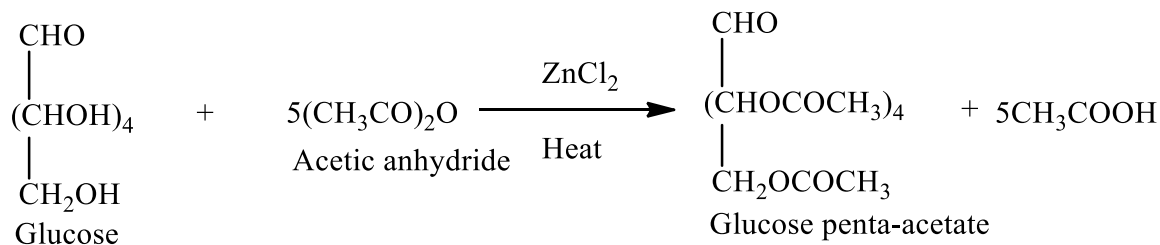


4. **Reaction with hydroxylamine.** Glucose forms glucose oxime.

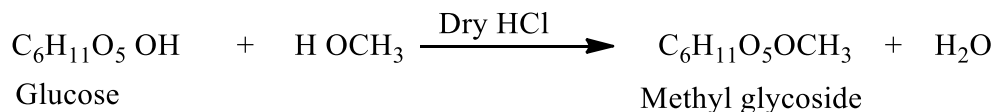


### (B) Reactions of hydroxyl groups

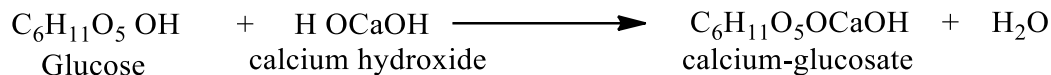
1. **Reaction with acetic anhydride or acetyl chloride.** Glucose forms penta acetate with acetic anhydride or acetyl chloride.



2. **Reaction with methyl alcohol.** Glucose reacts with methyl alcohol in the presence of dry HCl gas to form methyl glucoside.

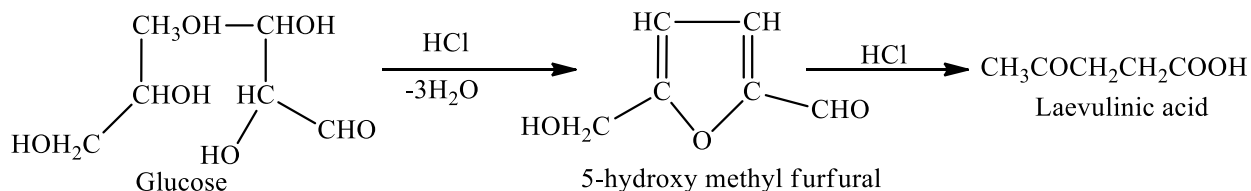


3. **Reaction with metallic hydroxides.** Glucose reacts with calcium hydroxide to form calcium glucosate which is water soluble.

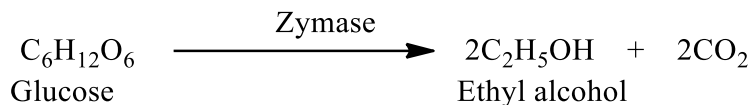


**(C) Miscellaneous reactions**

1. Action of acids. On warming with conc.HCl, glucose forms 5-hydroxy methyl furfural, which on further reaction gives laevulinic acid.

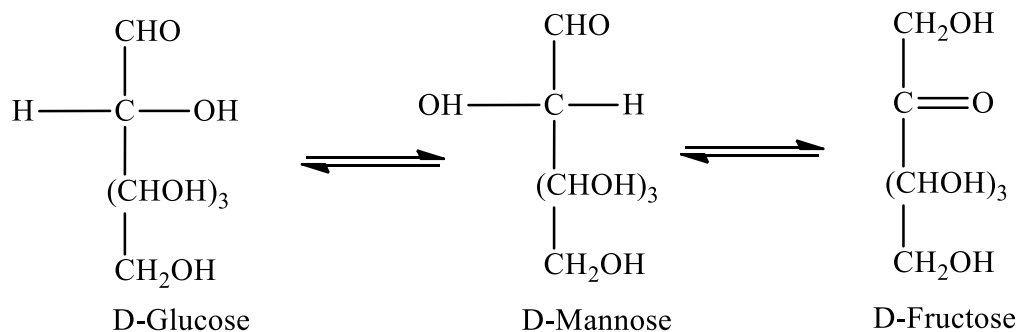


2. Fermentation. Glucose undergoes fermentation into ethyl alcohol in the presence of the enzyme zymase.

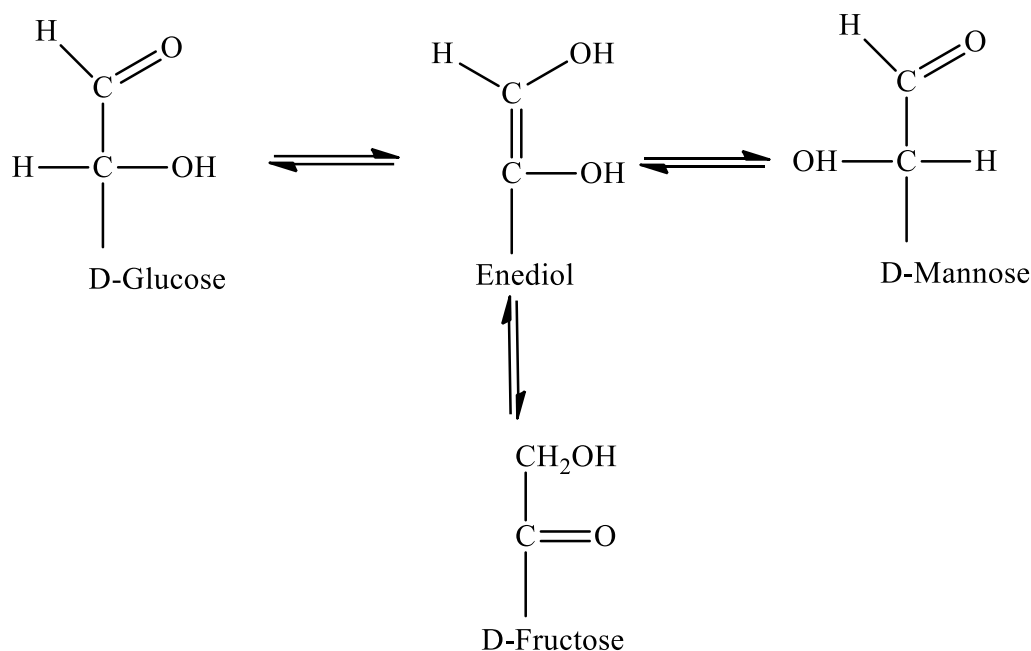


This reaction called alcoholic fermentation is the basis of manufacture of wines and alcohol.

3. Reaction with Alkalies. When warmed with strong sodium hydroxide solution, glucose forms a brown resinous product. In dilute alkali solution, D-glucose rearranges to give a mixture of D- glucose, D-mannose and d-fructose.



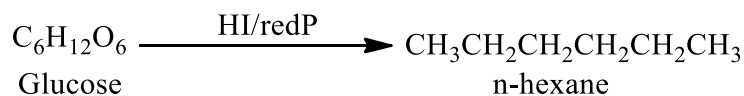
The above equilibrium is established via the enediol starting from any of these three hexoses.



That is why D-Fructose, although it has a ketonic C=O group, reduces Fehling's solution or Tollen's reagent. The rearrangement reaction of a monosaccharides in weakly alkaline solutions to give a mixture of isomeric sugars, is named as Lobry de Bruyn Van Ekestein rearrangement.

### Structure of glucose

1. On the basis of elemental analysis and molecular weight determination the molecular formula of glucose is  $\text{C}_6\text{H}_{12}\text{O}_6$ .
2. The reduction of glucose with red phosphorus and HI gives n-hexane.



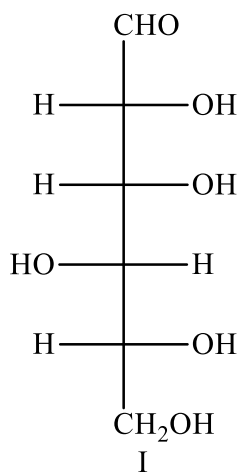
Therefore, the six carbon atoms of glucose form a straight chain.

3. It forms penta acetate on treatment with acetic anhydride which indicates the presence of five hydroxyl groups in the molecule.
4. Glucose reacts with hydroxyl amine to form an oxime and with hydrogen cyanide to form cyanohydrins. It indicates the presence of a carbonyl group. It also forms phenylhydrazone on treatment with phenylhydrazine.

- The mild oxidation of glucose with bromine water or sodium hypobromide yields a monocarboxylic acid (gluconic acid) containing same number of carbon atoms as in glucose, i.e., six. This indicates that the carbonyl group must be aldehyde group.
- The catalytic reduction of glucose gives a hexahydric alcohol (sorbitol) which gives hexaacetate on treatment with acetic anhydride. The sixth hydroxyl group must be obtained by the reduction of aldehyde group, thus further confirming the presence of an aldehyde group and five hydroxyl groups in glucose.
- Oxidation of gluconic acid with nitric acid yields a dicarboxylic acid (glucaric acid) with the same number of carbon atoms as in glucose. Thus besides aldehyde group, glucose must contain a primary alcoholic group also, which generates the second carboxylic group on oxidation.
- Glucose is a stable compound and does not undergo dehydration easily, indicating that not more than one hydroxyl group is bonded to a single carbon atom. Thus all the hydroxyl groups are attached to different carbon atoms.

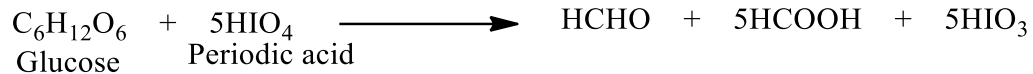
### Open –chain structure of glucose

On the basis of above reactions, Fisher assigned an open chain structure of glucose shown below as structure I



D-(+)-Glucose

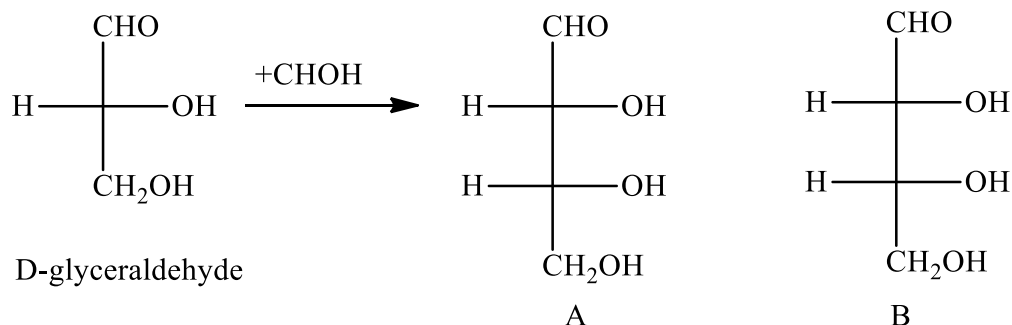
The above structure of glucose is also confirmed by the cleavage reaction of glucose with periodic acid. Five moles of periodic acid are consumed by one mole of glucose giving five moles of formic acid and one mole of formaldehyde.



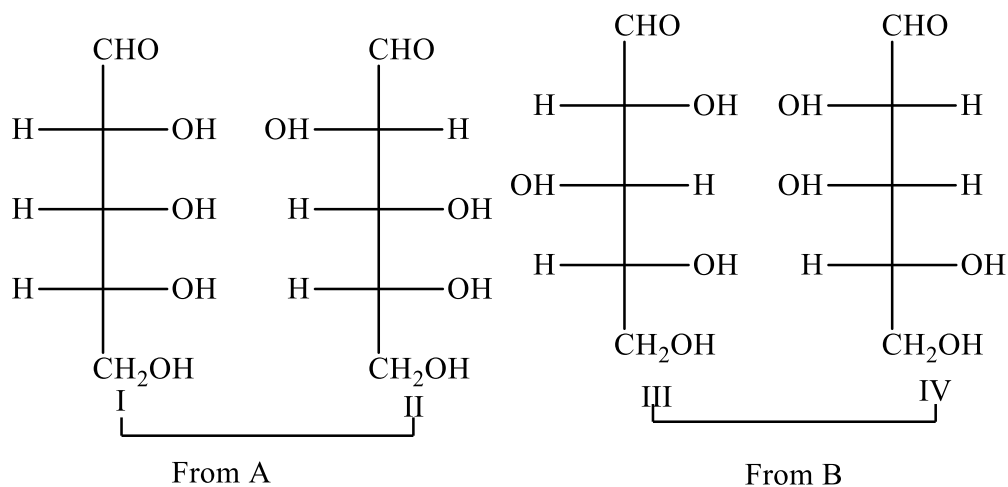
### Configuration of D-Glucose

The configuration of D-glucose was proved by Emil Fisher by arguments similar to the ones stated below.

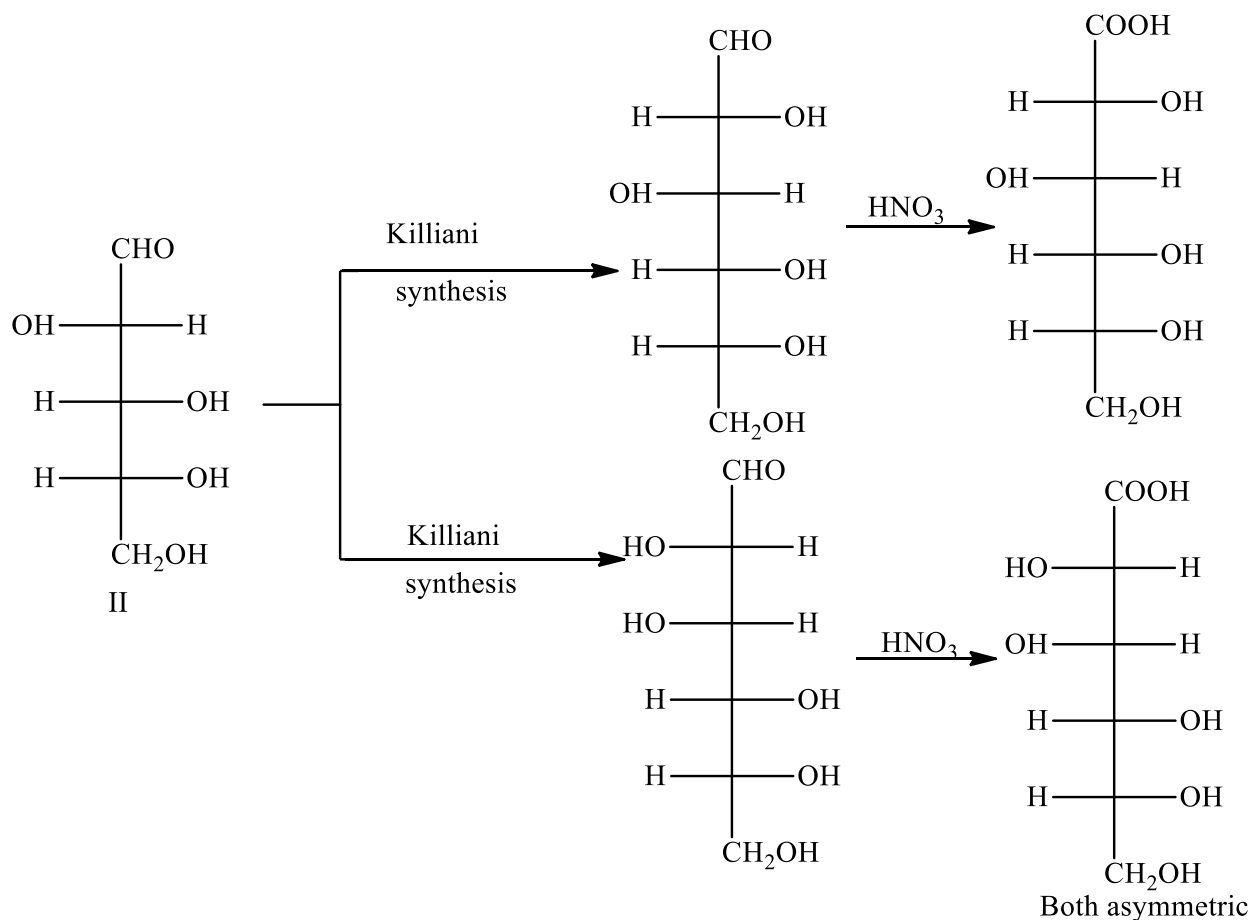
1. Construction of four possible D-pentoses. Taking the configuration of D-glyceraldehyde as the standard, two possible D-aldotetroses (A and B) may be constructed by adding a CHOH just below CHO, placing OH to the right and then to the left.



Similarly, each of the two D-tetroses (A and B) gives two D-aldopentoses. Thus four possible D-aldopentoses are:



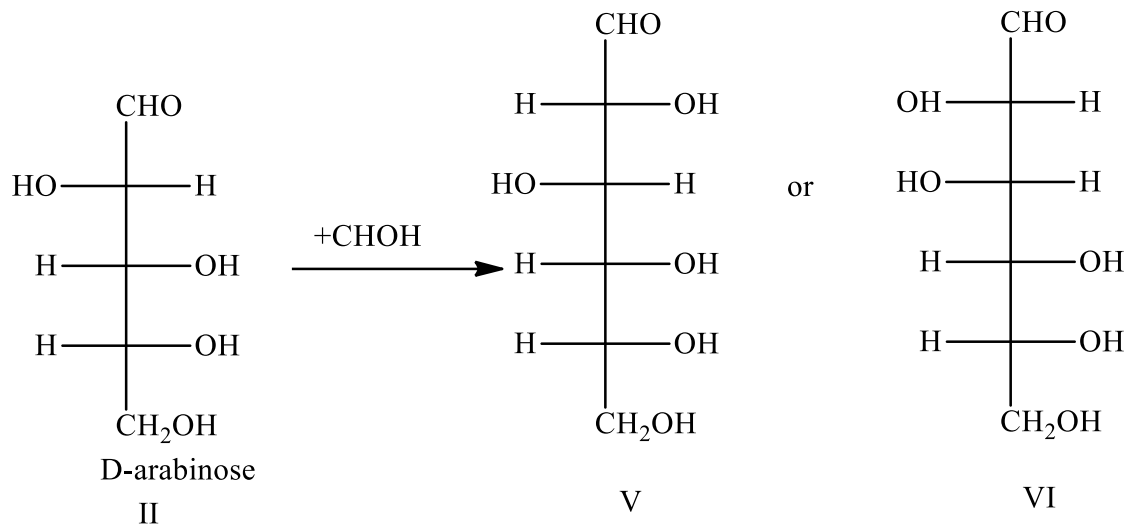
- D-Arabinose has configuration II or IV. Oxidation of D-arabinose with nitric acid oxidizes the terminal CHO and CH<sub>2</sub>OH groups yielding two optically active dicarboxylic acids. The forms II and IV can form two optically active diacids, while I and III can give meso acids only that have a plane of symmetry, therefore, D-arabinose is either II or IV.
- Configuration II confirmed for D-arabinose. D-arabinose by Killiani-Fisher synthesis yields two epimeric aldohexoses, D-glucose and D-mannose. These of oxidation with nitric acid form two optically active dicarboxylic acids. This is theoretically possible only if D-arabinose has the configuration II and not IV.



Proceeding similarly, you will find that if D-arabinose had configuration IV, of the two dicarboxylic acids derived from it, one would be meso and one asymmetric. Hence D-arabinose has the configuration II.

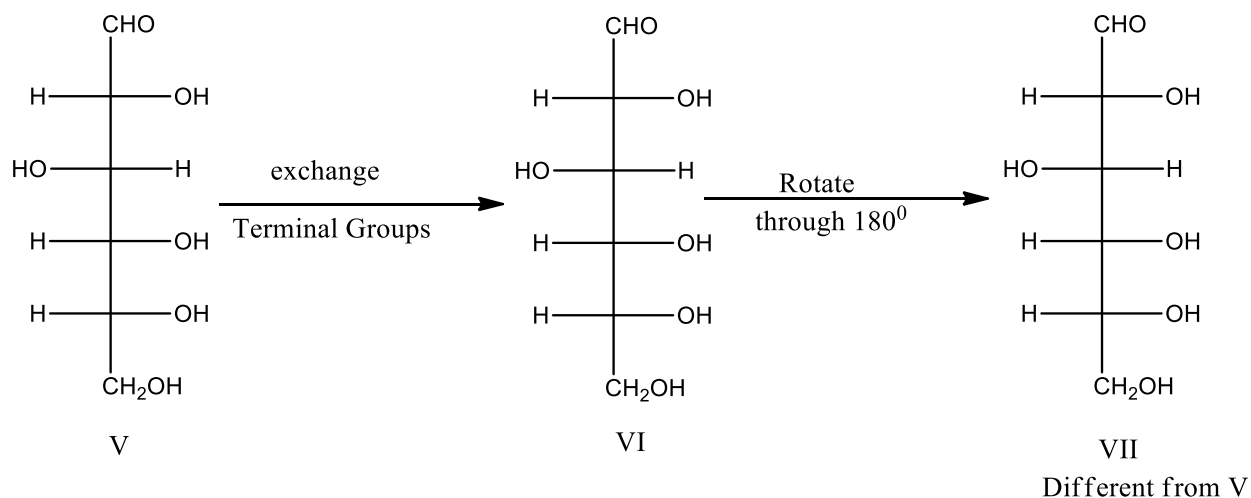
- Ruff degradation of D-glucose and D-mannose produces D-arabinose in each case. In ruff degradation the CHOH below CHO is destroyed. Therefore, the configuration of the two

aldohexoses, D-glucose and D-mannose, can be derived by adding a new CHOH below CHO in form II of D-arabinose.



Hence D-glucose has configuration V or VI.

5. D-Glucose and L-Glucose yield the same dicarboxylic acid. This means that two sugars differ only in respect of the position of the terminal groups (CHO and CH<sub>2</sub>OH). Therefore, the exchange of the terminal groups in D-glucose should be able to give a different aldohexose (L-glucose). Let us now examine configuration formula V and VI (one of which is D-glucose) from the angle.



If VII is rotated through 180° in the plane of paper, it gives an aldohexose VII, different from V. a similar procedure with formula VI does not give rise to a different sugar.

From the above arguments it is evident that D-glucose has the configuration as shown by the form V.

### Cyclic structure of D-Glucose

The open chain structure of glucose explained most of its properties. However, it could not explain the following facts.

1. Despite having an aldehyde group, glucose does not undergo certain characteristic reactions of aldehyde,
  - (a) Glucose does not react with sodium bisulphate to form addition product.
  - (b) Glucose does not react with ammonia.
  - (c) Glucose does not give Schiff's test and 2, 4-DNP test like other aldehydes.
2. Glucose reacts with hydroxylamine to form an oxime but glucose pentaacetate does not react with hydroxylamine. This shows that  $-CHO$  group is not present in glucose pentaacetate.
3. **D (+)-Glucose exist in two stereoisomeric forms i.e.,  $\alpha$ - D (+)-Glucose and  $\beta$ - D (+)-Glucose.** These two forms are crystalline and have different m.p and optical rotations. When glucose was crystallized from a concentrated solution at 303 K, it gave  $\alpha$ -form of glucose having m.p 419 K and  $[\alpha]_D = +111^\circ$ . On the other hand, the  $\beta$ -form of glucose is obtained on crystallization of glucose from a hot saturated solution of at a temperature above 371 K. The  $\beta$ -form of glucose has m.p 423 K and  $[\alpha]_D = +19.2^\circ$ .
4. **Mutarotation.** When either of two forms of glucose ( $\alpha$ - D-glucose and  $\beta$ - D-glucose) are dissolved in water and allowed to stand, these get slowly converted into other form and a equilibrium mixture of both  $\alpha$ - D-glucose (36 %) and  $\beta$ - D-glucose (about 64%) is formed.

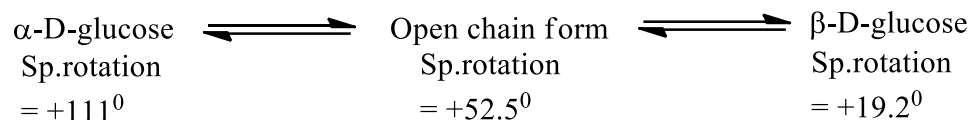
The formation of equilibrium mixture can be explained as:

The  $\alpha$ - D-glucose has a specific rotation of  $+111^\circ$ , while  $\beta$ - D-glucose has a specific rotation of  $+19.2^\circ$ . When  $\alpha$ -form is dissolved in water, its specific rotation falls until a constant value of  $+52.5^\circ$  is reached. On the other hand, when  $\beta$ -form is dissolved in water, its specific rotation increases and becomes constant at  $52.5^\circ$ .

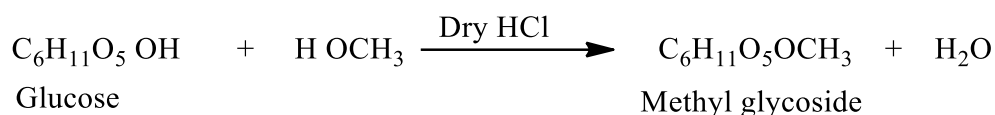


This spontaneous change in specific rotation of an optically active compound with time to an equilibrium value is called mutarotation. (Latin, mutare means to change).

Thus, there is an equilibrium mixture of  $\alpha$ - and  $\beta$ -forms in the solution



5. Glucose forms isomeric methyl glucosides. When glucose is heated with methanol in the presence of dry HCl, it gives two isomeric monomethyl derivatives known as  $\alpha$ -D-glucoside (m.p. = 438 K) and  $\beta$ -D-glucoside (m.p. 380 K).



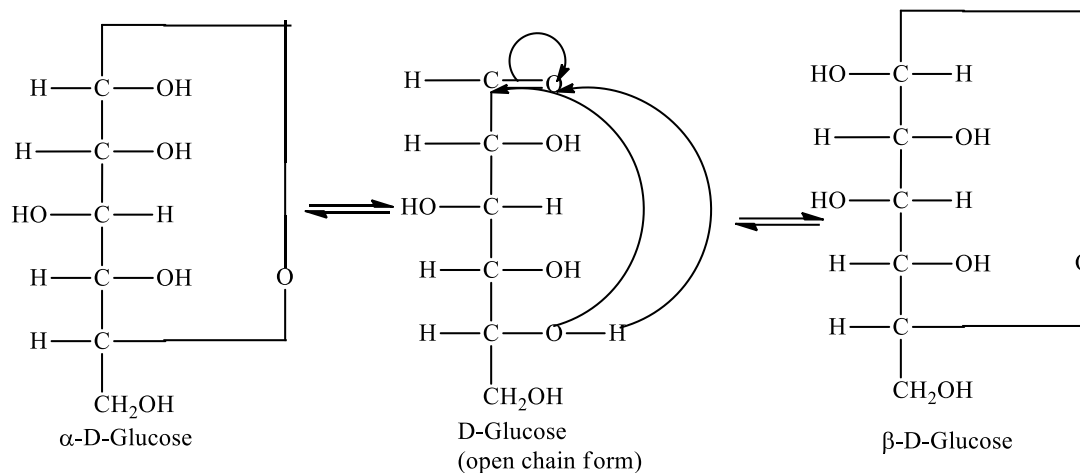
These two glucosides do not reduce Fehling's solution and also do not react with HCN or  $\text{NH}_2\text{OH}$  indicating that the free  $-\text{CHO}$  group is not present but it is converted to  $-\text{COOH}$  group.

### Cyclic structure of Glucose

#### Anomers:

Glucose forms a hemiacetal between the  $-\text{CHO}$  group and the  $-\text{OH}$  group on the  $\text{C}_5$  atom. As a result, of cyclisation,  $\text{C}_1$  becomes asymmetric (chiral) and the newly formed  $-\text{OH}$  group may be either on the left or on the right in Fisher projection formulae. These results in the formation of two isomers which differ in the orientation of H and  $-\text{OH}$  groups around  $\text{C}_1$  atom. These isomers are known as  $\alpha$ - D-glucose and  $\beta$ - D-glucose. The isomer having the  $-\text{OH}$  group on the right is called  $\alpha$ - D-glucose and one having the  $-\text{OH}$  group on the left is called  $\beta$ - D-glucose. Such pairs of optical isomers which differ in the configuration only around  $\text{C}_1$  atom are called anomers.

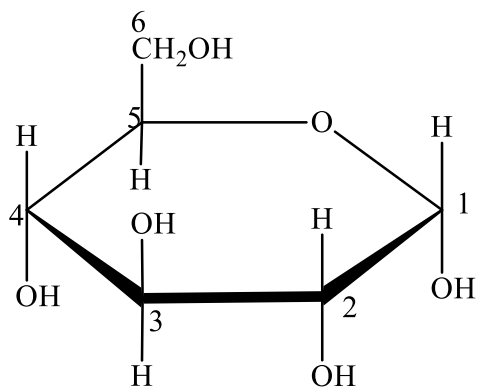
These two forms are not mirror image of each other, hence are not enantiomers. The  $\text{C}_1$  carbon is known as anomeric carbon or glycosidic carbon.



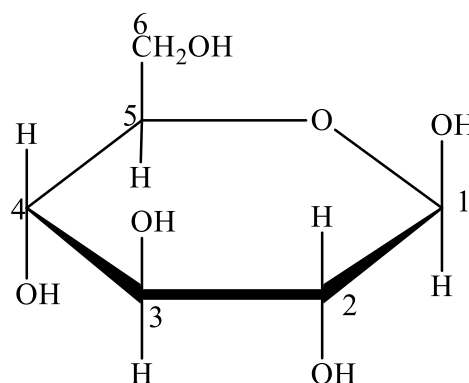
The above representations are called Fisher projection formulae.

### Haworth projection formulae or pyranose structures of D-Glucose.

In Haworth structures drawn with the heterocyclic oxygen in the upper right corner, the  $\alpha$ -form has the  $-\text{OH}$  group on  $\text{C}_1$  pointing “down”. The  $\beta$ -form has the same group pointing “up”. For D-sugars, the free  $-\text{CH}_2\text{OH}$  group of an aldohexose is drawn above the plane of ring when ring oxygen is in the upper right. The rest is the simple, the groups on the left of the Fisher projection are up and those on the right are down in the Haworth structure.



$\alpha$ -D-Glucose  
 or  
 $\alpha$ -D-Glucopyranose



$\beta$ -D-Glucose  
 or  
 $\beta$ -D-Glucopyranose

## Fructose

Fructose is another commonly known monosaccharide having the same molecular formula as glucose. It is laevorotatory because it rotates plane polarized light towards the left. It is present abundantly in fruits. That is why it is called fruit-sugar also.

### Physical properties

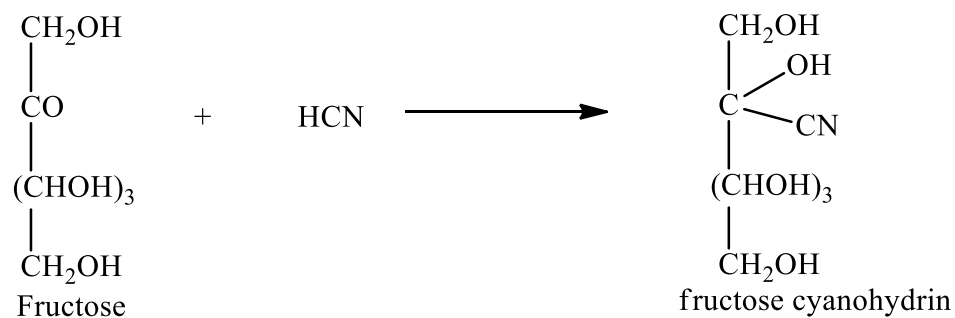
1. It is sweetest of all known sugars.
2. It is readily soluble in water, sparingly soluble in alcohol and insoluble in ether.
3. It is white crystalline solid with m.p. 375 K.
4. Fresh solution of fructose has a specific rotation  $-133^{\circ}$ .

### Chemical properties of fructose

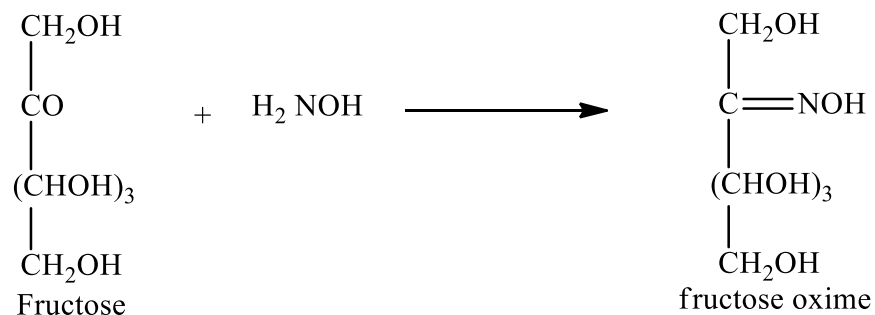
Chemical properties of fructose can be studied under the following heads:

#### (A) Reactions due to ketonic group

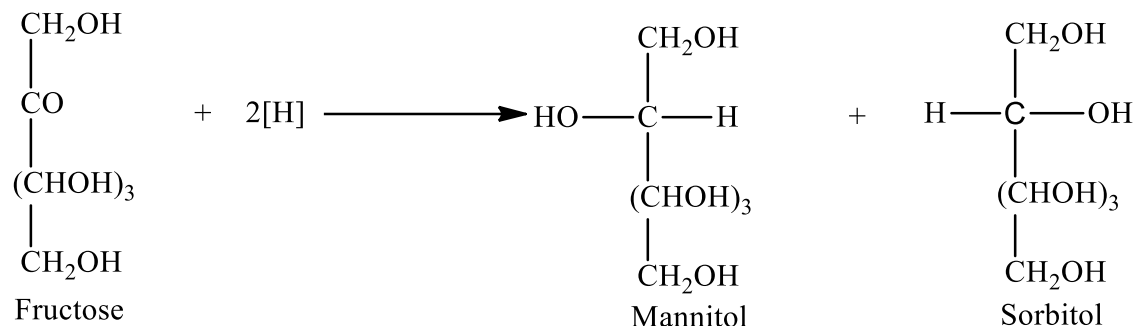
1. **Reaction with HCN.** Fructose reacts with HCN to form cyanohydrins.



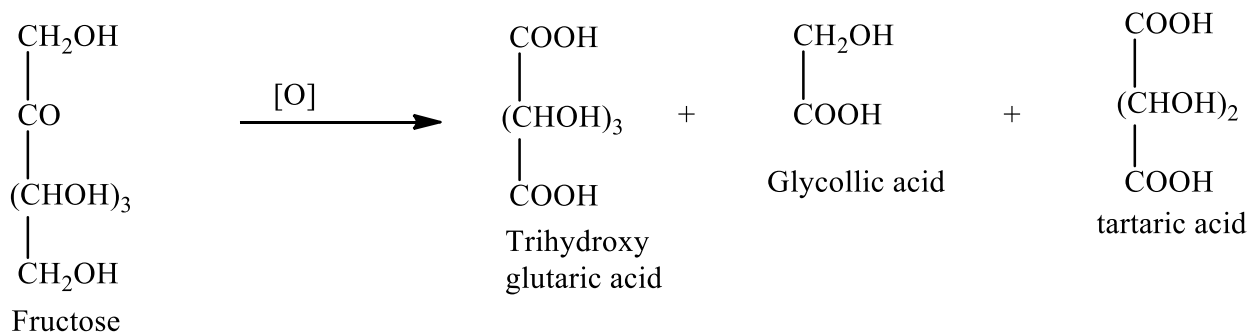
2. **Reaction with hydroxylamine.** Fructose reacts with hydroxylamine to form an oxime.



3. **Reduction.** Fructose gives a mixture of sorbitol and mannitol on reduction with Na-Hg and water or catalytic hydrogenation.



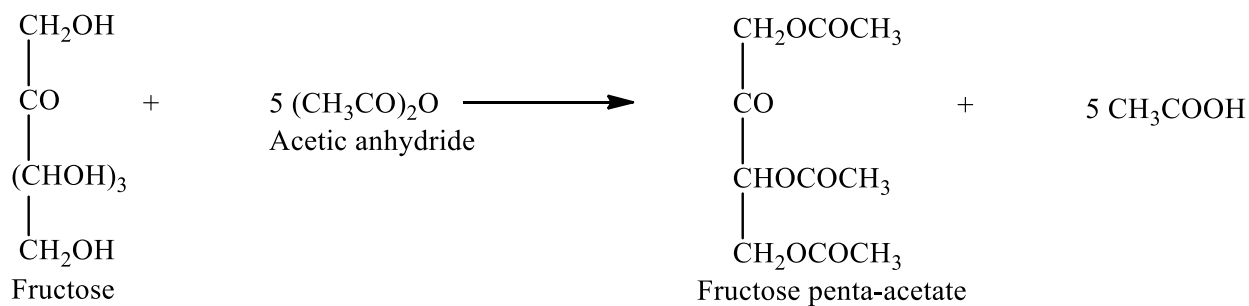
4. **Oxidation.** (i) there is no action of mild oxidizing agent like bromine water on fructose.  
(ii) Strong oxidizing agents like nitric acid oxidize fructose into a mixture of trihydroxy glutaric, glycolic and tartaric acids.



- (iii) Unlike other ketones, it reduces Tollen's reagent and Fehling solution. This is due to the presence of traces of glucose in alkaline medium.

### [B] reactions of the alcoholic group

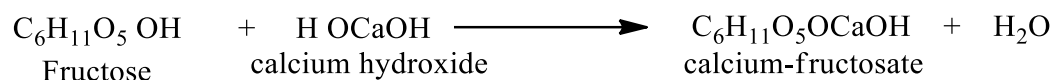
1. **Acetylation** . with acetic anhydride or acetyl chloride, fructose forms penta-acetate.



**2. Reaction with methyl alcohol (glucoside formation).** Fructose reacts with methyl alcohol in the presence of dry HCl gas forming methyl fructoside.



**3. Reaction with metallic hydroxides (fructosate formation)**



### Structure of Fructose

1. elemental analysis and molecular weight determination of fructose show that it has the molecular formula  $\text{C}_6\text{H}_{12}\text{O}_6$ .

2. fructose on reduction gives sorbitol which on reduction with HI and red P gives a mixture of n-hexane and 2-Iodohexane. This reaction indicates that six carbon atoms in fructose are in a straight chain.

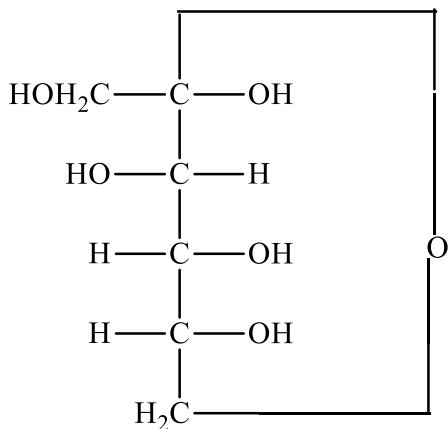
3. Fructose reacts with hydroxylamine, HCN and phenylhydrazine. It shows the presence of  $\text{-CHO}$  or  $\text{C=O}$  group in the molecule of fructose.

4. On treatment with bromine water, no reaction takes place. This rules out the possibility of presence of  $\text{-CHO}$  group.

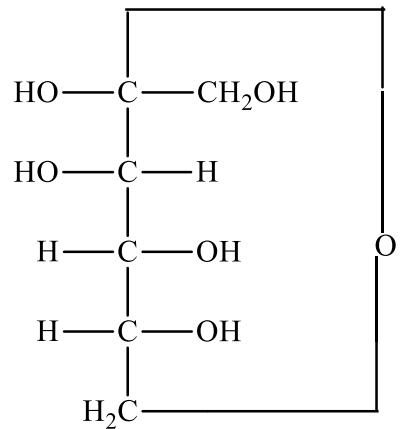
5. on oxidation with nitric acid, it gives glycollic acid and tartaric acids which contain smaller number of carbon atoms than fructose. This shows that a ketonic group is present at position 2. It is at this point that the molecule is broken.

### Cyclic structure of D-Fructose

Fructose shows the property of mutarotation. This means that it exists in two forms  $\alpha$ -fructose and  $\beta$ -fructose which are cyclic in structure and change into each other via the open chain structure. The cyclic and pyranose structures of  $\alpha$ -D-fructose and  $\beta$ -D-fructose are represented below:

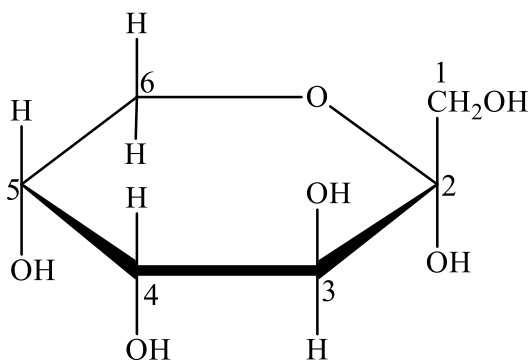


$\alpha$ -D-fructose

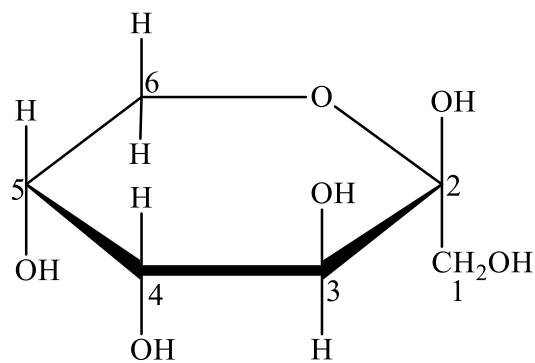


$\beta$ -D-fructose

Haworth Pyranose structure

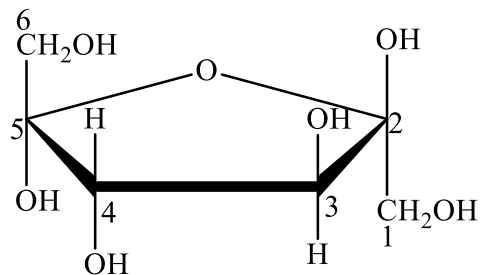


$\alpha$ -D-fructopyranose



$\beta$ -D-fructopyranose

However, when fructose is linked to glucose in a sucrose molecule, it has the furanose structure as shown below:



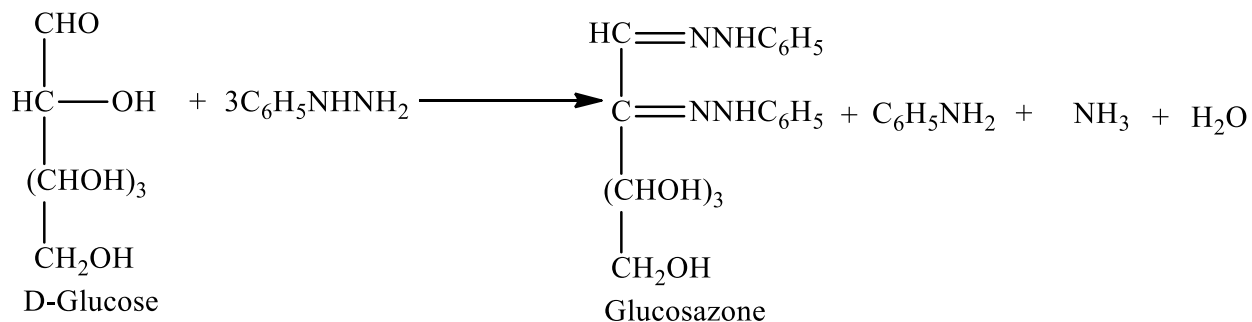
$\beta$ -D-fructofuranose

---

## 7.5 MECHANISM OF OSAZONE FORMATION

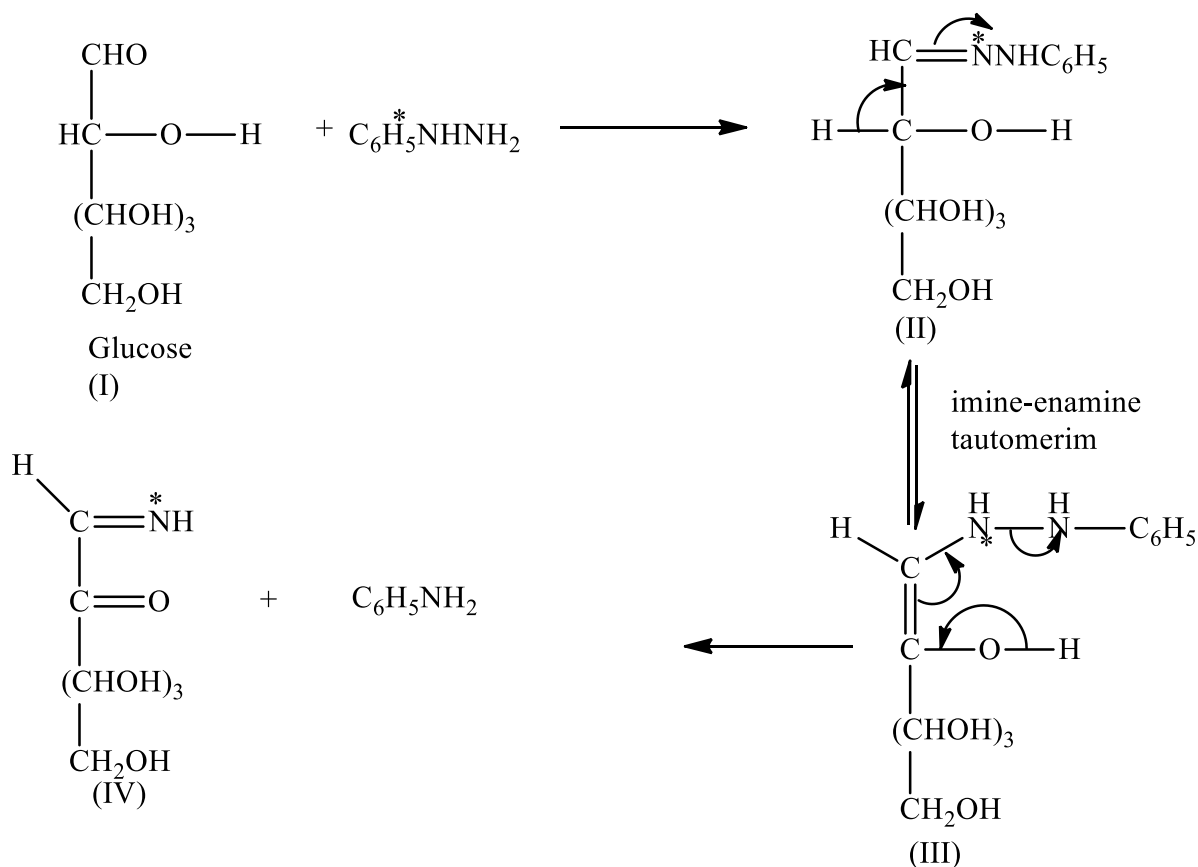
---

Glucose and fructose react with one equivalent of phenylhydrazine, forming phenylhydrazone. In contrast,  $\alpha$ -hydroxy carbonyl compounds react with three equivalents of phenylhydrazine to form bis-phenylhydrazones, commonly called osazones.



Phenylosazones crystallize readily and are useful derivatives for identifying sugars.

**Mechanism:** the first equivalent of phenylhydrazine forms phenylhydrazone with the aldehyde or ketone group as expected. Phenylhydrazone then undergoes the rearrangement, known as Amadori rearrangement, to give  $\alpha$ -iminoketone (IV) with the loss of aniline.



Subsequent attack of two moles of phenylhydrazine on the iminoketone (scheme-a) or on the ketoaldehyde (scheme-b) results in the formation of osazone accompanied by the elimination of ammonia.

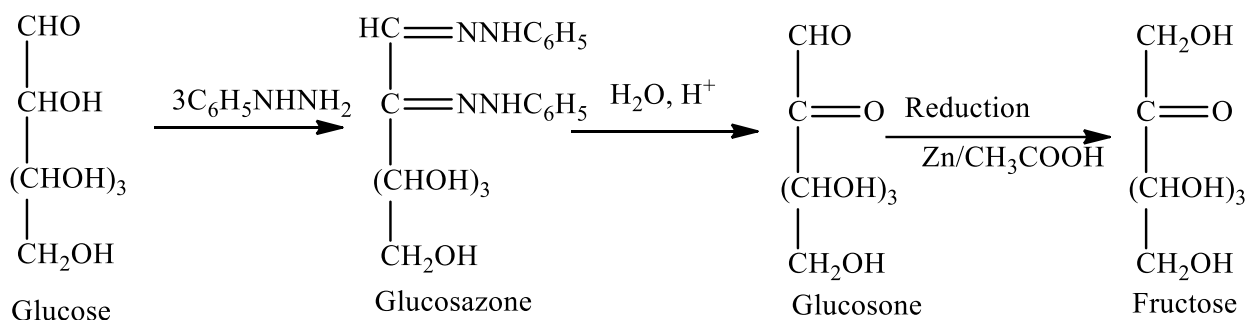
The given mechanism is supported by the observation that when phenyl hydrazone prepared by the reaction of glucose with  $N^{15}$  ( $N^*$ ) labeled phenylhydrazine is treated with ordinary phenylhydrazine, unlabelled osazone is obtained accompanied by the expulsion of labelled ammonia.

---

## 7.6 INTERCONVERSION OF GLUCOSE AND FRUCTOSE

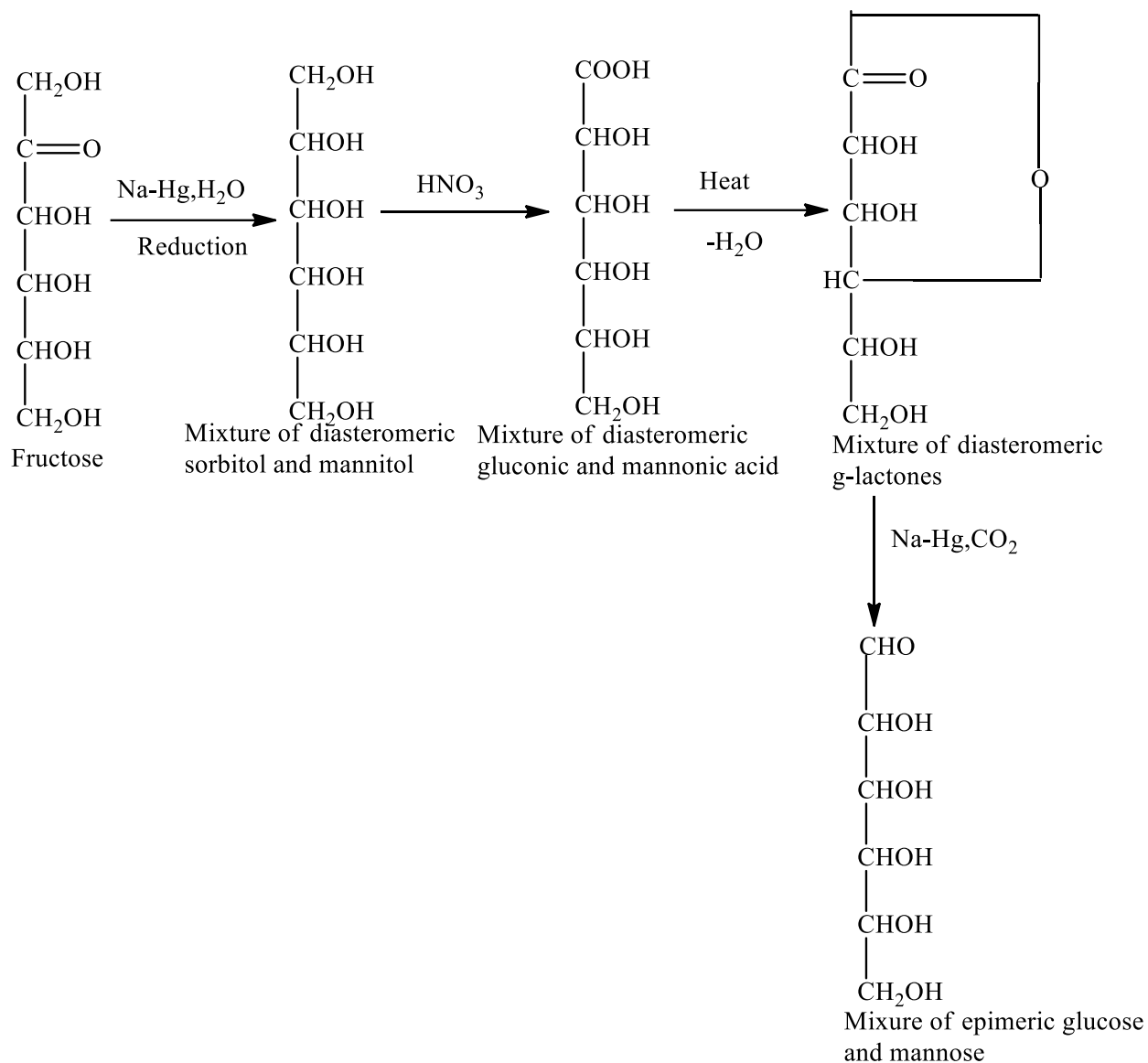
---

(a) Conversion of an aldose into an isomeric ketose. The procedure used for this purpose may be illustrated by taking into account the conversion of glucose into fructose.



(b) Conversion of ketose into an isomeric aldose. The procedure used here may be illustrated by taking into account the conversion of fructose into a mixture of epimeric aldoses, viz., glucose and mannose.






---

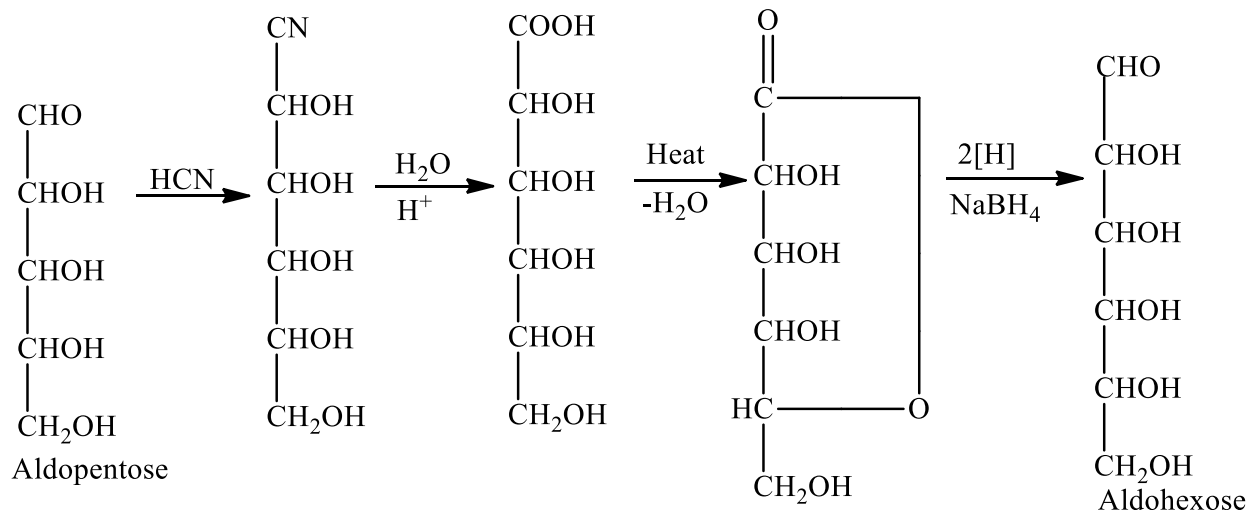
## 7.7 CHAIN LENGTHENING AND CHAIN SHORTENING OF ALDOSE

---

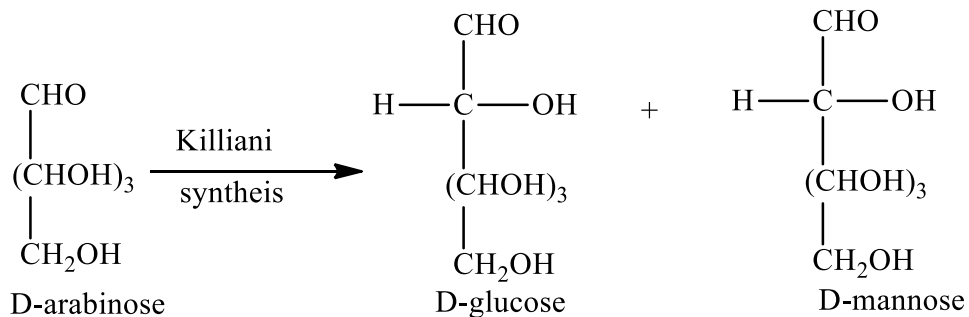
### (a) Lengthening of aldoses: Killiani-Fisher synthesis

The aldose chains may be lengthened by one carbon atom by a procedure known as **Killiani-Fisher synthesis**. Thus an aldose may be converted to the next higher member by the following steps: (1) Formation of cyanohydrins; (2) hydrolysis of  $-\text{CN}$  to  $-\text{COOH}$ , giving aldonic acid; (3) conversion of aldonic acid to lactone by heating; (4) reduction of lactone with sodium

borohydride,  $\text{NaBH}_4$ , to get higher aldose. For illustration, the overall change is the creation of an asymmetric centre at C-2 where a new  $\text{CHOH}$  has been added. Therefore their result two aldoses with one carbon more and differing only in configuration at C-2.



Taking a specific example, D-arabinose by killiani-Fisher synthesis gives two isomeric aldohexoses, D-glucose and D-mannose which differ only in the configuration at C-2

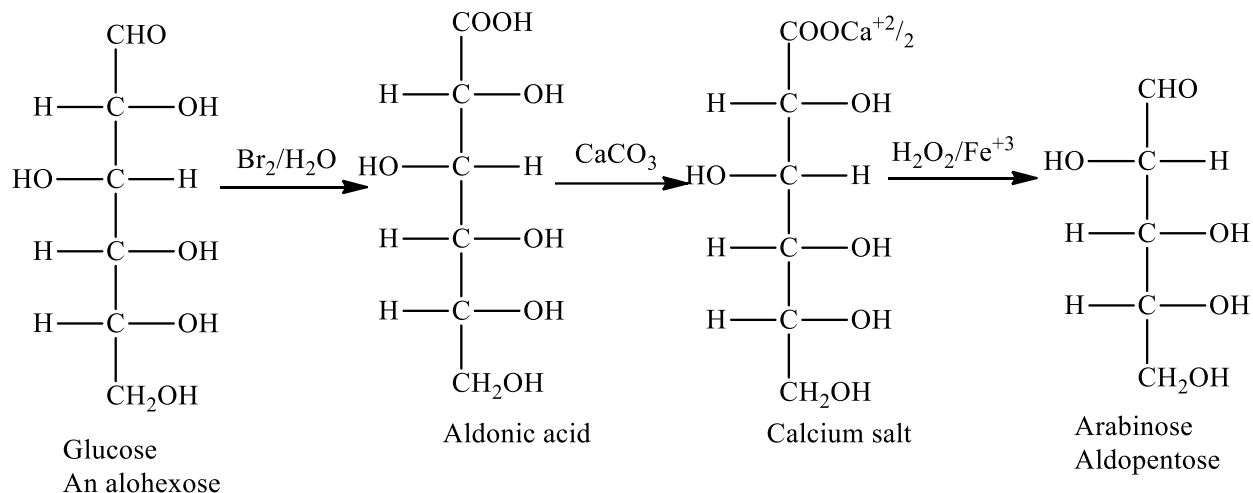


Such sugars which differ in configuration only at one asymmetric centre (C-2) are called Epimers.

### (b) Shortening of aldoses

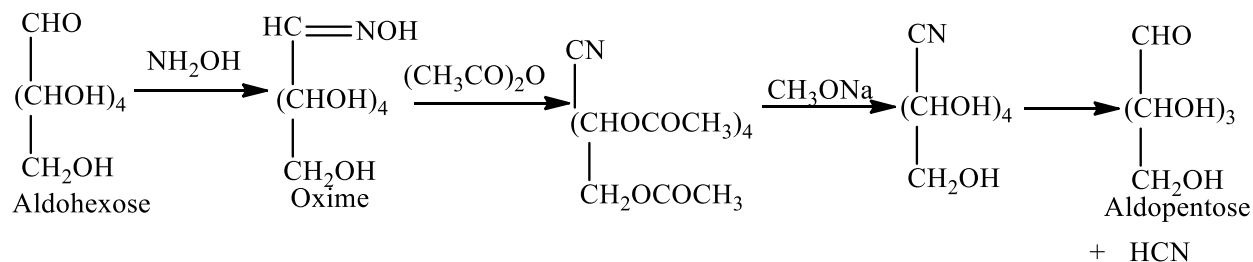
**(1) Ruff degradation.** An aldose may be converted into a lower aldose having one carbon atom less, i.e., the carbon chain may be shortened by Ruff degradation.

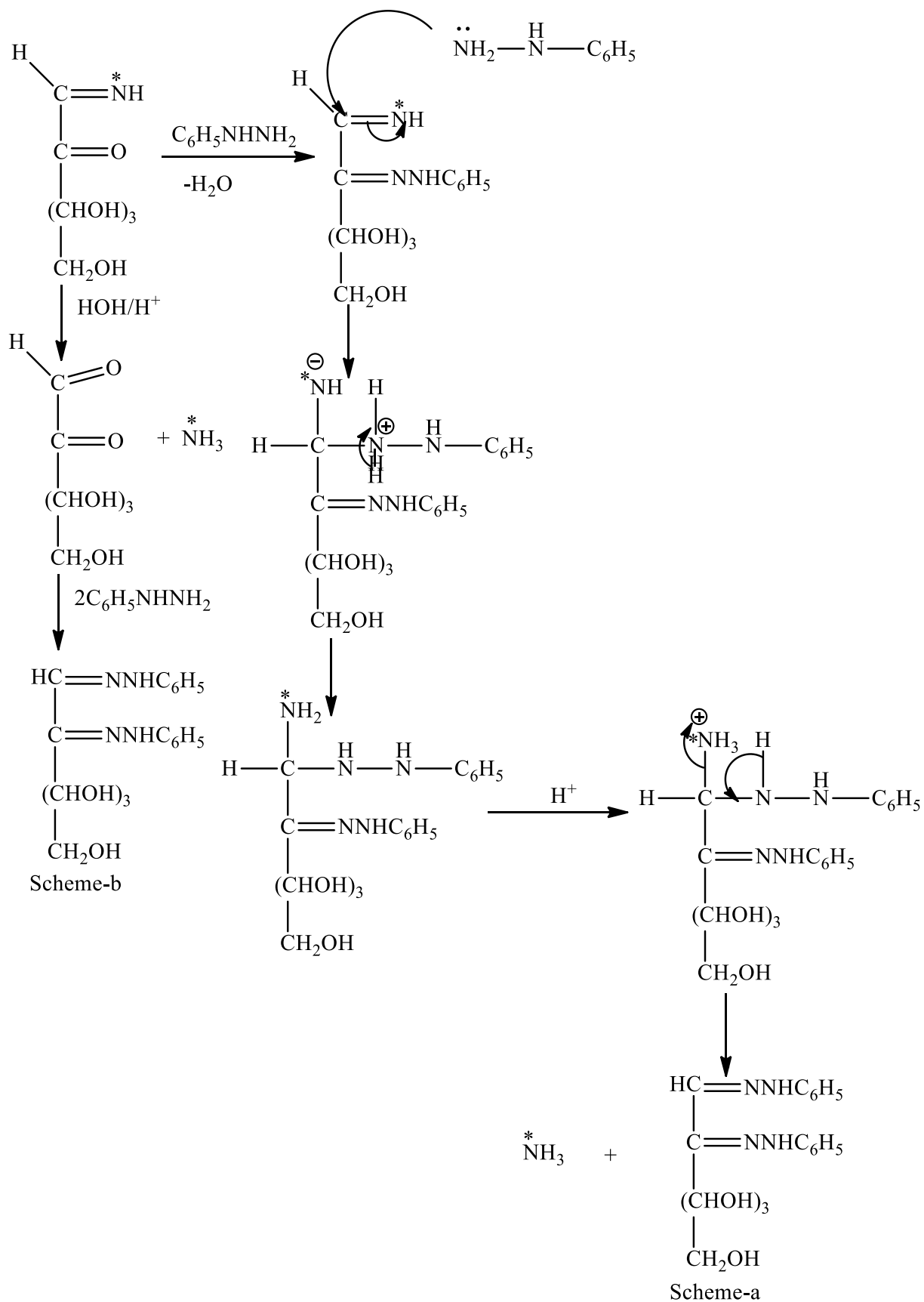
The method involves the oxidation of starting aldose into the corresponding aldonic acid. The acid is converted into its calcium salt which is treated with Fenton's reagent (H<sub>2</sub>O<sub>2</sub> in presence of Fe<sup>+3</sup> ion) to get the lower aldose. This method is illustrated as follows:



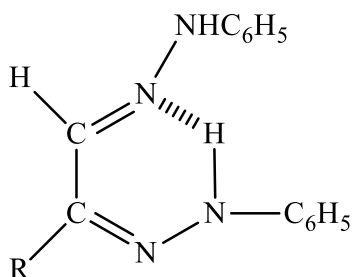
## (2) Wohl's degradation for chain shortening in aldoses

In this degradation, the aldose is converted into its oxime by treatment with hydrogrdadoxylamine. The oxime is treated with acetic anhydride when the oxime is dehydrated to nitrile. The nitrile is then treated with sodium methoxide. The cyanohydrin obtained undergoes degradation to a lower aldose. The reaction are written as under.





The osazone so formed does not undergo further Amadori rearrangement. This is the reaction with phenylhydrazine stops at this stage; thus further reaction at C-3 –OH group does not occur. This is because the osazone so formed, does not react further via intramolecular Amadori rearrangement involving C-3 –OH group because of the intramolecular hydrogen bonding as shown below:




---

## 7.8. SUMMARY

---

- Carbohydrates are poly hydroxy aldehydes and ketones.
- Monosaccharides containing an aldehyde group are called aldoses and those with a keto group are called ketoses.
- Carbohydrates can also be classified as disaccharides, oligosaccharides, and polysaccharides consist of monosaccharides linked by glycosidic bonds.
- The most abundant monosaccharide in nature is 6- carbon sugar, D-glucose. It exists as  $\alpha$  and  $\beta$  anomers with different optical rotations.
- If two monosaccharides isomers differ in configuration around one specific carbon atom [With exception of carbonyl carbon] they are called epimers of each other.

---

## 7.9. MODEL EXAMINATION QUESTIONS

---

1. Define and classify carbohydrates with suitable examples.
2. Explain Kiliani-Fischer synthesis and Ruff's degradation.
3. Explain the limitations of open chain D-glucose structure.
4. Establish the structure of glucose and fructose.

---

## ***REFERENCES***

---

1. A text book of organic chemistry, A. Bahl and B.S.Bahl, S.Chand & Compant Ltd.
2. Chemistry for degree students, R.L.madan, S.Chand & Compant Ltd.
3. Organic chemistry, Vol.III, Jagdamba singh and L.D.S Yadav, Prgati Prakashan.
4. Modern chemistry, S.P.Jauhar, Modern Publishers.
5. Organic chemistry, Francis A.Carey, Tata McGraw-Hill Company Ltd.

---

## UNIT-8 CARBOHYDRATES-II

---

### **CONTENTS**

8.1 Objectives

8.2 Introduction

8.3. Configuration of monosaccharides

8.4. Erythro and threo distereomers conversion of glucose

8.5 ethers and esters

8.6. Determination of ring size of monosaccharides

8.7. Cyclic structure of D-glucose

8.8. Mechanism of mutarotation

8.9. General study of disaccharides

8.10. General introduction of structure of ribose and deoxyribose

8.11. General study of polysaccharides

8.12 Summary

8.13. Model examination questions

---

### ***8.1 OBJECTIVES***

---

After going through this unit you will be able to:

- Know about configuration of monosaccharides
- Discuss about Erythro and threo distereomers conversion of glucose
- Describe ether and ester formation,
- Determination of ring size of monosaccharides,
- Cyclic structure of D-glucose

- Mechanism of mutarotation
- Types of disaccharides and their properties
- Structure of ribose and deoxyribose
- Polysaccharides and its types

---

## 8.2 INTRODUCTION

---

The carbohydrates are an important class of naturally occurring organic compounds. They occur naturally in plants (where they are produced photosynthetically), when the word "carbohydrate" was coined, it originally referred to compounds of general formula  $C_n(H_2O)_n$ . However, only the simple sugars or monosaccharides fit this formula exactly. The other types of carbohydrates, oligosaccharides, and polysaccharides, are based on monosaccharide units and have slightly different general formula. Carbohydrates also called "saccharides" which means sugar in Greek.

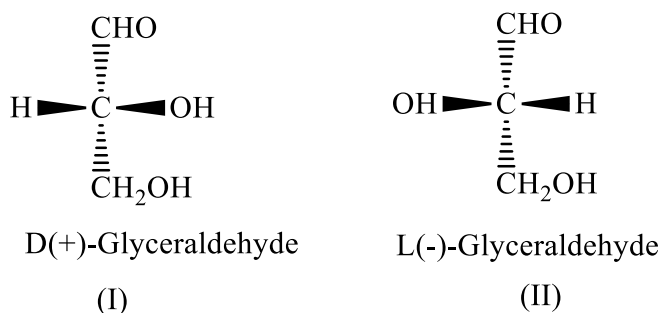
Many commonly encountered carbohydrates are polysaccharides, including glycogen, which is found in animals, and starch and cellulose, which occur in plant.

---

## 8.3 CONFIGURATION OF MONOSACCHARIDES

---

In early days of development of stereochemistry of organic compounds, it was not possible to determine the absolute configurations. The chemists were only interested in knowing the relative configurations. To decide about configurations, Emil Fisher in 1885 chose glyceraldehyde ( $CHOCHOHCH_2OH$ ) as the standard substance and fixed its relative configurations arbitrarily. This compound exists in two enantiomeric forms, as given below:



Compound I was found to be dextrorotatory and compound II was found to be laevorotatory. The difference between configuration of the two compounds is that in compound (I), -H is located

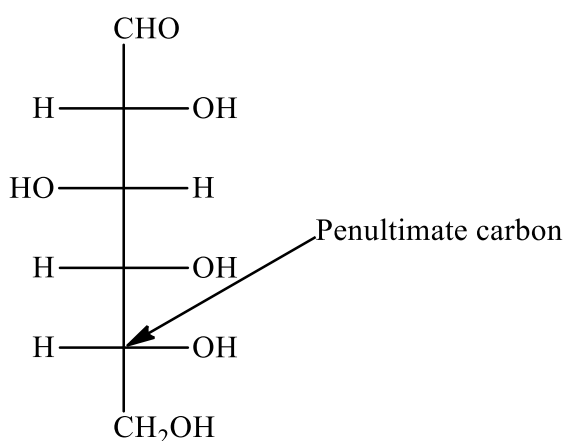


on the L.H.S and –OH is located on the R.H.S. of the Fisher projection formula while in compound (II), this is in reverse order.

Configuration of other compounds was then assigned by relating their configuration to that of D- or L-Glyceraldehyde.

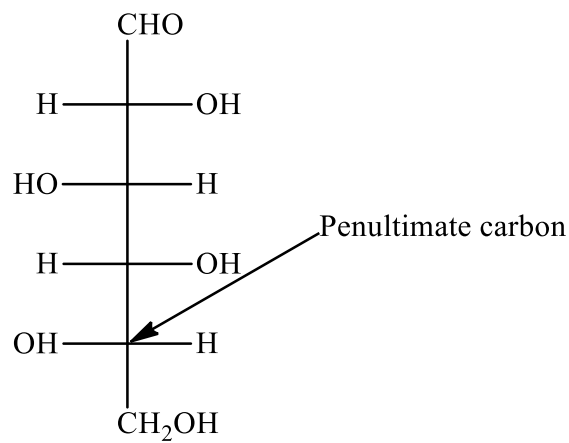
In 1951 Bijvoet using x-ray crystallography established that the arbitrarily assigned configurations of glyceraldehydes actually represented their correct absolute configurations. Thus, if the configuration of glyceraldehydes were correct, the derived relative configurations of other compound must also be their correct absolute configuration.

Thus D- and L- glyceraldehydes serve as reference molecule for all the monosaccharides. A monosaccharide whose penultimate carbon (farthest chiral carbon atom from most oxidizing end i.e, -CHO) has the same configuration as D-Glyceraldehyde has L-configuration. Similarly , amonosaccharide whose penultimate carbon has the same configuration as L-Glyceraldehyde has L-configuration. This is illustrated with the help of following examples.



**D-configuration**

(because the configuration at penultimate carbon is the same as that of D-Glyceraldehyde)



**L-configuration**

(because the configuration at penultimate carbon is the same as that of L-Glyceraldehyde)

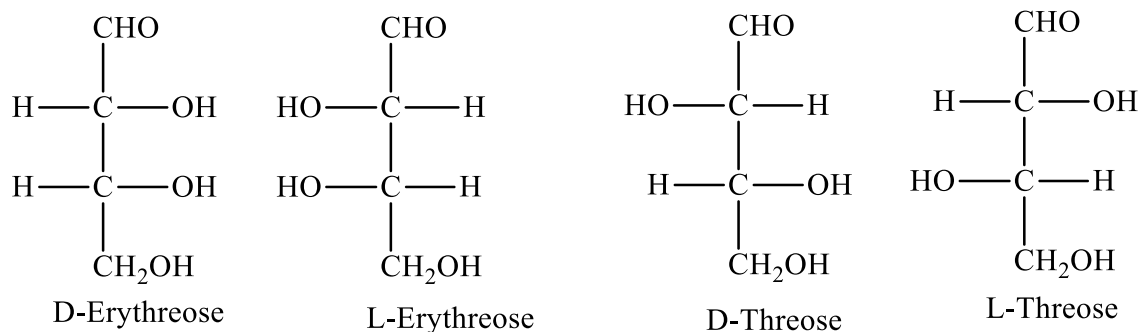
---

## ***8.4. ERYTHRO AND THREO DIASTEROMERS CONVERSION OF GLUCOSE***

---

Erythro and Threo system of nomenclature is used only in aldotetroses. Aldotetrose have two chirality centres and therefore four stereoisomers. Two of the sttereoisomers are D-sugars

and two are L-sugars. When Fischer projections are drawn for stereoisomers with two adjacent chirality centres, the pair of enantiomers with similar groups on the same side of the carbon chain is called the erythro enantiomers. The pair of enantiomers with similar groups on opposite sides are called the threo enantiomers. The names of erythro and threo pairs of enantiomers in fact, originated from the name of aldotetroses, erythrose and threose.



Erythrose and threose are diastereomers.

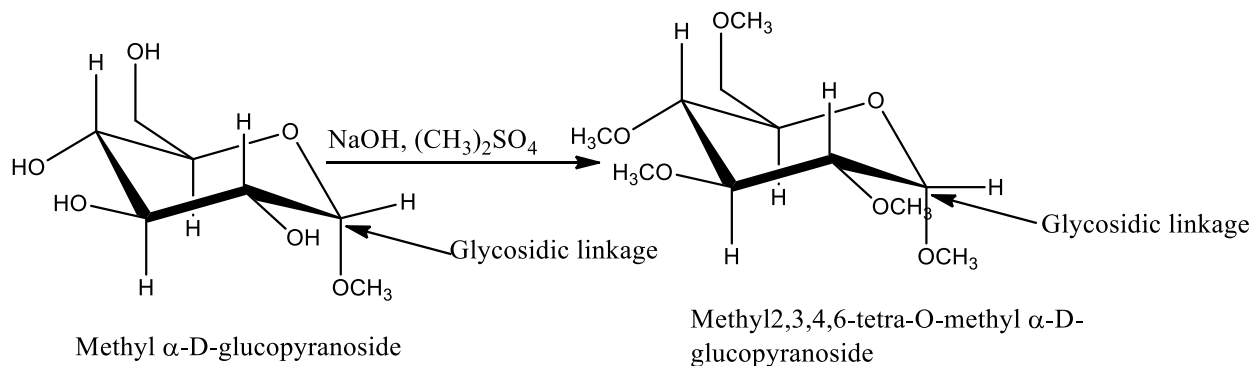
---

## 8.5. ETHERS AND ESTERS

---

### (a) Formation of ethers

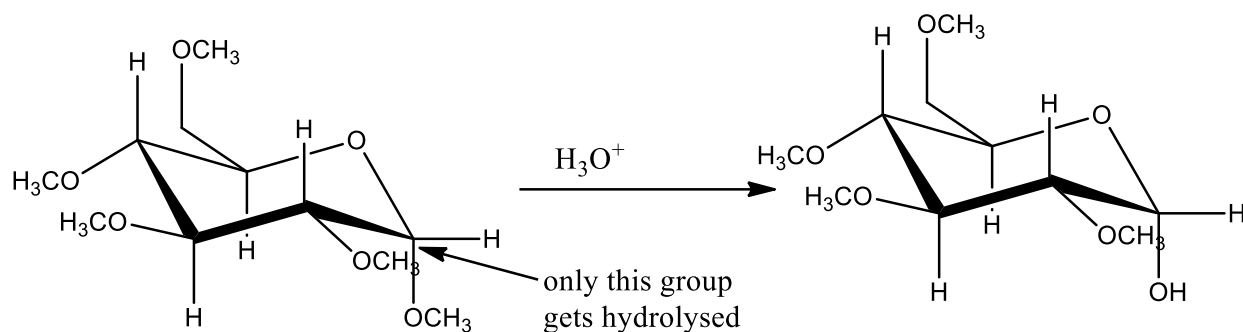
It is possible to convert the -OH groups attached to carbons other than anomeric carbon into alkyl derivatives having ordinary ether C-O-C linkages. For example methyl glucoside can be converted into pentamethyl derivative by treatment with excess dimethyl sulphate in aqueous sodium hydroxide. The function of sodium hydroxide is to convert hydroxyl groups into alkoxide ions which then react with dimethyl sulphate by an  $S_N2$  reaction to form methyl ethers.



Since all the  $\text{-OH}$  groups are converted into  $\text{-OCH}_3$  groups, the process is called exhaustive methylation or permethylation.

For naming these compounds, each  $\text{-OCH}_3$  group except that of glycosidic linkage is named as an O-methyl group.

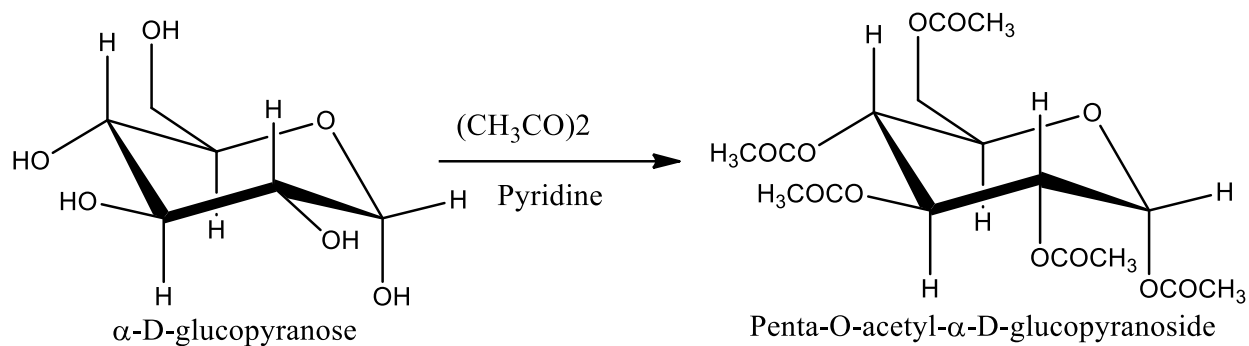
When permethylated glycoside is treated with dilute aqueous acid, the methyl glycoside bond gets hydrolysed (since acetals are hydrolysed in acidic solution). But the other methyl groups remain unaffected. This is because ordinary ether groups are stable in dilute aqueous acids. This is shown as under:



The process of permethylation of glycosides followed by acidic hydrolysis of glycosidic linkage forms an important method for determining the ring size of monosaccharides. This has been illustrated in the case of cyclic structure of glucose.

### (b) Formation of esters

Monosaccharides on treatment with acetic anhydride are converted into ester derivatives which are very useful crystalline compounds. The monosaccharide is treated with acetic anhydride and pyridine when all the hydroxyl groups are converted to ester groups. When carried out at low temperature (273 K), the reaction takes place stereospecifically,  $\alpha$ -anomer gives the  $\alpha$ -acetate and the  $\beta$ -anomer gives the  $\beta$ -acetate. For example:



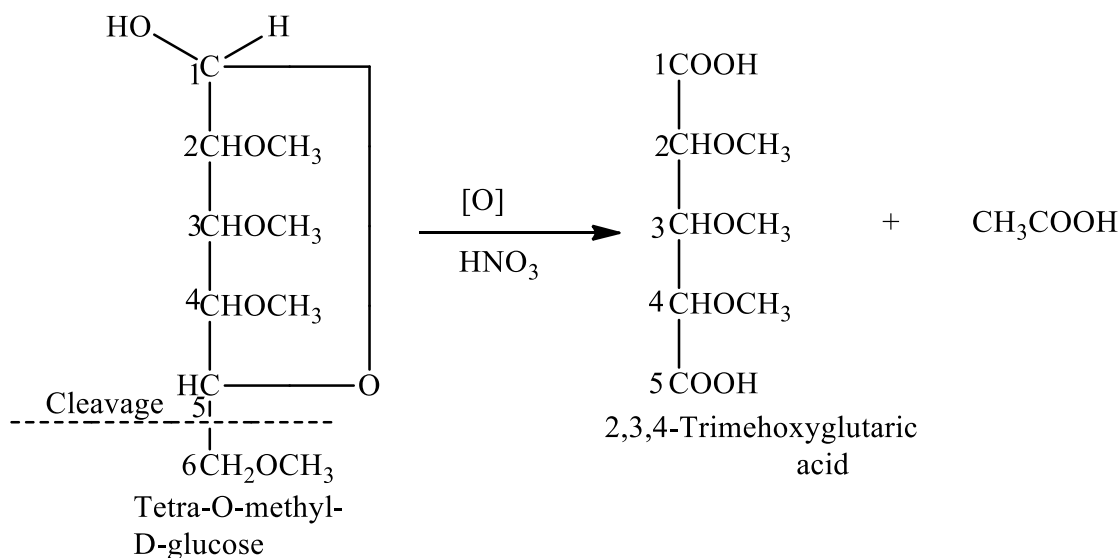

---

## 8.6. DETERMINATION OF RING SIZE OF MONOSACCHARIDES

---

So far we have represented structure of cyclic hemiacetals or anomers of D-glucose as having a ring of six members, five carbons and one oxygen. This has been proved to be correct and a five membered ring has been ruled out.

Hirst (1926) prepared tetra-O-methyl-D-glucose with dimethyl sulphate and subsequent acid hydrolysis of the pentamethyl derivative formed. The oxidation of tetra-O-methyl-D-glucose with nitric acid yielded trimethoxyglutaric acid.



Obviously, the two carboxylic carbons (1, 5) of the trimethoxyglutaric acid are the one's originally involved in ring formation. Hence, there must have existed an oxide ring between C-1 and C-5. Tracing back the reaction sequence, it stands proved that D-glucose has a six membered

ring. The presence of a 6-membered ring in D-glucose has also been confirmed by X-ray analysis.

---

## 8.7. CYCLIC STRUCTURE OF D-GLUCOSE

---

The open chain structure of glucose explained most of its properties. However, it could not explain the following facts.

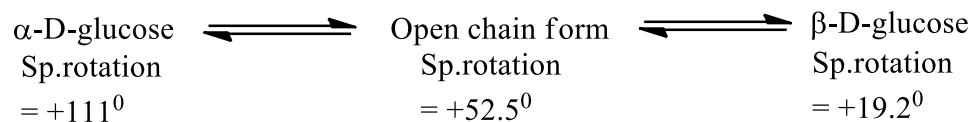
6. Despite having an aldehyde group, glucose does not undergo certain characteristic reactions of aldehyde,
  - (d) Glucose does not react with sodium bisulphate to form addition product.
  - (e) Glucose does not react with ammonia.
  - (f) Glucose does not give Schiff's test and 2, 4-DNP test like other aldehydes.
7. Glucose reacts with hydroxylamine to form an oxime but glucose pentaacetate does not react with hydroxylamine. This shows that  $-CHO$  group is not present in glucose pentaacetate.
8. **D (+)-Glucose exist in two stereoisomeric forms i.e.,  $\alpha$ - D(+)-Glucose and  $\beta$ - D(+)-Glucose.** These two forms are crystalline and have different m.p and optical rotations. When glucose was crystallized from a concentrated solution at 303 K, it gave  $\alpha$ -form of glucose having m.p 419 K and  $[\alpha]_D = +111^{\circ}$ . On the other hand, the  $\beta$ -form of glucose is obtained on crystallization of glucose from a hot saturated solution of at a temperature above 371 K. The  $\beta$ -form of glucose has m.p 423 K and  $[\alpha]_D = +19.2^{\circ}$ .
9. **Mutarotation.** When either of two forms of glucose ( $\alpha$ - D-glucose and  $\beta$ - D-glucose) are dissolved in water and allowed to stand, these get slowly converted into other form and a equilibrium mixture of both  $\alpha$ - D-glucose (36 %) and  $\beta$ - D-glucose (about 64%) is formed.

The formation of equilibrium mixture can be explained as:

The  $\alpha$ - D-glucose has a specific rotation of  $+111^{\circ}$ , while  $\beta$ - D-glucose has a specific rotation of  $+19.2^{\circ}$ . When  $\alpha$ -form is dissolved in water, its specific rotation falls until a constant value of  $+52.5^{\circ}$  is reached. On the other hand, when  $\beta$ -form is dissolved in water, its specific rotation increases and becomes constant at  $52.5^{\circ}$ .

This spontaneous change in specific rotation of an optically active compound with time to an equilibrium value is called mutarotation. (Latin, mutare means to change).

Thus, there is an equilibrium mixture of  $\alpha$ - and  $\beta$ -forms in the solution



10. Glucose forms isomeric methyl glucosides. When glucose is heated with methanol in the presence of dry HCl, it gives two isomeric monomethyl derivatives known as  $\alpha$ -D-glucoside (m.p. = 438 K) and  $\beta$ -D-glucoside (m.p. 380 K).



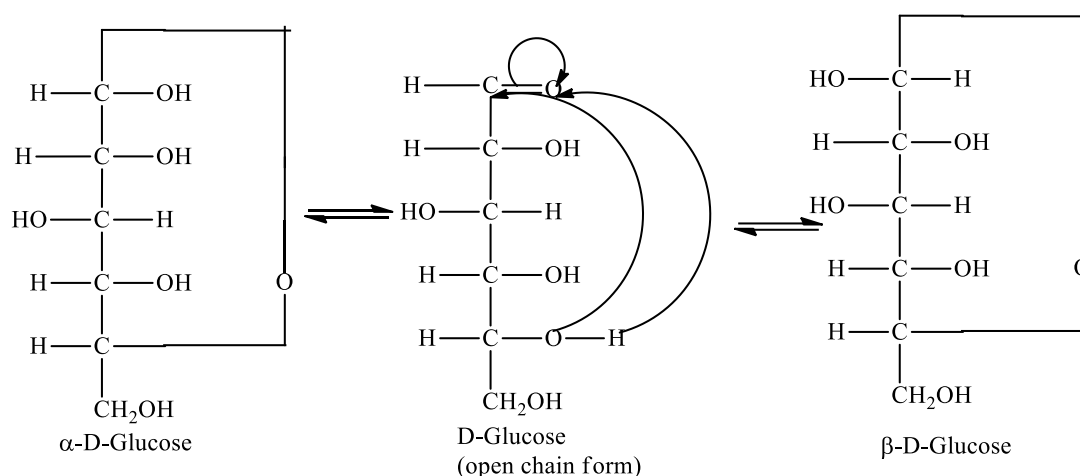
These two glucosides do not reduce Fehling's solution and also do not react with HCN or  $\text{NH}_2\text{OH}$  indicating that the free  $-\text{CHO}$  group is not present but it is converted to  $-\text{COOH}$  group.

### Cyclic structure of Glucose

#### Anomers.

Glucose forms a hemiacetal between the  $-\text{CHO}$  group and the  $-\text{OH}$  group on the  $\text{C}_5$  atom. As a result, of cyclisation,  $\text{C}_1$  becomes asymmetric (chiral) and the newly formed  $-\text{OH}$  group may be either on the left or on the right in Fisher projection formulae. This result in the formation of two isomers which differs in the orientation of H and  $-\text{OH}$  groups around  $\text{C}_1$  atom. These isomers are known as  $\alpha$ - D-glucose and  $\beta$ - D-glucose. The isomer having the  $-\text{OH}$  group on the right is called  $\alpha$ - D-glucose and one having the  $-\text{OH}$  group on the left is called  $\beta$ - D-glucose. Such pairs of optical isomers which differ in the configuration only around  $\text{C}_1$  atom are called anomers.

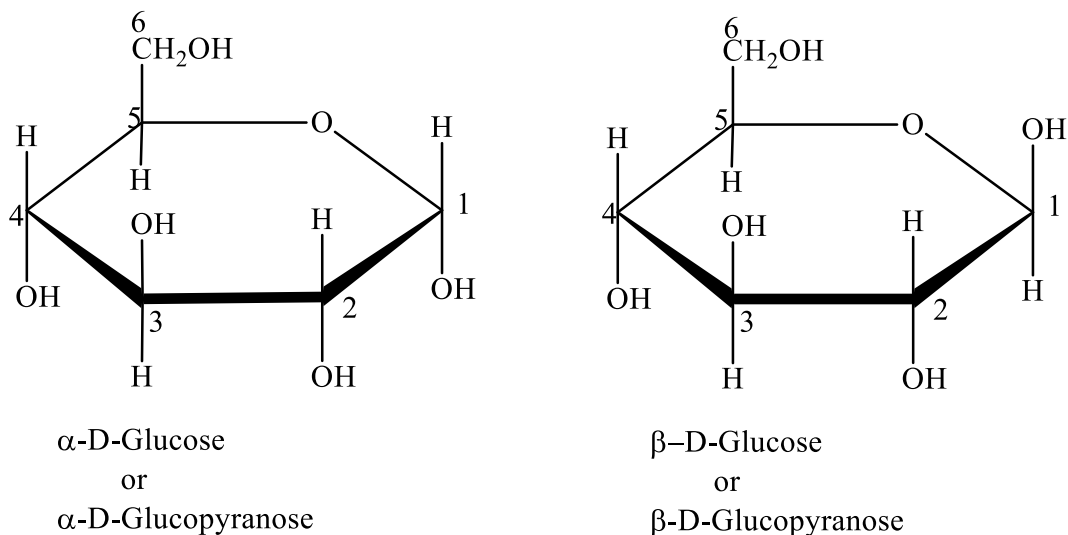
These two forms are not mirror image of each other, hence are not enantiomers. The  $\text{C}_1$  carbon is known as anomeric carbon or glycosidic carbon.



The above representations are called Fisher projection formulae.

### Haworth projection formulae or pyranose structures of D-Glucose.

In Haworth structures drawn with the heterocyclic oxygen in the upper right corner, the  $\alpha$ -form has the  $-\text{OH}$  group on  $\text{C}_1$  pointing “down”. The  $\beta$ -form has the same group pointing “up”. For D-sugars, the free  $-\text{CH}_2\text{OH}$  group of an aldohexose is drawn above the plane of ring when ring oxygen is in the upper right. The rest is the simple, the groups on the left of the Fisher projection are up and those on the right are down in the Haworth structure.



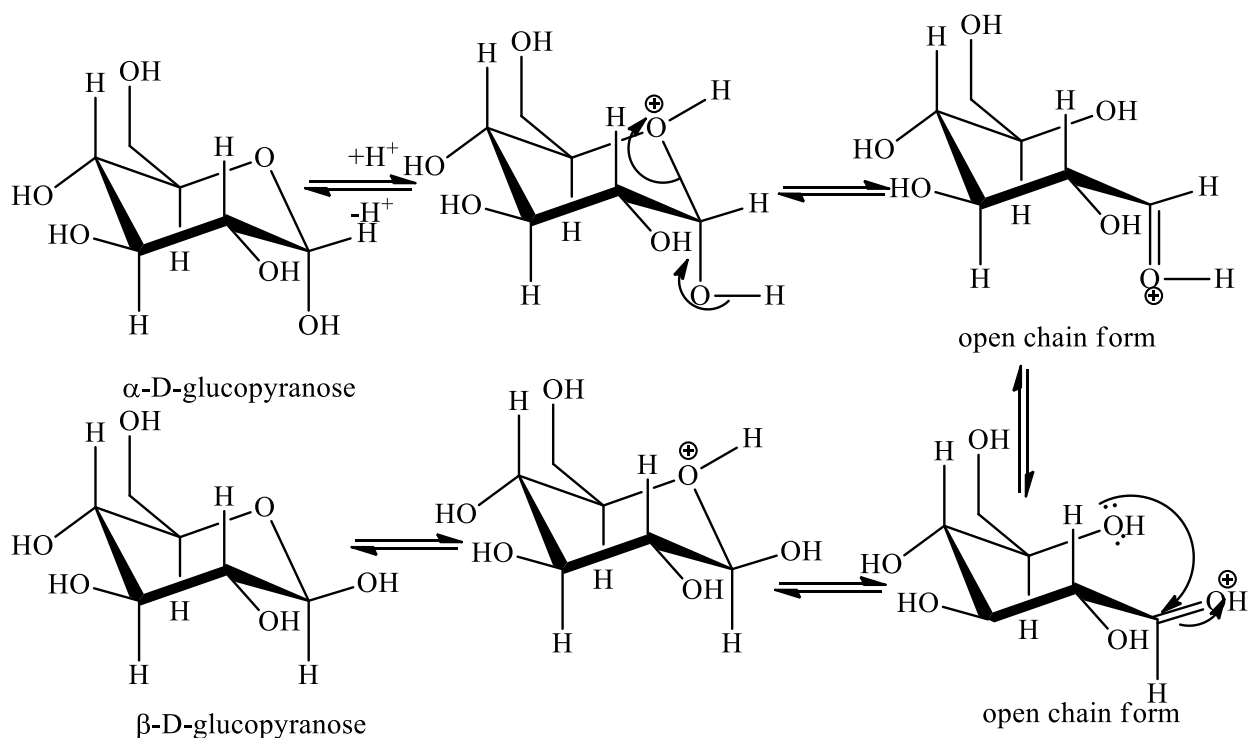

---

## 8.8. MECHANISM OF MUTAROTATION

---

Mutarotation occurs by opening of the ring to the free carbonyl form. The mechanism shown in Scheme I begins as the reverse of hemiacetal (or hemiketal) formation. An 180° rotation about the bond to the carbonyl group permits attack of the hydroxyl group at C-5 on the opposite face of the carbonyl carbon. Hemiacetal formation then gives the other anomer. Mutarotation is catalysed by both acid and base.

Thus, the easy opening and closing of hemiacetal or hemiketal linkage is responsible for mutarotation.



**Scheme I. Acid catalysed mechanism of mutarotation**

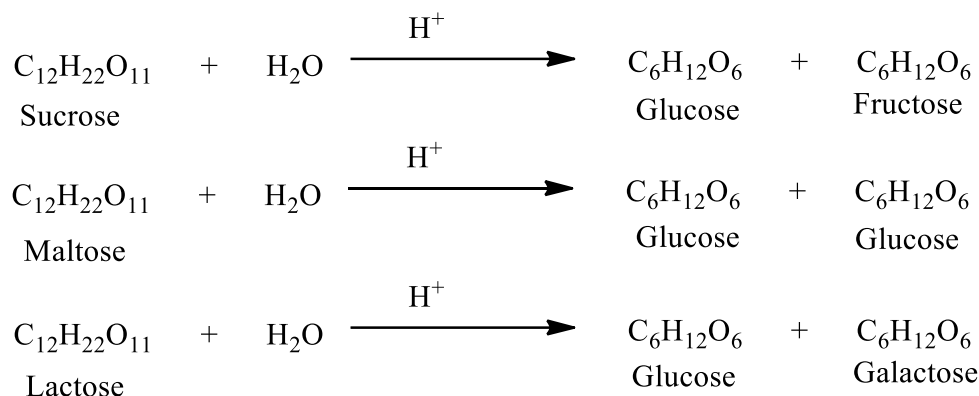
---

## **8.9. GENERAL STUDY OF DISACCHARIDES**

---

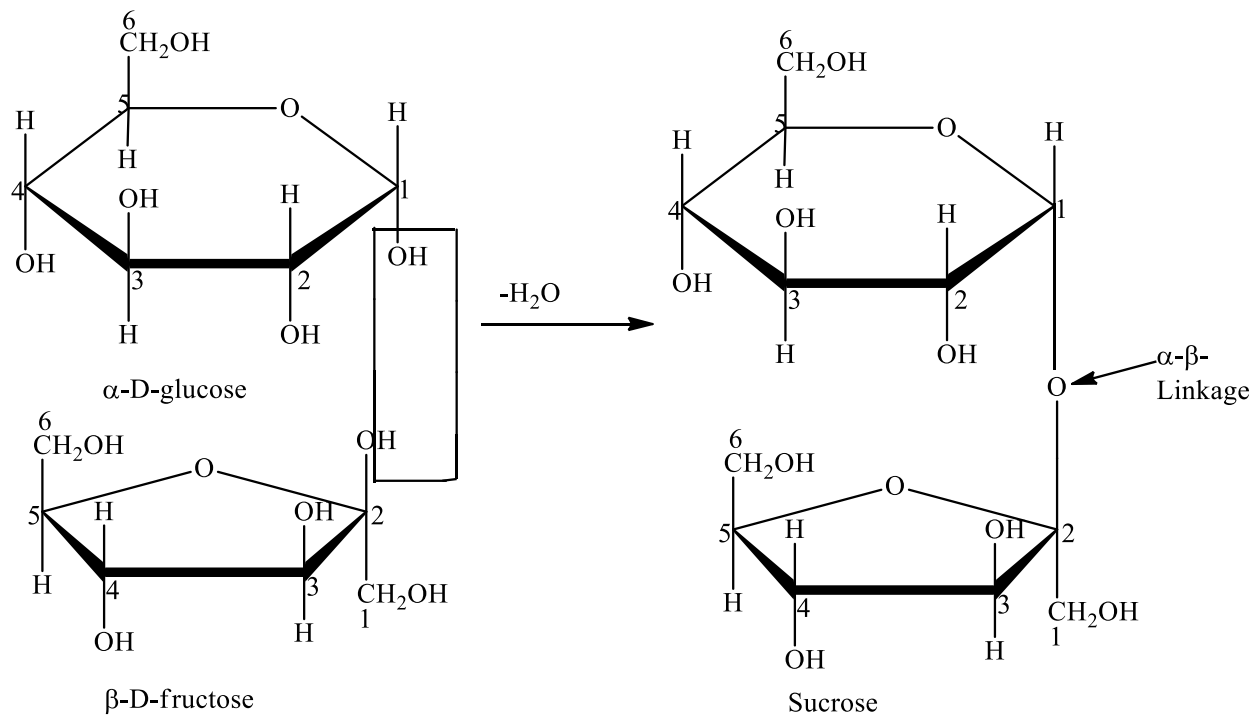
Disaccharides are the carbohydrates which on hydrolysis give two same or different monosaccharides. Their general formula is  $C_{12}H_{22}O_{11}$ . The important members belonging to disaccharides are sucrose, maltose, and lactose. On hydrolysis with dilute acids or enzymes these give the following two molecules of monosaccharides.





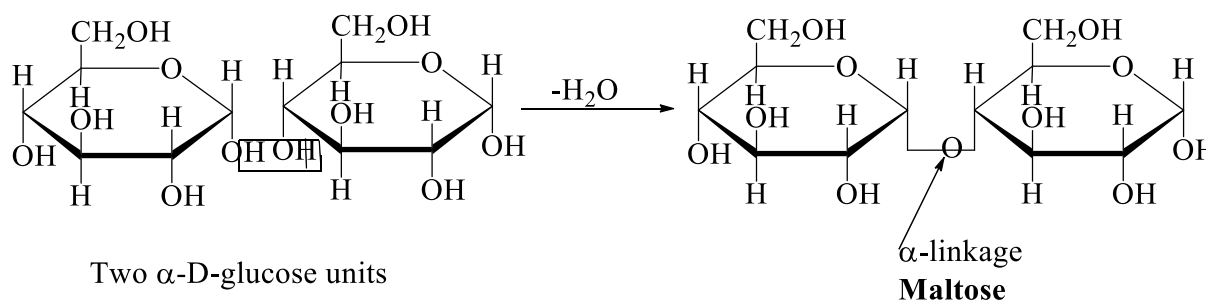
In disaccharides, the two monosaccharides are joined together by acetal or glycosidic formation. The hemiacetal OH of one monosaccharide and an OH of second monosaccharide, dehydrate to establish the bond (called glycosidic bond) between the two monosaccharides. That is, disaccharides are composed of two units of monosaccharides joined by glycosidic linkage.

**Sucrose (Cane Sugar).** Sucrose is ordinary table sugar. It is obtained from cane sugar. Sucrose is composed of  $\alpha$ -D-glucose and  $\beta$ -D-fructose unit. These units are joined by  $\alpha,\beta$ -glycosidic linkage between C-1 of glucose and C-2 of fructose unit.



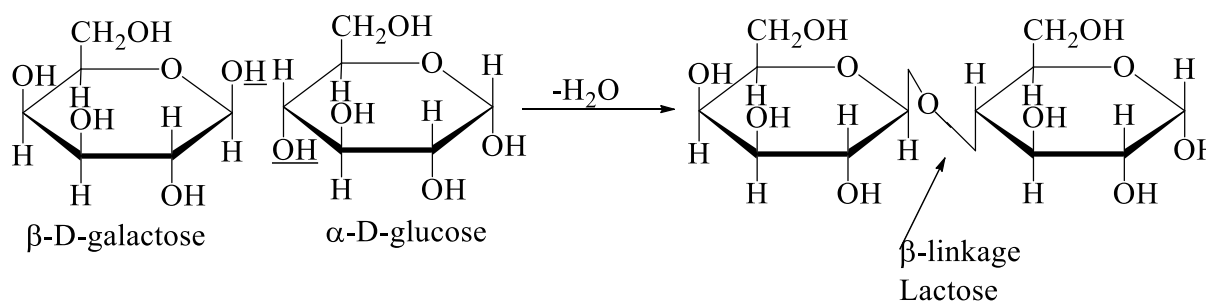
Notice that in the above structure of sucrose, hemiacetal structure is missing. That is why sucrose: (a) does not form an osazone with phenylhydrazine (b) does not reduce Tollen's reagent or Fehling's solution (sucrose is a non reducing sugar) (c) does not exhibit mutarotation.

**Maltose:** It is obtained from starch. It is composed of two  $\alpha$ -D-glucose units joined by a  $\alpha$ -glycosidic linkage between C-1 of one unit and C-4 of the other unit.



Notice that C-1 of the second glucose unit in the maltose structure is a hemiacetal carbon. Consequently, it is in equilibrium with the open chain aldehyde form. Thus maltose can exist in  $\alpha$  and  $\beta$  forms. Since it has a potential aldehyde group, maltose shows mutarotation, forms osazone and reduces Fehling's solution (Maltose is a reducing sugar).

**Lactose (Milk Sugar).** It is found in milk of all animals. Cow's milk contains 4-5 % and human milk 6-7 % lactose. Lactose is composed of  $\beta$ -D-galactose unit and  $\alpha$ -D-glucose unit joined by  $\beta$ -D-glycosidic linkage between C-1 of the galactose and C-4 of the glucose unit.

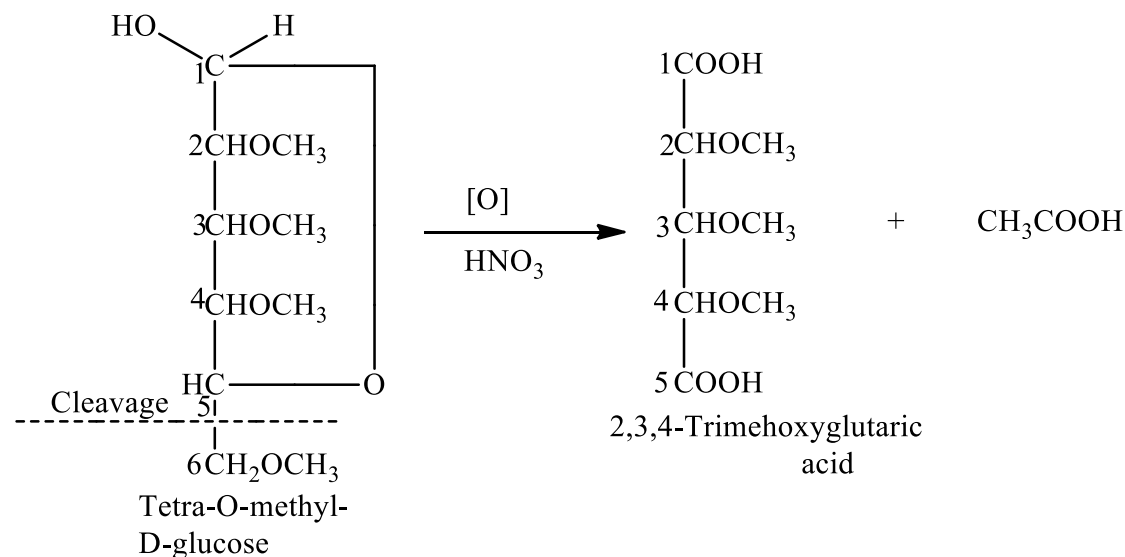


Like maltose, lactose can also exist in  $\alpha$  and  $\beta$  forms. Lactose is a reducing sugar and shows mutarotation. It reacts with Tollen's reagent and Fehling's solution.

**Determination of ring size of monosaccharides:**

So far we have represented structure of cyclic hemiacetals or anomers of D-glucose as having a ring of six members, five carbons and one oxygen. This has been proved to be correct and a five membered ring has been ruled out.

Hirst (1926) prepared tetra-O-methyl-D-glucose with dimethyl sulphate and subsequent acid hydrolysis of the pentamethyl derivative formed. The oxidation of tetra-O-methyl-D-glucose with nitric acid yielded trimethoxyglutaric acid.



Obviously, the two carboxylic carbons (1,5) of the trimethoxyglutaric acid are the one's originally involved in ring formation. Hence, there must have existed an oxide ring between C-1 and C-5. Tracing back the reaction sequence, it stands proved that D-glucose has a six membered ring. The presence of a 6-membered ring in D-glucose has also been confirmed by X-ray analysis.

### **SUCROSE, Cane Sugar, (C<sub>12</sub>H<sub>22</sub>O<sub>11</sub>):**

Sucrose is ordinary table sugar. It occurs chiefly in sugar cane and sugar beets. In smaller amounts it is present in maple sap, honey, and several fruits.

### **Manufacture of Sucrose (Table Sugar):**

In India and other tropical countries, the main source of sucrose is sugar cane. The modern method for the manufacture of 'Direct Consumption' sugar from cane consists of the following steps. (Fig 8.1).

**(1) Juice Extraction.** The crushed cane is passed through a roller mill to squeeze out juice. The partially exhausted 'cane mat' emerging from the mill is passed on to a tank, called Diffuser, by a chain conveyer. Here the maximum extraction of sucrose is done by washing with hot water and dilute juice on counter-current principle. This technique gets sugar extraction upto 98%. The cellulosic material discharged from the diffuser is called Bagasse and is used as fuel under boilers.

**(2) Juice Purification:** The raw juice contains 14-25% sucrose and much impurity such as organic acids, inorganic salts. Proteins and colouring matter. It is purified by the operations listed below:

**(i) Defecation:** The juice is heated with high pressure steam and treated with 2-3 % lime in a steel tank. This operation called defecation throws out organic acids as insoluble calcium salts, coagulated protein and colouring matter. The precipitate is removed by filtration.

**(ii) Carbonation:** Through the filtered juice is then  $\text{CO}_2$ . This operation known as carbonation, removes the excess, of lime as calcium carbonate which entraps colouring matter, colloidal and some inorganic salts. The 'mud' that settles is separated by filtration.

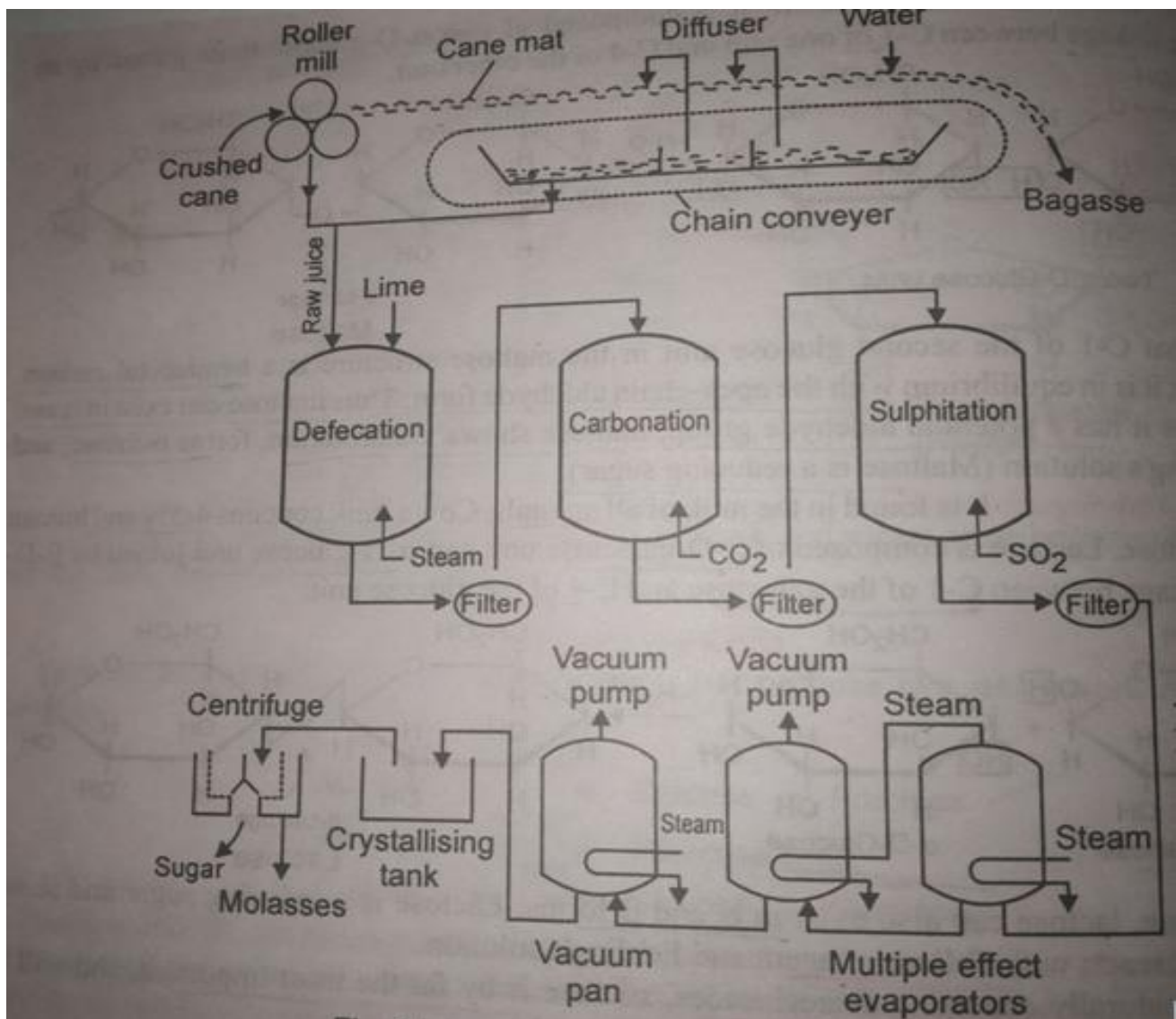
**(iii) Decolorisation:** In India, the clarified juice is decolorized by treating with  $\text{SO}_2$ . This operation called Sulphitation while it bleaches the brown colour of the juice, completes the neutralization of lime. The insoluble calcium sulphite is removed by filtration.

**(3) Concentration and Crystallisation:** The clear solution is then concentrated by boiling under reduced pressure in Multiple Effect Evaporators. In these, the steam produced in the first evaporator is used to boil the juice in the second maintained at a lower pressure; the second being used to boil the juice in the third kept at a still lower pressure; and son on.

The concentrated juice is finally passed to the Vacuum Pan where further evaporation reduces the water content to 6-8%. Here partial separation of crystals takes place. The mixture of

syrup and crystals, known as Massecuite, is then discharged into a large tank, the Crystallising Tank, fitted with cooling pipes. The crystals grow and form a thick crop.

**(4) Separation of Crystals by Centriguagation, and Drying.** The massecuite is then sent to centrifuges wherby sugar crystals are separated from the syrup. The crystals are here sprinkled with a little water to wash any syrup sticking to the surface. The wet sugar is dried by passing down a rotating drum with stream of hot air flowing counter-current to it. The residual mother liquor, from which the crystals have been removed, is called molasses. In India, it is valuble raw material for alcohol manufacture by fermentation.



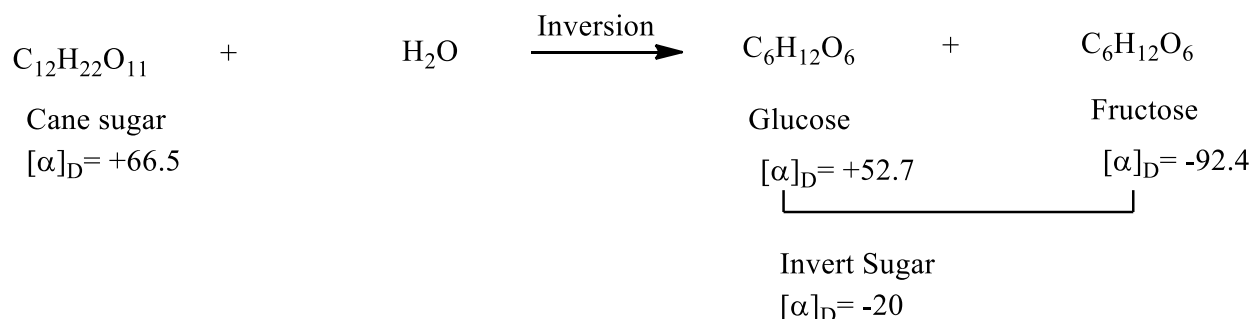
**Fig 8.1. sugar manufacture (Flow sheet)**

### Properties of Cane Sugar, $C_{12}H_{22}O_{11}$ :

1. It is colourless, crystalline substance, sweet in taste. It is very soluble in water and the solution is dextrorotatory  $[\alpha]_D = +66.5$ .
2. Effect of heat. Sucrose on heating slowly and carefully melts and then if allowed to cool, it solidifies to pale-yellow glassy mass called 'barley sugar'.

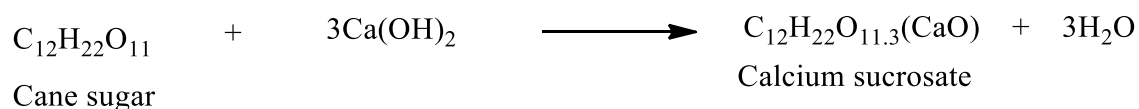
When heated to 473K, it loses water to form a brown amorphous mass called caramel. On strong heating it chars to almost pure carbon giving characteristic smell of burnt sugar.

3. Hydrolysis or Inversion of Sucrose (Sugar). Sucrose when boiled with mineral acids, or by the enzyme invertase, yields an equimolar mixture of glucose and fructose.



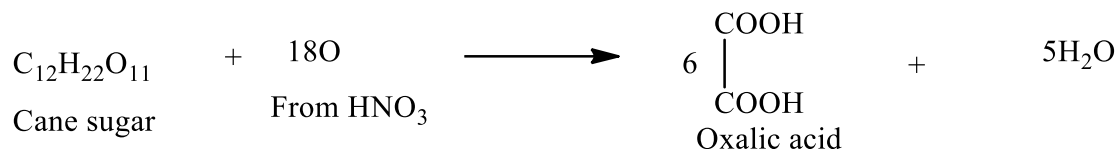
Sucrose is dextrorotatory and on hydrolysis produces dextrorotatory glucose and laevorotatory fructose. With greater laevorotation of fructose the mixture is laevorotatory. Thus, there is a change (inversion) in the direction of rotation of the reaction mixture from dextro to laevo. This phenomenon is called inversion and the enzyme which brings about this inversion is called invertase.

4. **Formation of Sucrosates:** Sucrose solution reacts with calcium, barium and strontium hydroxides to form sucrosates.

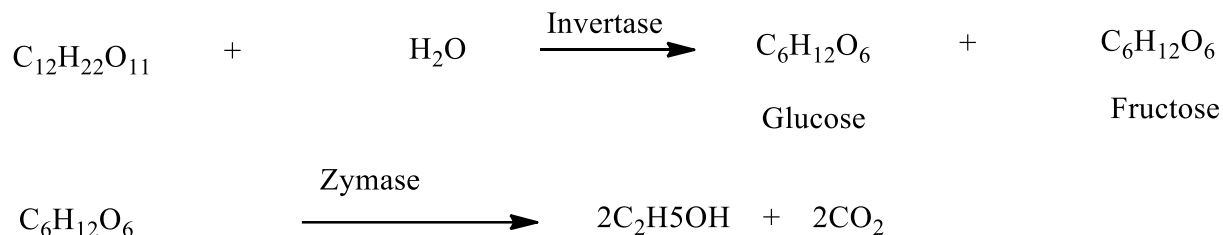


The sucrosate decomposes when carbon dioxide is passed in the solution.

5. **Action of nitric acid:** Concentrated nitric acid oxidizes cane sugar to oxalic acid.



6. **Fermentation:** Fermentation of Sucrose is brought about by yeast when the enzymes invertase hydrolysed sucrose to glucose and fructose and zymase converts them to ethyl alcohol.




---

## ***8.10. GENERAL INTRODUCTION OF STRUCTURE OF RIBOSE AND DEOXYRIBOSE***

---

Ribose and deoxyribose are two well known aldopentoses. Their structures are discussed as under.

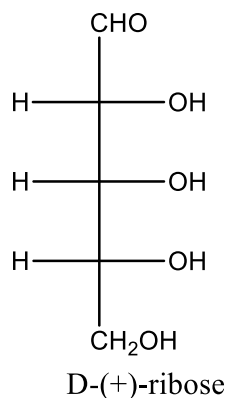
### **Structure of D-(+)- Ribose:**

D-(+)- Ribose occurs naturally in plant nucleic acids and in liver and pancreas nucleic acids. It gives properties similar to glucose.

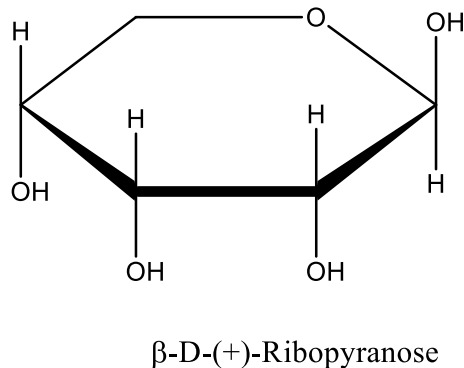
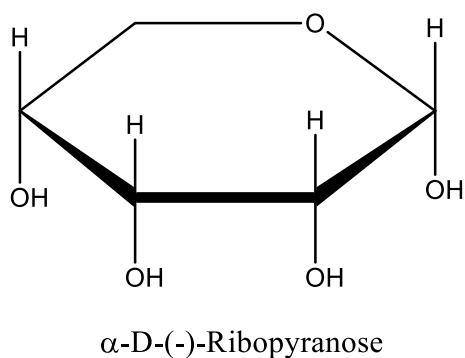
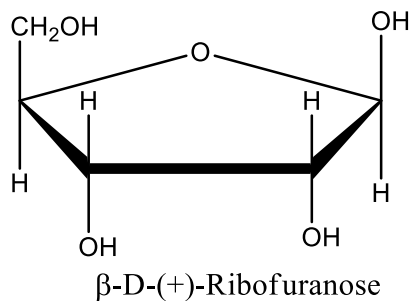
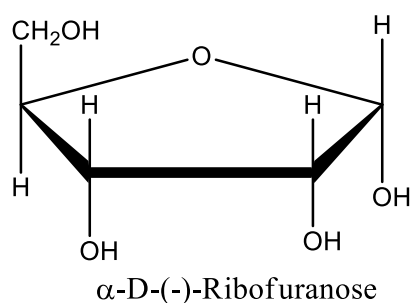
Ribose has the molecular formula (C<sub>5</sub>H<sub>10</sub>O<sub>5</sub>) and shows the presence of an aldehyde group, four hydroxyl groups (one primary and three secondary) and a straight chain of carbon atoms. Therefore, it was assigned an open chain formula as given below:



The configuration of D-ribose has been established as follows.



As in the case of glucose, D-ribose is now assigned a ring structure and is known to exist both in furanose and pyranose forms as depicted below:



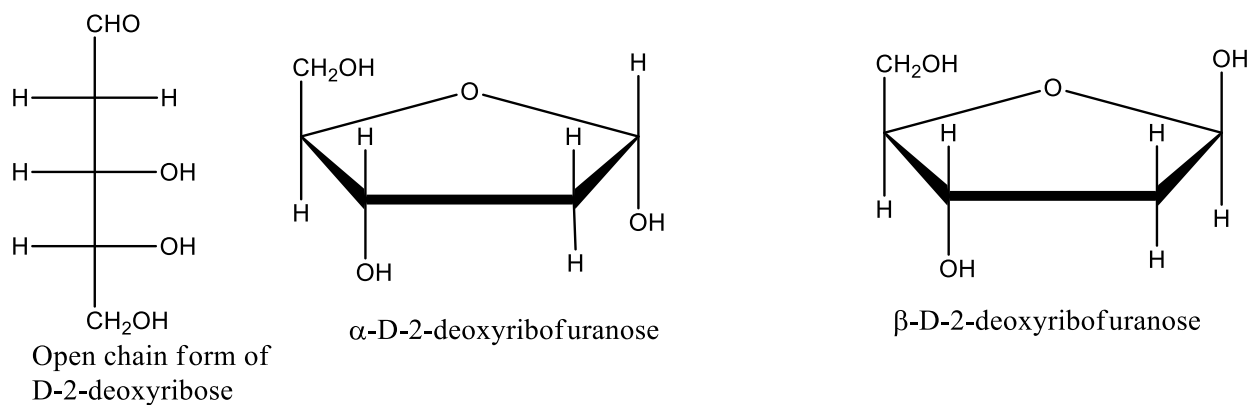
Pyranose form is more stable than the furanose form. Equilibrium mixture of ribose contains 56%  $\beta$ -D-ribopyranose 20%  $\alpha$ -D-ribopyranose, 18%  $\beta$ -D-ribofuranose and 6%  $\alpha$ -D-ribofuranose. In RNA ribose is present in furanose form.

### Structure of deoxyribose:



In this aldopentose the hydroxyl group at C-2 of ribose has been replaced by hydrogen. That is why it is named as deoxyribose. It is fundamental constituent of deoxyribonucleic acid (DNA).

The structure of D-2-deoxyribose is derived from that of D-ribose and may be represented in the open chain and ring forms as follows.




---

## 8.11 GENERAL STUDY OF POLYSACCHARIDES

---

These are neutral polymeric compounds in which hundreds or even thousands of monosaccharide units are joined by glycosidic linkages. They have the general formula  $(C_5H_{10}O_5)_n$ , where n has very large value. They are colourless, tasteless and are insoluble in water. They play very important role in plant and animal life as food storage and structural role. They are usually made up of pentoses or hexoses. The important polysaccharides are cellulose, starch, glycogen and dextrans.

### Starch:

Starch is most widely distributed in vegetable kingdom. In nature, it is transformed into complex polysaccharides like gum and cellulose and into simpler mono and disaccharides by enzymes working in vegetable kingdom. Its rich sources are potatoes, wheat, maize, rice, barley and arrow root. It is interesting to note that no two sources give identical starch.

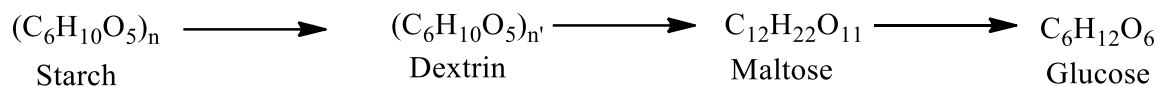
### Physical properties:

It is a white, amorphous substance with no taste or smell. It is insoluble in water but when starch is added to boiling water the granules swell and burst forming colloidal, translucent suspension.

**Chemical properties of starch:**

(i) When heated to a temperature between 200-250<sup>0</sup> it changes into dextrin. At higher temperature charring takes place.

(ii) Starch, when boiled with dilute acids, yielded ultimately glucose



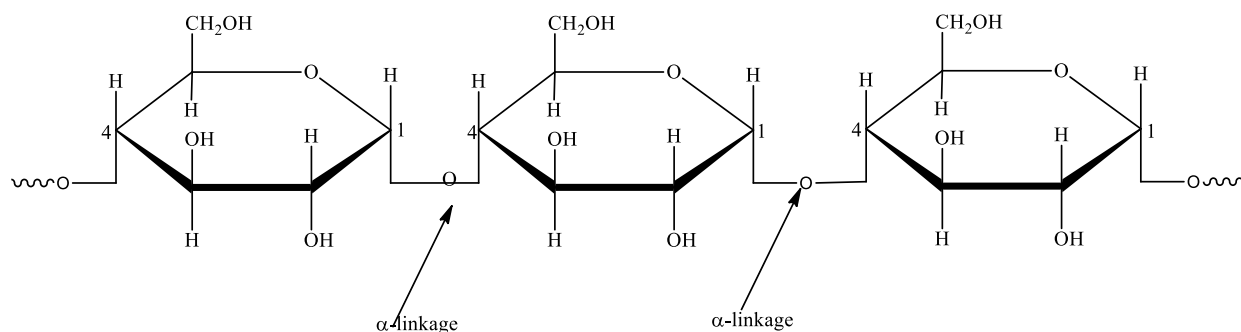
When hydrolysed with enzyme diastase, maltose is obtained.

(iii) Starch solution gives a blue colour with a drop of iodine solution. The blue Colour disappears on heating and reappears on cooling. In fact it is the amylose that gives colour with iodine; the amylopectin gives a red brown colour with iodine.

Starch is a non reducing saccharide. It does not reduce Fehling's solution or Tollen's reagent. It also does not form an osazone indicating that all hemiacetal hydroxyl groups of glucose units (C<sub>1</sub>) are not free but are linked with glycosidic linkages.

Starch is polymer of  $\alpha$ -D-glucose and consists of two components (15-20%) amylose and 80-85%) amylopectin.

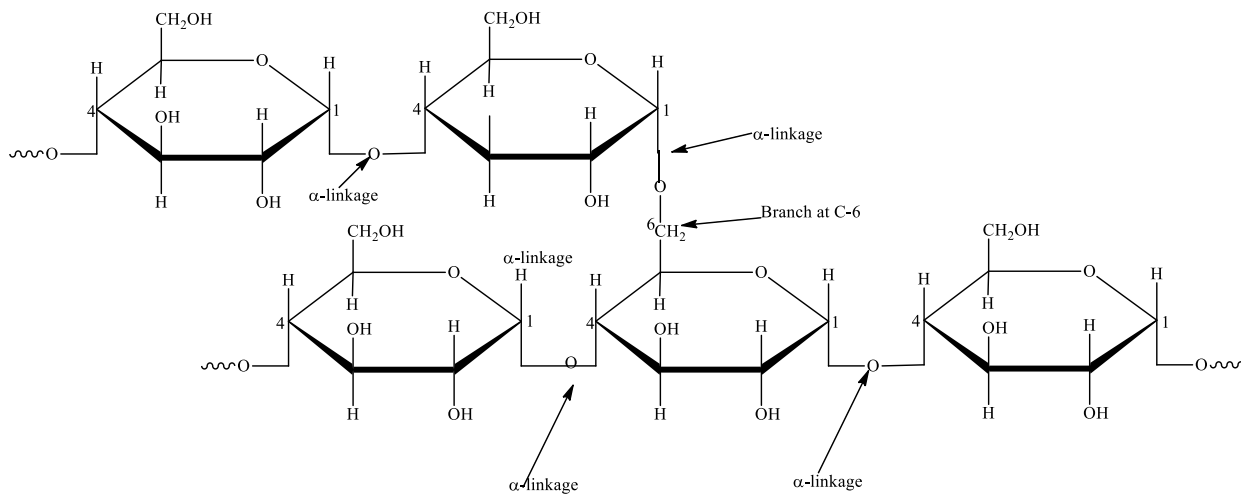
(i) **Amylose.** It is white soluble fraction. It is linear polymer of  $\alpha$ -D-glucose. It contains about 200-1000  $\alpha$ -D-glucose units which are linked to one another through  $\alpha$ -glycosidic linkage involving C-1 of one glucose and C-4 of the next as shown below.



Amylose

Its molecular mass can range from 10, 0000 to 500,000.

**(ii) Amylopectin.** It is water insoluble fraction. It is a highly branched chain polymer which does not give blue colour with iodine. It consists of a large number of short chains of 25-30 D-glucose units. In this case the main chain involves  $\alpha$ -linkages between C-1 of one  $\alpha$ -D-glucose unit and C-4 of the other. The C-1 of terminal glucose in each chain is further linked to C-6 of the other glucose unit in the next chain through C-1-C-6  $\alpha$ -linkage. This gives highly branched structure.



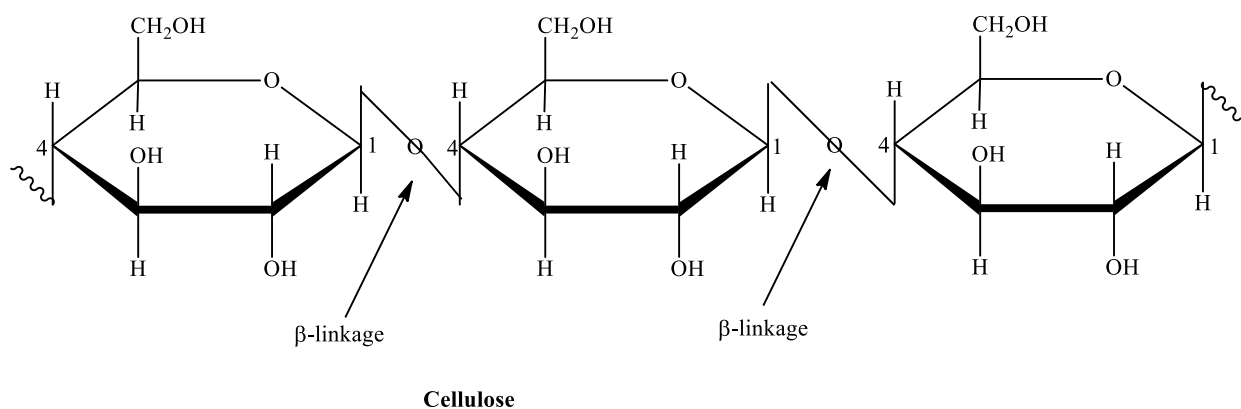
Amylopectin

Starch is used as the principal food storage of glucose energy. It is hydrolysed by enzyme amylase present in saliva. The end product of glucose which is an essential nutrient.

## Cellulose

Cellulose is the main structural material of trees and other plants. Wood is 50% cellulose, while cotton wool is almost pure cellulose. Other sources of cellulose are straw, corncobs, bagasse, and similar agriculture wastes.

**Manufacture:** Cotton wool is about 97% cellulose. It is ready for use after washing away the waxes and fats associated with it. The cellulose required for making paper is obtained from wood. Lignin and resinous substances present along with cellulose are removed by digesting the wood chips under pressure with a solution calcium hydrogen sulphite. The cellulose separates as insoluble fibres which are washed with water, bleached and dried.



**Structure.** Cellulose is a straight chain polysaccharide composed of D-glucose units. These units are joined by β-glycosidic linkages between C-1 of one glucose unit and C-4 of the next glucose unit. The number of D-glucose units in cellulose ranges from 300-2500.

**Properties:** Cellulose is a colourless amorphous solid having no m.p. it decomposes on strong heating. It is insoluble in water and most organic solvents. However, it dissolves in S. reagent which is an ammoniacal solution of cupric hydroxide.

**Hydrolysis:** Cellulose when hydrolysed by heating with dilute acids, gives D-glucose. Cellobiose is formed in case of incomplete hydrolysis.

The cattle, goats, and other ruminants have digestive enzymes (Cellulases) capable of hydrolyzing cellulose into glucose. Consequently, these can feed directly on cellulose. Man and many other mammals lack the necessary enzymes in their digestive tract, and they cannot use cellulose as foodstuff.

---

## **8.12. SUMMARY**

---

- Glyceraldehydes are the simplest carbohydrate and it serves as a reference molecule to write the configuration (D and L) of all other monosaccharides.
- The pair of enantiomers with similar groups on the same side of the carbon chain is called the erythro enantiomers while pair of enantiomers with similar groups on opposite sides is called the threo enantiomers.
- Mutarotation is defined as the interconversion of  $\alpha$  and  $\beta$  anomeric forms with the change in the optical rotation.
- Disaccharides are the carbohydrates which on hydrolysis give two same or different monosaccharides.
- Disaccharides are composed of two units of monosaccharides joined by glycosidic linkage.
- Polysaccharides are neutral polymeric compounds in which hundreds or even thousands of monosaccharide units are joined by glycosidic linkages.

---

## **8.13. MODEL EXAMINATION QUESTIONS**

---

1. How will you convert glucose into fructose?
2. Discuss the mechanism of mutarotation.
3. How is sucrose manufactured from sugar cane.
4. Discuss the structure of sucrose, lactose and maltose.
5. Write a short note on polysaccharides

---

## **REFERENCES**

---

1. A text book of organic chemistry, A. Bahl and B.S.Bahl, S.Chand & Compant Ltd.
2. Chemistry for degree students, R.L.madan, S.Chand & Compant Ltd.
3. Organic chemistry, Vol.III, Jagdamba singh and L.D.S Yadav, Prgati Prakashan.
4. Modern chemistry, S.P.Jauhar, Modern Publishers.
5. Organic chemistry, Francis A.Carey, Tata McGraw-Hill Company Ltd.

UNIT WRITER- Dr. Devendra Singh Dhami ,Department of Chemistry SSJ Campus, Almora



# Microbe Notes

☰ Menu

Search Notes 🔍

[Home](#) » [Molecular Biology](#)

## Different forms of DNA- A form, B form, Z form

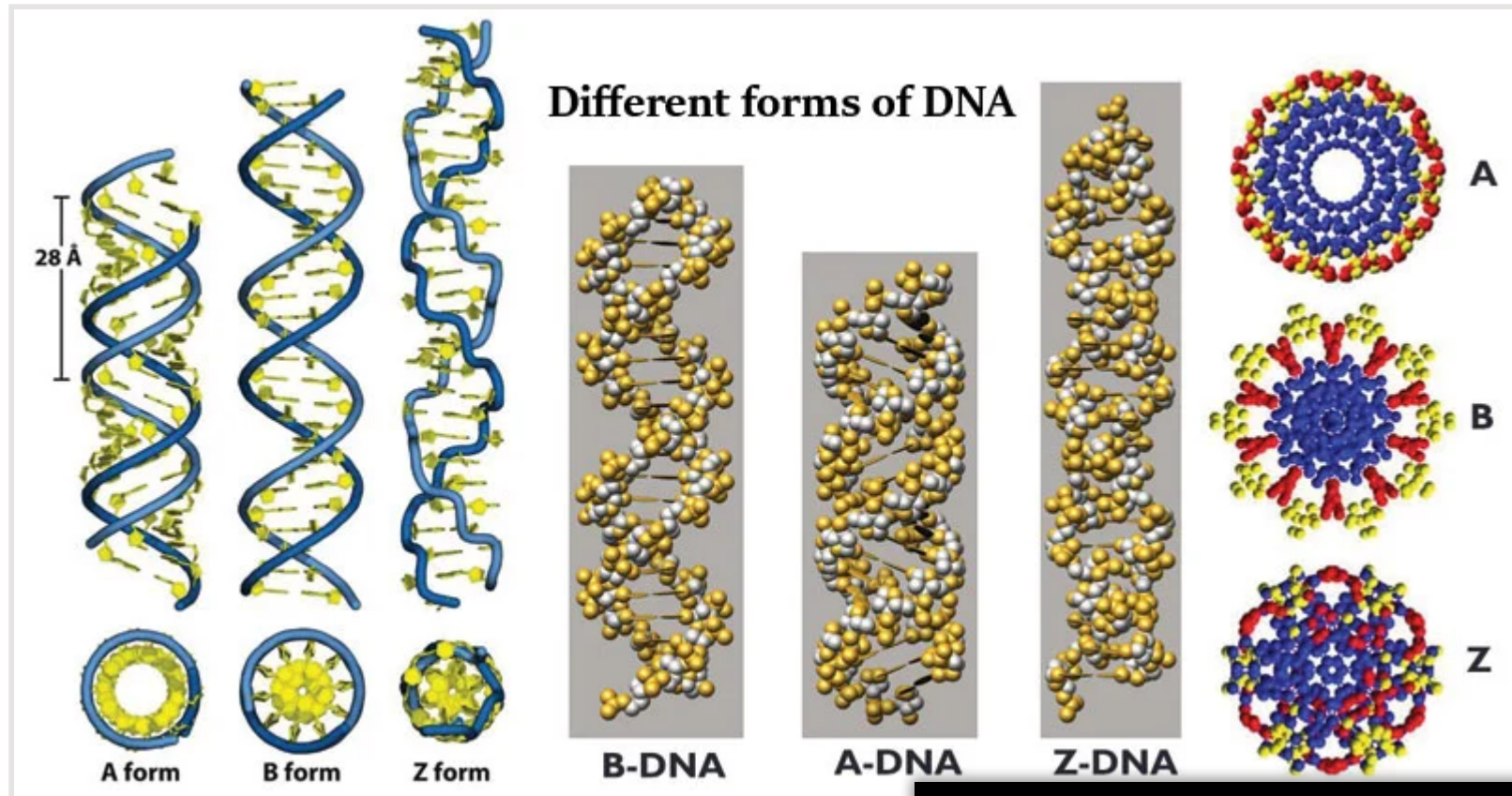
April 8, 2022 by Sagar Aryal

Edited By: [Sagar Aryal](#)

- The right-handed double-helical **Watson – Crick Model** for B-form DNA is the most commonly known DNA structure.
- In addition to this classic structure, several other forms of DNA have been observed.
- The helical structure of DNA is thus variable and depends on the sequence as well as the environment

CDC Issues Monkeypox Warning to 'Practice En...





## Table of Contents



[Why do different forms of DNA exist?](#)

[B-form DNA](#)

[A-form DNA](#)

[Z-form DNA](#)

[Conditions Favoring A-form, B-form, and Z-form of DNA](#)

[Other rare forms of DNA](#)

[References](#)

CDC Issues Monkeypox Warning to 'Practice En...





## Why do different forms of DNA exist?

- There is simply not enough room for the DNA to be stretched out in a perfect, linear B-DNA conformation. In nearly all cells, from simple bacteria through complex eukaryotes, the DNA must be compacted by more than a thousand fold in order even to fit inside the cell or nucleus.
- Refined resolution of the structure of DNA, based on X-ray crystallography of short synthetic pieces of DNA, has shown that there is a considerable variance of the helical structure of DNA. A 200-bp piece of DNA can run as if it were more than 1000 bp on an average. The double helix is not the same uniform structure.

## The Different Forms of DNA

CDC Issues Monkeypox Warning to 'Practice En...





---

## B-form DNA

---

- B-DNA is the Watson–Crick form of the double helix that most people are familiar with.
- They proposed two strands of DNA — each in a right-hand helix — wound around the same axis. The two strands are held together by H-bonding between the bases (in anti-conformation).
- The two strands of the duplex are antiparallel and plectonemically coiled. The nucleotides arrayed in a 5' to 3' orientation on one strand align with complementary nucleotides in the 3' to 5' orientation of the opposite strand.
- Bases fit in the double helical model if pyrimidine on one strand is always paired with purine on the other. From Chargaff's rules, the two strands will pair A with T and G with C. This pairs a keto base with an amino base, a purine with a pyrimidine. Two H-bonds can form between A and T, and three can form between G and C.
- These are the complementary base pairs. The base-pairing scheme :  
copy the genetic information.
- 34 nm between bp, 3.4 nm per turn, about 10 bp per turn
- 9 nm (about 2.0 nm or 20 Angstroms) in diameter.
- 34° helix pitch; -6° base-pair tilt; 36° twist angle

CDC Issues Monkeypox Warning to 'Practice En...



## A-form DNA

- The major difference between A-form and B-form nucleic acid is in the conformation of the deoxyribose sugar ring. It is in the C2' endoconformation for B-form, whereas it is in the C3' endoconformation in A-form.
- A second major difference between A-form and B-form nucleic acid is the placement of base-pairs within the duplex. In B-form, the base-pairs are almost centered over the helical axis and further from the central axis and closer to the major groove. The result is a compact core in A-form.
- Right-handed helix
- 11 bp per turn; 0.26 nm axial rise; 28° helix pitch; 20° base-pair tilt
- 33° twist angle; 2.3nm helix diameter

CDC Issues Monkeypox Warning to 'Practice En...



## Z-form DNA

- Z-DNA is a radically different duplex structure, with the two strands coiling in left-handed helices and a pronounced zig-zag (hence the name) pattern in the phosphodiester backbone.
- Z-DNA can form when the DNA is in an alternating purine-pyrimidine sequence such as GCGCGC, and indeed the G and C nucleotides are in different conformations, leading to the zig-zag pattern.
- The big difference is at the G nucleotide.
- It has the sugar in the C3' endoconformation (like A-form nucleic acid) and the guanine base is in the synconformation.
- This places the guanine back over the sugar ring, in contrast to the anti-conformation in the B-form nucleic acid. Note that having the base in the anticonformation places the base in the major groove, which bonds with the complementary base on the opposite strand.
- The duplex in Z-DNA has to accommodate the distortion of this G nucleotide in the synconformation. The cytosine in the adjacent nucleotide of Z-DNA is in the "normal" C2' endo, anticonformation.

CDC Issues Monkeypox Warning to 'Practice En...



- Discovered by Rich, Nordheim & Wang in 1984.
- It has antiparallel strands as B-DNA.
- It is long and thin as compared to B-DNA.
- 12 bp per turn; 0.45 nm axial rise; 45° helix pitch; 7° base-pair tilt
- -30° twist angle; 1.8 nm helix diameter

## Conditions Favoring A-form, B-form, and Z-form of DNA

- Whether a DNA sequence will be in the A-, B- or Z-DNA conformation
- The first is the ionic or hydration environment, which can facilitate
- A-DNA is favored by low hydration, whereas Z-DNA can be favored
- The second condition is the DNA sequence: A-DNA is favored by ce

whereas Z-DNA can be most readily formed by alternating purine-pyrimidine steps.

CDC Issues Monkeypox Warning to 'Practice En...



- The third condition is the presence of proteins that can bind to DNA in one helical conformation and force the DNA to adopt a different conformation, such as proteins which bind to B-DNA and can drive it to either A-or Z forms.
- In living cells, most of the DNA is in a mixture of A and B-DNA conformations, with a few small regions capable of forming Z-DNA.

**Subscribe us to receive latest notes.**

**Email Address\***

Subscribe

## Other rare forms of DNA

### C-DNA

- Formed at 66% relative humidity and in presence of  $\text{Li}^+$  and  $\text{Mg}^{2+}$  ions.
- Right-handed with the axial rise of  $3.32\text{\AA}$  per base pair
- 9.33 base pairs per turn

CDC Issues Monkeypox Warning to 'Practice En...



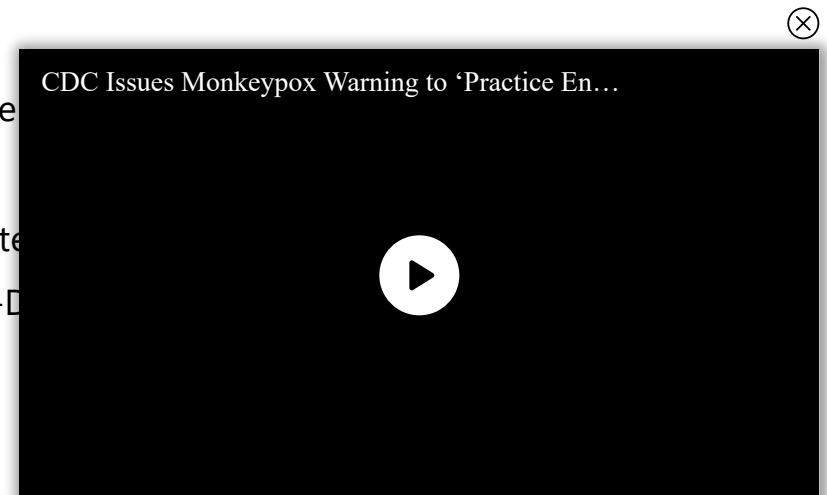
- Helical pitch  $3.32\text{A}^\circ \times 9.33^\circ\text{A} = 30.97\text{A}^\circ$ .
- Base pair rotation =  $38.58^\circ$ .
- Has a diameter of  $19\text{A}^\circ$ , smaller than that of A-&B- DNA.
- The tilt of base is  $7.8^\circ$

## D-DNA

- Rare variant with 8 base pairs per helical turn
- These forms of DNA found in some DNA molecules devoid of guanine.
- The axial rise of  $3.03\text{A}^\circ$  per base pairs
- The tilt of  $16.7^\circ$  from the axis of the helix.

## E- DNA

- Extended or eccentric DNA.
- E-DNA has a long helical axis rise and base perpendicular to the helical axis.
- Deep major groove and the shallow minor groove.
- E-DNA allowed to crystallize for a period time longer, the methylated DNA.
- E-DNA is the intermediate in the crystallographic pathway from B-DNA to A-DNA.



## Read Also:

- [Amazing 27 Things Under The Microscope With Diagrams](#)
- [Bacteria- Definition, Structure, Shapes, Sizes, Classification](#)
- [Prokaryotes vs. Eukaryotes \(47 Key Differences\)](#)
- [Microbiology of Extreme Environments \(Types and Examples\)](#)
- [Plant Cell- Definition, Structure, Parts, Functions, Labeled Diagram](#)

---

## References

---

1. [https://www.researchgate.net/publication/10837288\\_A\\_glossary\\_of](https://www.researchgate.net/publication/10837288_A_glossary_of)
2. <http://people.bu.edu/mfk/restricted566/dnastructure.pdf>
3. Alberts, B., Johnson, A., Lewis, J., Raff, M., Roberts, K., & Walter, P. (2002). *Molecular biology of the cell*. New York: Garland Science.
4. <http://www.newworldencyclopedia.org/entry/Deoxyribose>





5. <https://www.nature.com/scitable/definition/phosphate-backbone-273>
6. <http://www.newworldencyclopedia.org/entry/Deoxyribose>
7. <https://www.slideshare.net/vinithaunnikrishnan16/forms-of-dna-49312507>
8. David Hames and Nigel Hooper (2005). Biochemistry. Third ed. Taylor & Francis Group: New York.
9. Bailey, W. R., Scott, E. G., Finegold, S. M., & Baron, E. J. (1986). Bailey and Scott's Diagnostic microbiology. St. Louis: Mosby.
10. [https://bio.libretexts.org/Bookshelves/Genetics/Book%3A\\_Working\\_with\\_Molecular\\_Genetics\\_\(Hardison\)/Unit\\_I%3A\\_Genes%2C\\_Nucleic\\_Acids%2C\\_Genomes\\_and\\_Chromosomes/2%3A\\_Structures\\_of\\_Nucleic\\_Acids/2.5%3A\\_B-Form%2C\\_A-Form%2C\\_and\\_Z-Form\\_of\\_DNA](https://bio.libretexts.org/Bookshelves/Genetics/Book%3A_Working_with_Molecular_Genetics_(Hardison)/Unit_I%3A_Genes%2C_Nucleic_Acids%2C_Genomes_and_Chromosomes/2%3A_Structures_of_Nucleic_Acids/2.5%3A_B-Form%2C_A-Form%2C_and_Z-Form_of_DNA)
11. <http://eagri.org/eagri50/GBPR111/lec15.pdf>

## About Author



### Sagar Aryal

Sagar Aryal is a microbiologist and a scientific blogger. He attended ...  
Nepal, to complete his Master of Science in Microbiology. He worked

Kathmandu, Nepal, from Feb 2015 to June 2019. After teaching microbiology for more than four years, he joined the Central Department of Microbiology, Tribhuvan University, to pursue his Ph.D. in collaboration with Helmholtz-Institute for Pharmaceutical Research Saarland (HIPS), Saarbrücken, Germany. He is interested in research on

CDC Issues Monkeypox Warning to 'Practice En...



actinobacteria, myxobacteria, and natural products. He has published more than 15 research articles and book chapters in international journals and well-renowned publishers.

## 8 thoughts on "Different forms of DNA- A form, B form, Z form"

### Andy Carter

April 5, 2023 at 10:46 PM

Under C-DNA you say there are 33bp per turn. That should be 9.33bp per turn.

[Reply](#)

### Sagar Aryal

April 6, 2023 at 12:17 PM

Thanks, it has been corrected. 😊

[Reply](#)

CDC Issues Monkeypox Warning to 'Practice En...



**BUDHDEV PRAKASH PURTY**

July 21, 2021 at 12:20 PM

I was in need of a lot of help but after I got it reading Thanks a lot of

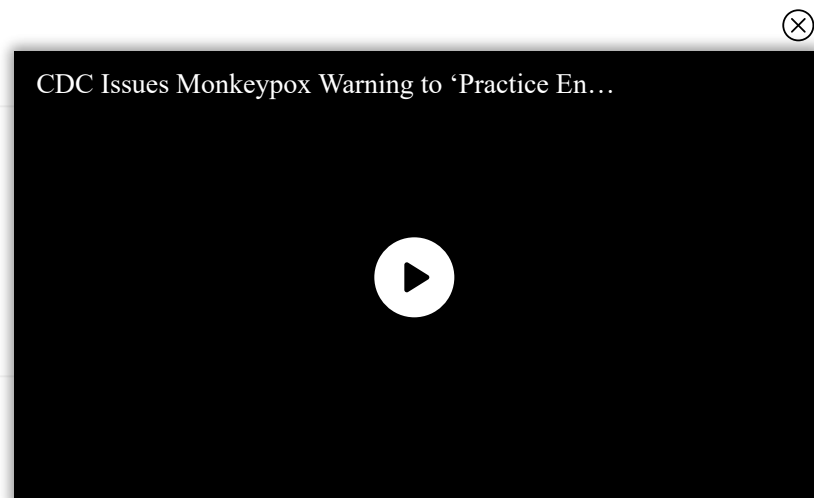
[Reply](#)

**Ahmed Gharib**

May 16, 2021 at 8:12 PM

Do you have PPTs for your syllabus?

[Reply](#)



**Vamsi Krishna**

October 30, 2020 at 3:14 PM

You are very helpful during the exams

[Reply](#)

**Naaz**

February 26, 2020 at 4:47 PM

wow...thank you so much ..this is very helpful ...

[Reply](#)

**Victor Maliti**

August 8, 2019 at 1:06 PM

Educative!

[Reply](#)



**Ahmed Gharib**

May 16, 2021 at 8:13 PM

Very Educative

[Reply](#)

### Leave a Comment

⊗

CDC Issues Monkeypox Warning to ‘Practice En...

▶

Name \*

Save my name, email, and website in this browser for the next time I comment.

This site uses Akismet to reduce spam. [Learn how your comment data is processed.](#)

## Topics / Categories

[Agricultural Microbiology](#) (14)

[Bacteriology](#) (117)

[Basic Microbiology](#) (54)

[Biochemical Test](#) (113)

[Biochemistry](#) (94)

[Biotechnology](#) (9)

[Cell Biology](#) (55)

[Culture Media](#) (64)

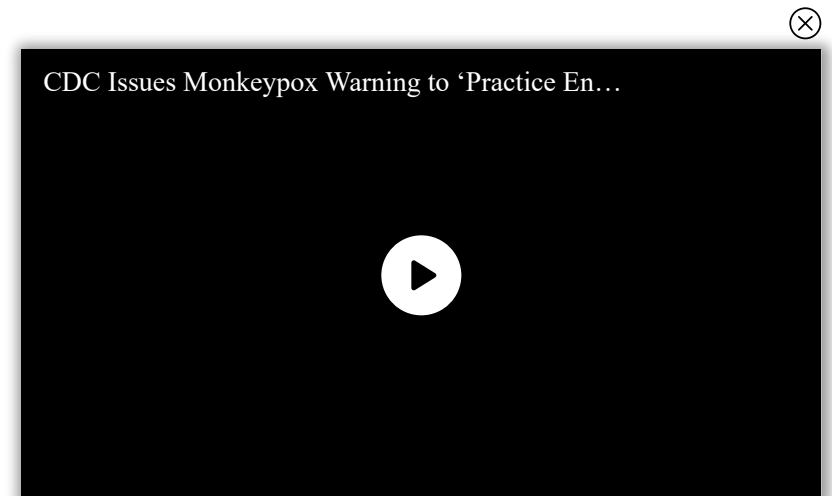
[Difference Between](#) (39)

[Diseases](#) (26)

[Environmental Microbiology](#) (4)

[Food Microbiology](#) (45)

[Immunology](#) (116)



[Instrumentation \(57\)](#)

[Microscopy \(21\)](#)

[Molecular Biology \(68\)](#)

[Mycology \(31\)](#)

[Parasitology \(23\)](#)

[Pharmacology \(14\)](#)

[Phycology \(2\)](#)

[Staining \(29\)](#)

[Virology \(47\)](#)

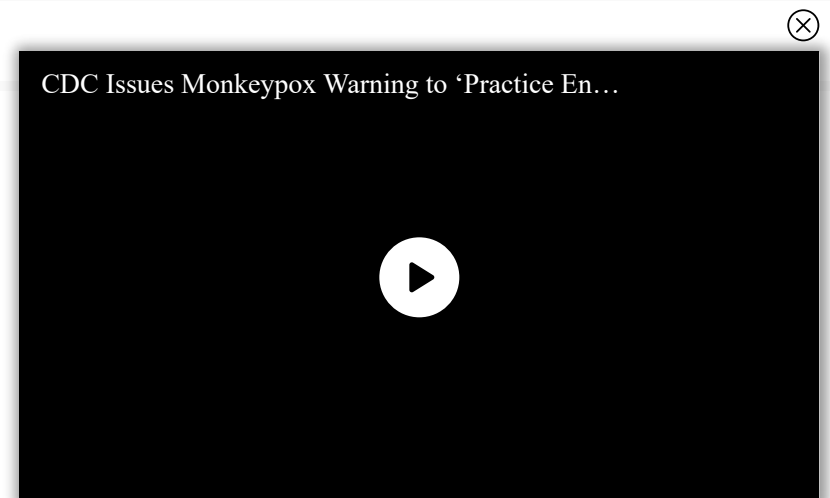
[Single Cell Protein \(SCP\): Microbes, Production, Uses](#)

[Real-Time PCR: Principle, Process, Markers, Uses](#)

[Cell Organelles: Definition, Structure, Functions, Diagram](#)

[HPLC: Principle, Parts, Types, Uses, Diagram](#)

[Serial Dilution: Formula, Calculator, Procedure, Uses](#)



## Read Also

[Amazing 27 Things Under The Microscope With Diagrams](#)

[Bacteria- Definition, Structure, Shapes, Sizes, Classification](#)

[Prokaryotes vs. Eukaryotes \(47 Key Differences\)](#)

[Microbiology of Extreme Environments \(Types and Examples\)](#)

[Plant Cell- Definition, Structure, Parts, Functions, Labeled Diagram](#)

[Our Team](#)

[About Us](#)

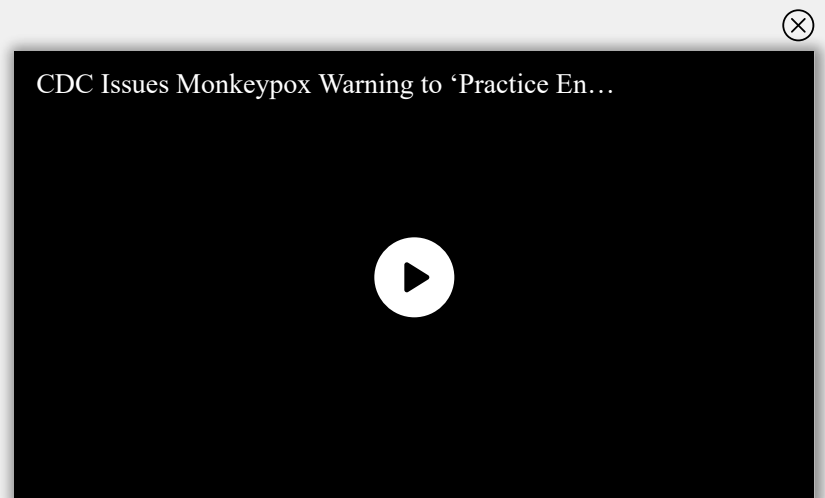
[Contact Us](#)

[Privacy Policy](#)

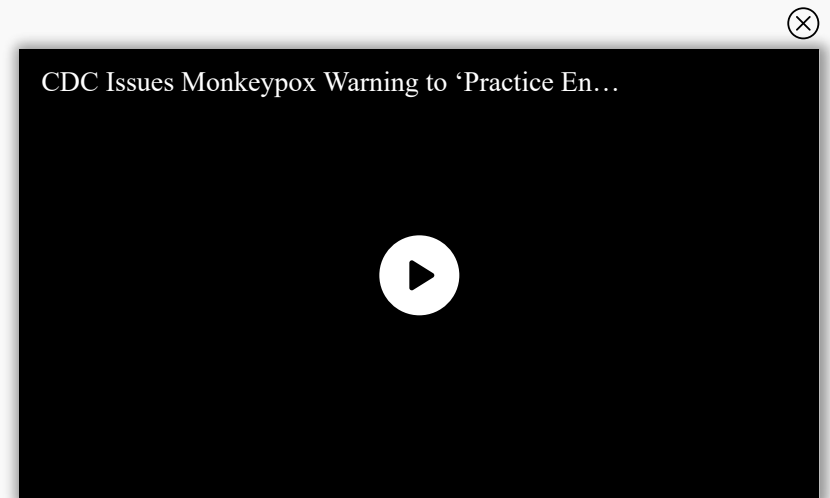
[Cookie Policy](#)

[Disclaimer \(Terms and Conditions\)](#)

[Do Not Sell My Personal Information](#)







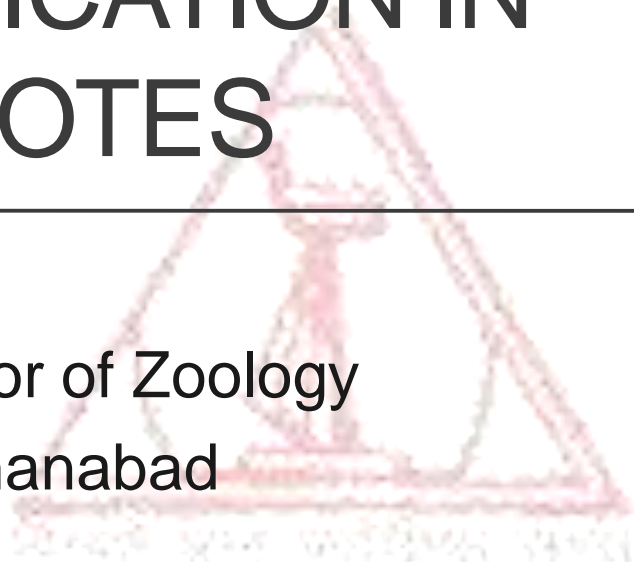
# DNA REPLICATION IN PROKARYOTES

---

Praveen Deepak

Assistant Professor of Zoology

S. S. College, Jehanabad



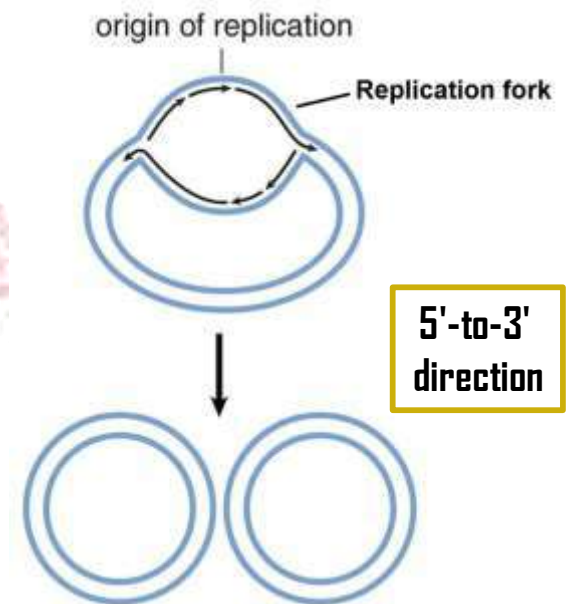
# Introduction

- ❑ The prokaryotic chromosome is a circular molecule.
- ❑ They are supercoiled structure that are suspended in cytoplasm.
- ❑ They are negatively supercoiled during normal growth.
- ❑ Most prokaryotes contain single circular genome, however some have multiple copies of genome, such as *Vibrio cholerae* (*Cholera*) contains 2 genomes (Trucksis et. al., 1998) and *Borrelia burgdorferi* (Lyme disease) contains up to 11 copies of genome (Ferdows & Barbour, 1989).
- ❑ *Borrelia burgdorferi* genome are not supercoiled as that of *Escherichia coli* (*E. coli*); rather; their DNA strands are diffused throughout the cell (Hinnebusch & Bendich, 1997).
- ❑ In addition to genome, most prokaryotes also contain linear or circular small DNA molecules known as plasmid, an extrachromosomal DNA molecule that encode nonessential genes. It may be found in one or multiple copies in the bacteria. *Borrelia* may contain up to 20 plasmids (Fraser et al., 1997).
- ❑ Plasmids are much smaller than genome often contain only 1500 kb and replicate independently.
- ❑ Replication, which is a duplication of chromosome, starts from a sequence known as the origin of replication (point at which the DNA opens up) in prokaryotes.



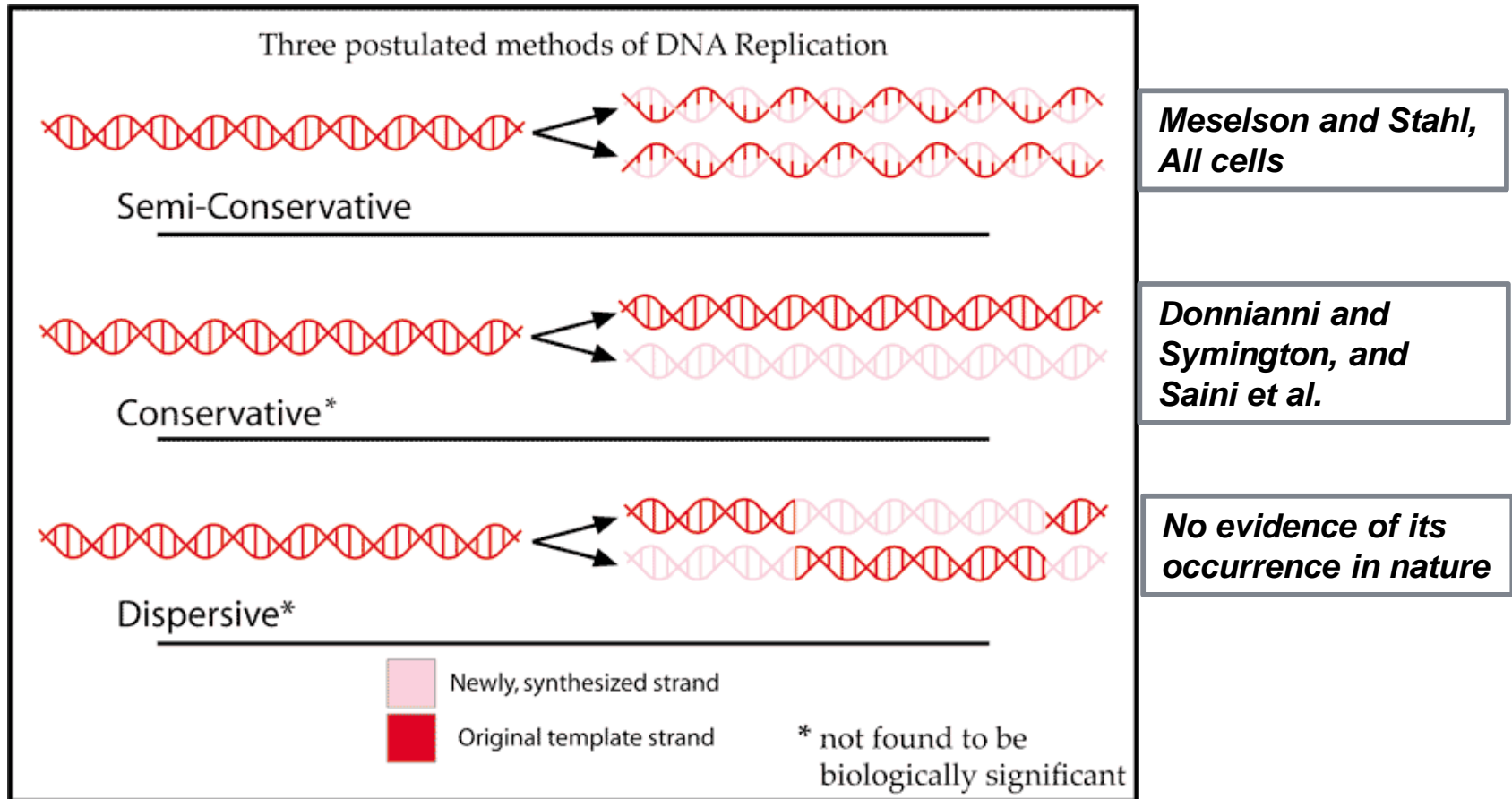
# Introduction

- ❑ The specific structure of the replication origin varies somewhat from species to species, but all share some common characteristics such as high AT content.
- ❑ Prokaryotes have single replication origin per circular chromosome except Archaea have several replication origin. It is called as OriC in *E. coli*.
- ❑ It is called as theta replication as the structure resembles the Greek alphabet theta ( $\theta$ ).
- ❑ The replication in prokaryotes occurs in three steps:
  - 1.) **Initiation:** at replication origin
  - 2.) **Elongation:** at replication fork
  - 3.) **Termination:** at termination sequence
- ❑ Replication is bidirectional Y-shaped formation of replication fork runs in both directions.
- ❑ Replication is semi-continuous:  
*Leading strand – continuous*  
*Lagging strand – fragmented (Okazaki fragments)*



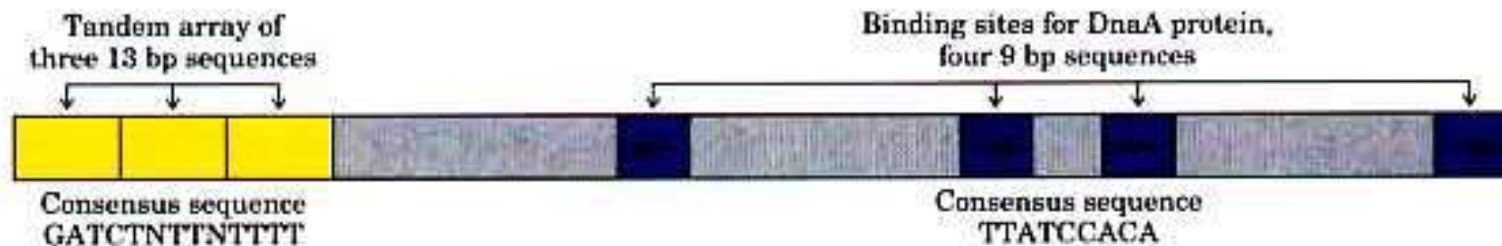
# Mode of replication

- Replication is performed by semiconservative mode, i.e., one strand of DNA is conserved (template strand) while other strand is not conserved.



# Initiation

- ❑ DNA replication starts with the formation of replication origin which is highly conserved among bacteria.
- ❑ The *oriC* replication origin of *E. coli* 245 base pairs.
- ❑ The key sequences *oriC* are two series of short repeats; three repeats of a 13 base pair sequence and four repeats of a 9 base pair sequence.

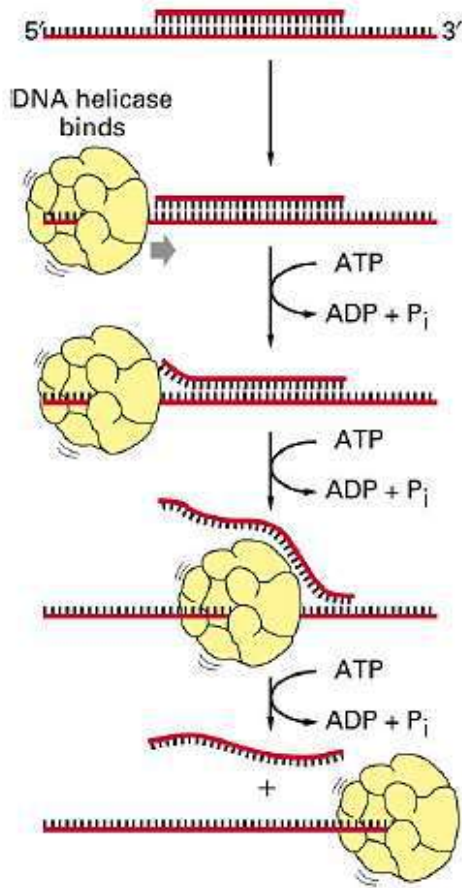


- ❑ DnaA protein binds to 9-mer DnaA box consensus sequence, 5'-TTAT<sub>n</sub>CACA-3' and results in unwinding of DNA at *oriC*. (***DiaA complex : DiaA-DnaA complex***)
- ❑ Unwinding results in the recognition of DNA by other replication proteins that act subsequently in the initiation process.
- ❑ Thereafter, integration host factor binds to its single site, which causes a sharp (120–180°) bend in the double helix (Swinger and Rice, 2004).
- ❑ A complex consisting of *oriC*, IHF, DiaA, and oligomeric ATP-DnaA is considered to make up the initiation complex in *E. coli* (Keyamura et al., 2007, 2009).
- ❑ This complex finally leads to the loading of DNA helicases and thereby the formation of replisomes.



# Initiation

## Unbinding of DNA by helicases



*An enzyme that unwinds the double helix by breaking the hydrogen bonds between the complimentary bases*

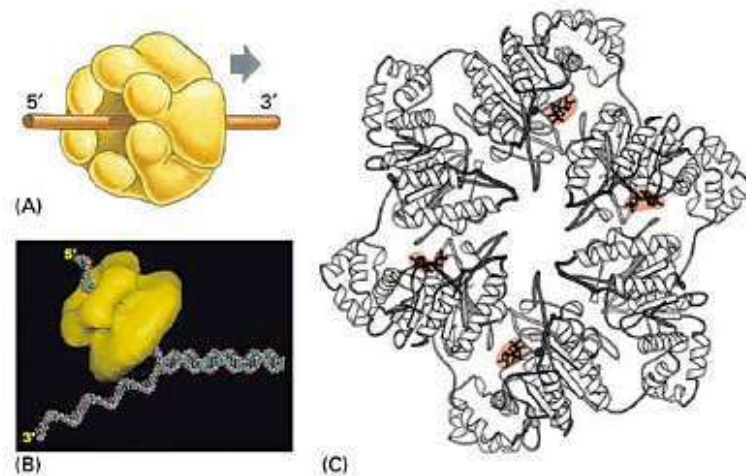


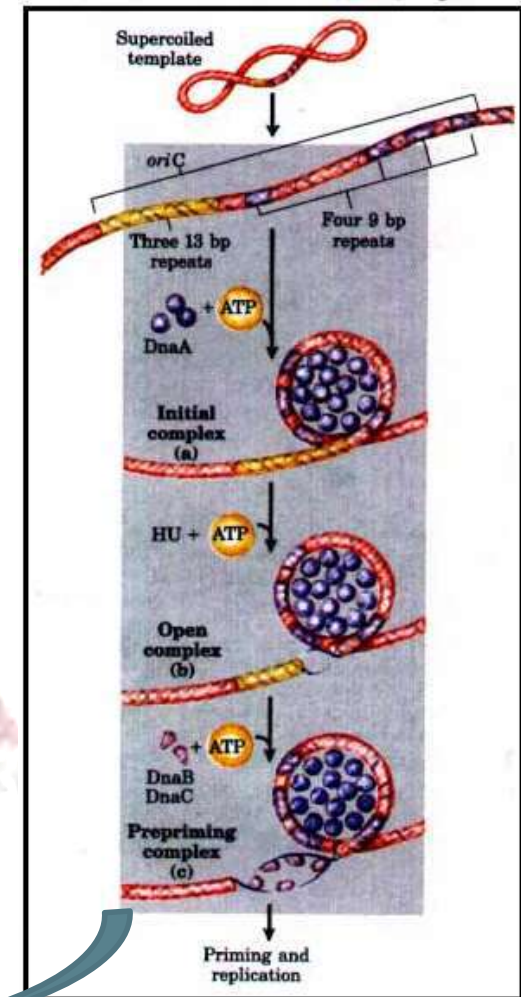
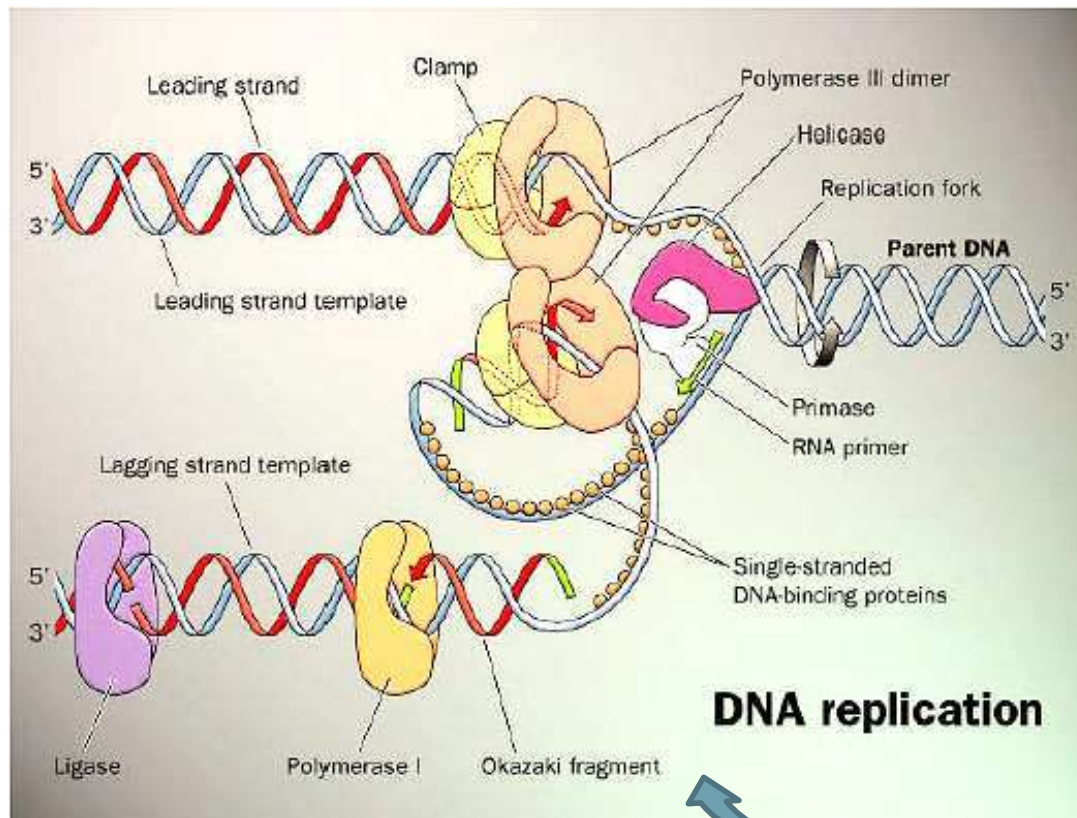
Figure 5-16. Molecular Biology of the Cell, 4th Edition.

Figure 5-15. Molecular Biology of the Cell, 4th Edition.



# Initiation

- ❑ Replisome – DNA polymerases, helicases, SSBs, DNA ligase, clamps (e.g. topoisomerases).
- ❑ Replisome is a multienzyme complex of >1MDa.



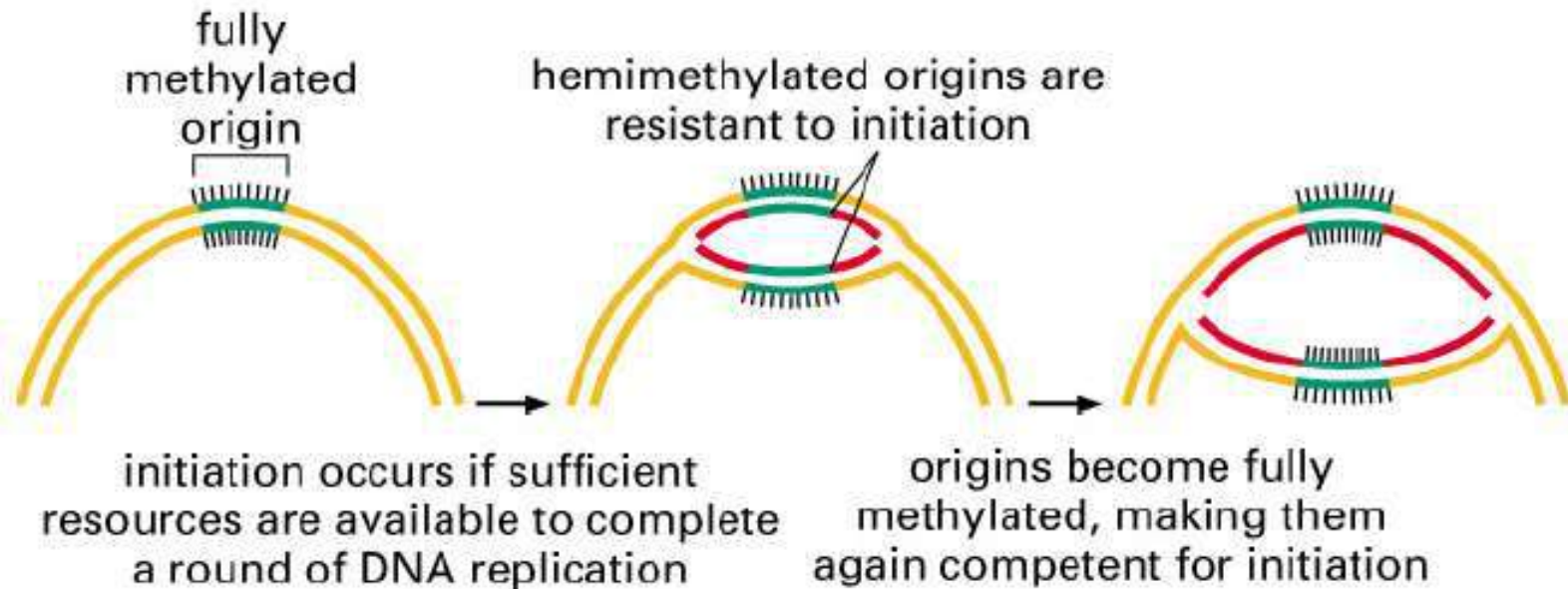
<http://www.bioinfo.org.cn/book/biochemistry/chapt24/bio3.htm>





# Initiation

## Regulation of initiation of replication

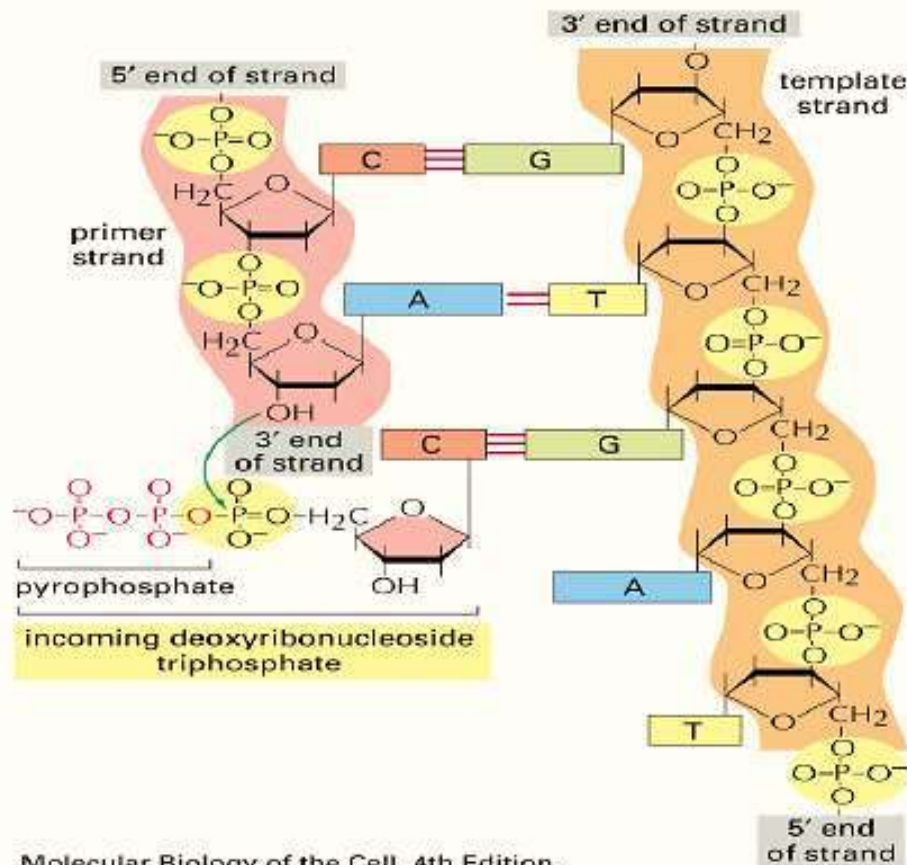


Molecular Biology of the Cell, 4th Edition.



# Elongation

- Elongation of new DNA at a replication fork.
  - It is catalyzed by enzymes called DNA polymerases, which add nucleotides to the 3' end of a growing strand.



DNA polymerase adds nucleotides to the deoxyribose (3') ended strand in a 5' to 3' direction

## Accuracy

1 error in 1 billion bases

## Speed

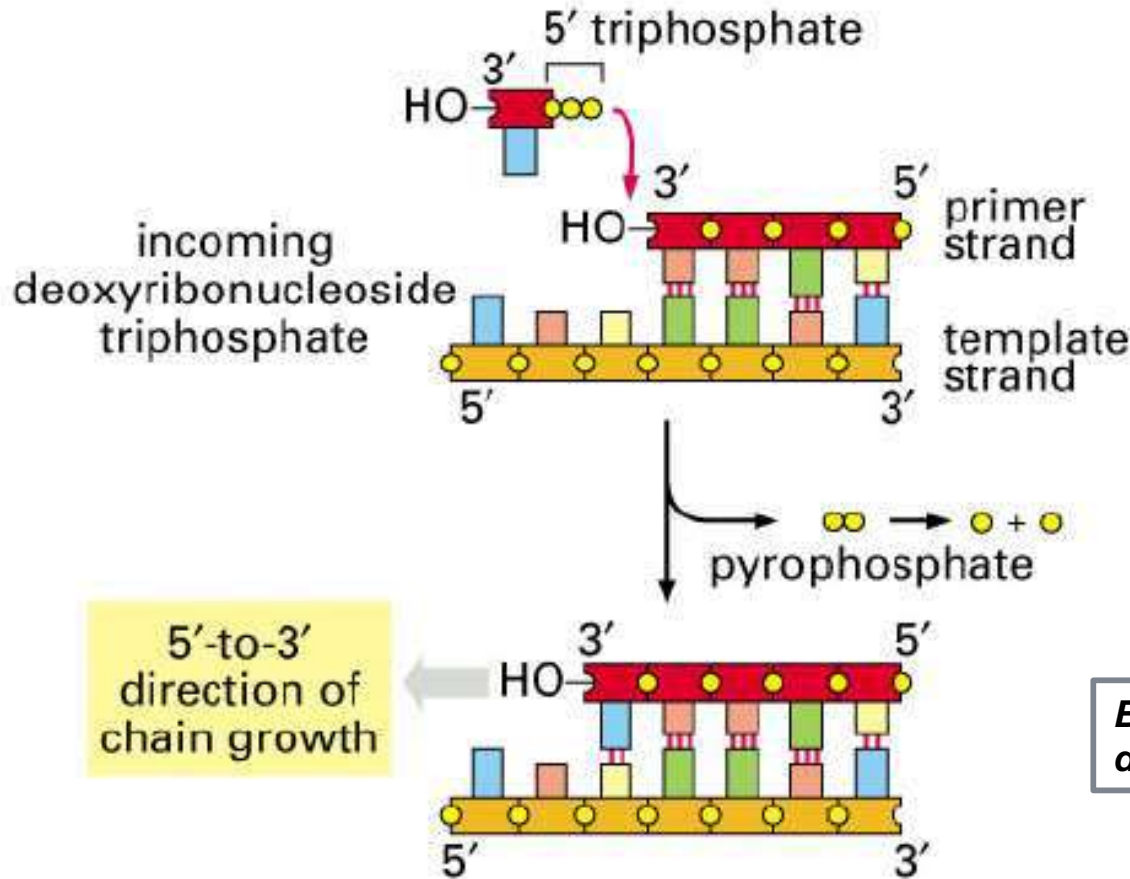
500 nt/s in bacteria

50 nt/s in mammals

Molecular Biology of the Cell, 4th Edition.

# Elongation

- DNA is synthesized in 5' to 3' direction



5'-to-3'  
direction of  
chain growth

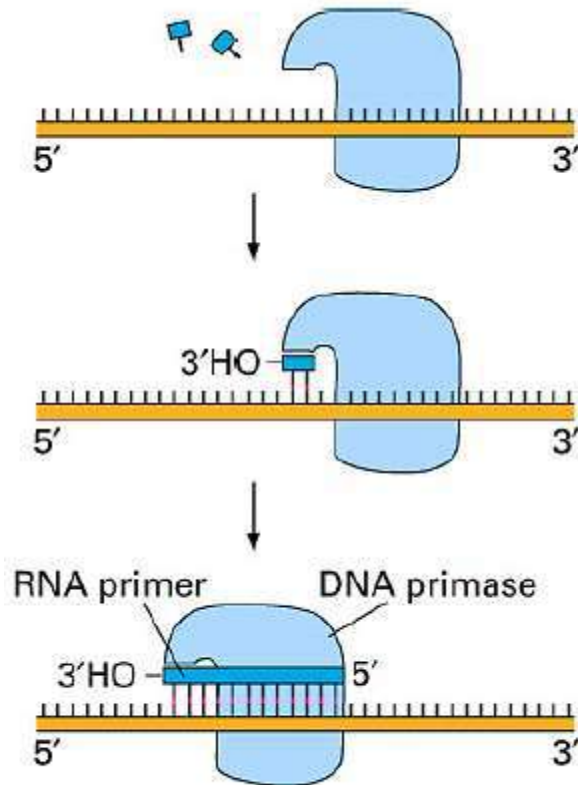
*Bacterial chromosome  
doubles in 40 min*

Molecular Biology of the Cell, 4th Edition.



# Elongation

## RNA polymerase or DNA primase



- *Makes the 10 nt RNA primer required for start of replication in the beginning of leading strand.*
- *In beginning of each Okazaki-Fragment, it synthesizes primer sequences of ribose nucleotide.*

Figure 5-12. Molecular Biology of the Cell, 4th Edition.



# Elongation

- Topoisomerase in initiation complex prevents over-winding of the DNA double helix ahead of the replication fork as the DNA is opening up by breaking the strand.

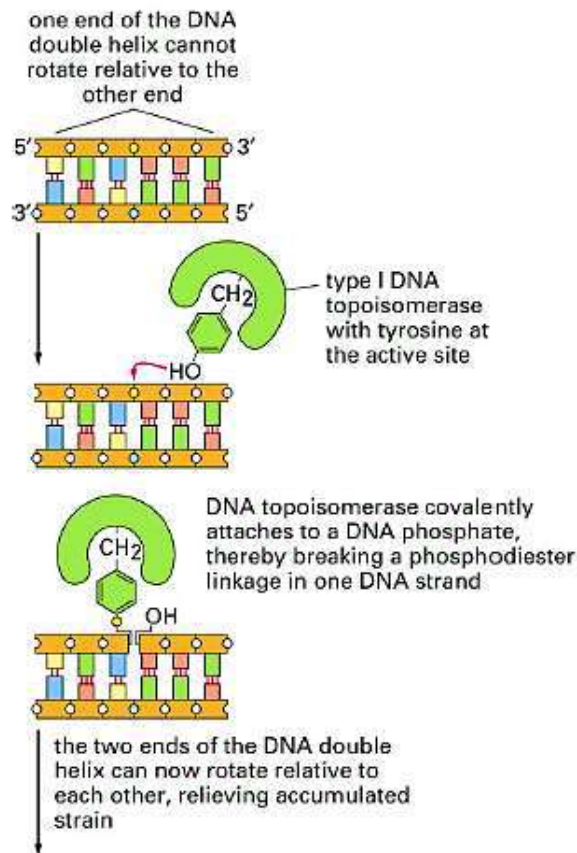


Figure 5-25 part 1 of 2. Molecular Biology of the Cell, 4th Edition.

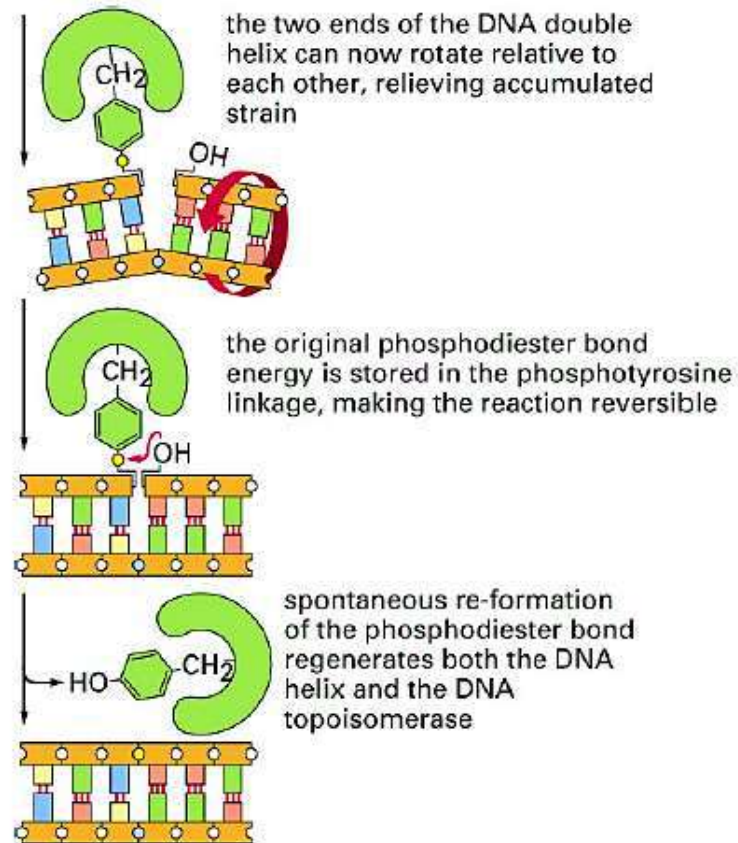
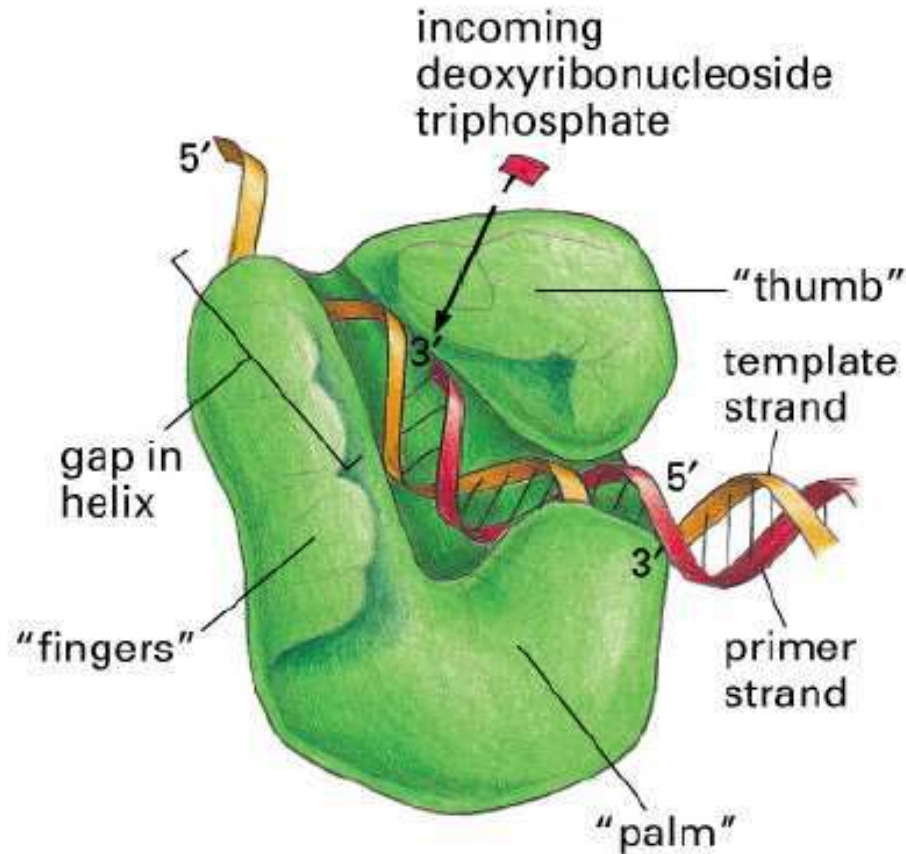


Figure 5-25 part 2 of 2. Molecular Biology of the Cell, 4th Edition.



# Elongation

- Nucleotides are added by the DNA polymerase.



Molecular Biology of the Cell, 4th Edition.

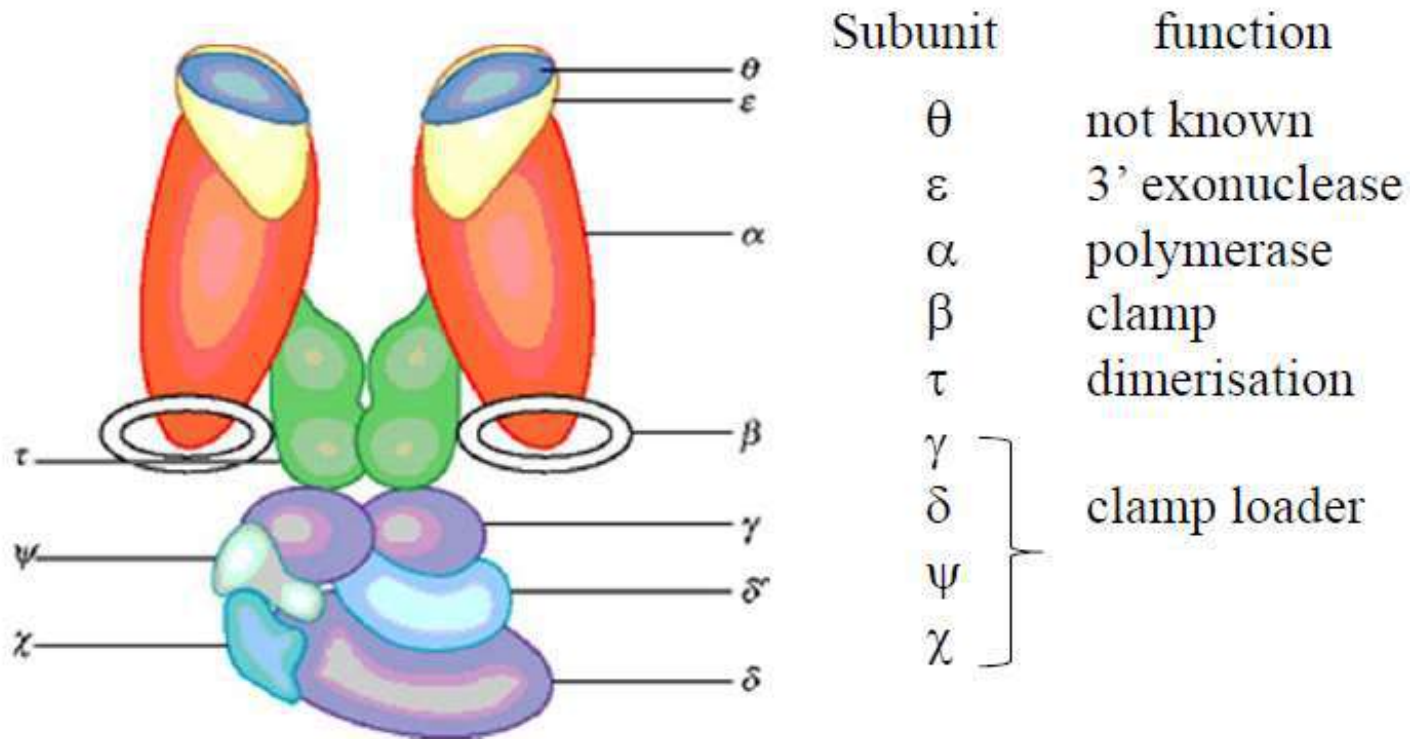
***DNA polymerase requires:***

- 1. A free 3'-OH group supplied by RNA Primer for start of polymerisation***
- 2. Mg<sup>2+</sup> ions for activity in active site***
- 3. A template to copy***



# Elongation

- Nucleotides are added by the DNA polymerase. DNA polymerase is a protein complex like DNA polymerase III composed of 10 subunits as shown below.

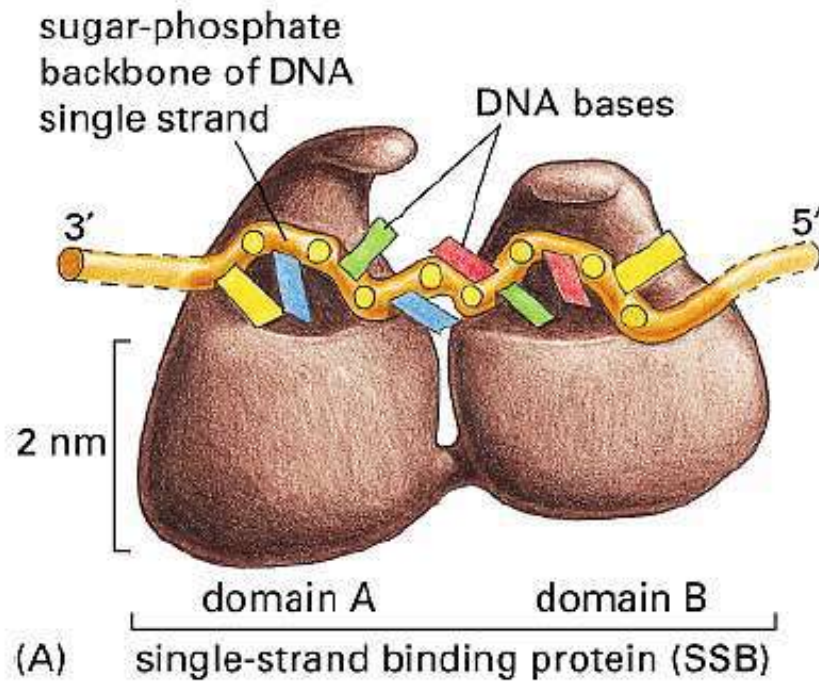


Structure of DNA polymerase III (dnaX)



# Elongation

## Binding of SSBs proteins to DNA



(B)

Figure 5-18. Molecular Biology of the Cell, 4th Edition.





# Elongation

## Binding of SSBs proteins to DNA

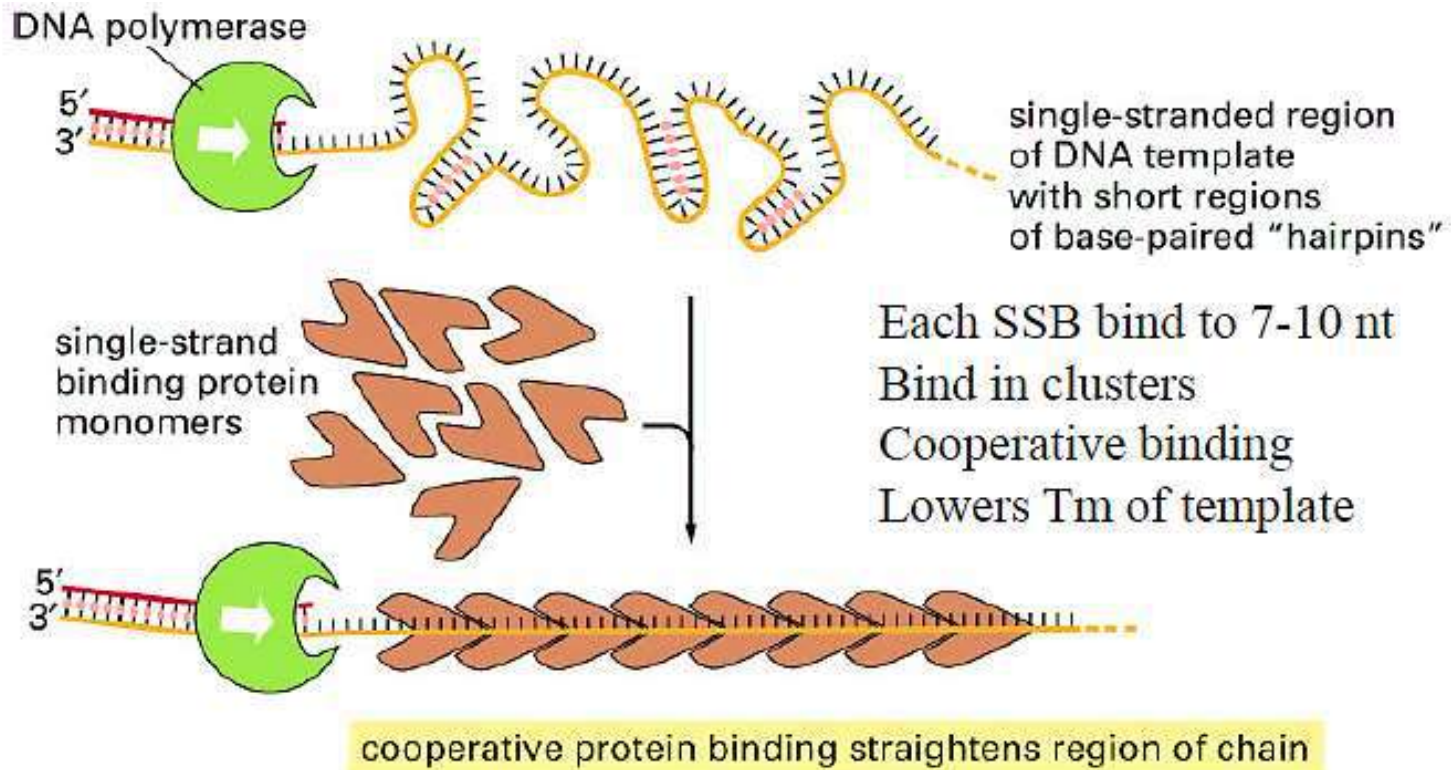


Figure 5-17. Molecular Biology of the Cell, 4th Edition.



# Elongation

## *E. coli* contains multiple DNA polymerases

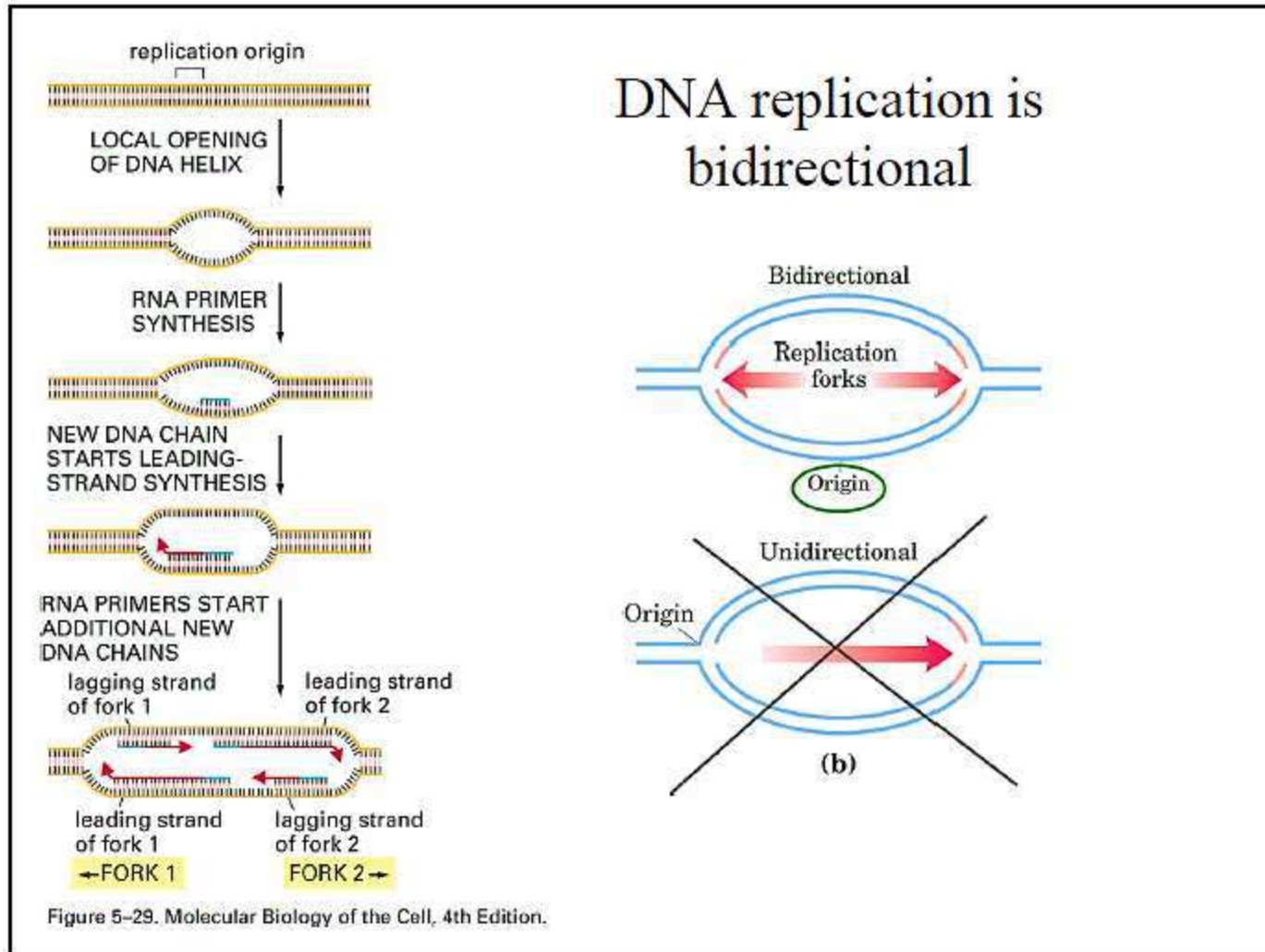
	DNA poly I	DNA poly II	DNA poly III
Number/cell	400	100	10
Speed (nt/s)	16-20	2-5	250-1000
3' exonuclease	Yes	Yes	No
5' exnuclease	Yes	No	No
Processitivity	3-200	10000	500000
Role	DNA repair RNA primer removal	DNA repair	Replication

- DNA poly I was found by Arthur Kornberg at mid 1950's
- It has three enzymatic activities:
  - Polymerase activity
  - 3' to 5' exonuclease activity
  - 5' to 3' exonuclease activity

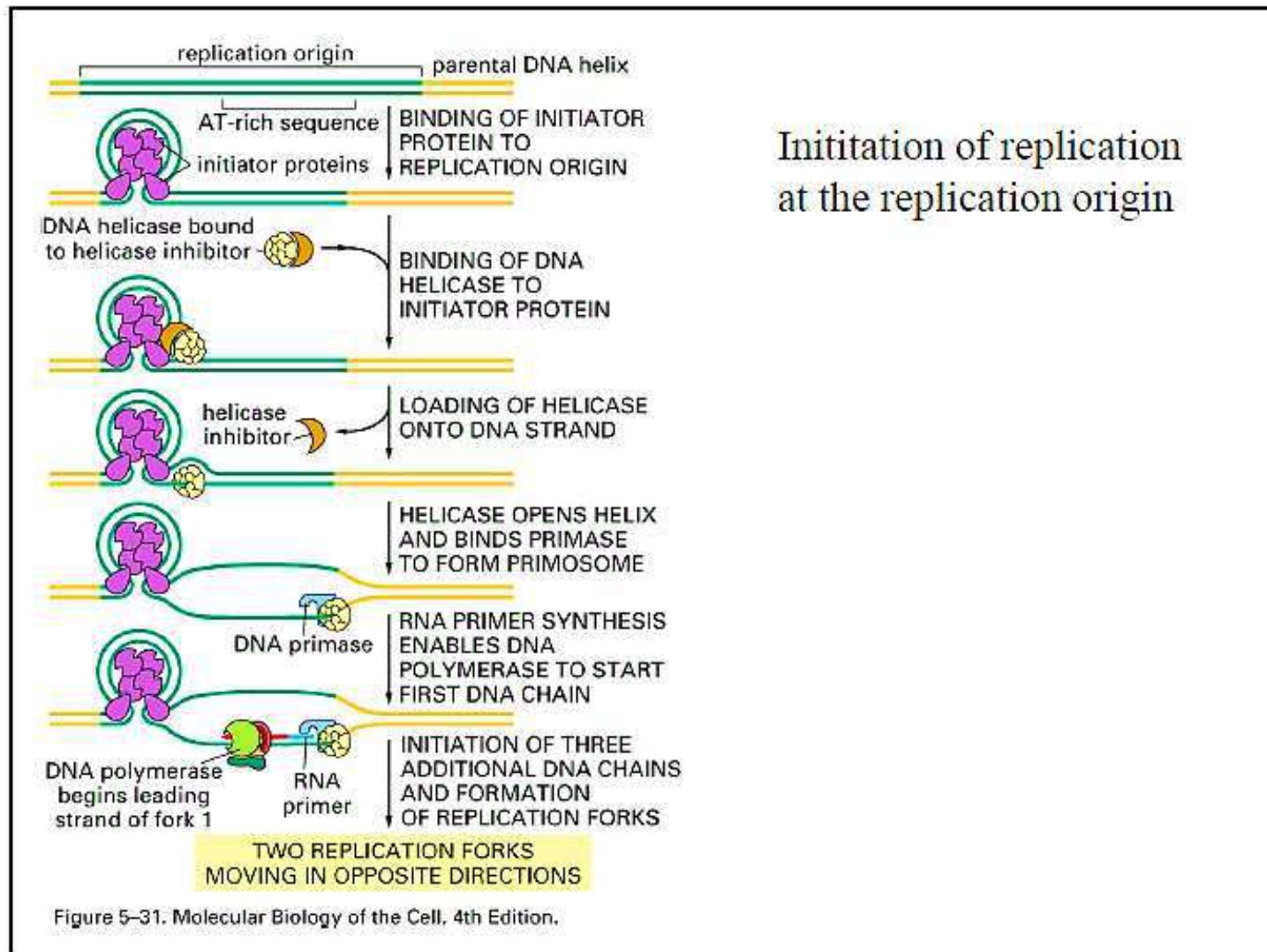
***Klenow enzyme is lacking one subunit responsible for the 5' to 3' exonuclease activity.***



# Elongation



# Elongation

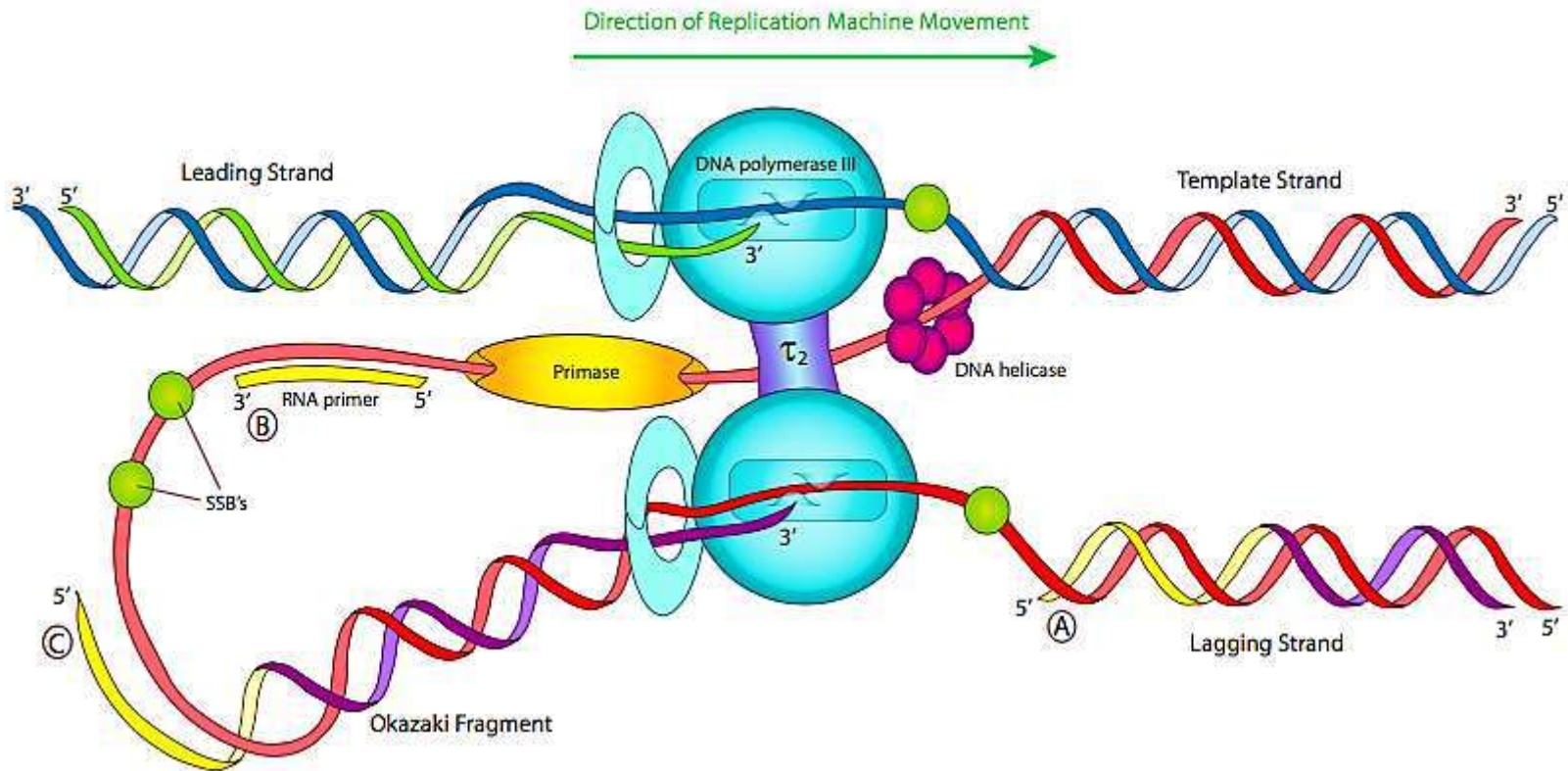


Initiation of replication at the replication origin



# Elongation

- DNA is synthesized in the replication fork in 5' to 3' direction



# Elongation

□ DNA is synthesized in the replication fork in 5' to 3' direction

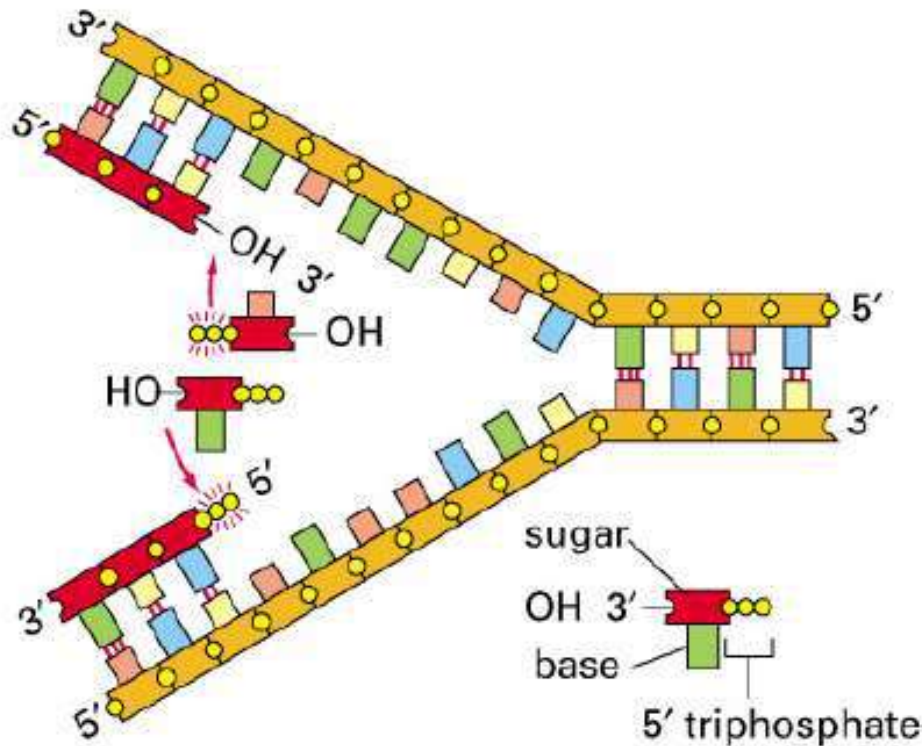


Figure 5-7. Molecular Biology of the Cell, 4th Edition.

- Here, a primer sequence is added with complementary RNA nucleotides by RNA polymerase called primase, which are then replaced by DNA nucleotides.
- DNA polymerase adds DNA nucleotides to the 3' end of the newly synthesized polynucleotide strand.
- The template strand specifies which of the four DNA nucleotides (A, T, C, or G) is added at each position along the new chain.
- Only the nucleotide complementary to the template nucleotide at that position is added to the new strand.
- Once DNA replication is finished, the daughter molecules are made entirely of continuous DNA nucleotides, with no RNA portions.



# Elongation

- ❑ Leading strand synthesis is continuous whereas lagging strand is synthesized in fragments

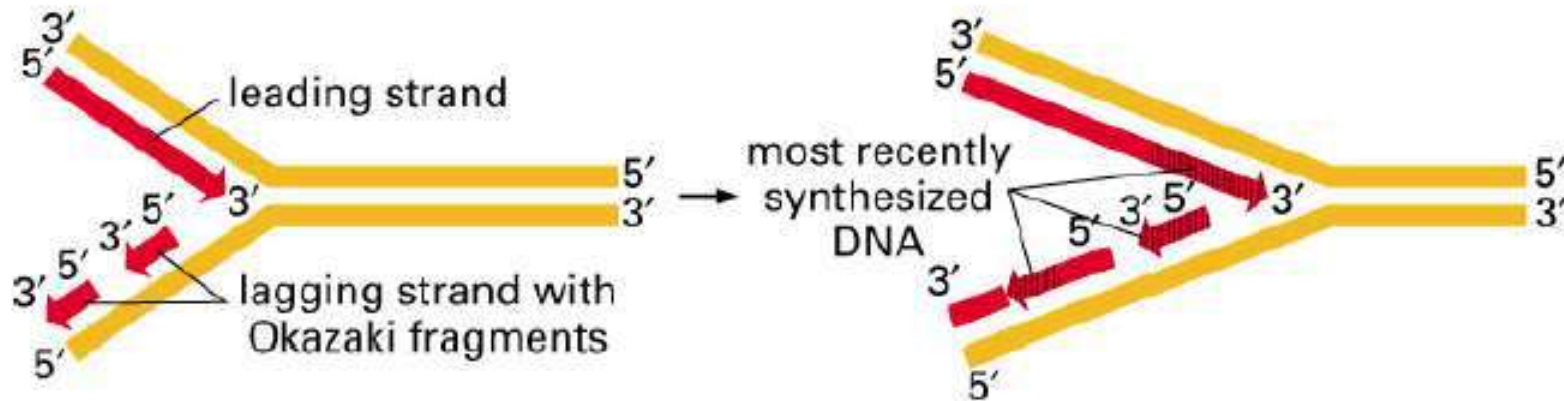


Figure 5-8. Molecular Biology of the Cell, 4th Edition.

- ❑ DNA polymerase can only synthesize new strands in the 5' to 3' direction.
- ❑ The “leading strand” is synthesized continuously toward the replication fork as helicase unwinds the template double-stranded DNA.
- ❑ The “lagging strand” is synthesized in the direction away from the replication fork and away from the DNA helicase unwinds.
- ❑ This lagging strand is synthesized in pieces because the DNA polymerase can only synthesize in the 5' to 3' direction. The pieces are called as Okazaki fragments
- ❑ Length of Okazaki fragments in prokaryotes are 1000-2000 nt.



# Elongation

- ❑ **Error correction or proofreading:** Any error that has been left during the replication is corrected by DNA polymerase.
- ❑ Error repair is achieved with the exonuclease activity of DNA polymerase.

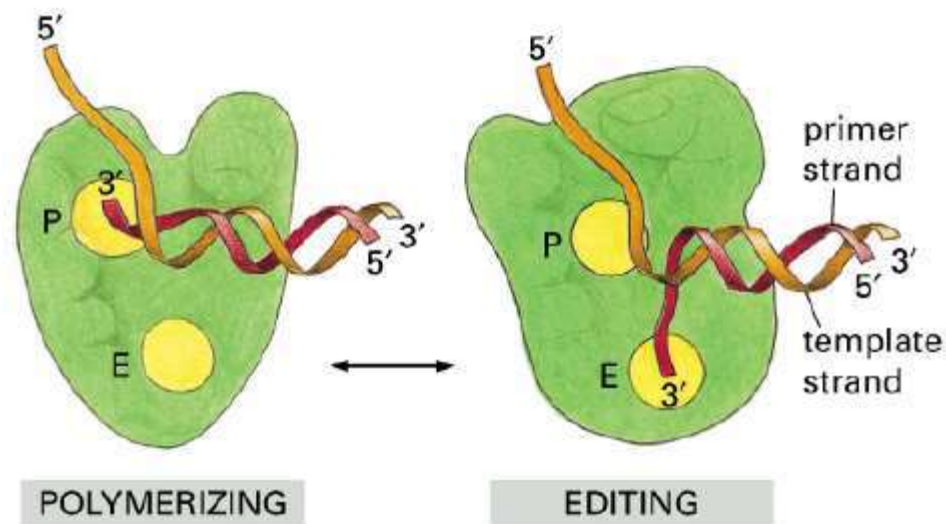


Figure 5-10. Molecular Biology of the Cell, 4th Edition.

***This results in a very low error rate of 1 in 1 billion nucleotides***

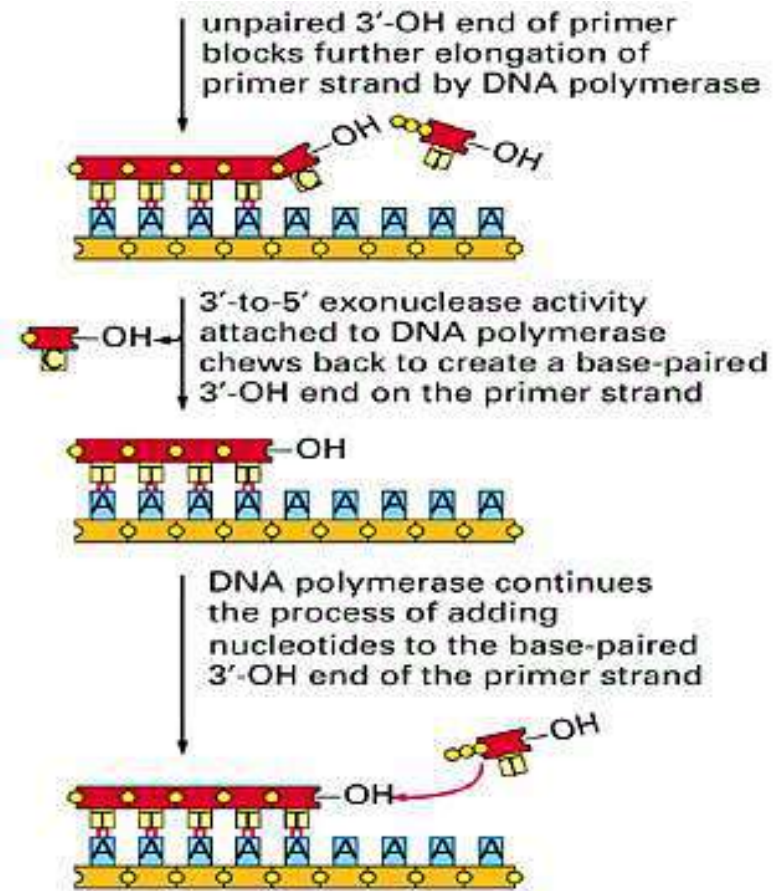
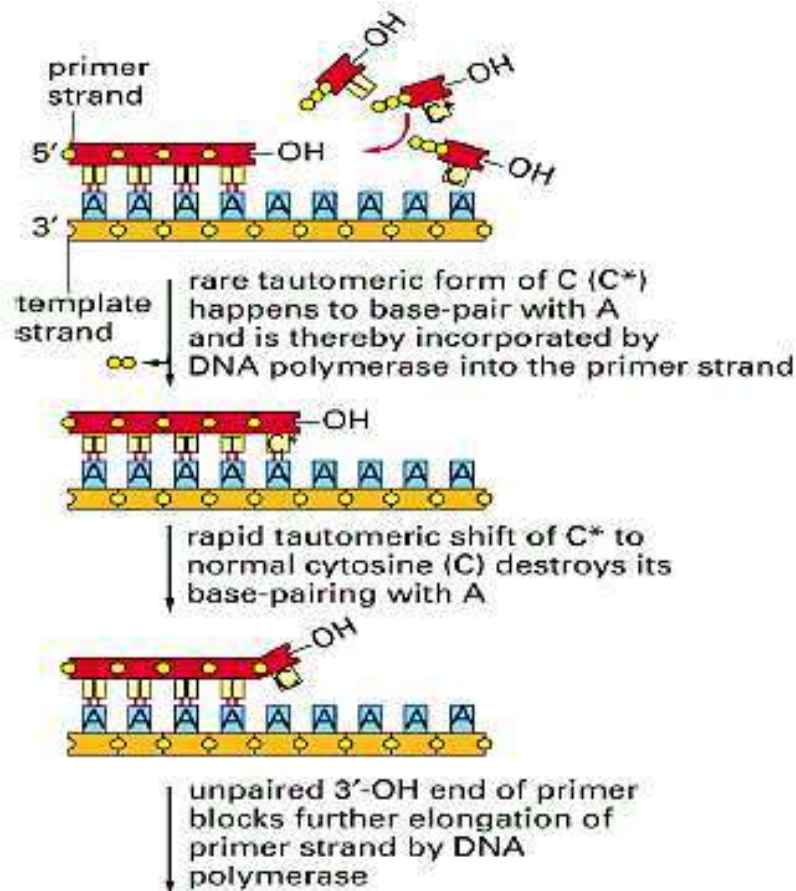




# Elongation

## Error correction

- 3' to 5' exonuclease activity corrects errors

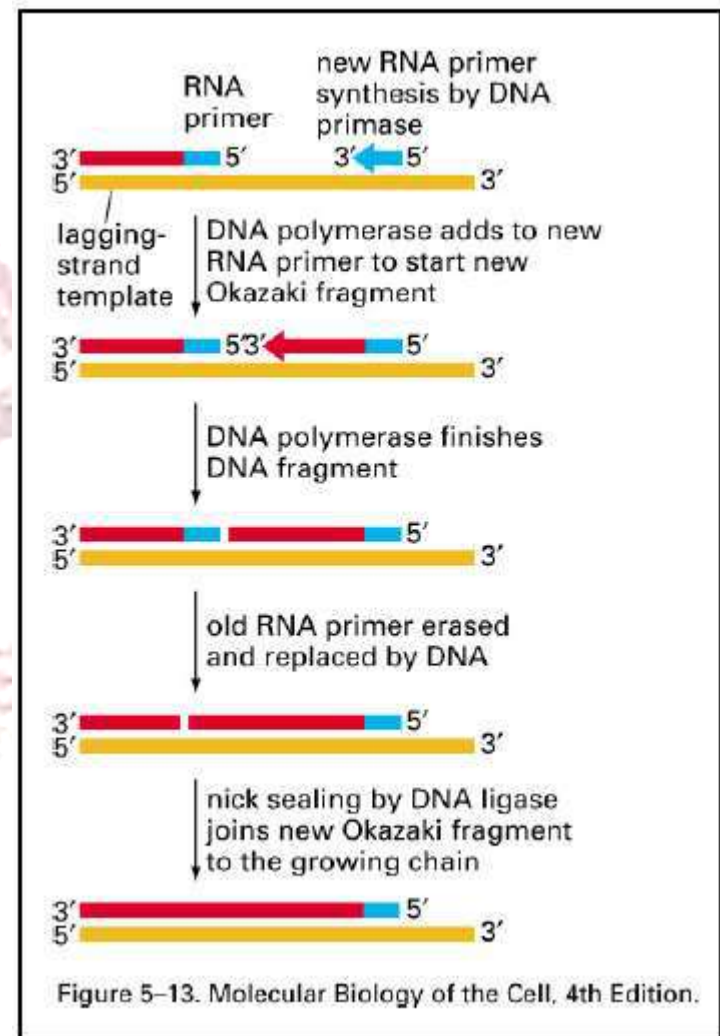


# Elongation

## Sealing the nick of Okazaki fragments

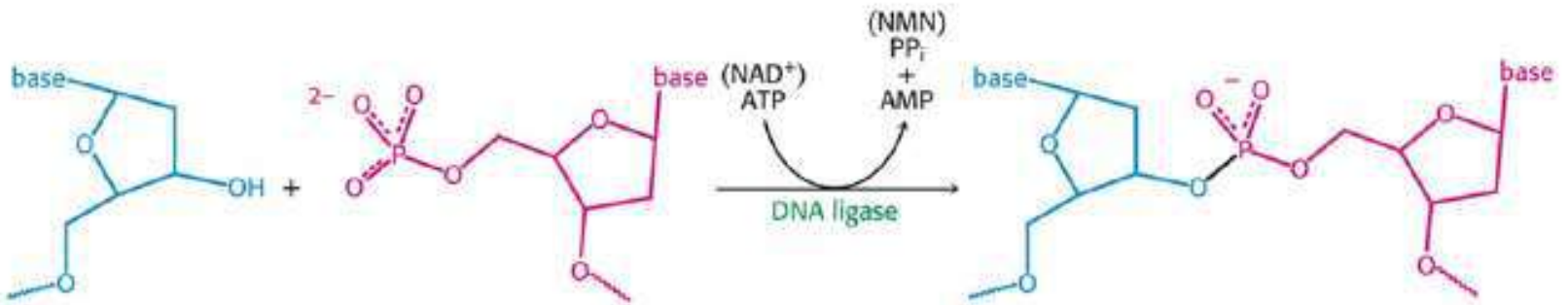
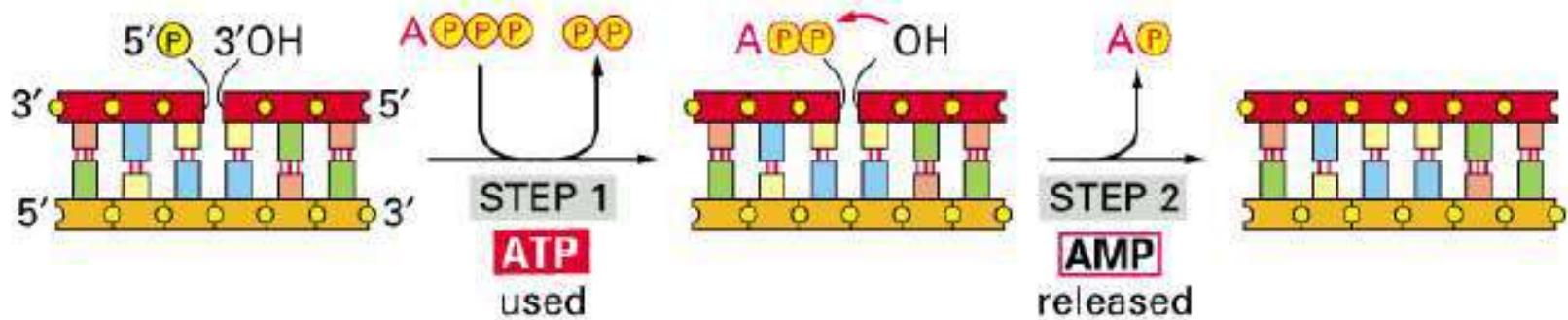
- DNA ligase seals the nicks between Okazaki fragments
- It requires close and free 3'-OH and 5'-P and proper base-pairing
- NAD<sup>+</sup> required in prokaryotes

***ATP required in eukaryotes***



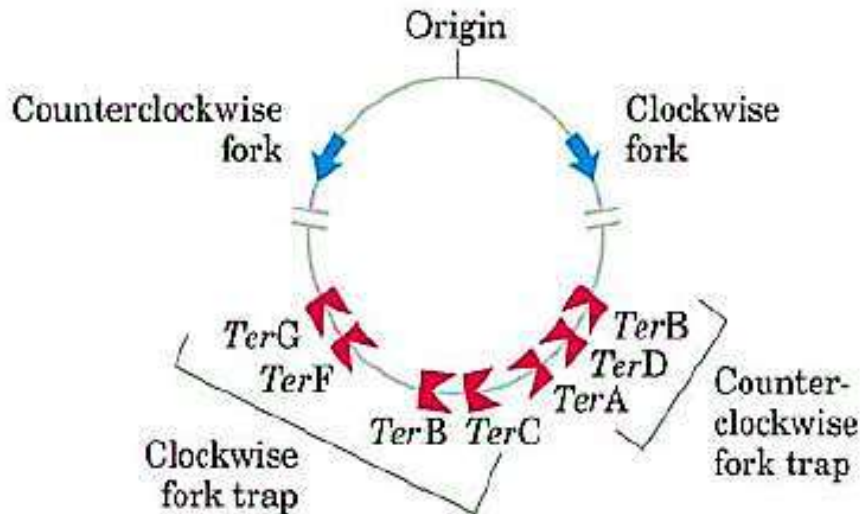
# Elongation

Sealing the nick of Okazaki fragments – Nick sealing by DNA ligase



# Termination

Termination of replication takes place at the termination site in the prokaryotic DNA



Terminus Utilization Substance (Tus)

- ❑ DNA replication terminates when replication forks reach specific 'termination sites', i.e. replication forks meet each other on the opposite end of the parental circular DNA.
- ❑ The two replication forks are synchronized by 10-23 bp Ter sequences that bind Tus proteins
- ❑ Tus proteins can only be displaced by replisomes coming from one direction

- ❑ Tus protein binds to terminator sequences (Ter sequence) and acts as a counter-helicase when it comes in contact with an advancing helicase. The bound Tus protein effectively halts DNA polymerase movement.



# Enzymes and Proteins of Prokaryotic DNA Replication

Enzyme/protein	Specific function
DNA pol I	Exonuclease activity removes RNA primer and replaces with newly synthesized DNA
DNA pol II	Repair function
DNA pol III	Main enzyme that adds nucleotides in the 5'-3' direction
Helicase	Opens the DNA helix by breaking hydrogen bonds between the nitrogenous bases
Ligase	Seals the gaps between the Okazaki fragments to create one continuous DNA strand
Primase	Synthesizes RNA primers needed to start replication
Sliding Clamp	Helps to hold the DNA polymerase in place when nucleotides are being added
Topoisomerase	Helps relieve the stress on DNA when unwinding by causing breaks and then resealing the DNA
Single-strand binding proteins (SSB)	Binds to single-stranded DNA to avoid DNA rewinding back.



# Steps of the DNA replication in prokaryotes

- ❑ DNA unwinds at the origin of replication.
- ❑ Helicase opens up the DNA-forming replication forks; these are extended bidirectionally.
- ❑ Single-strand binding proteins coat the DNA around the replication fork to prevent rewinding of the DNA.
- ❑ Topoisomerase binds at the region ahead of the replication fork to prevent supercoiling.
- ❑ Primase synthesizes RNA primers complementary to the DNA strand.
- ❑ DNA polymerase starts adding nucleotides to the 3'-OH end of the primer.
- ❑ Elongation of both the lagging and the leading strand continues.
- ❑ RNA primers are removed by exonuclease activity.
- ❑ Gaps are filled by DNA pol by adding dNTPs.
- ❑ The gap between the two DNA fragments is sealed by DNA ligase, which helps in the formation of phosphodiester bonds.



# Steps of the DNA replication in prokaryotes

- Willey J., Sherwood L., Woolverton C.J. 2017. Prescott's Microbiology 10<sup>th</sup> Edition, McGraw Hill Publication, New York, USA
- Krebs J.E., Goldstein E.S., Kilpatrick S.T. 2017. Lewin's Genes XII. Jones and Bartlett Publishers, Inc., Burlington, MA, USA
- Snyder L.R., Peters J.E., Henkin T.M., Champness W. 2013. Molecular Genetics of Bacteria, 2nd ed., ASM Press, Washington DC, USA, 2003.
- Graumann P.L. Chromosome architecture and segregation in prokaryotic cells. Microbial Physiology 24(5-6).
- Griswold A. 2008. Genome Packaging in Prokaryotes: the Circular Chromosome of *E. coli*. Nature Education 1(1):57.
- Kuzminov A. 2014. The precarious prokaryotic chromosome. Journal of Bacteriology 196(10):1793-1806.



# DNA, RNA, replication, translation, and transcription

---

## Overview

Recall the central dogma of biology:

DNA (genetic information in genes) → RNA (copies of genes) → proteins (functional molecules)

## DNA structure

One monomer unit = deoxyribonucleic acid

- composed of a base, a sugar (**deoxy**ribose), and a phosphate
- directionality along the backbone → 5' (phosphate) to 3' (OH)

Double-strand pairing:

- complementary **base-matching**: A-T, C-G
- base-matching achieved by H-bonding and geometry (long vs short nucleotides)
- antiparallel (one strand 5'→3', the other 3'→5')

Helical shape

- 10.4 nucleotides per turn
- diameter = 2 nm
- both major and minor grooves
- called **B-DNA**. The helix twist and diameter can also change under dehydrating conditions and methylation to **A-DNA** and **Z-DNA**

Base-pairing and strand interactions

- A, G are long (double ring purines)
- C, T are short (single ring pyrimidines)
- need one long and one short nucleotide per pair
- C-G have three hydrogen bonds (slightly stronger matching)
- A-T have two hydrogen bonds (slightly weaker matching)



- **base stacking** of aromatic rings allows sharing of pi electrons and adds stability to interior structure of DNA → some hydrophobic driving force as well
- pair structure allows template for **semi-conservative copying**

Information in DNA sequence is the **genome**

- **genes** are stretches of information in the sequence that encode for particular function (usually a particular protein, but sometimes also an RNA sequence)
- about 20,000 genes in humans
- typically 1000s of nucleotides long
- genes can be **expressed** (use to make proteins) or **repressed** (not used)
- regions of DNA are divided into **coding and non-coding** segments
- over 50% of human DNA is non-coding
- genes can be spliced together
- genes are organized in the large-scale structure of the DNA in the nucleus

In bacteria, genome usually **circular**

The genome in eukaryotes is organized into **chromosomes**

- each chromosome a separate DNA molecule
- human cells contain 46 chromosomes (22 each from mother and father)
- chromosomes are extended and replicated during **interphase** portion of the cell cycle → extended allows for gene expression
- chromosomes are condensed, visible with light during cell division (**M phase**)

Special DNA sequences exist in each chromosome

- **replication origins** – multiple locations where the replication machinery first binds to start replication
- **centromere** – center “pinch point” of a chromosome that allows one copy of each to be pulled apart into two daughter cells during division

- **telomere** – specialized sequences at the chromosomes end that facilitate replication there

#### Higher-order DNA structure

- How do cells efficiently store very long chains of DNA?
- DNA wraps around protein “spools” to form **nucleosomes**
- Nucleosomes are made of **histone** proteins
- Spools organize into **chromatin fibers** that pack in regular ways, on different length scales

#### *Replication*

DNA replication is **semi-conservative** → one strand from each of the initial two strands end up in a daughter strand

Each strand serves as a template for a new strand

New strand is formed by complementary base-pairing of the correct nucleotide plus formation of a phosphodiester bond

Synthesis begins at replication origins

- about 100 nucleotides long → rich in A-T, which are easier to pull apart because have 2 rather than 3 hydrogen bonds
- ~1 in bacteria
- ~10000 in humans

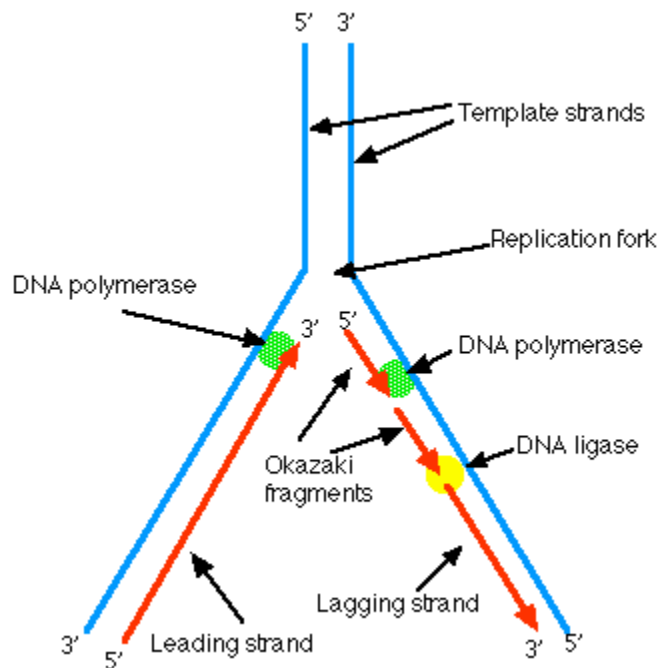
**Initiator** proteins bind at replication origins and recruit DNA replication machinery proteins

- **DNA polymerase** is responsible for catalyzing synthesis of new strands

Replication forks form and involve a **leading** and a **lagging** strand

- DNA is directional; two strands are antiparallel
- DNA polymerase can only synthesize from 5' to 3' direction, adding new nucleotides to the 3' end

- lagging strand must be synthesized by first spooling out some template strand and then synthesizing in reverse



#### Error-correction machinery

- mutations occur 1 in  $10^9$  nucleotides copied → evolution, cancer
- much better error rates than expected simply from base-pairing energetics
- DNA polymerase **proofreads** to make sure correct nucleotide is added → if not, it excises and goes back to add the correct one
- **Mismatch repair** machinery fixes incorrectly added nucleotides not found by DNA polymerase → detects nicks in newly created strand

#### Damage to DNA continuously occurs

- **Homologous recombination** uses similar sequences in nearby strands in order to fill in excised damaged DNA
- also the basis of heredity

### *Transcription*

**Messenger RNA**, or mRNA, is the RNA “copies” of genes ultimately used to synthesize proteins, although some RNA are the final product themselves

RNA has some distinctions from DNA

- ribose rather than deoxyribose sugar (differs in an OH group)
- **uracil** instead of thymine (loss of a methyl group)
- single-stranded, and typically folds into unique shapes, like proteins
- less chemically stable

Other kinds of RNA

- **Ribosomal RNA, rRNA**, is RNA that becomes part of the ribosome, the big molecular machine responsible for synthesizing proteins
- **Transfer RNA, tRNA**, is used to bring correct amino acids to the ribosome during protein synthesis
- **Micro RNAs (mRNAs)** are important in regulating gene expression
- others

**Transcription** involves the synthesis of rRNA from DNA using **RNA polymerase**

- RNA polymerase must unpair and unwind DNA as it is reading it
- much less accurate than replication → errors of 1 in  $10^4$
- protein synthesis can tolerate more errors
- multiple RNAs can be sequenced from the same gene at the same time

In bacteria:

- RNA polymerase binds to specific regions of the DNA called **promoters**, specific nucleotide sequences
- Promoters orient polymerase in a specific direction
- RNA polymerase binds to the promoter with the help of an accessory protein, called a **sigma factor**
- RNA transcript is synthesized by ribonucleotide triphosphate additions
- Synthesis stops at a **terminator** sequence, typically of poly A-T stretches of DNA

In eukaryotes, the situation is different in a number of ways:

1. Different kinds of RNA polymerases, depending on whether the product is protein or RNA
2. RNA polymerase requires a number of helper proteins to bind to DNA and initiate RNA synthesis → **transcription factors**
3. Transcription factor TFIID binds to a specific DNA sequence upstream 25 nucleotides from the region coding for the protein → **TATA sequence or TATA box**
4. Other proteins assemble to form a large **transcription complex**
5. **Chromatin-remodeling proteins** are involved to make DNA accessible from the wound histone structure
6. RNA chemically modified with a **methylated guanine** at the 5' end and a **poly-A** sequence at the 3' end → these help the ribosome later ensure that the complete recipe for a protein is there
7. RNA is processed after synthesis → **splicing** to remove **noncoding** regions called **introns**
8. The nuclear pore complex selectively exports complete, spliced mRNA molecules to the cytosol

Splicing has evolutionary advantages

- promotes diversity of proteins produced from a single gene → **alternative splicing**
- enables formation of new proteins from combinations of different genes separated by long noncoding regions

## *Translation*

Information transmission

- 4 bases in DNA/RNA to 20 amino acids in proteins
- “translation” since the chemical language is different
- How many nucleotides needed to specify each amino acid?
- Two = 16 combinations → not enough!
- Three = 64 combinations → plenty!

Processed (e.g., spliced) mRNA is read in groups of three nucleotides

- called **codons**
- redundancy of codons for different amino acids → typically the last nucleotide is variable
- three possible **reading frames** depending on starting nucleotide

**transfer RNAs (tRNAs)** are the intermediates between nucleotides and amino acids

- about 80 nucleotides long
- have specific 3D shape, like an “L”
- at one end: **anticodon** that base-pairs with mRNA
- at the other end: covalently coupled amino acid
- different tRNAs for each amino acid type
- base pairing weakest at third “wobble” nucleotide (why it is most variable)
- tRNAs are **charged** with an amino acid by **aminoacyl tRNA synthetases** that ensure correct addition of individual amino acids to corresponding tRNA

The synthesis of proteins is choreographed by large molecular machines called **ribosomes**

- large and small subunits = ~82 proteins (1/3) plus **4 ribosomal RNA (rRNA)** strands (2/3)
- overall structure and catalytic activity dictated by RNA → **ribozyme**
- huge! ~several million Daltons (vs 30k for a typical protein)
- Nobel prize in 2009!

General process for synthesis of proteins

- binding sites for mRNA and three tRNA amino acid carriers in ribosome
- correct tRNA binds at A site through base pairing with mRNA
- high-energy covalent bond attaching amino acid is added to growing chain
- ribosome shifts over one tRNA unit, placing the tRNA in the P and then E site

- synthesized protein exits the **ribosome exit tunnel**, opposite the mRNA
- about 2 AA/seconds in eukaryotes (20 AA/seconds in some bacteria)

#### Initiation of protein synthesis

- all proteins begin with a methionine → **start codon** that signals initiation of protein synthesis (methionine typically removed in post-translational processing)
- **initiation factor tRNA** binds first with small subunit to mRNA
- large subunit then binds
- synthesis continues until a **stop codon** is reached, which bind **release factor** proteins

Many proteins can be made at once from the same RNA transcript by having multiple ribosomes bound to it → **polyribosomes**

#### *After synthesis*

Proteins can fold as they are exiting the ribosome tunnel, but can also receive the help of **chaperones** to fold without danger of aggregation

Many proteins undergo **post-translational** modifications

- disulfide bond formation
- phosphorylation
- binding of small molecule **cofactors**
- association with other protein subunits into large functional structures
- **glycosylation** = addition of sugars to the surface to create glycoproteins

The protein life cycle ends with degradation into constituent amino acids that can be used to build new proteins

- **proteases** are proteins that degrade other proteins
- the **proteasome** is a large cylindrical protein complex that is responsible for degrading most proteins in eukaryotic cells in its interior

- the proteasome recognizes proteins that need to be degraded because they are “tagged” with **ubiquitin** – a protein that can be attached to proteins to signal that they are destined for degradation

### *The origins of life?*

The central dogma is so central to all living things, but one wonders how it may have evolved

Life requires both storage and replication of genetic information, and the ability to catalyze specific reactions → RNA has both of these abilities

RNA thought to be the original molecule of life, carrying both genetic info and performing chemical reactions (ribozymes)

Life then shifted to a DNA platform for the storage of the genetic information because of its increased chemical stability and double-stranded format that enables proofreading

Life then shifted to a protein platform for chemical processes → broader chemical functionality

### *Manipulating DNA, proteins, cells*

Ability to isolate and manipulate DNA has made possible **recombinant DNA technology**, or genetic engineering

Dramatic impact on our lives

- detection of genetic disorders
- forensic science
- everyday products, e.g., laundry detergents (enzymes that digest ‘dirt’)
- emerging new medicines

Manipulation of DNA

- **restriction nucleases** – proteins that cleave DNA at particular locations, enabling fragmentation into smaller parts in a predictable way
- **gel electrophoresis** – separation of DNA fragments of different sizes
- **hybridization** – double strands can be separated by heating just below boiling temperature → cooling then allows re-association to correct base pairing strands



- **probe sequences** of nucleotides can be used to hybridize to certain sequences of DNA
- **recombinant DNA** can be joined to existing DNA using **DNA ligase**

#### Cloning DNA using bacteria

- foreign DNA can be introduced into bacterial cells (**transformation**) that then will naturally replicate this DNA alongside their own during division → typically it integrates into the bacterial genome itself by **homologous recombination**
- **plasmids** are typically used → circular DNA molecules that exist independently of the bacterial chromosome
- plasmids also occur naturally, but those carrying foreign DNA are termed **vectors**

#### Cloning DNA using chemistry

- **polymerase chain reaction (PCR)** is a much quicker tool for duplicating DNA without cells, developed in 1980s
- a molecule of DNA must be heated up to separate the strands
- uses a heat resistant **DNA polymerase** isolated from hot-springs bacteria to then make copies
- repeated cycles of cooling and heating then enable repeated replication
- **amplicification** from one to billions of the same molecule

#### Sequencing DNA

- DNA polymerase used to make copies of a sequence
- **dideoxy DNA sequencing** → use of small amounts of dideoxyribonucleotides that terminate a growing copy (no way to add subsequent nucleotides)
- four separate experiments use either an A, T, C, G dideoxy base in addition to the four usual ones
- each experiments produces many copies of different lengths, but each terminated at a specific kind of nucleotide (either A, T, C, G)
- gel electrophoresis gives the molecular weight distribution in each of the four cases and can be used to show the sequence

- highly automated

#### Coaxing cells to make proteins

- **expression vectors** can be introduced with transcription, translation signals to ensure a gene (protein) is made
- introduced into cells, protein will be produced
- protein production can be monitored by making a fusion protein with **green fluorescent protein** (GFP), from the luminescent jellyfish

#### Manipulating the genome of existing animals

- genes can be knocked out or modified using hybridization techniques
- homologous recombination can be used to incorporate foreign DNA into a genome

#### Making antibodies

- immunize mouse with antigen
- mouse produces antibodies-manufacturing B-lymphocytes (white blood cells)
- hybridoma cells are made by fusing the B-lymphocytes with a myeloma cell (cancerous white blood cells)
- resultant cells produce antibody but also divide indefinitely (property of cancerous cells)
- culture in appropriate medium, grow cells
- lyse the cells
- fractionation, centrifugation

#### **Phage display** technologies used to find proteins that bind to a specific target molecule

- **phage** = bacterial virus = DNA inside protein coat
- phage DNA designed to encode for a particular protein in its coat, i.e., so that the protein is replicated on the surface of new copies of the phage
- amplification in E coli and random mutagenesis to build a library of different phages encoding for different proteins
- exposed to immobilized target binding molecule (e.g., protein or DNA)

- wash → binding proteins are kept
- re-infect E coli to amplify DNA sequence
- repeated rounds involving different levels of mutagenesis will **sort** to find proteins with good binding properties
- equivalent to a form of directed evolution on the lab bench

Protein purification using **column chromatography** uses the properties of solid matrix (beads) to selectively separate based on specific properties:

- size – gel filtration
- charge – ion exchange
- hydrophobicity
- affinity – specific interactions (adsorbed proteins, ligands, etc)

# Measurement of pH

In its most common interpretation, pH is used to specify the **degree of acidity or basicity** of an aqueous solution.

## Definition of pH

Historically, pH was first defined as the negative logarithm of the hydrogen ion concentration [ H<sup>+</sup> ]

i.e  $\text{pH} = -\log [ \text{H}^+ ]$

More rigorous definition of pH as the negative logarithm of the hydrogen ion activity in solution,

$$\text{pH} = -\log a_{\text{H}^+} = -\log \gamma [ \text{H}^+ ]$$

where  $a_{\text{H}^+}$  is the hydrogen ion activity and  $\gamma$  is the activity coefficient.

pH is a measure of hydrogen ion concentration in aqueous solution. It is an important parameter to determine the quality of water. The pH value is expressed as:

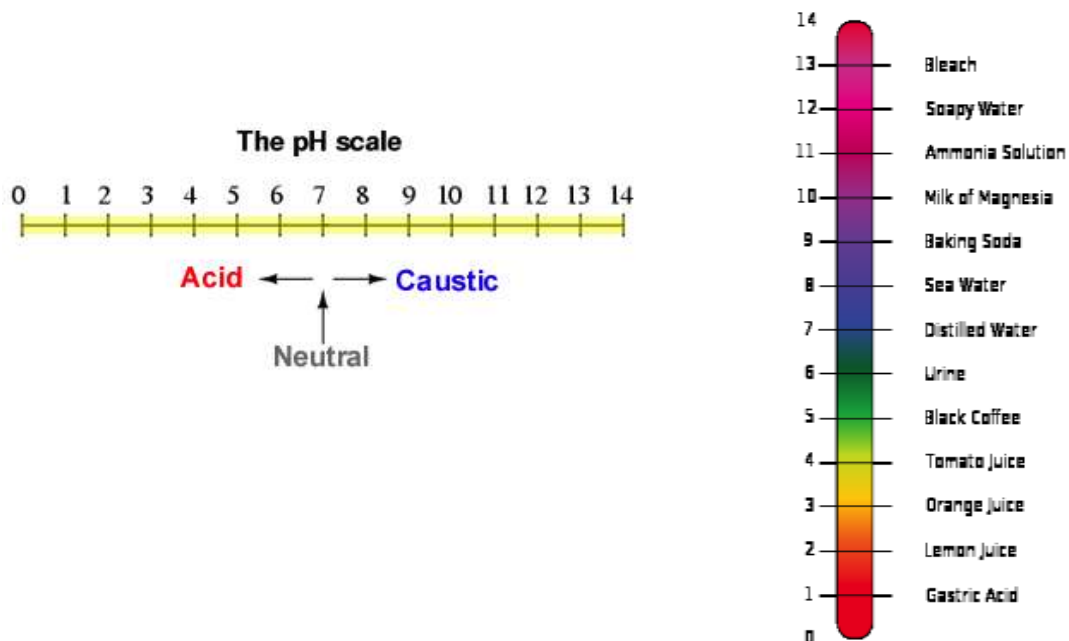
$$\text{pH} = \frac{1}{\log_{10} C}$$

Where  $C$  is the concentration of H<sup>+</sup> ions in a solution. In pure water, the concentration of H<sup>+</sup> ions is 10<sup>-7</sup> gm/ltr at 25° C. So the pH value is

$$\text{pH} = \frac{1}{\log_{10} 10^{-7}} = 7.$$

The advantage of using pH scale is that the activities of all strong acids and bases can be brought down to the scale of 0-14. The pH value of acidic solutions is in the range 0-7 and alkaline solutions in the range 7-14.

## pH Scale



Note : As pH value changes by 1 unit , then acidity and alkalinity values changes by factor of 10 .

## Why pH measurements are important ?

1. Measurement of pH of a solution is necessary to judge whether the **liquid is acidic , alkaline or neutral** .
2. The application areas are food and beverage industry , aquarium , gardening, medicine, biology, chemistry, agriculture, forestry, food science , environmental science, oceanography, civil engineering and many other applications.
3. Measurement of pH of liquids is necessary in many condensate systems as a **check on corrosion** , in **pharmaceuticals and drug production** for maximum yield , in food manufacturing to reduce spoilage and improve taste and in innumerable chemical processes .
4. The **continuous monitoring of blood pH** is essential for proper treatment of patients suffering from metabolic and respiratory problems .

## pH in nature

pH-dependent plant pigments that can be used as pH indicators occur in many plants, including hibiscus, red cabbage ,and red wine.



*Hydrangea macrophylla* blossoms vary from pink to blue, according to a pH-dependent mobilization and uptake of soil aluminium into the plants.

## Seawater

The pH of seawater plays an important role in the ocean's carbon cycle, and there is evidence of ongoing ocean acidification caused by carbon dioxide emissions.

## pH in living systems

The **pH of blood** is usually slightly basic with a value of pH **7.365**. This value is often referred to as physiological pH in biology and medicine.

The pH of different cellular compartments, body fluids, and organs is usually tightly regulated in a process called acid-base homeostasis.

The most common disorder in acid-base homeostasis is acidosis, which means an acid overload in the body, generally defined by pH falling below 7.35.

Compartment	pH
Gastric acid	1
Lysosomes	4.5
Granules of chromaffin cells	5.5
Human skin	5.5
Urine	6.0
Neutral H <sub>2</sub> O at 37 °C	6.81
Cytosol	7.2
Cerebrospinal fluid (CSF)	7.3
Blood	7.34–7.45
Mitochondrial matrix	7.5
Pancreas secretions	8.1

## How do you Measure pH ?

### pH Electrode

The pH value of a solution is measured by using **pH electrode**. It essentially consists of a pair of electrodes: **measuring and reference electrode**, both dipped in the solution of unknown pH. These two electrodes essentially form two *half-cells*; the total potential developed is the difference between the individual electric potential developed in each half cell. **While the potential developed in the reference cell is constant, the measuring cell potential is dependent on the hydrogen ion concentration of the solution** and is governed by *Nernst's equation*:

$$E = E_0 + \frac{RT}{nF} \ln(aC)$$

where ,

$E$ = e.m.f of the half cell

$E_0$ = e.m.f of the half cell under saturated condition

$R$ = Gas constant (8.314 J/°C)

$T$ = Absolute temperature (K)

$N$ = valance of the ion

$F$ = Faraday Constant = 96493 C

$a$ = Activity co-efficient ( $0 \leq a \leq 1$ ); for a very dilute solution,  $a \rightarrow 1$

$C$ = molar concentration of ions.

### Measuring Electrode

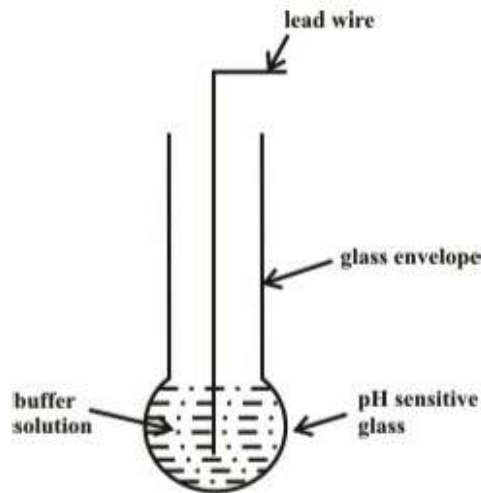


Fig. 7 Measuring Electrode

The measuring electrode is made of *thin sodium ion selective glass*. A potential is developed across the surface of this glass bulb, when dipped in aqueous solution. **This potential is sensitive to the H<sup>+</sup> ion concentration, having a sensitivity of 59.2 mv/pH at 25°C.** Fig. 7 shows the basic schematic of a measuring probe. The buffer solution inside the glass bulb has a constant H<sup>+</sup> ion concentration and provides electrical connection to the lead wire.

## Reference Electrode ( common use is Calomel electrode )

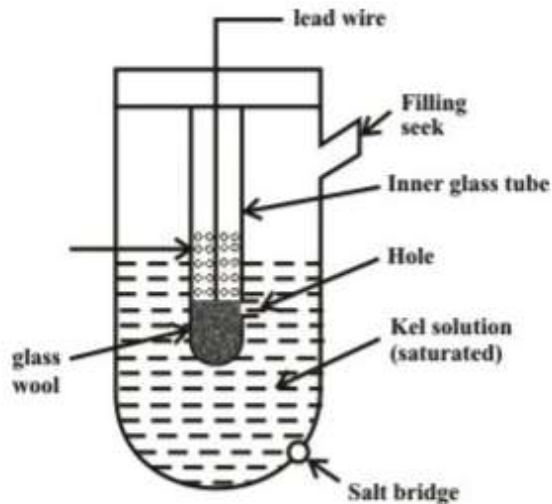


Fig. 8 Reference Electrode

Calomel ( mercury and mercurous chloride )

The basic purpose of a reference electrode is to provide continuity to the electrical circuit, since the potential across a single half cell cannot be measured. With both the measuring and reference cells dipped in the same solution, the potential is measured across the two lead wires. A reference electrode should satisfy the following basic requirements:

1. The potential developed should be independent of H<sup>+</sup> ion concentration.
2. The potential developed should be independent of temperature
3. The potential developed should not change with time.

Considering all these requirements, two types of reference electrodes are commonly used: (i) Calomel (Mercury-Mercurous Chloride) and (ii) Silver-Silver Chloride. The construction of a Calomel reference electrode is shown in Fig. 8. The electrical connection is maintained through the *salt bridge*.

## Combination type pH Electrode ( common form of pH measurement )

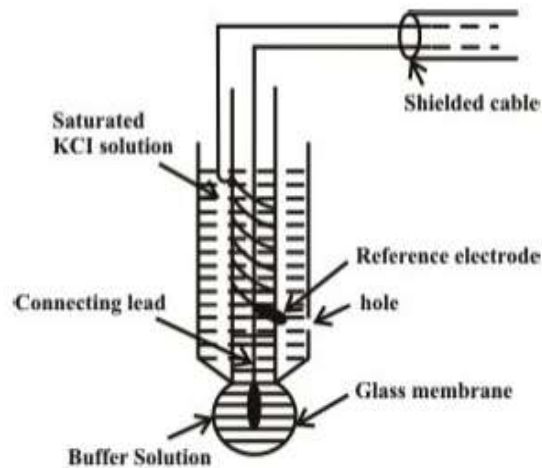
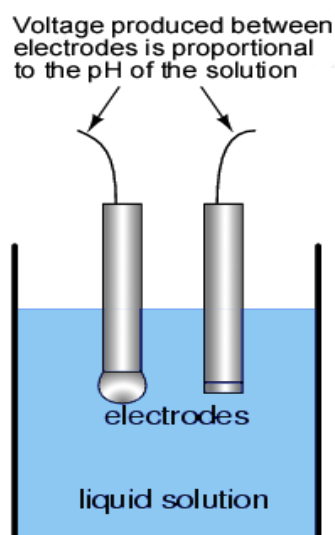


Fig. 9 Combination type pH electrode

Sometimes the reference and measuring electrodes are housed together, as shown in Fig. 9. This type of electrode is known as *Combination Electrode*. The reference electrode used in this case is Silver-Silver Chloride. The combination is dipped in the solution whose pH is to be measured and the output voltage is the difference between the e.m.f.s generated by the measuring glass electrode and the reference electrode.



## Measuring scheme

**The sensitivity of pH probe is around 59.2mv/pH at 25°C.** This sensitivity should be sufficient for measurement of voltage using ordinary electronic voltmeters. But, that is not the case; special



measuring circuits are required for measurement of pH voltage. This is because of the fact that the internal resistance of the pH probe as a voltage source is very high, in the order of  $10^{10}$ - $10^{12} \Omega$ . This is because of the fact; the electrical path between the two lead wires is completed through the glass membrane.

As a result, the input resistance for of the measuring device must be at least ten times electrode resistance of the electrode. FET-input amplifier circuits are normally used for amplifying the voltage from the pH probe. Not only that, the insulation resistance between the leads must also be very high. They are normally provided with moisture resistance insulation coating.

**The voltage in the pH probe is temperature dependent**, as evident from Nernst equation. As a result suitable temperature compensation scheme should also be provided in the measuring scheme.

## Electrochemical Methods of pH Measurement

### The Glass Membrane Indicator Electrode

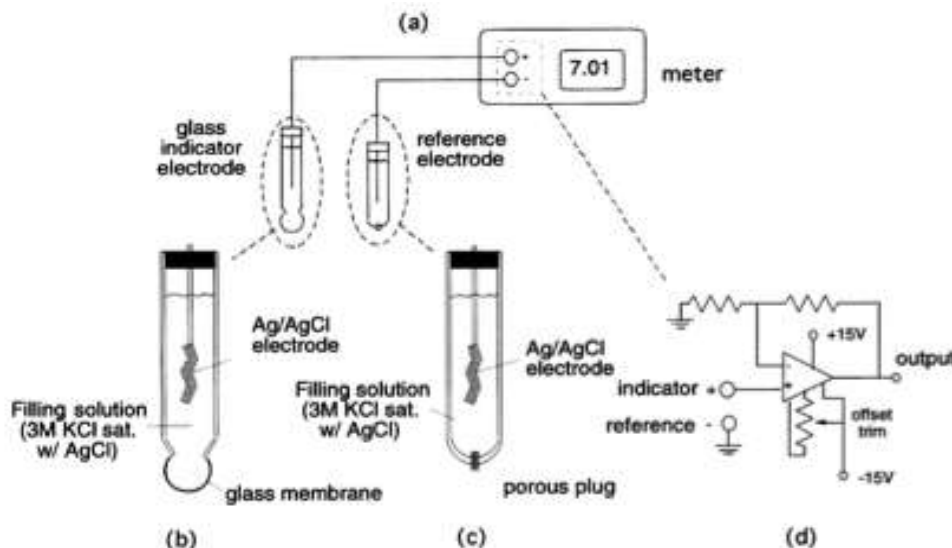


FIGURE 71.1 pH measurement using a glass membrane electrode: (a) measurement system comprising a pH meter, indicator, and reference electrodes; (b) indicator electrode construction; (c) reference electrode construction; and (d) amplifier circuit.

1. The most widely used method for measuring pH is the glass membrane electrode. As illustrated schematically in Figure 71.1(a), a pH meter measures the electrical potential difference (voltage) that develops between a glass membrane pH *indicator / measuring* electrode and a *reference* electrode immersed in the sample to be tested.
2. The indicator and reference electrodes are commonly combined into a single, functionally equivalent, probe, referred to as a combination electrode. The glass membrane of the indicator electrode develops a pH-dependent potential.
3. The construction of a typical pH indicator electrode is illustrated in Figure 71.1(b). The glass membrane at the tip of the electrode, which acts as the transducer of pH, is approximately 0.1 mm thick.
4. One side of the membrane contacts the sample while the other contacts the electrode filling

solution, an electrolyte of defined composition and pH. A reference element (e.g., a silver chloride coated silver wire) immersed in the filling solution makes a stable electrical contact between the potential measuring circuitry of the pH meter and the electrolyte in contact with the inner side of the glass membrane.

5. The reference electrode illustrated in Figure 71.1(c) provides a means of making electrical contact between the meter and the sample that is in contact with the external side of the indicator electrode's pH-sensitive glass membrane. Like the indicator electrode, the body of the reference electrode is filled with an electrolyte into which a reference element is immersed.
6. **The electrical potential difference between the pH indicator electrode and the reference electrode provides a measure of pH.**
7. The main function of the pH meter of Figure 71.1(a) is to measure this difference, with a precision of 0.1 mV or better. The amplifier circuit of Figure 71.1(d) illustrates how this may be done. Due to the high electrical resistance of the indicator electrode's glass membrane, the meter must have a correspondingly high input impedance.

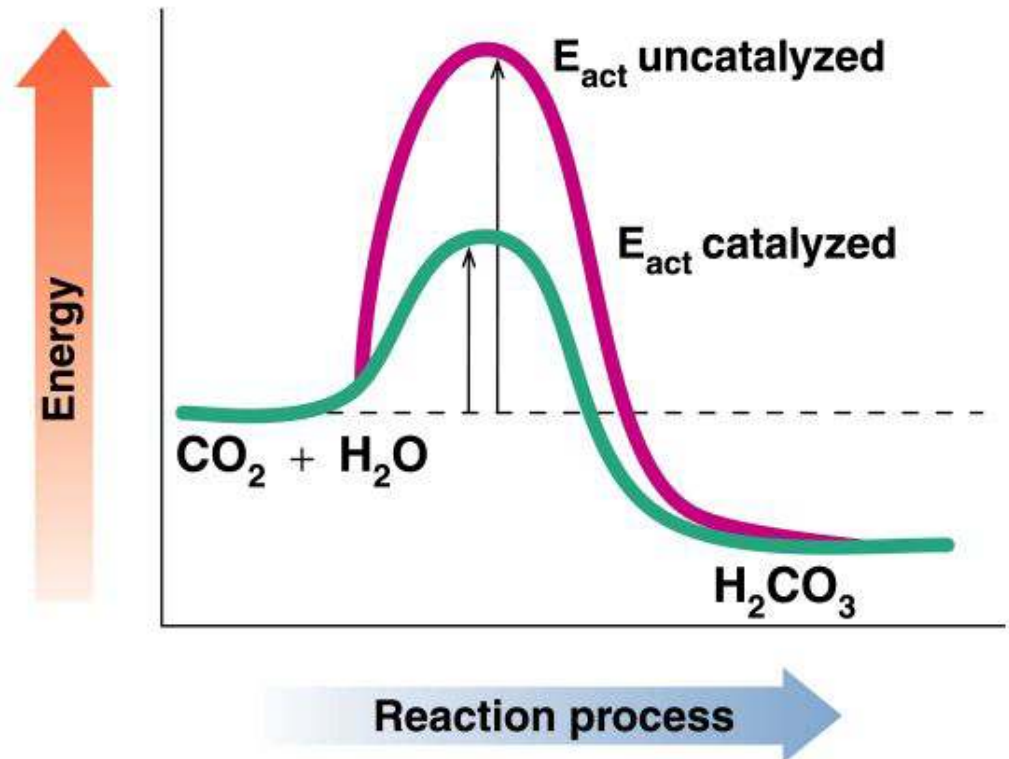
**Enzyme**

# Definition of enzyme

- Enzymes are biological catalysts.
- A Catalyst is defined as "a substance that increases the rate of a chemical reaction without being itself changed in the process."

# Enzymes as Biological Catalysts

- **Enzymes** are proteins that increase the rate of reaction by lowering the energy of activation
- They catalyze nearly all the chemical reactions taking place in the cells of the body
- Enzymes have unique three-dimensional shapes that fit the shapes of reactants (**substrates**)



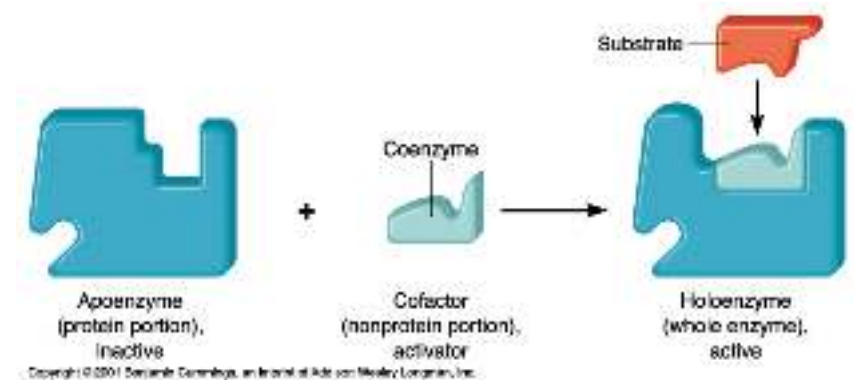
## 2. Properties of enzymes (important!)

- **Catalytic efficiency – high efficiency,  $10^3$  to  $10^{17}$  faster than the corresponding uncatalyzed reactions**
- **Specificity - high specificity, interacting with one or a few specific substrates and catalyzing only one type of chemical reaction.**
- **Mild reaction conditions-  $37^\circ\text{C}$ , physiological pH, ambient atmospheric pressure**

# 3. Chemical composition of enzymes

(1) Simple protein

(2) Conjugated protein



Holoenzyme = Apoenzyme + Cofactor

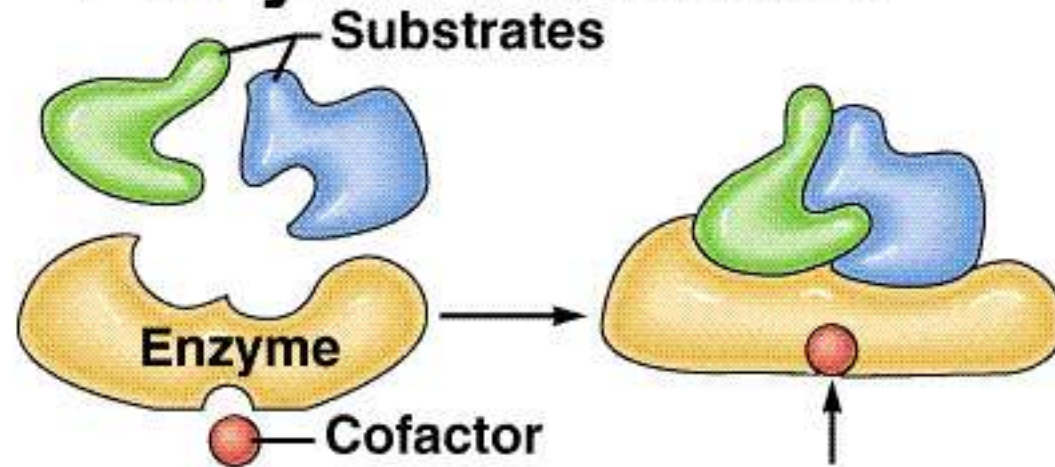
Cofactor

Coenzyme : loosely bound to enzyme (non-covalently bound).

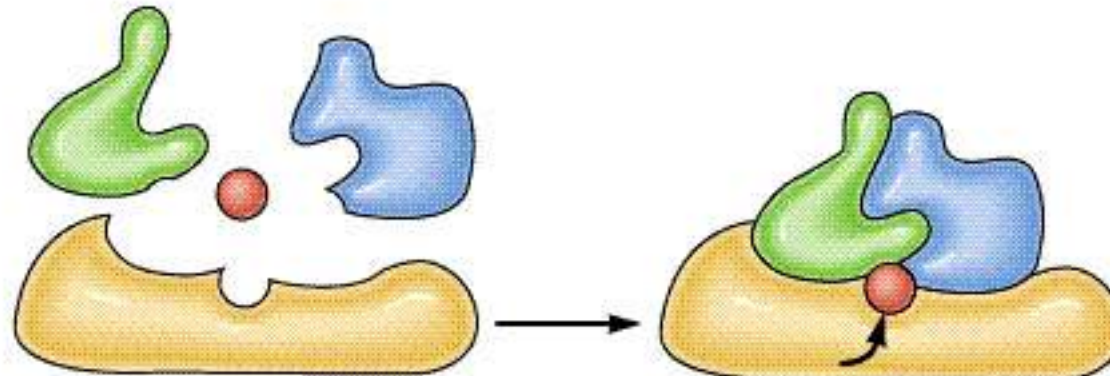
Prosthetic group : very tightly or even covalently bound to enzyme (covalently bound)

Copyright © The McGraw-Hill Companies, Inc. Permission required for reproduction or display.

# Roles of Cofactors in Enzyme Function



Cofactor changes conformation of active site.



Cofactor participates in temporary bonding between active site and substrates.



## 4. Classification of enzymes

### (1). By their composition

1). Monomeric enzyme

2). Oligomeric enzyme

3). Multienzyme complex: such as  
Fatty acid synthase

## (2) Nomenclature

- Recommended name

- Enzymes are usually named according to the reaction they carry out.

- To generate the name of an enzyme, the suffix *-ase* is added to the name of its substrate (e.g., **lactase** is the enzyme that cleaves lactose) or the type of reaction (e.g., **DNA polymerase** forms DNA polymers).

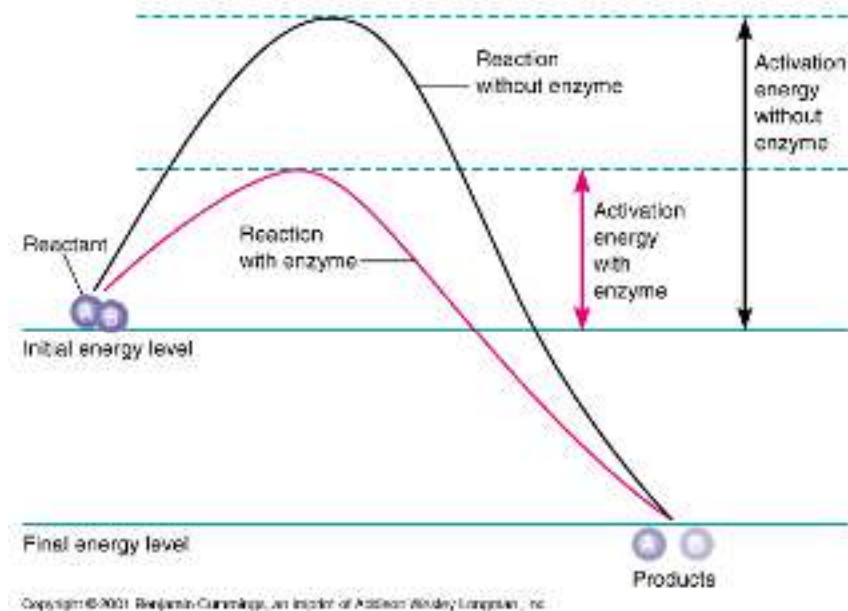
- Systematic name (International classification)

- By the reactions they catalyze (Six classes)

## 5. How enzymes work (important!)

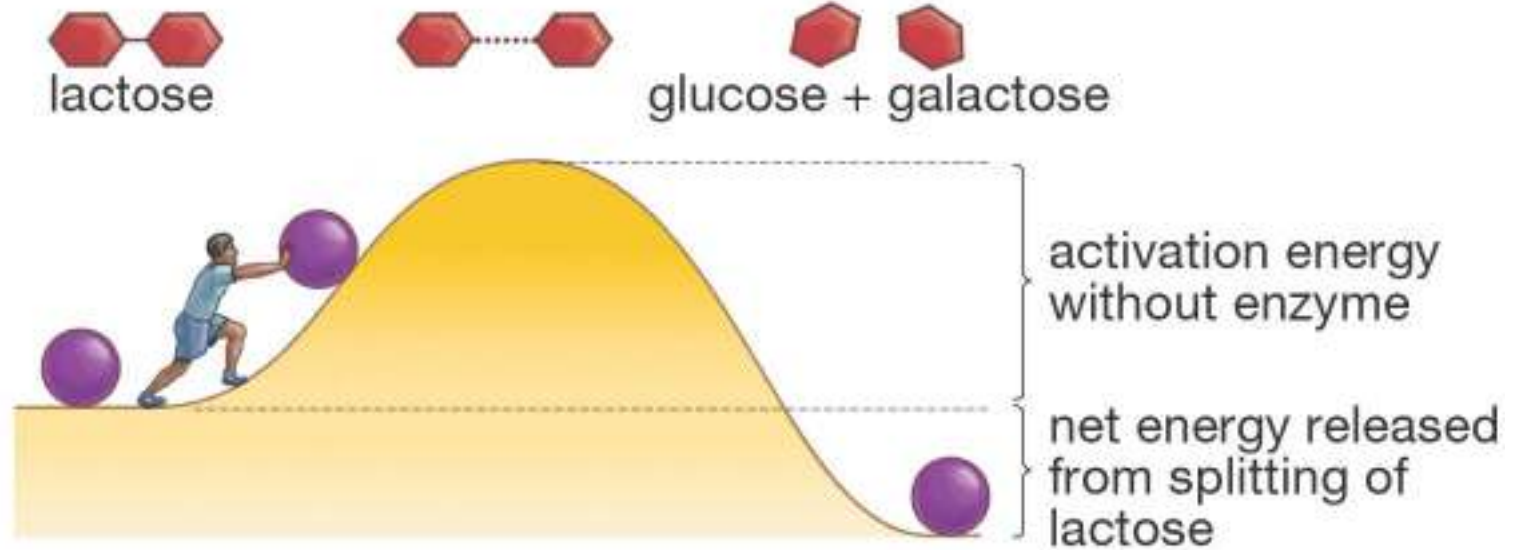
### 1) Enzymes lower a reaction's activation energy

- All chemical reactions have an energy barrier, called the **activation energy**, separating the reactants and the products.
- **activation energy**: amount of energy needed to disrupt stable molecule so that reaction can take place.

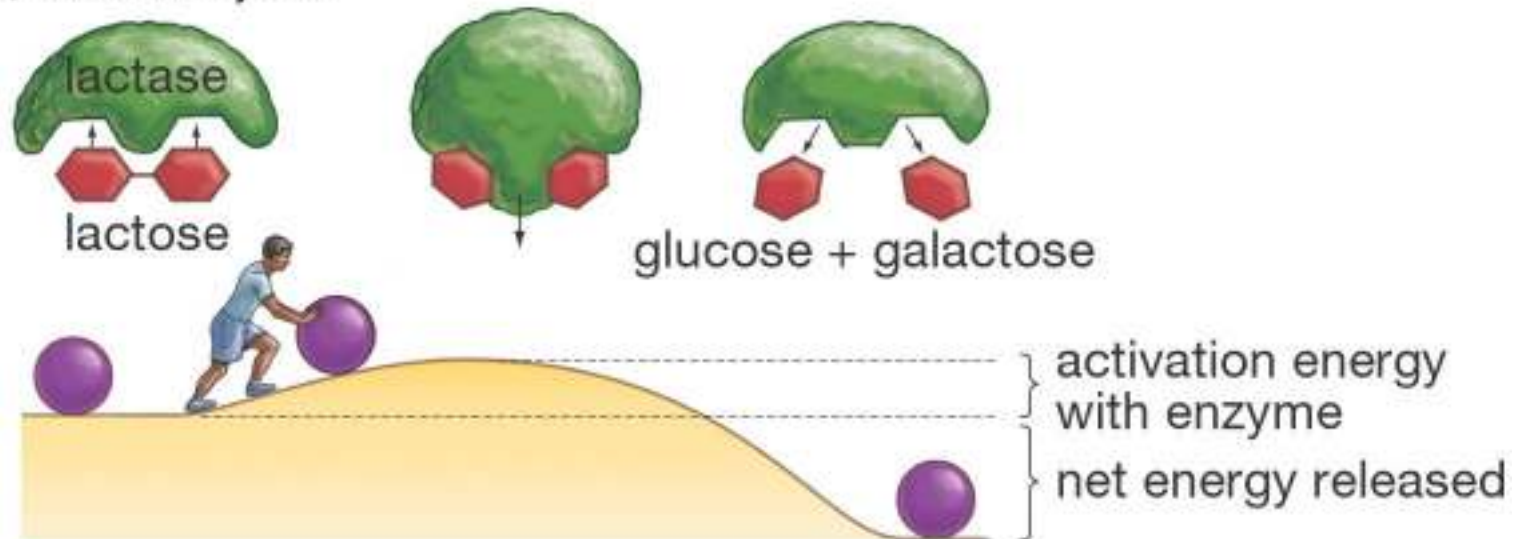


# Enzymes Lower a Reaction's Activation Energy

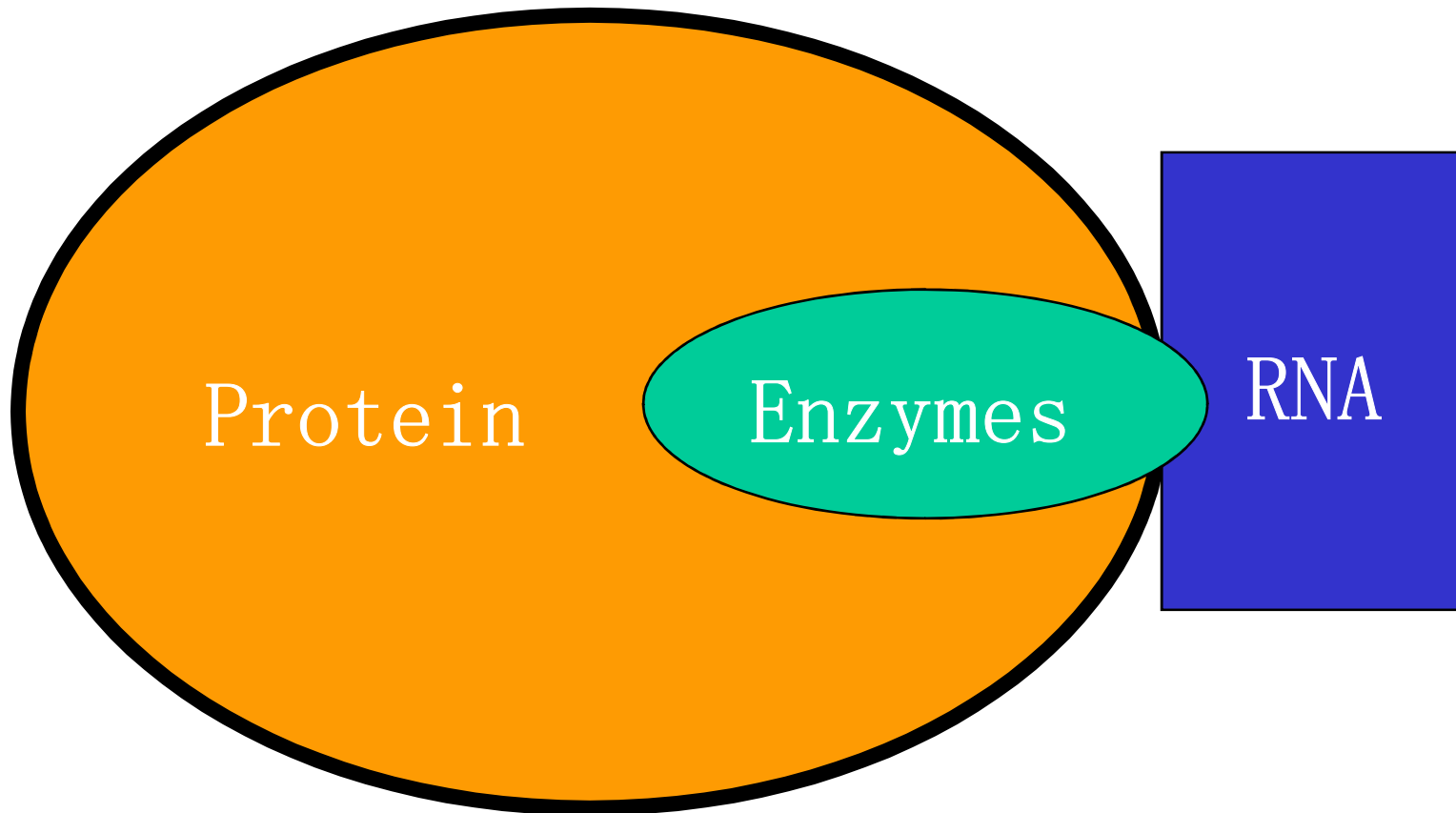
(a) Without enzyme



(b) With enzyme



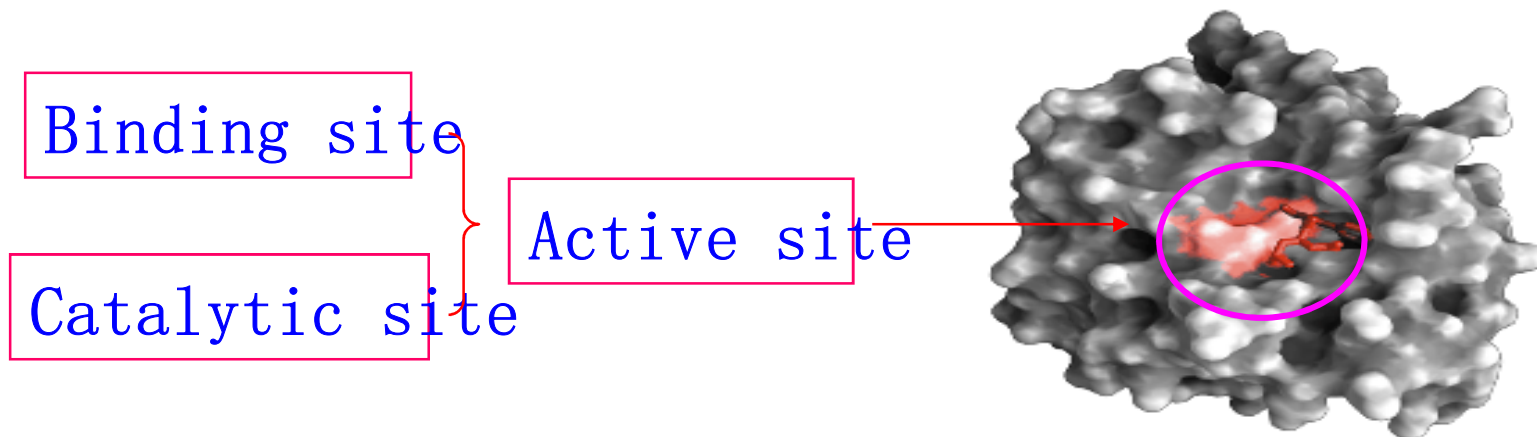
What is the difference between an enzyme and a protein?



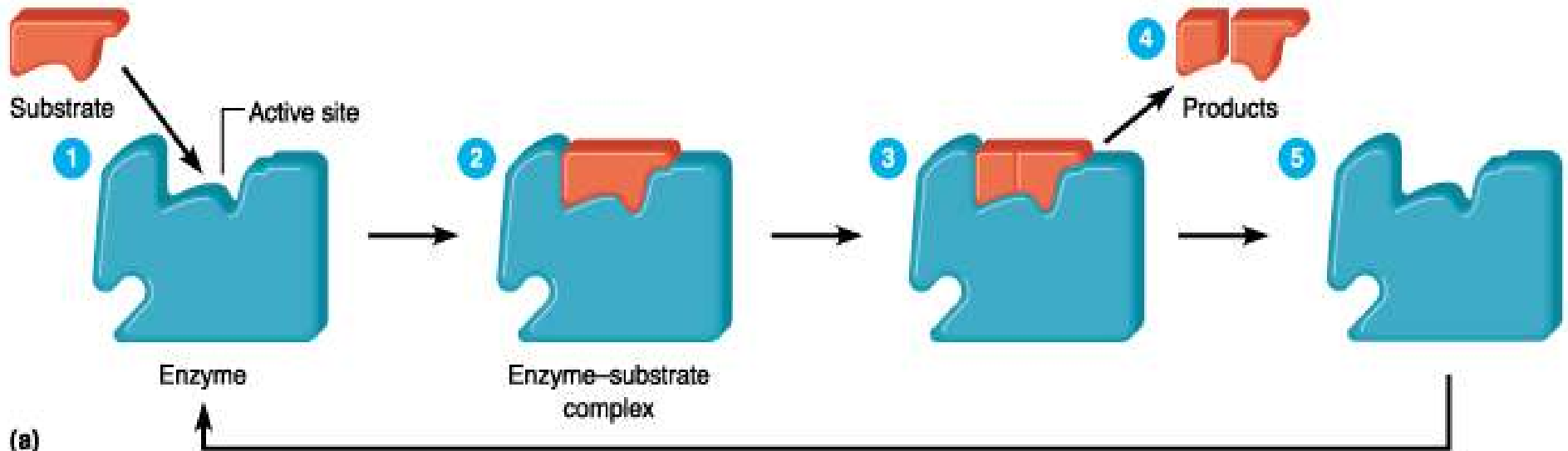
- All enzymes are proteins except some RNAs
- not all proteins are enzymes

## 2) The active site of the enzyme

- Enzymes bind substrates to their active site and stabilize the transition state of the reaction.
- The **active site** of the enzyme is the place where the substrate binds and at which catalysis occurs.
- The active site binds the substrate, forming an enzyme-substrate(ES) complex.



# Enzymatic reaction steps



(a)

Copyright © 2001 Benjamin Cummings, an imprint of Addison Wesley Longman, Inc.

1. Substrate approaches active site
2. Enzyme-substrate complex forms
3. Substrate transformed into products
4. Products released
5. Enzyme recycled

## 6. Enzyme activity

- Enzymes are never expressed in terms of their concentration (as mg or  $\mu\text{g}$  etc.), but are expressed only as activities.
- **Enzyme activity** = moles of substrate converted to product per unit time.
  - The **rate** of appearance of product or the rate of disappearance of substrate
  - Test the absorbance: spectrophotometer



# 7. Factors affecting enzyme activity

- Concentration of substrate
- Concentration of enzyme
- Temperature
- pH
- Activators
- Inhibitors

# Enzymes in clinical diagnosis

- An enzyme test is a **blood** test or **urine** test that measures levels of certain enzymes to assess how well the body's systems are functioning and whether there has been any tissue damage. (why?)

- Common enzymes used for clinical diagnosis include:
  - alanine aminotransferase (ALT, also called glutamate pyruvate transaminase, GPT)
  - alkaline phosphatase
  - amylase
  - aspartate aminotransferase
  - creatine kinase
  - lactate dehydrogenase

## BT 510 Analytical Biotechnology Lab

### ESTIMATION OF DNA BY DIPHENYLAMINE REACTION

#### Principle:

The deoxyribose in DNA in the presence of acid forms  $\beta$ -hydroxylevulinialdehyde which reacts with diphenylamine to give a blue colour with a sharp absorption maximum at 595nm. In DNA, only the deoxyribose of the purine nucleotides react, so that the value obtained represents half of the total deoxyribose present.

#### METHODOLOGY

##### a) Materials required:

###### 1. Equipments:

- Spectrophotometer
- Water bath

###### 2. Chemicals/reagents:

- Standard DNA solution (0.25mg/ml)
- Diphenylamine reagent
- DNA sample in saline citrate buffer
- Saline citrate buffer (0.15M NaCl, 0.015M sodium citrate, pH 7.0)
- Glacial acetic Acid
- Concentrated  $H_2SO_4$
- Ethanal

###### 3. Glasswares and others:

- Test tubes
- Pipettes
- Graduated cylinder

##### b) Procedure:

**Preparation of reagent:** Dissolve 1.5g diphenylamine in 100ml of glacial acetic acid. Add 1.5ml of conc  $H_2SO_4$ . Store the solution in a dark glass bottle. On the day of use, prepare a fresh solution of ethanal (1ml) in  $dH_2O$  (50ml). Add 0.5ml of this solution to each 100ml of the diphenylamine solution.

**Caution:** *Wear eye protection and use a fume cupboard when preparing this reagent. Diphenylamine is harmful if ingested or inhaled and may irritate skin or eyes if it comes into contact with them.*

c) **Assay:**

1. Prepare a series of dilutions of standard DNA (0.25mg/ml) in saline citrate buffer to give a concentration of 50-500 $\mu$ g/ml.
2. Prepare all the samples in triplicate.
3. To 2ml of each dilution of blank, standard and unknown add 4ml of diphenylamine reagent and mix. Tube 1 is used as blank and tubes 2 through 7 are used for construction of a standard calibration curve for DNA. Tubes 8-11 are for unknown samples. (Table1)
4. Incubate all the tubes in boiling water for 10 min.
5. Cool the tubes and read the absorbance at 595nm against the blank.
6. Construct a standard curve of absorbance  $A_{595}$  vs. quantity of DNA and then calculate the concentration of unknown DNA dissolved in the saline citrate solution.

**Table1:**

Sl No	DNA		DH <sub>2</sub> O ( $\mu$ l)	Reagent (ml)	$A_{595}$
	( $\mu$ l)	( $\mu$ g)			
1.	-	-	2000	4	
2.	200	50	1800	4	
3.	400	100	1600	4	
4.	800	200	1200	4	
5.	1200	300	800	4	
6.	1600	400	400	4	
7.	2000	500	-	4	
8.	Unknown (A)	-	-	4	
9.	Unknown (B)	-	-	4	
10.	Unknown (C)	-	-	4	
11.	Unknown (D)	-	-	4	

**Calculation:** Determine the amount of DNA in the unknown sample by plotting a standard curve of  $A_{595}$  on Y-axis and  $\mu$ g of DNA on X-axis.

**References:**

1. Plummer, D.T. (1977) *An Introduction to Practical Biochemistry*. Tata McGraw Hill, Bombay.
2. J. Jayaram. (1981) *Laboratory Manual in Biochemistry*. New Age International Ltd. New Delhi.
3. Burton, K. (1956) A study of the conditions and mechanism of the diphenylamine reaction for the colorimetric estimation of deoxyribonucleic acid. *Biochemical Journal*. **62**: 314-323.

### Estimation of RNA by Orcinol Reaction

Dr. Mahesha H B, Yuvaraja's College, University of Mysore, Mysore.

**Aim:** To estimate the concentration of RNA by orcinol reaction.

**Principle:** This is a general reaction for pentoses and depends on the formation of furfural when the pentose is heated with concentrated hydrochloric acid. Orcinol reacts with the furfural in the presence of ferric chloride as a catalyst to give a green colour, which can be measured at 665 nm.

#### **Requirements:**

1. Standard RNA solution- 200 $\mu$ g/ml in 1 N perchloric acid/buffered saline.
2. Orcinol Reagent- Dissolve 0.1g of ferric chloride in 100 ml of concentrated HCl and add 3.5 ml of 6% w/v orcinol in alcohol.
3. Buffered Saline- 0.5 mol/litre NaCl; 0.015 mol/litre sodium citrate, pH 7.

#### **Procedure:**

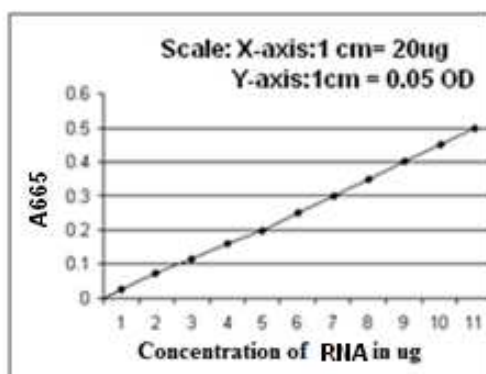
1. Pipette out 0.0, 0.2, 0.4, 0.6, 0.8 and 1 ml of working standard in to the series of labeled test tubes.
2. Pipette out 1 ml of the given sample in another test tube.
3. Make up the volume to 1 ml in all the test tubes. A tube with 1 ml of distilled water serves as the blank.
4. Now add 2 ml of orcinol reagent to all the test tubes including the test tubes labeled 'blank' and 'unknown'.
5. Mix the contents of the tubes by vortexing / shaking the tubes and heat on a boiling water bath for 20 min.
6. Then cool the contents and record the absorbance at 665 nm against blank.
7. Then plot the standard curve by taking concentration of RNA along X-axis and absorbance at 665 nm along Y-axis.
8. Then from this standard curve calculate the concentration of RNA in the given sample.

**Result:** The given unknown sample contains ---- $\mu$ g RNA/ml.

#### **Observations and Calculations**

Volume of standard (200 $\mu$ g/ml) RNA	Volume of distilled water (ml)	Concentration of RNA ( $\mu$ g)	Volume of Orcinol reagent (ml)	Incubate in boiling water bath for 20 Min & Cool	A <sub>665</sub>
0.0	1.0	00	2		0.00
0.2	0.8	40	2		
0.4	0.6	80	2		
0.6	0.4	120	2		
0.8	0.2	160	2		
1.0	0.0	200	2		
1.0 Unknown	0.0	To be estimated	2		

**Standard curve for RNA estimation by Orcinol reaction**



#### **References**

1. Plummer D.T., 1988. An introduction Practical Biochemistry, 3<sup>rd</sup> ed, Tata Mc Graw-Hill Pub.Co., New Delhi, pp 221.
2. Introductory Practical Biochemistry, Editors: S.K.Sawhney & Randhir Singh, Narosa Pub. House, pp 74-75.

-----

## Fatty Acid Biosynthesis

- Synthesis takes place in the cytosol
- Intermediates covalently linked to acyl carrier protein
- Activation of each acetyl CoA.
- $\text{acetyl CoA} + \text{CO}_2 \rightarrow \text{Malonyl CoA}$
- Four-step repeating cycle, extension by 2-carbons / cycle
  - Condensation
  - Reduction
  - Dehydration
  - reduction

## Fatty acid synthesis

- The enzymes of fatty acid synthesis are packaged together in a complex called as fatty acid synthase (FAS).
- The product of FAS action is palmitic acid. (16:0).
- Modifications of this primary FA leads to other longer (and shorter) FA and unsaturated FA.
- The fatty acid molecule is synthesized 2 carbons at a time
- FA synthesis begins from the methyl end and proceeds toward the carboxylic acid end. Thus, C16 and C15 are added first and C2 and C1 are added last.
- C15 and C16 are derived directly from acetylCoA. For further step-wise 2-carbon extensions, acetylCoA is first activated to malonyl CoA, a 3-carbon compound, by the addition of a  $\text{CO}_2$ .

### Citrate Shuttle

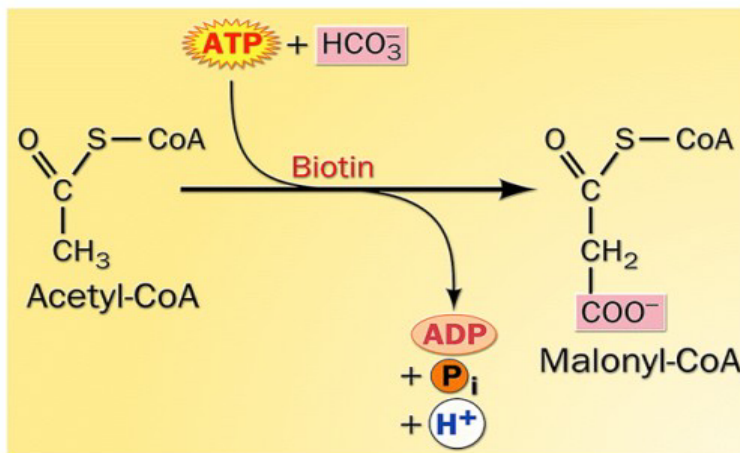
- FAs are synthesized in the cytoplasm from acetylCoA
- AcetylCoA generated from pyruvate by the action of PDH and by  $\beta$ -oxidation of fatty acids is in the mitochondria.
- For fatty acid biosynthesis, acetylCoA has to be transported from the mitochondria to the cytoplasm. This is done via a shuttle system called the **Citrate Shuttle**.
- AcetylCoA reacts with oxaloacetate to give citrate. A **tricarboxylate translocase** transports citrate from mitochondria to cytosol.
- In the cytosol, citrate is cleaved back to oxaloacetate and acetylCoA. This reaction is catalyzed by ATP-citrate lyase and requires the hydrolysis of one molecule of ATP.

### Citrate Shuttle (regeneration of pyruvate)

- Oxaloacetate is converted back to pyruvate for re-entry into mitochondria
- Step 1. Oxaloacetate + NADH + H<sup>+</sup> → malate + NAD<sup>+</sup>. Reverse of the TA cycle reaction. Catalyzed by cytosolic malate dehydrogenase.
- Step 2. Malate + NADP<sup>+</sup> → pyruvate + CO<sub>2</sub> + NADPH. Catalyzed by malic enzyme
- Pyruvate translocase transports pyruvate into mitochondria.
- Pyruvate is converted to oxaloacetate by pyruvate carboxylase with coupled hydrolysis of one ATP. Pyruvate + ATP + CO<sub>2</sub> + H<sub>2</sub>O → oxaloacetate + ADP + Pi (reaction of gluconeogenesis)
- Net Reaction: NADP<sup>+</sup> + NADH + H<sup>+</sup> + ATP + H<sub>2</sub>O → NADPH + NAD<sup>+</sup> + ADP + Pi
- Thus, transport of acetylCoA to cytosol requires expense of one ATP and conversion of one NADH to NADPH.



### Reaction catalyzed by Acetyl CoA Carboxylase



Activation of acetate : Acetyl-CoA to malonyl CoA

### MalonylCoA

- Malonyl CoA is synthesized by the action of acetylCoA carboxylase. Biotin is a required cofactor.
- $\text{CH}_3\text{COSCoA} + \text{CO}_2 + \text{ATP} \rightarrow \text{OOC-CH}_2\text{-CO-SCoA} + \text{ADP} + \text{P}_i$  (enzyme: acetylCoA carboxylase)
- This is an irreversible reaction. AcetylCoA carboxylation is a rate-limiting step of FA biosynthesis.
- AcetylCoA carboxylase is under allosteric regulation. Citrate is a positive effector and palmitoyl CoA is a negative effector.

### Fatty Acid Synthase (FAS)

- FAS is a polypeptide chain with multiple domains, each with distinct enzyme activities required for fatty acid biosynthesis.
- ACP: Recall that CoA is used as an activator for  $\beta$ -oxidation. For fatty acid biosynthesis, the activator is a protein called the acyl carrier protein (ACP). It is part of the FAS complex. The acyl groups get anchored to the CoA group of ACP by a thioester linkage
- Condensing enzyme/ $\beta$ -ketoacyl synthase (K-SH). Also part of FAS, CE has a cysteine SH that participates in thioester linkage with the carboxylate group of the fatty acid.
- During FA biosynthesis, the growing FA chain alternates between K-SH and ACP-SH

### Step-wise reactions

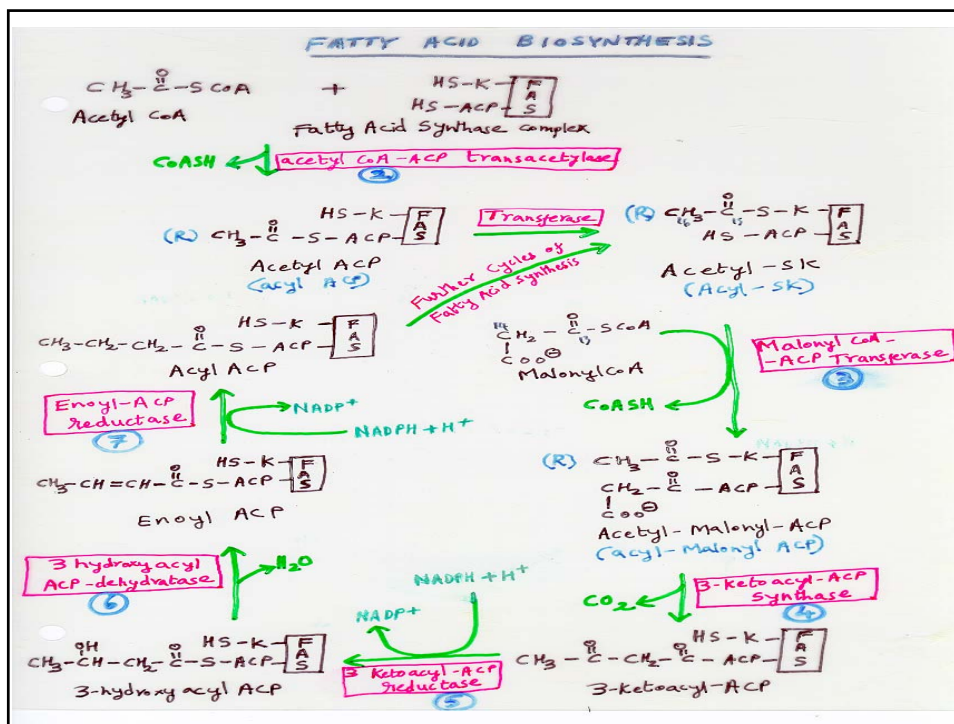
1. The **acetyl group gets transferred from CoA to ACP** by **acetyl CoA-ACP transacylase**.
2. The **acetyl (acyl) group next gets transferred to the K arm** of FAS complex.
3. Next, the **malonyl group gets transferred from CoA to ACP** by **malonyl CoA ACP transacylase**. This results in both arms of FAS occupied forming acyl-malonyl-ACP.
4. The COO group of malonyl ACP is **removed as CO<sub>2</sub>**, the **acetyl group (C16 and C15) gets transferred to the alpha carbon of malonyl ACP**. This results in **3-keto acyl ACP**.

### Reactions of FA biosynthesis (continued)

- The 3-keto group is converted to a  $\text{CH}_2$  by a series of reactions reverse to FA  $\beta$ -oxidation. Namely,
  1. reduction to hydroxyl group. Enz: 3-keto acyl ACP reductase
  2. dehydration to form a 2,3 double bond and Enz: 3-hydroxy acyl ACP dehydratase
  3. a second reduction to remove the double bond. Enz: Enoyl ACP reductase
- Both reduction reactions require the reduced **cofactor NADPH**. This is **generated by the hexose monophosphate pathway** of phosphogluconate pathway and during the citrate shuttle

### Repeat cycles for chain elongation

- The result of the first cycle of fatty acid biosynthesis is a four carbon chain associated to the ACP arm.
- This chain gets transferred to the K arm.
- A new malonyl CoA is introduced on the ACP arm.
- The reactions proceed as before. For each cycle the acyl group transferred to the  $\alpha$ -carbon of malonyl CoA is 2-carbons longer the previous cycle.
- At the end of 7 cycles a 16 carbon chain is attached to the ACP arm (palmitoyl ACP).
- The C16 unit is hydrolyzed from ACP yielding free palmitate
- Net reaction:  $\text{Acetyl CoA} + 7 \text{ malonyl CoA} + 14 \text{ NADPH} + 14 \text{ H}^+ \rightarrow \text{Palmitate} + 7 \text{ CO}_2 + 8 \text{ CoA} + 14 \text{ NADP}^+ + 6\text{H}_2\text{O}$



### Differences between FA degradation and synthesis

Characteristic	Degradation	Synthesis
Location	Mitochondrial Matrix	Cytosol
Activated intermediates	Thioesters of CoA	Thioesters of ACP
Enzymes	4 distinct, nonassociated enzymes	FAS is a multienzyme complex
Process	2-Carbon fragments removed as acetyl CoA	2-Carbon elongation using malonyl CoA
Direction	Starts at carboxyl end	Starts at methyl end
Fatty acid size	All sizes are degraded	Only Palmitate is made
Redox reaction cofactors	FAD/FADH2 and NAD+/NADH	NADP+/NADPH
Major tissue site	Muscle and liver	Liver
Nutritional status	In starvation	After carbohydrate-rich meal
Hormonal regulation	Low insulin / glucagon ratio	High insulin/glucagon ratio
Activator	FFA generated by hormone-sensitive lipase	Citrate
Inhibitor	Malonyl CoA (inhibits carnitine acyl transferase)	Fatty acyl CoA (inhibits acetyl CoA carboxylase)

### Modification of Palmitic acid

- Palmitic acid is converted to palmitoyl CoA for modification.
- Fatty acids modification takes place by the action of enzyme systems that are present on the cytoplasmic face of the ER membrane.
- FA longer than palmitic acid are synthesized by an elongation enzyme system. Additional carbons are added in 2-carbon units using malonyl CoA as the donor.
- Unsaturated fatty acids are synthesized by the action of specific enzymes called as fatty acid CoA desaturases. The desaturases are specific for specific positions of the double bond.

### Essential Fatty Acids

- Mammals lack the enzymes to introduce double bonds at carbon atoms beyond C9.
- Hence, all fatty acids containing a double bond at positions beyond C9 have to be supplied in the diet. These are called *Essential fatty acids (EFA)*.
- Linoleate (18:2  $\Delta^{9,12}$ ) and Linolenate (18:3  $\Delta^{9,12,15}$ ) are the two essential fatty acids in mammals.
- Other unsaturated fatty acids such as arachidonic acid (20:4  $\Delta^{5,8,11,14}$ ) are derived from these two EFA.
- Eicosanoids are derivatives of arachidonic acid and have hormonal and signaling properties. Classified into prostaglandins, thromboxanes and leukotrienes

### Regulation of FA metabolism

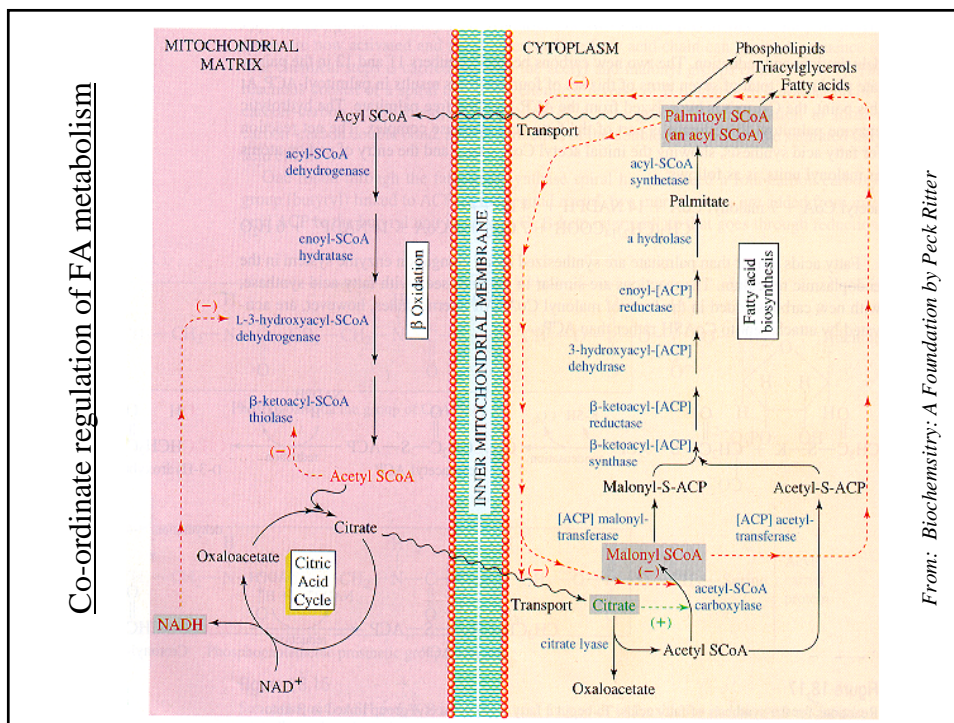
- The two processes of  $\beta$ -oxidation and FA synthesis are coordinately regulated.
- Three hormonal signals determine the state of FA metabolism. Glucagon and epinephrine inhibit FA synthesis and favor oxidation, whereas insulin is anti-lipolytic and stimulates FA biosynthesis.
- The mechanism of hormonal regulation is covalent phosphorylation of acetylCoA carboxylase, the rate-limiting step of FA biosynthesis.
- Acetyl CoA carboxylase is inhibited by phosphorylation. Phosphorylated acetylCoA carboxylase can regain partial activity by allosterically binding citrate.

### Metabolic Enzymes Regulated by Covalent Phosphorylation

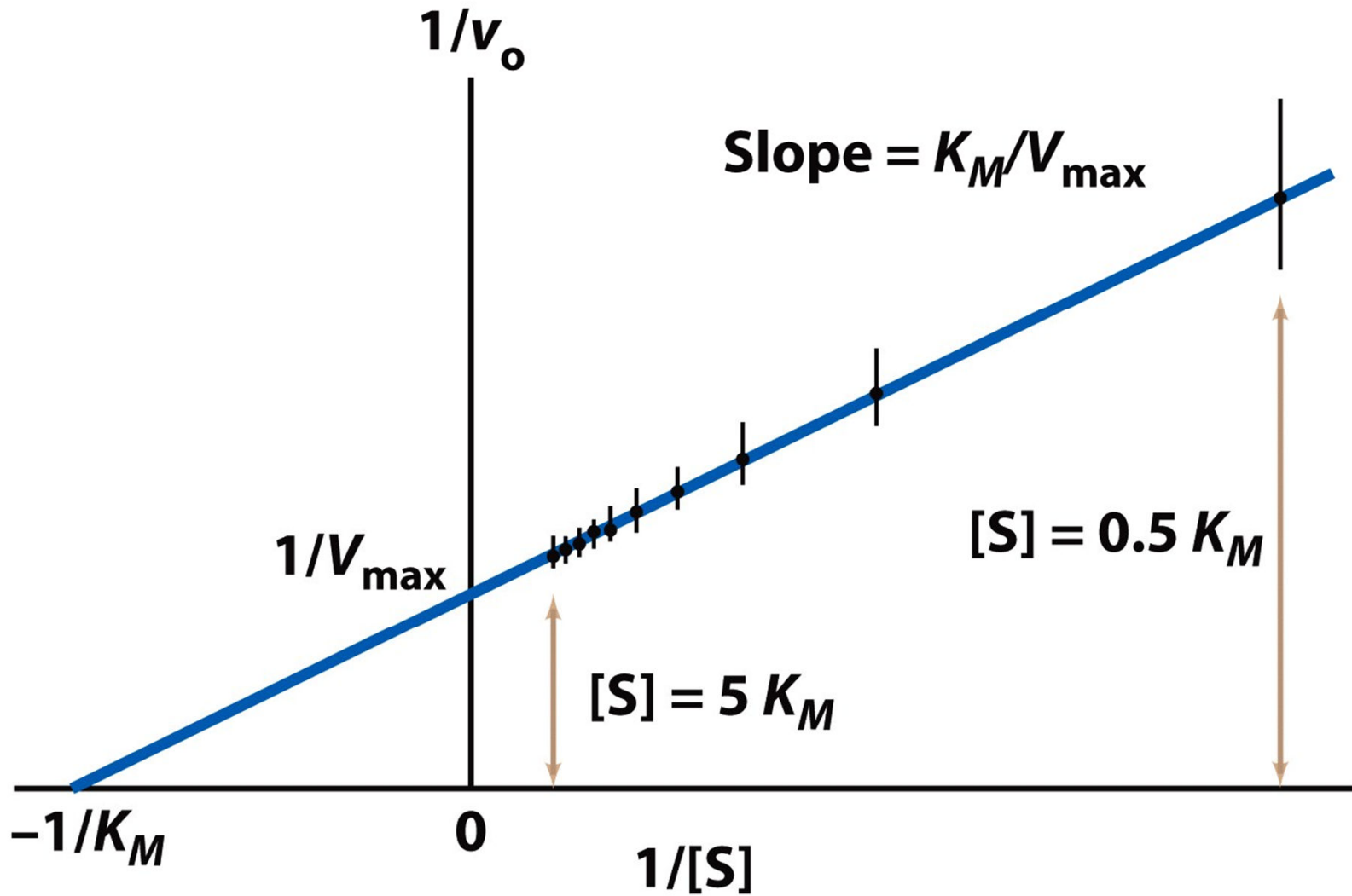
<u>Enzyme</u>	<u>Pathway</u>	<u>Reaction Catalyzed</u>	<u>Metabolic Role</u>	<u>Effect of Covalent Phosphorylation</u>
Phosphofructokinase 2	Glycolysis	Formation of F-2,6-BP	catabolic	Inactivation
Pyruvate kinase	Glycolysis	Formation of pyruvate	catabolic	Inactivation
Pyruvate dehydrogenase	Pre-TCA cycle	Formation of acetylCoA	catabolic	Inactivation
Glycogen phosphorylase	Glycogenolysis	Degradation of glycogen	catabolic	Activation
Glycogen synthase	Glycogen synthesis	Formation of glycogen	anabolic	Inactivation
AcetylCoA carboxylase	FA biosynthesis	Formation of malonylCoA	anabolic	Inactivation

## Allosteric Regulation of FA Metabolism

- Acetyl CoA carboxylase is the rate-limiting step of FA biosynthesis. It is allosterically inhibited by palmitoyl CoA and activated by citrate.
- Palmitoyl CoA also inhibits the citrate shuttle and thus slows down FA biosynthesis.
- Malonyl CoA and acetyl CoA inhibit  $\beta$ -oxidation.
- Acetyl CoA inhibits the final step of  $\beta$ -oxidation catalyzed by 3-ketoacyl thiolase.
- Malonyl CoA inhibits the transport of acylCoA to mitochondria via inhibition of carnitine-acyl transferase I.
- Additionally, ATP and NADH also inhibit  $\beta$ -oxidation.



The double-reciprocal (Lineweaver-Burk) plot allows easy calculation of  $K_m$  and  $V_{max}$

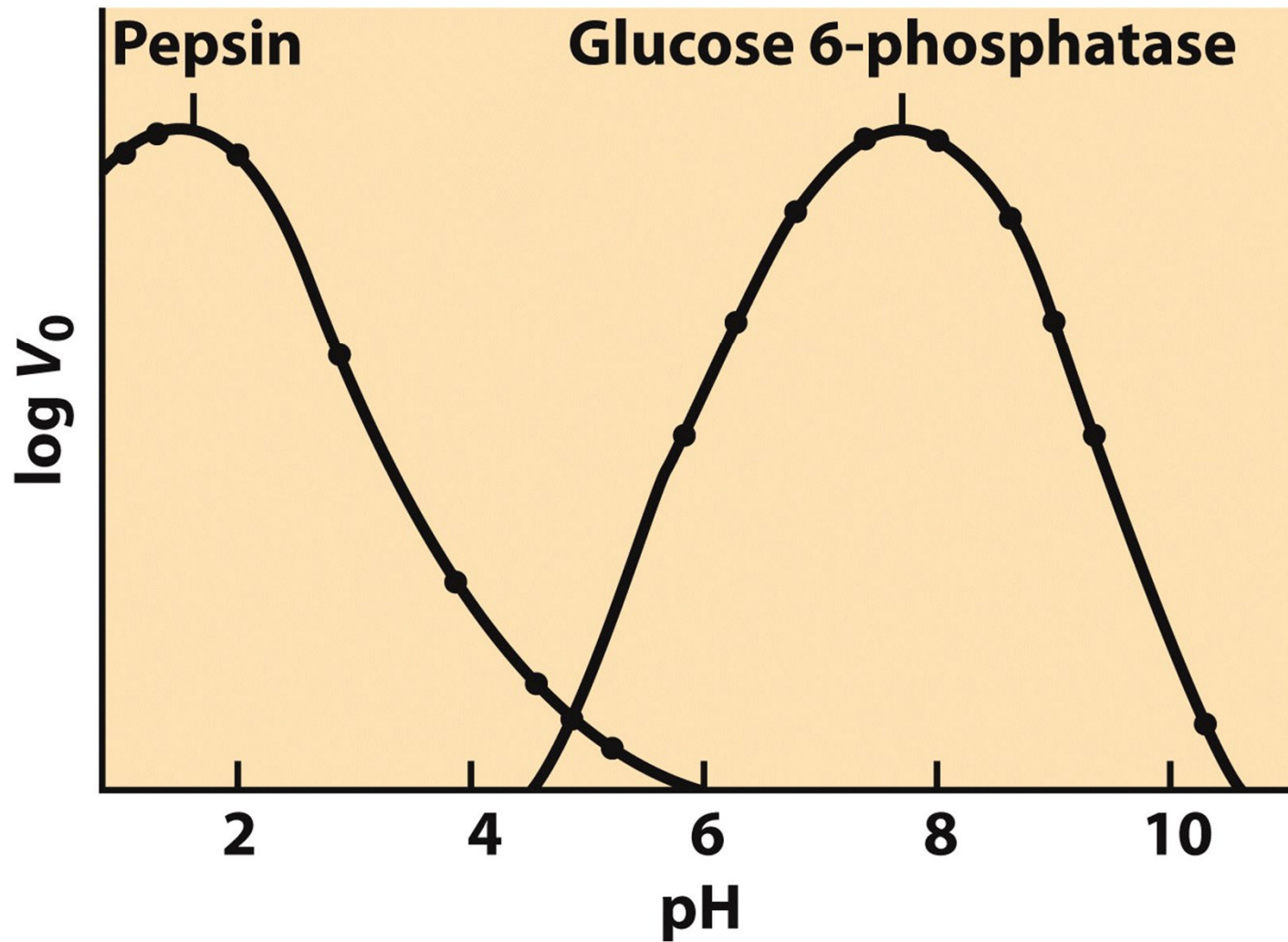




# Many factors influence the activity of an enzyme

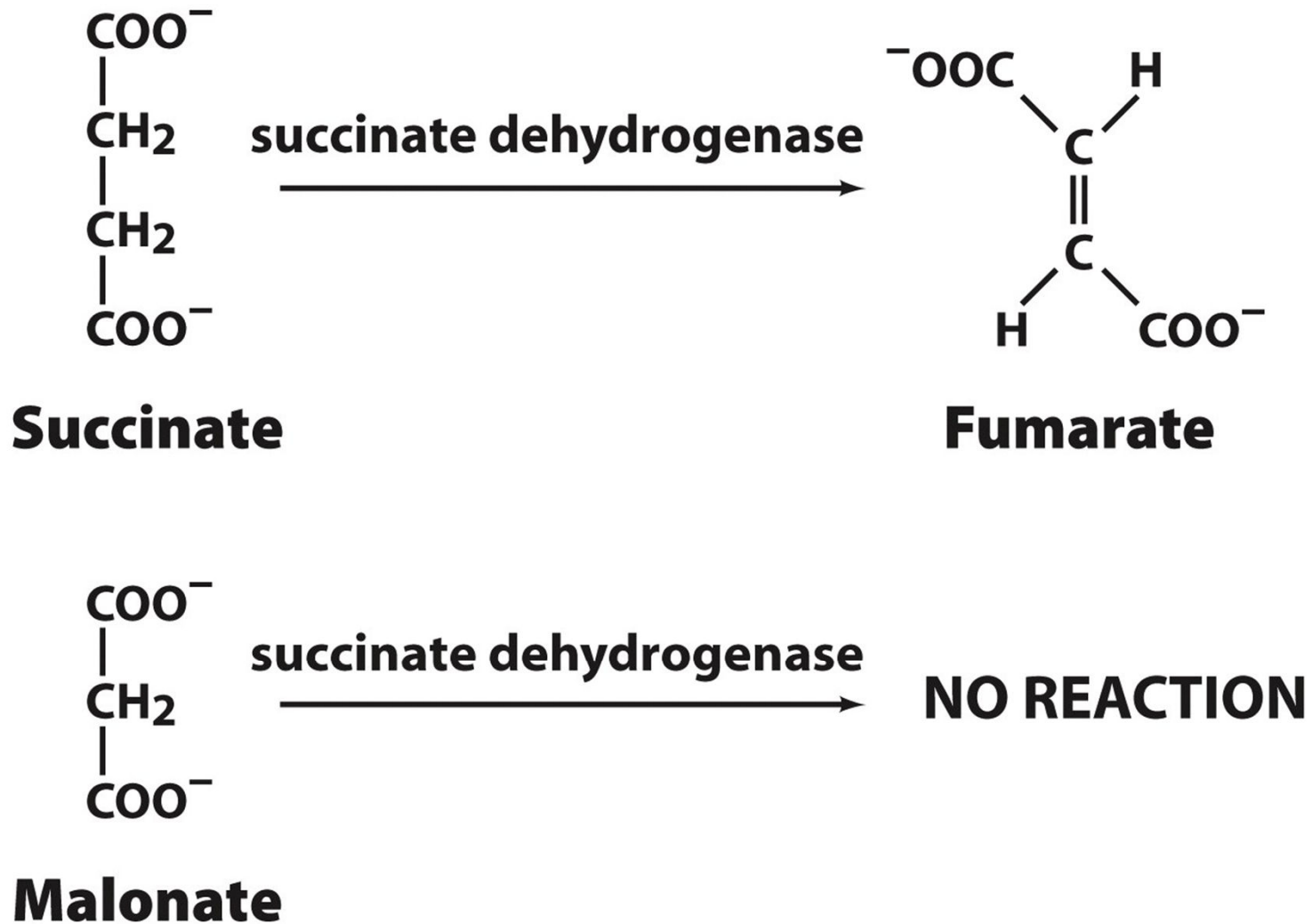
- pH
- Temperature
- Concentration of molecules that bind to enzyme
  - Substrate
  - Reversible inhibitors
  - Irreversible inhibitors (inactivators)
  - Allosteric effectors
- Covalent modification
- Enzyme concentration

Enzymes show maximum activity at their pH optimum



**Figure 6-17**  
*Lehninger Principles of Biochemistry, Fifth Edition*  
© 2008 W.H. Freeman and Company

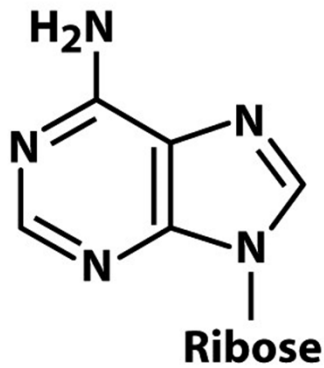
# Enzymes can be inhibited by substrate analogs



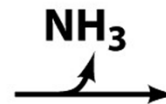
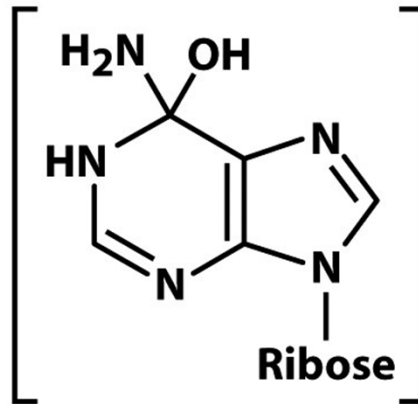
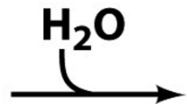
# Enzymes are greatly inhibited by transition-state analogs

## Adenosine deaminase

$K_m = 3 \times 10^{-5}$

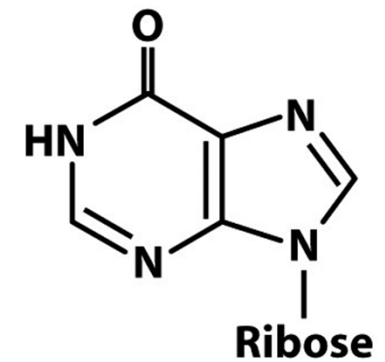


**Adenosine**

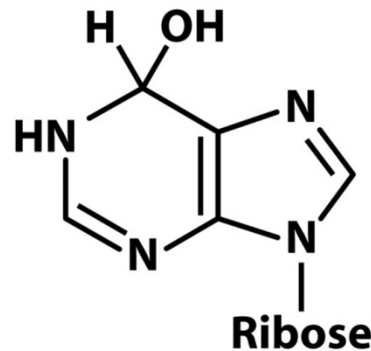


Product inhibition:

$K_i = 3 \times 10^{-4}$



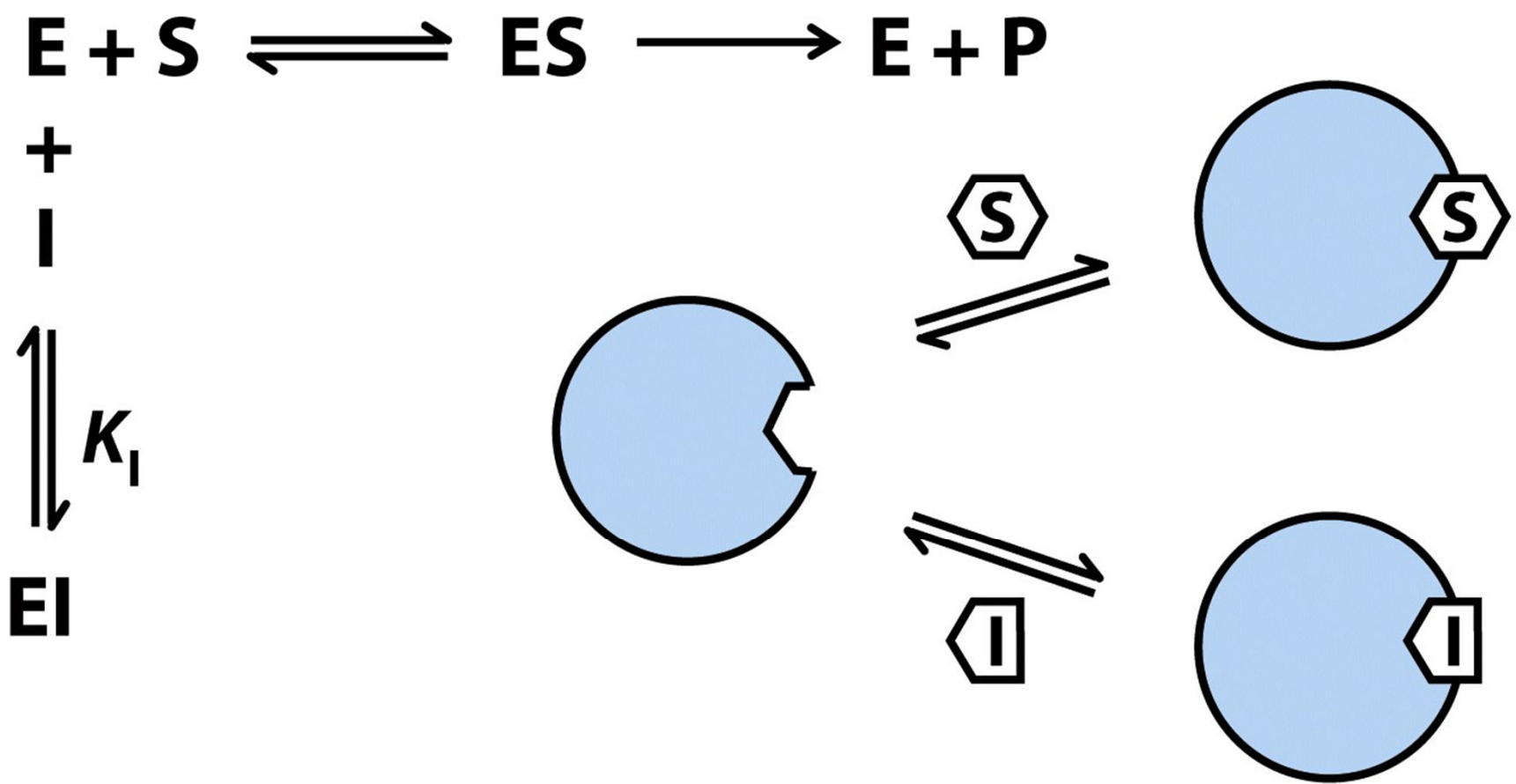
**Inosine**



**1,6-Dihydroinosine**

TS analog:  
 $K_i = 1.5 \times 10^{-13}$

# Competitive inhibition



**Figure 6-15a**  
*Lehninger Principles of Biochemistry, Fifth Edition*  
© 2008 W. H. Freeman and Company

# Uncompetitive inhibition

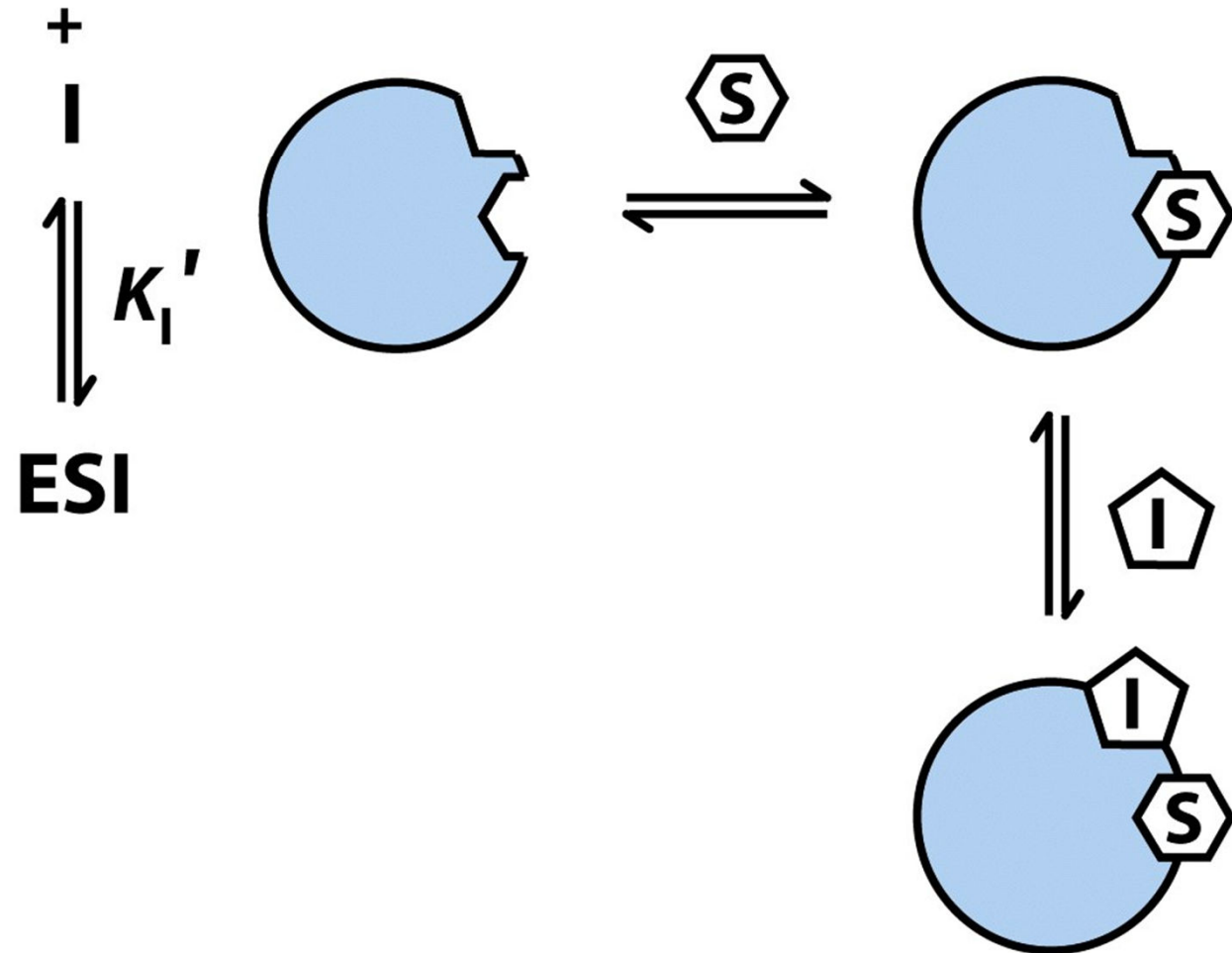
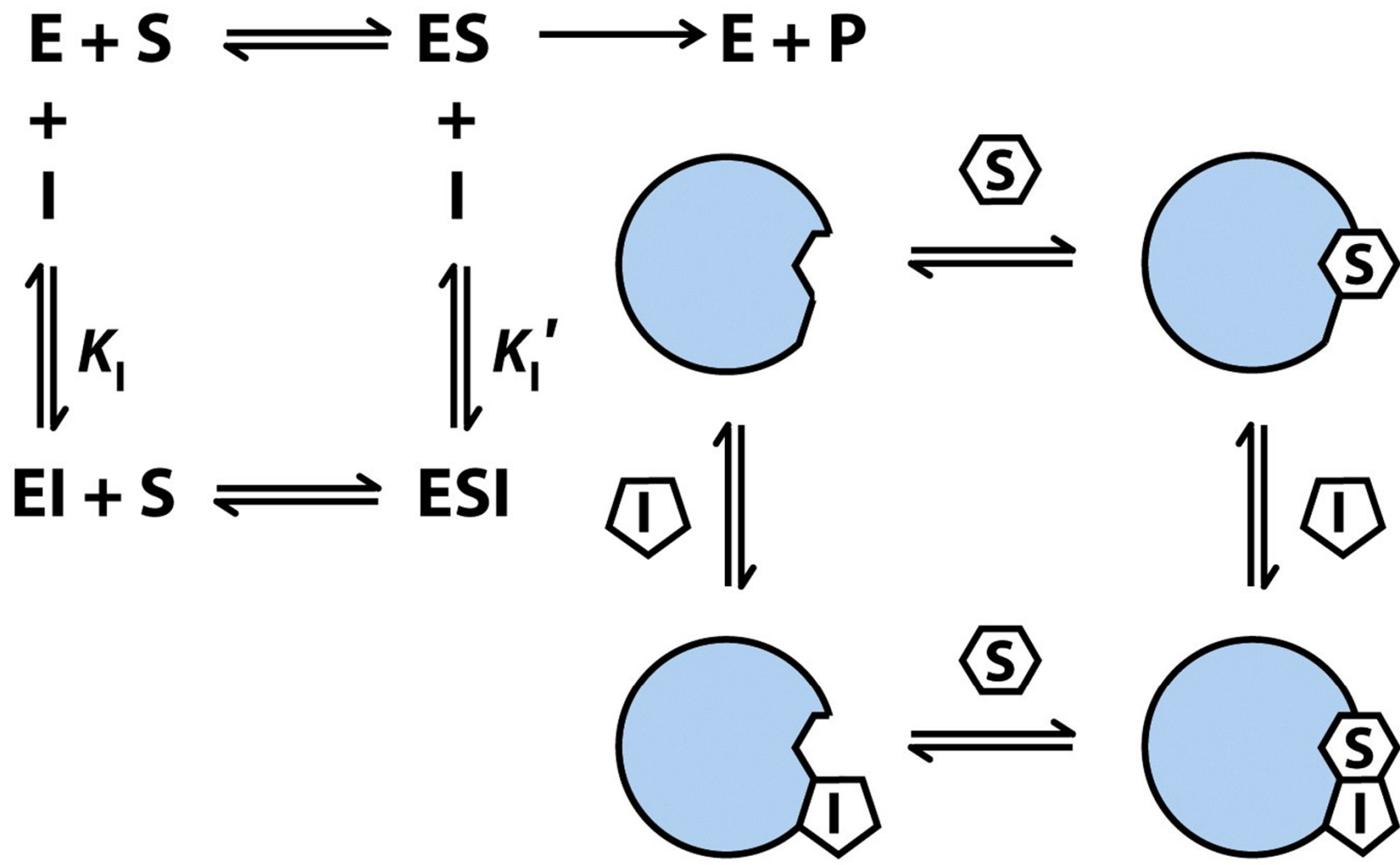


Figure 6-15b

Lehninger Principles of Biochemistry, Fifth Edition

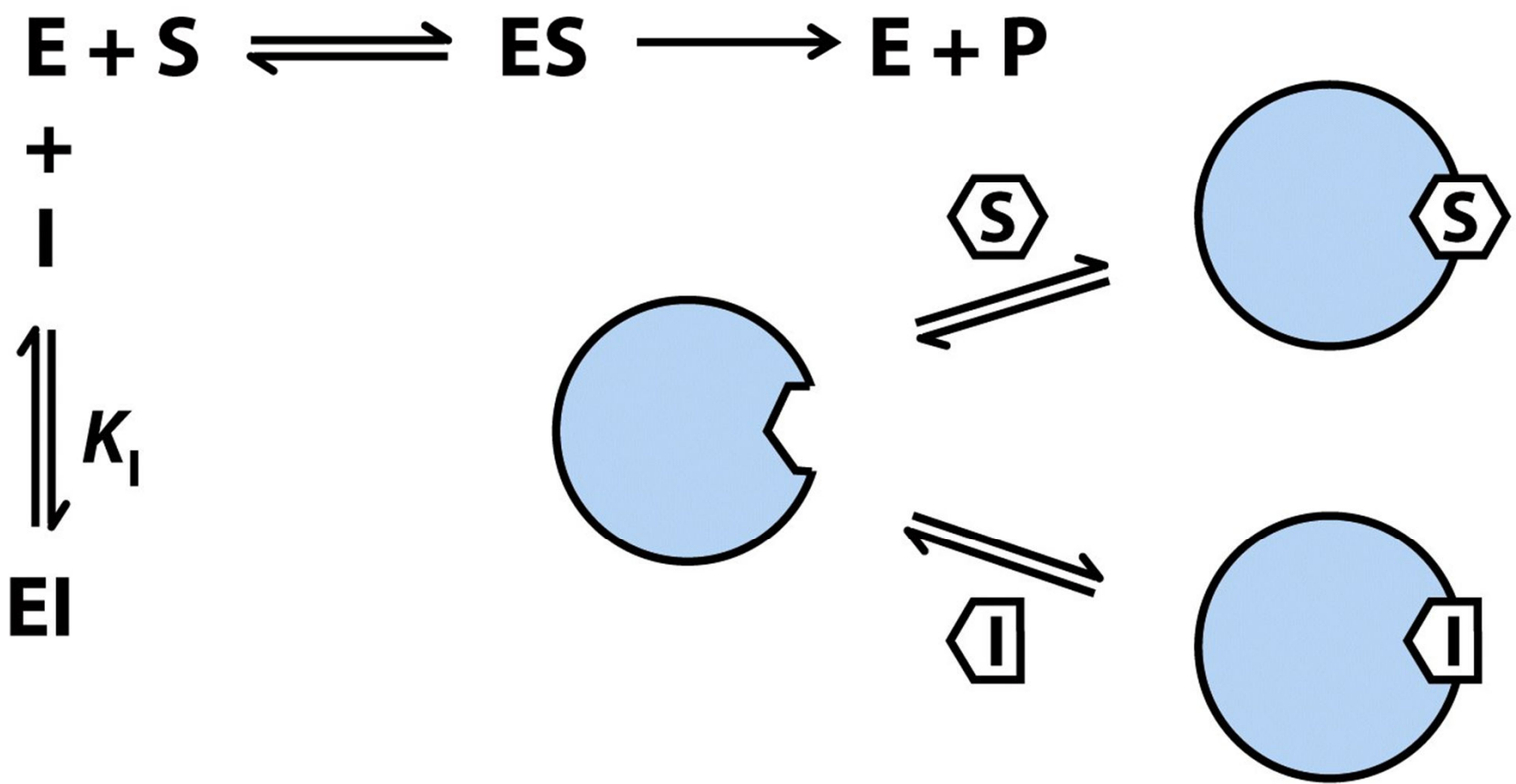
© 2008 W.H. Freeman and Company

# Mixed inhibition



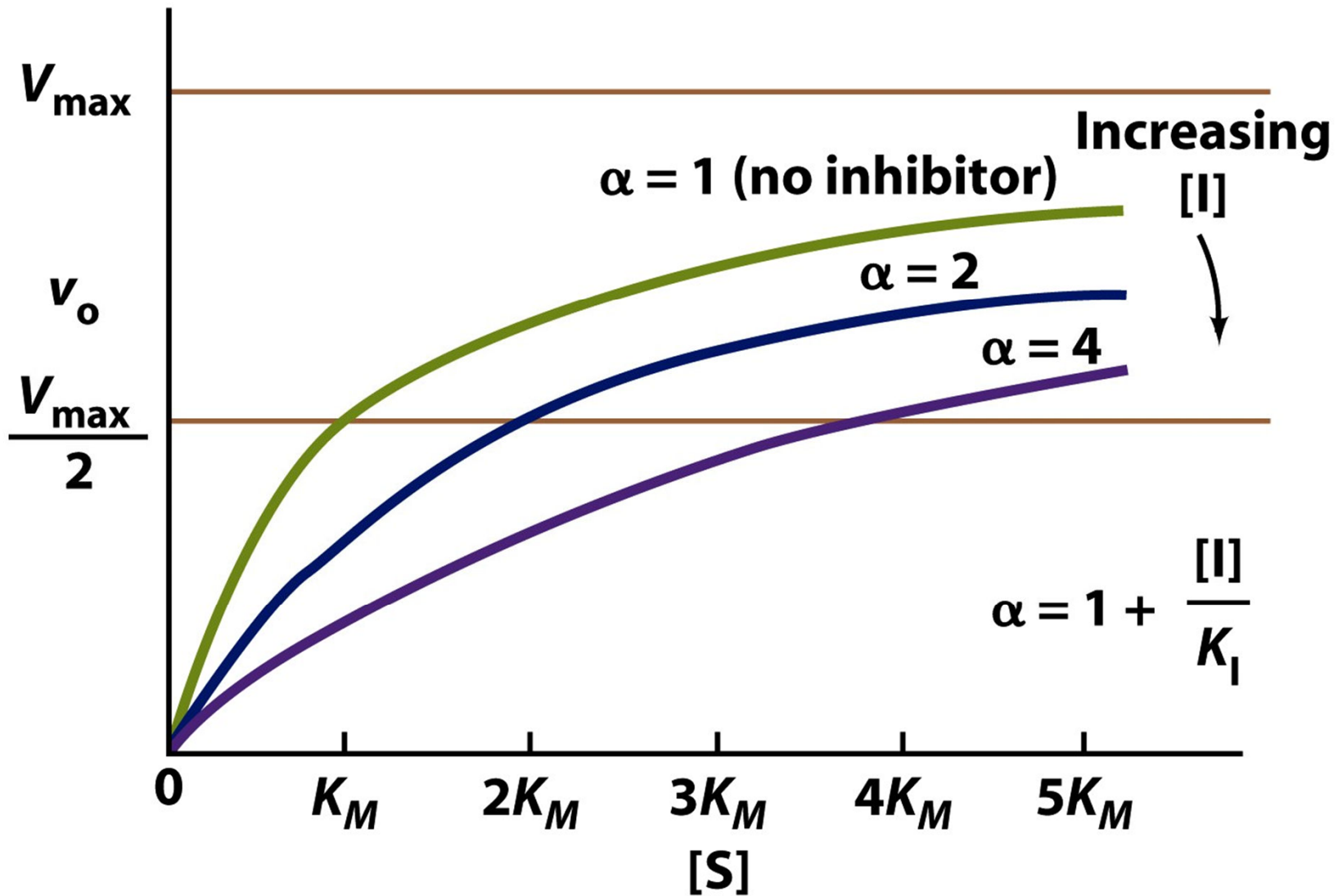
**Figure 6-15c**  
*Lehninger Principles of Biochemistry, Fifth Edition*  
 © 2008 W. H. Freeman and Company

# Competitive inhibition

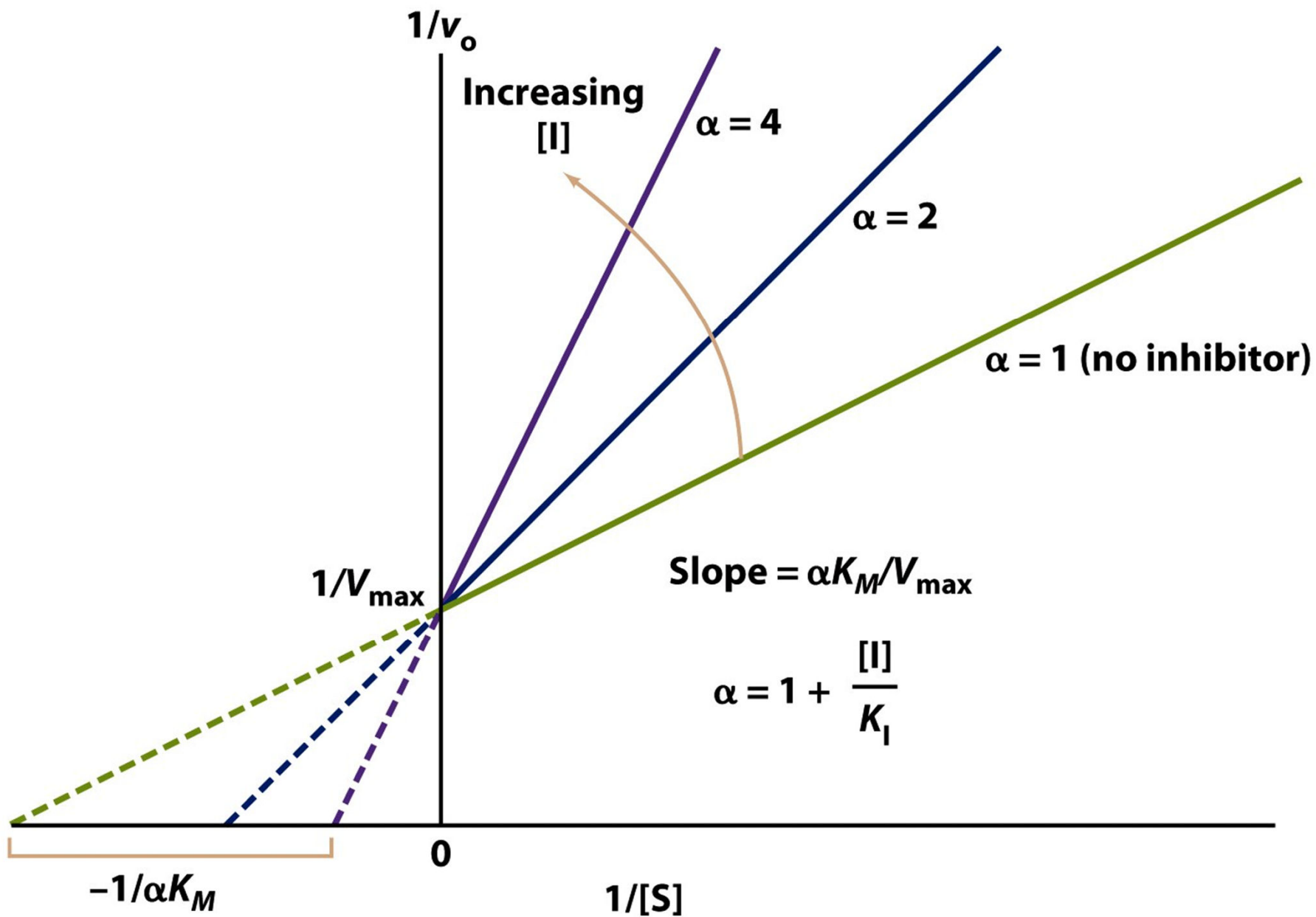


**Figure 6-15a**  
*Lehninger Principles of Biochemistry, Fifth Edition*  
© 2008 W. H. Freeman and Company





$\alpha$  is the factor by which  $[S]$  must be increased to overcome the presence of inhibitor



# Uncompetitive inhibition

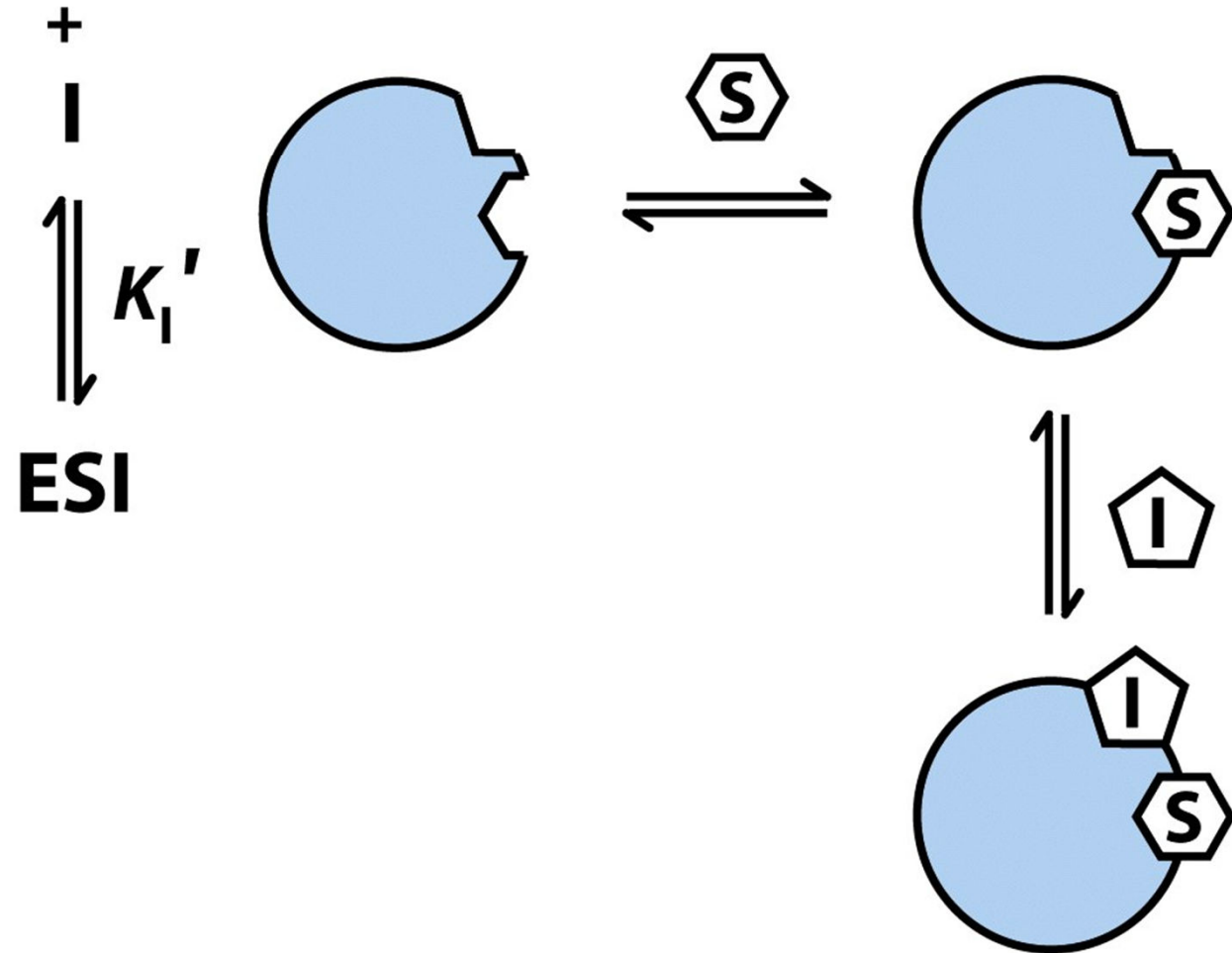
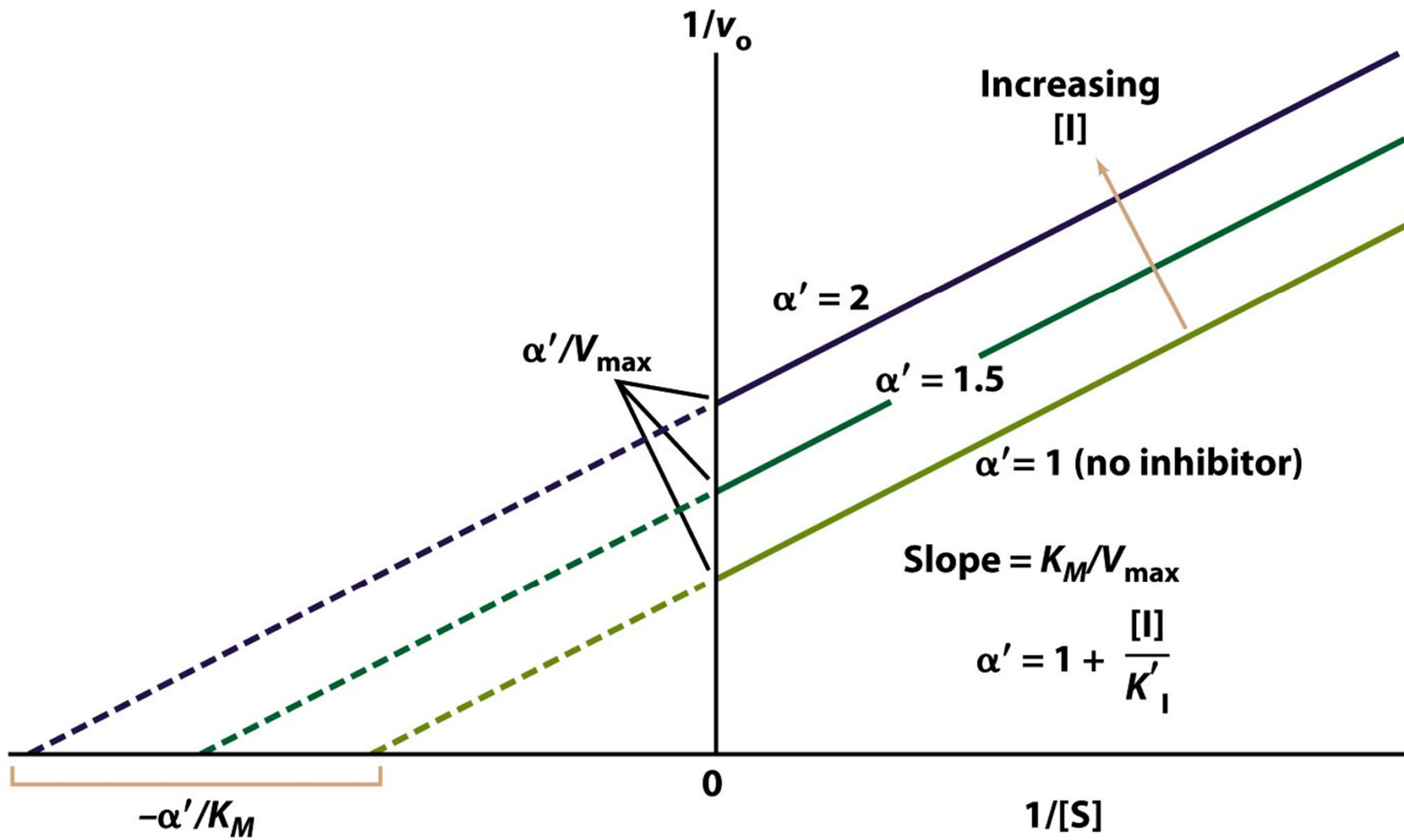


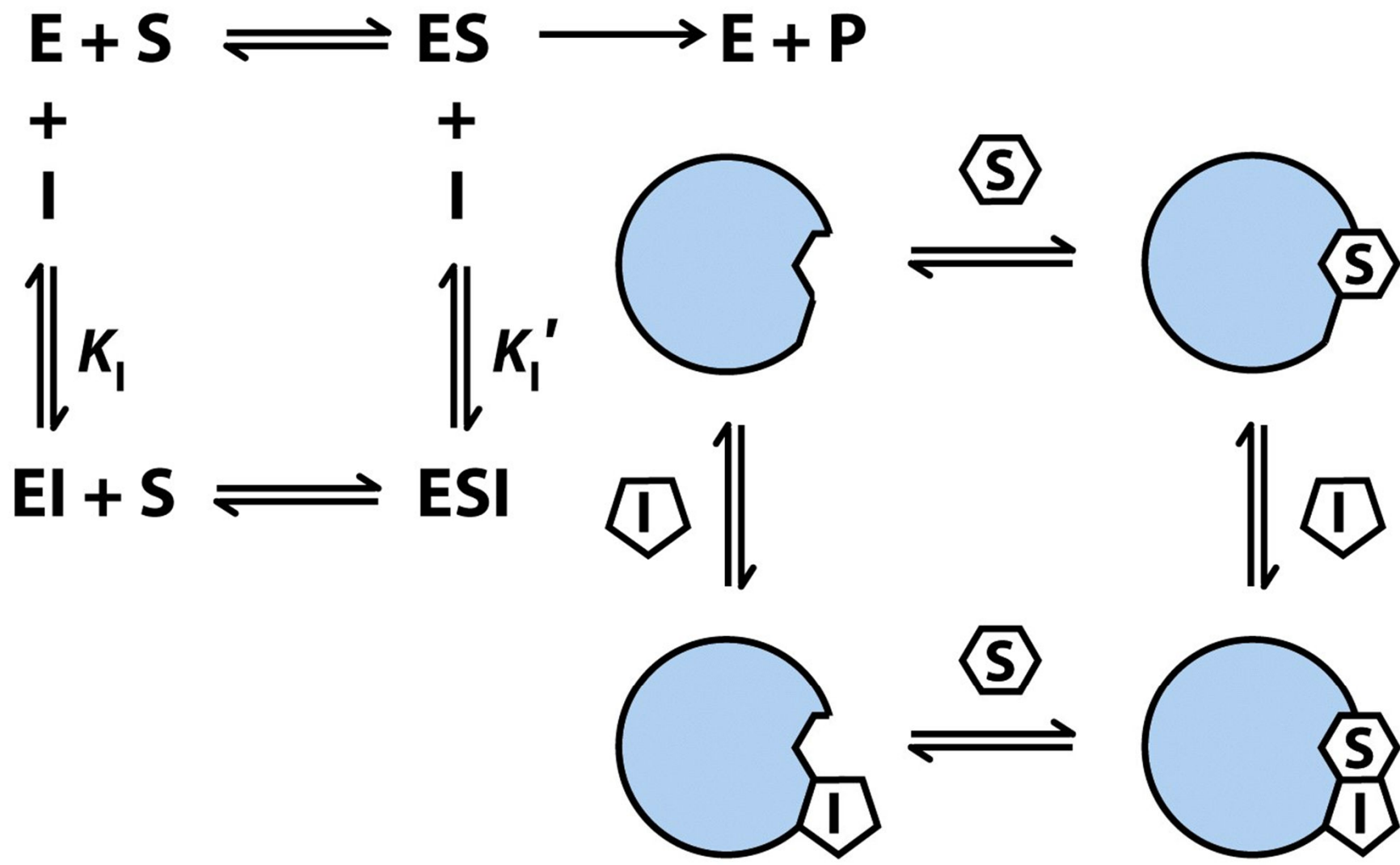
Figure 6-15b

*Lehninger Principles of Biochemistry, Fifth Edition*

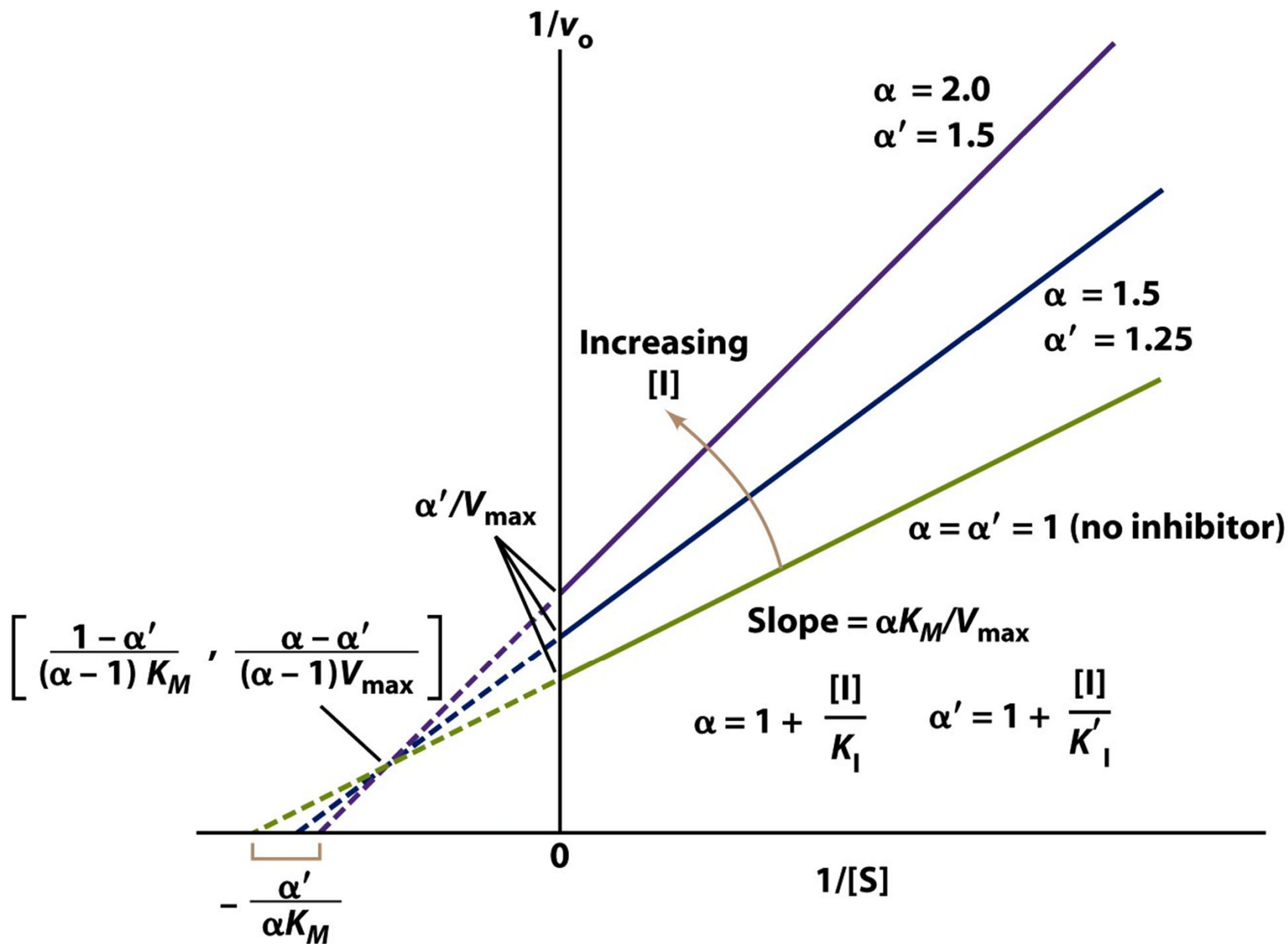
© 2008 W.H. Freeman and Company



# Mixed inhibition



**Figure 6-15c**  
*Lehninger Principles of Biochemistry, Fifth Edition*  
 © 2008 W. H. Freeman and Company



**TABLE 6–9****Effects of Reversible Inhibitors on Apparent  $V_{\max}$  and Apparent  $K_m$** 

Inhibitor type	Apparent $V_{\max}$	Apparent $K_m$
None	$V_{\max}$	$K_m$
Competitive	$V_{\max}$	$\alpha K_m$
Uncompetitive	$V_{\max}/\alpha'$	$K_m/\alpha'$
Mixed	$V_{\max}/\alpha'$	$\alpha K_m/\alpha'$

**Table 6-9***Lehninger Principles of Biochemistry, Fifth Edition*

© 2008 W. H. Freeman and Company

**Table 12-2** Effects of Inhibitors on Michaelis–Menten Reactions<sup>a</sup>

Type of Inhibition	Michaelis–Menten Equation	Lineweaver–Burk Equation	Effect of Inhibitor
None	$v_o = \frac{V_{\max}[S]}{K_M + [S]}$	$\frac{1}{v_o} = \frac{K_M}{V_{\max}} \frac{1}{[S]} + \frac{1}{V_{\max}}$	None
Competitive	$v_o = \frac{V_{\max}[S]}{\alpha K_M + [S]}$	$\frac{1}{v_o} = \frac{\alpha K_M}{V_{\max}} \frac{1}{[S]} + \frac{1}{V_{\max}}$	Increases $K_M^{\text{app}}$
Uncompetitive	$v_o = \frac{V_{\max}[S]}{K_M + \alpha'[S]} = \frac{(V_{\max}/\alpha')[S]}{K_M/\alpha' + [S]}$	$\frac{1}{v_o} = \frac{K_M}{V_{\max}} \frac{1}{[S]} + \frac{\alpha'}{V_{\max}}$	Decreases $K_M^{\text{app}}$ and $V_{\max}^{\text{app}}$
Mixed (noncompetitive)	$v_o = \frac{V_{\max}[S]}{\alpha K_M + \alpha'[S]} = \frac{(V_{\max}/\alpha')[S]}{(\alpha/\alpha')K_M + [S]}$	$\frac{1}{v_o} = \frac{\alpha K_M}{V_{\max}} \frac{1}{[S]} + \frac{\alpha'}{V_{\max}}$	Decreases $V_{\max}^{\text{app}}$ ; may increase or decrease $K_M^{\text{app}}$

$${}^a\alpha = 1 + \frac{[I]}{K_i} \text{ and } \alpha' = 1 + \frac{[I]}{K_i'}$$



# EXPERIMENT 4

## DETERMINATION OF $K_m$ AND $V_{max}$ USING LINEWEAVER – BURK GRAPH

### Structure

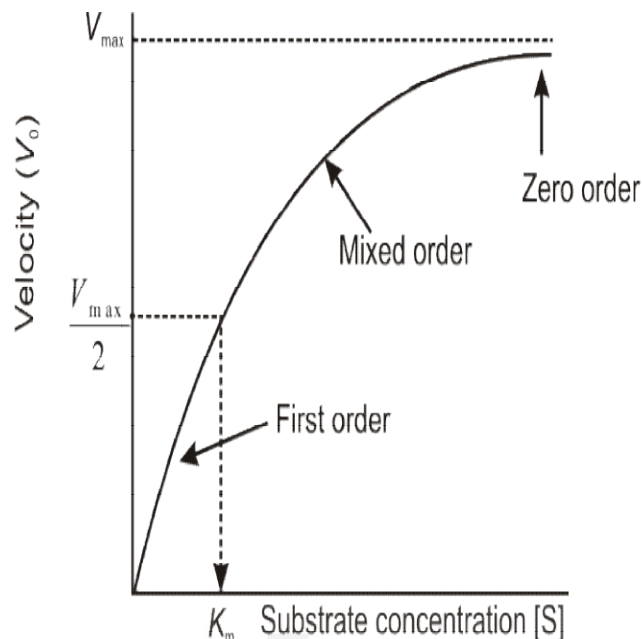
---

4.1	Introduction	4.5	Determination of $K_m$ and $V_{max}$ Using Lineweaver – Burk plot/graph - Protocol
	Expected Learning Outcomes		
4.2	Principle	4.6	Precautions
4.3	Reagents	4.7	Summary
4.4	Preparation of Enzyme Extract		

### 4.1 INTRODUCTION

---

You have learned in core course BBCCT-107 of Enzymes that various factors e.g., substrate availability, pH of medium, temperature, presence of activator/inhibitor etc. can affect the rate of an enzyme catalyzed reaction. Among these, substrate concentration is very important factor affecting the rate of reaction. E and S combine to form [ES] complex which is converted to [EP] from which finally the product P is released. With the increase in substrate concentration, velocity of reaction is increased in a hyperbolic manner (See Fig. 4.1). At low substrate concentration, not all the active sites of enzyme are occupied by substrate molecules and the rate of reaction will be proportional to the substrate concentration exhibiting first order reaction kinetics. When the substrate concentration is very high, enzyme is saturated i.e., the number of substrate molecules exceeds the number of active sites of the enzyme. Under this condition, increase in substrate concentration will not affect the velocity of enzyme catalyzed reaction i.e., velocity will be independent of the substrate concentration. At this stage velocity is at a maximum ( $V_{max}$ ), and zero order kinetics is observed.



**Fig. 4.1: Effect of substrate concentration on enzyme activity.**

The mathematical expression of the hyperbolic shape curve is given by Michaelis-Menten equation:

$$V_0 = \frac{V_{max} [S]}{K_m + [S]}$$

It shows relationship between initial velocity ( $V_0$ ) with maximum velocity ( $V_{max}$ ), initial substrate concentration  $[S]$  and the Michaelis constant ( $K_m$ ).

In this equation, if  $[S] = K_m$ , the  $V_0 = V_{max}/2$

Therefore, Michaelis constant ( $K_m$ ) can be defined as the substrate concentration at which the initial velocity is half of the maximum velocity. It is expressed in the units of substrate (M or mM).

$K_m$  is a measure of affinity of an enzyme for its substrate. A large  $K_m$  means low affinity while a low  $K_m$  value indicates high affinity for the given substrate.

$V_0$  vs.  $[S]$  curve gives only an approx. value of  $K_m$  as  $V_{max}$  is not clearly determined.

Lineweaver-Burk plot is obtained by transformation of Michaelis-Menten equation and is a very common method to determine  $K_m$  and  $V_{max}$ .

Taking reciprocal on both sides of equation;

$$\frac{1}{V_0} = \frac{K_m}{V_{max}} \cdot \frac{1}{[S]} + \frac{1}{V_{max}}$$

It is a straight line equation. By plotting a graph  $1/V_0$  vs.  $1/[S]$ ,  $V_{\max}$  on Y-axis and  $K_m$  from X-axis can be obtained. It is also called double reciprocal plot as  $1/V_0$  vs.  $1/[S]$  are plotted (Fig. 4.2).

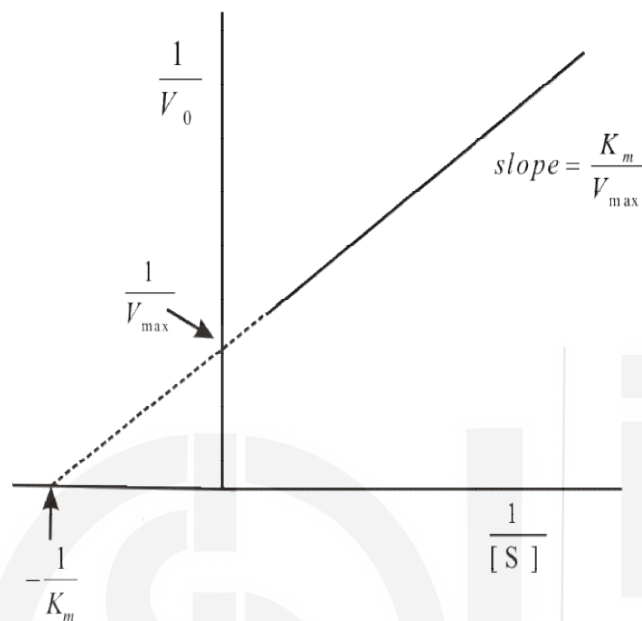


Fig. 4.2: Lineweaver-Burk plot (Double Reciprocal plot).

## Expected Learning Outcomes

After studying this unit, you should be able to:

- ❖ understand how substrate level affects the rate of an enzyme catalyzed reaction; and
- ❖ perform the experiment to study the effect of substrate concentration on activity of acid phosphatase and determine  $K_m$  and  $V_{\max}$  using Lineweaver-Burk plot/graph.

## 4.2 PRINCIPLE

The hyperbolic curve (initial velocity  $V_0$  vs. substrate concentration) is not entirely satisfactory for determination of  $K_m$  and  $V_{\max}$  for an enzyme catalyzed reaction. The Michaelis-Menten equation can be rearranged by taking reciprocals on both sides of equation to a form that is equivalent to the straight-line equation. By plotting  $1/V_0$  on Y-axis (ordinate) and  $1/[S]$  on X-axis (abscissa), a straight line relationship is observed which is known as Lineweaver- Burk plot, where the slope is  $K_m/V_{\max}$  and the intercept on the Y-axis is  $1/V_{\max}$ . The X-intercept is  $-1/K_m$  where  $K_m$  is the Michaelis-Menten constant. In acid phosphatase catalyzed reaction using *p*-nitrophenyl phosphate as substrate, the inverse values of different concentrations of *p*-nitrophenol (i.e.,  $1/V_0$ ) vs. the inverse values of *p*NPP concentrations (i.e.,

$1/[S]$  are plotted to determine the  $K_m$  and  $V_{max}$  from the Lineweaver and Burk plot.

**Note:**

1. Only approximate values of  $V_{max}$  and  $K_m$  can be obtained from velocity ( $V_o$ ) vs.  $[S]$  graph.
2. Reactions for substrate conversion etc. are given in Expt. 1.

### 4.3 REAGENTS

- i) Buffer: 0.1M Sodium citrate buffer (pH 4.8) as described in experiment 1.
- ii) Substrate solution: 5 mM *p*-nitrophenyl phosphate (*p*NPP), dissolved in 0.1 M sodium citrate buffer (pH 4.8).
- iii) 0.2N Sodium hydroxide solution

### 4.4 PREPARATION OF ENZYME EXTRACT

Follow the steps as already explained in Ex. 1.

### 4.5 DETERMINATION OF $K_m$ AND $V_{max}$ USING LINEWEAVER-BURK PLOT/GRAPH-PROTOCOL

Take clean test tubes numbered from 1 to 9. Pipette out different volumes of 5 mM *p*NPP solution and the citrate buffer as follows (in duplicate). Prepare another set also and mark as Blank e.g. B1, B2, B3, B4 B5, B6, B7, B8, B9.

Reagent	Tube								
	1	2	3	4	5	6	7	8	9
5 mM <i>p</i> NPP solution (mL)	0.025	0.05	0.10	0.15	0.20	0.25	0.3	0.6	0.9
0.1M Citrate buffer (pH 4.8) (mL)	0.875	0.85	0.80	0.75	0.70	0.65	0.6	0.3	-
	Mix properly and equilibrate at 37°C for ~3 min								

- Start the reaction by adding 0.1 mL of enzyme extract in each tube (assay tubes only). Note down the time of adding the enzyme extract in first tube.
- Immediately mix properly and incubate at 37°C for 10 min.
- Stop the reaction by adding 4.0 mL of 0.2N NaOH in each tube.
- In blanks, add enzyme extract (0.1 mL in each tube) at the end after addition of 0.2N NaOH.
- Record the absorbance of each tube (assay) against the corresponding blank (prepared for each *p*NPP concentration), at 410 nm using a spectrophotometer.

### **Calculations and plotting the graph**

- Determine the amount of *p*-nitrophenol produced in each tube from the standard curve prepared as explained in experiment 1.
- Calculate the  $\mu\text{moles}$  of *p*-nitrophenol produced/min (termed as velocity,  $V_0$ ) for each concentration (mM) of *p*NPP, represented as [S].
- Plot  $V_0$  vs. [S] and note the shape of curve.
- For the Lineweaver-Burk plot (double reciprocal plot), you will have to find out the reciprocal of velocity ( $1/V_0$ ) and substrate concentration ( $1/[S]$ ).

Plot  $1/V_0$  on Y-axis and  $1/[S]$  on X-axis, and determine the value of  $K_m$  and  $V_{\text{max}}$  of the acid phosphatase catalyzed reaction.

Note: i) Prepare blank tube corresponding to each substrate concentration.

ii) The velocity of enzyme catalyzed reaction is expressed as product formed per unit time e.g.  $\mu\text{moles } p\text{-nitrophenol/min}$ .

### **4.6 PRECAUTIONS**

- i) The substrate concentration should cover a wide range.
- ii) Pipetting of volumes should be very accurate.
- iii) Always wear gloves while working with *p*-nitrophenylphosphate and *p*-nitrophenol, avoid contact, inhalation etc.
- iv) Ensure equilibration at incubation temperature before adding the enzyme extract.

### **4.7 SUMMARY**

In an enzyme catalyzed reaction as the substrate concentration is increased, the velocity of reaction increases till it reaches the maximum value ( $V_{\text{max}}$ ). The substrate concentration at which the velocity of enzyme catalyzed reaction is half maximal is defined as the Michaelis constant ( $K_m$ ).  $K_m$  is a measure of affinity of the enzyme for its substrate and its units are same as that of substrate. A double reciprocal plot ( $1/V_0$  vs.  $1/[S]$ ), known as Lineweaver-Burk

plot, is a common method to determine the  $K_m$  and  $V_{max}$ . Activity of acid phosphatase can be measured by using a chromogenic synthetic substrate, *p*-nitrophenylphosphate. The velocity is calculated as  $\mu$ moles *p*-nitrophenol formed/min and  $K_m$  is expressed as mM. For an enzyme assay, the reaction is carried out under optimal conditions of pH, temperature, substrate concentration etc. To set up the enzyme assays, substrate should not be limiting i.e., enzyme should be saturated with the substrate.



ignou  
THE PEOPLE'S  
UNIVERSITY

# Michaelis-Menten Constant ( $K_m$ value & Its Significance)

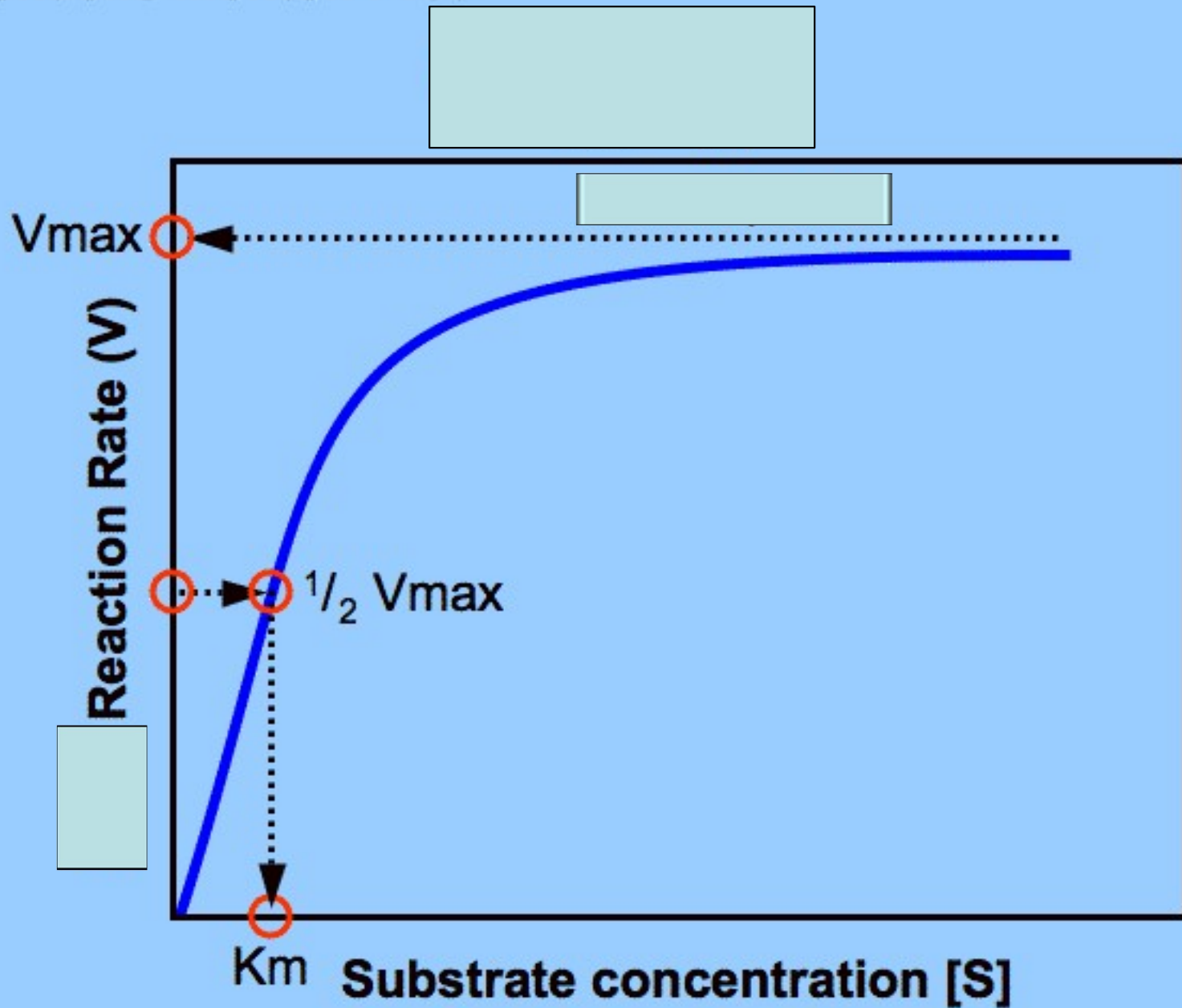
In an enzyme catalyzed reaction when there is large excess of substrate and the enzyme concentration is held constant, if substrate concentration (S) is plotted against velocity (V) or reaction rate, a hyperbolic curve is obtained (see figure). This type of plot is also known as saturation plot.



In the beginning, there is approximately direct proportionality between substrate concentration and reaction rate until the enzyme concentration becomes limiting and a steady state is obtained.

In this situation addition of more substrate will not increase reaction rate because all the active sites of the enzyme are saturated with substrate molecules and the rate of reaction will increase only by addition of more enzyme.

# Michaelis Menten Plot



The concentration of substrate required to half saturate the enzyme or in other words to cause half the maximal reaction rate ( $1/2 V_{max}$ ) called as Michaelis Constant or Michaelis-Menten Constant and is denoted by  $K_m$ .

Michaelis constant is a reflection of the affinity of enzyme for its substrate and is characteristic of a particular enzyme-substrate system. The smaller the value of  $K_m$ , the more strongly the enzyme binds the substrate.

Kinetic values of enzyme catalyzed reactions are usually measured under steady state conditions and described by a simple expression called Michaelis-Menten, equation.

$$V = V_{\max} [S] / K_m + [S]$$

where,

$V \rightarrow$  velocity or reaction rate

$V_{\max} \rightarrow$  maximum velocity or maximal reaction rate

$S \rightarrow$  Substrate concentration

$K_m \rightarrow$  Michaelis constant.

K<sub>m</sub> values range widely but most lie between 0.1 and 0.000001 M.

## K<sub>m</sub> Values for Some Enzymes with Respective Substrates

<i>Enzyme</i>	<i>Substrate</i>	<i>K<sub>m</sub> (mM)</i>
Hexokinase (brain)	ATP	0.4
	D-Glucose	0.05
	D-Fructose	1.5
Carbonic anhydrase	HCO <sub>3</sub> <sup>-</sup>	26
Chymotrypsin	Glycyltyrosinylglycine	108
	N-Benzoyltyrosinamide	2.5
β-Galactosidase	D-Lactose	4.0



## Significance of Michaelis-Menten Constant:

- (i) By knowing the  $K_m$  value of a particular enzyme-substrate system, one can predict whether the cell needs more enzymes or more substrate to speed up the enzymatic reaction.
- (ii) If an enzyme can catalyze a reaction with two similar substrates (e.g., glucose and fructose) in the cell, it will prefer that substrate for which the enzyme has lower  $K_m$  value.

(iii)  $K_m$  value gives an approximate measure of the concentration of substrate of the enzyme in that part of the cell where reaction is occurring.

Source:

1. Plant Physiology by Taiz & Zeiger (2015)
2. Biochemistry by Stryer (2016)

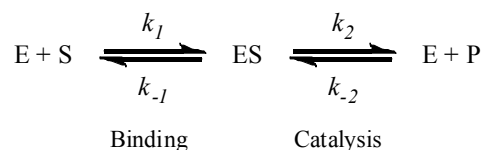
## Michaelis-Menten (steady-state) Kinetics

**The Michaelis-Menten model** for enzyme kinetics presumes a simple 2-step reaction:

Step 1: Binding – the substrate binds to the enzyme

Step 2: Catalysis – the substrate is converted to product and released

(Note that enzymes not matching this reaction scheme may still show similar kinetics.)



**The Michaelis-Menten equation** shows how the initial rate of this reaction,  $V_o$ , depends on the substrate concentration,  $[S]$ :

$$V_o = \frac{V_{max}[S]}{K_m + [S]}$$

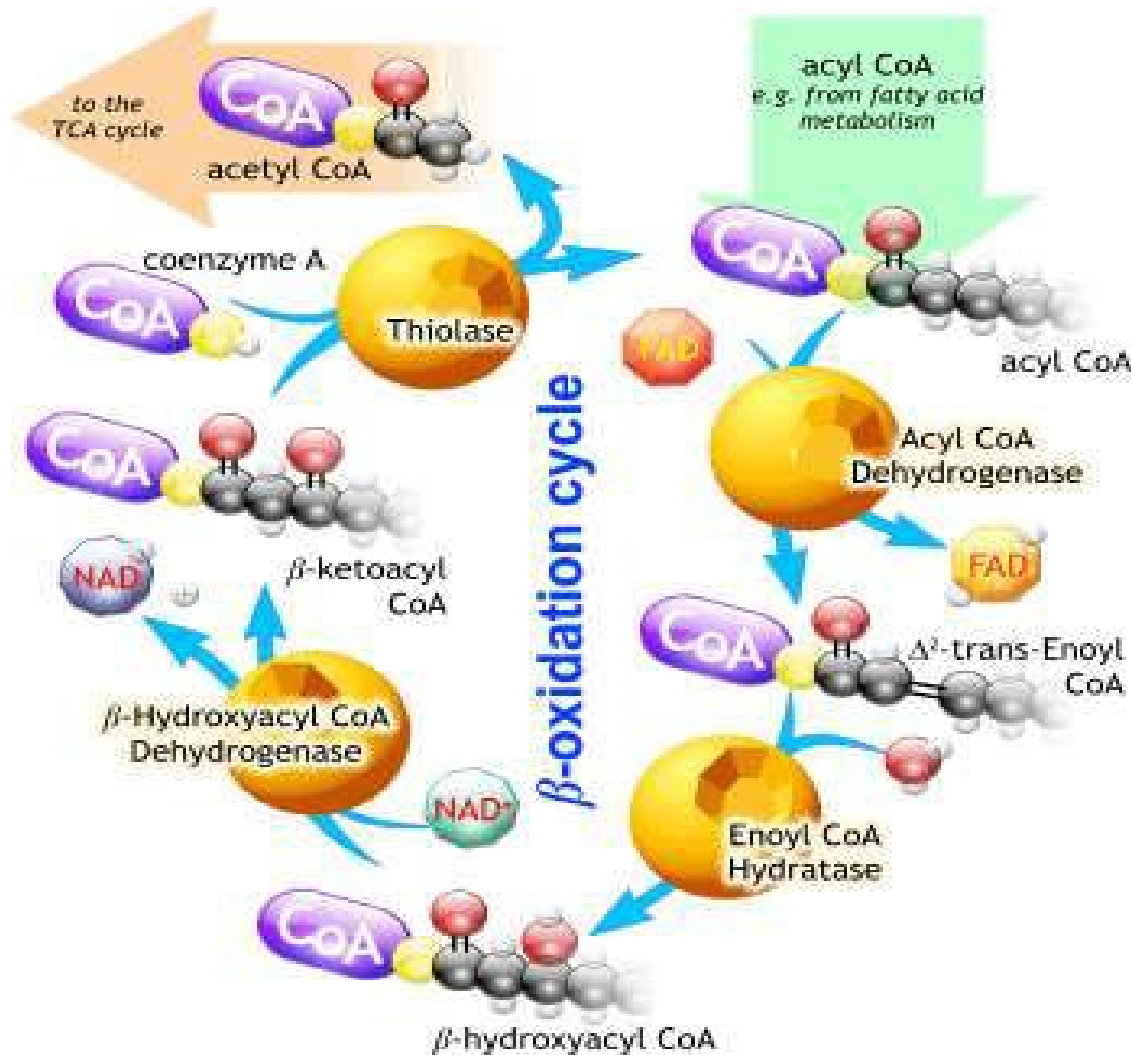
**Several simplifying assumptions** allow for the derivation of the Michaelis-Menten equation:

- (1) The binding step ( $E + S \rightleftharpoons ES$ ) is fast, allowing the reaction to quickly reach equilibrium ratios of  $[E]$ ,  $[S]$ , and  $[ES]$ . The catalytic step ( $ES \rightleftharpoons E + P$ ) is slower, and thus rate-limiting.
- (2) At early time points, where initial velocity ( $V_o$ ) is measured,  $[P] \approx 0$ .
- (3)  $ES$  immediately comes to steady state, so  $[ES]$  is constant (throughout the measured portion of the reaction).
- (4)  $[S] \gg [E_T]$ , so the fraction of  $S$  that binds to  $E$  (to form  $ES$ ) is negligible, and  $[S]$  is constant at early time points.
- (5) The enzyme exists in only two forms: free ( $E$ ), and substrate-bound ( $ES$ ). Thus, the total enzyme concentration ( $E_T$ ) is the sum of the free and substrate-bound concentrations:  $[E_T] = [E] + [ES]$

**A derivation of the Michaelis-Menten equation** shows how to use the above assumptions to describe the rate of the enzyme-catalyzed reaction in terms of measurable quantities:

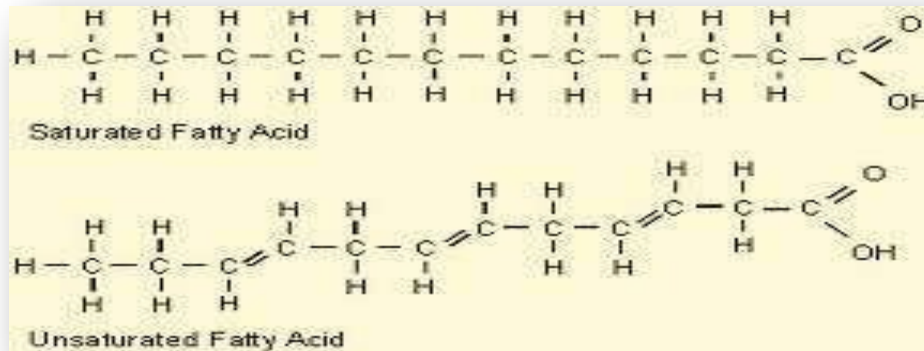
From (1), we know the overall rate of the reaction is determined by the rate of the catalytic step:	$V_o = k_2[ES] - k_{-2}[E][P]$
From (2), the second term equals zero, so we are left with:	$V_o = k_2[ES]$
We want to describe $V_o$ in measurable quantities, but $[ES]$ is not easy to measure. However $[S]$ is known, from (4). To express $[ES]$ in terms of $[S]$ , we can start from (3):	Rate of formation of $ES$ = Rate of breakdown of $ES$ $k_1[E][S] + k_{-2}[E][P] = k_{-1}[ES] + k_2[ES]$
From (2), this simplifies to:	$k_1[E][S] = k_{-1}[ES] + k_2[ES]$
We can factor out $[ES]$ and group the rate constants:	$k_1[E][S] = [ES]\{k_{-1} + k_2\}$ $[E][S] = [ES]\left\{\frac{k_{-1} + k_2}{k_1}\right\}$
This ratio of rate constants is defined as <b>the Michaelis Constant, <math>K_m</math></b> :	$K_m = \frac{k_{-1} + k_2}{k_1}$
Substituting in $K_m$ for the rate-constant ratio gives:	$[E][S] = [ES]K_m$
Just as $[ES]$ is not easy to measure, $[E]$ is also not easy to measure. However, $[E_T]$ is known. Rearranging (5) for $[E]$ and substituting, we get:	$\{[E_T] - [ES]\}[S] = [ES]K_m$
We are still trying to get an expression for $[ES]$ in terms of measurable quantities. Here we can multiply, rearrange, factor, and divide, to get $[ES]$ in terms of $[E_T]$ , $[S]$ , and $K_m$ :	$[E_T][S] - [ES][S] = [ES]K_m$ $[E_T][S] = [ES]K_m + [ES][S]$ $[E_T][S] = [ES]\{K_m + [S]\}$ $\frac{[E_T][S]}{K_m + [S]} = [ES]$
Now we can substitute our expression for $[ES]$ into the rate equation:	$V_o = k_2[ES] = \frac{k_2[E_T][S]}{K_m + [S]}$
At high $[S]$ (when $[S] \gg K_m$ ), nearly all enzyme will have substrate bound, and $[ES]$ approaches $[E_T]$ . This is when $V_o$ approaches $V_{max}$ . Since $V_o = k_2[ES]$ , (Or, mathematically, when $[S] \gg K_m$ , $K_m$ is negligible, and the equation simplifies to:)	$V_{max} = k_2[E_T]$ $\left(V_{max} = \frac{k_2[E_T][S]}{[S]} = k_2[E_T]\right)$
Substituting $V_{max}$ in to the rate equation gives <b>the Michaelis-Menten equation</b> :	$V_o = \frac{V_{max}[S]}{K_m + [S]}$

# FATTY ACID OXIDATION



# FATTY ACIDS

- A fatty acid contains a long hydrocarbon chain and a terminal carboxylate group. The hydrocarbon chain may be saturated (with no double bond) or may be unsaturated (containing double bond).



- ❑ Fatty acids can be obtained from-
- ❑ Diet
- ❑ Adipolysis
- ❑ De novo synthesis

# FUNCTIONS OF FATTY ACIDS

Fatty acids have four major physiological roles.

1) Fatty acids are **building blocks of phospholipids and glycolipids.**

2) Many proteins are modified by the **covalent attachment of fatty acids, which target them to membrane locations**

3) Fatty acids are **fuel molecules.** They are stored as triacylglycerols. Fatty acids mobilized from triacylglycerols are oxidized to meet the energy needs of a cell or organism.

4) Fatty acid **derivatives serve as hormones and intracellular messengers** e.g. steroids, sex hormones and prostaglandins.

# TRIGLYCERIDES

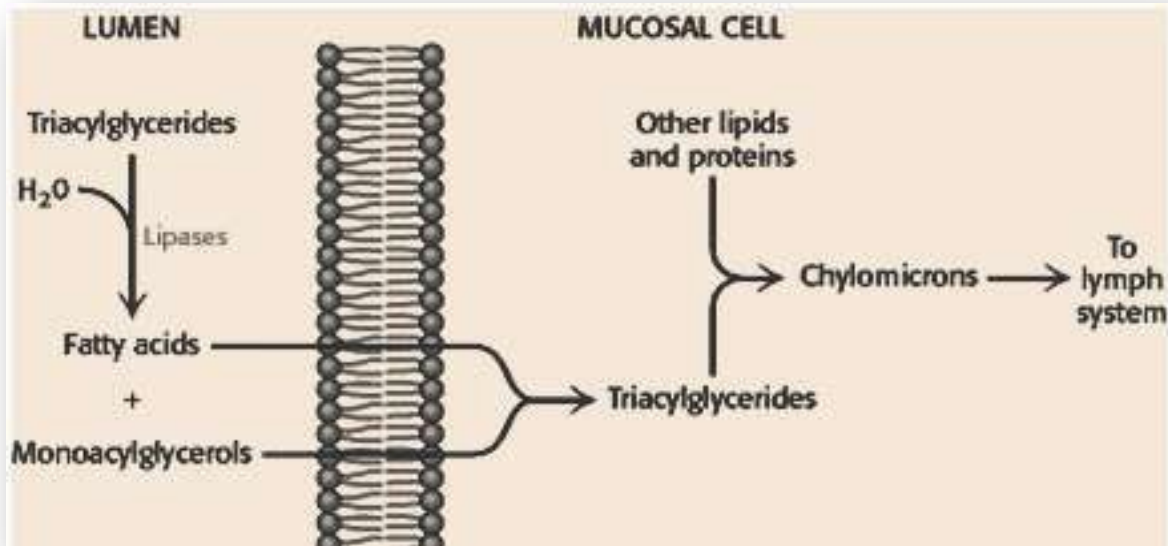
- Triglycerides are **a highly concentrated** stores of energy because they are ***reduced and anhydrous***.
- The yield from the complete oxidation of fatty acids is about 9 kcal g<sup>-1</sup> (38 kJ g<sup>-1</sup>)
- Triacylglycerols are nonpolar, and are stored in a nearly anhydrous form, whereas much more polar proteins and carbohydrates are more highly



# TRIGLYCERIDES V/S GLYCOGEN

- *A gram of nearly anhydrous fat stores more than six times as much energy as a gram of hydrated glycogen*, which is likely the reason that triacylglycerols rather than glycogen were selected in evolution as the major energy reservoir.
- The glycogen and glucose stores provide enough energy to sustain biological function for about 24 hours, whereas the **Triacylglycerol stores allow survival for several weeks.**

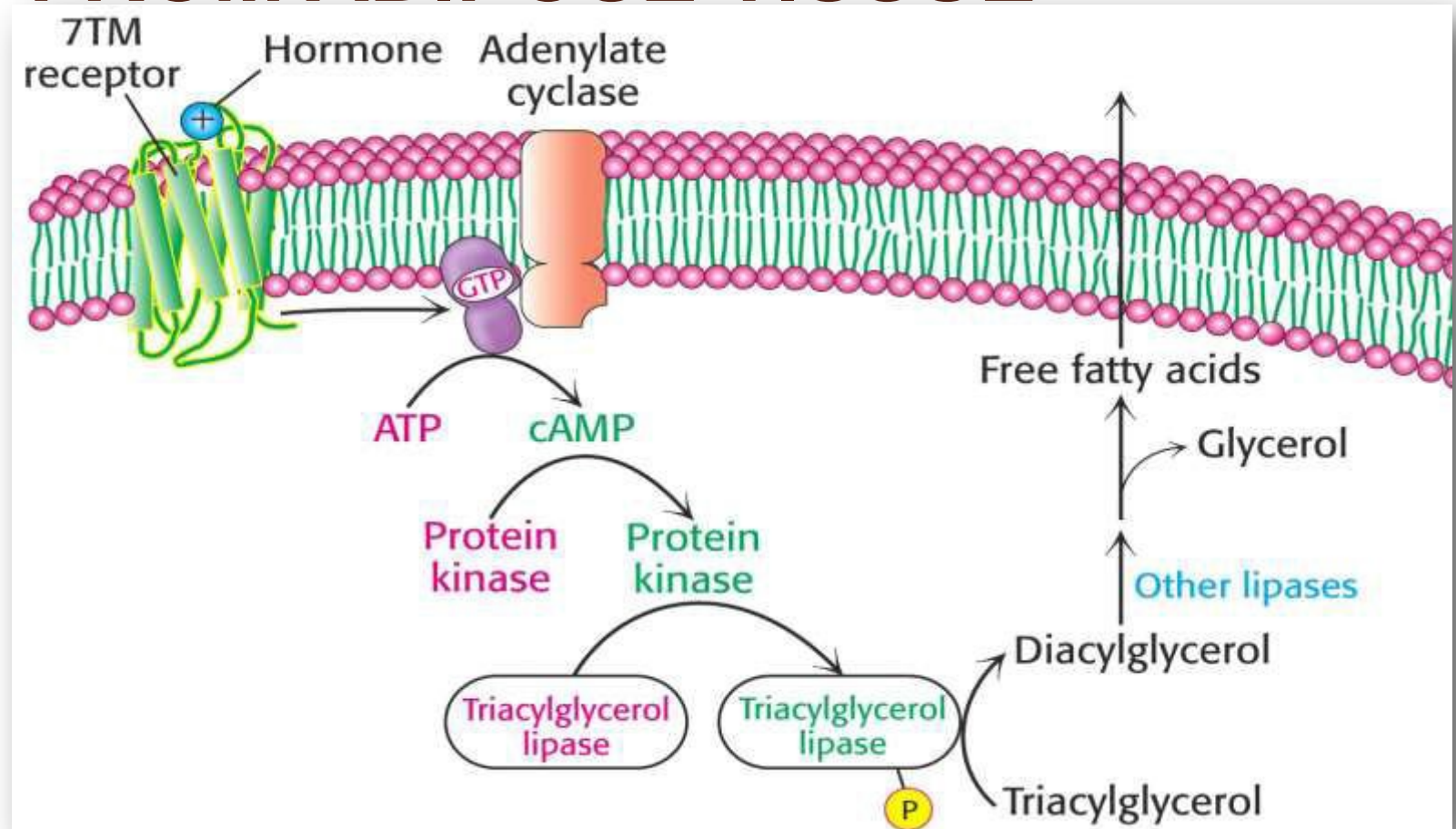
# PROVISION OF DIETARY FATTY ACIDS



Most lipids are ingested in the form of triacylglycerols, that must be degraded to fatty acids for absorption across the intestinal epithelium.

- Free fatty acids and monoacylglycerols obtained by digestion of dietary triglycerides are absorbed by intestinal epithelial cells.
- Triacylglycerols are resynthesized and packaged with other lipids and apoprotein B-48 to form chylomicrons, which are then released into the lymph system.

# PROVISION OF FATTY ACIDS FROM ADIPOSE TISSUE



The triacylglycerols are degraded to fatty acids and glycerol by hormone sensitive lipase. The released fatty acids are transported to the energy-requiring tissues.

# TRANSPORTATION OF FREE FATTY ACIDS

- ❑ Free fatty acids—also called unesterified (UFA) or nonesterified (NEFA) fatty acids—are fatty acids that are in the **unesterified state**.
- ❑ In plasma, longer-chain FFA are combined with **albumin**, and in the cell they are attached to a **fatty acid-binding protein**.
- ❑ **Shorter-chain fatty acids are more water-soluble and exist as the un-ionized acid or as a fatty acid anion.**
- ❑ By these means, free fatty acids are made accessible as a fuel in other tissues.

# TYPES OF FATTY ACID OXIDATION

Fatty acids can be oxidized by-

1) **Beta oxidation**- Major mechanism, occurs in the mitochondria matrix. 2-C units are released as acetyl CoA per cycle.

2) **Alpha oxidation**- Predominantly takes place in brain and liver, one carbon is lost in the form of CO<sub>2</sub> per cycle.

3) **Omega oxidation**- Minor mechanism, but becomes important in conditions of impaired beta oxidation

4) **Peroxisomal oxidation**- Mainly for the trimming of very long chain fatty acids.

# BETA OXIDATION

## Overview of beta oxidation

A saturated acyl Co A is degraded by a recurring sequence of four reactions:

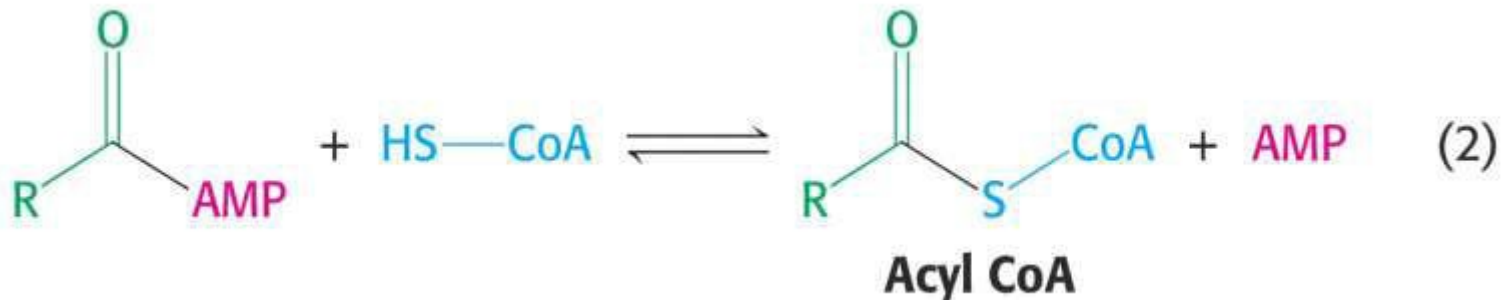
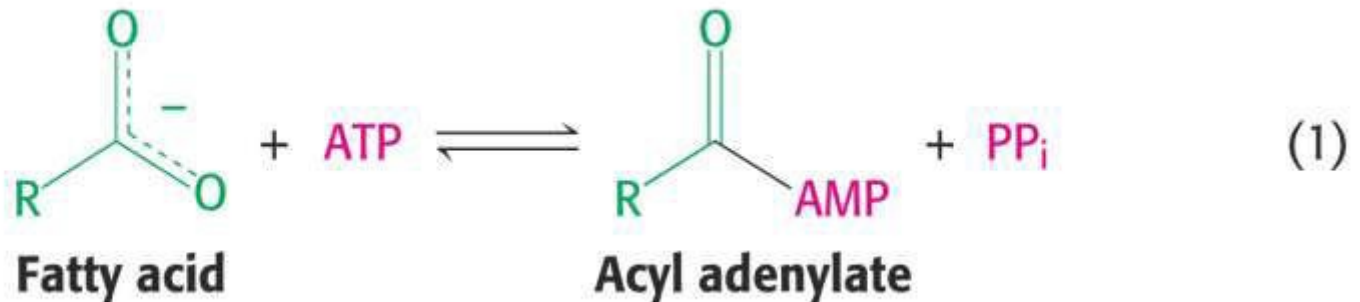
- 1) **Oxidation** by flavin adenine dinucleotide (FAD)
- 2) **Hydration**,
- 3) **Oxidation** by  $\text{NAD}^+$ , and
- 4) **Thiolysis** by CoASH

# BETA OXIDATION

- ❑ The fatty acyl chain is shortened by two carbon atoms as a result of these reactions,
- ❑ FADH<sub>2</sub>, NADH, and acetyl Co A are generated.
- ❑ Because oxidation is on the  $\beta$  carbon and the chain is broken between the  $\alpha$  (2)- and  $\beta$  (3)-carbon atoms—hence the name –  $\beta$  oxidation .

# ACTIVATION OF FATTY ACIDS

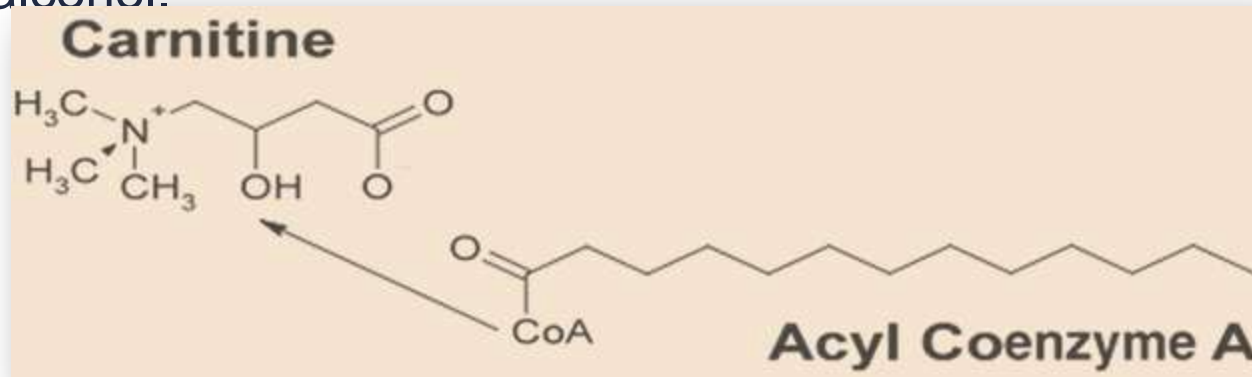
- Fatty acids must first be converted to an active intermediate before they can be catabolized. This is the only step in the complete degradation of a fatty acid that requires energy from ATP. The activation of a fatty acid is accomplished in two steps.





# TRANSPORT OF FATTY ACID IN TO MITOCHONDRIAL MATRIX

- ❑ Fatty acids are activated on the outer mitochondrial membrane, whereas they are oxidized in the mitochondrial matrix.
- ❑ Activated long-chain fatty acids are transported across the membrane by conjugating them to *carnitine*, a zwitterionic alcohol.



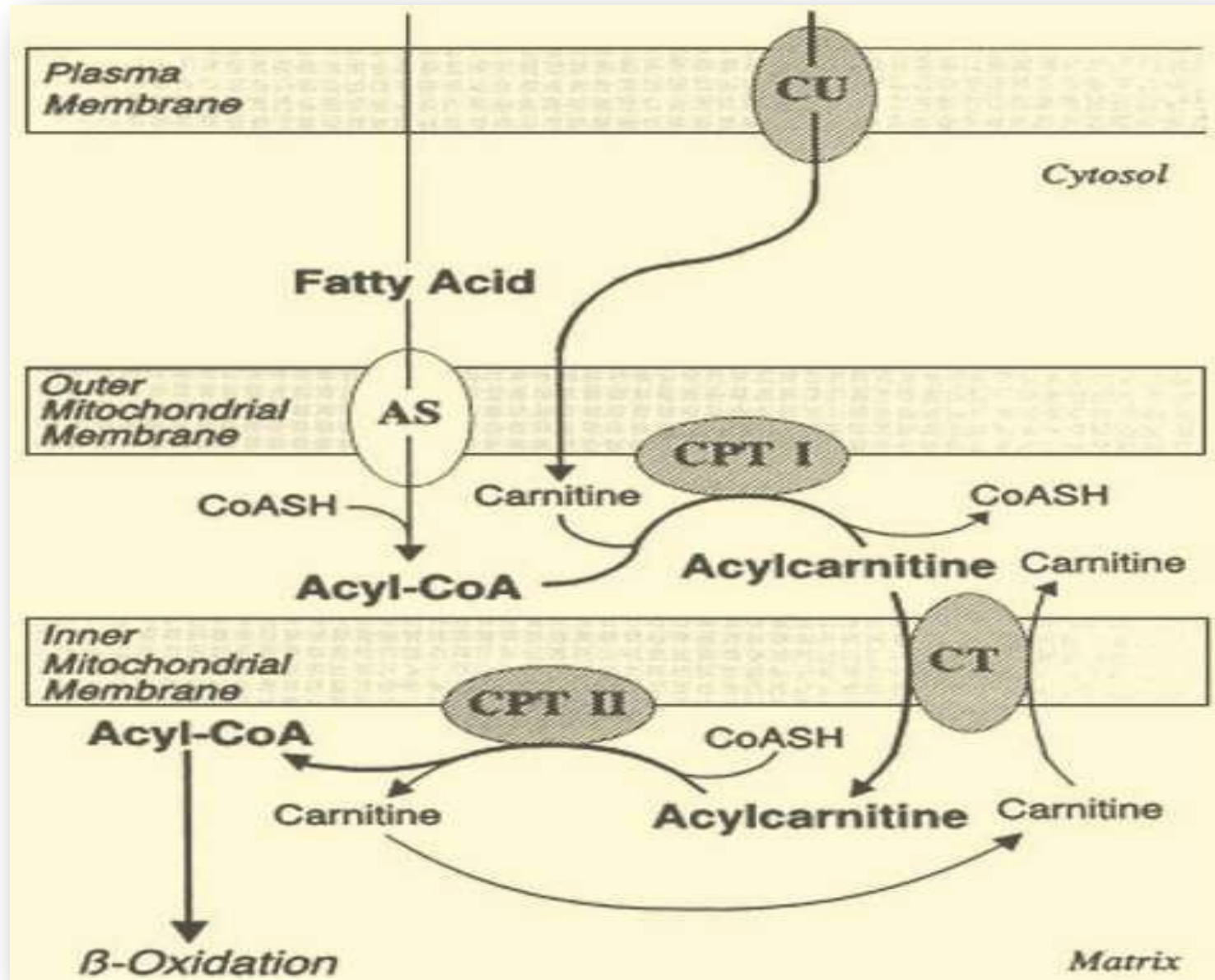
Carnitine ( $\beta$ -hydroxy- $\gamma$ -trimethyl ammonium butyrate),  $(\text{CH}_3)_3\text{N}^+—\text{CH}_2—\text{CH}(\text{OH})—\text{CH}_2—\text{COO}^-$ , is widely distributed and is particularly abundant in muscle. Carnitine is obtained from foods, particularly animal-based foods, and via endogenous synthesis.

# ROLE OF CARNITINE

- 1) The acyl group is transferred to the hydroxyl group of carnitine to form *acyl carnitine*. This reaction is catalyzed by ***carnitine acyl transferase I***
- 2) Acyl carnitine is then shuttled across the inner mitochondrial membrane by a **translocase**.
- 3) The acyl group is transferred back to CoA on the matrix side of the membrane. This reaction, which is catalyzed by ***carnitine acyl transferase II***.

Finally, the translocase returns carnitine to the cytosolic side in exchange for an incoming acyl carnitine

# ROLE OF CARNITINE



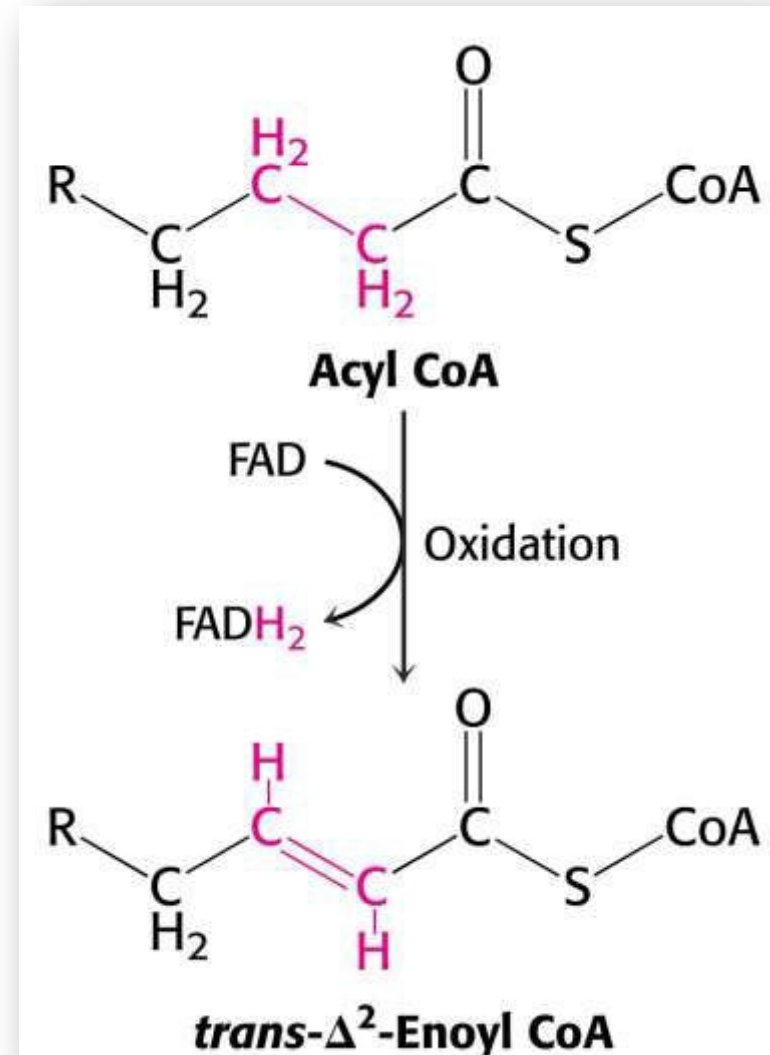
# STEPS OF BETA OXIDATION

## Step-1

### Dehydrogenation-

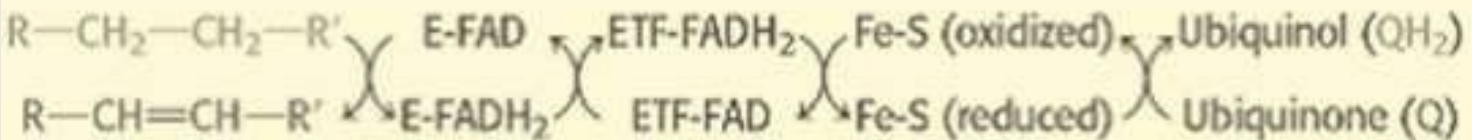
The first step is the removal of two hydrogen atoms from the 2( $\alpha$ )- and 3( $\beta$ )-carbon atoms, catalyzed by **acyl-CoA**

**dehydrogenase** and requiring FAD. This results in the formation of  $\Delta^2$ -*trans*-enoyl-CoA and FADH

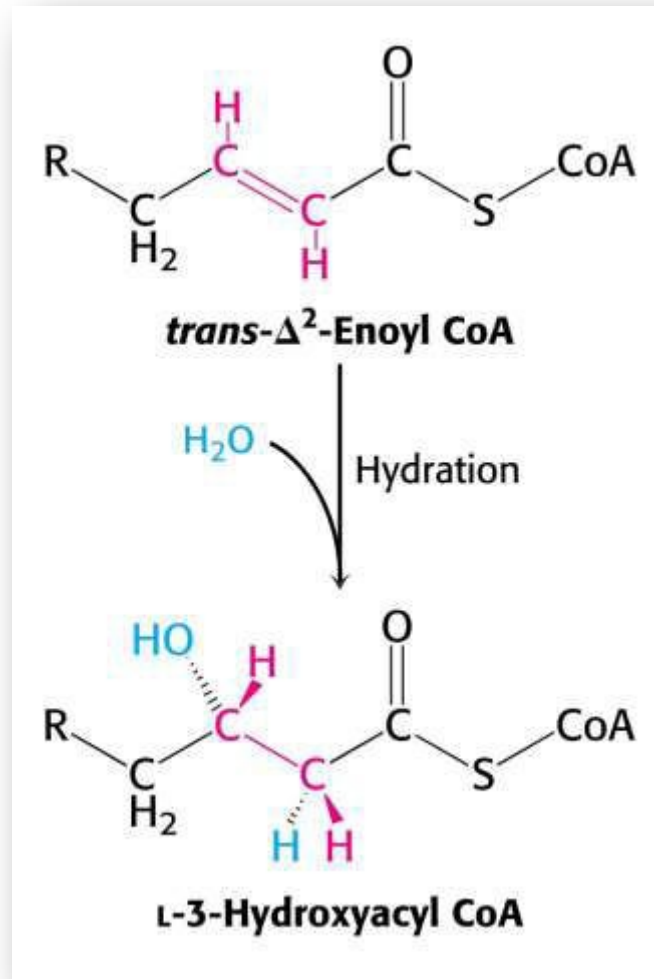


# STEPS OF BETA OXIDATION

- ❑ Electrons from the FADH<sub>2</sub> prosthetic group of the reduced acyl CoA dehydrogenase are transferred to **electron-transferring flavoprotein (ETF)**.
- ❑ ETF donates electrons to **ETF: ubiquinone reductase, an iron-sulfur protein**.
- ❑ Ubiquinone is thereby reduced to ubiquinol, which delivers its high-potential electrons to the second proton-pumping site of the respiratory



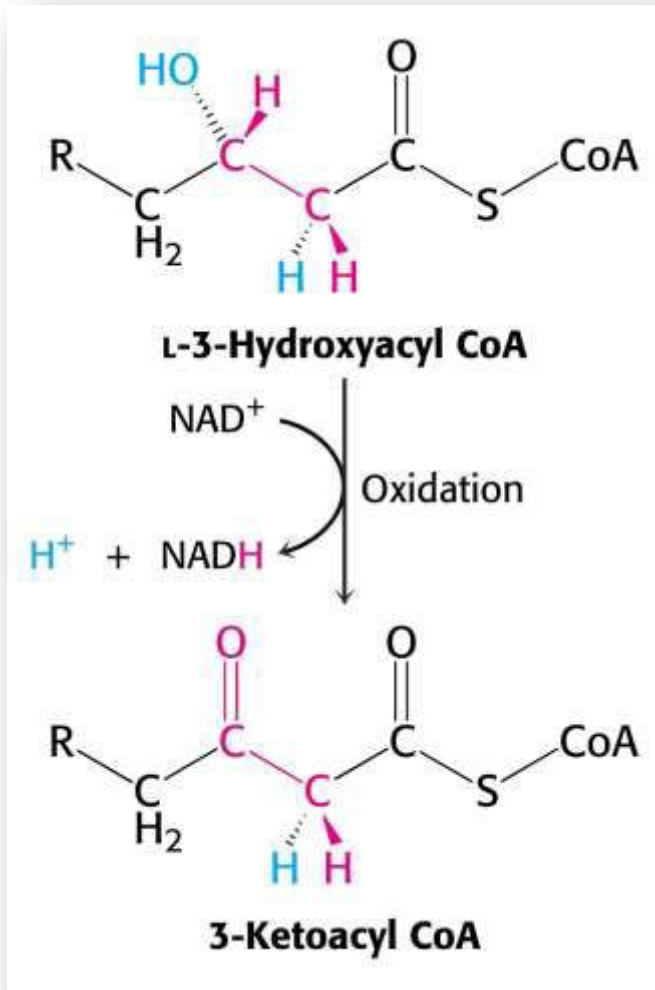
# STEPS OF BETA OXIDATION



## Step-2- Hydration

Water is added to saturate the double bond and form 3-hydroxyacyl-CoA, catalyzed by  $\Delta^2$ -enoyl-CoA hydratase.

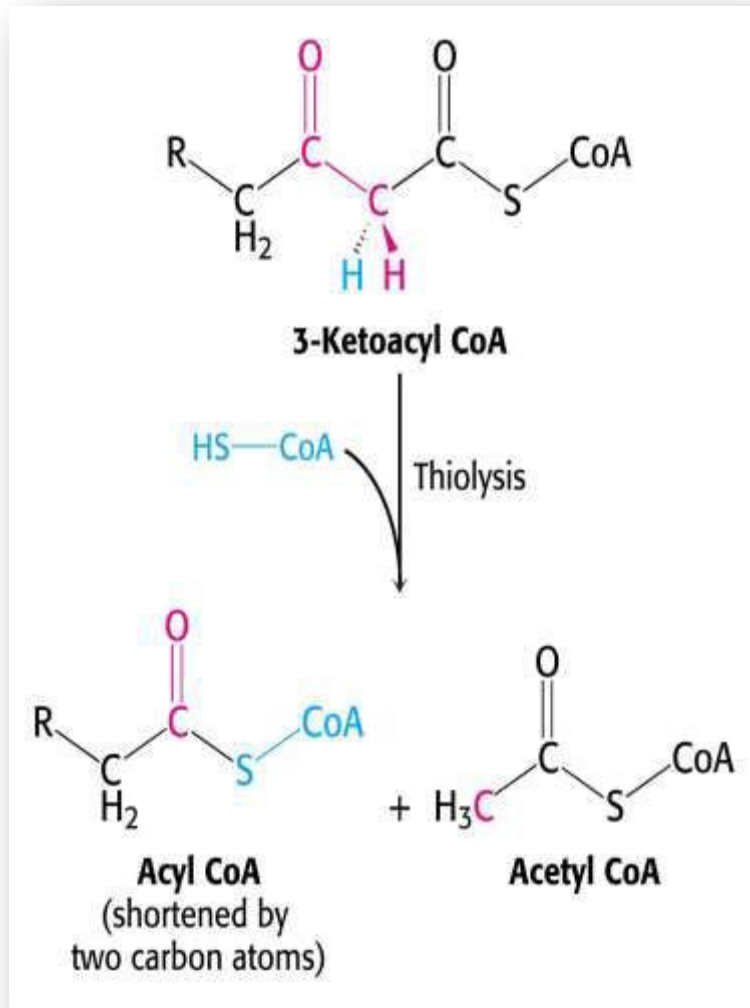
# STEPS OF BETA OXIDATION



## Step-3- dehydrogenation-

The 3-hydroxy derivative undergoes further dehydrogenation on the 3-carbon catalyzed by **L(+)-3-hydroxyacyl-CoA dehydrogenase** to form the corresponding 3-ketoacyl-CoA compound. In this case, NAD<sup>+</sup> is the coenzyme involved.

# STEPS OF BETA OXIDATION

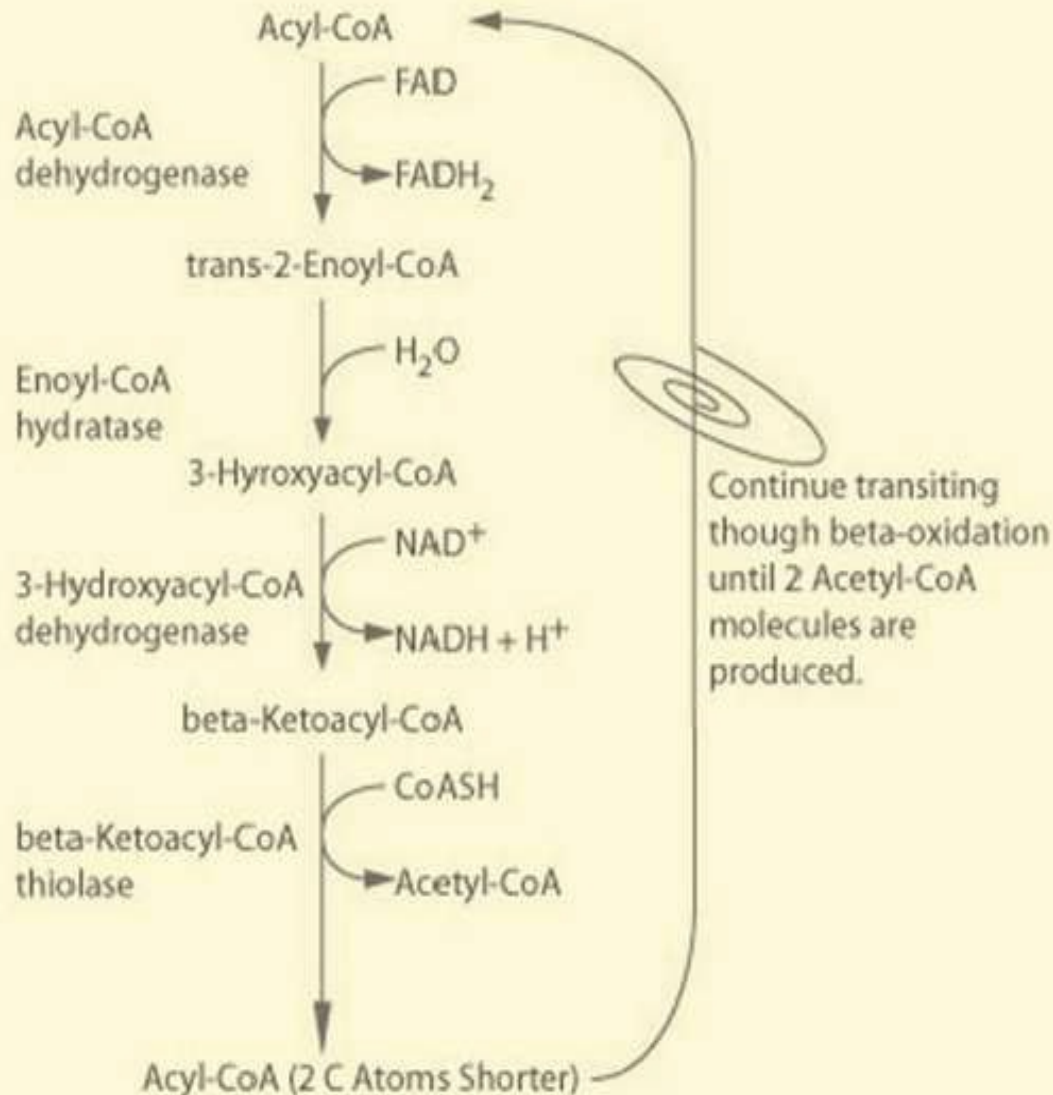


## Step-4- Thiolysis

-  
3-ketoacyl-CoA is split at the 2,3-position by **thiolase** (3-ketoacyl-CoA-thiolase), forming acetyl-CoA and a new acyl-CoA two carbons shorter than the original acyl-CoA molecule.



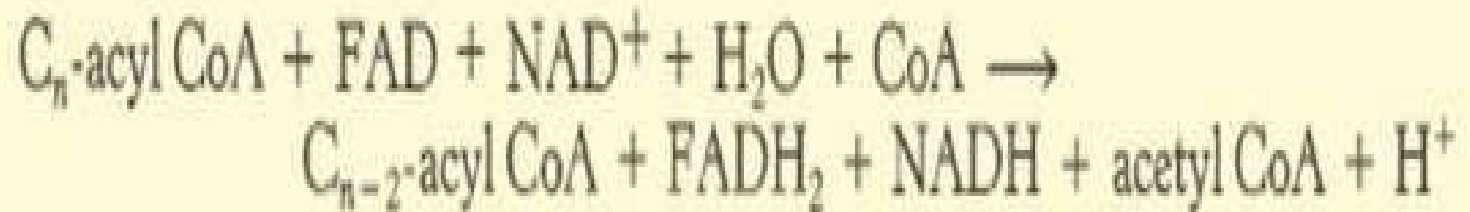
# STEPS OF BETA OXIDATION



- ❑ The acyl-CoA formed in the cleavage reaction reenters the oxidative pathway at reaction 2.
- ❑ Since acetyl-CoA can be oxidized to CO<sub>2</sub> and water via the citric acid cycle the complete oxidation of fatty acids is achieved

# BETA OXIDATION

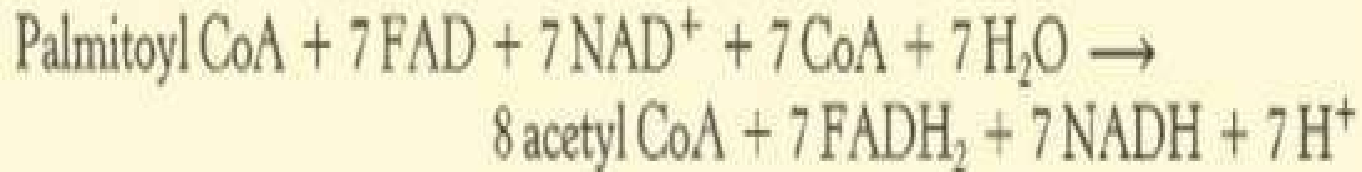
The overall reaction can be represented as follows-



# BETA OXIDATION- ENERGY YIELD

**Energy yield by the complete oxidation of one mol of Palmitic acid-**

The degradation of palmitoyl CoA (C16-acyl Co A) requires seven reaction cycles. In the seventh cycle, the C4-ketoacyl CoA is thiolyzed to two molecules of acetyl CoA.



106 (129 As per old concept) ATP are produced by the complete oxidation of one mol of Palmitic acid.

# BETA OXIDATION- ENERGY YIELD

2.5 ATPs per NADH = 17.5

1.5 ATPs per FADH<sub>2</sub> = 10.5

10 ATPs per acetyl-CoA = 80

Total = 108 ATPs

2 ATP equivalents (ATP → AMP + PPi

PPi → 2 Pi)

consumed during activation of palmitate to  
Palmitoyl CoA

Net Energy output- 108-2 = 106 ATP

# DISORDERS ASSOCIATED WITH IMPAIRED BETA OXIDATION

## 1) Deficiencies of carnitine or carnitine transferase or translocase

- ❑ Symptoms include muscle cramps during exercise, severe weakness and death.
- ❑ Muscle weakness related to importance of fatty acids as long term energy source
- ❑ Hypoglycemia and hypo ketosis are common findings
- ❑ Diet containing medium chain fatty acids is recommended since they do not require carnitine shuttle to enter mitochondria.

# DISORDERS ASSOCIATED WITH IMPAIRED BETA OXIDATION

**2) Jamaican Sickness-** Jamaican vomiting sickness is caused by eating the unripe fruit of akee tree, which contains the toxin hypoglycin, that inactivates medium and short-chain acyl-CoA dehydrogenases, inhibiting  $\beta$  oxidation and thereby causing hypoglycemia.

**3) Dicarboxylic aciduria** is characterized by-

- i) Excretion of  $C_6-C_{10}$  -dicarboxylic acids and
- ii) **Nonketotic hypoglycemia** which is caused by lack of mitochondrial **medium chain acyl-CoA dehydrogenases**.

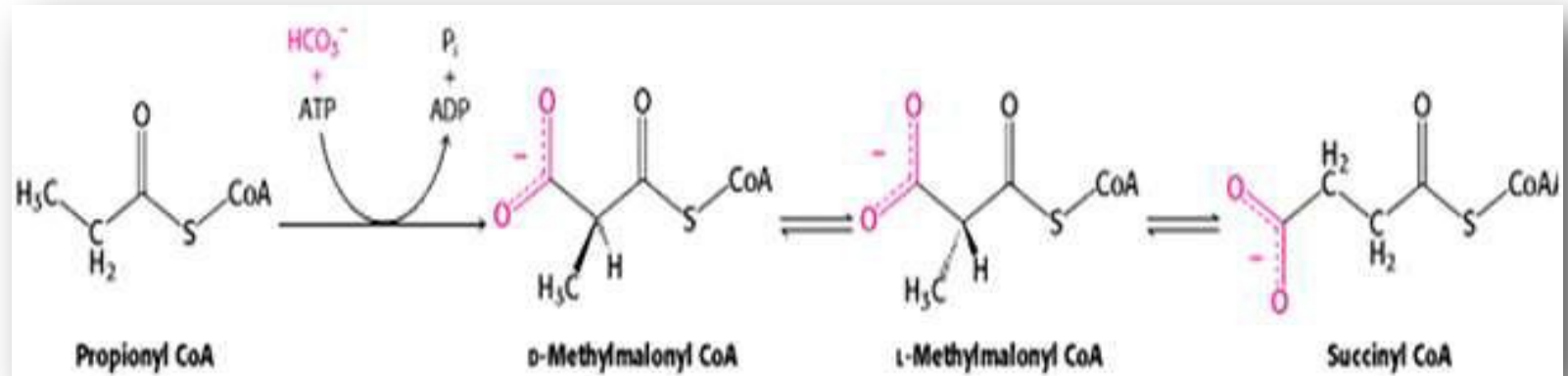
# DISORDERS ASSOCIATED WITH IMPAIRED BETA OXIDATION

## 4) Acute fatty liver of pregnancy

- ❑ Manifests in the second half of pregnancy, usually close to term, but may also develop in the postpartum period.
- ❑ The patient developed symptoms of hepatic dysfunction at 36 weeks of gestation.
- ❑ Short history of illness, hypoglycemia, liver failure, renal failure, and coagulopathy are observed.
- ❑ Diagnosis is made based on an incidental finding of abnormal liver enzyme levels.
- ❑ Affected patients may become jaundiced or develop encephalopathy from liver failure, usually reflected by an elevated ammonia level.
- ❑ Profound hypoglycemia is common.

# BETA OXIDATION OF ODD CHAIN FATTY ACIDS

Fatty acids with an odd number of carbon atoms are oxidized by the pathway of  $\beta$ -oxidation, producing acetyl-CoA, until a three-carbon (propionyl-CoA) residue remains. This compound is converted to Succinyl-CoA, a constituent of the citric acid cycle



The propionyl residue from an odd-chain fatty acid is the only part of a fatty acid that is glucogenic. Acetyl CoA cannot be converted into pyruvate or Oxaloacetate in animals.

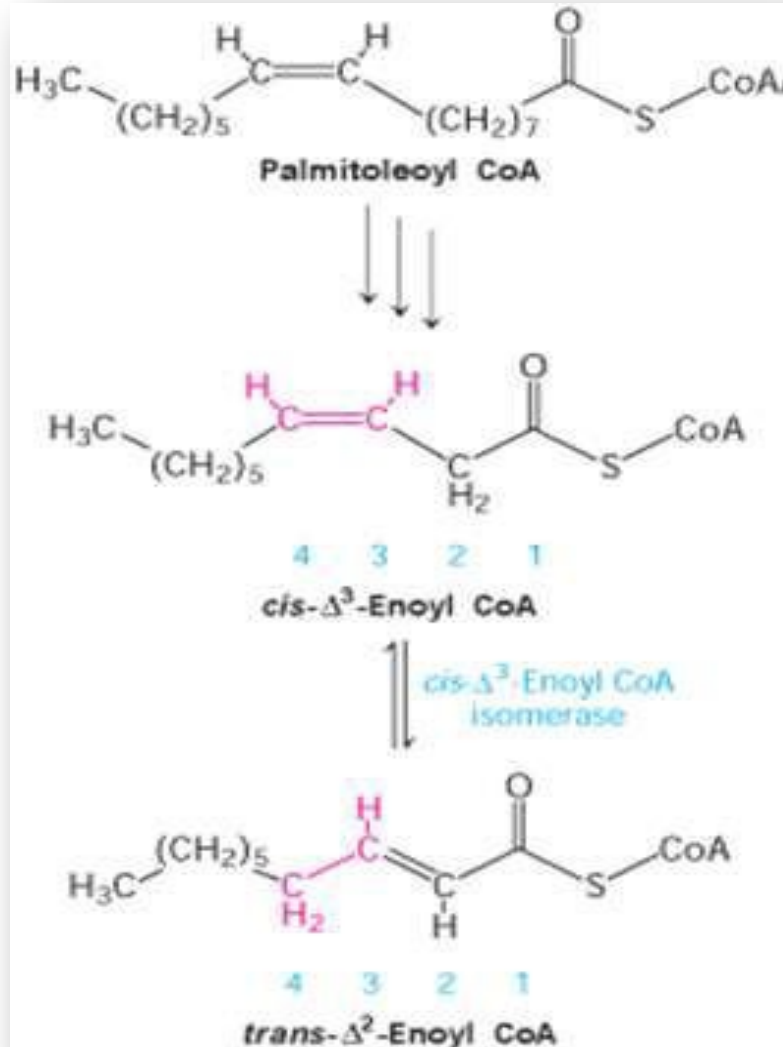


# BETA OXIDATION OF UNSATURATED FATTY ACIDS

- ❑ In the oxidation of unsaturated fatty acids, most of the reactions are the same as those for saturated fatty acids, only two additional enzymes an **isomerase** and a **reductase** are needed to degrade a wide range of unsaturated fatty acids.
- ❑ Energy yield is less by the oxidation of unsaturated fatty acids since they are less reduced.
- ❑ Per double bonds 2 ATP are less formed, since the first step of dehydrogenation to introduce double bond is not required.

# BETA OXIDATION OF

# UNSATURATED FATTY ACIDS



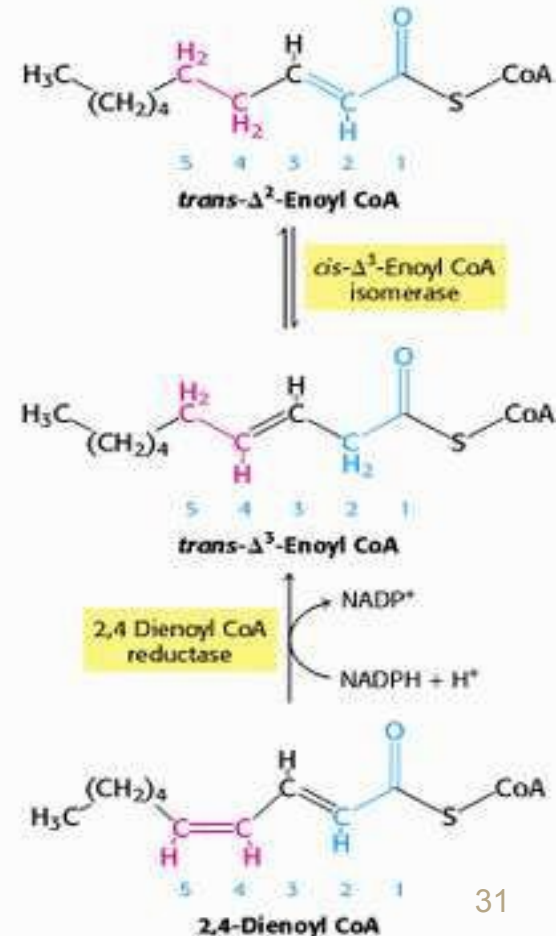
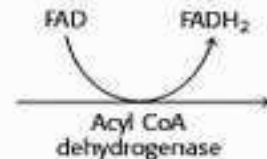
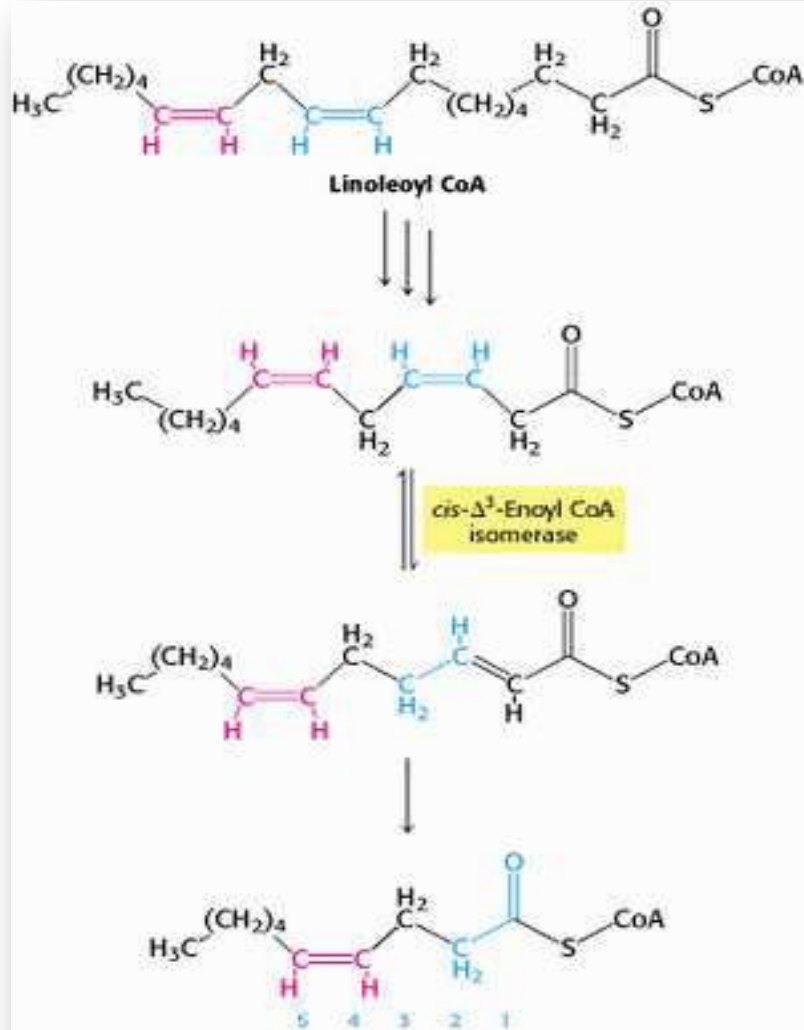
Palmitoleoyl CoA undergoes three cycles of degradation, which are carried out by the same enzymes as in the oxidation of saturated fatty acids.

The *cis*- $\Delta^3$ -enoyl CoA formed in the third round is not a substrate for acyl CoA dehydrogenase.

**An isomerase converts this double bond into a trans- $\Delta^2$  double bond.**

The subsequent reactions are those of the saturated fatty acid oxidation pathway, in which The *cis*- $\Delta^3$ -enoyl CoA is a

# BETA OXIDATION OF POLYUNSATURATED FATTY ACIDS



# BETA OXIDATION OF POLY UNSATURATED FATTY ACIDS

- A different set of enzymes is required for the oxidation of Linoleic acid, a C18 polyunsaturated fatty acid with cis- $\Delta$  9 and cis- $\Delta$ 12 double bonds .
- The cis-  $\Delta$  3 double bond formed after three rounds of  $\beta$  oxidation is converted into a trans-  $\Delta$  2 double bond by isomerase.
- The acyl CoA produced by another round of  $\beta$  oxidation contains a cis-  $\Delta$  4 double bond. Dehydrogenation of this species by **acyl CoA dehydrogenase yields a 2,4-dienoyl intermediate**, which is not a substrate for the next enzyme in the  $\beta$  -oxidation pathway.
- This impasse is circumvented by *2,4-dienoyl CoA reductase*, an enzyme that uses NADPH to reduce the **2,4-dienoyl intermediate to trans- $\Delta$  3-enoyl CoA**.
- *cis- $\Delta$  3-Enoyl CoA isomerase* then converts *trans-  $\Delta$  3-enoyl CoA* into the trans-  $\Delta$  2 form, a customary intermediate in the beta-oxidation pathway

# MINOR PATHWAYS OF FATTY ACID OXIDATION

- 1)  **$\alpha$ - Oxidation-** Oxidation occurs at C-2 instead of C-3 , as in  $\beta$  oxidation
- 2)  **$\omega$ - Oxidation –** Oxidation occurs at the methyl end of the fatty acid molecule.
- 3) **Peroxisomal fatty acid oxidation-** Occurs for the chain shortening of very long chain fatty acids.

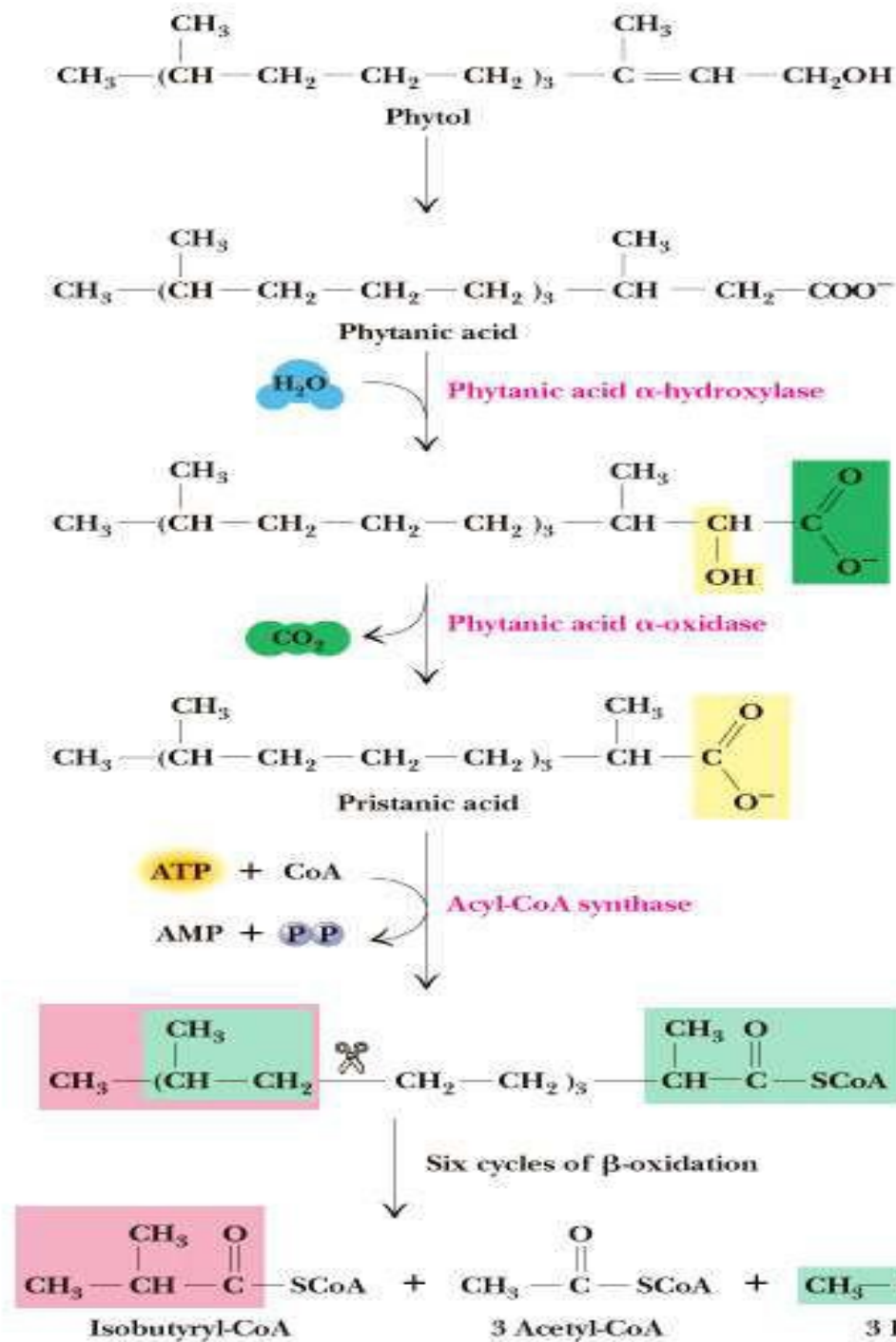
# $\alpha$ - OXIDATION OF FATTY ACIDS



- ❑ Takes place in the microsomes of brain and liver,
- ❑ Involves decarboxylation process for the removal of single carbon atom at one time with the resultant production of an odd chain fatty acid that can be subsequently oxidized by beta oxidation for energy production.
- ❑ It is strictly an aerobic process.
- ❑ No prior activation of the fatty acid is required.
- ❑ The process involves hydroxylation of the alpha carbon with a specific  $\alpha$ -hydroxylase that requires  $\text{Fe}^{++}$  and vitamin C/FH4 as cofactors.

# BIOLOGICAL SIGNIFICANCE OF ALPHA OXIDATION

- $\alpha$ - Oxidation is most suited for the oxidation of phytanic acid, produced from dietary phytol, a constituent of chlorophyll of plants.
- **Phytanic acid** is a significant constituent of milk lipids and animal fats.
- Normally it is metabolized by an initial  **$\alpha$ -hydroxylation followed by dehydrogenation and decarboxylation.**
- Beta oxidation can not occur initially because of the presence of 3- methyl groups, but it can proceed after decarboxylation.
- **The whole reaction produces three molecules of propionyl co A, three molecules of Acetyl co A, and one molecule of iso butyryl co A .**



Phytanic acid is oxidized by Phytanic acid  $\alpha$  oxidase ( $\alpha$ -hydroxylase enzyme) to yield CO<sub>2</sub> and odd chain fatty acid Pristanic acid that can be subsequently oxidized by beta oxidation.



# BIOLOGICAL SIGNIFICANCE OF ALPHA OXIDATION

2) The **hydroxy fatty acids** produced as intermediates of this pathway like Cerebronic acid can be used for the synthesis of **cerebrosides and sulfatides**

3) **Odd chain fatty acids** produced upon decarboxylation in this pathway, can be used for the synthesis of **sphingolipids** and can also **undergo beta oxidation to form propionyl co A and Acetyl co A**. The number of acetyl co A depend upon the chain length. Propionyl co A is converted to Succinyl co A to gain entry in to TCA cycle for further oxidation.

# CLINICAL SIGNIFICANCE OF ALPHA OXIDATION

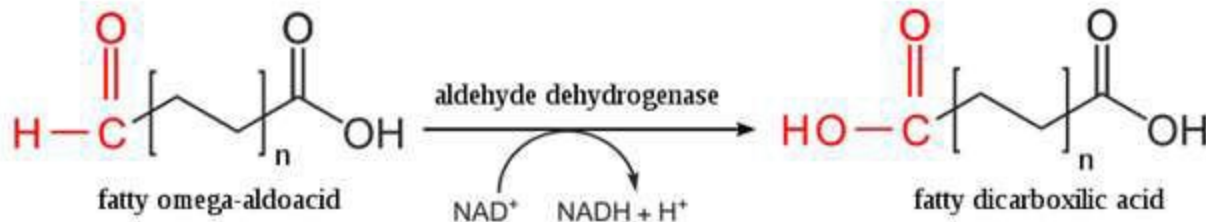
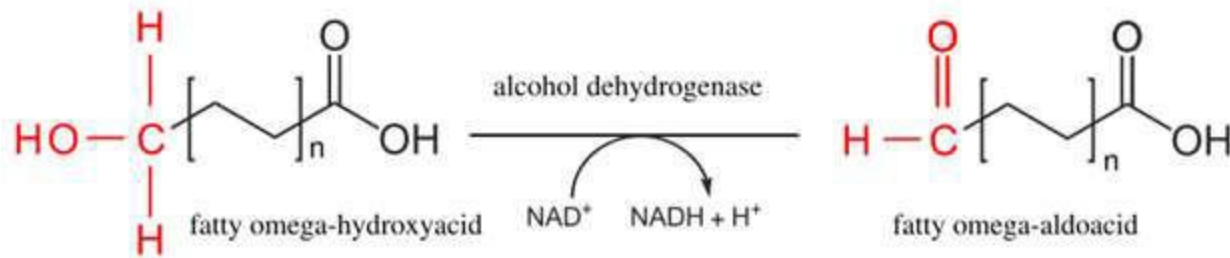
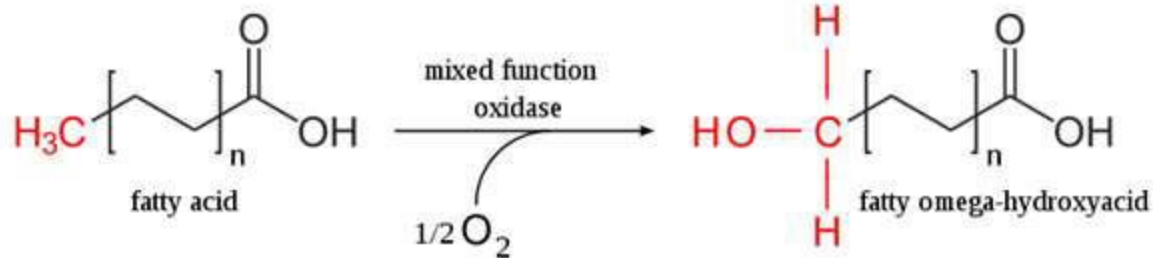
**Refsum's disease (RD)**-is a neurocutaneous syndrome that is characterized biochemically by the accumulation of phytanic acid in plasma and tissues. Patients with Refsum disease are unable to degrade phytanic acid because of a deficient activity of Phytanic acid oxidase enzyme catalyzing the first step of phytanic acid alpha-oxidation.

**Peripheral polyneuropathy, cerebellar ataxia, retinitis pigmentosa, and Ichthyosis (rough, dry and scaly skin) are the major clinical components.** The symptoms evolve slowly and insidiously from childhood through adolescence and early adulthood.

# OMEGA OXIDATION OF FATTY ACIDS

- ❑ Involves **hydroxylation** and occurs in the endoplasmic reticulum of many tissues.
- ❑ **Hydroxylation takes place on the methyl carbon** at the other end of the molecule from the carboxyl group or on the carbon next to the methyl end.
- ❑ It uses the “**mixed function oxidase**” type of reaction requiring **Cytochrome P450, O<sub>2</sub> and NADPH**, as well as the necessary enzymes.
- ❑ Hydroxy fatty acids can be further oxidized to a dicarboxylic acid via **sequential reactions of Alcohol dehydrogenase and aldehyde dehydrogenases**.
- ❑ The process occurs **primarily with medium chain fatty acids**.

# OMEGA OXIDATION OF FATTY ACIDS



Dicarboxylic acids so formed can undergo beta oxidation to produce shorter chain dicarboxylic acids such as Adipic acids(C6) and succinic acid (C4).

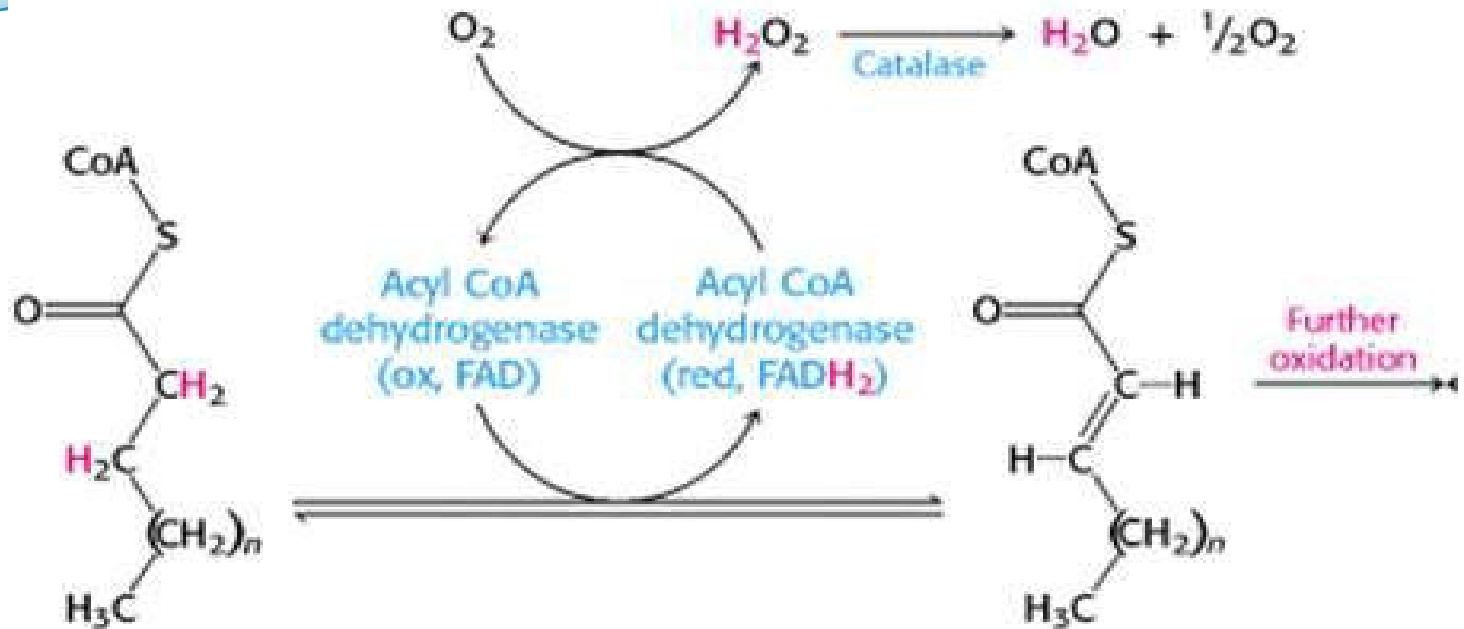
# SIGNIFICANCE OF OMEGA OXIDATION

- ❑ The microsomal (endoplasmic reticulum, ER) pathway of fatty acid  $\omega$ -oxidation represents a minor pathway of overall fatty acid oxidation.
- ❑ However, in certain pathophysiological states, such as **diabetes, chronic alcohol consumption, and starvation**, the  $\omega$ -oxidation pathway may provide an effective means for the elimination of toxic levels of free fatty acids.

# PEROXISOMAL OXIDATION OF VERY LONG CHAIN FATTY ACIDS

- ❑ In peroxisomes, a flavoprotein dehydrogenase transfers electrons to  $O_2$  to yield  $H_2O_2$  instead of capturing the high-energy electrons as  $FADH_2$ , as occurs in mitochondrial beta oxidation.
- ❑ Catalase is needed to convert the hydrogen peroxide produced in the initial reaction into water and oxygen.
- ❑ Subsequent steps are identical with their mitochondrial counterparts,
- ❑ They are carried out by different isoform of the enzymes.

# PEROXISOMAL OXIDATION OF VERY LONG CHAIN FATTY ACIDS



The specificity of the peroxisomal enzymes is for longer chain fatty acids. Thus peroxisomal enzymes function to shorten the chain length of relatively long chain fatty acids to a point at which beta oxidation can be completed in mitochondria.

# SIGNIFICANCE OF PEROXISOMAL OXIDATION

- ❑ Peroxisomal reactions include **chain shortening of very long chain fatty acids, dicarboxylic acids, conversion of cholesterol to bile acids and formation of ether lipids.**
- ❑ The congenital absence of functional peroxisomes, an inherited defect, causes **Zellweger syndrome.**



# ZELLWEGER SYNDROME



- ❑ **Zellweger syndrome**, also called **cerebrohepatorenal syndrome** is a rare, congenital disorder (present at birth), characterized by the **reduction or absence of Peroxisomes in the cells of the liver, kidneys, and brain.**
- ❑ The most common features of Zellweger syndrome include **vision disturbances, prenatal growth failure, lack of muscle tone, unusual facial characteristics, mental retardation, seizures, and an inability to suck and/or swallow.**

# ZELLWEGER SYNDROME

- ◻ The **abnormally high levels of VLCFA( Very long chain fatty acids )**, are most diagnostic.
- ◻ There is no cure for Zellweger syndrome, nor is there a standard course of treatment.
- ◻ Most treatments are **symptomatic and supportive.**
- ◻ Most infants do not survive past the first 6 months, and usually succumb to **respiratory distress, gastrointestinal bleeding, or liver failure.**

## Topic - Biosynthesis of Palmitic acid

- ✓ Lipid which is considered as a principal form of stored energy, is the major component of phospholipid bilayer Plasma Membrane.
- ✓ Liver, Kidney, adipose tissue and lactating mammary glands are the organs where de novo synthesis of fatty acid occurs.
- ✓ Site for Fatty acid biosynthesis is **cytosol**.
- ✓ **Prerequisite for Fatty acid biosynthesis include following things**
  - ✓ 1. **Acetyl CoA**
  - ✓ 2. **NADPH**.
  - ✓ 3. **ATP**
- ✓ **Fatty acid biosynthesis can be understand in 3 stages:-**
  - ✓ 1. **Production of Acetyl CoA and NADPH.**
  - ✓ 2. **Conversion of Acetyl CoA to malonyl CoA**
  - ✓ 3. **Reactions which are catalyzed by Fatty Acid Synthase complex.**
  - ✓

### What is Fatty acid synthase enzyme?

- ✓ **Fatty Acid Synthase complex is a multifunctional enzyme which is made up of dimer with two identical subunits including ACP (Acyl Carrier Protein). ACP is responsible for transfer of acyl group from acetyl CoA and 2 carbon fragment from malonyl CoA for the elongation of carbon chain required for fatty acid biosynthesis like 16 Carbon compounds called palmitate.**

### Fatty acid synthase complex is made up of

- ✓ 1. **Acetyl transacylase**
- ✓ 2. **Malonyl transacylase**

- ✓ 3. Ketoacyl synthase
- ✓ 4. Ketoacyl reductase
- ✓ 5. Dehydratase
- ✓ 6. Enoyl reductase.
- ✓ 7. Thioesterase.

### **Production of Acetyl CoA and NADPH**

Acetyl CoA is produced in mitochondria by oxidation of pyruvate (PDH complex) and oxidation of fatty acid.

Oxidation of fatty acid gives 8 molecules of acetyl CoA.

**But the problem is that acetyl CoA cannot permeable to mitochondria as it has to go cytosol for FAB.**

So, in mitochondria, acetyl CoA condense with OAA to form citrate.

Citrate can pass through mitochondrial membrane and comes to cytosol where an enzyme called citrate lyase cleaved citrate into OAA and Acetyl CoA.

OAA is converted into malate in cytosol and malate into pyruvate by malic enzyme with **NADPH formation** which is a **reducing equivalent** and **required for fatty acid biosynthesis**.

### **Formation of malonyl CoA**

It is formed by carboxylation of acetyl CoA by an enzyme called acetyl CoA carboxylase.

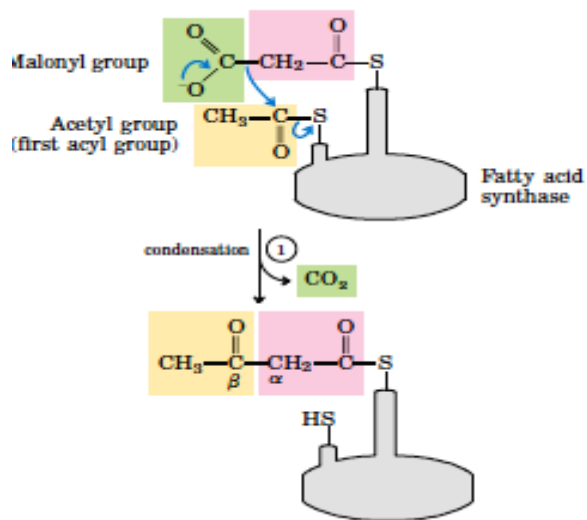
This enzyme is a **ATP** dependent and **requires biotin as a cofactor**.

**Reactions which are catalyzed by Fatty Acid Synthase complex to form long chain fatty acid called Palmitic acid/Palmitate.**

Acyl group from acetyl CoA and malonyl group from malonyl CoA is transferred to fatty acid synthase complex by Acetyl CoA-ACP transacylase and Malonyl CoA-ACP transacylase.

## Step 1 . CONDENSATION RACTION

Acyl (from acetyl CoA) which is the first acyl group and 2 carbon derived from malonyl extends the acyl chain by 2 carbons so this condensation of both molecules is associated with decarboxylation and product form is **Beta ketobutyryl-ACP**. Enzyme is **Beta ketoacyl-ACP synthase**.

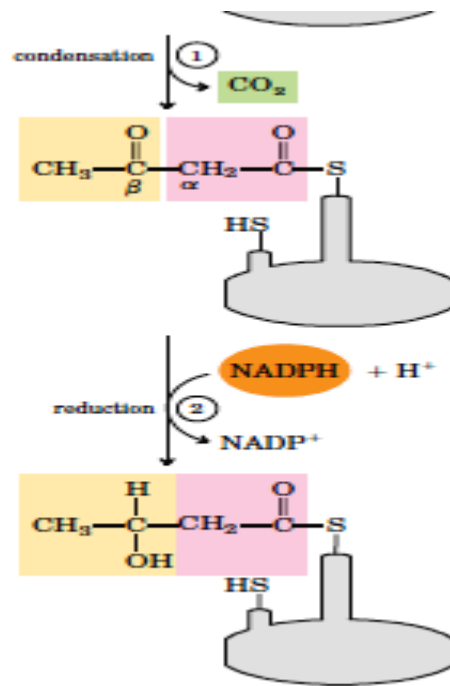


(Adapted from Lehninger)

## Step 2 . Reduction Reaction

Beta ketobutyryl-ACP is then undergo reduction and ketoacyl group is turned into hydroxyl group. Electron donar is NADPH. Enzyme is **beta ketoacyl-ACP reductase**.

Final product is Beta hydroxybutyryl-ACP



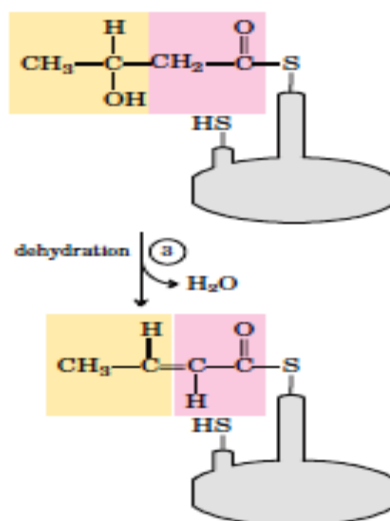
(Adapted from Lehninger)

### Step 3 . Dehydration reaction

Beta hydroxybutyryl ACP undergoes dehydration and forms enoyl ACP. Enzyme is Beta hydroxyacyl-ACP dehydratase.

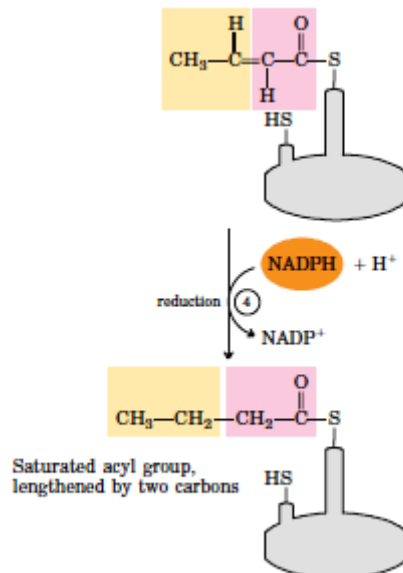
Elimination of water takes place during dehydration reaction.

Product formed will be butenoyl-ACP.



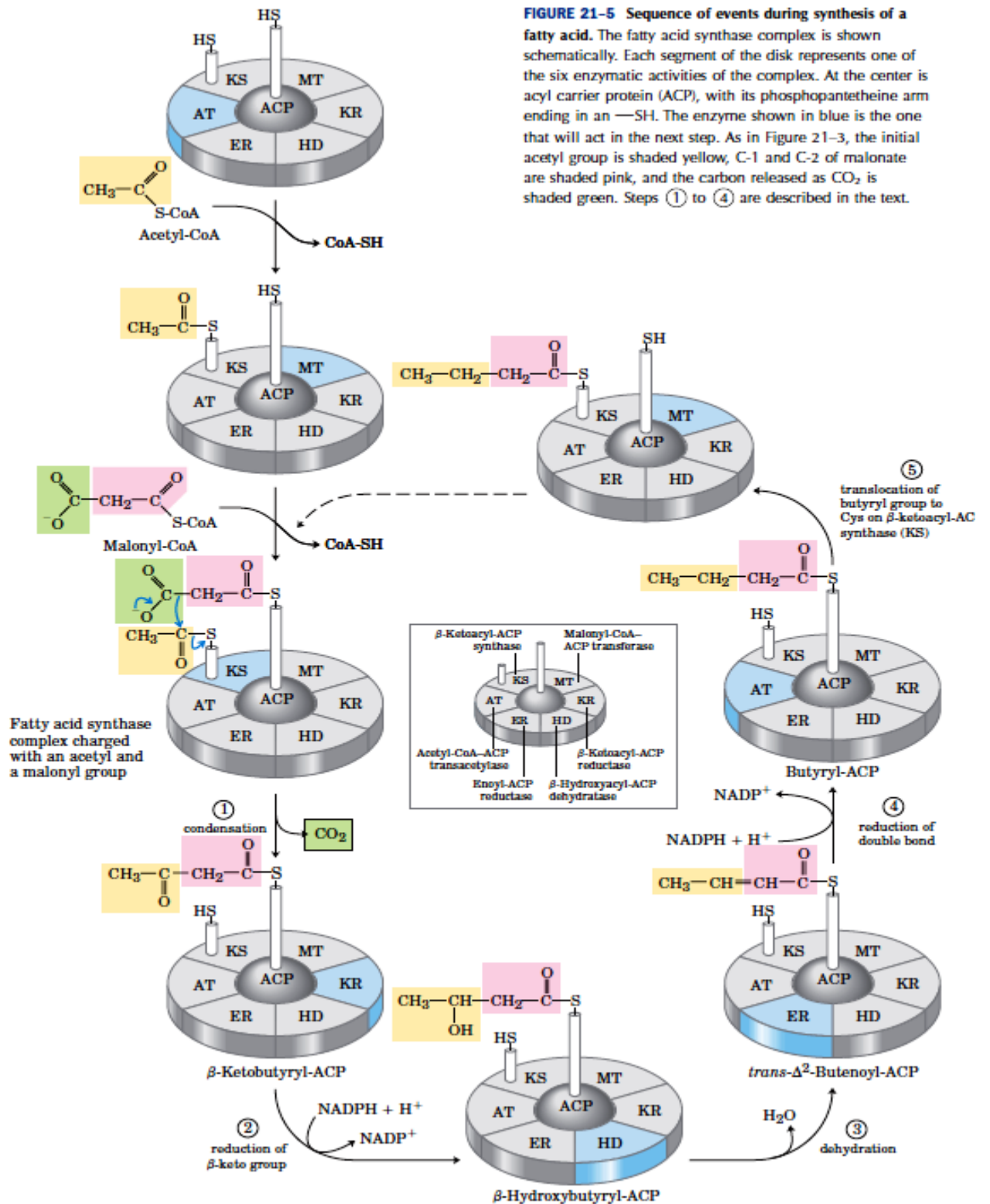
#### Step 4. Reduction reaction

Enoyl ACP reductase catalyses this reaction using NADPH as a reducing equivalent and forms Acyl ACP.



The 4 carbon unit attached to ACP is butyryl. ACP is the carrier molecule which has to transfer carbon chain to cysteine part of Fatty acid synthase enzyme complex and in this way the above mentioned reactions repeated 6 more times.

Note- total 7 times reactions repeated to form 16 Carbon palmitate molecule. In EACH time, chain is elongated by 2 carbon unit. Then finally, palmitoyl thioesterase separates palmitate from ACP. In this way a **fully saturated 16 carbon compound is formed which is called Palmitate.**

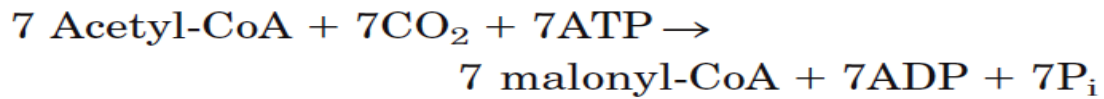


(Taken from Lehninger)

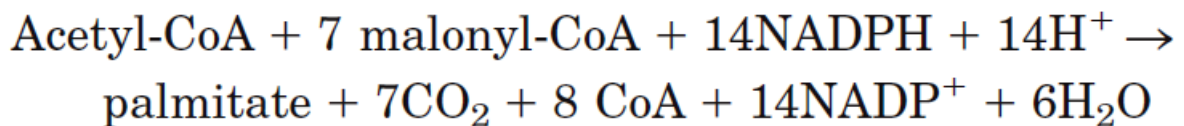


**Overall reaction will be :-**

**Firstpart**



**Second part (7 cycles of condensation and reduction)**



**Regulation of Fatty acid synthesis:-**

1. Controlled by hormones, enzyme and metabolites and end products.
2. Acetyl CoA carboxylase:- This enzyme is active in polymeric form and inactive when exist in monomeric form.  
Citrate promotes polymeric form whereas palmitoyl CoA and malonyl CoA promotes its inactivation.
3. Hormonal control – it includes cAMP dependent phosphorylation for inactivation and vice versa for activation. Insulin promotes fatty acid synthesis and glucagon inhibits.
4. Availability of NADPH – It is provided by citrate (Acetyl CoA) or PPP/HMS (Hexose monophosphate shunt pathway) which significantly influences Fatty acid synthesis

## phosphate buffer

Information from cshprotocols.org:

Gomori buffers, the most commonly used phosphate buffers, consist of a mixture of monobasic dihydrogen phosphate and dibasic monohydrogen phosphate. By varying the amount of each salt, a range of buffers can be prepared that buffer well between pH 5.8 and pH 8.0 (please see the tables below). Phosphates have a very high buffering capacity and are highly soluble in water. However, they have a number of potential disadvantages:

\* Phosphates inhibit many enzymatic reactions and procedures that are the foundation of molecular cloning, including cleavage of DNA by many restriction enzymes, ligation of DNA, and bacterial transformation.

\* Because phosphates precipitate in ethanol, it is not possible to precipitate DNA and RNA from buffers that contain significant quantities of phosphate ions.

\* Phosphates sequester divalent cations such as Ca<sup>2+</sup> and Mg<sup>2+</sup>.

0.5L of 1M K<sub>2</sub>HPO<sub>4</sub> at 174.18g mol<sup>-1</sup> = 87.09g

0.5L of 1M KH<sub>2</sub>PO<sub>4</sub> at 136.09g mol<sup>-1</sup> = 68.045g

## preparation of 0.1 M potassium phosphate buffer at 25°C

### Preparation of 0.1 M Potassium Phosphate Buffer at 25°C

pH	VOLUME OF 1 M K <sub>2</sub> HPO <sub>4</sub> (ml)	VOLUME OF 1 M KH <sub>2</sub> PO <sub>4</sub> (ml)
5.8	8.5	91.5
6.0	13.2	86.8
6.2	19.2	80.8
6.4	27.8	72.2
6.6	38.1	61.9
6.8	49.7	50.3
7.0	61.5	38.5
7.2	71.7	28.3
7.4	80.2	19.8
7.6	86.6	13.4
7.8	90.8	9.2
8.0	94.0	6.0

Dilute the combined 1 M stock solutions to 1 liter with distilled H<sub>2</sub>O. pH is calculated according to the Henderson-Hasselbalch equation:

$$\text{pH} = \text{pK}' + \log \left\{ \frac{(\text{proton acceptor})}{(\text{proton donor})} \right\}$$

where pK' = 6.86 at 25°C.

LIPIDS....

# Introduction

- in 1943, term proposed by Bloor.
- Greek word “lipos” meaning fat.
- Organic compounds insoluble in water.
- Soluble in non-polar solvents.
- Composed of carbon, hydrogen and oxygen.
- Found in both plants and animals.
- Present in fruits, nuts and oils.

# Constituents

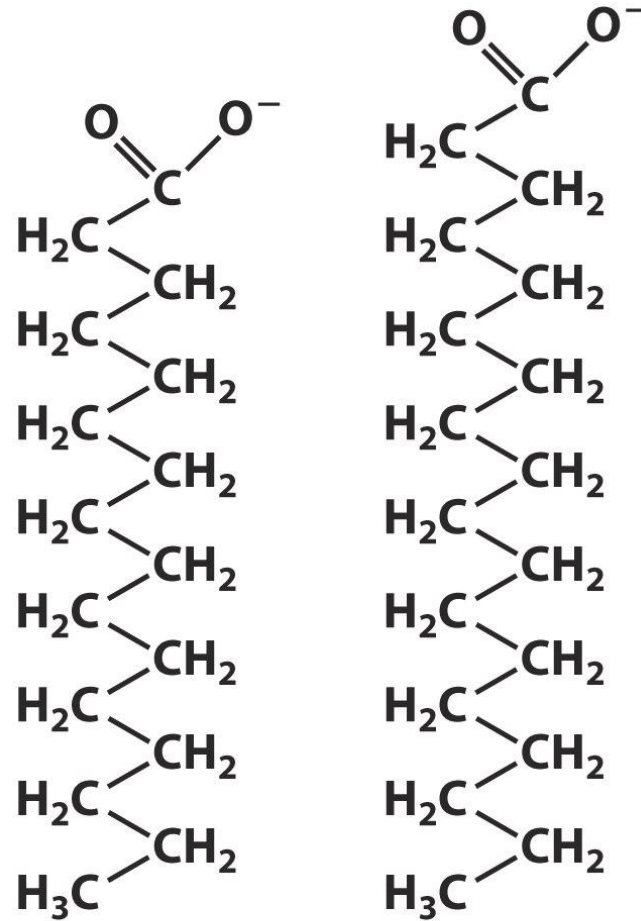
- Fatty acids and alcohol



## Saturated fatty acids

- Single bonds.
- Solids at room temperature.
- High melting and boiling points.

# Saturated Fatty acids



**Palmitate**

**Stearate**

# Unsaturated fatty acids

- Single and double bonds.
- Liquids at room temperature.
- Low boiling point.

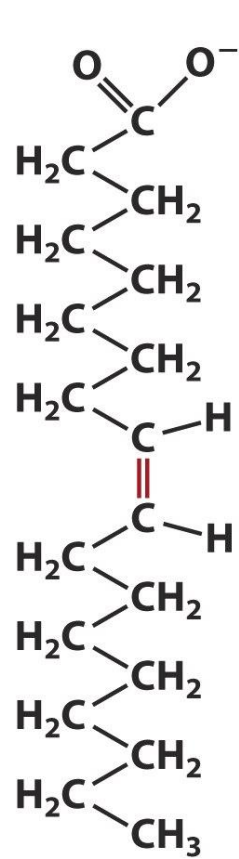
## **Monounsaturated fatty acids**

containing one double bond

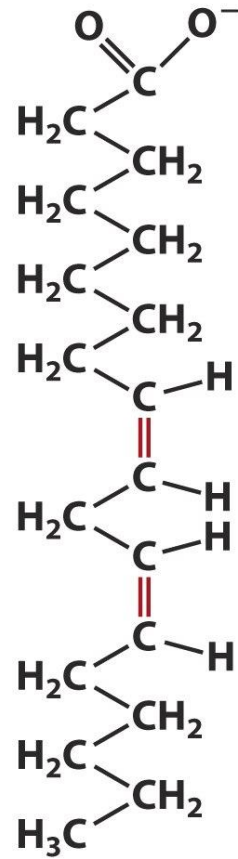
## **Polyunsaturated fatty acids**

- containing two or more double bonds.
- Double bonds are separated by at least by one methylene group.

# Unsaturated Fatty acids



Oleate



Linoleate



## TYPES OF FATTY ACIDS

(according to the number of double bonds)



**Saturated (No bond)**



**Monounsaturated (1 bond)**



**Polyunsaturated (>1 bond)**

# Properties of lipids

- ✓ Concentrated source of energy.
- ✓ Serves as a cushion for vital organs.
- ✓ Structural elements of biomembranes.
- ✓ Reserviors of fat soluble vitamins.
- ✓ Serves as binding agents in food preprations.
- ✓ Serves as thermal insultors around certain organs.
- ✓ Provide shape and contour to the body.
- ✓ Act as metabolic regulators.
- ✓ Helps in cell cell interaction and signal transduction.
- ✓ Colouration of flowers.

# Classification of lipids

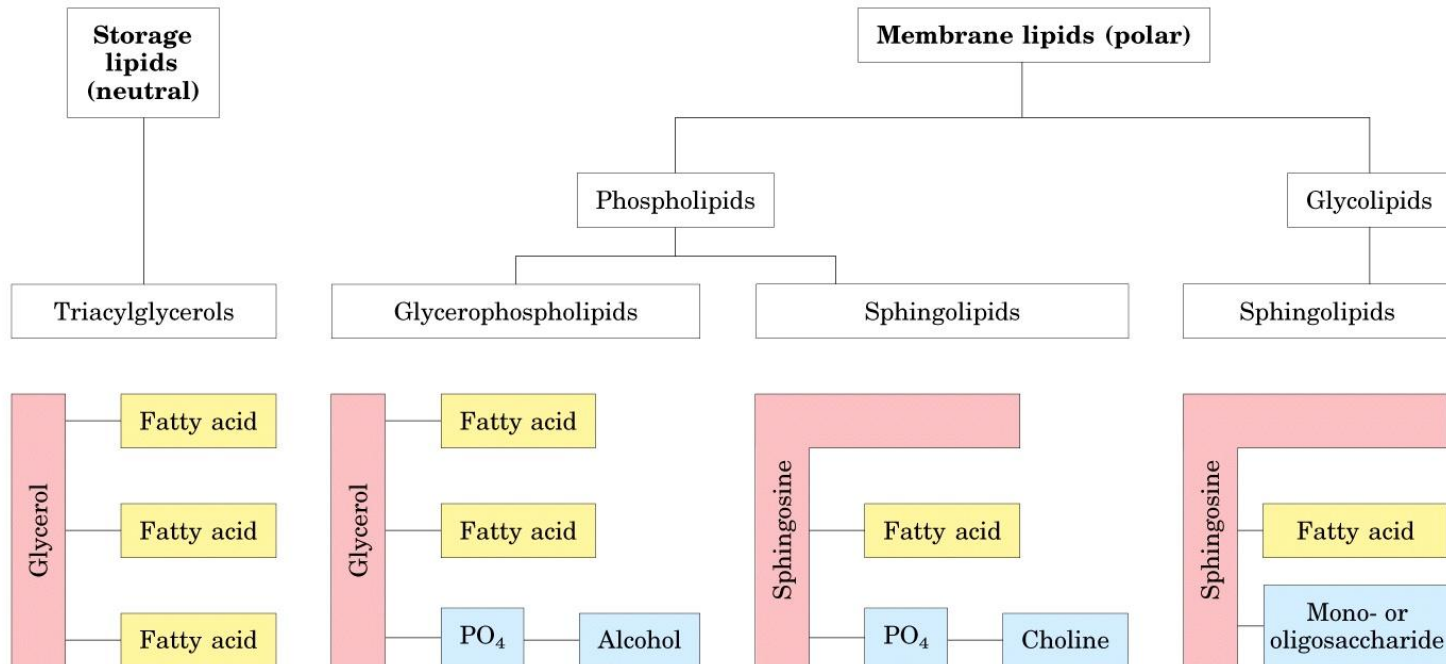
## Simple lipids;

- Esters of fatty acids and alcohol.
- Esterification of fatty acids with the alcohol results in the formation of ester bond.

## complex lipids;

esters of fatty acids containing groups in addition to an alcohol and a fatty acid.

# Types of lipids



# Storage lipids

## Triacylglycerol;

- basic foundation molecule – trihydroxyl compound-**Glycerol**
- Each hydroxyl group is linked to a fatty acid by esterification.

### **Simple triacylglycerol**

- If all the OH groups are esterified to same fatty acids.

### **Mixed triacylglycerol**

- if different fatty acids are esterified.

# Properties of triacylglycerol

- Colourless, odourless and tasteless
- Specific gravity is less than 1.0
- Have two primary biological roles-
  - energy metabolism (adipocytes in animals and cytoplasm in plants) and
  - temperature insulation.
- Act as electrical insulators allowing rapid propagation of depolarized waves along myelinated nerves.

# Membrane lipids

- Amphiphilic in nature
- Found exclusively in membranes.

Two types

Glycerophospholipids and sphingolipids

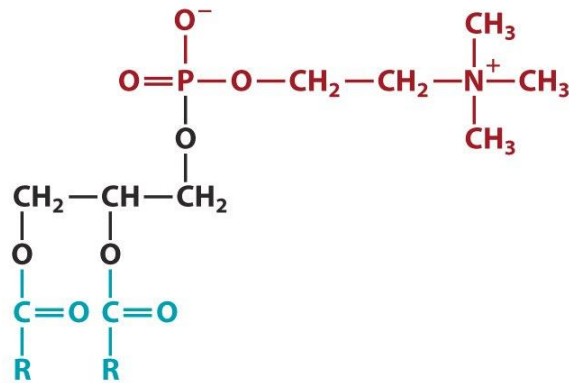
## Glycerophospholipids ;

- Foundation molecule is phosphatidic acid or 1,2 diacylglycerol 3- phosphate.
- Both saturated and unsaturated fatty acids are present.
- 3<sup>rd</sup> hydroxyl group of glycerol is esterified by phosphoric acid.
- Another alcohol can be esterified with the phosphate group.

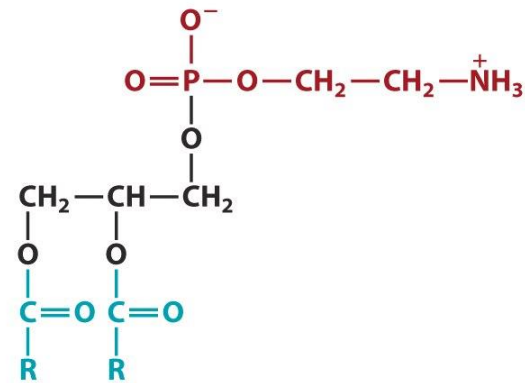
- Four major types of glycerophospholipids are;
  - ✓ Phosphatidylethanolamines
  - ✓ Phosphatidylcholines
  - ✓ Phosphatidylserines
  - ✓ Phosphatidylinositols



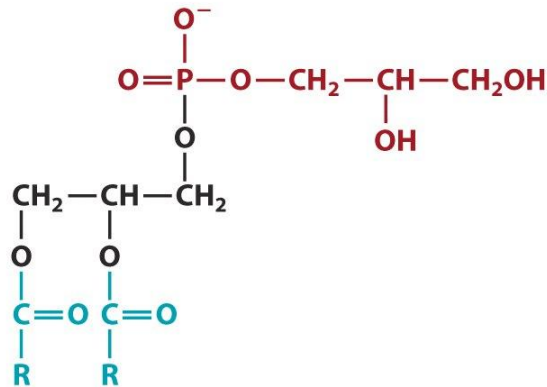
# Glycerophospholipids



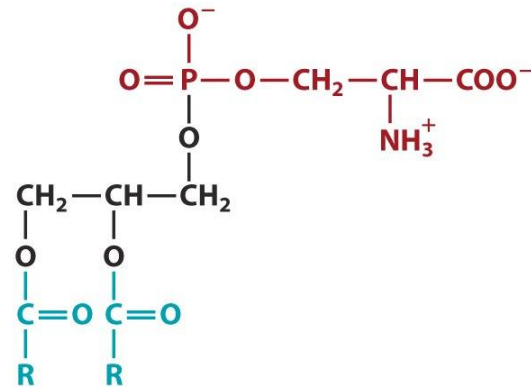
Phosphatidylcholine



Phosphatidylethanolamine



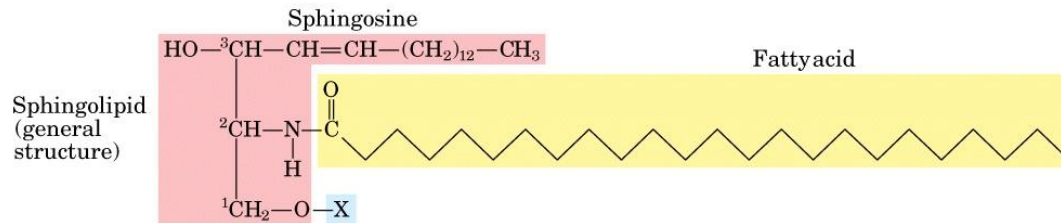
Phosphatidylglycerol

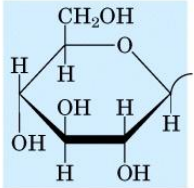
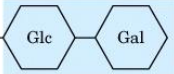
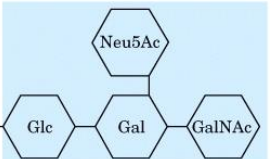


Phosphatidylserine

# Sphingolipids

- Foundation molecule is sphingosine
- Sphingosine has two functional groups (amino and hydroxyl) that can be chemically modified to make sphingolipids.
- Four major types of sphingolipids are;
  - Ceramides
  - Sphingomyelins
  - Cerebrosides
  - Gangliosides



Name of sphingolipid	Name of X	Formula of X
Ceramide	—	— H
Sphingomyelin	Phosphocholine	$\begin{array}{c} \text{O} \\ \parallel \\ \text{—P—O—CH}_2\text{—CH}_2\text{—N}^+(\text{CH}_3)_3 \\   \\ \text{O}^- \end{array}$
Neutral glycolipids Glucosylcerebroside	Glucose	
Lactosylceramide (a globoside)	Di-, tri-, or tetrasaccharide	
Ganglioside GM2	Complex oligosaccharide	

# Polar lipids and membranes

- unable to assemble into micelles.
- They form bilayers composed of two monolayers or sheets of polar lipids.
- Non polar side of each sheet combines by hydrophobic interactions to exclude water in the central region of the bilayer.

# Steroids

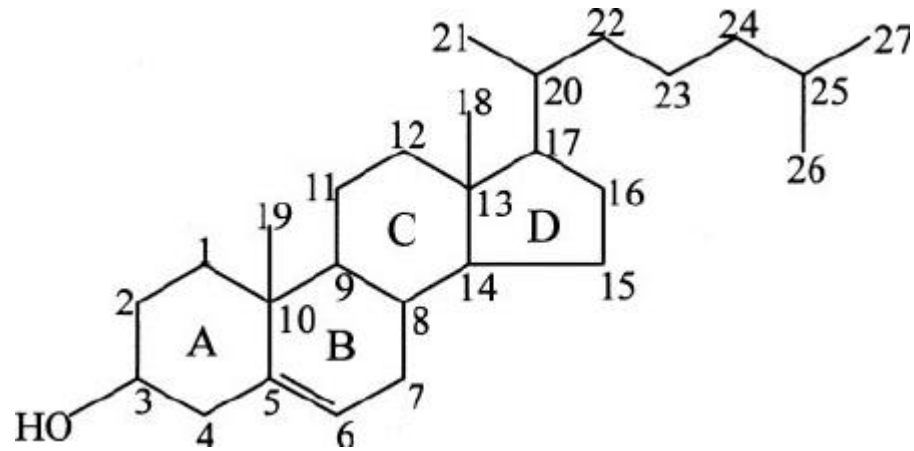
- Have the characteristic fused ring system of three six membered rings labeled as A,B and C and one five membered ring called the D ring.
- Steroids containing one or more OH groups are known as sterols.

## Cholesterol

- ✓ has a hydroxyl group on the A ring, a double bond in ring B, and hydrocarbon chains attached at several locations.
- ✓ amphiphilic in nature having a polar head and an extensive non polar region.
- ✓ Chemically reactive portion of cholesterol is the hydroxyl group.
- ✓ Derived from 5 carbon compound-isoprene.

- ✓ Has 27 carbon atoms, an OH group, a double bond, two methyl groups at C10 and C13 and a side chain at C17.
- ✓ Precursor of various compounds such as vitamin D3, bile acids and adrenocortical and sex hormones.
- ✓ Distributed widely in all cells of the body but mainly in nervous tissue.
- ✓ Poor conductor of heat and hence acts as insulator.
- ✓ Excess is harmful to body.
- ✓ Enzyme catalysed oxidation reactions on the cholesterol fused ring system leads to production of bile acids.

# Structure of cholesterol



# Phytosterols

- Also derived from isoprenes.
- Essential constituents in plant membrane structure.
- three major phytosterols are
  - ✓ Stigmasterol,
  - ✓ B-sitosterol and
  - ✓ campesterol.
- Differs from cholesterol in the placement of methyl groups and unsaturation of side chains.



# Terpenes

- also synthesised from isoprenes.
- Important terpenes are
  - ✓ Limonene – responsible for distant odour in citrus fruits.
  - ✓ B-carotene – the source of orange colour in carrot
  - ✓ Gibberellic acid – plant growth hormone
  - ✓ Squalene- acts as a precursor for synthesis of all plant and animal sterols
  - ✓ Lycopene – the source of red pigment in tomatoes.

# Eicosanoids

- act in the local environment.
- Initiate inflammatory response, pain and fever associated with injury and diseases.
- Promote blood clotting and regulate blood pressure.
- Control some of the reproductive functions.
- Regulate temperature and sleep wake cycle in animals.
- Promote smooth muscle contraction.
- Three major subclasses are
  - ✓ prostaglandins
  - ✓ thromboxanes

✓ leukotrienes

## Prostaglandins

- First isolated from prostate gland in animals.
- contain a five membered ring substituted with two side chains and functional groups including a carboxylic acid and hydroxyl groups, ketones and double bonds.

## Thromboxanes

- Isolated from thrombocytes
- characterized by six membered ring containing oxygen.
- participate in the formation of blood clots.

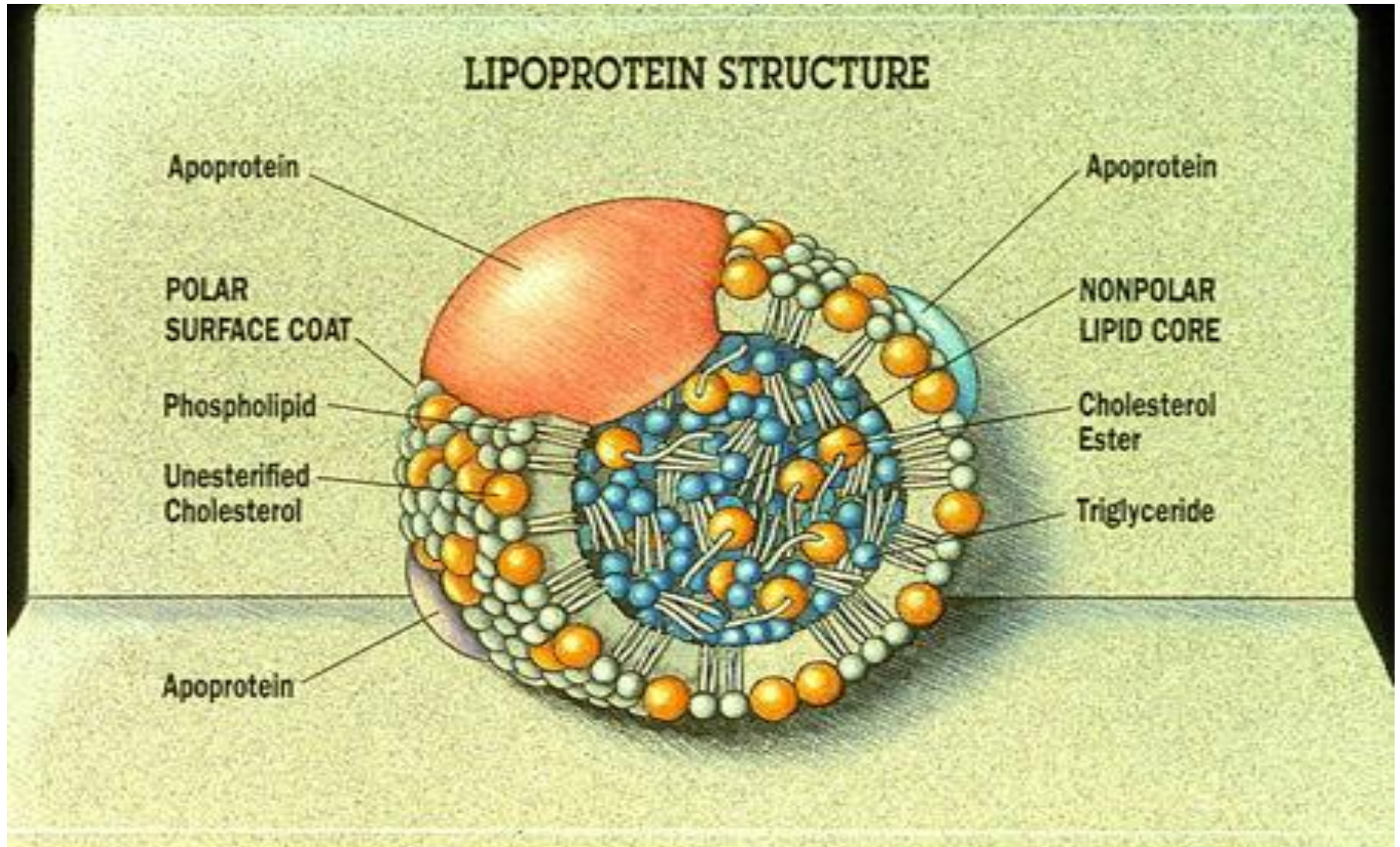
# Leukotrienes

- Isolated from leukocytes.
- Linear chain and the presence of three conjugated double bonds.
- Cause the contraction of smooth muscles.

## Lipoproteins

- serum particles consisting of specific proteins known as apolipoproteins and diverse combination of lipids.
- combination of lipids and proteins leads to the formation of water soluble complexes known as lipoproteins.
- Has a central core neutral, non polar lipid surrounded by a shell of phospholipids and proteins

# Lipoprotein Structure



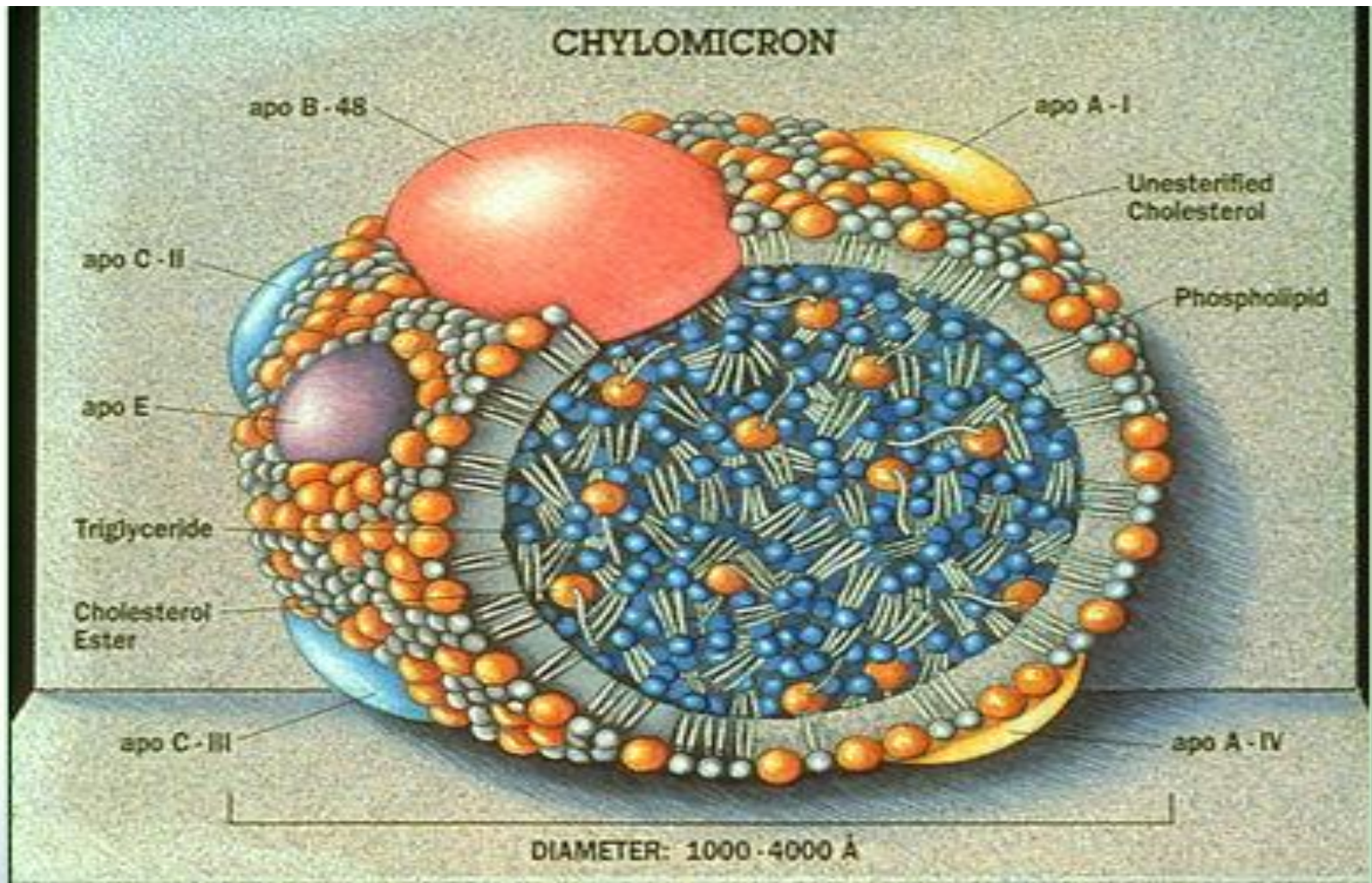
## Comparative chart of Lipoproteins

Lipoprotein class	Density (g/mL)	Diameter (nm)	Protein % of dry wt	Phospholipid %	Triacylglycerol % of dry wt
HDL	1.063-1.21	5 – 15	33	29	8
LDL	1.019 – 1.063	18 – 28	25	21	4
IDL	1.006-1.019	25 - 50	18	22	31
VLDL	0.95 – 1.006	30 - 80	10	18	50
chylomicrons	< 0.95	100 - 500	1 - 2	7	84

# Chylomicrons

- Has the least density.
- Consists of 98% to 99% of lipids content.
- Lipid content is primarily dietary triacylglycerides.
- They get assembled in the intestines and absorbed into the bloodstream, where from they are transported to peripheral tissues.
- The enzyme lipoprotein lipase releases the free fatty acids from triacylglycerides.
- The lipoprotein after loss of various triacylglycerols becomes remnant with very high amount of cholesterol.

# Chylomicron structure

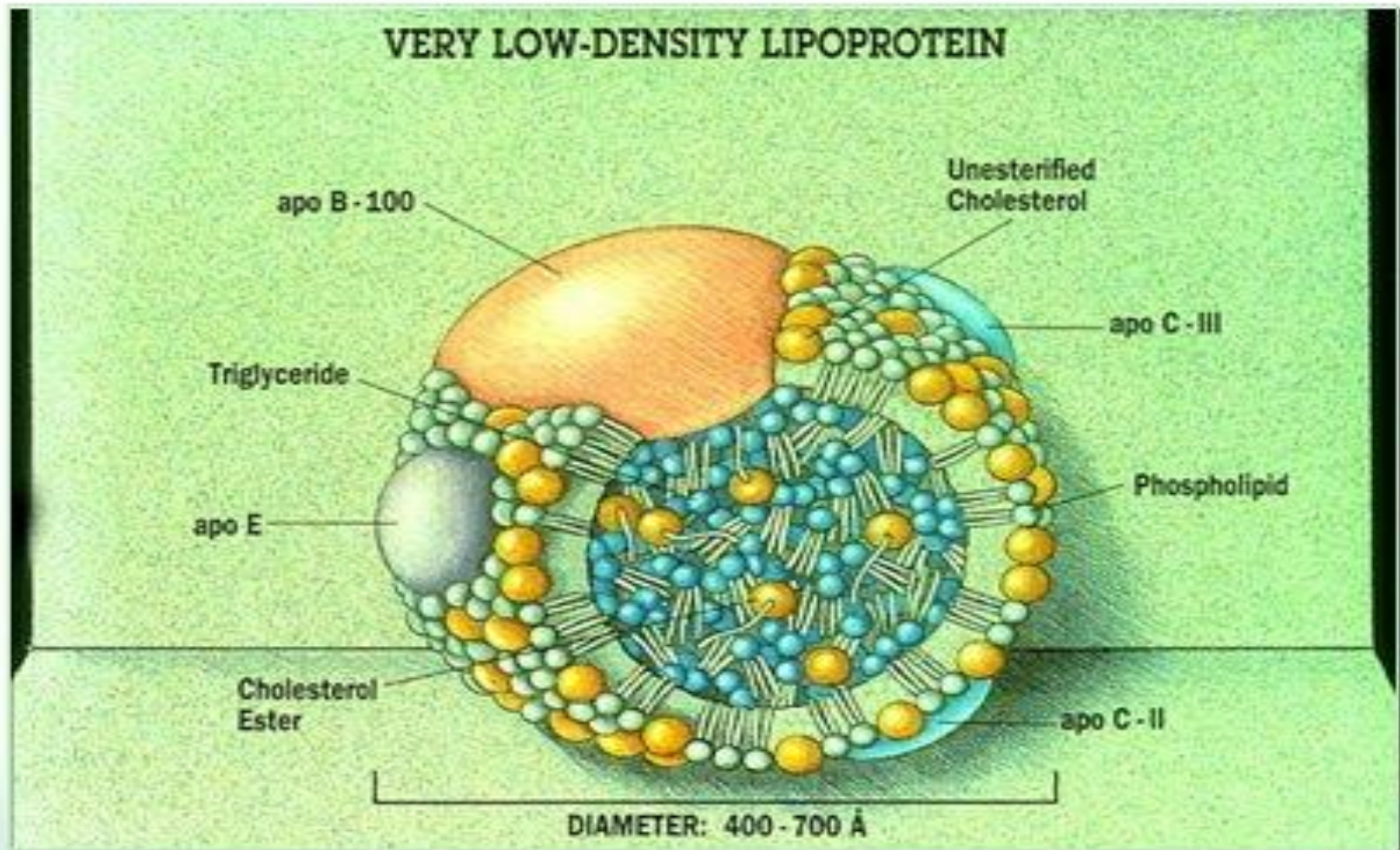




# Very low density lipoproteins (VLDL)

- ✓ Found in liver.
- ✓ Their function is to deliver synthesised lipids to the adipose and other peripheral tissues.
- ✓ Fatty acids are released in the same manner as in chylomicrons.

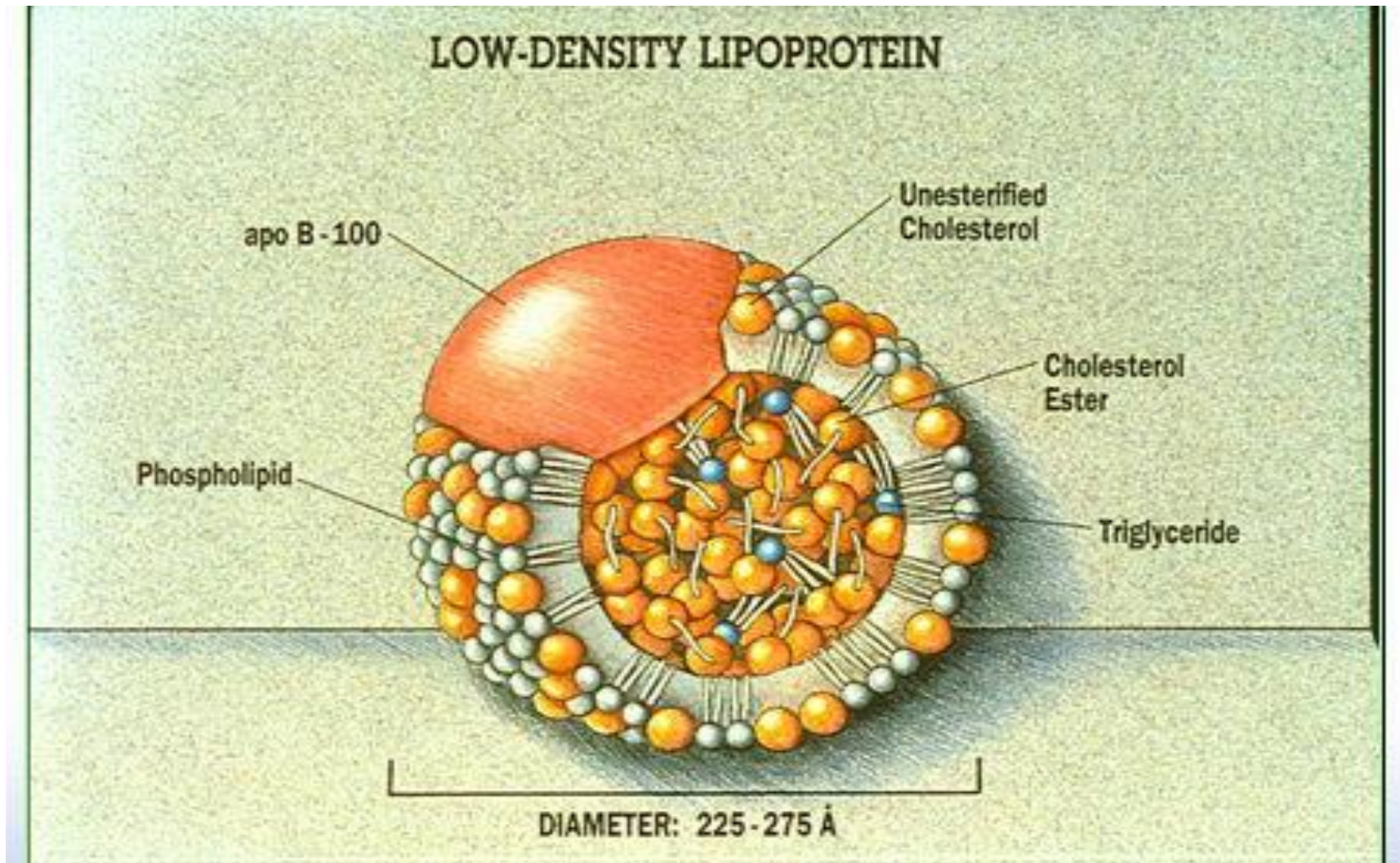
# Very low density lipoproteins (VLDL)



# Low density lipoproteins (LDL)

- ✓ Major carriers of cholesterol in the blood.
- ✓ Carry the cholesterol and cholesteryl esters from the liver to the adipose and other peripheral tissues.
- ✓ main lipids are cholesteryl esters containing polyunsaturated fatty acid linoleate.

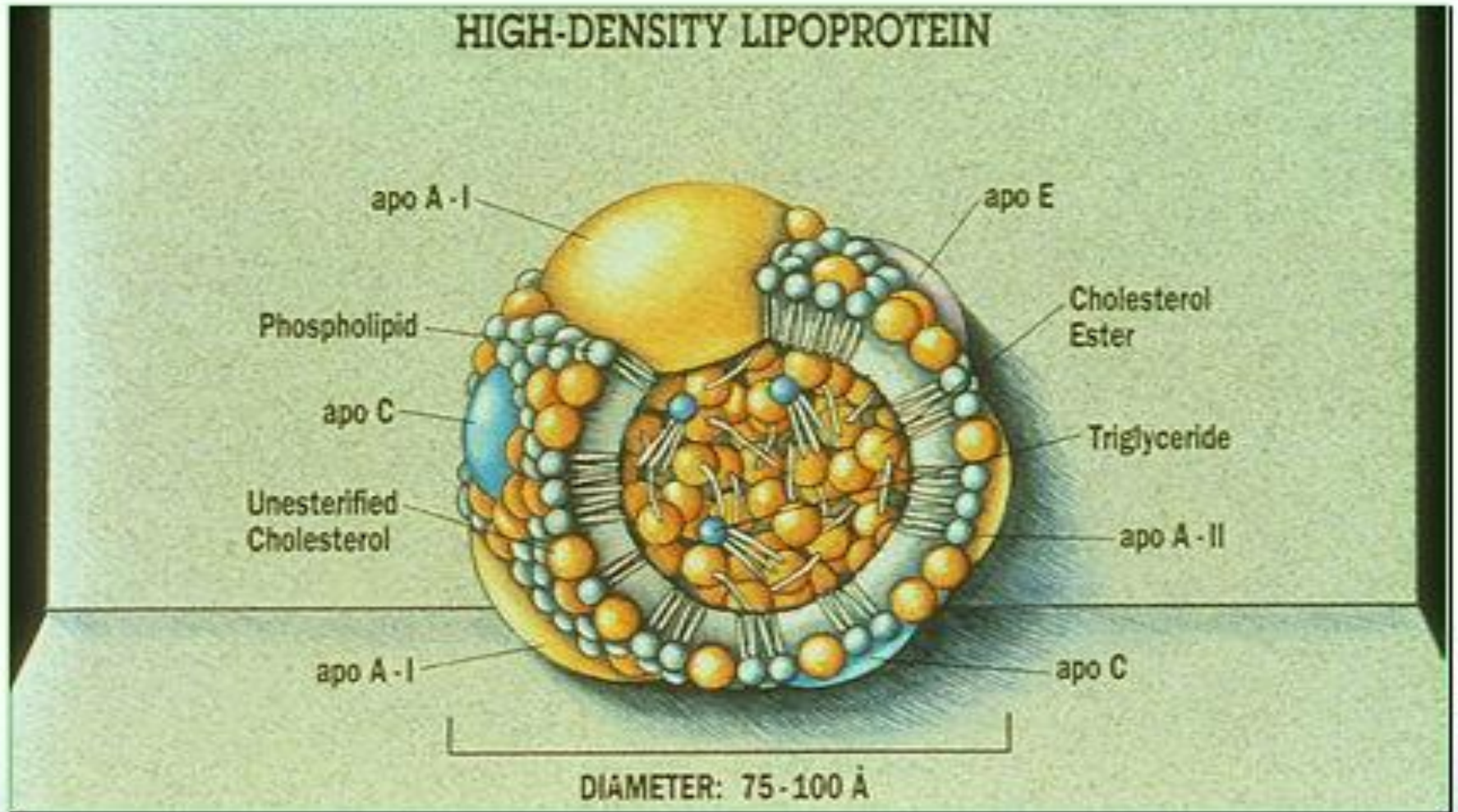
# Low density lipoproteins (LDL)



# High density lipoproteins (HDL)

- Have higher content of proteins and are therefore more dense.
- Transport the cholesterol from peripheral tissues to liver.
- This transport is known as reverse cholesterol transport.

# High density lipoproteins (HDL)



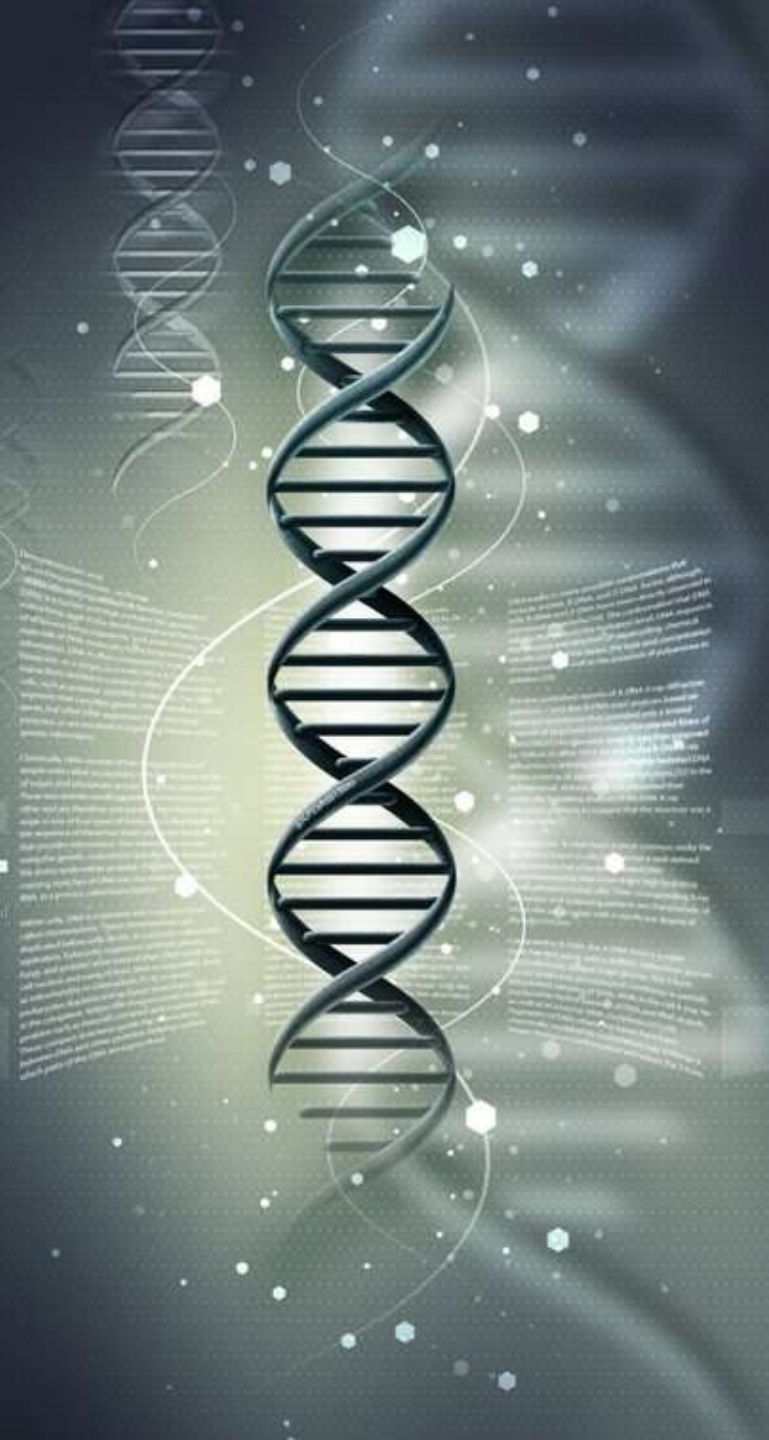
A 3D molecular model of DNA and RNA. The DNA is shown as a double helix with blue spheres representing the sugar-phosphate backbone and green and orange cylinders representing the nitrogenous base pairs. The RNA is shown as a single strand with a similar backbone and a different base pairing scheme. The model is set against a white background with a green border on the left and top edges.

# Structure Of DNA & RNA

By Himanshu Dev  
VMCC & SJH

# DNA

random|plains

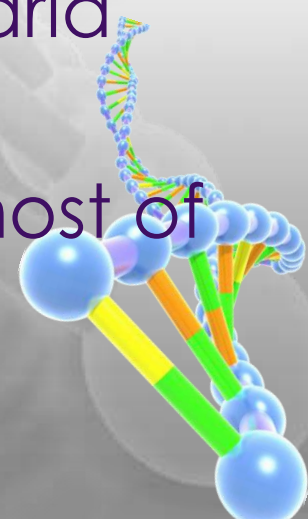






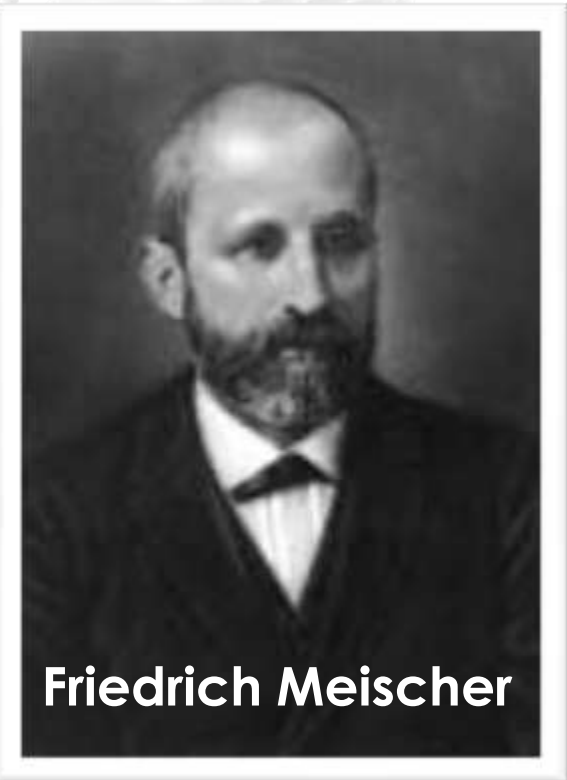
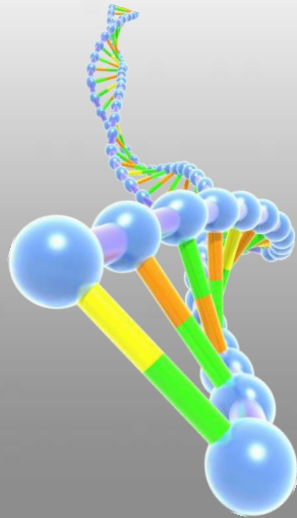
# DNA

- Deoxyribonucleic acid
- DNA - a polymer of deoxyribonucleotides.
- Usually double stranded.
- And have double-helix structure.
- found in chromosomes, mitochondria and chloroplasts.
- It acts as the genetic material in most of the organisms.
- Carries the genetic information



# A Few Key Events Led to the Discovery of the Structure of DNA

- DNA as an acidic substance present in nucleus was first identified by **Friedrich Meischer** in 1868.
- He named it as 'Nuclein'.



Friedrich Meischer

➤ In 1953, **James Watson and Francis Crick**, described a very simple but famous **Double Helix** model for the structure of DNA.



# FRANCIS CRICK AND JAMES WATSON



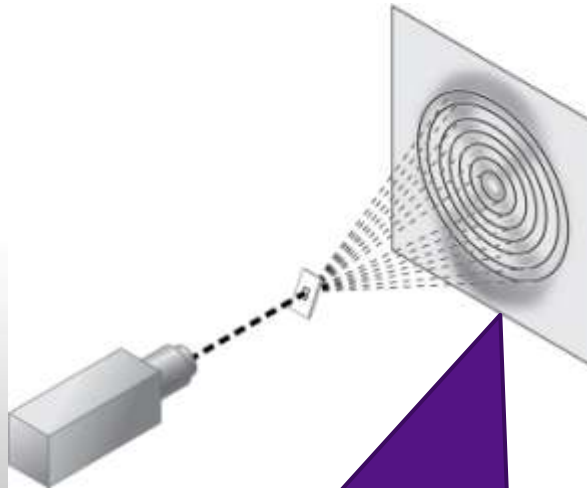
- The scientific framework for their breakthrough was provided by other scientists including
  - Linus Pauling
  - Rosalind Franklin and Maurice Wilkins
  - Erwin Chargaff



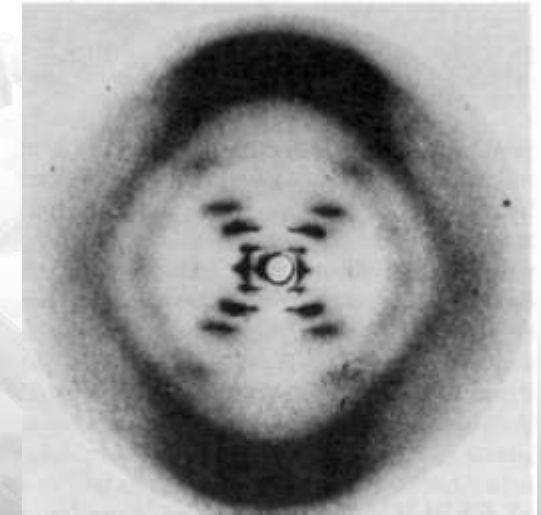
## ❖ Rosalind Franklin

- She worked in same laboratory as Maurice Wilkins.
- She study X-ray diffraction to study wet fibers of DNA.

X-ray diffraction  
of wet DNA fibers

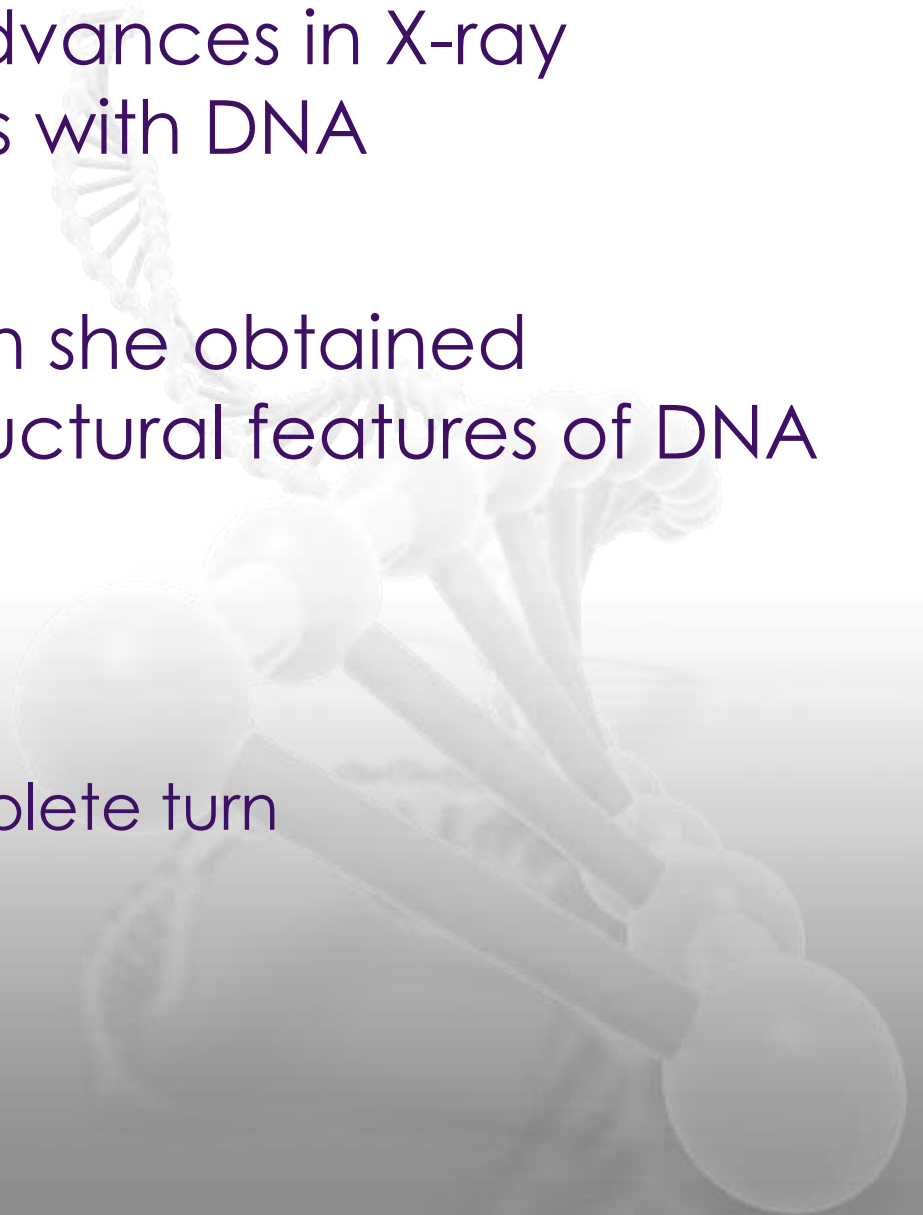


The diffraction pattern is interpreted (using mathematical theory) This can ultimately provide information concerning the structure of the molecule



X Ray  
Crystallography  
Rosalind  
Franklin's photo

- She made marked advances in X-ray diffraction techniques with DNA
- The diffraction pattern she obtained suggested several structural features of DNA
  - Helical
  - More than one strand
  - 10 base pairs per complete turn



Rosalind Franklin

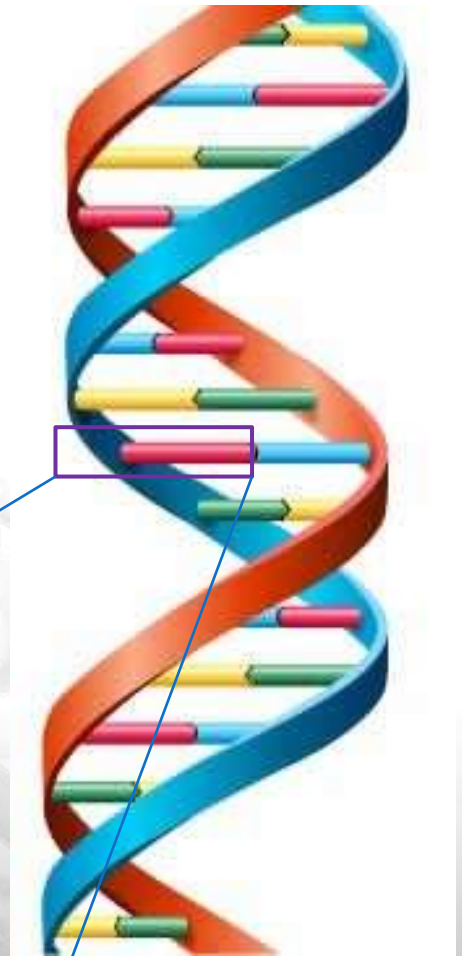
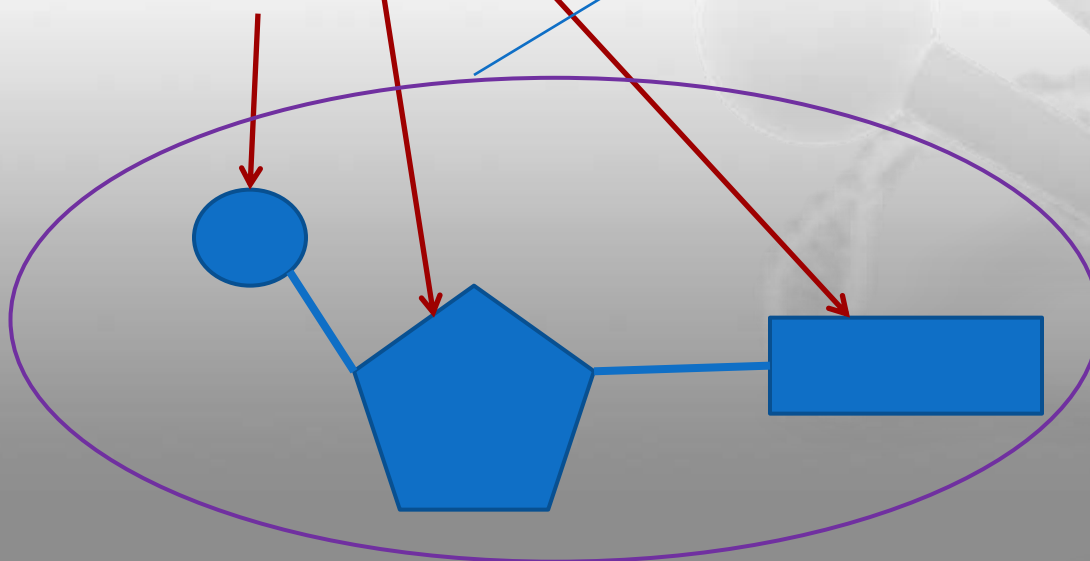


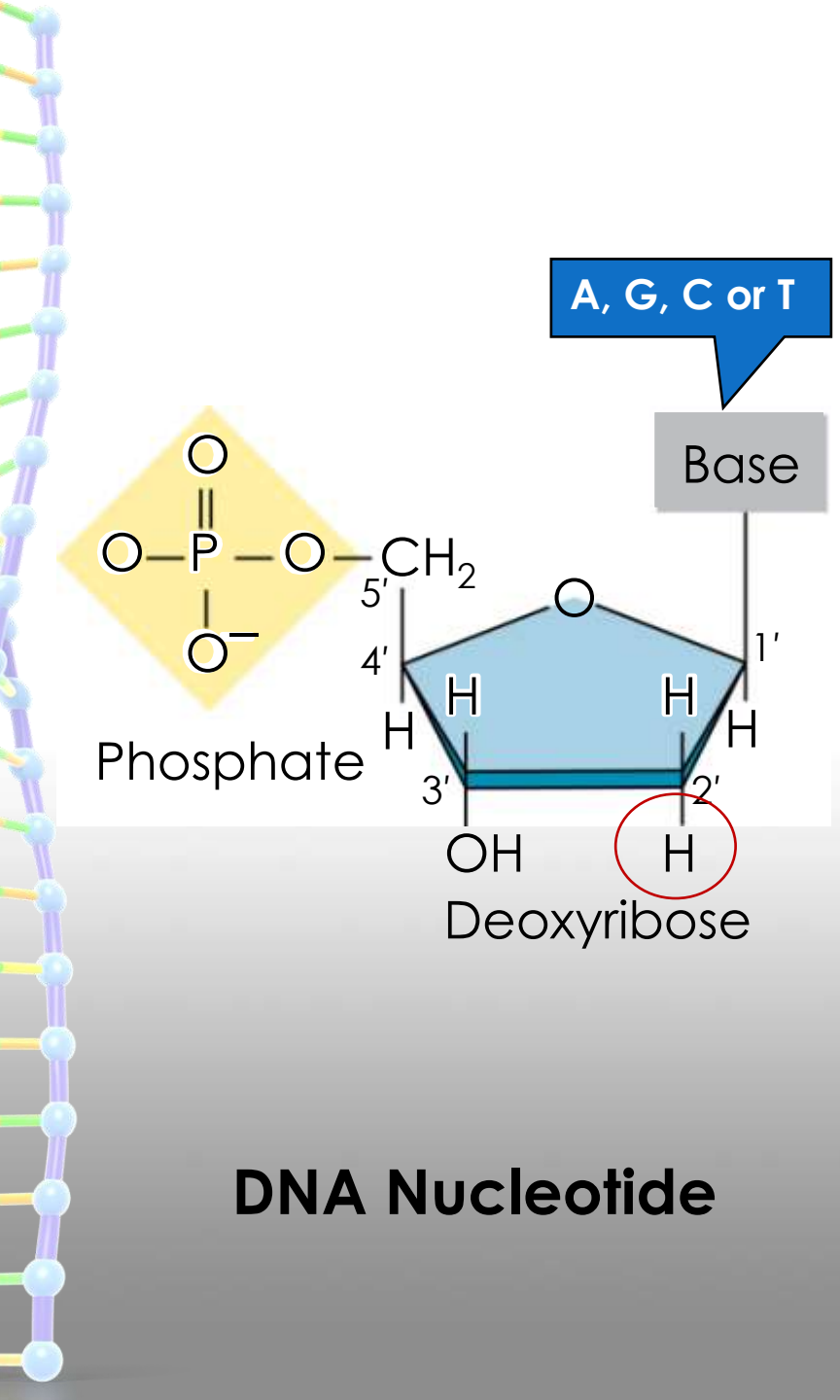
Maurice Wilkins



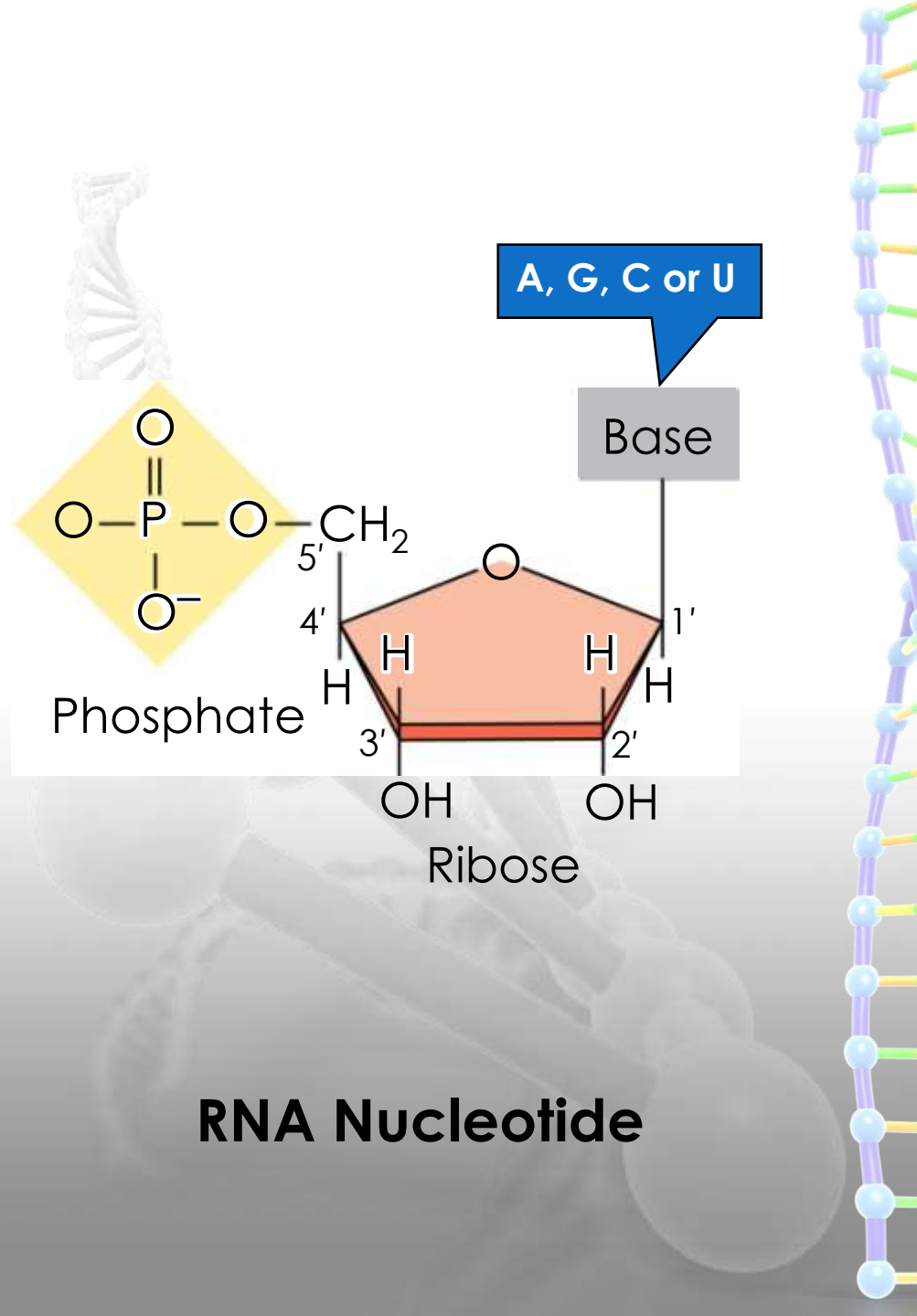
# ❖ DNA Structure

- DNA structure is often divided into four different levels primary, secondary, tertiary and quaternary.
- DNA has three main components
  - 1. Deoxyribose (a pentose sugar)
  - 2. Base (there are four different ones)
  - 3. Phosphate



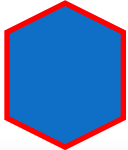
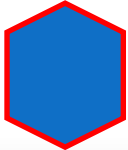
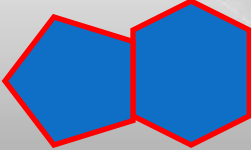
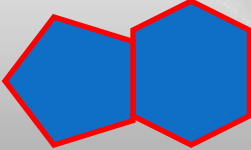


**DNA Nucleotide**

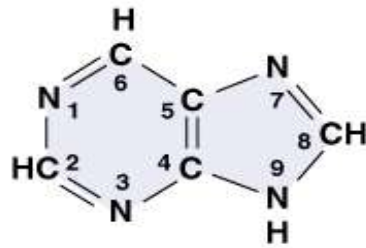


**RNA Nucleotide**

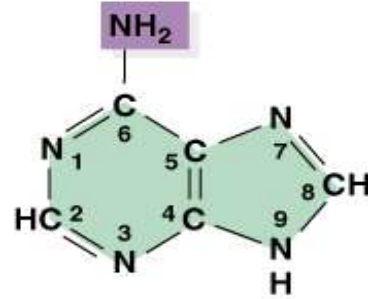
# ❖ The Nitrogenous Bases

- THEY ARE DIVIDED INTO TWO GROUPS
  - Pyrimidines and purines
- PYRIMIDINES (MADE OF ONE 6 MEMBER RING)
  - Thymine 
  - Cytosine 
- PURINES (MADE OF A 6 MEMBER RING, FUSED TO A 5 MEMBER RING)
  - Adenine 
  - Guanine 
- THE RINGS ARE NOT ONLY MADE OF CARBON

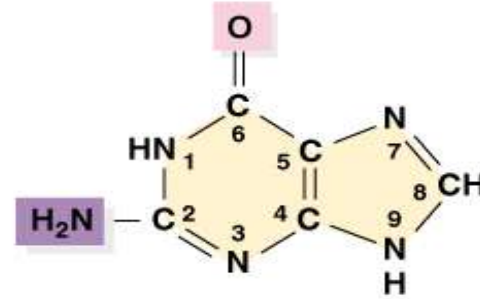
# ❖ Nitrogenous bases of DNA & RNA



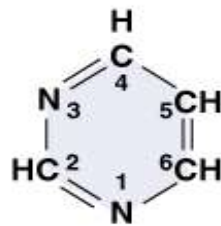
Purine  
(parent compound)



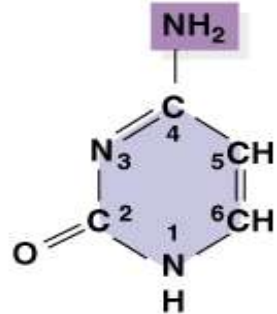
Adenine (A)



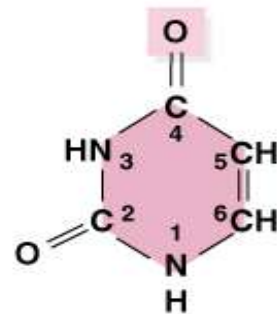
Guanine (G)



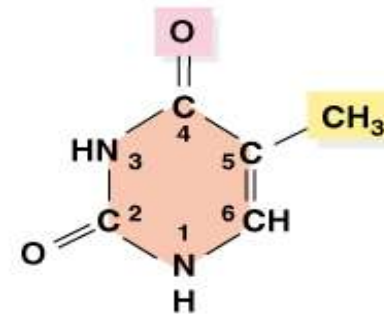
Pyrimidine  
(parent  
compound)



Cytosine (C)



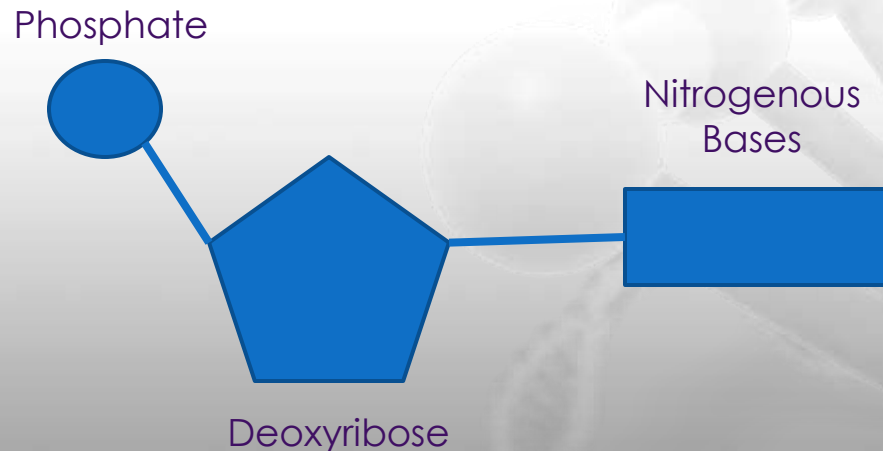
Uracil (U)  
(found in RNA)

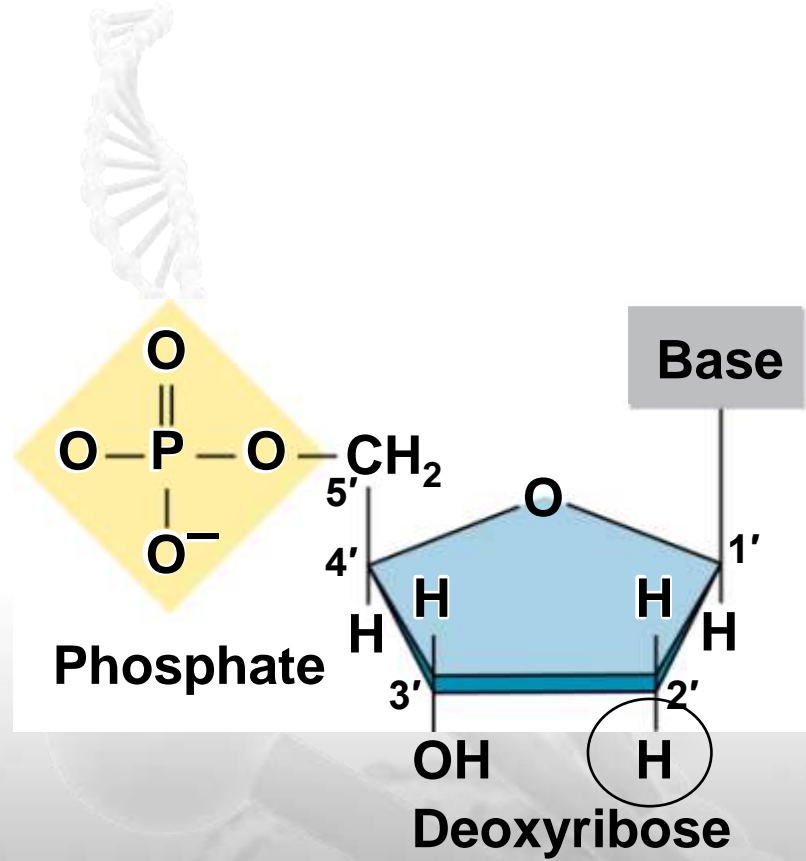
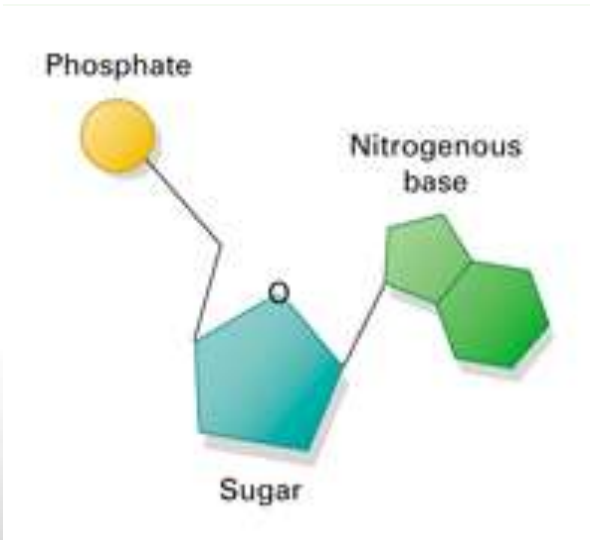


Thymine (T)  
(found in DNA)

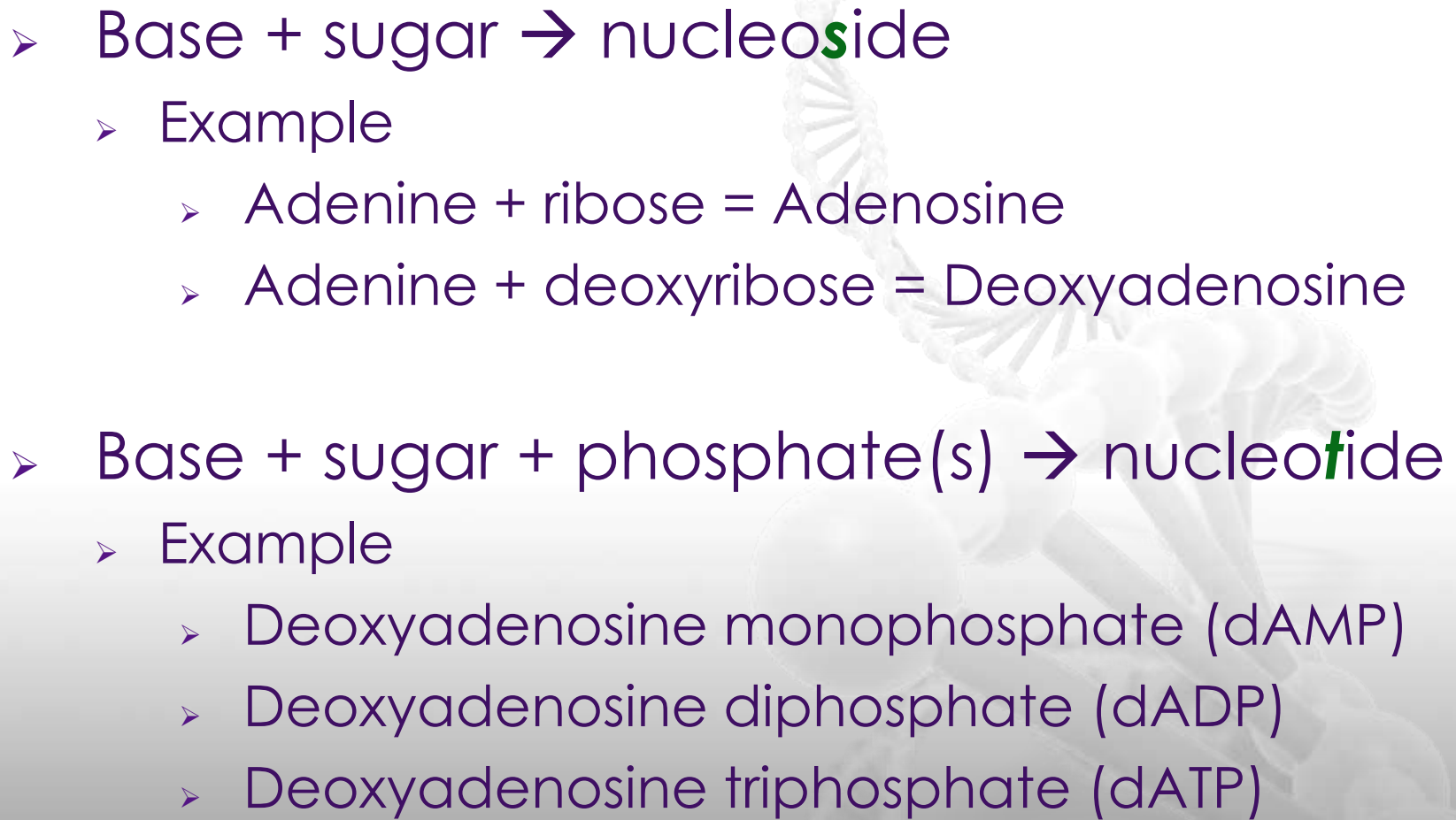
# ❖ Nucleotide Structure

- Nucleotides are formed by the condensation of a sugar, phosphate and one of the 4 bases
- The following illustration represents one nucleotide





DNA nucleotide

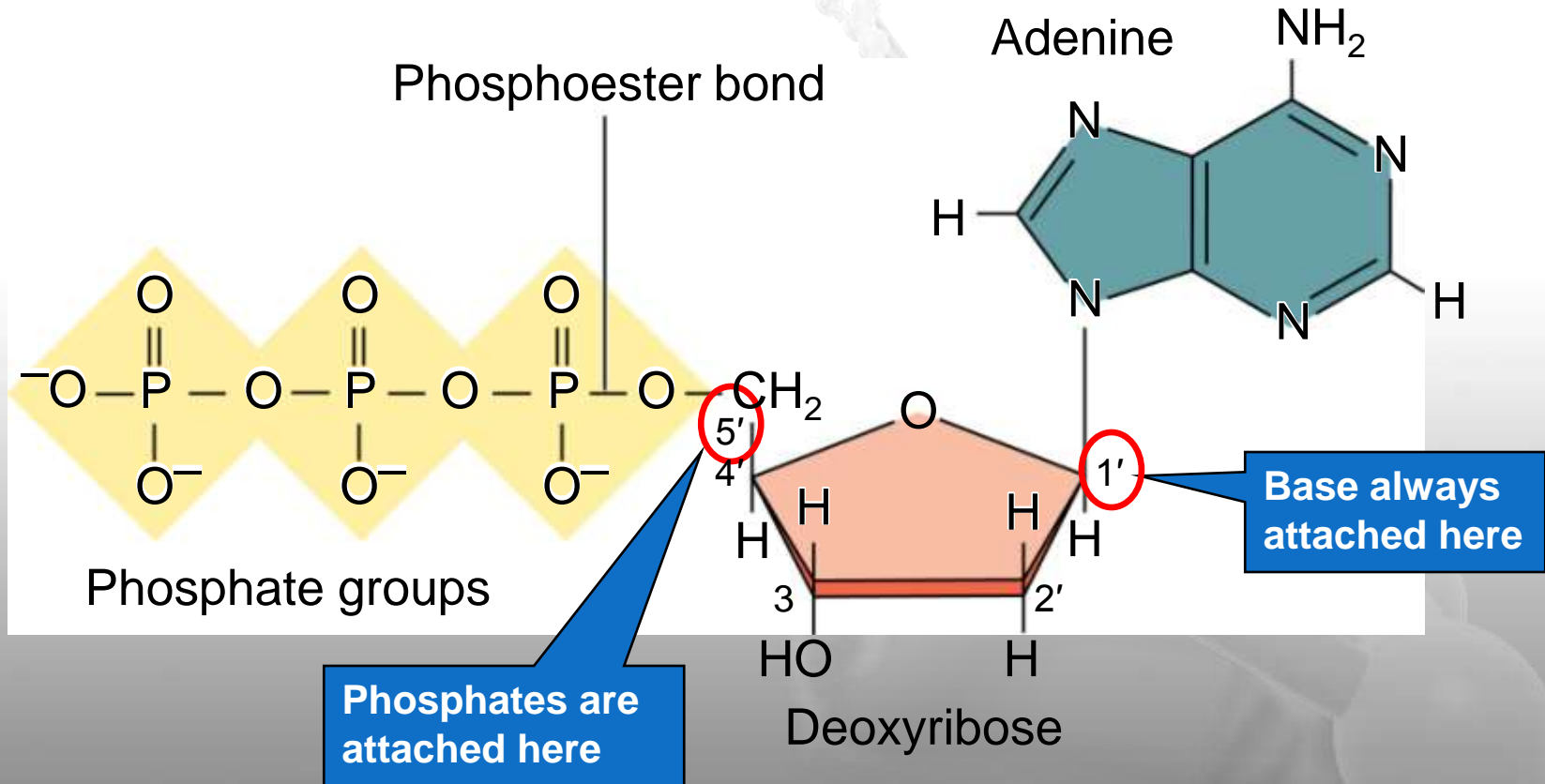
- 
- Base + sugar → nucleoside
    - Example
      - Adenine + ribose = Adenosine
      - Adenine + deoxyribose = Deoxyadenosine
  - Base + sugar + phosphate(s) → nucleotide
    - Example
      - Deoxyadenosine monophosphate (dAMP)
      - Deoxyadenosine diphosphate (dADP)
      - Deoxyadenosine triphosphate (dATP)

# Deoxyadenosine triphosphate

Doxyadenosine diphosphate

Deoxyadenosine monophosphate

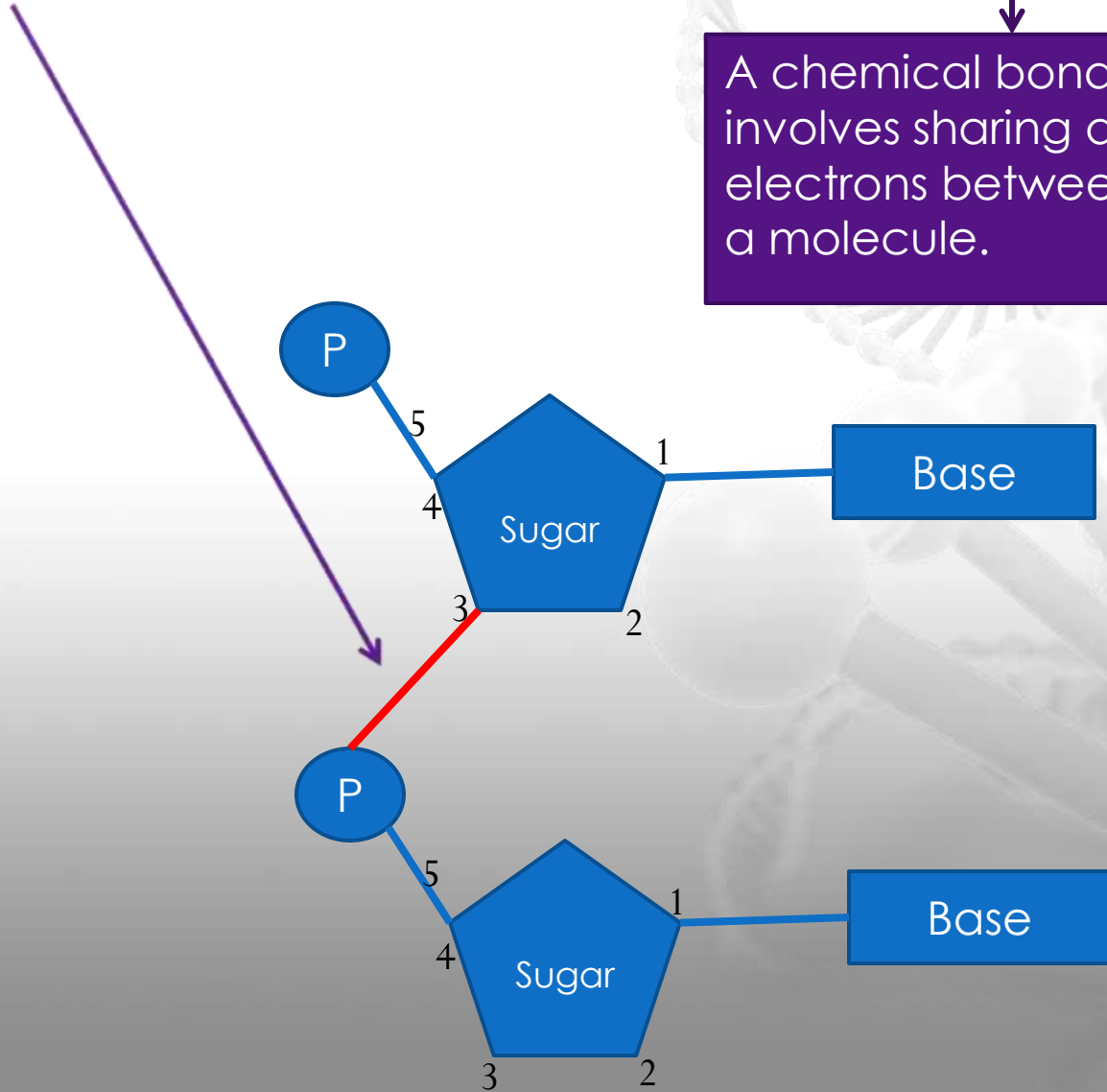
Deoxyadenosine

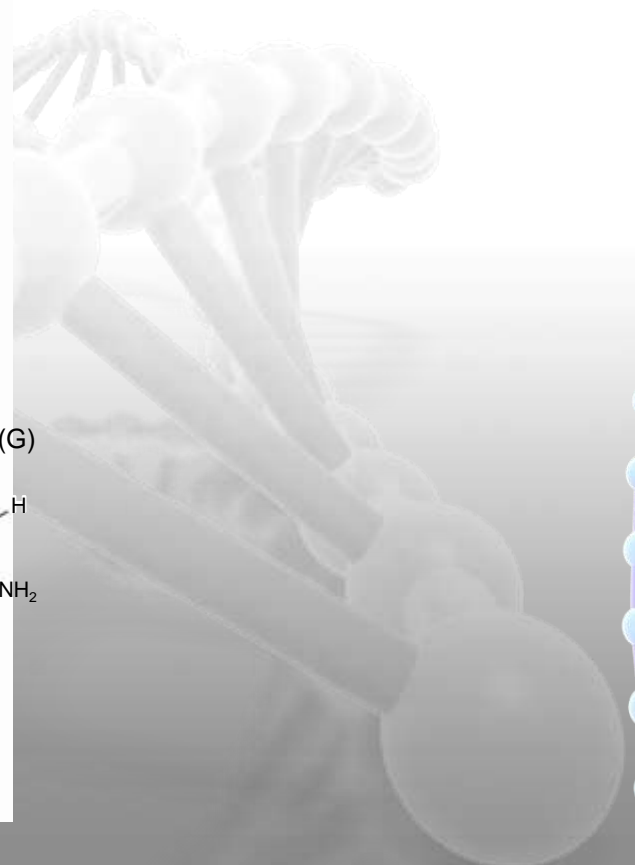
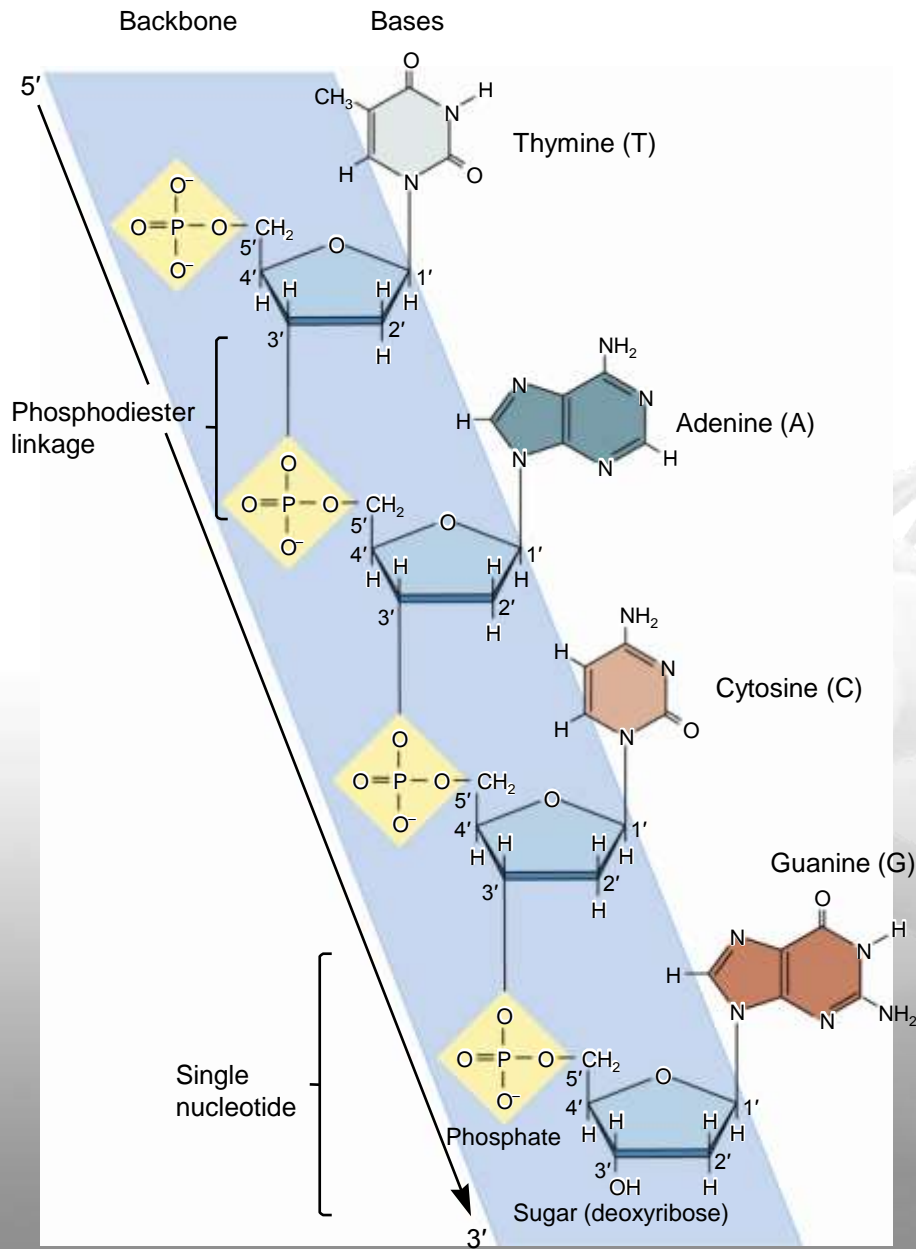




- Nucleotides are linked together by covalent bonds called phosphodiester linkage.

A chemical bond that involves sharing a pair of electrons between atoms in a molecule.

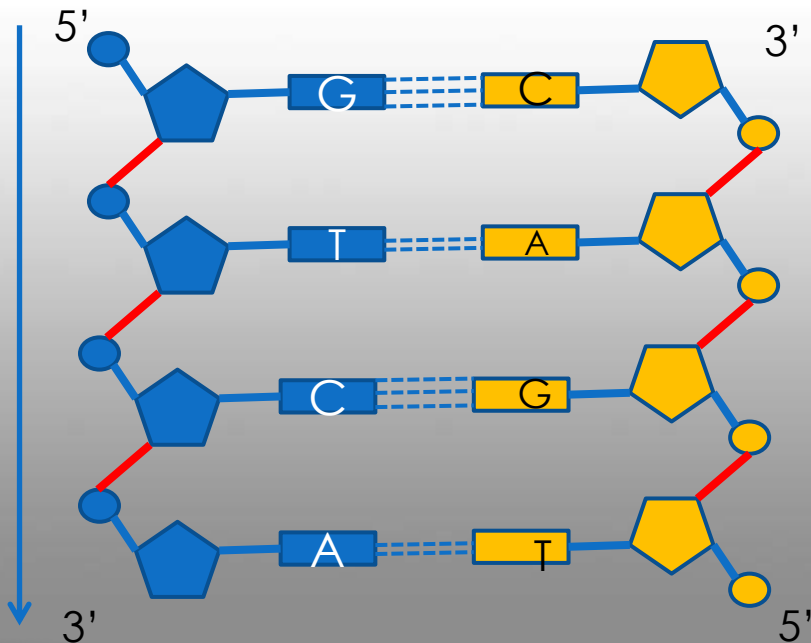


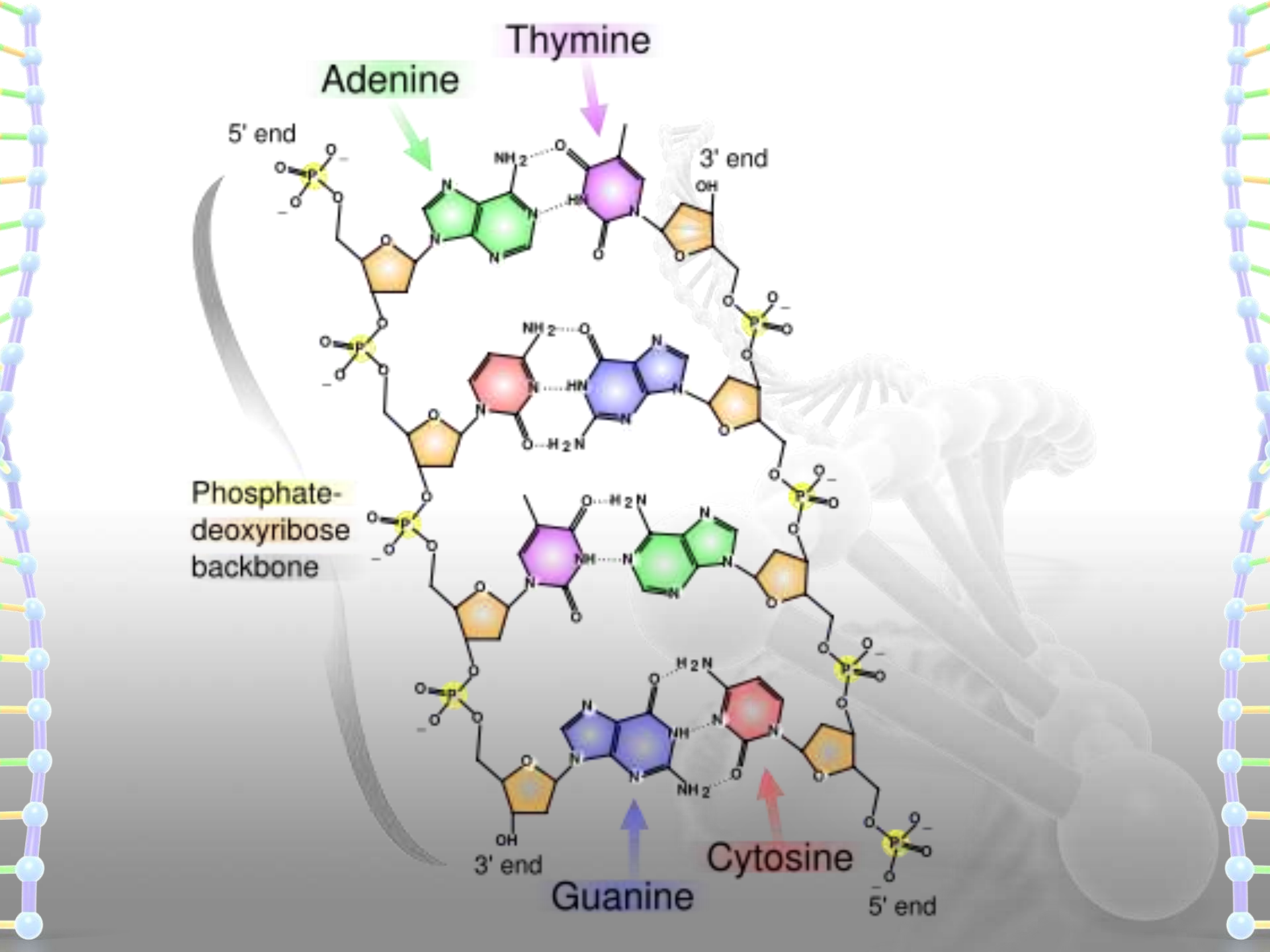


# ❖ DNA Double Helix & Hydrogen bonding

## Salient features of the Double-helix structure of DNA:

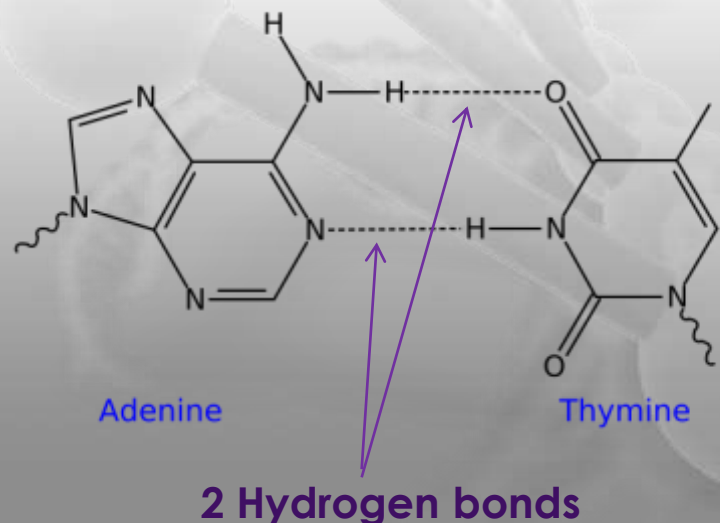
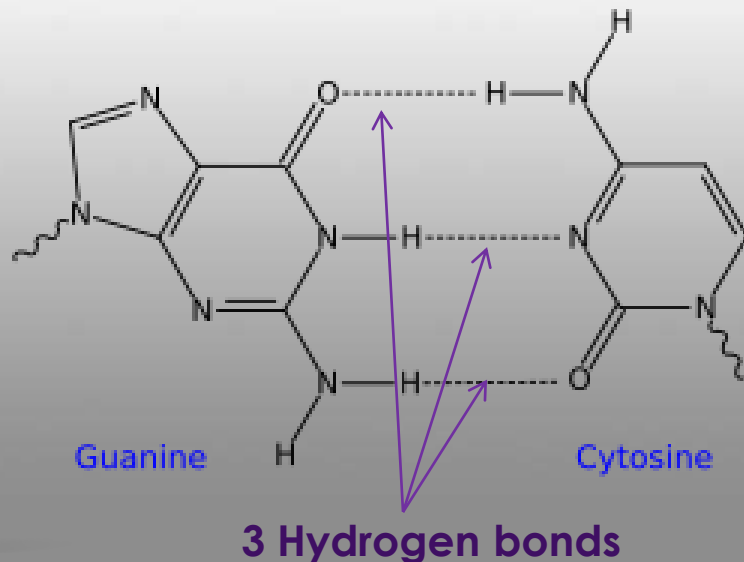
- It is made of two polynucleotide chains, where the backbone is constituted by sugar-phosphate, and the bases project inside.
- The two chains have anti-parallel polarity. It means, if one chain has the polarity  $5' \rightarrow 3'$ , the other has  $3' \rightarrow 5'$ .





# ❖ DNA Double Helix & Hydrogen bonding

- The bases in two strands are paired through hydrogen bond (H-bonds) forming base pairs (bp). **Adenine** forms **two** hydrogen bonds with **Thymine** from opposite strand and vice-versa. Similarly, **Guanine** is bonded with **Cytosine** with **three** H-bonds.
- Based on the observation of **Erwin Chargaff** that for a double stranded DNA, the ratios between **Adenine** and **Thymine**; and **Guanine** and **Cytosine** are constant and equals one.
- **Hydrogen bond**: -A chemical bond consisting of a hydrogen atom between two electronegative atoms (e.g., oxygen or nitrogen) with one side be a covalent bond and the other being an ionic bond.



# ❖ Erwin Chargaff's Experiment



- Chargaff pioneered many of biochemical technique for the isolation, purification and measurement of nucleic acids from living cells.
- It was known that DNA contained the four bases: A, G, C & T.
- Chargaff analyzed the base composition DNA isolated from many different species.

## ❖ THE HYPOTHESIS

- An analysis of the base composition of DNA in different species may reveal important features about structure of DNA.

1. For each type of cell, extract the chromosomal material. This can be done in a variety of ways, including the use of high salt, detergent, or mild alkali treatment. Note: The chromosomes contain both DNA and protein.

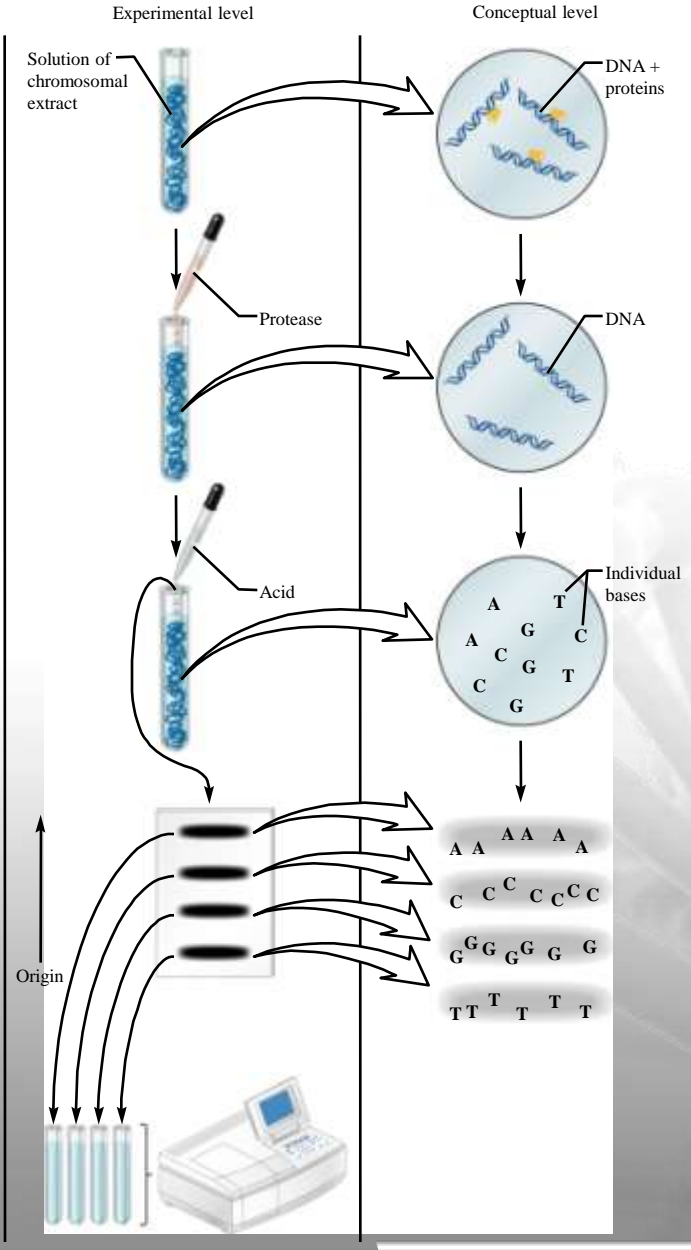
2. Remove the protein. This can be done in several ways, including treatment with protease.

3. Hydrolyze the DNA to release the bases from the DNA strands. A common way to do this is by strong acid treatment.

4. Separate the bases by chromatography. Paper chromatography provides an easy way to separate the four types of bases. (The technique of chromatography is described in the Appendix.)

5. Extract bands from paper into solutions and determine the amounts of each base by spectroscopy. Each base will absorb light at a particular wavelength. By examining the absorption profile of a sample of base, it is then possible to calculate the amount of the base. (Spectroscopy is described in the Appendix.)

6. Compare the base content in the DNA from different organisms.



# The Data



## THE DATA

### Base Content in the DNA from a Variety of Organisms\*

*Percentage of Bases (based on molarity)*

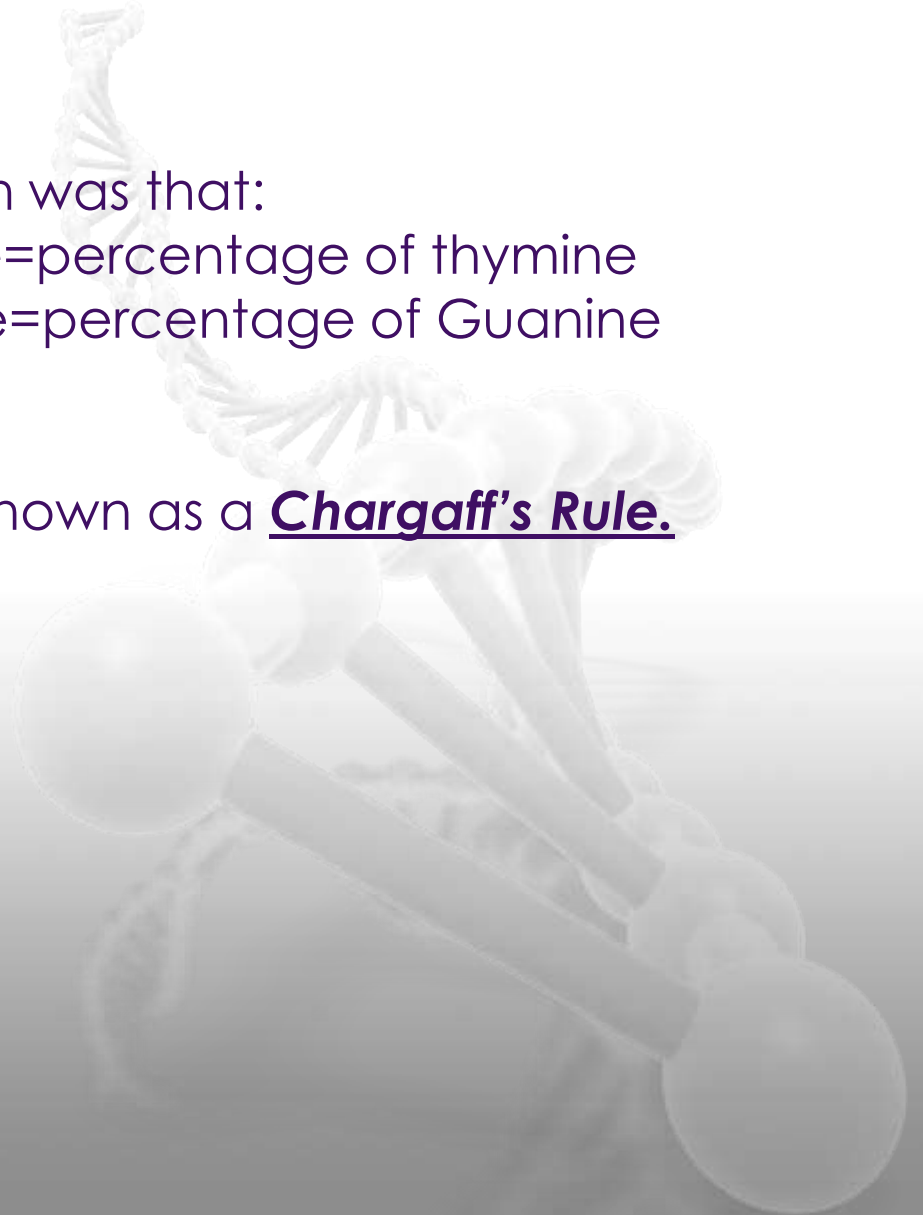
<i>Organism</i>	<i>Adenine</i>	<i>Thymine</i>	<i>Guanine</i>	<i>Cytosine</i>
<i>Escherichia coli</i>	26.0	23.9	24.9	25.2
<i>Streptococcus pneumoniae</i>	29.8	31.6	20.5	18.0
Yeast	31.7	32.6	18.3	17.4
Turtle red blood cells	28.7	27.9	22.0	21.3
Salmon sperm	29.7	29.1	20.8	20.4
Chicken red blood cells	28.0	28.4	22.0	21.6
Human liver cells	30.3	30.3	19.5	19.9

\*When the base compositions from different tissues within the same species were measured, similar results were obtained. These data were compiled from several sources. See E. Chargaff and J. Davidson, Eds. (1995) *The Nucleic Acids*. Academic Press, New York.

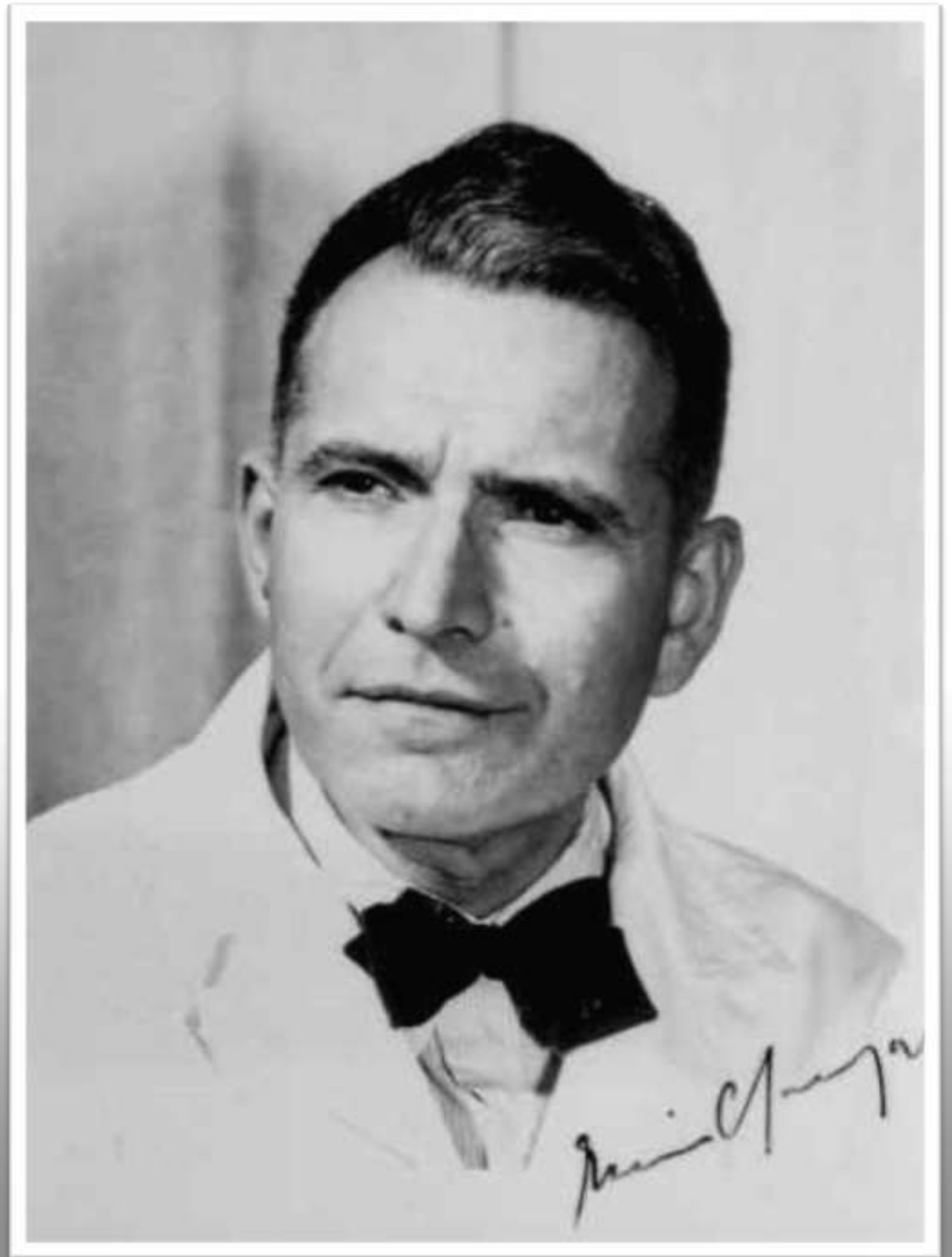


# Interpretation of Data

- The compelling observation was that:
  - ✓ Percentage of adenine=percentage of thymine
  - ✓ Percentage of Cytosine=percentage of Guanine
- This observation became known as a **Chargaff's Rule.**



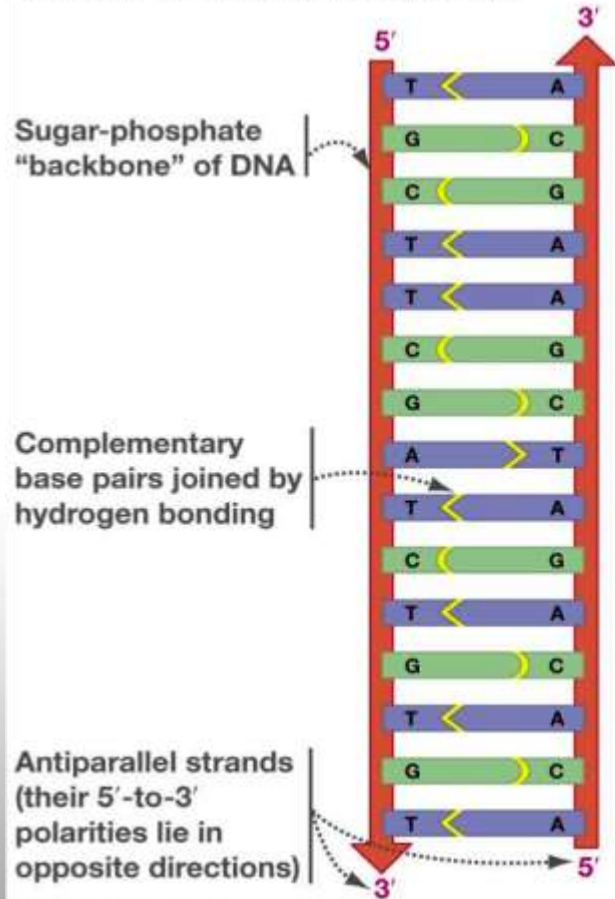
# Erwin Chargaff



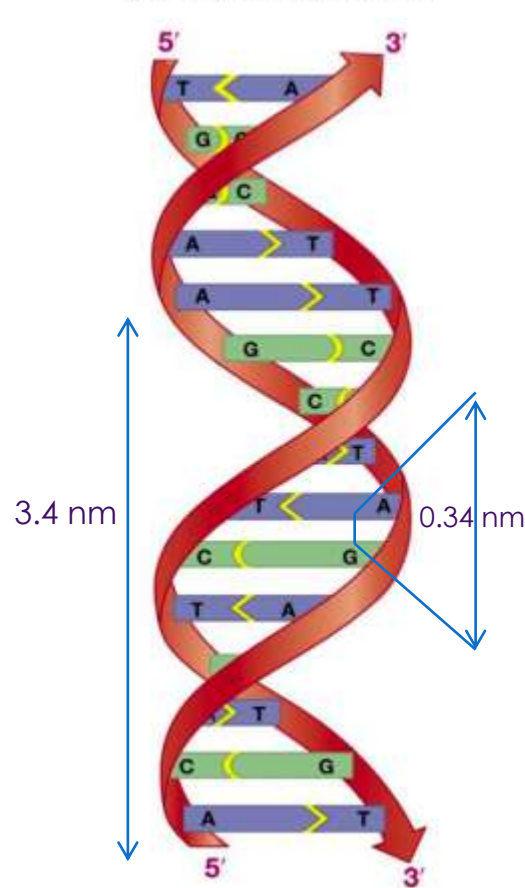
# ❖ DNA Double Helix & Hydrogen bonding

- The two strands are coiled in a ***right-handed fashion (Clockwise)***. The pitch of the helix is **3.4 nm** (a nanometer is one billionth of a meter, that is  $10^{-9}$  m) and there are roughly **10 bp** in each turn. Consequently, the distance between a bp in a helix is approximately equal to **0.34 nm**.
- The plane of one base pair stacks over the other in double helix. This, in addition to H-bonds, confers stability of the helical structure.

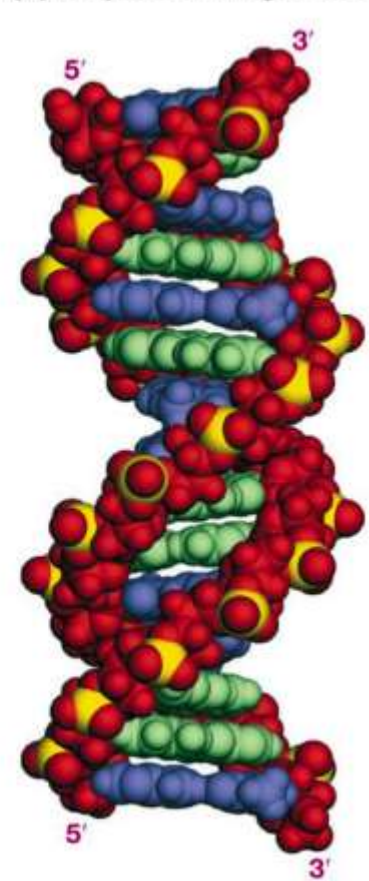
**(a) Complementary base pairing**



**(b) The double helix**



**(c) A space-filling model**

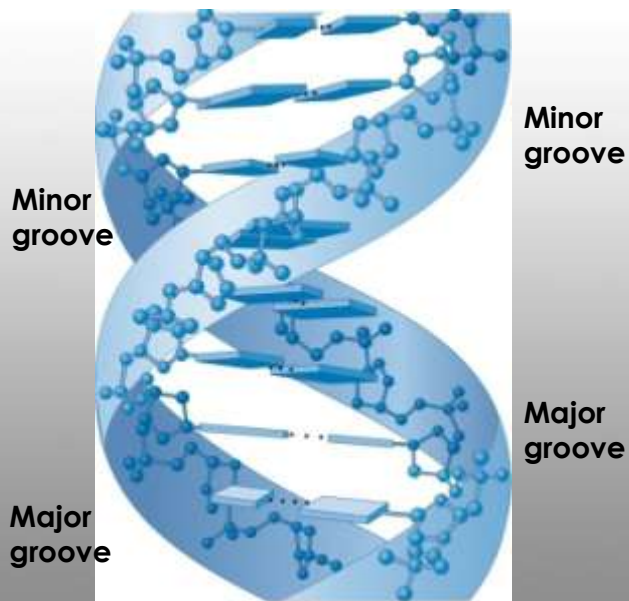


# ❖ DNA Double Helix & Hydrogen bonding

- There are two asymmetrical grooves on the outside of the helix:
  - a) Major groove
  - b) Minor groove

**Groove**:- any furrow (slight depression in the smoothness of a surface) or channel on a bodily structure or part.

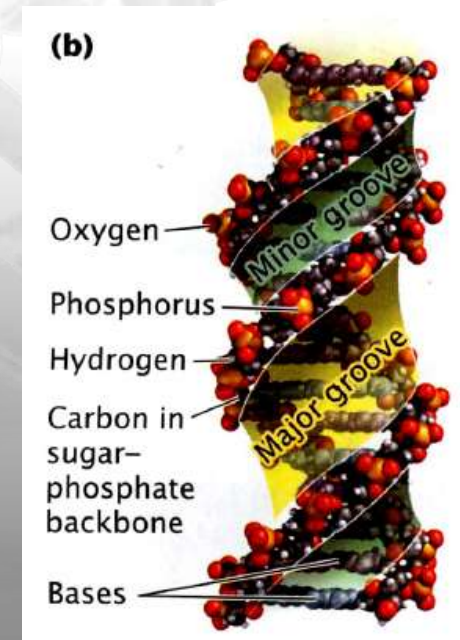
- ✓ Certain proteins can bind within these groove
  - ✓ They can thus interact with a particular sequence of bases.



(a) Ball-and-stick model of DNA



(b) Space-filling model of DNA



# ❖ Structure of Double-helix

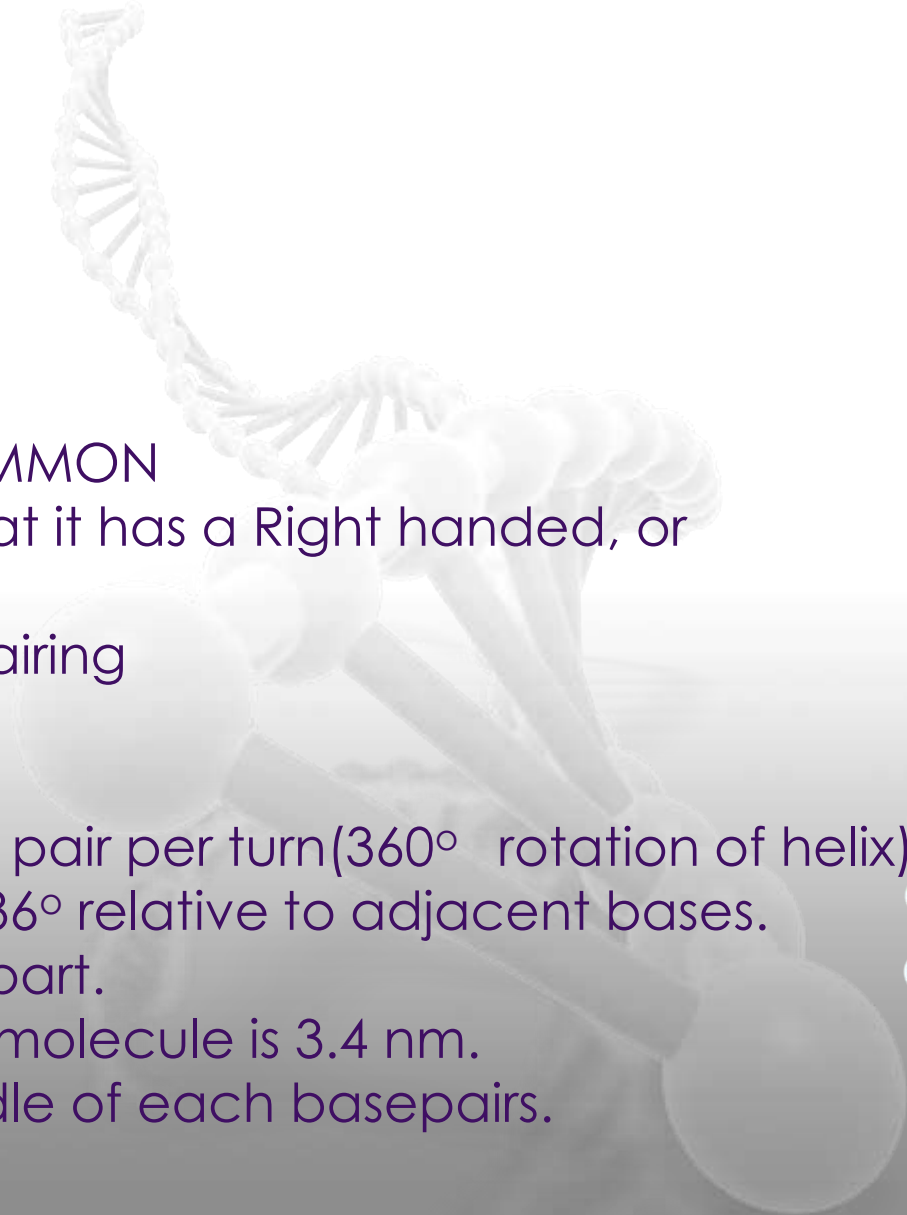
➤ Three major forms:

- ✓ B-DNA
- ✓ A-DNA
- ✓ Z-DNA

## ❖ B-DNA

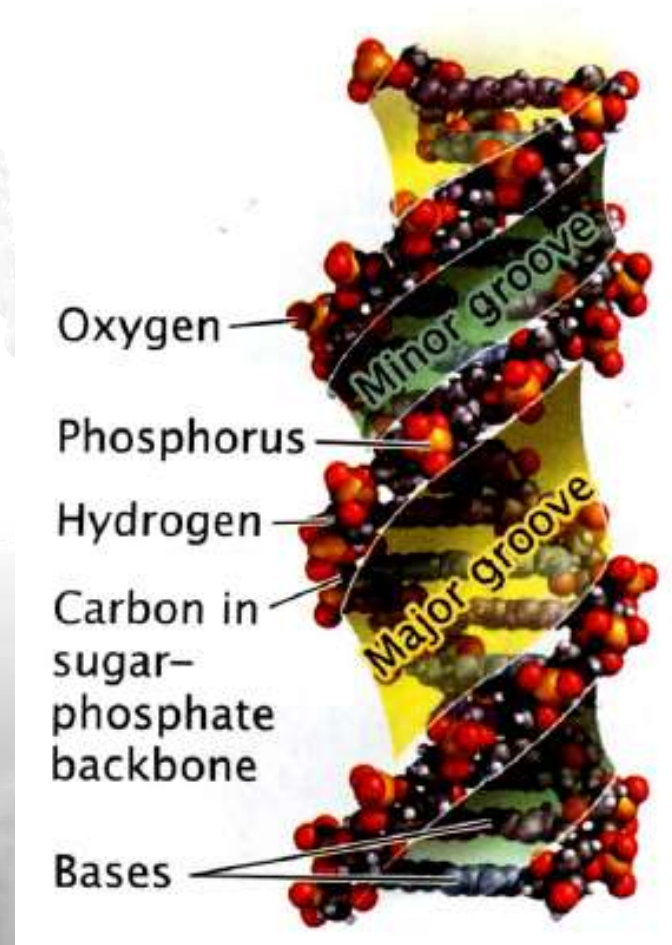
is biologically THE MOST COMMON

- ✓ It is a  $\alpha$ -helix meaning that it has a Right handed, or clockwise, spiral.
- ✓ Complementary base pairing
  - A-T
  - G-C
- ✓ Ideal B-DNA has 10 base pair per turn ( $360^\circ$  rotation of helix)
- ✓ So each base is twisted  $36^\circ$  relative to adjacent bases.
- ✓ Base pair are 0.34 nm apart.
- ✓ So complete rotation of molecule is 3.4 nm.
- ✓ Axis passes through middle of each basepairs.



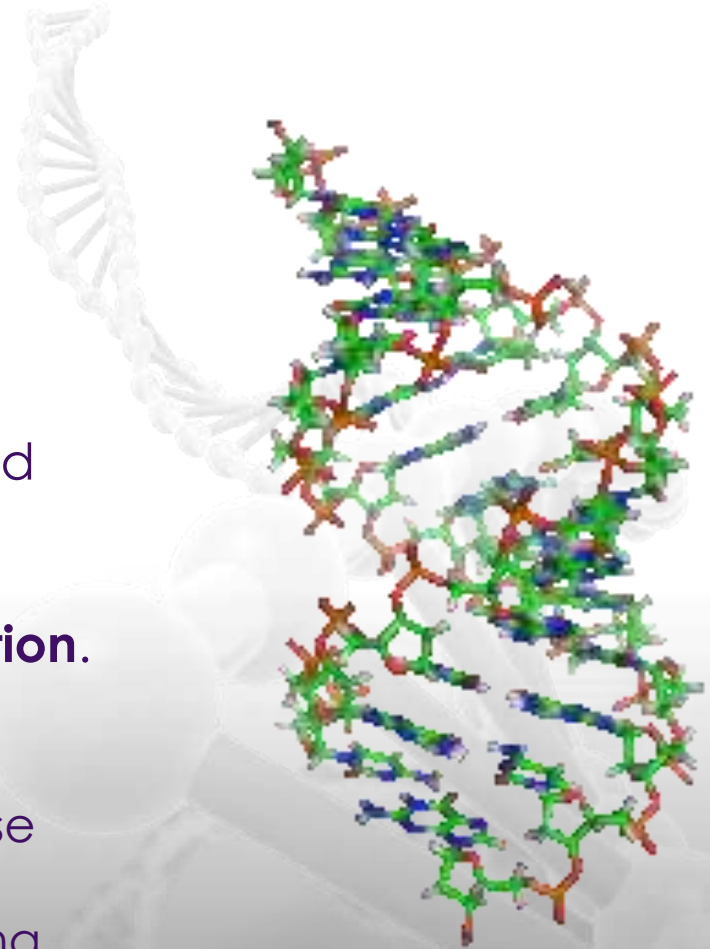
## ❖ B-DNA

- ✓ Minor Groove is Narrow, Shallow.
- ✓ Major Groove is Wide, Deep.
- ✓ This structure **exists** when **plenty of water** surrounds molecule and there is no unusual base sequence in DNA-Condition that are likely to be present in the cells.
- ✓ B-DNA structure is most stable configuration for a random sequence of nucleotides under physiological condition.



## ❖ A-DNA

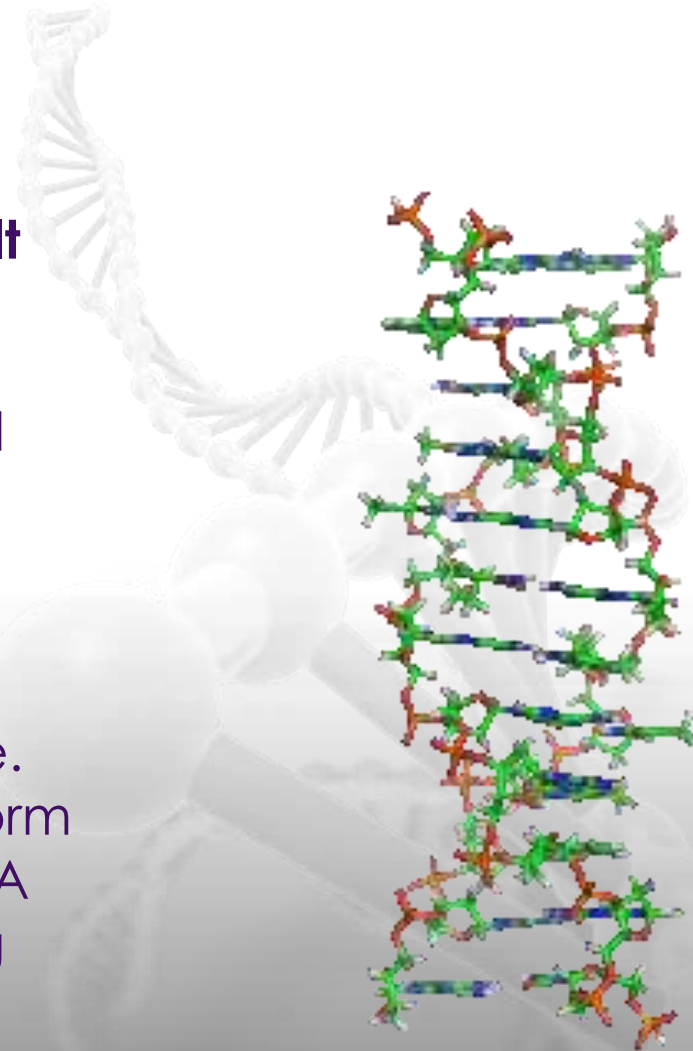
- ✓ Right-handed helix
- ✓ Wider and flatter than B-DNA
- ✓ 11 bp per turn
- ✓ Its bases are tilted away from main axis of molecule
- ✓ Narrow Deep major Groove and Broad, Shallow minor Groove.
- ✓ Observed when less water is present. i.e. **Dehydrating condition.**
- ✓ A-DNA has been observed in two context:
  - Active site of DNA polymerase (~3bp)
  - Gram (+) bacteria undergoing sporulation

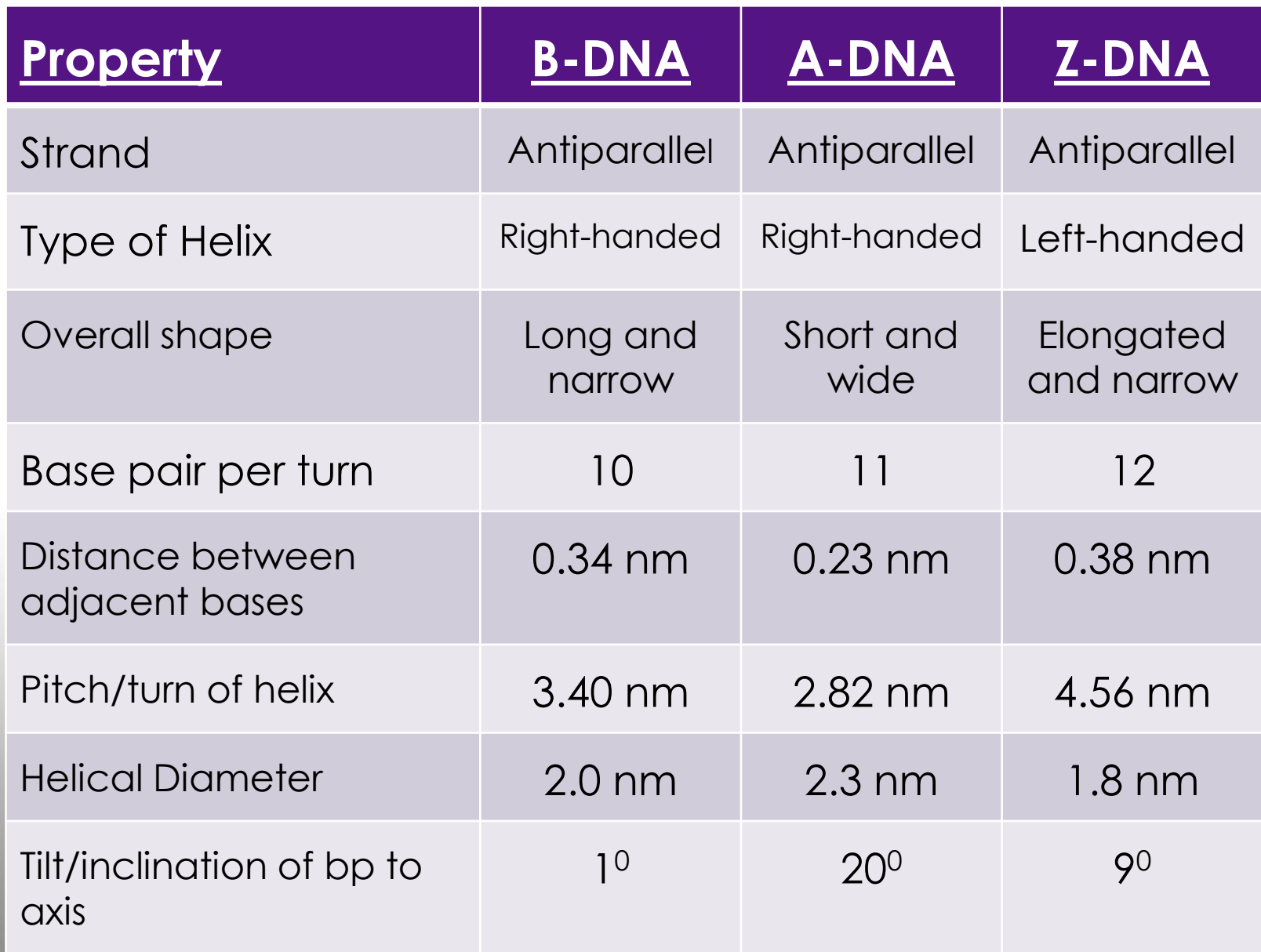




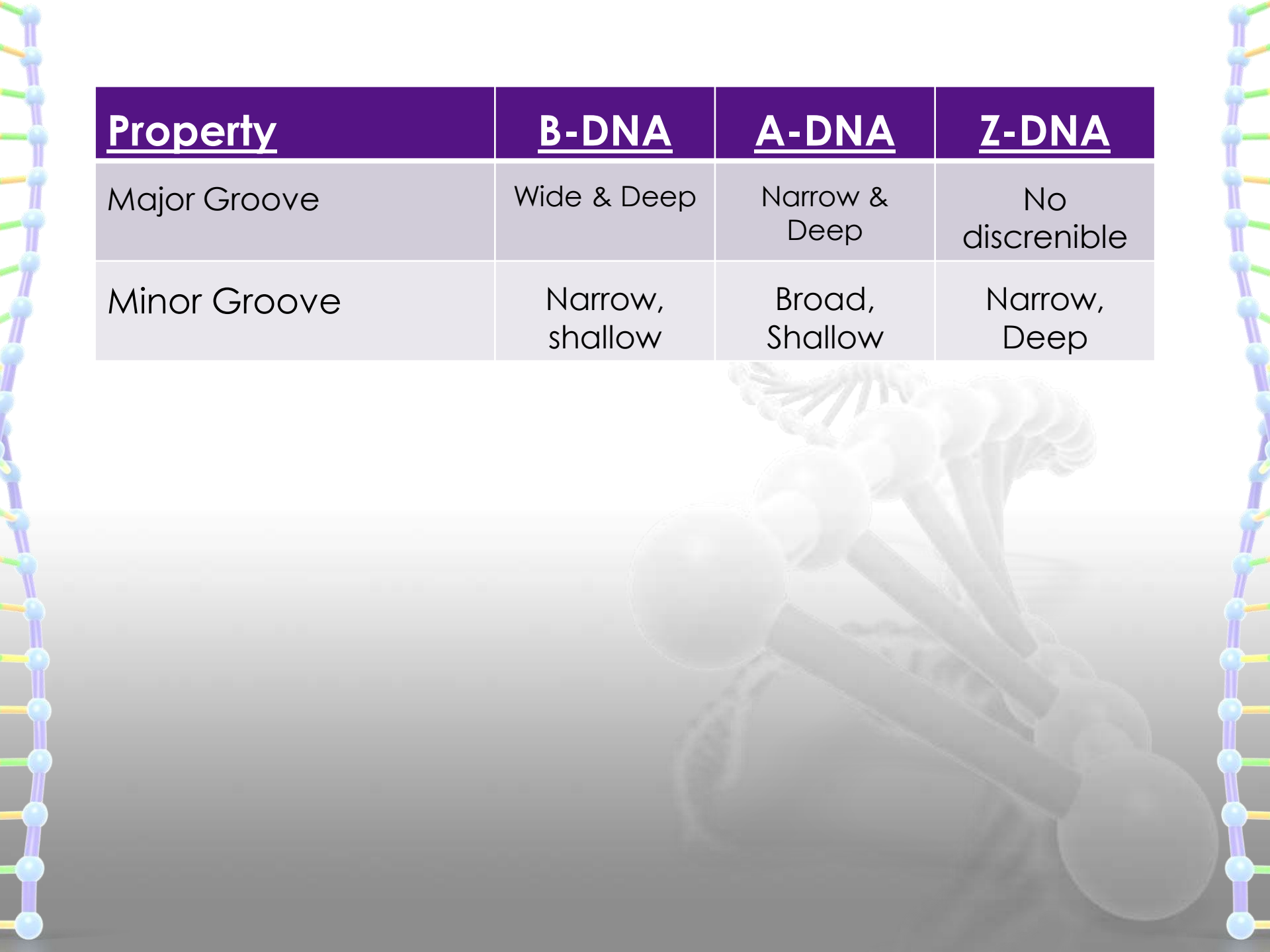
## ❖ Z-DNA

- ✓ A left-handed helix
- ✓ Seen in Condition of **High salt concentration**.
- ✓ In this form sugar-phosphate backbones zigzag back and forth, giving rise to the name Z-DNA (for zigzag).
- ✓ 12 base pairs per turn.
- ✓ A deep Minor Groove.
- ✓ No Discernible Major Groove.
- ✓ Part of some active genes form Z-DNA, suggesting that Z-DNA may play a role in regulating gene transcription.





<u>Property</u>	<u>B-DNA</u>	<u>A-DNA</u>	<u>Z-DNA</u>
Strand	Antiparallel	Antiparallel	Antiparallel
Type of Helix	Right-handed	Right-handed	Left-handed
Overall shape	Long and narrow	Short and wide	Elongated and narrow
Base pair per turn	10	11	12
Distance between adjacent bases	0.34 nm	0.23 nm	0.38 nm
Pitch/turn of helix	3.40 nm	2.82 nm	4.56 nm
Helical Diameter	2.0 nm	2.3 nm	1.8 nm
Tilt/inclination of bp to axis	1 <sup>0</sup>	20 <sup>0</sup>	9 <sup>0</sup>

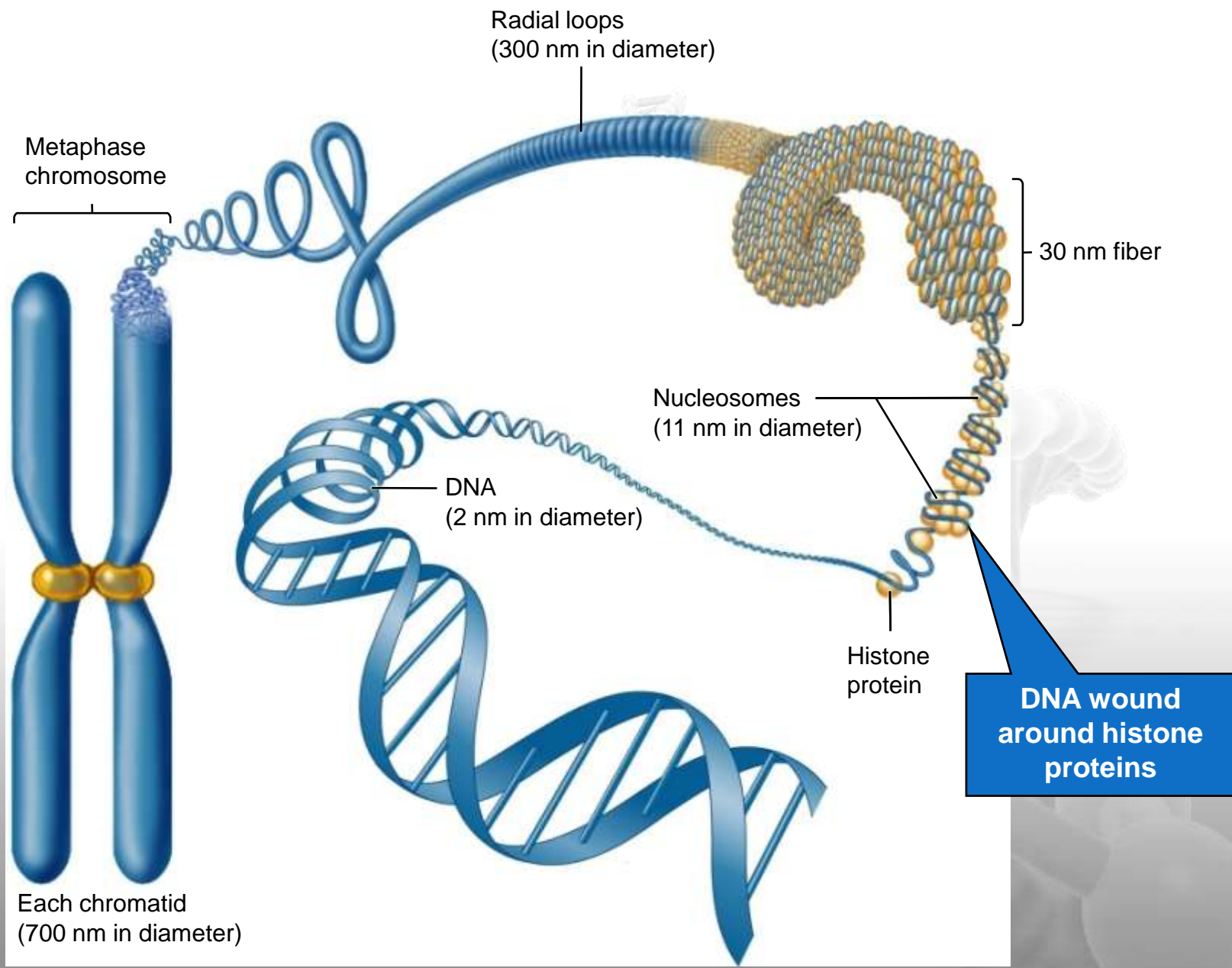


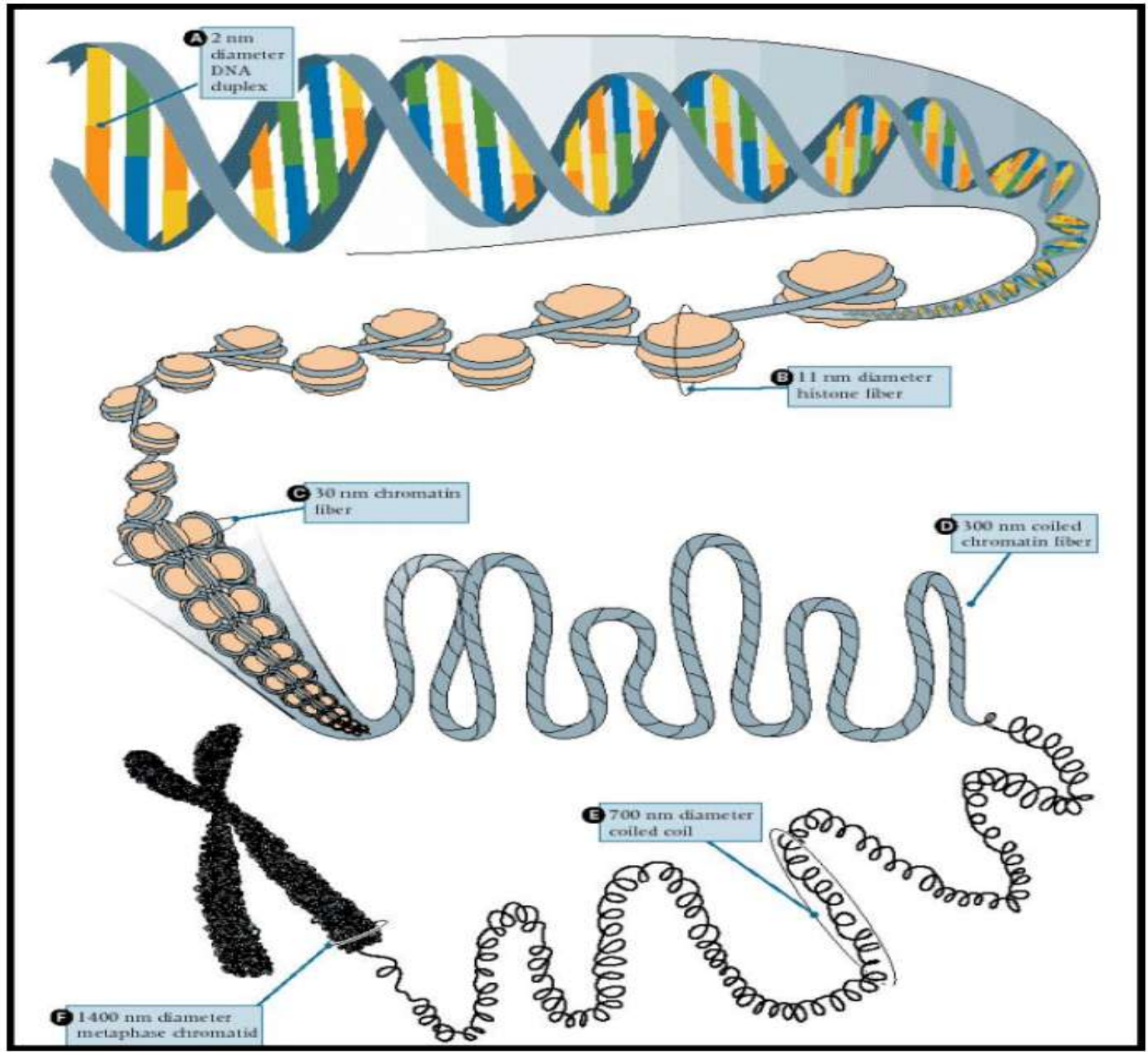
<u>Property</u>	<u>B-DNA</u>	<u>A-DNA</u>	<u>Z-DNA</u>
Major Groove	Wide & Deep	Narrow & Deep	No discredible
Minor Groove	Narrow, shallow	Broad, Shallow	Narrow, Deep



# ❖ DNA Supercoiling

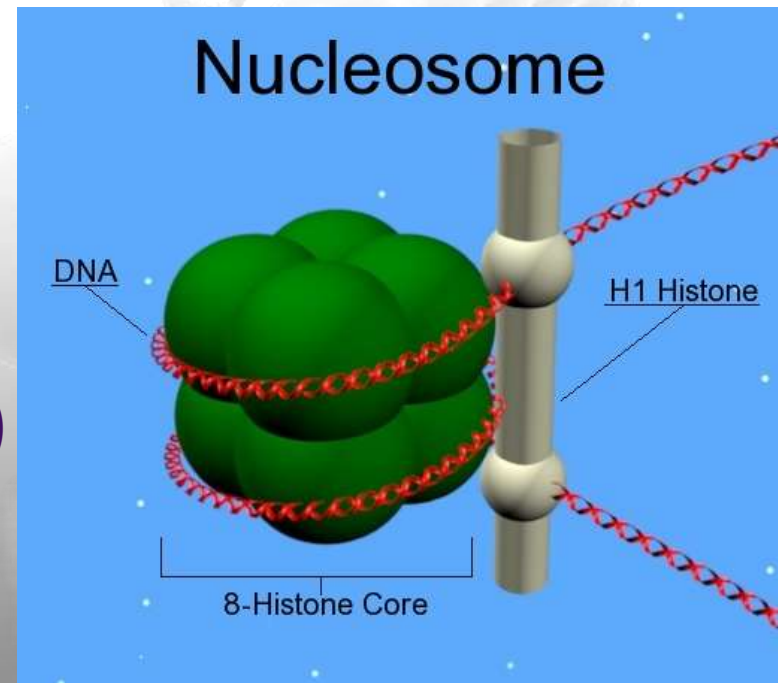
- **DNA supercoiling** refers to the over or under-winding of strands.
- DNA supercoiling is important for DNA packaging within all cells. Because the length of DNA can be of thousands of times that of a cell, packaging this material into the cell or nucleus (in Eukaryotes) is a difficult feat.
- Supercoiling of DNA reduces the space and allows for much more DNA to be packaged.



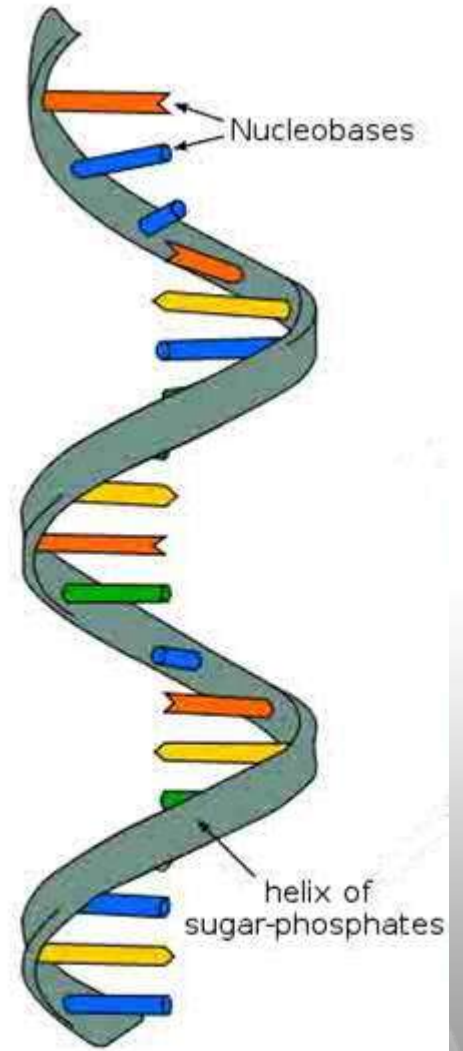


# ❖ Nucleosome Structure

- Nucleosome are the basic unit of the chromatin organization.
- In Eukaryotes DNA associated with Proteins.  
(In prokaryotes DNA is naked)
- Nucleosomes= basic bead like unit of DNA packing
  - ✓ Made of segment of DNA wound around a protein core that is composed of 2 copies of each 4 types of Histones.
- Nucleosomes have:
  - ✓ 8 Histones in the core
  - ✓ DNA wrapped twice around the core
  - ✓ One Histone holding the Nucleosome together
  - ✓ A DNA 'linker' continues towards the next nucleosome.
- The DNA has a negatively charged backbone (because of  $\text{PO}_4^{3-}$  group)
- The Protein (Histones) are positively charged.
- The DNA and Protein are Electromagnetically attracted to each other to form chromatin.



# RNA



**RNA**  
Ribonucleic acid

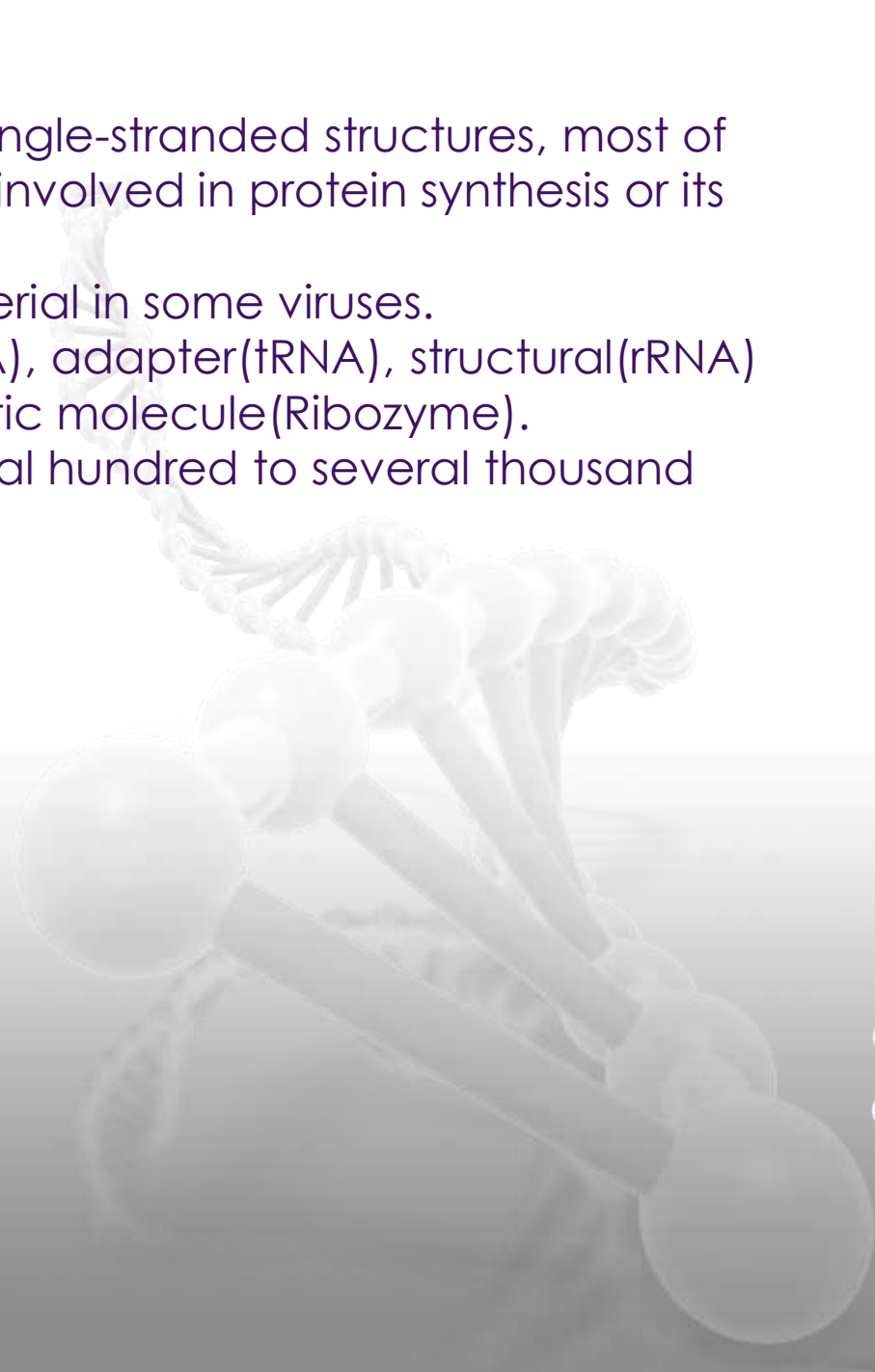




# RNA

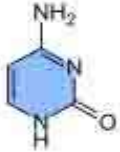
- Ribonucleic Acid
- RNA is a polymer of ribonucleotides linked together by **phosphodiester linkage**.
- RNA was first genetic material.
- **In 1967 Carl Woese** found the **catalytic** properties of RNA and speculated that the **earliest forms of life** relied on RNA both to carry genetic information and to catalyse biochemical reactions.
- Their theories were not validated until the work of Nobel Prize laureate **Thomas R. Cech**. In the **1970s, Cech** was studying the splicing of RNA in a single-celled organism, *Tetrahymena thermophila*, when he **discovered** that an **unprocessed RNA molecule could splice itself**. He announced his discovery in **1982** and became the first to show that RNA has **catalytic functions**.
- Usually single stranded and helical in structure.
- But double stranded also present in some viruses.

- RNA exists in several different single-stranded structures, most of which are directly or indirectly involved in protein synthesis or its regulation.
- It also acts as the genetic material in some viruses.
- It function as messenger(mRNA), adapter(tRNA), structural(rRNA) and in some cases as a catalytic molecule(Ribozyme).
- RNA strands are typically several hundred to several thousand nucleotides in length.

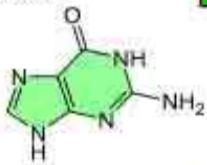


# ❖ RNA V/S DNA

Cytosine **C**



Guanine **G**



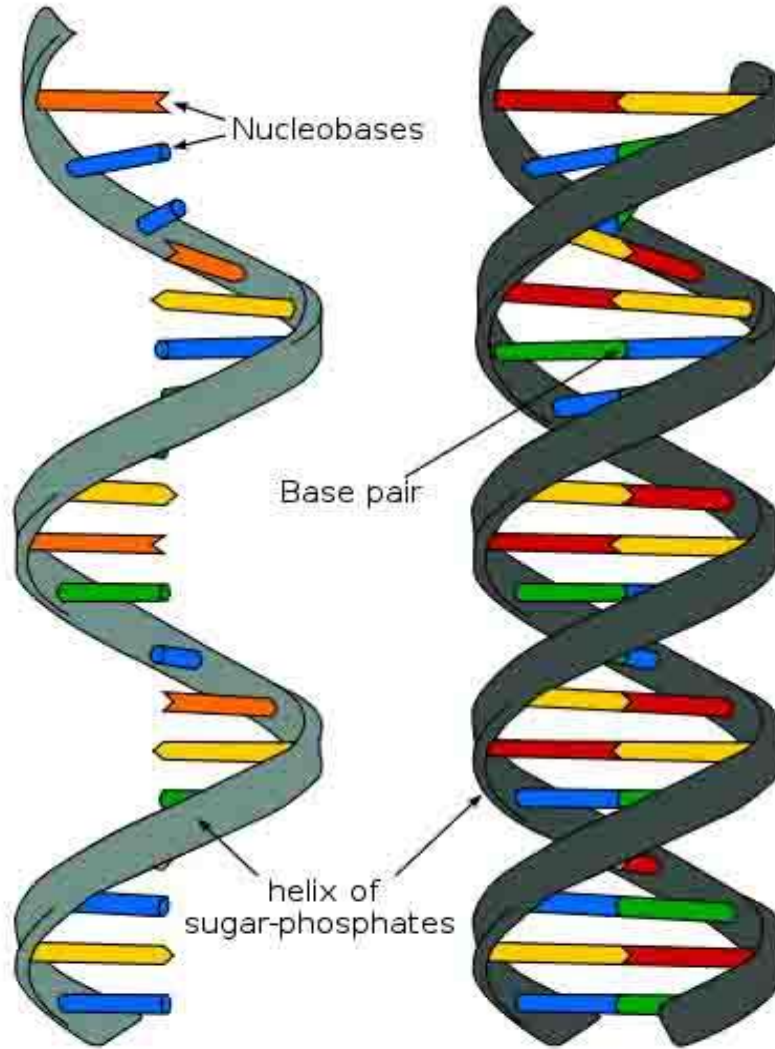
Adenine **A**



Uracil **U**



Nucleobases  
of RNA



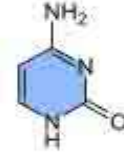
**RNA**

Ribonucleic acid

**DNA**

Deoxyribonucleic acid

Cytosine **C**



Guanine **G**



Adenine **A**



Thymine **T**



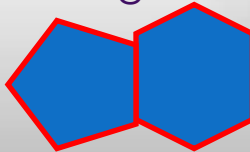
Nucleobases  
of DNA

# ❖ RNA structure

- There are also three main component
  - a) Phosphate Group
  - b) Sugar(Ribose)
  - c) And Nitrogenous base

## ❖ The Nitrogenous Bases

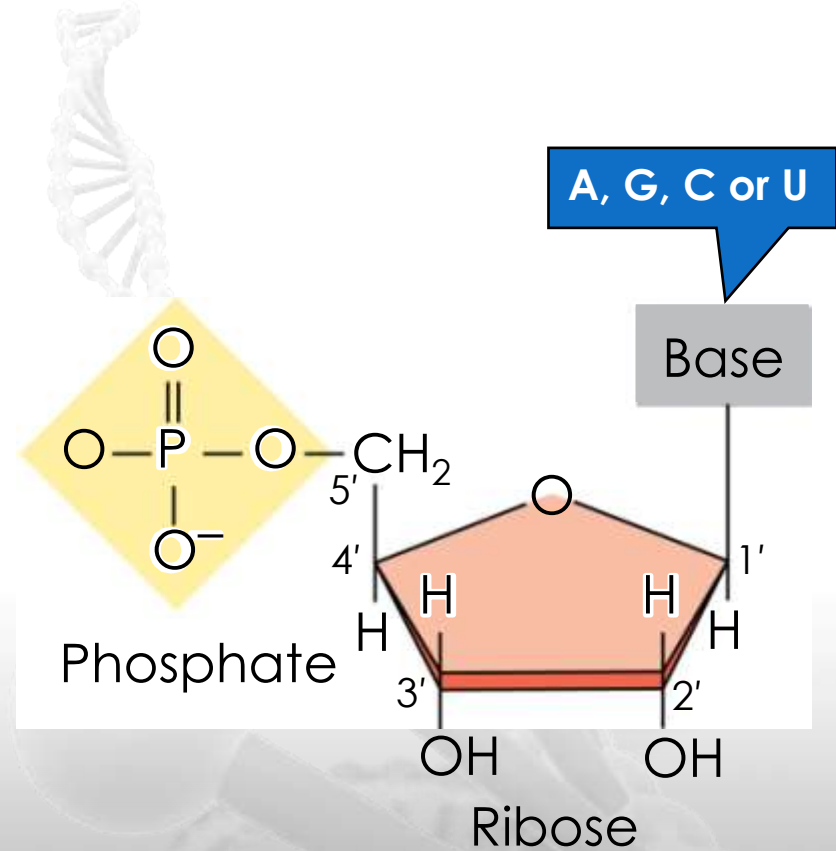
- They are divided into two groups:
  - i. Purine
  - ii. Pyrimidine
- Purines (made of a 6 member ring, fused to a 5 member ring)
  - ✓ Adenine
  - ✓ Guanine
- Pyrimidine (made of a 6 member ring)
  - ✓ Cytosine
  - ✓ Uracil



# ❖ RNA Structure

## ❖ Nucleotide

- Nucleotides are formed by the condensation of a sugar, phosphate and one of the 4 bases
- The following illustration represents one nucleotide



**RNA Nucleotide**



➤ Base + sugar → nucleoside

➤ Example

➤ Adenine + ribose = Adenosine

➤ Base + sugar + phosphate(s) → nucleotide

➤ Example

➤ Adenosine monophosphate (AMP)

➤ Adenosine diphosphate (ADP)

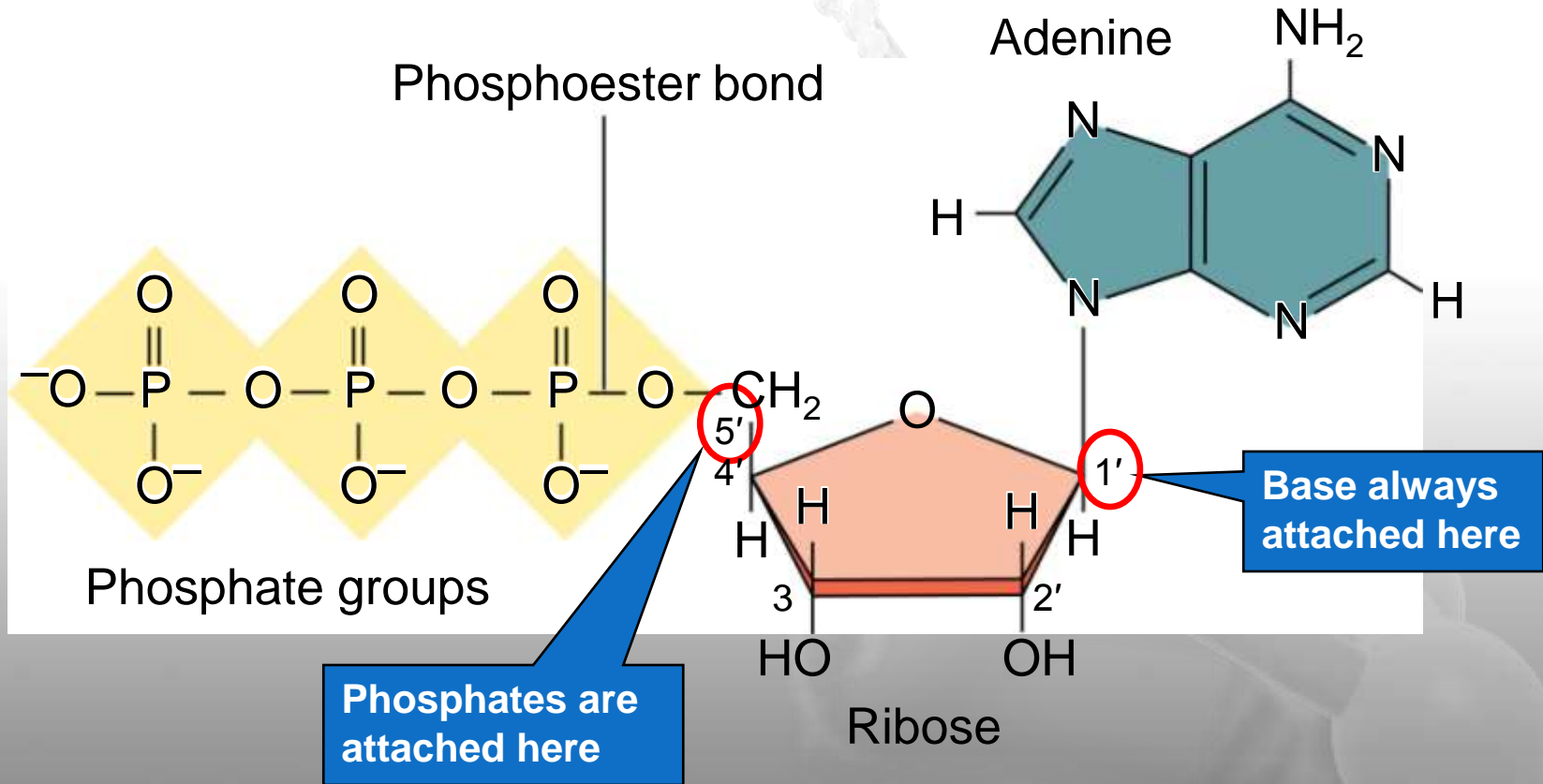
➤ Adenosine triphosphate (ATP)

# Adenosine triphosphate

## Adenosine diphosphate

## Adenosine monophosphate

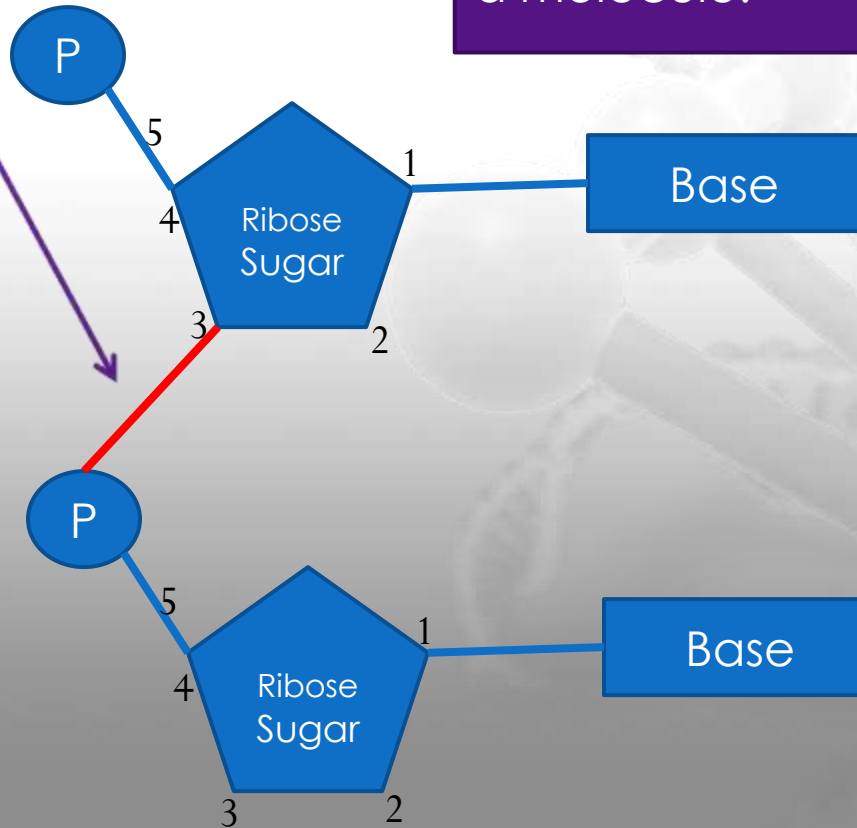
## Adenosine



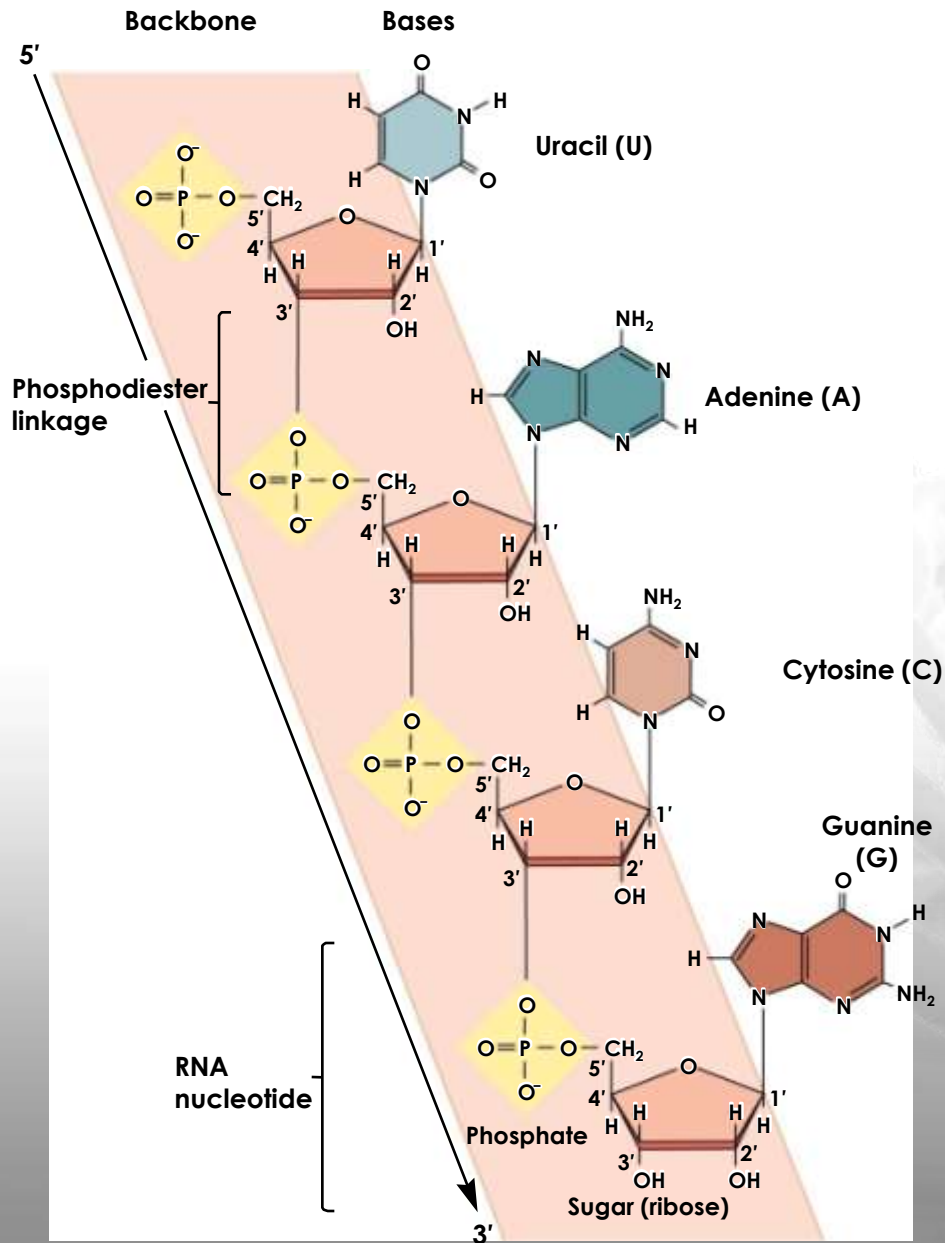
## ❖ Covalent bonding B/W Nucleotides

- Nucleotides are linked together by covalent bonds called phosphodiester linkage.

A chemical bond that involves sharing a pair of electrons between atoms in a molecule.

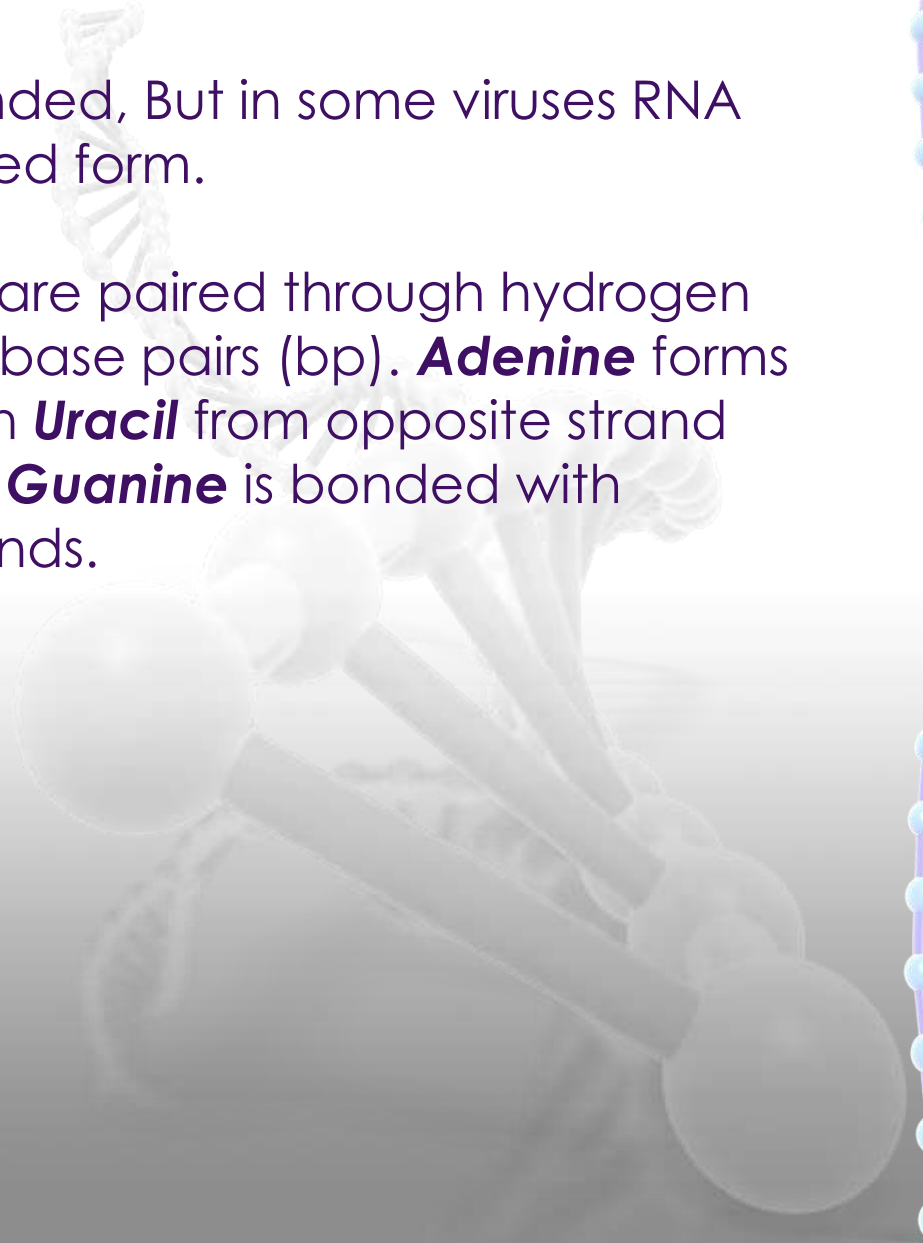






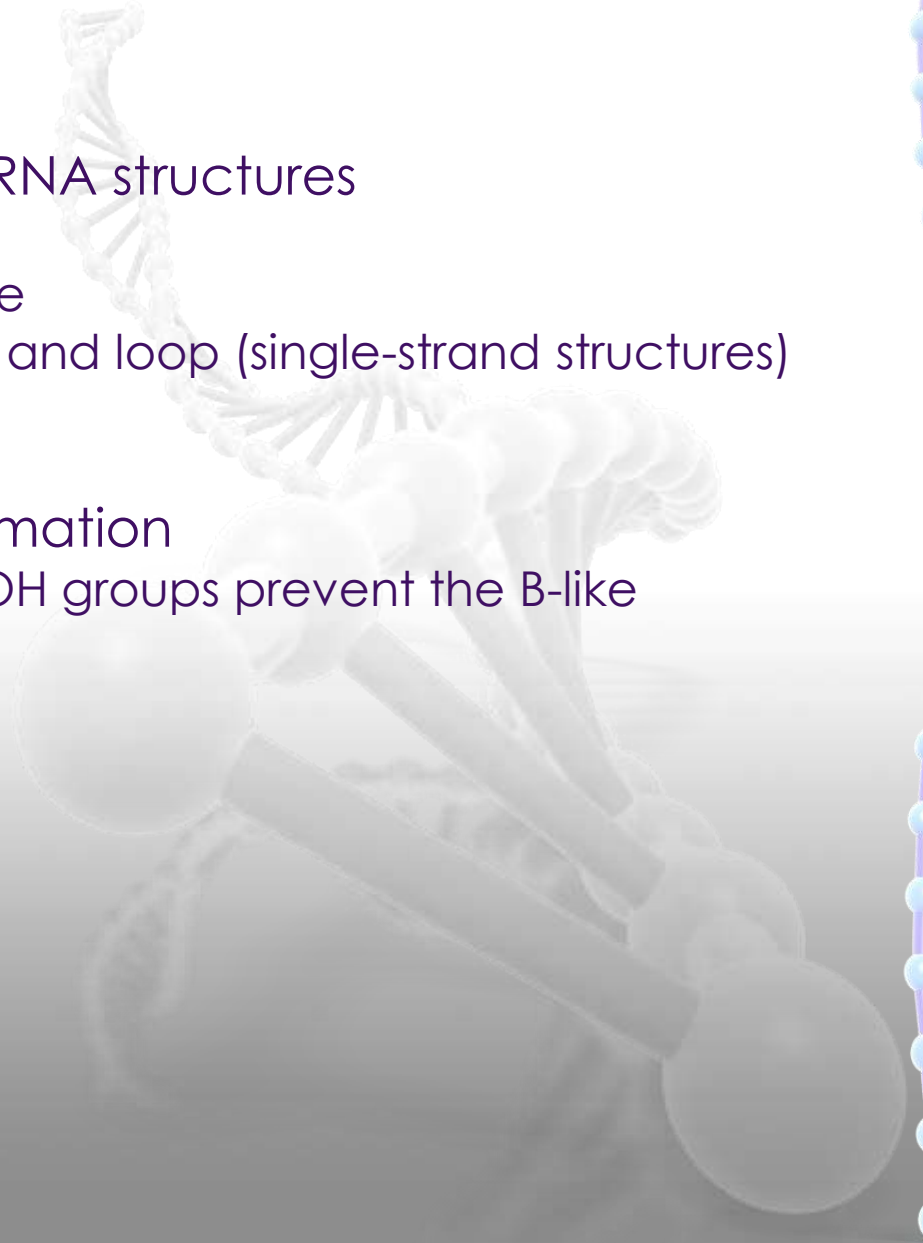
## ❖ Hydrogen bonding

- Usually RNA is single stranded, But in some viruses RNA present in double stranded form.
- The bases in two strands are paired through hydrogen bond (H-bonds) forming base pairs (bp). **Adenine** forms **two** hydrogen bonds with **Uracil** from opposite strand and vice-versa. Similarly, **Guanine** is bonded with **Cytosine** with **three** H-bonds.

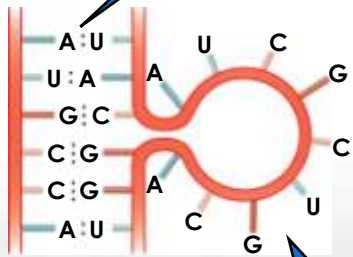


## ❖ dsRNA Structure

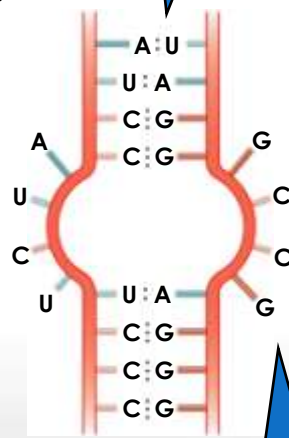
- There are double-stranded RNA structures
  - ✓ RNA can fold back on itself
  - ✓ Depends on base sequence
  - ✓ Gives stem (double-strand) and loop (single-strand structures)
- ds RNA has an A-like conformation
  - ✓ Steric clashes between 2'-OH groups prevent the B-like conformation.



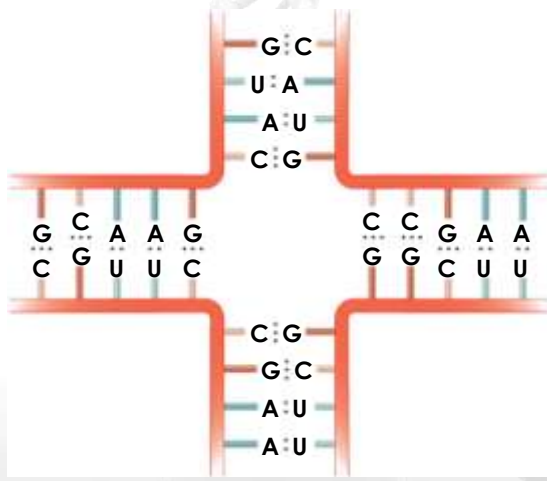
**Complementary regions  
Held together by  
hydrogen bonds**



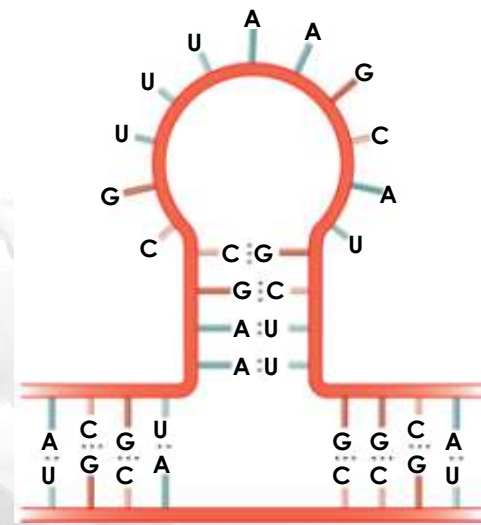
**(a) Bulge loop**



**(b) Internal loop**



**(c) Multibranch junction**



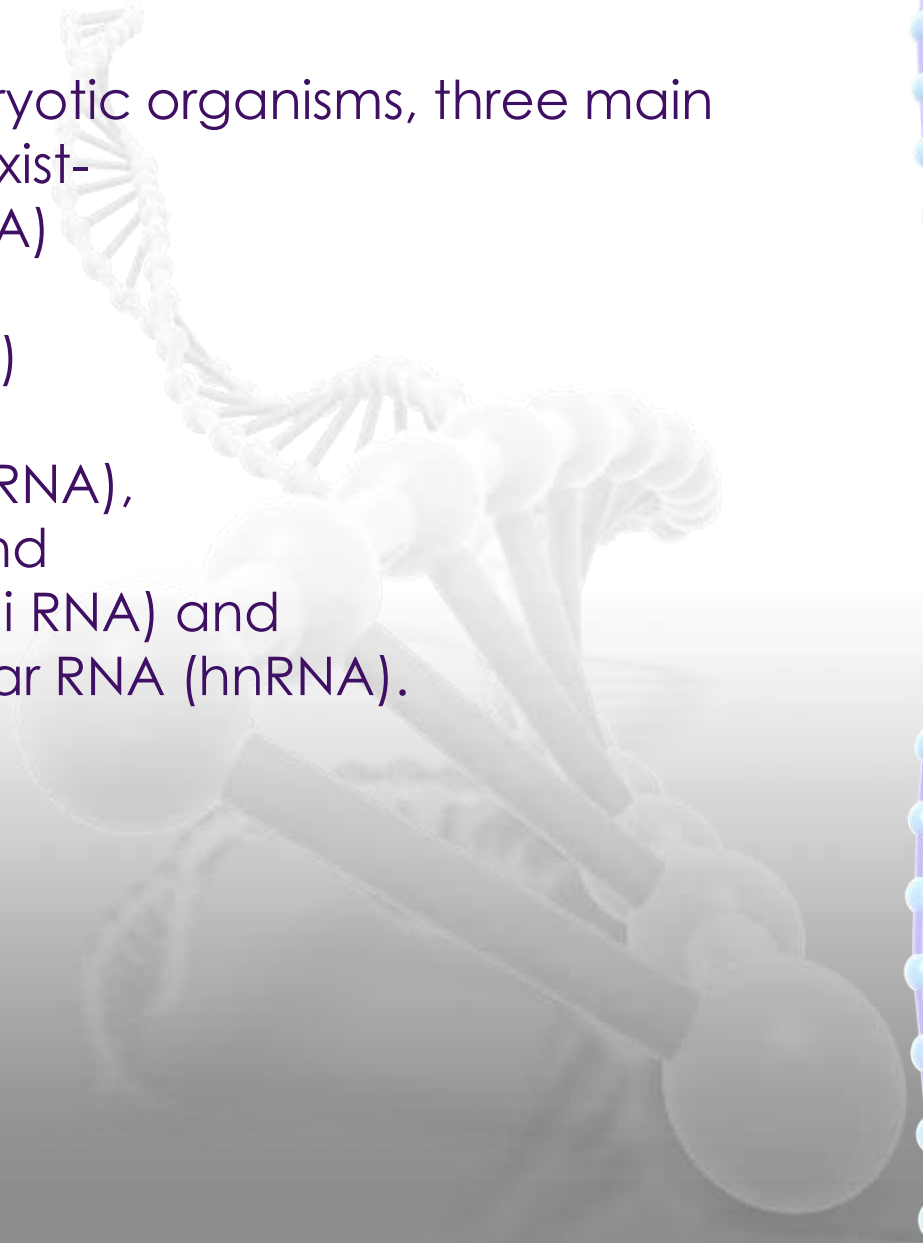
**(d) Stem-loop**

**Non-complementary regions  
Have bases projecting away  
from double stranded regions**

**Also called  
hair-pin**

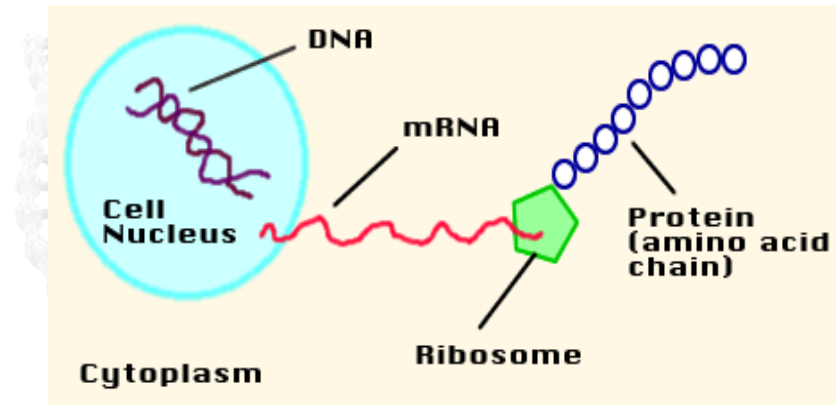
## ❖ Types of RNA

- In all prokaryotic and eukaryotic organisms, three main classes of RNA molecules exist-
  - 1) Messenger RNA (m RNA)
  - 2) Transfer RNA (t RNA)
  - 3) Ribosomal RNA (r RNA)
- The other are –
  - ✓ small nuclear RNA (SnRNA),
  - ✓ micro RNA (mi RNA) and
  - ✓ small interfering RNA (Si RNA) and
  - ✓ heterogeneous nuclear RNA (hnRNA).



## ❖ Messenger RNA (m-RNA)

- All members of the class function as messengers carrying the information in a gene to the protein synthesizing machinery

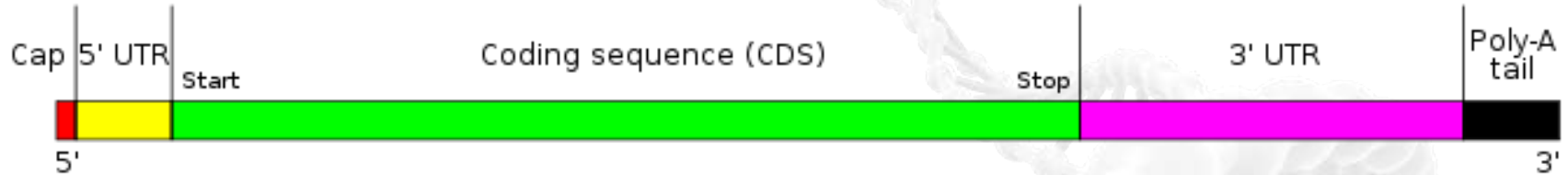


## ❖ Structure

- The 5' terminal end is capped by **7- methyl guanosine triphosphate cap**.
- The cap is involved in the **recognition of mRNA** by the translating machinery.
- It stabilizes m RNA by protecting it from 5' **exonuclease**.
- The 3' end of most m-RNAs have a polymer of Adenylate residues( 20-250).
- The tail prevents the attack by 3' exonucleases.
- On both 5' and 3' end there are non coding sequences which are not translated (NCS)

- The intervening region between non coding sequences present between 5' and 3' end is called coding region. This region encodes for the synthesis of a protein.

The structure of a typical human protein coding mRNA including the untranslated regions (UTRs)



### Eukaryotic mRNA molecule



5'-cap-AGGAUU AUGCCUGGACUGAGCGCUUAG AUUAUAUAAAAAAAAAAAAA

Start Stop

## ❖ Heterogeneous nuclear RNA (hnRNA) [Precursor mRNA]

- In mammalian nuclei , hnRNA is the immediate product of gene transcription
- The nuclear product is heterogeneous in size (Variable) and is very large.
- 75 % of hnRNA is degraded in the nucleus, only 25% is processed to mature m RNA.
- Mature m –RNA is formed from primary transcript by capping, tailing, splicing and base modification.



# ❖ Transfer RNA (t-RNA)

- Transfer RNA are the smallest of three major species of RNA molecules
- They have 74-95 nucleotide residues
- They transfer the amino acids from cytoplasm to the protein synthesizing machinery, hence the name t RNA.
- They are also called Adapter molecules, since they act as adapters for the translation of the sequence of nucleotides of the m RNA in to specific amino acids
- There are at least 20 species of tRNA one corresponding to each of the 20 amino acids required for protein synthesis.
- **tRNA** is the only RNA species that contains the **nucleoside thymidine**.

## ❖ Structure

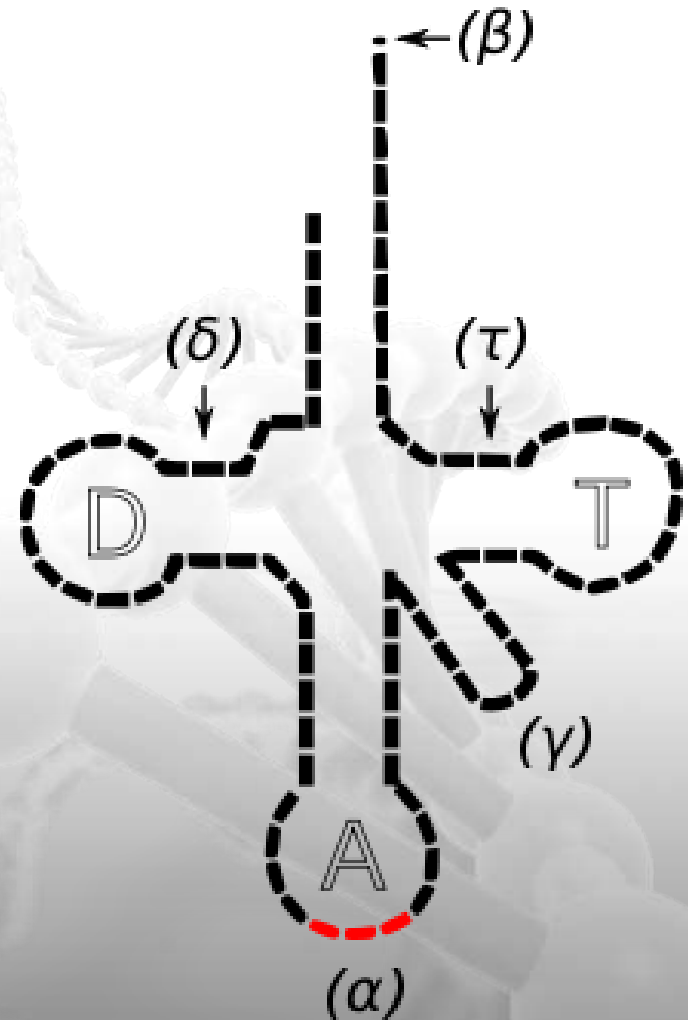
**1) Primary structure-** The nucleotide sequence of all the t RNA molecules allows extensive intrastand complementarity that generates a secondary structure.

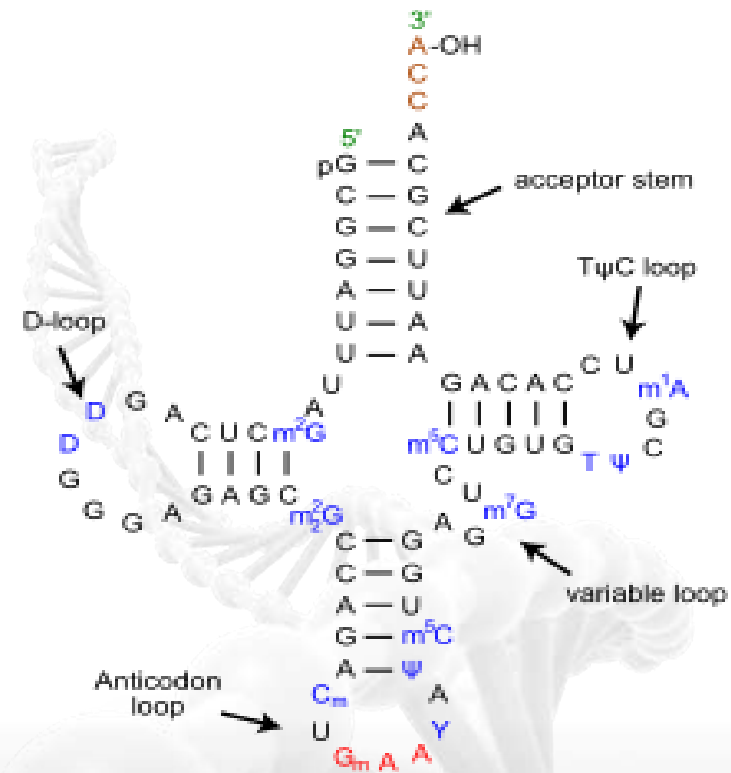
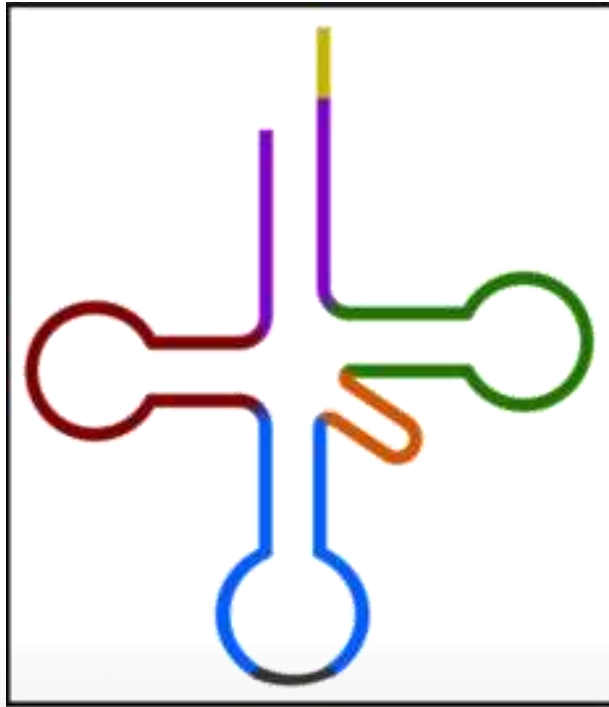
**2) Secondary structure-** Each single t- RNA shows extensive internal base pairing and acquires a clover leaf like structure. The structure is stabilized by hydrogen bonding between the bases and is a consistent feature.

### **Secondary structure (Clover leaf structure)**

All t-RNA contain 5 main arms or loops which are as follows-

- Acceptor arm
- Anticodon arm
- D HU arm (***DihydroUracil***)
- T $\Psi$  C arm **Thymidine Pseudouridine Cytosine**
- Extra arm

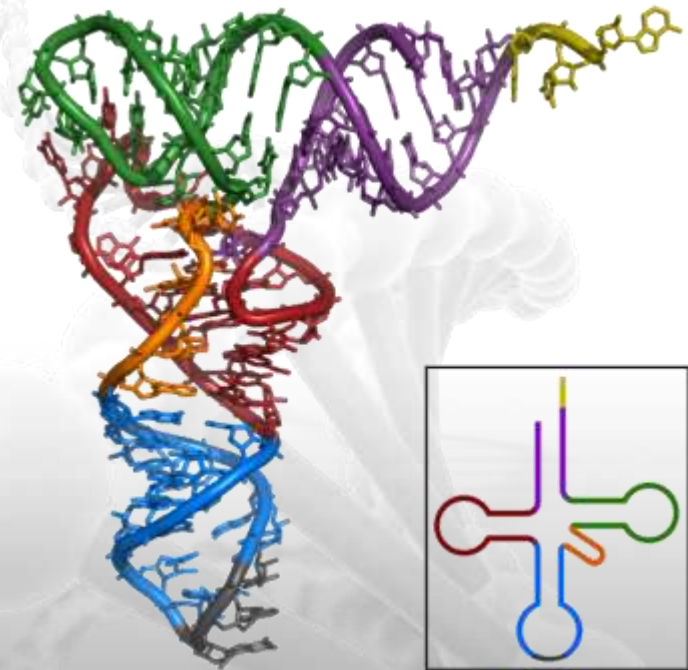




Secondary structure of tRNA. **CCA tail** in **yellow**, **Acceptor stem** in **purple**, **Variable loop** in **orange**, **D arm** in **red**, **Anticodon arm** in **blue** with **Anticodon** in **black**, **T arm** in **green**.

### 3) Tertiary structure of t-RNA

- The L shaped tertiary structure is formed by further folding of the clover leaf due to hydrogen bonds between T and D arms.
- The base paired double helical stems get arranged in to two double helical columns, continuous and perpendicular to one another.



## ❖ Ribosomal RNA (rRNA)

- **Ribosomal ribonucleic acid (rRNA)** is the **RNA** component of the **ribosome**, and is essential for **protein synthesis** in all living organisms.
- The functions of the ribosomal RNA molecules in the ribosomal particle are not fully understood, but they are necessary for ribosomal assembly and seem to play key roles in the binding of mRNA to ribosomes and its translation
- Recent studies suggest that an rRNA component performs the peptidyl transferase activity and thus is an enzyme (a ribozyme).
- It constitutes the predominant material within the ribosome, which is approximately 60% rRNA and 40% protein by weight.
- Ribosomes contain two major rRNAs and 50 or more proteins.
- The ribosomal RNAs form two subunits, the large subunit (LSU) and small subunit (SSU). The LSU rRNA acts as a **ribozyme**, catalysing **peptide bond formation**.

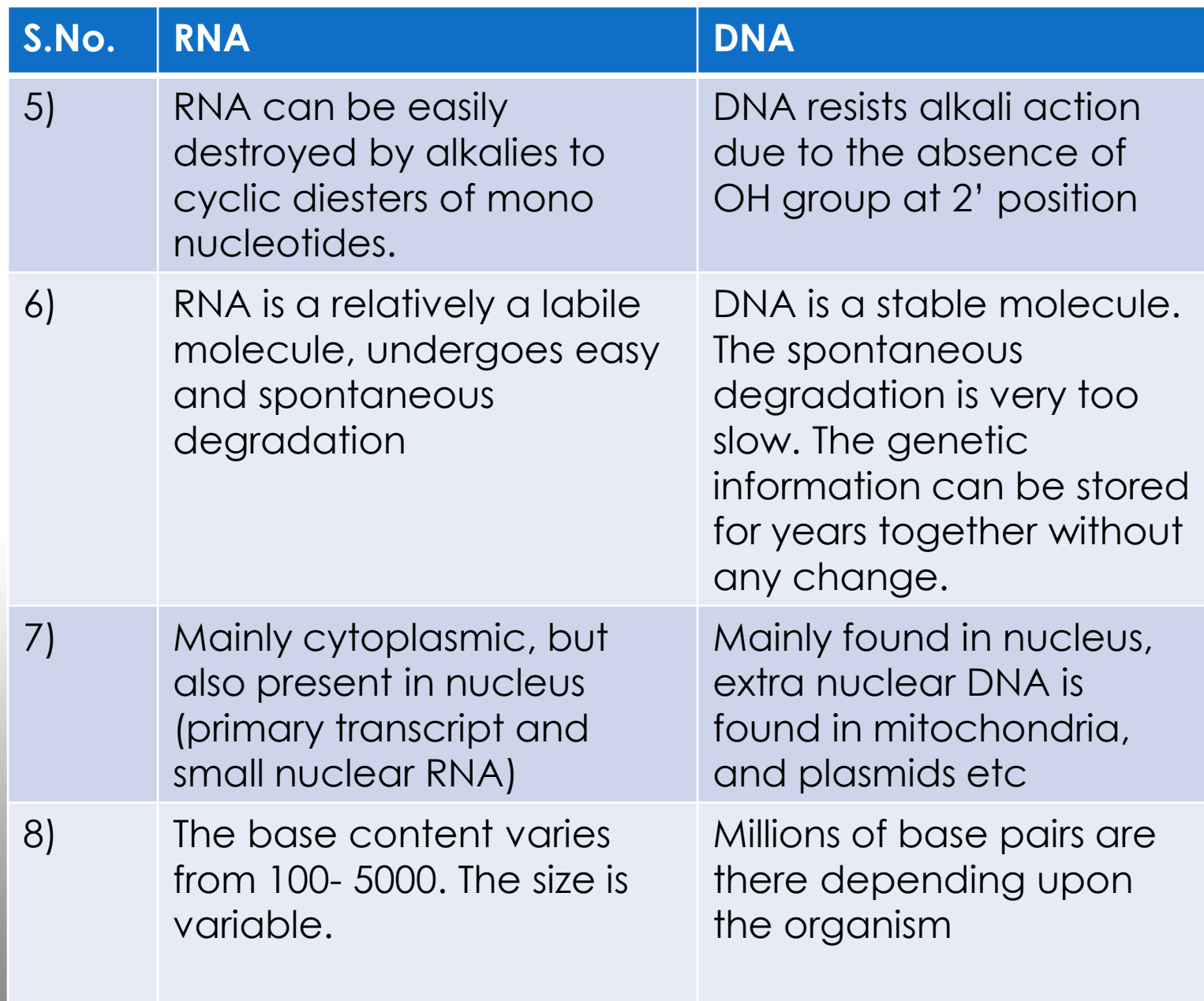
# ❖ Small RNA molecules

## □ Major types of small RNA molecules:

- Small nuclear RNA (snRNA) - involved in mRNA splicing.
- Small nucleolar RNA (snoRNA) - directs the modification of ribosomal RNAs.
- Micro RNA (miRNA) and short interfering RNA (siRNA) - regulate gene expression.

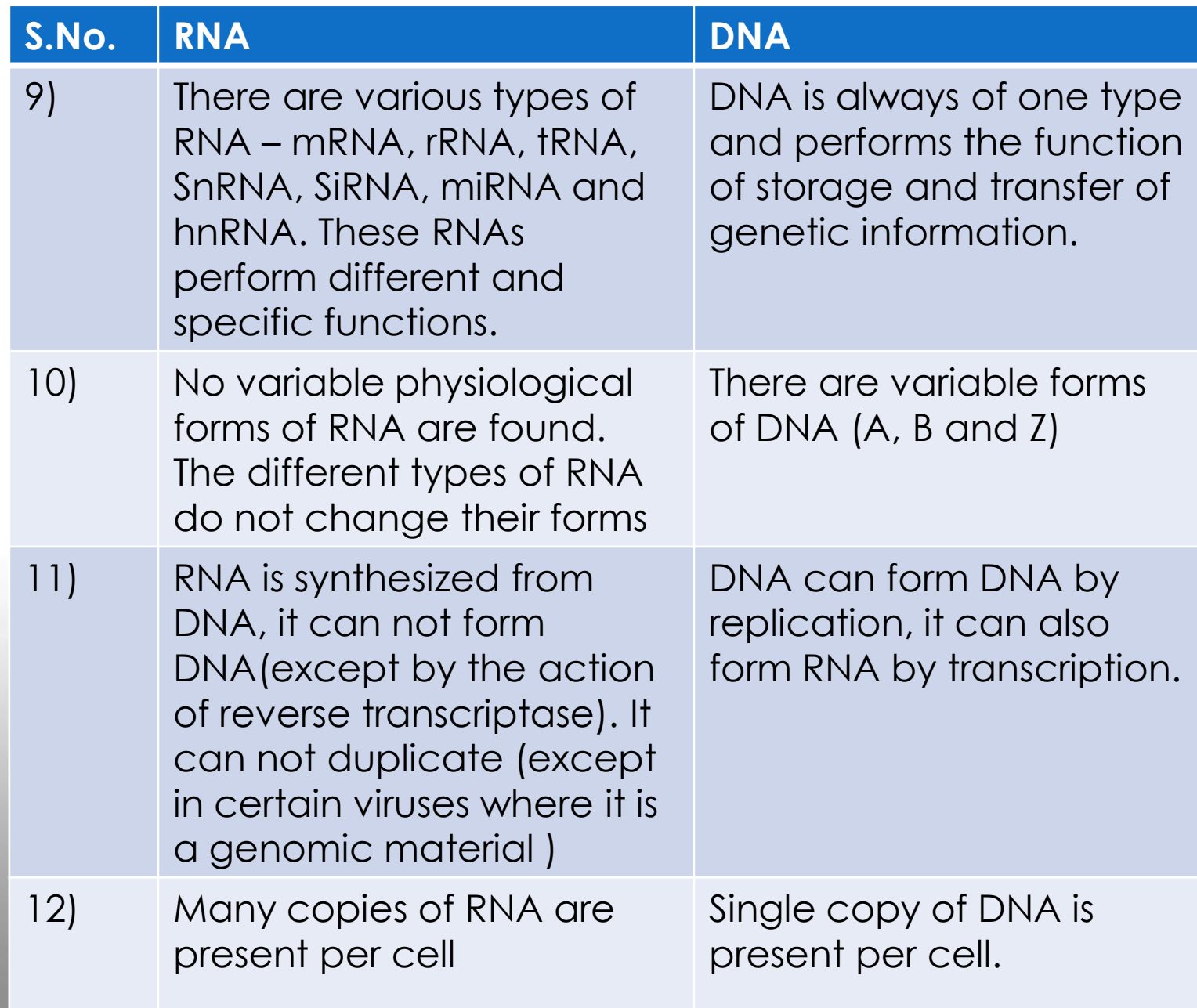
# ❖ Differences between RNA and DNA

S.No.	RNA	DNA
1)	Single stranded mainly except when self complementary sequences are there it forms a double stranded structure (Hair pin structure)	Double stranded (Except for certain viral DNA s which are single stranded)
2)	Ribose is the main sugar	The sugar moiety is deoxy ribose
3)	Pyrimidine components differ. Thymine is never found (Except tRNA)	Thymine is always there but uracil is never found
4)	Being single stranded structure- It does not follow Chargaff's rule	It does follow Chargaff's rule. The total purine content in a double stranded DNA is always equal to pyrimidine content.

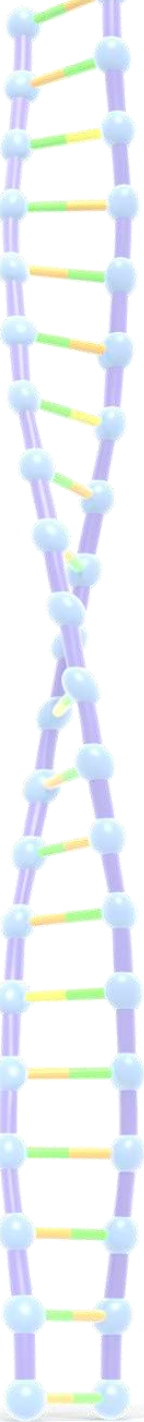


S.No.	RNA	DNA
5)	RNA can be easily destroyed by alkalis to cyclic diesters of mono nucleotides.	DNA resists alkali action due to the absence of OH group at 2' position
6)	RNA is a relatively a labile molecule, undergoes easy and spontaneous degradation	DNA is a stable molecule. The spontaneous degradation is very too slow. The genetic information can be stored for years together without any change.
7)	Mainly cytoplasmic, but also present in nucleus (primary transcript and small nuclear RNA)	Mainly found in nucleus, extra nuclear DNA is found in mitochondria, and plasmids etc
8)	The base content varies from 100- 5000. The size is variable.	Millions of base pairs are there depending upon the organism



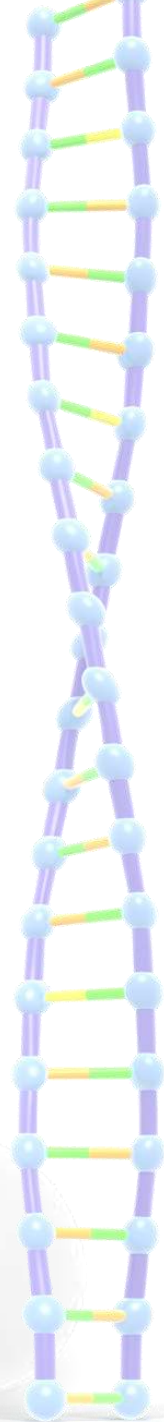


S.No.	RNA	DNA
9)	There are various types of RNA – mRNA, rRNA, tRNA, SnRNA, SiRNA, miRNA and hnRNA. These RNAs perform different and specific functions.	DNA is always of one type and performs the function of storage and transfer of genetic information.
10)	No variable physiological forms of RNA are found. The different types of RNA do not change their forms	There are variable forms of DNA (A, B and Z)
11)	RNA is synthesized from DNA, it can not form DNA(except by the action of reverse transcriptase). It can not duplicate (except in certain viruses where it is a genomic material )	DNA can form DNA by replication, it can also form RNA by transcription.
12)	Many copies of RNA are present per cell	Single copy of DNA is present per cell.



*Thank*

*You*



Lecture note- 4  
Organic Chemistry CHE 502

# **CARBOHYDRATES**

Co-Coordinator – Dr. Shalini Singh

DEPARTMENT OF CHEMISTRY  
UTTARAKHAND OPEN UNIVERSITY

---

# UNIT- 7 CARBOHYDRATES-I

---

## **CONTENTS**

- 7.1. Objectives
- 7.2. Introduction
- 7.3. Classification and Nomenclature
- 7.4. Monosaccharides
- 7.5. Mechanism of osazone formation
- 7.6. Interconversion of glucose and fructose
- 7.7. Chain lengthening and chain shortening of glucose
- 7.8 Summary
- 7.9. Model examination questions

---

## ***7.1 OBJECTIVES***

---

After going through this unit you will be able to:

- Define carbohydrates,
- Differentiate and classify the three major groups of carbohydrates,
- Define anomers, mutarotation, configuration and mechanism of osazone formation,
- Describe ether and ester formation,
- Differentiate between reducing and non reducing sugars,
- Define interconversion of glucose and fructose,
- Describe the chain lengthening and chain shortening of aldose
- Discuss about Erythro and threo distereomers conversion of glucose
- Determination of ring size of monosaccharides,

---

## ***7.2 INTRODUCTION***

---

Carbohydrates are a class of naturally occurring organic compounds of carbon, hydrogen and oxygen which are primarily produced by plants. They are extremely widespread in plants comprising upto 80% of dry weight. These are ultimate source of our food. In higher animals the simple sugar glucose is an essential constituent of blood and occurs in a polymeric form as glycogen in the liver and muscle.

In the green plants, carbohydrates are produced by a process called photosynthesis. This process involves the conversion of simple compounds  $\text{CO}_2$  and  $\text{H}_2\text{O}$  into glucose ( $\text{C}_6\text{H}_{12}\text{O}_6$ ) and is catalysed by green colouring pigment chlorophyll present in the leaves of plants. The energy required for this conversion is supplied by sun in the form of sunlight.

Carbohydrates are very useful for human beings. They provide us all the three basic necessities of life i.e., food (starch containing grain), clothes (cellulose in the form of cotton, linen and rayon) and shelter (cellulose in the form of wood used for making our houses and furniture etc.). Carbohydrates are also important to the economy of many nations. For example, sugar is one of the most important commercial commodities.

The term carbohydrates arose because the general formula for most of them could be written as  $\text{C}_x (\text{H}_2\text{O})_y$  and thus they may be regarded as hydrates of carbon. However, this definition was not found to be correct e.g., rhamnose, a carbohydrate, is having the formula  $\text{C}_6\text{H}_{12}\text{O}_5$  while acetic acid having formula  $\text{C}_2\text{H}_4\text{O}_2$  is not a carbohydrate. Simple carbohydrates are also known as sugars or saccharides (Latin: Saccharum; Greek : Sakcharon, Sugar) and the ending of the names of most sugars is -ose. Examples: glucose, fructose, sucrose, maltose, arabinose, etc.

Chemically, carbohydrates contain mainly two functional groups, carbonyl group (aldehyde or ketone) and a number of hydroxyl groups. Accordingly carbohydrates are now defined optically active polyhydroxy aldehydes or polyhydroxy ketones or the compound that can be hydrolysed to either of them.

---

## 7.3 CLASSIFICATION AND NOMENCLATURE

---

### 7.3.1 Classification

Carbohydrates, in general, may be classified into two classes:

- (i) **Sugars.** These are crystalline substances which are sweet and water soluble. For examples, glucose, fructose and cane sugar.
- (ii) **Non-sugars.** These are tasteless, insoluble in water and amorphous. For example. Starch, cellulose, etc.

However, these days Carbohydrates are systematically classified into three major group:

- (a) **Monosaccharides.** The simplest carbohydrates that cannot be hydrolysed into simpler carbohydrates, are called monosaccharides. depending upon whether they contain an aldehyde or keto groups, they may be called aldoses or ketoses. For example, a five carbon monosaccharide having aldehyde group is called aldopentose and six carbon monosaccharide containing a keto group is called keto-hexose. A few examples of monosaccharides are given below:

Aldotetroses. Erythrose and Threose;  $\text{CH}_2\text{OH}(\text{CHOH})_2 \text{CHO}$ .

Ketotetroses. Erythrulose,  $\text{CH}_2\text{OHCOCHOHCH}_2\text{OH}$ .

Aldopentoses. Ribose, arabinose, Xylose and Lyxose.  $\text{CH}_2\text{OH}(\text{CHOH})_3 \text{CHO}$ .

All have a common molecular formula but different structures.

Ketopentoses. Ribulose and Xylulose;  $\text{CH}_2\text{OHCO}(\text{CHOH})_2 \text{CH}_2\text{OH}$ .

Aldohexoses. Glucose, mannose, galactose;  $\text{CH}_2\text{OH}(\text{CHOH})_4 \text{CHO}$ .

Ketohexoses. Fructose, Sorbose etc.  $\text{CH}_2\text{OHCO}(\text{CHOH})_3 \text{CH}_2\text{OH}$ .

- (b) **Oligosaccharides.** These are the carbohydrates which can be hydrolysed into a definite number of monosaccharide molecules. Depending upon the number of monosaccharides that are obtained from them on hydrolysis, they may be called di-, tri- or tetra-saccharides: For example:

Disaccharides: sucrose, lactose, maltose. All these have the same molecular formula  $C_{12}H_{22}O_{11}$ .

Trisaccharides: raffinose ( $C_{18}H_{32}O_{16}$ ).

Tetrasaccharides: stachyose ( $C_{24}H_{42}O_{21}$ ).

(c) **Polysaccharides.** Carbohydrates that yield a large number of molecules (more than ten molecules) of monosaccharides on hydrolysis are called polysaccharides. The common examples are starch, cellulose, glycogen, etc.

### 7.3.2 Nomenclature

Carbohydrates contain hydroxy and aldehydic or ketonic groups. They are named according to IUPAC system of nomenclature

Compound	Common name	IUPAC name
$CH_2OHCHOHCHO$	Glyceraldehyde	2, 3-dihydroxy propanol
$CH_2OHCOCH_2OH$	Dihydroxyacetone	1,3-dihydroxy propanone
$CH_2OH(CHOH)_4CHO$	Glucose	2,3,4,5,6-pentahydroxyhexanal
$CH_2OH(CHOH)_3COCH_2OH$	Fructose	1,3,4,5,6-pentahydroxyhexan-2-one

---

## 7.4 MONOSACCHARIDES

---

The monosaccharides are again classified on the basis of two factors:

(1) By the carbonyl function. Those containing the aldehydic function, -CHO, are called aldoses. Others containing the keto group, -CO-, are called ketoses.

(2) By the number of Carbonyl atoms in the molecule. These monosaccharides containing 3,4,5,6 etc., carbon atoms are designated as trioses, tetroses, pentoses, hexoses, and so on.

Monosaccharides are polyhydric aldehydes and ketones which cannot be hydrolysed into simpler carbohydrates.

### 7.4.1 Structures of monosaccharides

The common monosaccharides are given in table.

Table. Monosaccharides

No of carbon atoms	Class	Molecular formula aldoses	Structural formula	Examples
3	aldotrioses	$C_3H_6O_3$	$CH_2OHCHOHCHO$	Glyceraldehyde
4	aldotetroses	$C_4H_8O_4$	$CH_2OH(CHOH)_2CHO$	Erythrose, Threose
5	Aldopentose	$C_5H_{10}O_5$	$CH_2OH(CHOH)_3CHO$	Arabinose, Ribose, Xylose, Lyxose
6	aldohexoses	$C_6H_{12}O_6$	$CH_2OH(CHOH)_4CHO$	Glucose, galactose, mannose, allose, talose, gulose, iodose, etc.
3	ketotrioses	$C_3H_6O_3$	$CH_2OHCOCH_2OH$	dihydroxyacetone
4	ketotetroses	$C_4H_8O_4$	$CH_2OHCOCHOHCH_2OH$	erythrulose
5	ketopentoses	$C_5H_{10}O_5$	$CH_2OHCO(CHOH)_2CH_2OH$	Ribulose, Xylulose
6	ketohehexoses	$C_6H_{12}O_6$	$CH_2OHCO(CHOH)_3CH_2OH$	Fructose, Sorbose, Tagatose, Psicose

### 7.4.2 Glucose

Glucose is most common monosaccharide. It is known as Dextrose because it occurs in nature principally as optically dextrorotatory isomer. Glucose is found in most sweet fruits, especially grapes (20-30%), and honey. It is an essential constituent of human blood. The blood normally contains 65 to 110 mg (0.06 to 0.1%) of glucose per 100 ml. In diabetic persons the

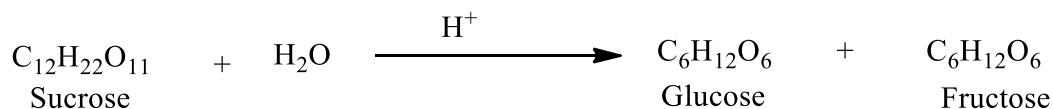


level may be much higher. In combined form glucose occurs in abundance in cane sugar and polysaccharides such as starch and cellulose.

## Preparation of Glucose

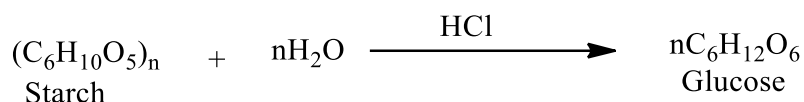
### 1. From sucrose (Cane sugar)

When sucrose is boiled with dilute HCl or H<sub>2</sub>SO<sub>4</sub> in alcoholic solution, glucose and fructose are obtained in equal amounts.



### 2. From Starch

Glucose is produced commercially by the hydrolysis of starch by boiling it with dilute H<sub>2</sub>SO<sub>4</sub> at high temperature under pressure.



In this process, an aqueous solution of starch obtained from corn is acidified with dilute H<sub>2</sub>SO<sub>4</sub>. It is then heated with high pressure steam in an autoclave. When the hydrolysis is complete, the liquid is neutralized with sodium carbonate to pH of 4-5. The resulting solution is concentrated under reduced pressure to get the crystals of glucose.

## Physical properties of glucose

Some important physical properties of glucose are mentioned as under:

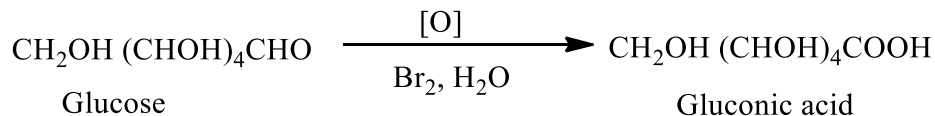
1. It is colourless sweet crystalline compound having m.p. 419 K.
2. It is readily soluble in water, sparingly soluble in alcohol and insoluble in ether.
3. It forms a monohydrate having m.p. 391 K.
4. It is optically active and its solution is dextrorotatory. The specific rotation of fresh solution is + 112° C.
5. It is about three fourth as sweet as sugarcane i.e., sucrose.

## Chemical properties of glucose

Chemical properties of glucose can be studied under the following headings:

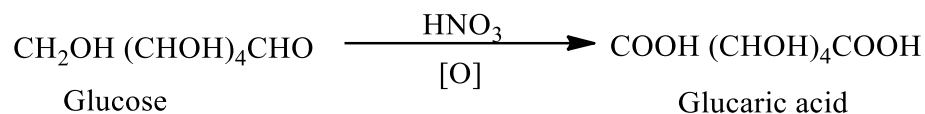
**(A) Reactions of aldehydic group**

1. **Oxidation.** (a) Glucose gets oxidized to gluconic acid with mild oxidizing agents like bromine water



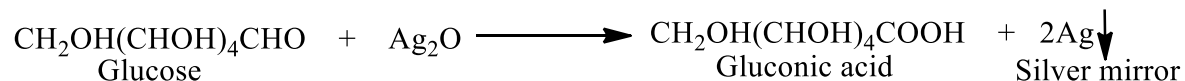
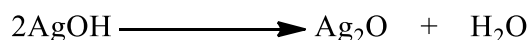
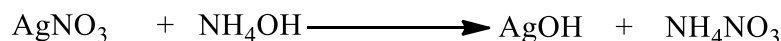
Only-CHO group is affected.

- (b) A strong oxidizing agent like nitric acid oxidizes both the terminal groups viz.  $-\text{CH}_2\text{OH}$  and  $-\text{CHO}$  groups and saccharic acid or glucaric acid is obtained.

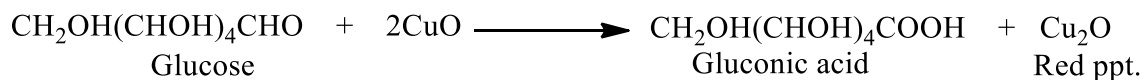
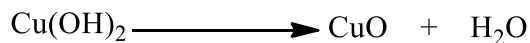
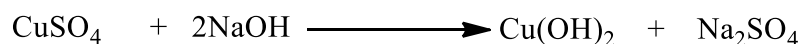


- (d)** Glucose gets oxidized to gluconic acid with ammonical silver nitrate (Tollen's reagent) and alkaline copper sulphate (Fehling solution). Tollen's reagent is reduced to metallic silver (silver mirror) and Fehling solution to cuprous oxide which is a red precipitate.

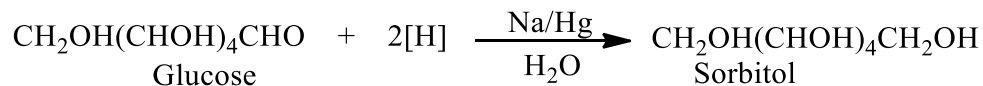
- (i) With Tollen's reagent



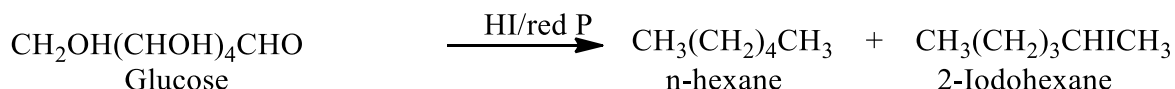
- (ii) With Fehling solution



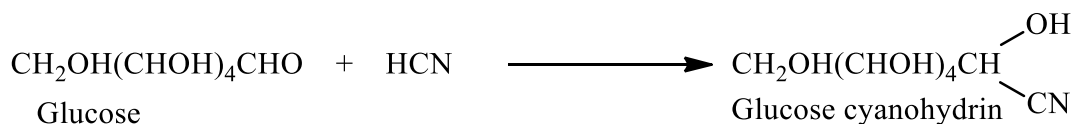
2. **Reduction** (a) glucose is reduced to sorbitol or Glucitol on treatment with sodium amalgam and water.



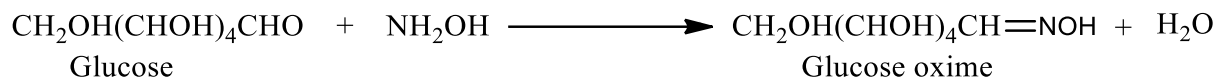
- (b) On reduction with conc. HI and red P at 373 K glucose gives a mixture of n-hexane and 2-iodohexane



3. **Reaction with HCN.** Like aldehydes, glucose reacts with HCN forming cyanohydrins.

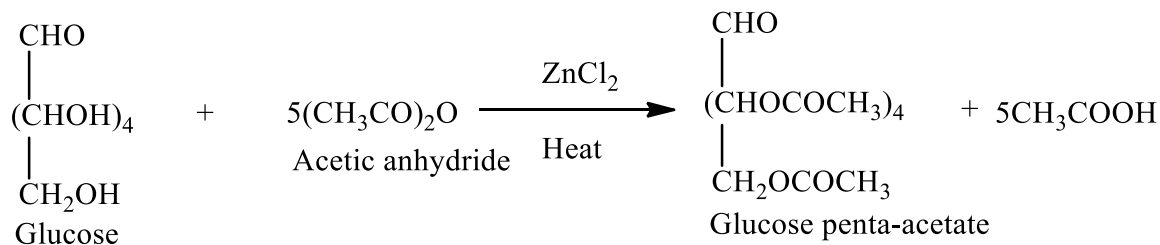


4. **Reaction with hydroxylamine.** Glucose forms glucose oxime.

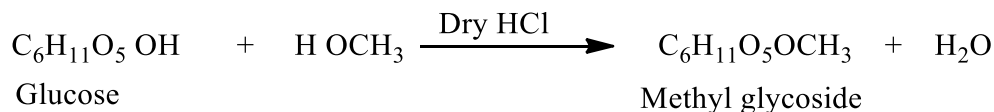


### (B) Reactions of hydroxyl groups

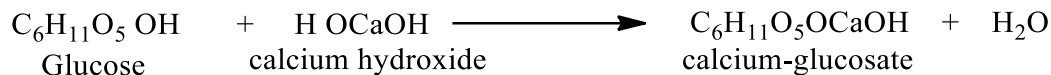
1. **Reaction with acetic anhydride or acetyl chloride.** Glucose forms penta acetate with acetic anhydride or acetyl chloride.



2. **Reaction with methyl alcohol.** Glucose reacts with methyl alcohol in the presence of dry HCl gas to form methyl glucoside.

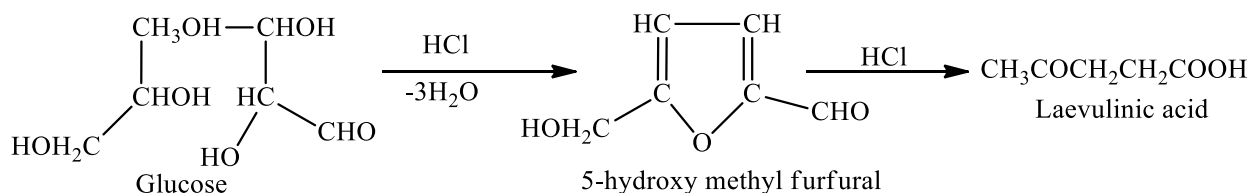


3. **Reaction with metallic hydroxides.** Glucose reacts with calcium hydroxide to form calcium glucosate which is water soluble.

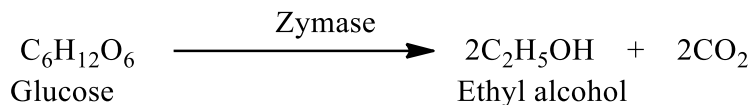


**(C) Miscellaneous reactions**

1. Action of acids. On warming with conc.HCl, glucose forms 5-hydroxy methyl furfural, which on further reaction gives laevulinic acid.

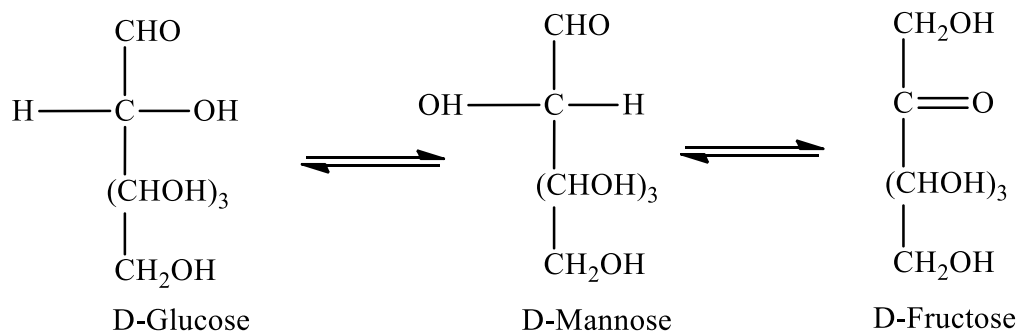


2. Fermentation. Glucose undergoes fermentation into ethyl alcohol in the presence of the enzyme zymase.

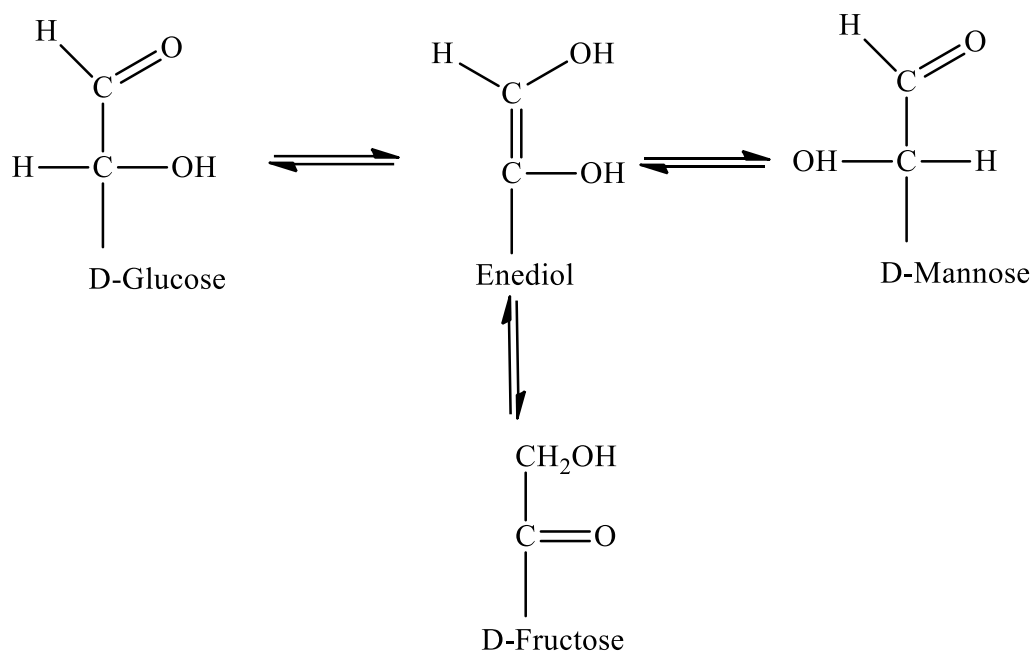


This reaction called alcoholic fermentation is the basis of manufacture of wines and alcohol.

3. Reaction with Alkalies. When warmed with strong sodium hydroxide solution, glucose forms a brown resinous product. In dilute alkali solution, D-glucose rearranges to give a mixture of D- glucose, D-mannose and d-fructose.



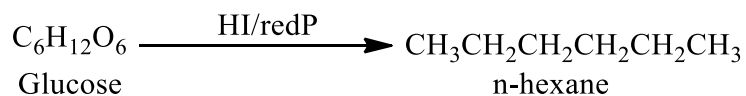
The above equilibrium is established via the enediol starting from any of these three hexoses.



That is why D-Fructose, although it has a ketonic C=O group, reduces Fehling's solution or Tollen's reagent. The rearrangement reaction of a monosaccharides in weakly alkaline solutions to give a mixture of isomeric sugars, is named as Lobry de Bruyn Van Ekestein rearrangement.

### Structure of glucose

1. On the basis of elemental analysis and molecular weight determination the molecular formula of glucose is  $\text{C}_6\text{H}_{12}\text{O}_6$ .
2. The reduction of glucose with red phosphorus and HI gives n-hexane.



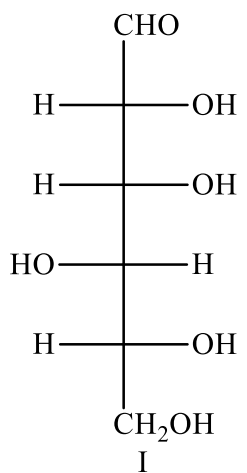
Therefore, the six carbon atoms of glucose form a straight chain.

3. It forms penta acetate on treatment with acetic anhydride which indicates the presence of five hydroxyl groups in the molecule.
4. Glucose reacts with hydroxyl amine to form an oxime and with hydrogen cyanide to form cyanohydrins. It indicates the presence of a carbonyl group. It also forms phenylhydrazone on treatment with phenylhydrazine.

- The mild oxidation of glucose with bromine water or sodium hypobromide yields a monocarboxylic acid (gluconic acid) containing same number of carbon atoms as in glucose, i.e., six. This indicates that the carbonyl group must be aldehyde group.
- The catalytic reduction of glucose gives a hexahydric alcohol (sorbitol) which gives hexaacetate on treatment with acetic anhydride. The sixth hydroxyl group must be obtained by the reduction of aldehyde group, thus further confirming the presence of an aldehyde group and five hydroxyl groups in glucose.
- Oxidation of gluconic acid with nitric acid yields a dicarboxylic acid (glucaric acid) with the same number of carbon atoms as in glucose. Thus besides aldehyde group, glucose must contain a primary alcoholic group also, which generates the second carboxylic group on oxidation.
- Glucose is a stable compound and does not undergo dehydration easily, indicating that not more than one hydroxyl group is bonded to a single carbon atom. Thus all the hydroxyl groups are attached to different carbon atoms.

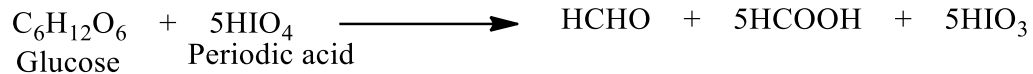
### Open –chain structure of glucose

On the basis of above reactions, Fisher assigned an open chain structure of glucose shown below as structure I



D-(+)-Glucose

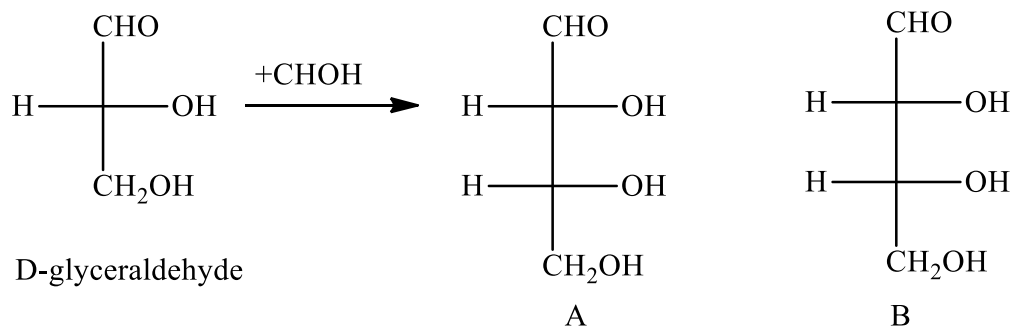
The above structure of glucose is also confirmed by the cleavage reaction of glucose with periodic acid. Five moles of periodic acid are consumed by one mole of glucose giving five moles of formic acid and one mole of formaldehyde.



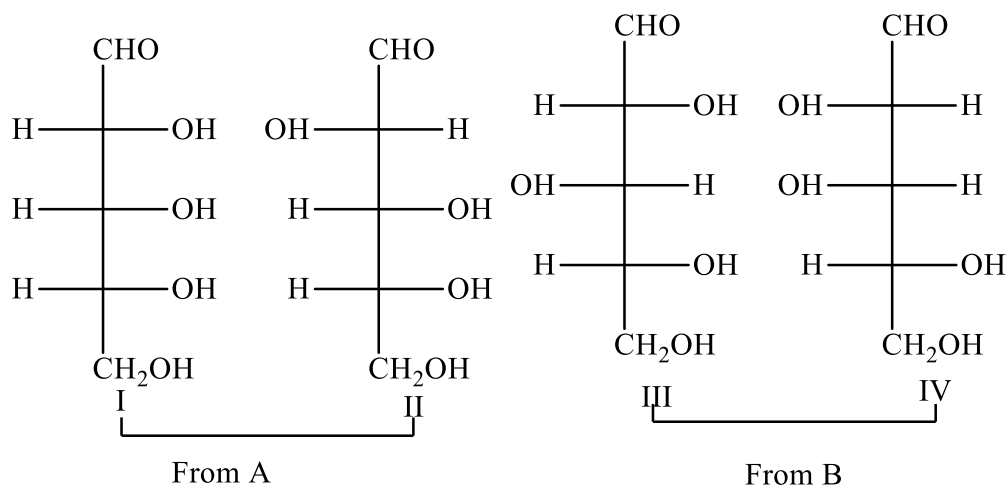
### Configuration of D-Glucose

The configuration of D-glucose was proved by Emil Fisher by arguments similar to the ones stated below.

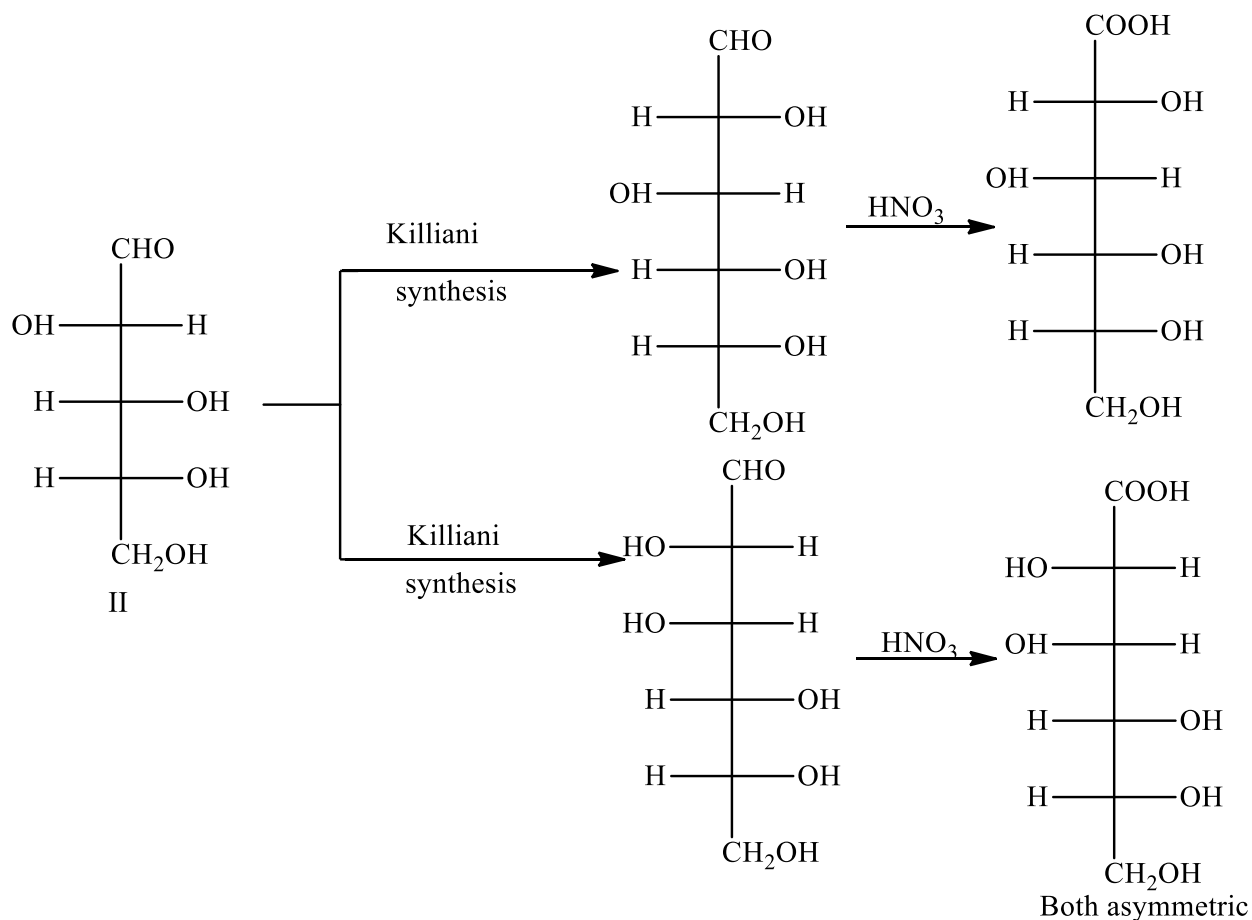
- Construction of four possible D-pentoses. Taking the configuration of D-glyceraldehyde as the standard, two possible D-aldotetroses (A and B) may be constructed by adding a CHOH just below CHO, placing OH to the right and then to the left.



Similarly, each of the two D-tetroses (A and B) gives two D-aldopentoses. Thus four possible D-aldopentoses are:



- D-Arabinose has configuration II or IV. Oxidation of D-arabinose with nitric acid oxidizes the terminal CHO and CH<sub>2</sub>OH groups yielding two optically active dicarboxylic acids. The forms II and IV can form two optically active diacids, while I and III can give meso acids only that have a plane of symmetry, therefore, D-arabinose is either II or IV.
- Configuration II confirmed for D-arabinose. D-arabinose by Killiani-Fisher synthesis yields two epimeric aldohexoses, D-glucose and D-mannose. These of oxidation with nitric acid form two optically active dicarboxylic acids. This is theoretically possible only if D-arabinose has the configuration II and not IV.

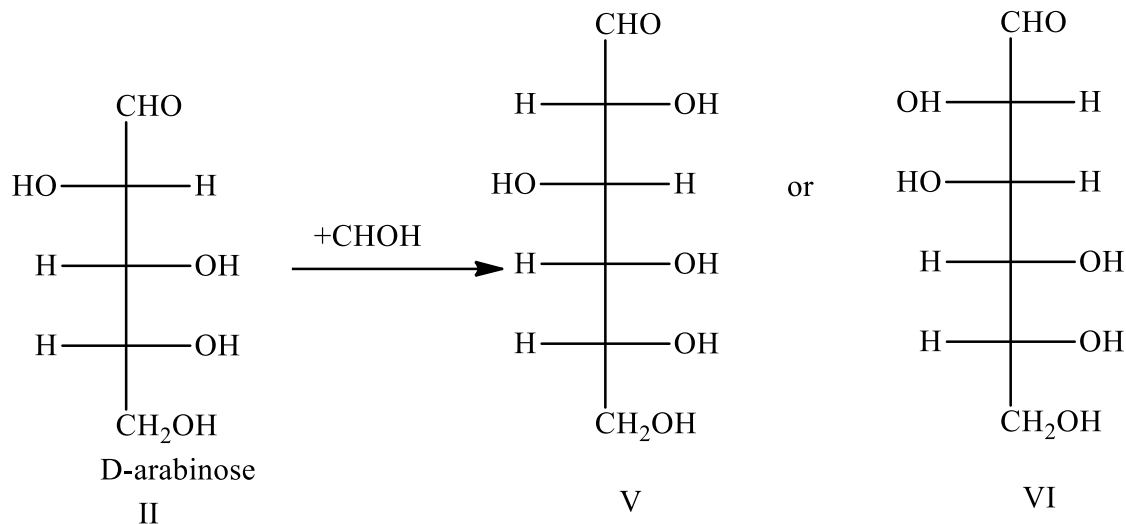


Proceeding similarly, you will find that if D-arabinose had configuration IV, of the two dicarboxylic acids derived from it, one would be meso and one asymmetric. Hence D-arabinose has the configuration II.

- Ruff degradation of D-glucose and D-mannose produces D-arabinose in each case. In ruff degradation the CHOH below CHO is destroyed. Therefore, the configuration of the two

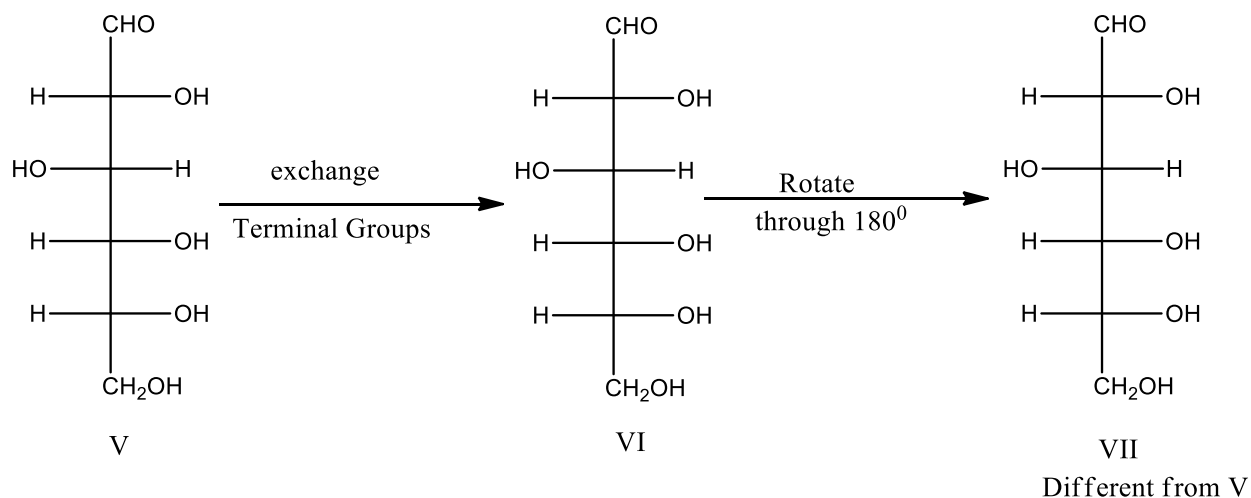


aldohexoses, D-glucose and D-mannose, can be derived by adding a new CHOH below CHO in form II of D-arabinose.



Hence D-glucose has configuration V or VI.

5. D-Glucose and L-Glucose yield the same dicarboxylic acid. This means that two sugars differ only in respect of the position of the terminal groups (CHO and CH<sub>2</sub>OH). Therefore, the exchange of the terminal groups in D-glucose should be able to give a different aldohexose (L-glucose). Let us now examine configuration formula V and VI (one of which is D-glucose) from the angle.



If VII is rotated through 180° in the plane of paper, it gives an aldohexose VII, different from V. a similar procedure with formula VI does not give rise to a different sugar.

From the above arguments it is evident that D-glucose has the configuration as shown by the form V.

### Cyclic structure of D-Glucose

The open chain structure of glucose explained most of its properties. However, it could not explain the following facts.

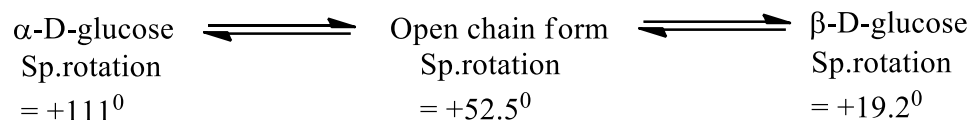
1. Despite having an aldehyde group, glucose does not undergo certain characteristic reactions of aldehyde,
  - (a) Glucose does not react with sodium bisulphate to form addition product.
  - (b) Glucose does not react with ammonia.
  - (c) Glucose does not give Schiff's test and 2, 4-DNP test like other aldehydes.
2. Glucose reacts with hydroxylamine to form an oxime but glucose pentaacetate does not react with hydroxylamine. This shows that  $-CHO$  group is not present in glucose pentaacetate.
3. **D (+)-Glucose exist in two stereoisomeric forms i.e.,  $\alpha$ - D (+)-Glucose and  $\beta$ - D (+)-Glucose.** These two forms are crystalline and have different m.p and optical rotations. When glucose was crystallized from a concentrated solution at 303 K, it gave  $\alpha$ -form of glucose having m.p 419 K and  $[\alpha]_D = +111^\circ$ . On the other hand, the  $\beta$ -form of glucose is obtained on crystallization of glucose from a hot saturated solution of at a temperature above 371 K. The  $\beta$ -form of glucose has m.p 423 K and  $[\alpha]_D = +19.2^\circ$ .
4. **Mutarotation.** When either of two forms of glucose ( $\alpha$ - D-glucose and  $\beta$ - D-glucose) are dissolved in water and allowed to stand, these get slowly converted into other form and a equilibrium mixture of both  $\alpha$ - D-glucose (36 %) and  $\beta$ - D-glucose (about 64%) is formed.

The formation of equilibrium mixture can be explained as:

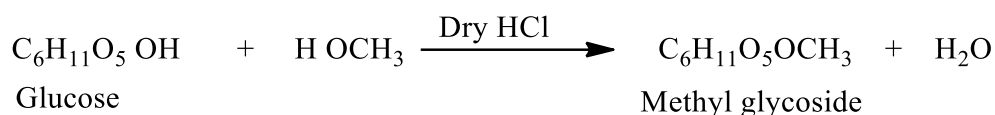
The  $\alpha$ - D-glucose has a specific rotation of  $+111^\circ$ , while  $\beta$ - D-glucose has a specific rotation of  $+19.2^\circ$ . When  $\alpha$ -form is dissolved in water, its specific rotation falls until a constant value of  $+52.5^\circ$  is reached. On the other hand, when  $\beta$ -form is dissolved in water, its specific rotation increases and becomes constant at  $52.5^\circ$ .

This spontaneous change in specific rotation of an optically active compound with time to an equilibrium value is called mutarotation. (Latin, mutare means to change).

Thus, there is an equilibrium mixture of  $\alpha$ - and  $\beta$ -forms in the solution



5. Glucose forms isomeric methyl glucosides. When glucose is heated with methanol in the presence of dry HCl, it gives two isomeric monomethyl derivatives known as  $\alpha$ -D-glucoside (m.p. = 438 K) and  $\beta$ -D-glucoside (m.p. 380 K).



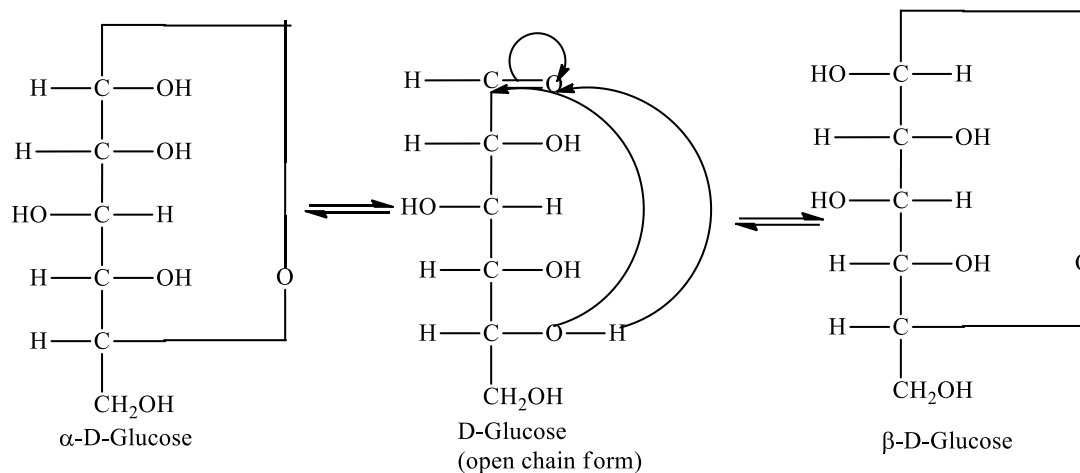
These two glucosides do not reduce Fehling's solution and also do not react with HCN or  $\text{NH}_2\text{OH}$  indicating that the free  $-\text{CHO}$  group is not present but it is converted to  $-\text{COOH}$  group.

### Cyclic structure of Glucose

#### Anomers:

Glucose forms a hemiacetal between the  $-\text{CHO}$  group and the  $-\text{OH}$  group on the  $\text{C}_5$  atom. As a result, of cyclisation,  $\text{C}_1$  becomes asymmetric (chiral) and the newly formed  $-\text{OH}$  group may be either on the left or on the right in Fisher projection formulae. These results in the formation of two isomers which differ in the orientation of H and  $-\text{OH}$  groups around  $\text{C}_1$  atom. These isomers are known as  $\alpha$ - D-glucose and  $\beta$ - D-glucose. The isomer having the  $-\text{OH}$  group on the right is called  $\alpha$ - D-glucose and one having the  $-\text{OH}$  group on the left is called  $\beta$ - D-glucose. Such pairs of optical isomers which differ in the configuration only around  $\text{C}_1$  atom are called anomers.

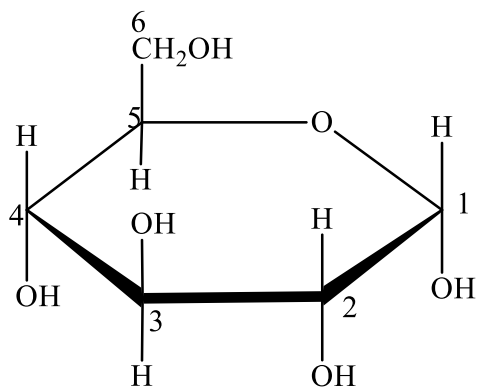
These two forms are not mirror image of each other, hence are not enantiomers. The  $\text{C}_1$  carbon is known as anomeric carbon or glycosidic carbon.



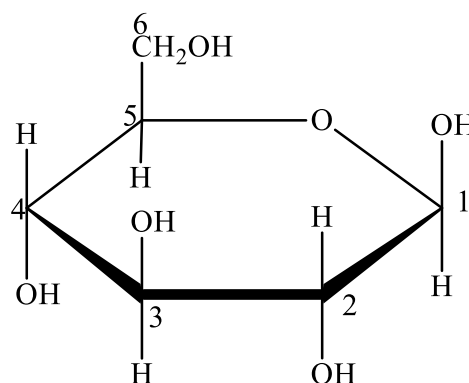
The above representations are called Fisher projection formulae.

### Haworth projection formulae or pyranose structures of D-Glucose.

In Haworth structures drawn with the heterocyclic oxygen in the upper right corner, the  $\alpha$ -form has the  $-\text{OH}$  group on  $\text{C}_1$  pointing “down”. The  $\beta$ -form has the same group pointing “up”. For D-sugars, the free  $-\text{CH}_2\text{OH}$  group of an aldohexose is drawn above the plane of ring when ring oxygen is in the upper right. The rest is the simple, the groups on the left of the Fisher projection are up and those on the right are down in the Haworth structure.



$\alpha$ -D-Glucose  
 or  
 $\alpha$ -D-Glucopyranose



$\beta$ -D-Glucose  
 or  
 $\beta$ -D-Glucopyranose

## Fructose

Fructose is another commonly known monosaccharide having the same molecular formula as glucose. It is laevorotatory because it rotates plane polarized light towards the left. It is present abundantly in fruits. That is why it is called fruit-sugar also.

### Physical properties

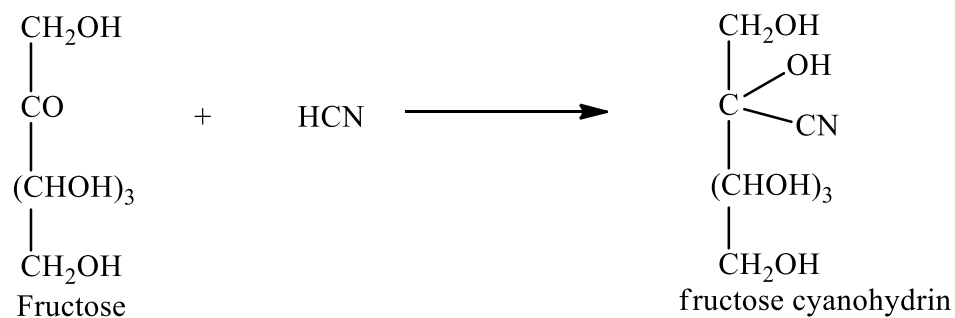
1. It is sweetest of all known sugars.
2. It is readily soluble in water, sparingly soluble in alcohol and insoluble in ether.
3. It is white crystalline solid with m.p. 375 K.
4. Fresh solution of fructose has a specific rotation  $-133^{\circ}$ .

### Chemical properties of fructose

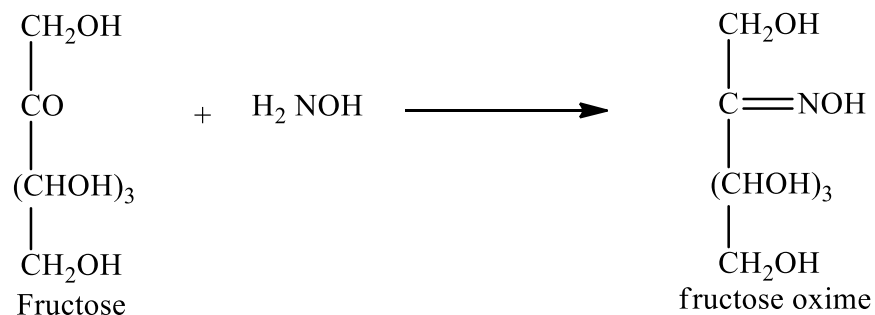
Chemical properties of fructose can be studied under the following heads:

#### (A) Reactions due to ketonic group

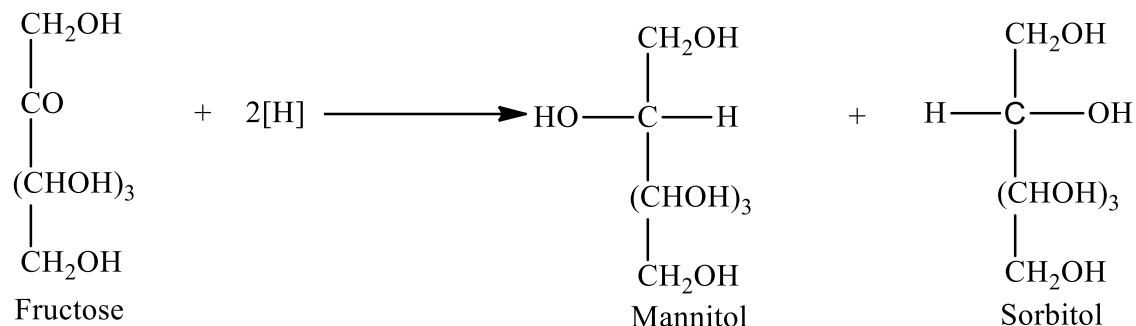
1. **Reaction with HCN.** Fructose reacts with HCN to form cyanohydrins.



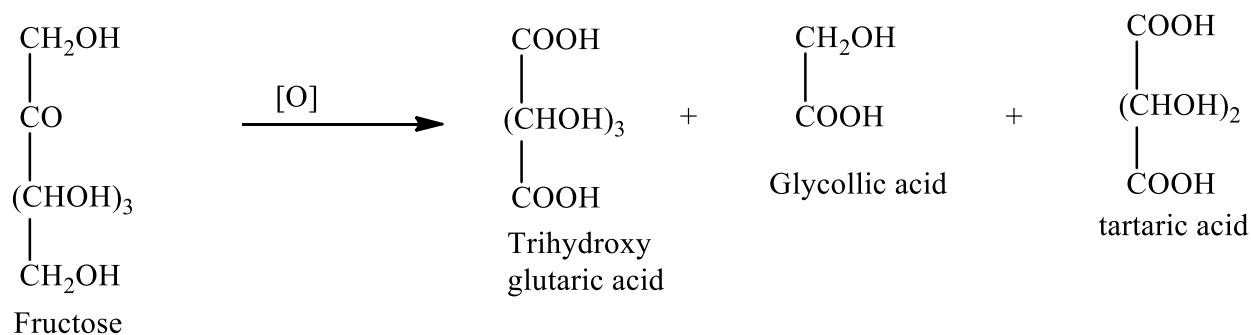
2. **Reaction with hydroxylamine.** Fructose reacts with hydroxylamine to form an oxime.



3. **Reduction.** Fructose gives a mixture of sorbitol and mannitol on reduction with Na-Hg and water or catalytic hydrogenation.



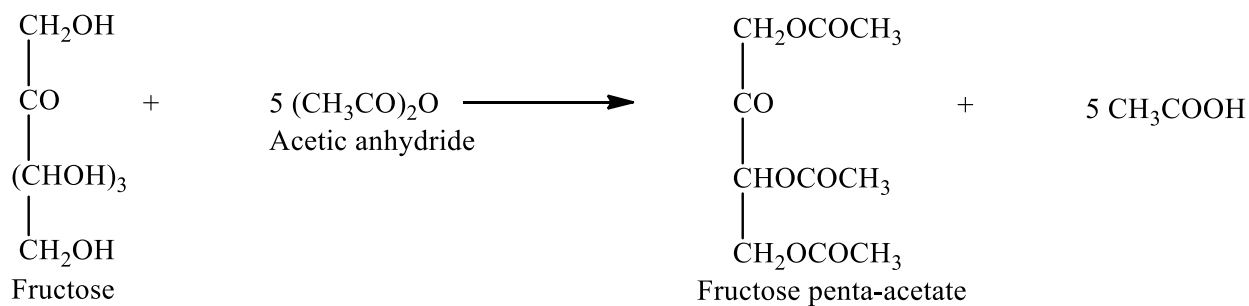
4. **Oxidation.** (i) there is no action of mild oxidizing agent like bromine water on fructose.  
(ii) Strong oxidizing agents like nitric acid oxidize fructose into a mixture of trihydroxy glutaric, glycolic and tartaric acids.



- (iii) Unlike other ketones, it reduces Tollen's reagent and Fehling solution. This is due to the presence of traces of glucose in alkaline medium.

### [B] reactions of the alcoholic group

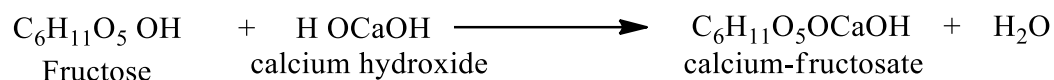
1. **Acetylation** . with acetic anhydride or acetyl chloride, fructose forms penta-acetate.



**2. Reaction with methyl alcohol (glucoside formation).** Fructose reacts with methyl alcohol in the presence of dry HCl gas forming methyl fructoside.



**3. Reaction with metallic hydroxides (fructosate formation)**



### Structure of Fructose

1. elemental analysis and molecular weight determination of fructose show that it has the molecular formula  $\text{C}_6\text{H}_{12}\text{O}_6$ .

2. fructose on reduction gives sorbitol which on reduction with HI and red P gives a mixture of n-hexane and 2-Iodohexane. This reaction indicates that six carbon atoms in fructose are in a straight chain.

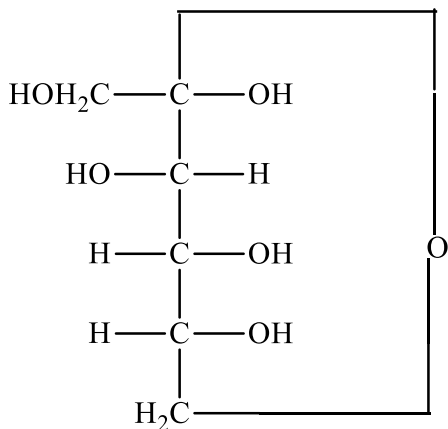
3. Fructose reacts with hydroxylamine, HCN and phenylhydrazine. It shows the presence of  $\text{-CHO}$  or  $\text{C=O}$  group in the molecule of fructose.

4. On treatment with bromine water, no reaction takes place. This rules out the possibility of presence of  $\text{-CHO}$  group.

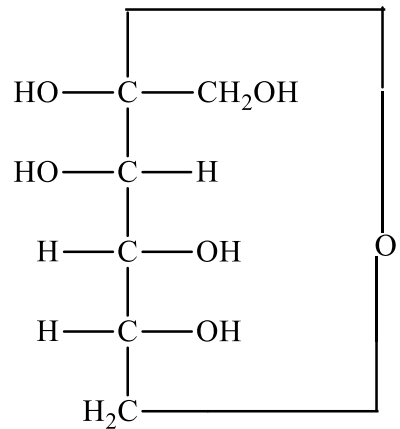
5. on oxidation with nitric acid, it gives glycollic acid and tartaric acids which contain smaller number of carbon atoms than fructose. This shows that a ketonic group is present at position 2. It is at this point that the molecule is broken.

### Cyclic structure of D-Fructose

Fructose shows the property of mutarotation. This means that it exists in two forms  $\alpha$ -fructose and  $\beta$ -fructose which are cyclic in structure and change into each other via the open chain structure. The cyclic and pyranose structures of  $\alpha$ -D-fructose and  $\beta$ -D-fructose are represented below:

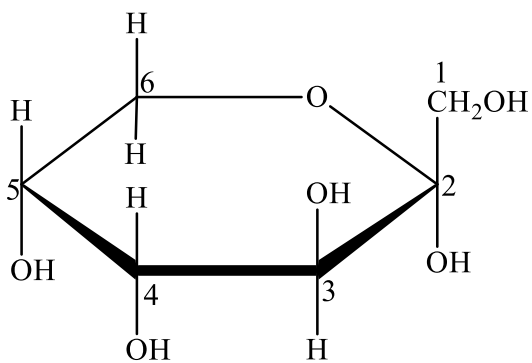


$\alpha$ -D-fructose

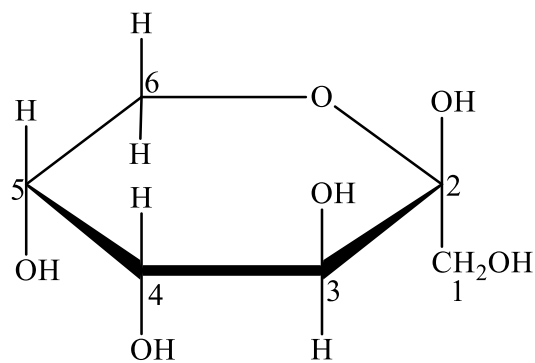


$\beta$ -D-fructose

Haworth Pyranose structure

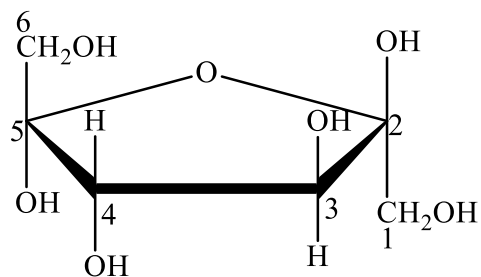


$\alpha$ -D-fructopyranose



$\beta$ -D-fructopyranose

However, when fructose is linked to glucose in a sucrose molecule, it has the furanose structure as shown below:



$\beta$ -D-fructofuranose

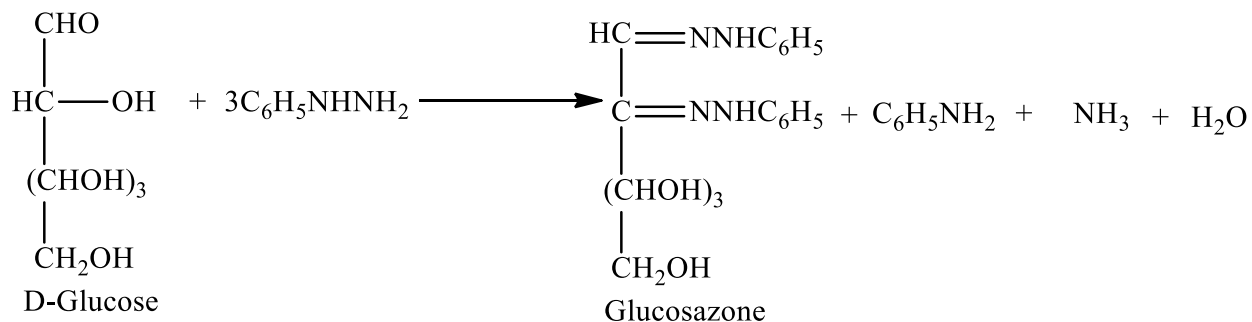
---

## 7.5 MECHANISM OF OSAZONE FORMATION

---

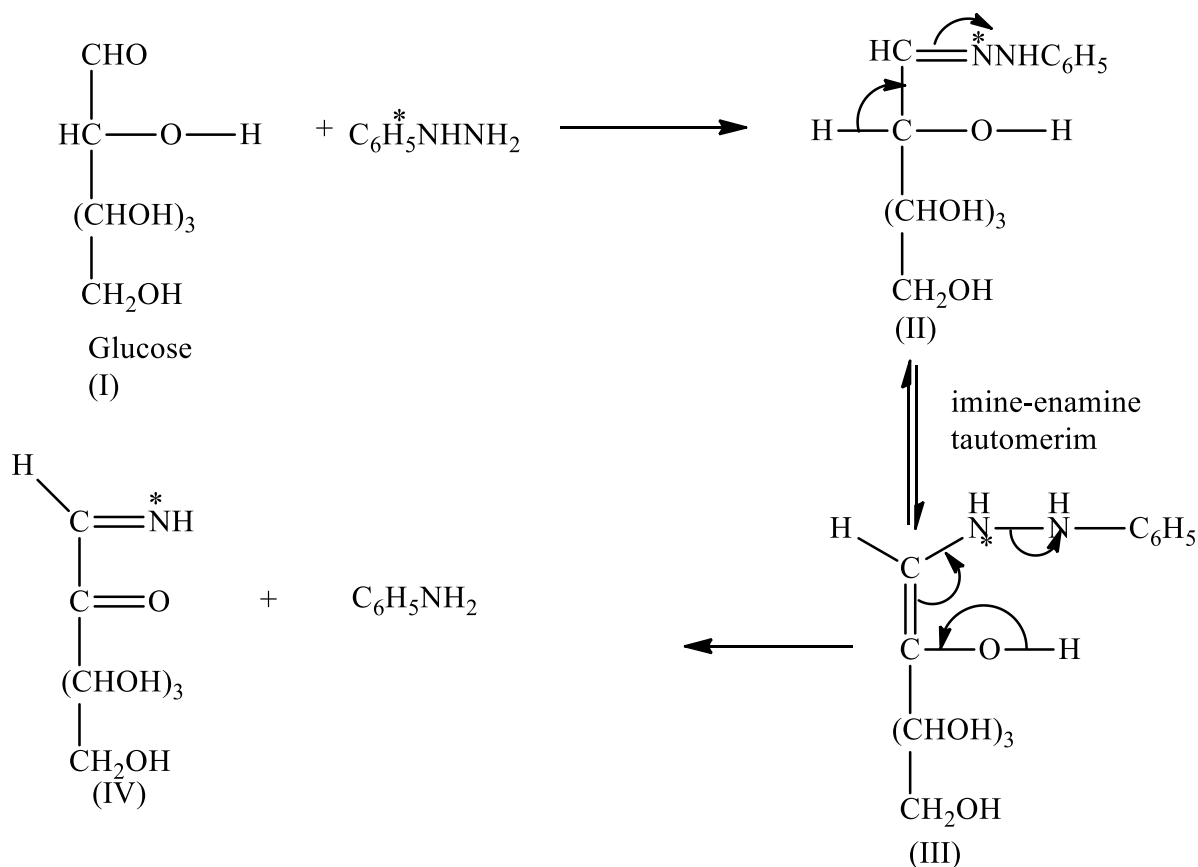


Glucose and fructose react with one equivalent of phenylhydrazine, forming phenylhydrazone. In contrast,  $\alpha$ -hydroxy carbonyl compounds react with three equivalents of phenylhydrazine to form bis-phenylhydrazones, commonly called osazones.



Phenylosazones crystallize readily and are useful derivatives for identifying sugars.

**Mechanism:** the first equivalent of phenylhydrazine forms phenylhydrazone with the aldehyde or ketone group as expected. Phenylhydrazone then undergoes the rearrangement, known as Amadori rearrangement, to give  $\alpha$ -iminoketone (IV) with the loss of aniline.



Subsequent attack of two moles of phenylhydrazine on the iminoketone (scheme-a) or on the ketoaldehyde (scheme-b) results in the formation of osazone accompanied by the elimination of ammonia.

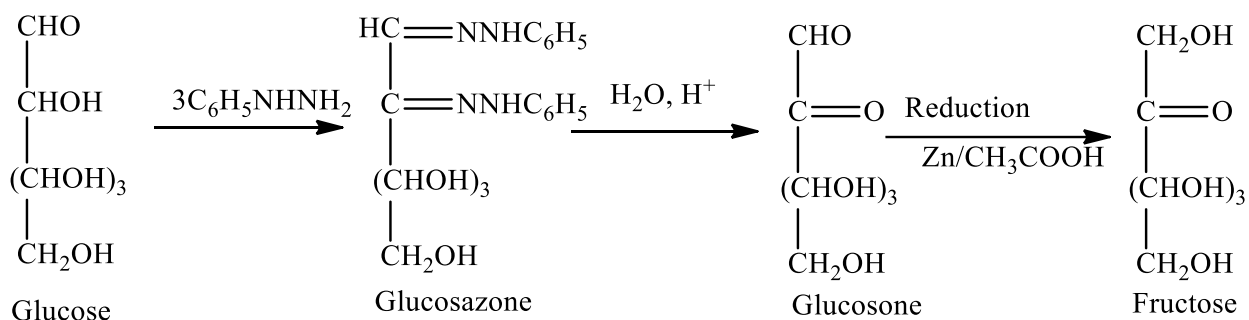
The given mechanism is supported by the observation that when phenyl hydrazone prepared by the reaction of glucose with  $N^{15}$  ( $N^*$ ) labeled phenylhydrazine is treated with ordinary phenylhydrazine, unlabelled osazone is obtained accompanied by the expulsion of labelled ammonia.

---

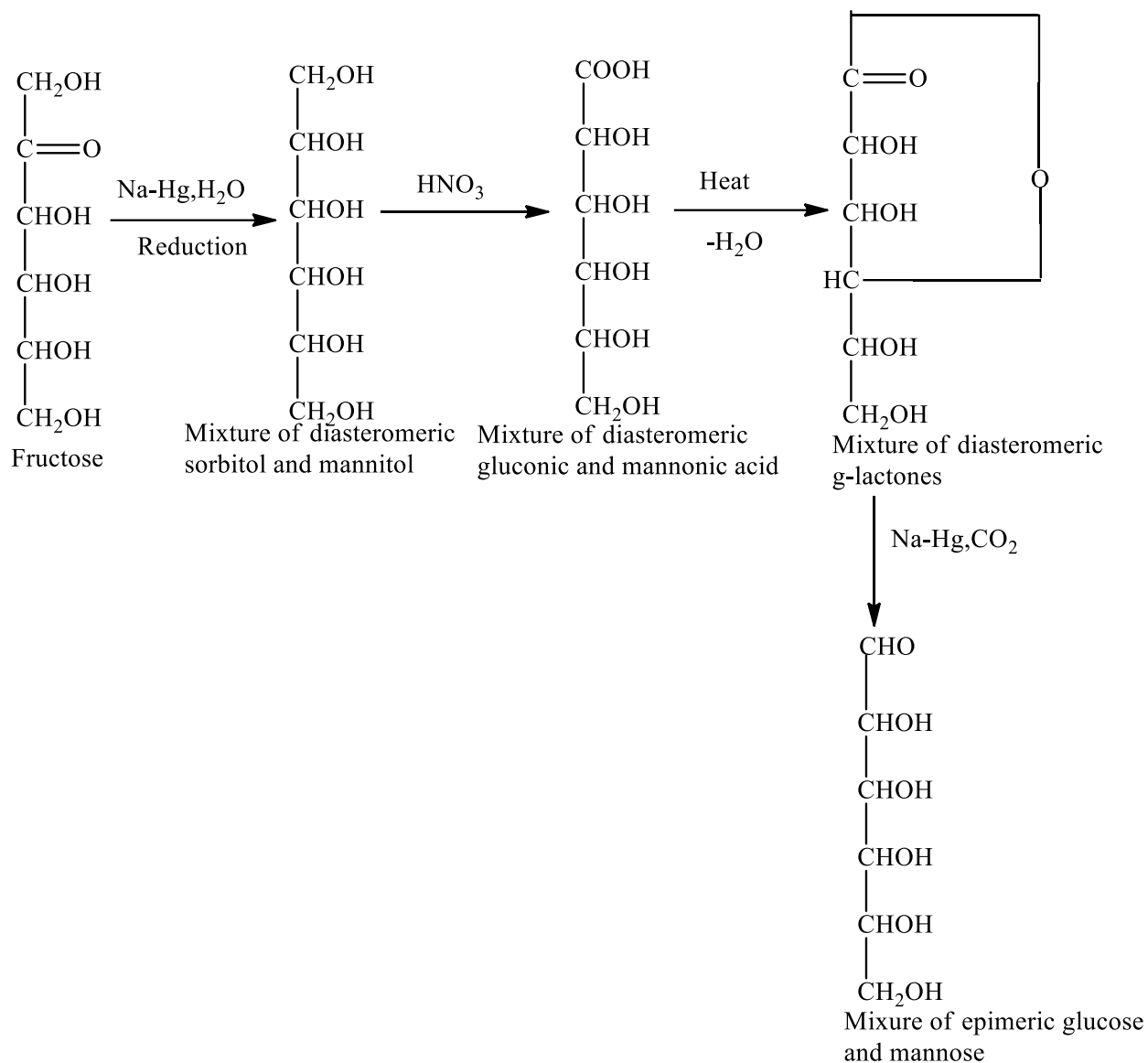
## 7.6 INTERCONVERSION OF GLUCOSE AND FRUCTOSE

---

(a) Conversion of an aldose into an isomeric ketose. The procedure used for this purpose may be illustrated by taking into account the conversion of glucose into fructose.



(b) Conversion of ketose into an isomeric aldose. The procedure used here may be illustrated by taking into account the conversion of fructose into a mixture of epimeric aldoses, viz., glucose and mannose.




---

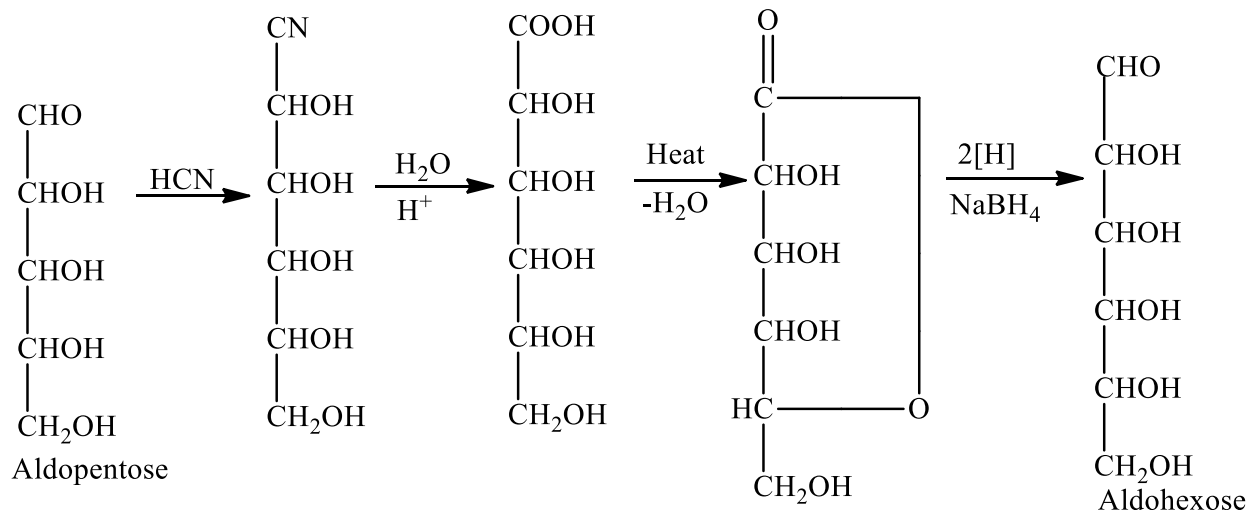
## 7.7 CHAIN LENGTHENING AND CHAIN SHORTENING OF ALDOSE

---

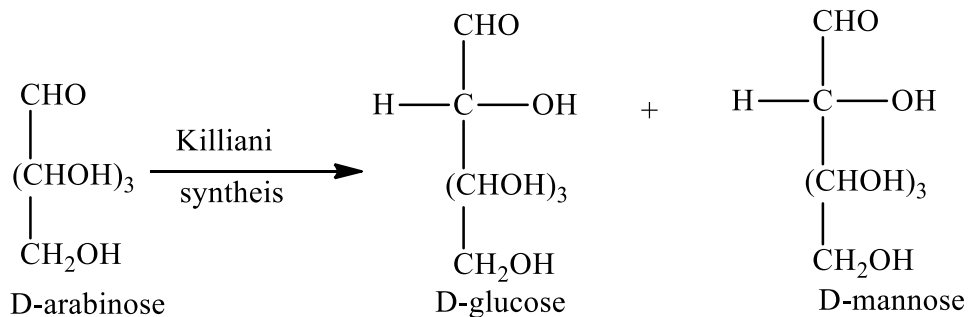
### (a) Lengthening of aldoses: Killiani-Fisher synthesis

The aldose chains may be lengthened by one carbon atom by a procedure known as **Killiani-Fisher synthesis**. Thus an aldose may be converted to the next higher member by the following steps: (1) Formation of cyanohydrins; (2) hydrolysis of  $-\text{CN}$  to  $-\text{COOH}$ , giving aldonic acid; (3) conversion of aldonic acid to lactone by heating; (4) reduction of lactone with sodium

borohydride,  $\text{NaBH}_4$ , to get higher aldose. For illustration, the overall change is the creation of an asymmetric centre at C-2 where a new  $\text{CHOH}$  has been added. Therefore their result two aldoses with one carbon more and differing only in configuration at C-2.



Taking a specific example, D-arabinose by killiani-Fisher synthesis gives two isomeric aldohexoses, D-glucose and D-mannose which differ only in the configuration at C-2

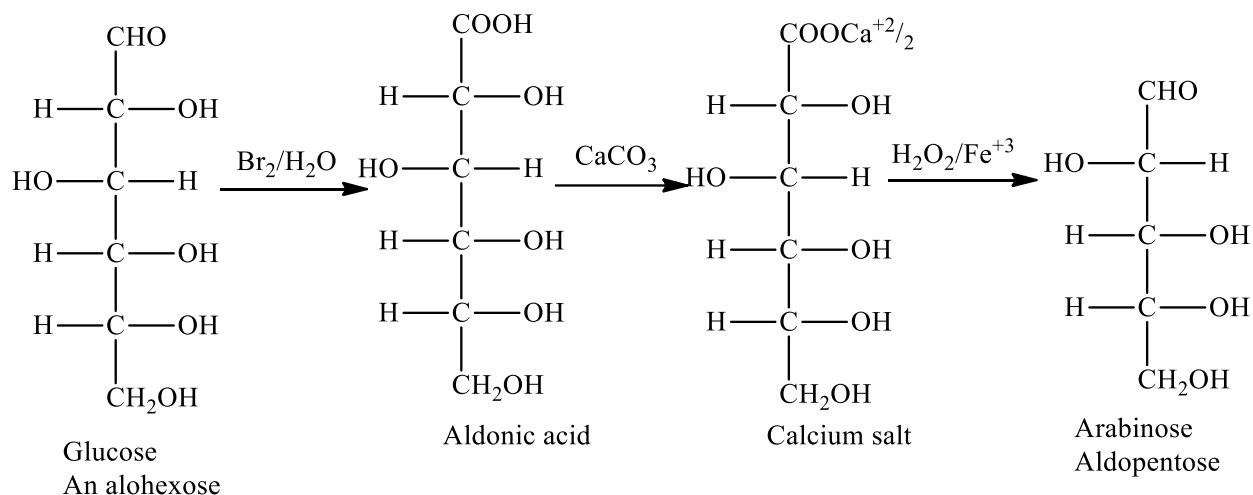


Such sugars which differ in configuration only at one asymmetric centre (C-2) are called Epimers.

### (b) Shortening of aldoses

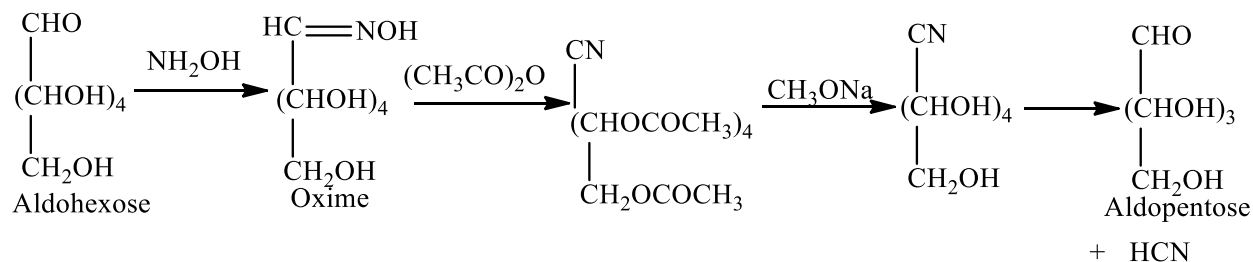
**(1) Ruff degradation.** An aldose may be converted into a lower aldose having one carbon atom less, i.e., the carbon chain may be shortened by Ruff degradation.

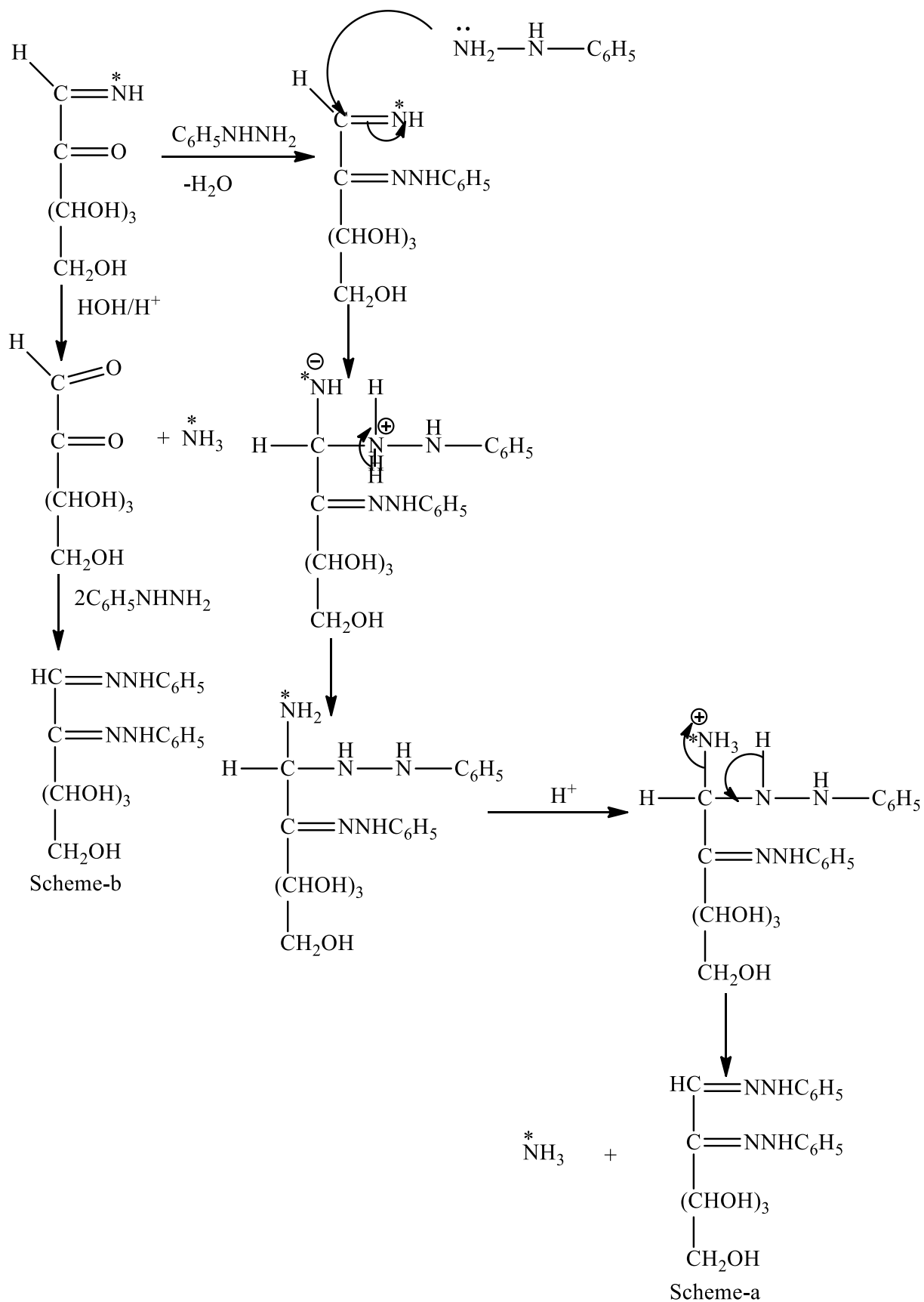
The method involves the oxidation of starting aldose into the corresponding aldonic acid. The acid is converted into its calcium salt which is treated with Fenton's reagent (H<sub>2</sub>O<sub>2</sub> in presence of Fe<sup>+3</sup> ion) to get the lower aldose. This method is illustrated as follows:



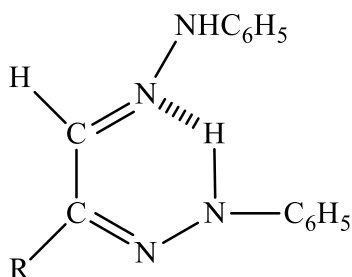
## (2) Wohl's degradation for chain shortening in aldoses

In this degradation, the aldose is converted into its oxime by treatment with hydrogradaozoxylamine. The oxime is treated with acetic anhydride when the oxime is dehydrated to nitrile. The nitrile is then treated with sodium methoxide. The cyanohydrin obtained undergoes degradation to a lower aldose. The reaction are written as under.





The osazone so formed does not undergo further Amadori rearrangement. This is the reaction with phenylhydrazine stops at this stage; thus further reaction at C-3 –OH group does not occur. This is because the osazone so formed, does not react further via intramolecular Amadori rearrangement involving C-3 –OH group because of the intramolecular hydrogen bonding as shown below:




---

## 7.8. SUMMARY

---

- Carbohydrates are poly hydroxy aldehydes and ketones.
- Monosaccharides containing an aldehyde group are called aldoses and those with a keto group are called ketoses.
- Carbohydrates can also be classified as disaccharides, oligosaccharides, and polysaccharides consist of monosaccharides linked by glycosidic bonds.
- The most abundant monosaccharide in nature is 6- carbon sugar, D-glucose. It exists as  $\alpha$  and  $\beta$  anomers with different optical rotations.
- If two monosaccharides isomers differ in configuration around one specific carbon atom [With exception of carbonyl carbon] they are called epimers of each other.

---

## 7.9. MODEL EXAMINATION QUESTIONS

---

1. Define and classify carbohydrates with suitable examples.
2. Explain Kiliani-Fischer synthesis and Ruff's degradation.
3. Explain the limitations of open chain D-glucose structure.
4. Establish the structure of glucose and fructose.

---

## ***REFERENCES***

---

1. A text book of organic chemistry, A. Bahl and B.S.Bahl, S.Chand & Compant Ltd.
2. Chemistry for degree students, R.L.madan, S.Chand & Compant Ltd.
3. Organic chemistry, Vol.III, Jagdamba singh and L.D.S Yadav, Prgati Prakashan.
4. Modern chemistry, S.P.Jauhar, Modern Publishers.
5. Organic chemistry, Francis A.Carey, Tata McGraw-Hill Company Ltd.



---

## UNIT-8 CARBOHYDRATES-II

---

### **CONTENTS**

8.1 Objectives

8.2 Introduction

8.3. Configuration of monosaccharides

8.4. Erythro and threo distereomers conversion of glucose

8.5 ethers and esters

8.6. Determination of ring size of monosaccharides

8.7. Cyclic structure of D-glucose

8.8. Mechanism of mutarotation

8.9. General study of disaccharides

8.10. General introduction of structure of ribose and deoxyribose

8.11. General study of polysaccharides

8.12 Summary

8.13. Model examination questions

---

### ***8.1 OBJECTIVES***

---

After going through this unit you will be able to:

- Know about configuration of monosaccharides
- Discuss about Erythro and threo distereomers conversion of glucose
- Describe ether and ester formation,
- Determination of ring size of monosaccharides,
- Cyclic structure of D-glucose

- Mechanism of mutarotation
- Types of disaccharides and their properties
- Structure of ribose and deoxyribose
- Polysaccharides and its types

---

## 8.2 INTRODUCTION

---

The carbohydrates are an important class of naturally occurring organic compounds. They occur naturally in plants (where they are produced photosynthetically), when the word "carbohydrate" was coined, it originally referred to compounds of general formula  $C_n(H_2O)_n$ . However, only the simple sugars or monosaccharides fit this formula exactly. The other types of carbohydrates, oligosaccharides, and polysaccharides, are based on monosaccharide units and have slightly different general formula. Carbohydrates also called "saccharides" which means sugar in Greek.

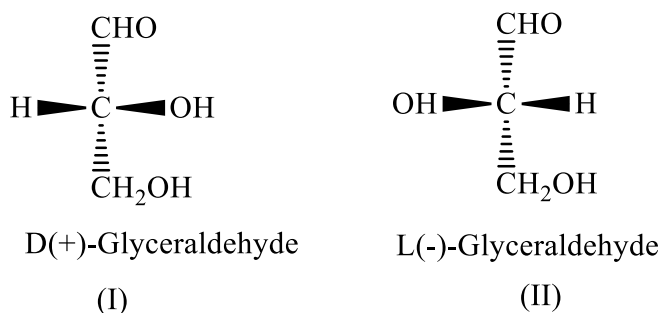
Many commonly encountered carbohydrates are polysaccharides, including glycogen, which is found in animals, and starch and cellulose, which occur in plant.

---

## 8.3 CONFIGURATION OF MONOSACCHARIDES

---

In early days of development of stereochemistry of organic compounds, it was not possible to determine the absolute configurations. The chemists were only interested in knowing the relative configurations. To decide about configurations, Emil Fisher in 1885 chose glyceraldehyde ( $CHOCHOHCH_2OH$ ) as the standard substance and fixed its relative configurations arbitrarily. This compound exists in two enantiomeric forms, as given below:



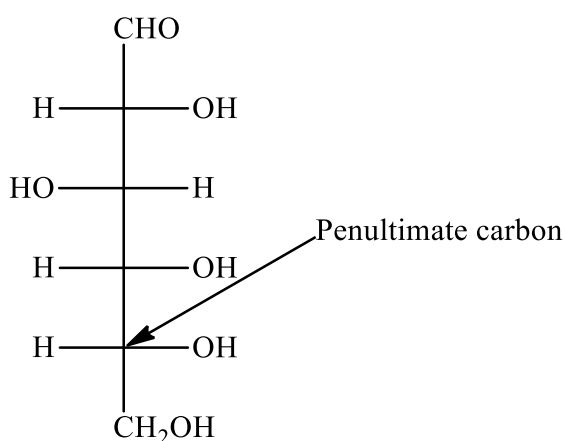
Compound I was found to be dextrorotatory and compound II was found to be laevorotatory. The difference between configuration of the two compounds is that in compound (I), -H is located

on the L.H.S and –OH is located on the R.H.S. of the Fisher projection formula while in compound (II), this is in reverse order.

Configuration of other compounds was then assigned by relating their configuration to that of D- or L-Glyceraldehyde.

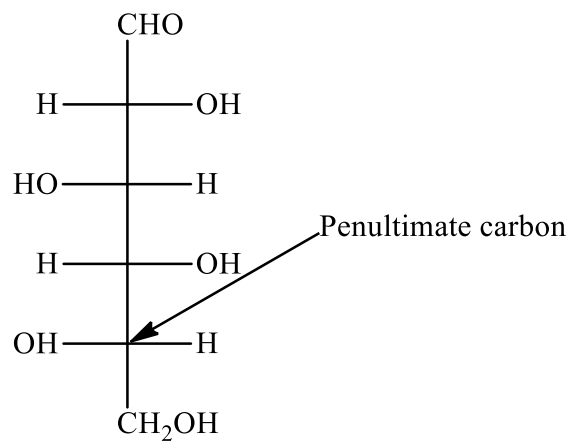
In 1951 Bijvoet using x-ray crystallography established that the arbitrarily assigned configurations of glyceraldehydes actually represented their correct absolute configurations. Thus, if the configuration of glyceraldehydes were correct, the derived relative configurations of other compound must also be their correct absolute configuration.

Thus D- and L- glyceraldehydes serve as reference molecule for all the monosaccharides. A monosaccharide whose penultimate carbon (farthest chiral carbon atom from most oxidizing end i.e, -CHO) has the same configuration as D-Glyceraldehyde has L-configuration. Similarly , amonosaccharide whose penultimate carbon has the same configuration as L-Glyceraldehyde has L-configuration. This is illustrated with the help of following examples.



**D-configuration**

(because the configuration at penultimate carbon is the same as that of D-Glyceraldehyde)



**L-configuration**

(because the configuration at penultimate carbon is the same as that of L-Glyceraldehyde)

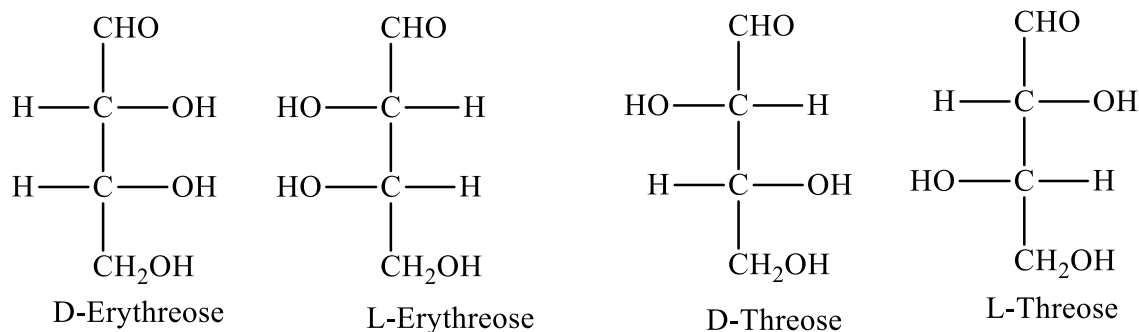
---

## ***8.4. ERYTHRO AND THREO DIASTEROMERS CONVERSION OF GLUCOSE***

---

Erythro and Threo system of nomenclature is used only in aldotetroses. Aldotetrose have two chirality centres and therefore four stereoisomers. Two of the sttereoisomers are D-sugars

and two are L-sugars. When Fischer projections are drawn for stereoisomers with two adjacent chirality centres, the pair of enantiomers with similar groups on the same side of the carbon chain is called the erythro enantiomers. The pair of enantiomers with similar groups on opposite sides are called the threo enantiomers. The names of erythro and threo pairs of enantiomers in fact, originated from the name of aldotetroses, erythrose and threose.

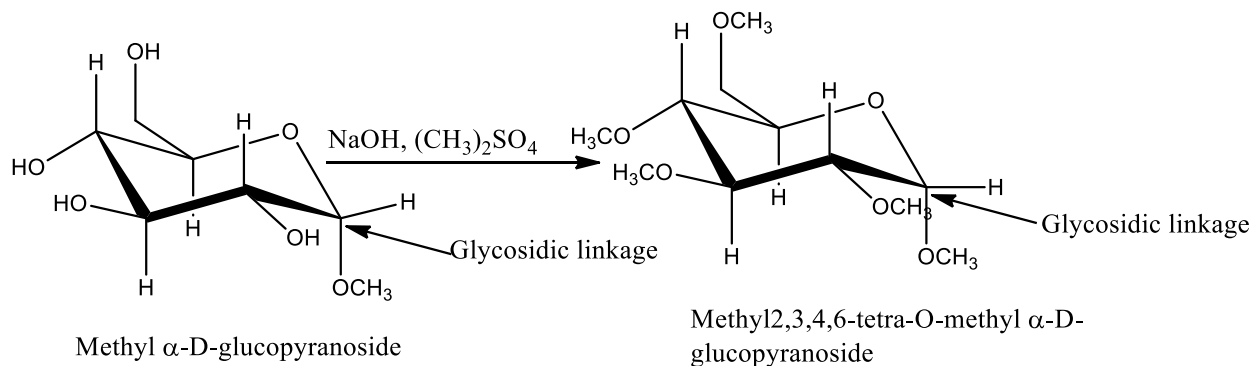


Erythrose and threose are diastereomers.

## 8.5. ETHERS AND ESTERS

### (a) Formation of ethers

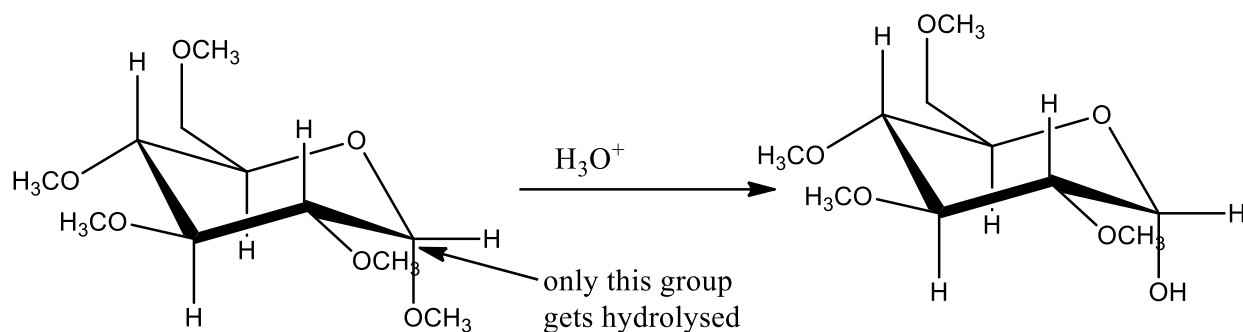
It is possible to convert the -OH groups attached to carbons other than anomeric carbon into alkyl derivatives having ordinary ether C-O-C linkages. For example methyl glucoside can be converted into pentamethyl derivative by treatment with excess dimethyl sulphate in aqueous sodium hydroxide. The function of sodium hydroxide is to convert hydroxyl groups into alkoxide ions which then react with dimethyl sulphate by an  $S_N2$  reaction to form methyl ethers.



Since all the  $\text{-OH}$  groups are converted into  $\text{-OCH}_3$  groups, the process is called exhaustive methylation or permethylation.

For naming these compounds, each  $\text{-OCH}_3$  group except that of glycosidic linkage is named as an O-methyl group.

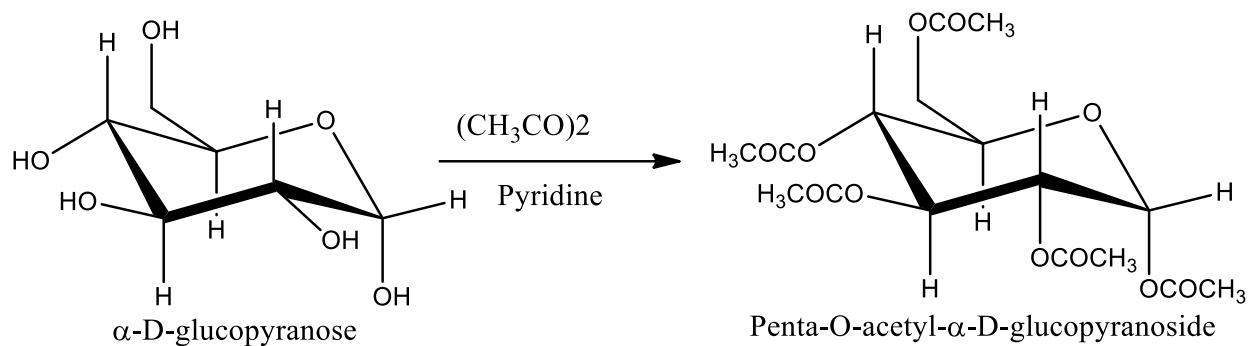
When permethylated glycoside is treated with dilute aqueous acid, the methyl glycoside bond gets hydrolysed (since acetals are hydrolysed in acidic solution). But the other methyl groups remain unaffected. This is because ordinary ether groups are stable in dilute aqueous acids. This is shown as under:



The process of permethylation of glycosides followed by acidic hydrolysis of glycosidic linkage forms an important method for determining the ring size of monosaccharides. This has been illustrated in the case of cyclic structure of glucose.

### (b) Formation of esters

Monosaccharides on treatment with acetic anhydride are converted into ester derivatives which are very useful crystalline compounds. The monosaccharide is treated with acetic anhydride and pyridine when all the hydroxyl groups are converted to ester groups. When carried out at low temperature (273 K), the reaction takes place stereospecifically,  $\alpha$ -anomer gives the  $\alpha$ -acetate and the  $\beta$ -anomer gives the  $\beta$ -acetate. For example:



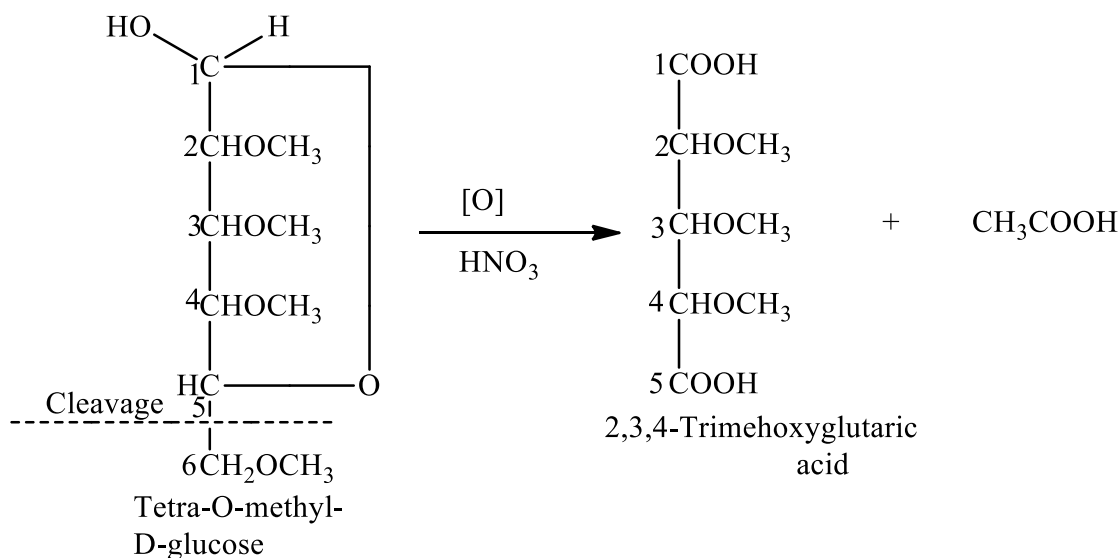

---

## 8.6. DETERMINATION OF RING SIZE OF MONOSACCHARIDES

---

So far we have represented structure of cyclic hemiacetals or anomers of D-glucose as having a ring of six members, five carbons and one oxygen. This has been proved to be correct and a five membered ring has been ruled out.

Hirst (1926) prepared tetra-O-methyl-D-glucose with dimethyl sulphate and subsequent acid hydrolysis of the pentamethyl derivative formed. The oxidation of tetra-O-methyl-D-glucose with nitric acid yielded trimethoxyglutaric acid.



Obviously, the two carboxylic carbons (1, 5) of the trimethoxyglutaric acid are the one's originally involved in ring formation. Hence, there must have existed an oxide ring between C-1 and C-5. Tracing back the reaction sequence, it stands proved that D-glucose has a six membered

ring. The presence of a 6-membered ring in D-glucose has also been confirmed by X-ray analysis.

---

## 8.7. CYCLIC STRUCTURE OF D-GLUCOSE

---

The open chain structure of glucose explained most of its properties. However, it could not explain the following facts.

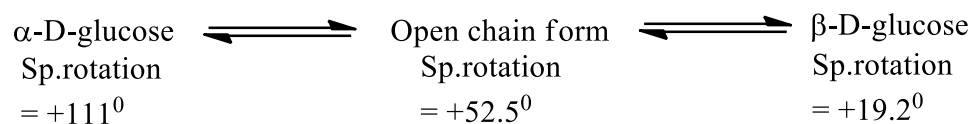
6. Despite having an aldehyde group, glucose does not undergo certain characteristic reactions of aldehyde,
  - (d) Glucose does not react with sodium bisulphate to form addition product.
  - (e) Glucose does not react with ammonia.
  - (f) Glucose does not give Schiff's test and 2, 4-DNP test like other aldehydes.
7. Glucose reacts with hydroxylamine to form an oxime but glucose pentaacetate does not react with hydroxylamine. This shows that  $-CHO$  group is not present in glucose pentaacetate.
8. **D (+)-Glucose exist in two stereoisomeric forms i.e.,  $\alpha$ - D(+)-Glucose and  $\beta$ - D(+)-Glucose.** These two forms are crystalline and have different m.p and optical rotations. When glucose was crystallized from a concentrated solution at 303 K, it gave  $\alpha$ -form of glucose having m.p 419 K and  $[\alpha]_D = +111^{\circ}$ . On the other hand, the  $\beta$ -form of glucose is obtained on crystallization of glucose from a hot saturated solution of at a temperature above 371 K. The  $\beta$ -form of glucose has m.p 423 K and  $[\alpha]_D = +19.2^{\circ}$ .
9. **Mutarotation.** When either of two forms of glucose ( $\alpha$ - D-glucose and  $\beta$ - D-glucose) are dissolved in water and allowed to stand, these get slowly converted into other form and a equilibrium mixture of both  $\alpha$ - D-glucose (36 %) and  $\beta$ - D-glucose (about 64%) is formed.

The formation of equilibrium mixture can be explained as:

The  $\alpha$ - D-glucose has a specific rotation of  $+111^{\circ}$ , while  $\beta$ - D-glucose has a specific rotation of  $+19.2^{\circ}$ . When  $\alpha$ -form is dissolved in water, its specific rotation falls until a constant value of  $+52.5^{\circ}$  is reached. On the other hand, when  $\beta$ -form is dissolved in water, its specific rotation increases and becomes constant at  $52.5^{\circ}$ .

This spontaneous change in specific rotation of an optically active compound with time to an equilibrium value is called mutarotation. (Latin, mutare means to change).

Thus, there is an equilibrium mixture of  $\alpha$ - and  $\beta$ -forms in the solution



10. Glucose forms isomeric methyl glucosides. When glucose is heated with methanol in the presence of dry HCl, it gives two isomeric monomethyl derivatives known as  $\alpha$ -D-glucoside (m.p. = 438 K) and  $\beta$ -D-glucoside (m.p. 380 K).



These two glucosides do not reduce Fehling's solution and also do not react with HCN or  $\text{NH}_2\text{OH}$  indicating that the free  $-\text{CHO}$  group is not present but it is converted to  $-\text{COOH}$  group.

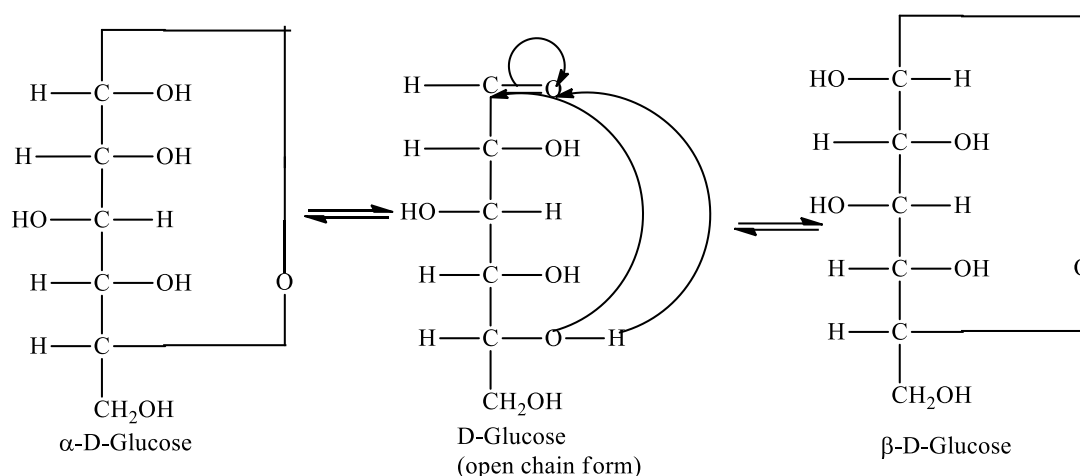
### Cyclic structure of Glucose

#### Anomers.

Glucose forms a hemiacetal between the  $-\text{CHO}$  group and the  $-\text{OH}$  group on the  $\text{C}_5$  atom. As a result, of cyclisation,  $\text{C}_1$  becomes asymmetric (chiral) and the newly formed  $-\text{OH}$  group may be either on the left or on the right in Fisher projection formulae. This result in the formation of two isomers which differs in the orientation of H and  $-\text{OH}$  groups around  $\text{C}_1$  atom. These isomers are known as  $\alpha$ - D-glucose and  $\beta$ - D-glucose. The isomer having the  $-\text{OH}$  group on the right is called  $\alpha$ - D-glucose and one having the  $-\text{OH}$  group on the left is called  $\beta$ - D-glucose. Such pairs of optical isomers which differ in the configuration only around  $\text{C}_1$  atom are called anomers.

These two forms are not mirror image of each other, hence are not enantiomers. The  $\text{C}_1$  carbon is known as anomeric carbon or glycosidic carbon.

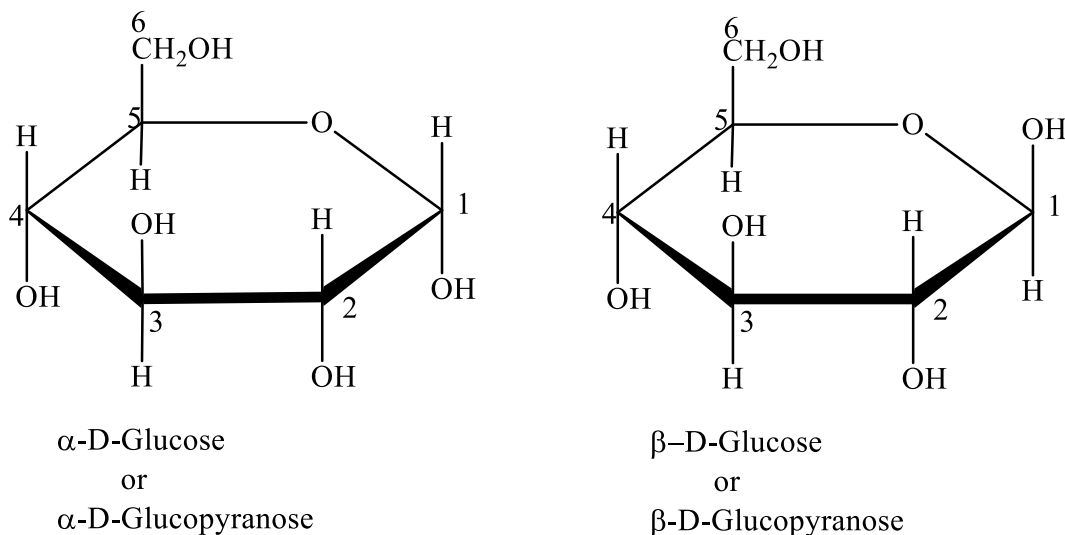




The above representations are called Fisher projection formulae.

### Haworth projection formulae or pyranose structures of D-Glucose.

In Haworth structures drawn with the heterocyclic oxygen in the upper right corner, the  $\alpha$ -form has the  $-\text{OH}$  group on  $\text{C}_1$  pointing “down”. The  $\beta$ -form has the same group pointing “up”. For D-sugars, the free  $-\text{CH}_2\text{OH}$  group of an aldohexose is drawn above the plane of ring when ring oxygen is in the upper right. The rest is the simple, the groups on the left of the Fisher projection are up and those on the right are down in the Haworth structure.



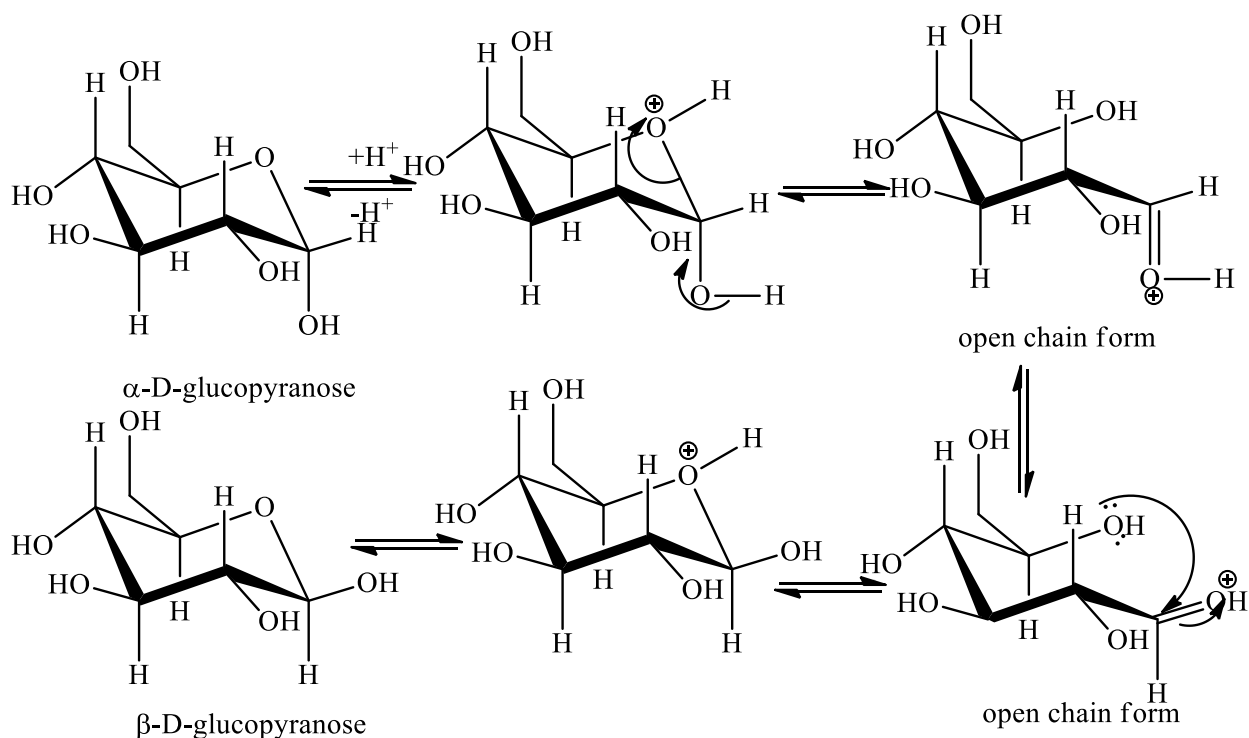

---

## 8.8. MECHANISM OF MUTAROTATION

---

Mutarotation occurs by opening of the ring to the free carbonyl form. The mechanism shown in Scheme I begins as the reverse of hemiacetal (or hemiketal) formation. An 180° rotation about the bond to the carbonyl group permits attack of the hydroxyl group at C-5 on the opposite face of the carbonyl carbon. Hemiacetal formation then gives the other anomer. Mutarotation is catalysed by both acid and base.

Thus, the easy opening and closing of hemiacetal or hemiketal linkage is responsible for mutarotation.



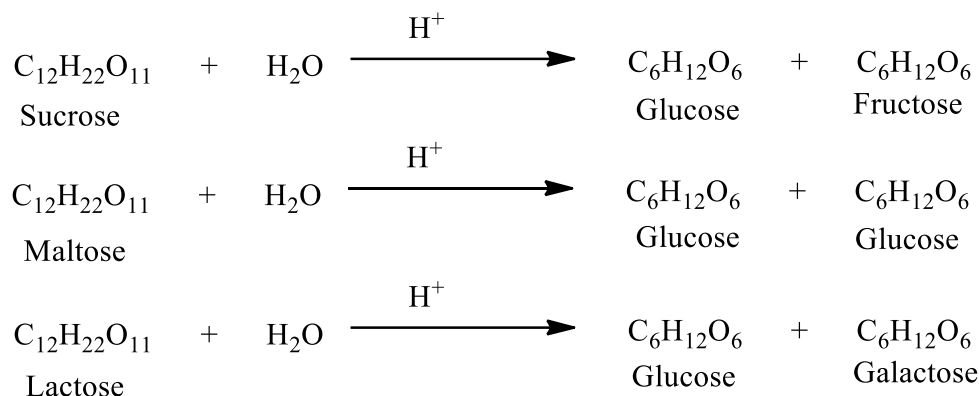
**Scheme I. Acid catalysed mechanism of mutarotation**

---

## **8.9. GENERAL STUDY OF DISACCHARIDES**

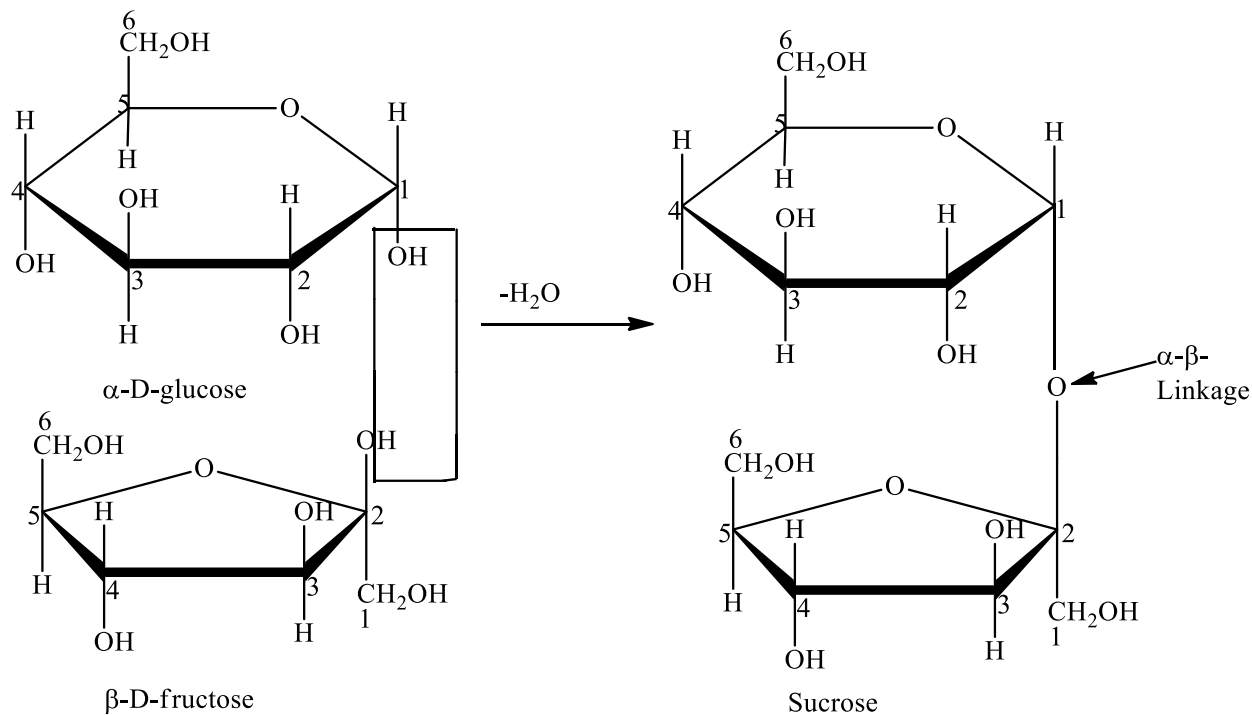
---

Disaccharides are the carbohydrates which on hydrolysis give two same or different monosaccharides. Their general formula is  $C_{12}H_{22}O_{11}$ . The important members belonging to disaccharides are sucrose, maltose, and lactose. On hydrolysis with dilute acids or enzymes these give the following two molecules of monosaccharides.



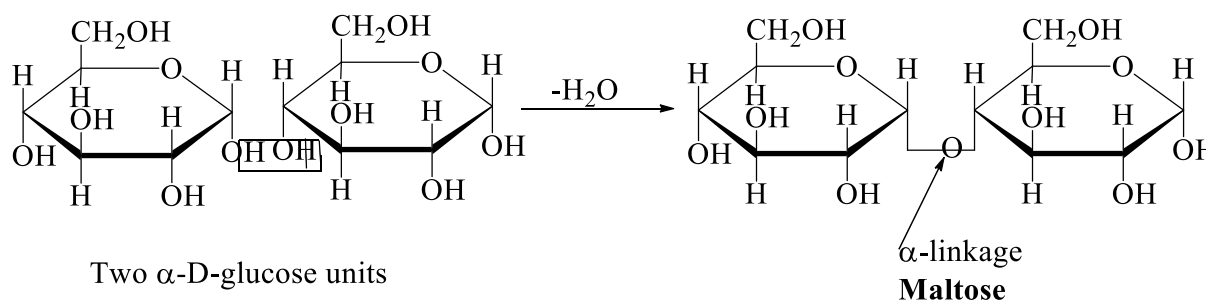
In disaccharides, the two monosaccharides are joined together by acetal or glycosidic formation. The hemiacetal OH of one monosaccharide and an OH of second monosaccharide, dehydrate to establish the bond (called glycosidic bond) between the two monosaccharides. That is, disaccharides are composed of two units of monosaccharides joined by glycosidic linkage.

**Sucrose (Cane Sugar).** Sucrose is ordinary table sugar. It is obtained from cane sugar. Sucrose is composed of  $\alpha$ -D-glucose and  $\beta$ -D-fructose unit. These units are joined by  $\alpha,\beta$ -glycosidic linkage between C-1 of glucose and C-2 of fructose unit.



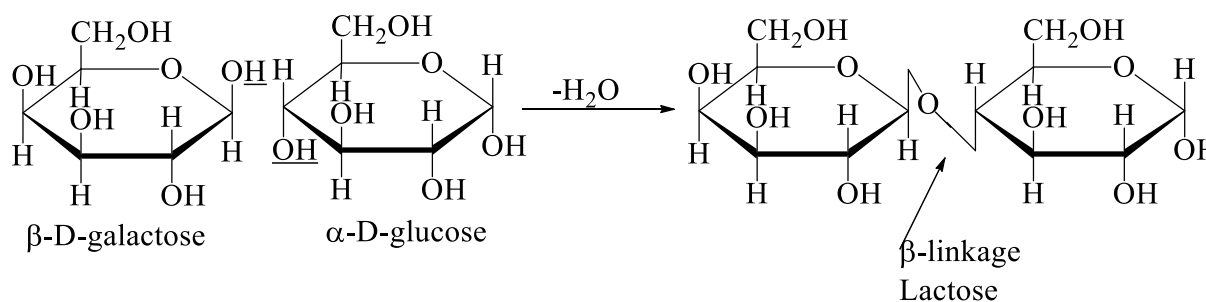
Notice that in the above structure of sucrose, hemiacetal structure is missing. That is why sucrose: (a) does not form an osazone with phenylhydrazine (b) does not reduce Tollen's reagent or Fehling's solution (sucrose is a non reducing sugar) (c) does not exhibit mutarotation.

**Maltose:** It is obtained from starch. It is composed of two  $\alpha$ -D-glucose units joined by a  $\alpha$ -glycosidic linkage between C-1 of one unit and C-4 of the other unit.



Notice that C-1 of the second glucose unit in the maltose structure is a hemiacetal carbon. Consequently, it is in equilibrium with the open chain aldehyde form. Thus maltose can exist in  $\alpha$  and  $\beta$  forms. Since it has a potential aldehyde group, maltose shows mutarotation, forms osazone and reduces Fehling's solution (Maltose is a reducing sugar).

Lactose (Milk Sugar). It is found in milk of all animals. Cow's milk contains 4-5 % and human milk 6-7 % lactose. Lactose is composed of  $\beta$ -D-galactose unit and  $\alpha$ -D-glucose unit joined by  $\beta$ -D-glycosidic linkage between C-1 of the galactose and C-4 of the glucose unit.

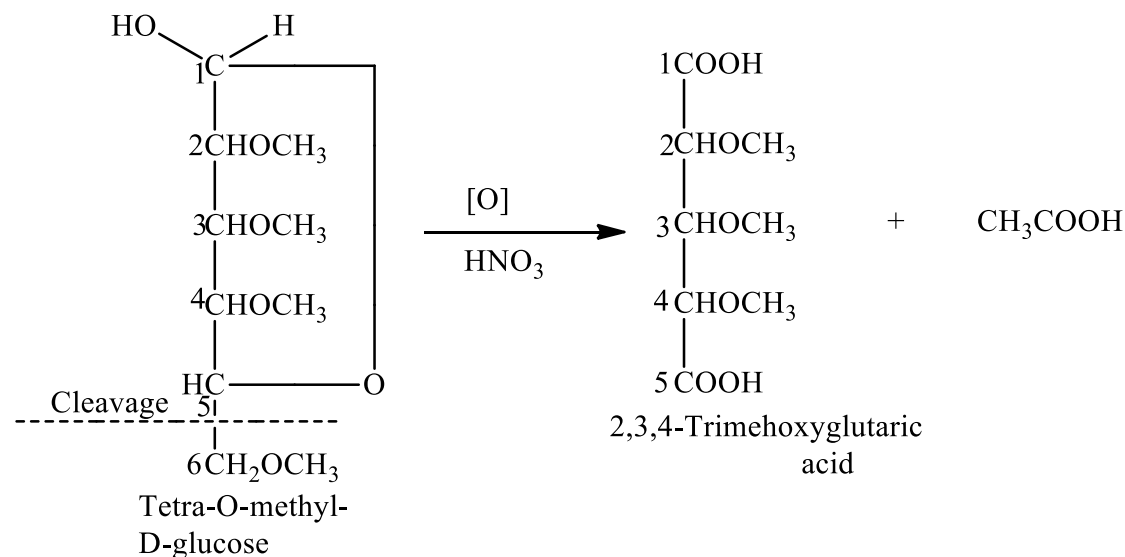


Like maltose, lactose can also exist in  $\alpha$  and  $\beta$  forms. Lactose is a reducing sugar and shows mutarotation. It reacts with Tollen's reagent and Fehling's solution.

**Determination of ring size of monosaccharides:**

So far we have represented structure of cyclic hemiacetals or anomers of D-glucose as having a ring of six members, five carbons and one oxygen. This has been proved to be correct and a five membered ring has been ruled out.

Hirst (1926) prepared tetra-O-methyl-D-glucose with dimethyl sulphate and subsequent acid hydrolysis of the pentamethyl derivative formed. The oxidation of tetra-O-methyl-D-glucose with nitric acid yielded trimethoxyglutaric acid.



Obviously, the two carboxylic carbons (1,5) of the trimethoxyglutaric acid are the one's originally involved in ring formation. Hence, there must have existed an oxide ring between C-1 and C-5. Tracing back the reaction sequence, it stands proved that D-glucose has a six membered ring. The presence of a 6-membered ring in D-glucose has also been confirmed by X-ray analysis.

### **SUCROSE, Cane Sugar, (C<sub>12</sub>H<sub>22</sub>O<sub>11</sub>):**

Sucrose is ordinary table sugar. It occurs chiefly in sugar cane and sugar beets. In smaller amounts it is present in maple sap, honey, and several fruits.

### **Manufacture of Sucrose (Table Sugar):**

In India and other tropical countries, the main source of sucrose is sugar cane. The modern method for the manufacture of 'Direct Consumption' sugar from cane consists of the following steps. (Fig 8.1).

**(1) Juice Extraction.** The crushed cane is passed through a roller mill to squeeze out juice. The partially exhausted 'cane mat' emerging from the mill is passed on to a tank, called Diffuser, by a chain conveyer. Here the maximum extraction of sucrose is done by washing with hot water and dilute juice on counter-current principle. This technique gets sugar extraction upto 98%. The cellulosic material discharged from the diffuser is called Bagasse and is used as fuel under boilers.

**(2) Juice Purification:** The raw juice contains 14-25% sucrose and much impurity such as organic acids, inorganic salts. Proteins and colouring matter. It is purified by the operations listed below:

**(i) Defecation:** The juice is heated with high pressure steam and treated with 2-3 % lime in a steel tank. This operation called defecation throws out organic acids as insoluble calcium salts, coagulated protein and colouring matter. The precipitate is removed by filtration.

**(ii) Carbonation:** Through the filtered juice is then  $\text{CO}_2$ . This operation known as carbonation, removes the excess, of lime as calcium carbonate which entraps colouring matter, colloidal and some inorganic salts. The 'mud' that settles is separated by filtration.

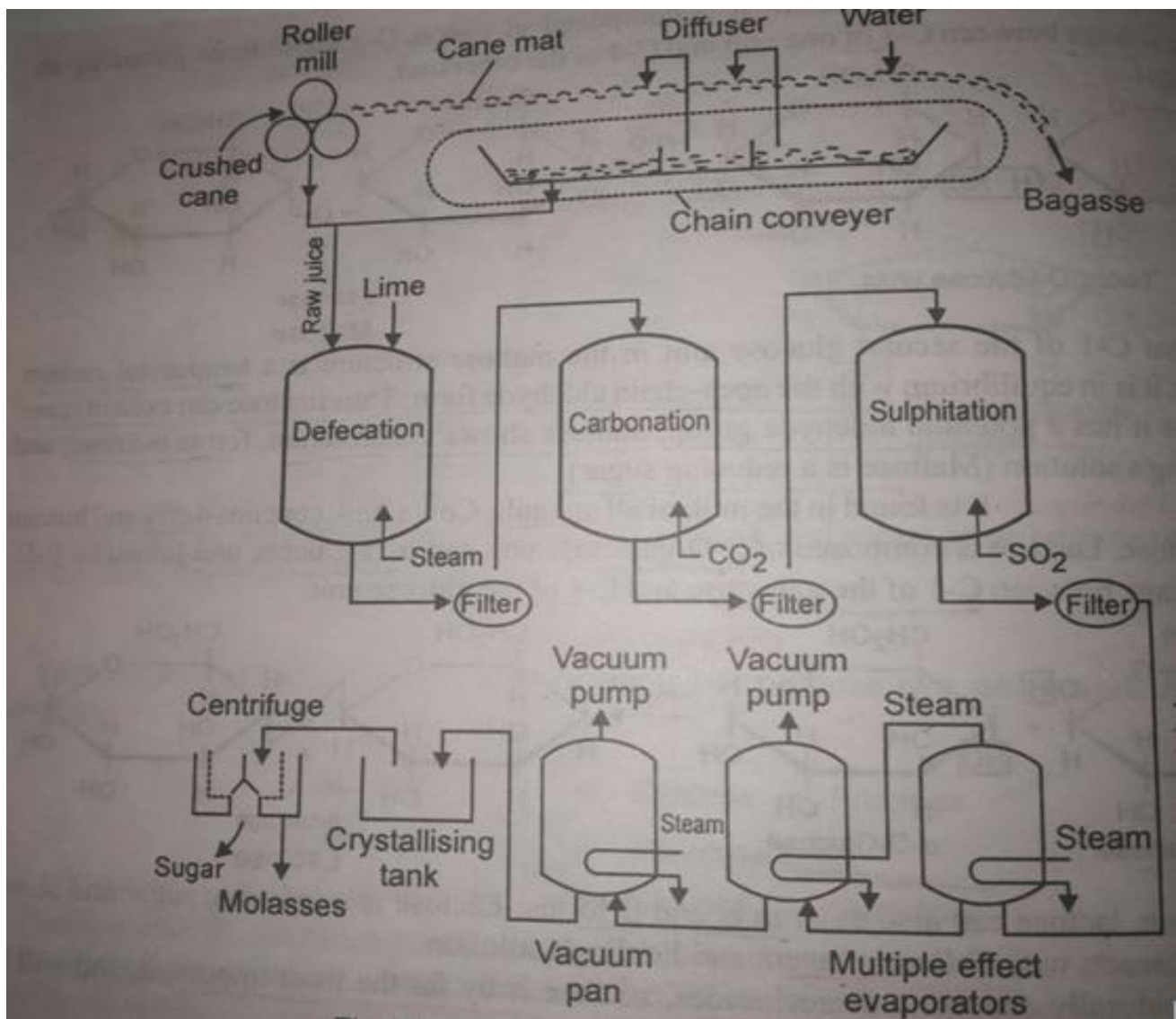
**(iii) Decolorisation:** In India, the clarified juice is decolorized by treating with  $\text{SO}_2$ . This operation called Sulphitation while it bleaches the brown colour of the juice, completes the neutralization of lime. The insoluble calcium sulphite is removed by filtration.

**(3) Concentration and Crystallisation:** The clear solution is then concentrated by boiling under reduced pressure in Multiple Effect Evaporators. In these, the steam produced in the first evaporator is used to boil the juice in the second maintained at a lower pressure; the second being used to boil the juice in the third kept at a still lower pressure; and son on.

The concentrated juice is finally passed to the Vacuum Pan where further evaporation reduces the water content to 6-8%. Here partial separation of crystals takes place. The mixture of

syrup and crystals, known as Massecuite, is then discharged into a large tank, the Crystallising Tank, fitted with cooling pipes. The crystals grow and form a thick crop.

**(4) Separation of Crystals by Centriguagation, and Drying.** The massecuite is then sent to centrifuges wherby sugar crystals are separated from the syrup. The crystals are here sprinkled with a little water to wash any syrup sticking to the surface. The wet sugar is dried by passing down a rotating drum with stream of hot air flowing counter-current to it. The residual mother liquor, from which the crystals have been removed, is called molasses. In India, it is valuble raw material for alcohol manufacture by fermentation.



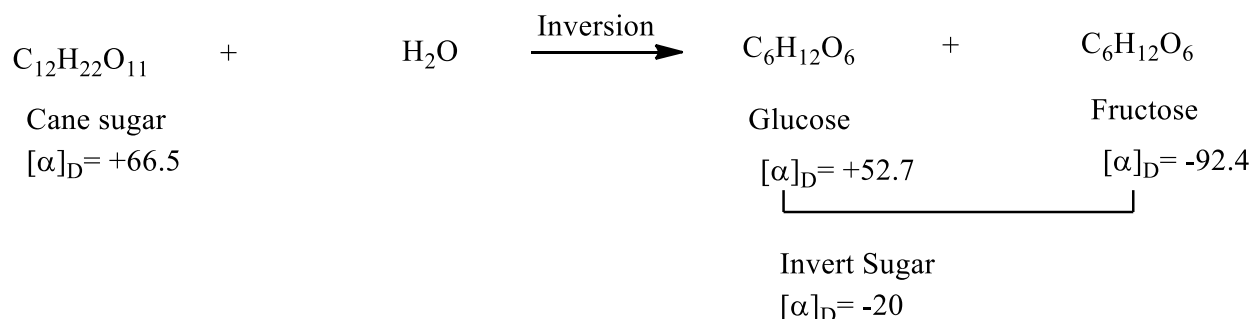
**Fig 8.1. sugar manufacture (Flow sheet)**

### Properties of Cane Sugar, C<sub>12</sub>H<sub>22</sub>O<sub>11</sub>:

1. It is colourless, crystalline substance, sweet in taste. It is very soluble in water and the solution is dextrorotatory  $[\alpha]_D = +66.5$ .
2. Effect of heat. Sucrose on heating slowly and carefully melts and then if allowed to cool, it solidifies to pale-yellow glassy mass called 'barley sugar'.

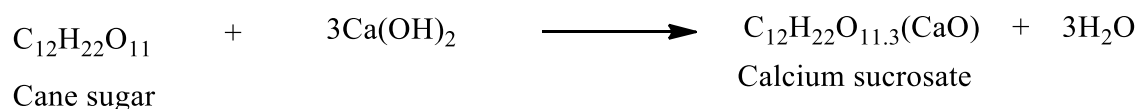
When heated to 473K, it loses water to form a brown amorphous mass called caramel. On strong heating it chars to almost pure carbon giving characteristic smell of burnt sugar.

3. Hydrolysis or Inversion of Sucrose (Sugar). Sucrose when boiled with mineral acids, or by the enzyme invertase, yields an equimolar mixture of glucose and fructose.



Sucrose is dextrorotatory and on hydrolysis produces dextrorotatory glucose and laevorotatory fructose. With greater laevorotation of fructose the mixture is laevorotatory. Thus, there is a change (inversion) in the direction of rotation of the reaction mixture from dextro to laevo. This phenomenon is called inversion and the enzyme which brings about this inversion is called invertase.

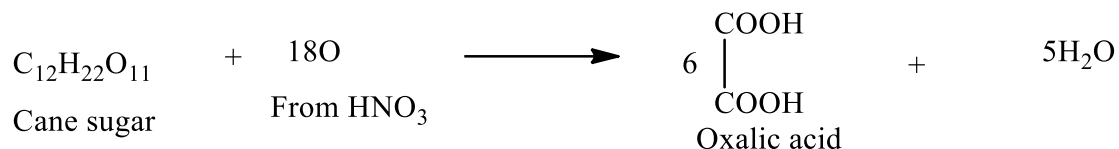
4. **Formation of Sucrosates:** Sucrose solution reacts with calcium, barium and strontium hydroxides to form sucrosates.



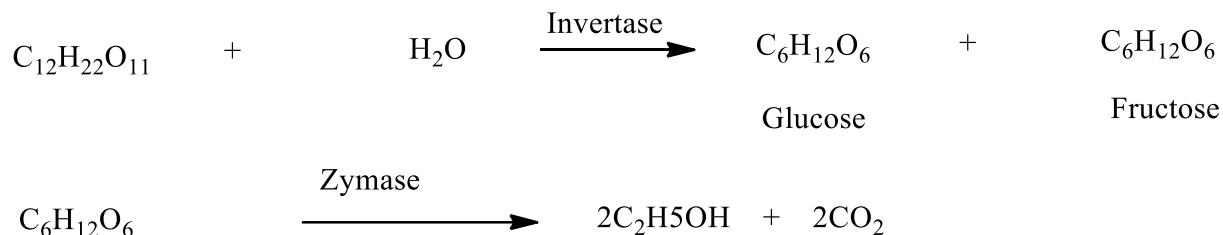
The sucrosate decomposes when carbon dioxide is passed in the solution.



5. **Action of nitric acid:** Concentrated nitric acid oxidizes cane sugar to oxalic acid.



6. **Fermentation:** Fermentation of Sucrose is brought about by yeast when the enzymes invertase hydrolysed sucrose to glucose and fructose and zymase converts them to ethyl alcohol.




---

## ***8.10. GENERAL INTRODUCTION OF STRUCTURE OF RIBOSE AND DEOXYRIBOSE***

---

Ribose and deoxyribose are two well known aldopentoses. Their structures are discussed as under.

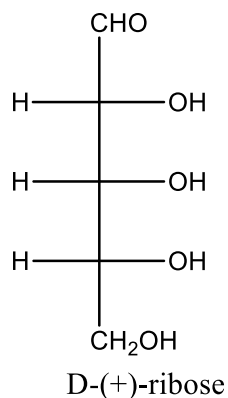
### **Structure of D-(+)- Ribose:**

D-(+)- Ribose occurs naturally in plant nucleic acids and in liver and pancreas nucleic acids. It gives properties similar to glucose.

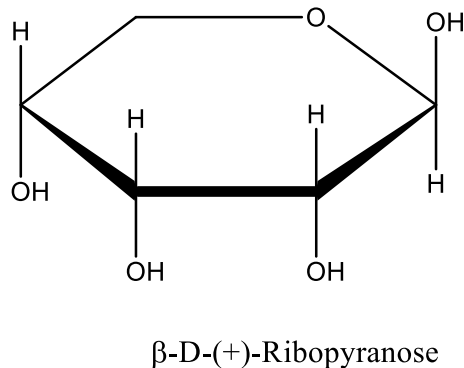
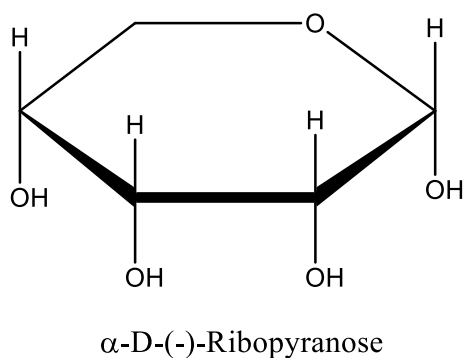
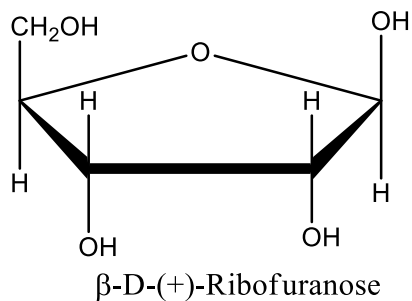
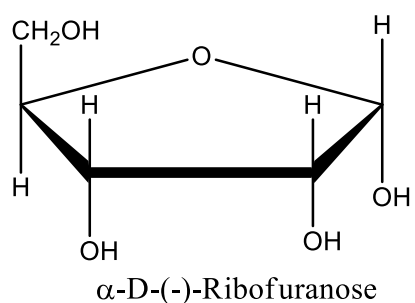
Ribose has the molecular formula ( $\text{C}_5\text{H}_{10}\text{O}_5$ ) and shows the presence of an aldehyde group, four hydroxyl groups (one primary and three secondary) and a straight chain of carbon atoms. Therefore, it was assigned an open chain formula as given below:



The configuration of D-ribose has been established as follows.



As in the case of glucose, D-ribose is now assigned a ring structure and is known to exist both in furanose and pyranose forms as depicted below:

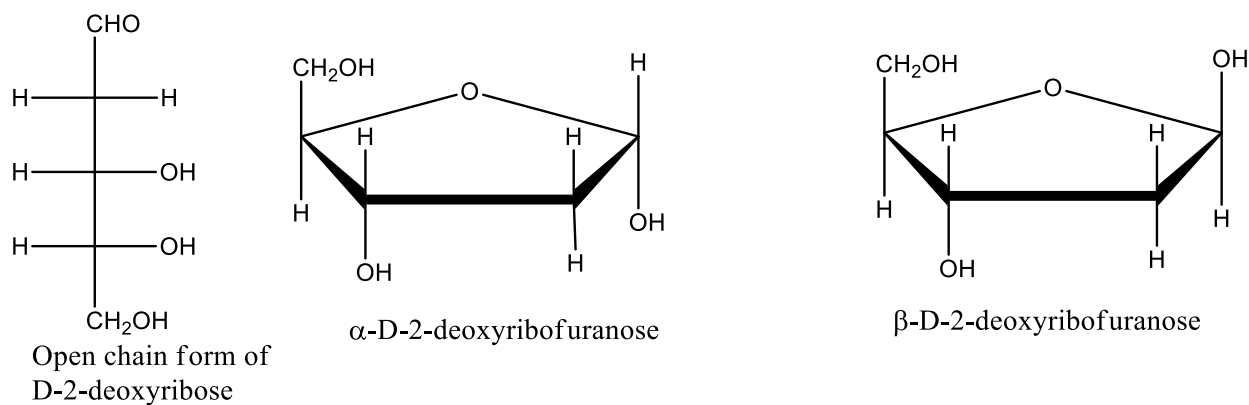


Pyranose form is more stable than the furanose form. Equilibrium mixture of ribose contains 56%  $\beta$ -D-ribopyranose 20%  $\alpha$ -D-ribopyranose, 18%  $\beta$ -D-ribofuranose and 6%  $\alpha$ -D-ribofuranose. In RNA ribose is present in furanose form.

### Structure of deoxyribose:

In this aldopentose the hydroxyl group at C-2 of ribose has been replaced by hydrogen. That is why it is named as deoxyribose. It is fundamental constituent of deoxyribonucleic acid (DNA).

The structure of D-2-deoxyribose is derived from that of D-ribose and may be represented in the open chain and ring forms as follows.




---

## 8.11 GENERAL STUDY OF POLYSACCHARIDES

---

These are neutral polymeric compounds in which hundreds or even thousands of monosaccharide units are joined by glycosidic linkages. They have the general formula  $(C_5H_{10}O_5)_n$ , where n has very large value. They are colourless, tasteless and are insoluble in water. They play very important role in plant and animal life as food storage and structural role. They are usually made up of pentoses or hexoses. The important polysaccharides are cellulose, starch, glycogen and dextrans.

### Starch:

Starch is most widely distributed in vegetable kingdom. In nature, it is transformed into complex polysaccharides like gum and cellulose and into simpler mono and disaccharides by enzymes working in vegetable kingdom. Its rich sources are potatoes, wheat, maize, rice, barley and arrow root. It is interesting to note that no two sources give identical starch.

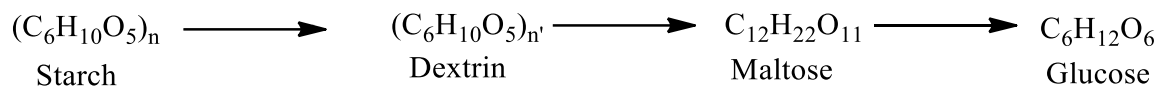
### Physical properties:

It is a white, amorphous substance with no taste or smell. It is insoluble in water but when starch is added to boiling water the granules swell and burst forming colloidal, translucent suspension.

**Chemical properties of starch:**

(i) When heated to a temperature between 200-250<sup>0</sup> it changes into dextrin. At higher temperature charring takes place.

(ii) Starch, when boiled with dilute acids, yielded ultimately glucose



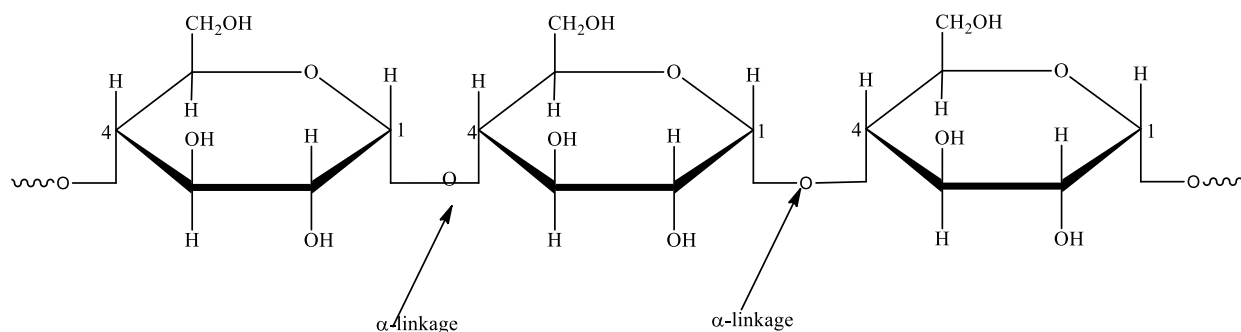
When hydrolysed with enzyme diastase, maltose is obtained.

(iii) Starch solution gives a blue colour with a drop of iodine solution. The blue Colour disappears on heating and reappears on cooling. In fact it is the amylose that gives colour with iodine; the amylopectin gives a red brown colour with iodine.

Starch is a non reducing saccharide. It does not reduce Fehling's solution or Tollen's reagent. It also does not form an osazone indicating that all hemiacetal hydroxyl groups of glucose units (C<sub>1</sub>) are not free but are linked with glycosidic linkages.

Starch is polymer of  $\alpha$ -D-glucose and consists of two components (15-20%) amylose and 80-85%) amylopectin.

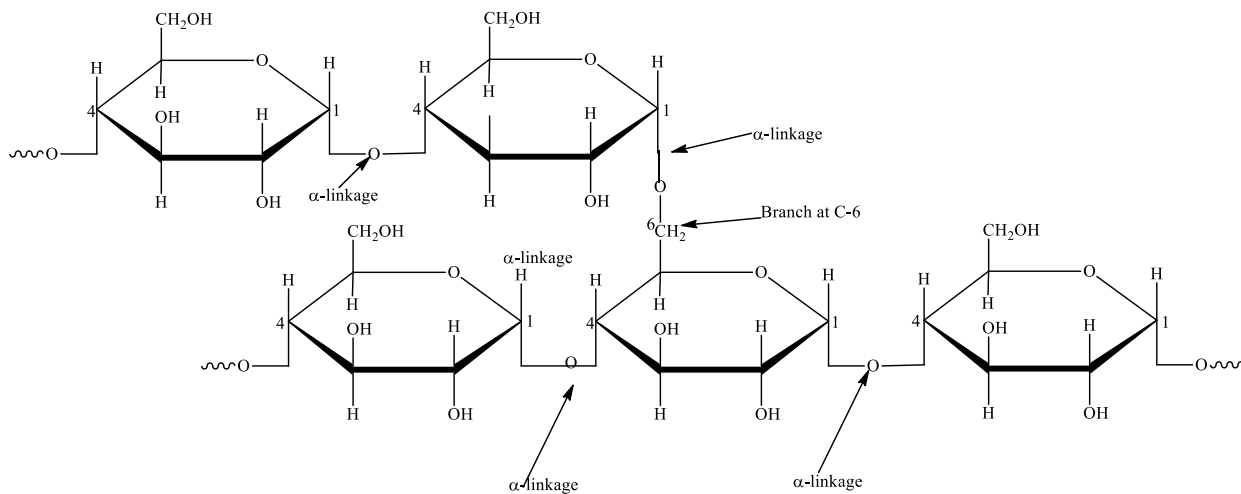
(i) **Amylose.** It is white soluble fraction. It is linear polymer of  $\alpha$ -D-glucose. It contains about 200-1000  $\alpha$ -D-glucose units which are linked to one another through  $\alpha$ -glycosidic linkage involving C-1 of one glucose and C-4 of the next as shown below.



Amylose

Its molecular mass can range from 10, 0000 to 500,000.

**(ii) Amylopectin.** It is water insoluble fraction. It is a highly branched chain polymer which does not give blue colour with iodine. It consists of a large number of short chains of 25-30 D-glucose units. In this case the main chain involves  $\alpha$ -linkages between C-1 of one  $\alpha$ -D-glucose unit and C-4 of the other. The C-1 of terminal glucose in each chain is further linked to C-6 of the other glucose unit in the next chain through C-1-C-6  $\alpha$ -linkage. This gives highly branched structure.



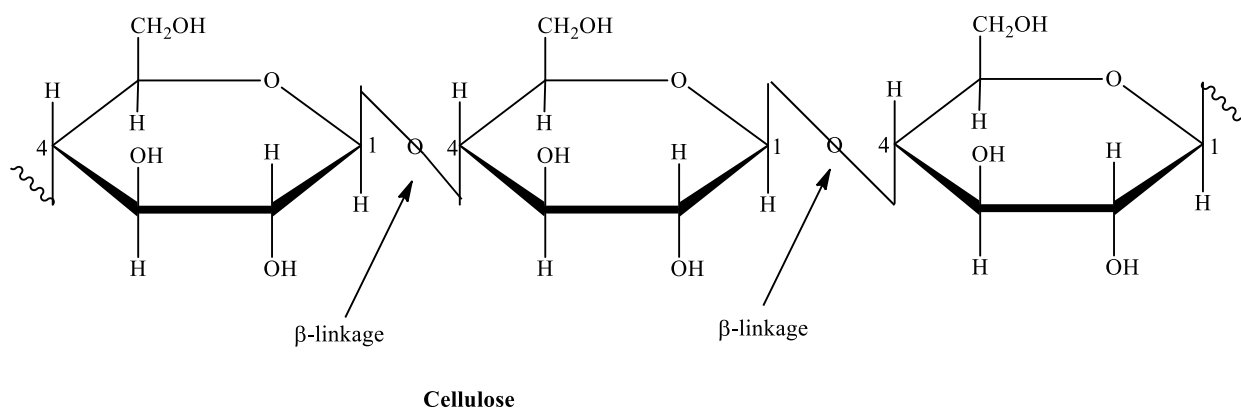
Amylopectin

Starch is used as the principal food storage of glucose energy. It is hydrolysed by enzyme amylase present in saliva. The end product of glucose which is an essential nutrient.

## Cellulose

Cellulose is the main structural material of trees and other plants. Wood is 50% cellulose, while cotton wool is almost pure cellulose. Other sources of cellulose are straw, corncobs, bagasse, and similar agriculture wastes.

**Manufacture:** Cotton wool is about 97% cellulose. It is ready for use after washing away the waxes and fats associated with it. The cellulose required for making paper is obtained from wood. Lignin and resinous substances present along with cellulose are removed by digesting the wood chips under pressure with a solution calcium hydrogen sulphite. The cellulose separates as insoluble fibres which are washed with water, bleached and dried.



**Structure.** Cellulose is a straight chain polysaccharide composed of D-glucose units. These units are joined by β-glycosidic linkages between C-1 of one glucose unit and C-4 of the next glucose unit. The number of D-glucose units in cellulose ranges from 300-2500.

**Properties:** Cellulose is a colourless amorphous solid having no m.p. it decomposes on strong heating. It is insoluble in water and most organic solvents. However, it dissolves in S. reagent which is an ammoniacal solution of cupric hydroxide.

**Hydrolysis:** Cellulose when hydrolysed by heating with dilute acids, gives D-glucose. Cellobiose is formed in case of incomplete hydrolysis.

The cattle, goats, and other ruminants have digestive enzymes (Cellulases) capable of hydrolyzing cellulose into glucose. Consequently, these can feed directly on cellulose. Man and many other mammals lack the necessary enzymes in their digestive tract, and they cannot use cellulose as foodstuff.

---

## **8.12. SUMMARY**

---

- Glyceraldehydes are the simplest carbohydrate and it serves as a reference molecule to write the configuration (D and L) of all other monosaccharides.
- The pair of enantiomers with similar groups on the same side of the carbon chain is called the erythro enantiomers while pair of enantiomers with similar groups on opposite sides is called the threo enantiomers.
- Mutarotation is defined as the interconversion of  $\alpha$  and  $\beta$  anomeric forms with the change in the optical rotation.
- Disaccharides are the carbohydrates which on hydrolysis give two same or different monosaccharides.
- Disaccharides are composed of two units of monosaccharides joined by glycosidic linkage.
- Polysaccharides are neutral polymeric compounds in which hundreds or even thousands of monosaccharide units are joined by glycosidic linkages.

---

## **8.13. MODEL EXAMINATION QUESTIONS**

---

1. How will you convert glucose into fructose?
2. Discuss the mechanism of mutarotation.
3. How is sucrose manufactured from sugar cane.
4. Discuss the structure of sucrose, lactose and maltose.
5. Write a short note on polysaccharides

---

## **REFERENCES**

---

1. A text book of organic chemistry, A. Bahl and B.S.Bahl, S.Chand & Compant Ltd.
2. Chemistry for degree students, R.L.madan, S.Chand & Compant Ltd.
3. Organic chemistry, Vol.III, Jagdamba singh and L.D.S Yadav, Prgati Prakashan.
4. Modern chemistry, S.P.Jauhar, Modern Publishers.
5. Organic chemistry, Francis A.Carey, Tata McGraw-Hill Company Ltd.

UNIT WRITER- Dr. Devendra Singh Dhami ,Department of Chemistry SSJ Campus, Almora



## Structure and Properties of Carbohydrates

Carbohydrates are aldehyde and ketone compounds with multiple hydroxyl groups. They are one of the most abundant classes of biomolecules in nature. They are widely distributed in all life forms and serves many roles, such as

- They serve as energy stores, fuels and metabolic intermediates.
- They are constituent of RNA and DNA backbones as ribose and deoxyribose sugars.
- Polysaccharides are constituents of cell walls of bacteria and plants.
- Carbohydrates are linked to surfaces of proteins and lipids where they play role as informational materials e.g. in cell-cell interaction and interaction between cells with other elements in the cellular environment.

Carbohydrate can be classified into three groups: monosaccharide, oligosaccharides and polysaccharides.

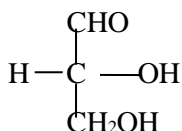
### Monosaccharide

Monosaccharide are the simplest carbohydrates which contain free aldehyde (-CHO) and ketone (>C=O) groups that have two or more hydroxyl (-OH) groups. The general formula of monosaccharide is  $C_n(H_2O)_n$ . Monosaccharides are sugars that can not be further hydrolysed into simple carbohydrates. They can be classified on the basis of number of carbon atoms for example triose, tetrose, pentose, hexose, heptoses etc. and on the basis of functional group they possess for example, aldoses (those having aldehyde groups) or ketoses (those having ketone groups) (Table 1).

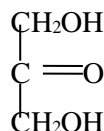
Table1: Classification of monosaccharides.

Name of sugar	Aldoses	Ketoses
Trioses ( $C_3H_6O_3$ )	Glucose	Dihydroxy acetone
Tetroses ( $C_4H_8O_4$ )	Erythrose	Erythulose
Pentoses ( $C_5H_{10}O_5$ )	Ribose	Ribulose
Hexoses ( $C_6H_{12}O_6$ )	Glucose	Fructose

Both the classifications i.e. number of carbon atoms and nature of functional groups may be combined to classify the sugar. For example glycerose (=glyceraldehyde) is an aldotriose, ribose is an aldopentose and fructose is a ketohexose. The smallest monosaccharide are glyceraldehyde and dihydroxyacetone for which  $n=3$  (where  $n$ = number of carbon atoms) (Figure 1).



Structure of glyceraldehyde

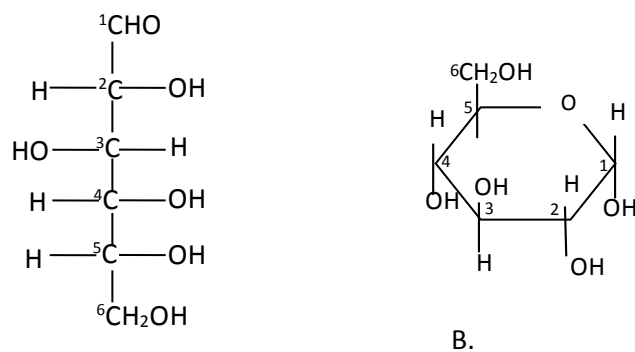


Structure of dihydroxyacetone

Figure 1: Structure of smallest monosaccharides ( $n=3$ ).

### Properties of monosaccharide

Monosaccharide exists in both as straight chain structure and cyclic structure (Figure 2). Sugars with five membered rings and with six membered rings are most stable. Cyclic structures are the result of hemiacetal formation by intermolecular reaction between carbonyl group and a hydroxyl group.



A.  
 Figure 2: Structure of  $\alpha$ -D-glucose. A. Straight chain B. Cyclic form

### 1. Chiral centre

All monosaccharide except dihydroxy acetone contain one or more asymmetric (chiral) carbon atoms thus are optically active isomers (enantiomers). A molecule with  $n$  chiral centres can have  $2^n$  stereoisomers. Glyceraldehydewith one chiral centrehas  $2^1=2$  and glucose with four chiral centres, have  $2^4=16$  stereoisomers.

### 2. D and L isomerism

One of the two enantiomers of glyceraldehyde is designated the D isomers and the other L isomers. The orientation of the  $-OH$  group that is most distant from the carbonyl carbon determines whether the sugar belongs the D or L sugars. When the  $-OH$  group on this carbon is on the right the sugar is D isomers, when is on the left the sugar is L isomers. Most of sugars present in biological system are D sugars. The D and L forms of glucose is shown in Figure 3.

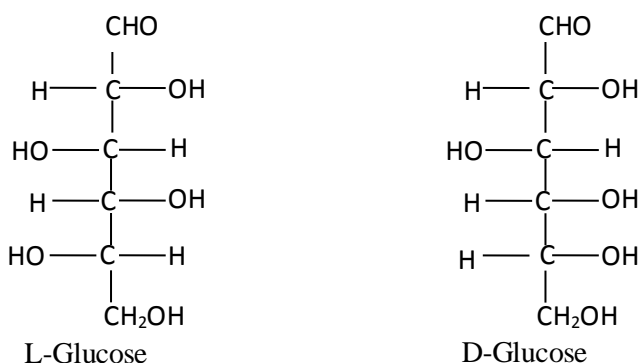


Figure 3: L and D forms of glucose.

### 3. Anomers

In aqueous solution all monosaccharide with five or more carbon atoms in the backbone occur as cyclic forms. Formation of cyclic structure is result of a reaction between alcohols and aldehydes or ketones to form derivatives called hemiacetal or hemiketals. The ring structure of monosaccharide are either similar to pyran (a six membered ring) or furan (a five membered ring). In linear form of monosaccharide, which is in equilibrium with the cyclic forms, the anomeric carbon is easily oxidised, making the sugar a reducing sugar. D-glucose exists in solution as an intramolecular hemiacetal in which the free  $-OH$  at C-5 has reacted with aldehyde C-1 producing two anomers called  $\alpha$  and  $\beta$  (Figure 4). D-fructose also forms hemiketal in which  $-OH$  at C-5 has reacted with keto at C-2 producing two anomers called  $\alpha$  and  $\beta$  (Figure 5).

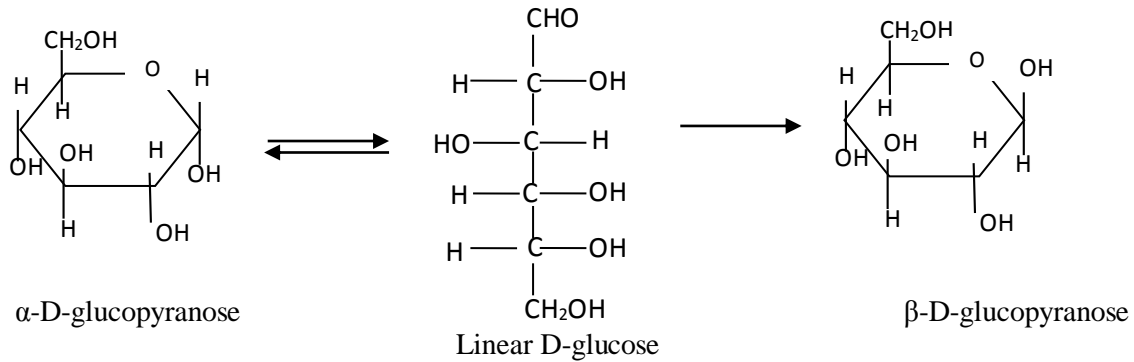


Figure 4: Two cyclic forms of glucose that are interconvertible in aqueous solution (mutarotation).

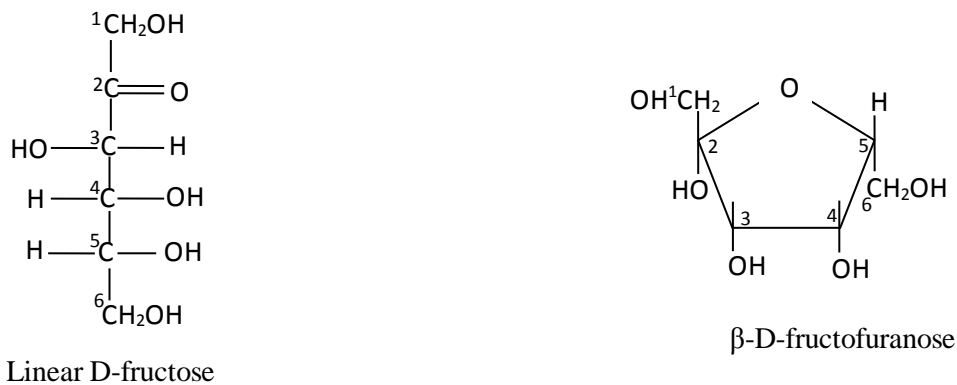


Figure 5: Structure of a ketohexose (fructose) and its cyclic hemiketal fructofuranose.

Isomeric forms of monosaccharide that differ only in their configuration about the hemiacetal or hemiketal carbon atom are called anomers, and the carbonyl carbon atom is called the anomeric carbon. The interconversion of  $\alpha$  and  $\beta$  anomers in aqueous solution is called mutarotation, in which one ring form opens briefly into the linear form, then closes again to produce  $\beta$  anomers. Thus, a solution of  $\beta$ -D-glucose and solution of  $\alpha$ -D-glucose eventually form identical equilibrium mixtures having identical properties. This mixture consists of about one third of  $\alpha$ -isomers and two third  $\beta$ -D-glucose.

#### 4. Epimers

Isomers having different configuration of  $-OH$  only at one carbon atoms are known as epimers. The most important epimers of glucose are mannose (epimers at C-2) and galactose (epimers at C-4) (Figure 6).

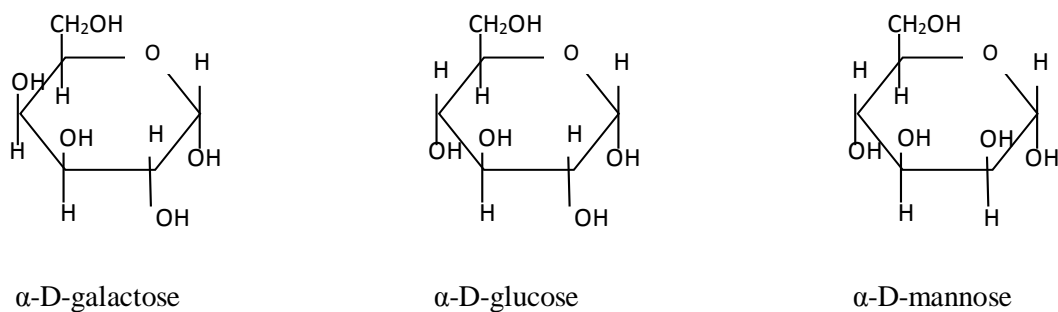


Figure 6: Epimers of glucose.

#### Disaccharides

Two monosaccharides can join covalently when –OH group of one sugar reacts with the anomeric carbon of other to form a disaccharide. The bond formed between the monosaccharide is called O-glycosidic bond. The reaction represents the formation of acetal from a hemiacetal. Glycosidic bond can be hydrolysed by acid but not cleave by the base. Thus disaccharides can be hydrolysed to yield their constituent monosaccharides by boiling with dilute acid. Hydrolysis of sucrose yields a mixture of glucose and fructose called ‘invert sugar’ because fructose is strongly levorotatory and change (converts) the weaker dextrorotatory action of sucrose. Some common disaccharides are given in Table 2.

Table 2: Some common disaccharides.

Disaccharide	Nomenclature	Source
Sucrose	<i>O</i> - $\alpha$ -D-glucopyranosyl-(1 $\rightarrow$ 2)- $\beta$ -D-fructofuranoside	Cane sugar and beet sugar, sorghum fruits and vegetables
Lactose	<i>O</i> - $\alpha$ -D-galactopyranosyl-(1 $\rightarrow$ 4)- $\beta$ -D-glucopyranose	Milk sugar
Maltose	<i>O</i> - $\alpha$ -D-glucopyranosyl-(1 $\rightarrow$ 4)- $\alpha$ -D-glucopyranose	Germinating cereals and malt
Isomaltase	<i>O</i> - $\alpha$ -D-glucopyranosyl-(1 $\rightarrow$ 6)- $\alpha$ -D-glucopyranose	Enzymatic hydrolysis of starch
Trehalose	<i>O</i> - $\alpha$ -D-glucopyranosyl-(1 $\rightarrow$ 1)- $\alpha$ -D-glucopyranose	Yeast and fungi

When the anomeric carbon is involved in a glycosidic bond, the easy interconversion of linear and a cyclic form is prevented. Because the carbonyl carbon can be oxidised only when the sugar is in its linear form, formation of a glycosidic bond makes the sugar non-reducing. The end of chain in disaccharide and polysaccharide with free anomeric carbon is called the reducing end. The disaccharides maltose contains two D-glucose residues joined by glycosidic linkage and lactose is made up of D-galactose and D-glucose residues. In both the disaccharides C-1 (anomeric carbon) of one sugar makes glycosidic bond with C-4 of another. Since the anomeric carbon of one sugar residue is available for oxidation, maltose and lactose are reducing disaccharides. Whereas in sucrose, the two monosaccharides glucose and fructose are linked via their anomeric carbon (C<sub>1</sub> of glucose and C<sub>2</sub> of fructose form glycosidic bond), no anomeric carbon atom is free, therefore sucrose is a non-reducing sugar (Figure 7).

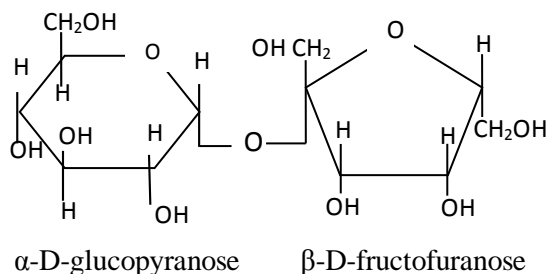


Figure 7: Structure of sucrose [*O*- $\alpha$ -D-glucopyranosyl-(1 $\rightarrow$ 2)- $\beta$ -D-fructofuranoside]

The stability of sucrose makes it ideal molecule for storage and transport of energy in plants. Trehalose, like sucrose is a non-reducing sugar is major constituent of circulating fluid of insects, serving as energy storage compound.

### Polysaccharides

Polysaccharides are polymers composed of ten or more monosaccharide units. These monosaccharide units are joined together by glycosidic linkages. Polysaccharides made up of a single type of monosaccharide units are called as homopolysaccharides, whereas polysaccharides composed of two or more types of monosaccharides are called heteropolysaccharides. Some polysaccharides are made up of sugar derivatives like, for example glucosamine, a glucose derivative, is the repeating monosaccharide in chitin. Polysaccharides differ from each other in the type of repeating monosaccharide unit, in the number of repeating units, in the degree of branching, and in the type of glycosidic linkage between the monomeric units.

Depending of the functional roles they play, homopolysaccharides may further be classified as storage polysaccharides and structural polysaccharides. Storage polysaccharides serve as storage form of monosaccharide that is used as fuels. Starch is an example of storage polysaccharide in plants and glycogen is the storage polysaccharide in animals. Structural polysaccharides such as cellulose and chitin serve as structural elements in plant cell wall and animal exoskeleton, respectively. Heteropolysaccharides, unlike the homopolysaccharides, provide extracellular support for organisms. Heteropolysaccharides in the extracellular space of animal tissues form a matrix that holds individual cells together and provides shape, support and protection to the cells and tissues.

### Homopolysaccharides

Homopolysaccharides yield a single type of monosaccharide on hydrolysis. They serve as both storage (e.g., starch, glycogen, dextran, inulin) and structural (e.g., cellulose, chitin, xylan, pectin) polymers. The structures and properties of some homopolysaccharides are given in Table 3.

Table 3: Structures and properties of some homopolysaccharides.

Name	Constituent monosaccharide	Glycosidic linkage	Size (no. of monosaccharide residues)	Biological significance
Starch	$\alpha$ -D-glucose	$\alpha(1\rightarrow4)$ glucoside (in amylose) $\alpha(1\rightarrow4)$ glucoside; $\alpha(1\rightarrow6)$ glucoside linkage at branch points (in amylopectin) Branches at every 24-30 residues	50-5000  Upto $10^6$	Energy storage in plants
Glycogen	$\alpha$ -D-glucose	$\alpha(1\rightarrow4)$ glucoside; $\alpha(1\rightarrow6)$ glucoside linkage at branch points Branches every 8-14 residues	Upto 50000	Energy storage in bacteria and animals
Cellulose	$\beta$ -D-glucose	$\beta(1\rightarrow4)$ glucoside	Up to 15000	Structural role: provide rigidity and strength to cell wall
Chitin	N-acetyl-D-glucosamine	$\beta(1\rightarrow4)$ glucoside	Very large	Structural role: provide rigidity and strength to exoskeleton of insects
Dextran	$\alpha$ -D-glucose	$\alpha(1\rightarrow6)$ glucoside with $\alpha(1\rightarrow3)$ glucoside at branching points	Wide range	Structural: extracellular adhesive in bacteria
Inulin	$\beta$ -D-fructose	$\beta(2\rightarrow1)$ fructoside	30-35	Energy storage in plants
Pectin	$\alpha$ -D-galacturonic acid	$\alpha(1\rightarrow4)$ galactoside		Structural: holds cellulose fibrils together in plant cell walls
Xylan	$\beta$ -D-xylose	$\beta(1\rightarrow4)$ xylose	30-100	Storage and supporting roles in plants

### Starch

Starch occurs in plants as reserve carbohydrate in tubers, seeds, fruits and roots. It is deposited in the cytoplasm of plant cells as insoluble granules composed of two homopolysaccharides; amylose (15-20%) and amylopectin (80-85%). Amylose is a linear polymer of  $\alpha$ -D-glucose monomers linked by  $\alpha(1\rightarrow4)$  bonds (Figure 8). The linkage in amylose is thus  $\alpha(1\rightarrow4)$  glycoside, similar to that in maltose. The molecular weight of amylose ranges from 10,000 to 50,000 Da.

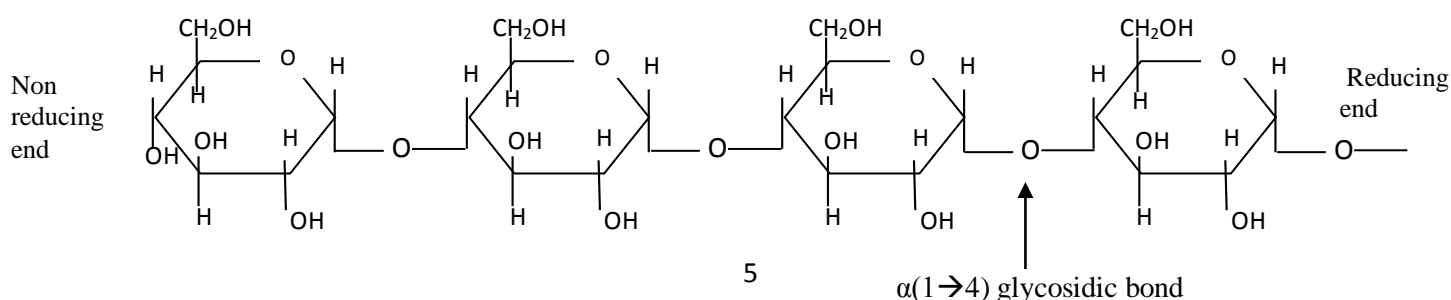


Figure 8: Structure of amylose.

Amylopectin is very high molecular weight (up to 200 million Da) molecule consisting of glucose units linked by  $\alpha(1\rightarrow4)$  glycoside linkage like amylose, but it is highly branched. Branch points occur every 24 to 30 glucose residues and linkage at the branch points is  $\alpha(1\rightarrow6)$  glycosidic (Figure 9).

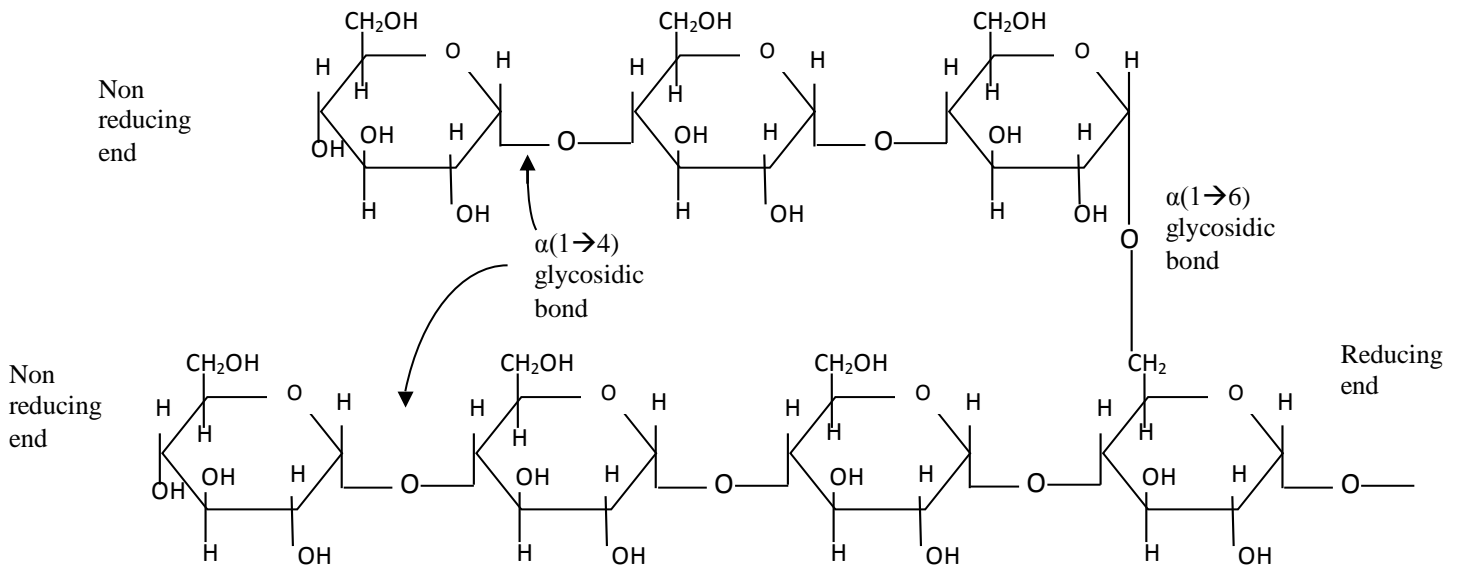


Figure 9: Structure of amylopectin.

Starch is insoluble in water, alcohol and ether at room temperature. It is highly hydrated since it contains many exposed  $-\text{OH}$  groups. It is non-reducing polysaccharide since the carbonyl groups of all units (except the last unit at the terminus) are involved in glycosidic bond formation. Characteristic blue colour of the starch with iodine is due to amylose. The amylose is an open, helical molecule, the inside diameter of the helix is large enough to accommodate iodine molecule. In contrast, most other polysaccharides including amylopectin, give only dull reddish brown colour with iodine.

### Glycogen

Glycogen is storage homopolysaccharide of animals and is consist of glucose units linked by  $\alpha(1\rightarrow4)$  glycoside linkage like amylopectin in starch. Branching is more extensive as compared to amylopectin, occur every 8 to 14 glucose residues and linkage at the branch points is  $\alpha(1\rightarrow6)$  glycosidic. Each glycogen molecule contains up to 120,000 glucose units. Muscle cells contain glycogen at 1-2% of their dryweight, and liver cells contain up to 10% of their dry weight as glycogen, which is sufficient for >12 hour energy supply for the body. Glycogen granules contain enzymes that catalyze glycogen synthesis and breakdown, as well as enzymes that regulate these processes.

Glycogen's highly branched structure is physiologically significant; it permits glycogen's rapid degradation through the simultaneous release of the glucose units at the end of every branch. In animals the fat is far more abundant in the body and can serve the same purpose as glycogen but still body uses glycogen as storage energy. The reason for that is 1.) muscle can not mobilize fat as rapidly as glycogen, 2.) the fatty acid residues of the fat can not be metabolized anaerobically, and 3.) animals can not convert fatty acids to glucose, so fat metabolism alone cannot adequately maintain essential blood glucose levels. Cells can only metabolize glucose monomers but cannot store glucose within cells.

Storage of glucose monomers in the form of starch (in plants) and glycogen (in animals) greatly reduces the large intracellular osmotic pressure that would result from its storage in monomeric form. Osmotic pressure is proportional to the number of solute molecules in a given volume.

## Cellulose

Cellulose is most abundant extracellular structural polysaccharide of the plants. It is also most abundant of all biomolecules in the biosphere. It is primary structural component of plant cell wall. Cellulose is linear polymer of upto 15000 D-glucose units linked by  $\beta(1 \rightarrow 4)$  glucosidic bonds.

In plant cell walls, the cellulose fibres are embedded in and cross-linked by a matrix of several polysaccharides that are composed of glucose as well as other monosaccharides. In wood this cementing matrix also contains a large proportion of lignin, a plastic like polymer.  $\beta$ -D-glucose monomers in cellulose form extensive hydrogen bonded structure that gives cellulose fibres exceptional strength and make them water insoluble despite their hydrophilicity. Unlike starch it gives no colour with iodine and lacks sweetness. It is of no nutritive value as it is chemically unreactive, however, its non-reactive property make it so useful fibers for paper and cloth.

Vertebrates lack the enzyme that hydrolyse  $\beta(1 \rightarrow 4)$  linkages of cellulose. However, the digestive tracts of herbivores contain symbiotic microorganisms that secrete a series of enzymes called cellulase that readily digests cellulose. Termites also digest cellulose because their gut contains parasitic protozoa, Trichonympha, which secrete cellulase. Cellulase is also produced by wood-rot fungi and bacteria.

Degradation of cellulose is slow process because it is tightly packed and hydrogen bonded polymer chains are not easily accessible to cellulase and do not separate readily even after many of their glycosidic bonds have been cleaved. The digestion of fibrous plants such as grass by herbivores is therefore a more complex and time consuming process than is the digestion of meat by carnivores. Similarly, the decay of dead plants by fungi, bacteria and other microorganisms, and the consumption of wooden houses by termites, often takes years.

## Chitin

Chitin is the second most abundant polysaccharide in nature after cellulose. Chitin is main structural component of the exoskeleton of invertebrates such as crustaceans, insects and spiders. It is also main component of cell walls of most fungi. It is a linear polysaccharide of  $\beta(1 \rightarrow 4)$  linked N-acetyl-D-glucosamine residues. Chitin and cellulose have similar structures except that C<sub>2</sub>-OH group of cellulose is replaced by an acetamido group in chitin. Extensive hydrogen bonding of N-acetyl side chains makes chitin tough, and insoluble polymer. Like cellulose chitin is not degraded by vertebrate animals. Chitinases (enzyme present in gastric juice of snails or from bacteria) decompose the chitin to N-acetyl-D-glucosamine.

## Dextrans

Dextrans are formed when some microorganisms like yeast and bacteria are grown in sucrose solution. It is made up of D-glucose residues but the molecular structure varies with type and strain of the microorganism forming them. Dextrans formed by majority of microorganisms is made up of  $\alpha(1 \rightarrow 6)$  linked glucosides. All dextrans contain  $\alpha(1 \rightarrow 3)$  branching points and some also contain  $\alpha(1 \rightarrow 2)$  or  $\alpha(1 \rightarrow 4)$  branches. Dextrans provide a source of glucose for bacterial metabolism. Synthetic dextrans are used in several commercial products (e.g. sephadex) that are used in the fractionation of proteins by size exclusion chromatography. The dextrans in these products are chemically cross-linked to form insoluble materials of various sizes.

## Inulin

Inulin is storage polysaccharide of plants composed of D-fructose residues. It occurs in the tubers of artichoke and dahlias and roots of dandelions. Bulbs of onion and garlic also contain inulin. Inulin is not found in animals. It is composed of straight chain of polyfructose residues of 30-35 number and molecular weight of about 5000. It is formed by glycosidic linkage between -OH group of C-2 one  $\beta$ -D-fructose unit and -OH group on C-1 of adjacent  $\beta$ -D-fructose unit. Inulin therefore contain  $\beta(2 \rightarrow 1)$  glycosidic bond.

It is non-reducing, levorotatory sugar soluble in hot water but does not gelatinize as starch does. Unlike starch it does not give characteristic blue colour with iodine. Inulin is not hydrolysed by amylase but is cleaved by inulinase. It is not hydrolysed by any of the enzymes of the gastrointestinal tract and is therefore not utilized as food. Inulin is used as a source of commercial fructose. It is also administered to animals in studies of glomerular membrane filtration rates.

### **Pectin**

Pectin is structural carbohydrate made up of mixture of polysaccharides that hold cellulose fibrils together. It is found in pulp of ripe fruits such as citrus fruits, apples, guava etc. it is present in cell wall in an insoluble form. Pectic acid is a polysaccharide of  $\alpha$ -D-galacturonic acid. Some of the free  $-\text{COOH}$  groups are esterified with methyl alcohol and others are combined with Ca and Mg ions. Pectin provides stability and solidity to plants. Pectin is used in the fruit conserving industry.

### **Xylan**

Xylans and related substances are collectively known as hemicelluloses. They are abundant in unrefined cereals, vegetables and in some fruits. Hemicelluloses consist of either pentoses (e.g. xylose, arabinose) or hexoses (e.g. glucose, mannose, galactose). Unlike cellulose they are partially soluble in alkali and water. They play storage and supporting role in plants. They absorb water and are partially digestible.

Xylan is a complex polysaccharide and closely associated with cellulose in lignified cell walls of plants. It is a linear polymer of D-xylose linked by  $\beta(1 \rightarrow 4)$  bond having side chain of 4-O-methylglucuronic acid and/or arabinose. The numbers of xylose residues vary from 30 to 100. Microorganisms can degrade xylan more rapidly than cellulose. Many cellulase producing organisms also produce xylanase, thus they can utilize xylan.

### **Heteropolysaccharides**

Heteropolysaccharides yield a mixture of monosaccharide on hydrolysis. They are present in extracellular matrix of plants, animals and bacteria.

### **Agar**

Agar is gelatinous polysaccharide produced in cell wall of marine red algae such as species of *Gelidium*, *Gracilaria*, *Gigartina* etc. It is a mixture of sulphated heteropolysaccharides made up of D-galactose and L-galactose derivatives ether-linked between C<sub>3</sub> and C<sub>6</sub>. Agarose is the agar component with fewest charged groups (sulfates, pyruvates). It has molecular weight of 150000. If agar and agarose are dissolved in hot water they form sol which upon cooling sets to a gel. Agarose gels are used as inert support for the electrophoretic separation of nucleic acids. Agar is used to form a surface for the growth of bacterial and plant tissue cultures.

### **Peptidoglycan**

Peptidoglycan constitutes the rigid component of bacterial cell wall. It is heteropolysaccharide of alternating  $\beta(1 \rightarrow 4)$  linked N-acetyl-D-glucosamine and N-acetyl muramic acid residues. The linear polysaccharide chains are cross linked by short peptides attached to N-acetyl muramic acid. Cross linking by peptide welds the polysaccharide chains into a strong sheath that envelops the entire cell and prevents osmotic rupture of the cell. Lysozyme, which is an enzyme present in human tears kills bacteria by hydrolyzing the  $\beta(1 \rightarrow 4)$  glycosidic linkage of peptidoglycan. Some bacteriophages also produce lysozyme for releasing themselves from the host. An antibiotic penicillin kills bacteria by preventing the cross linking process and therefore making the cell wall weak to resist osmotic lysis.