

ELECTRONIC DEVICES AND CIRCUIT THEORY

TENTH EDITION

BOYLESTAD

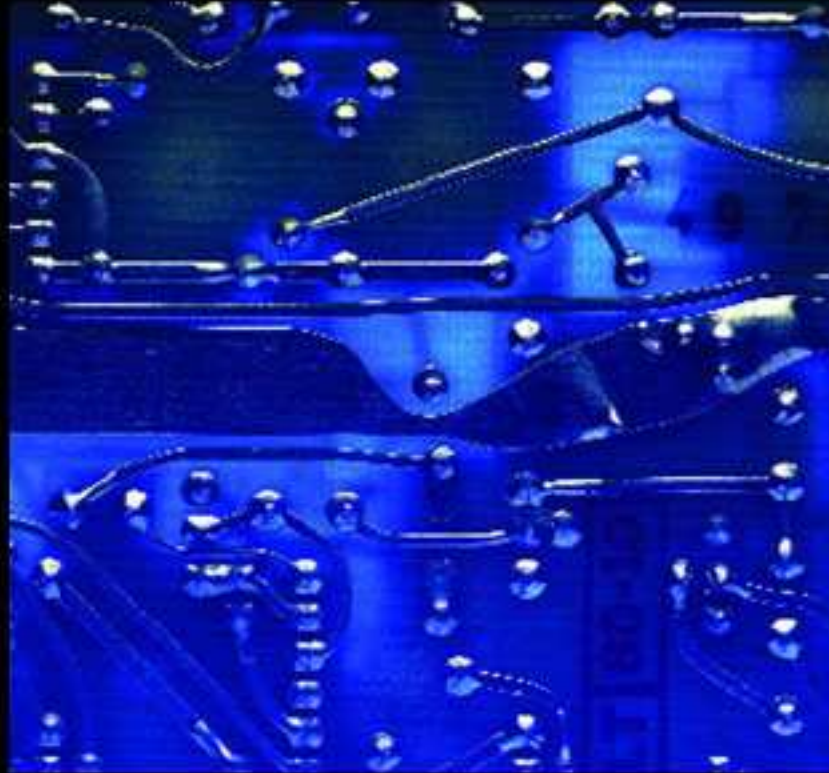

PEARSON

Chapter 3: Bipolar Junction Transistors

Transistor Construction

There are two types of transistors:

- *pnp*
- *npn*

The terminals are labeled:

- **E - Emitter**
- **B - Base**
- **C - Collector**

pnp

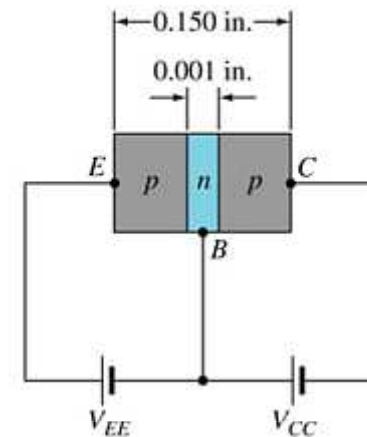

npn

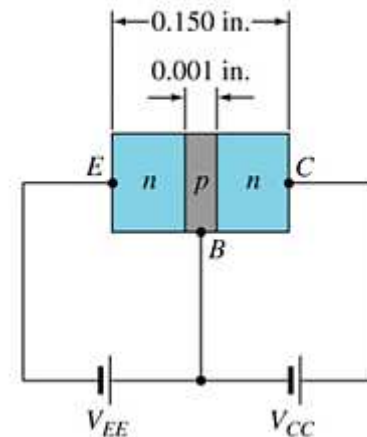

Transistor Operation

With the external sources, V_{EE} and V_{CC} , connected as shown:

- The emitter-base junction is forward biased
- The base-collector junction is reverse biased

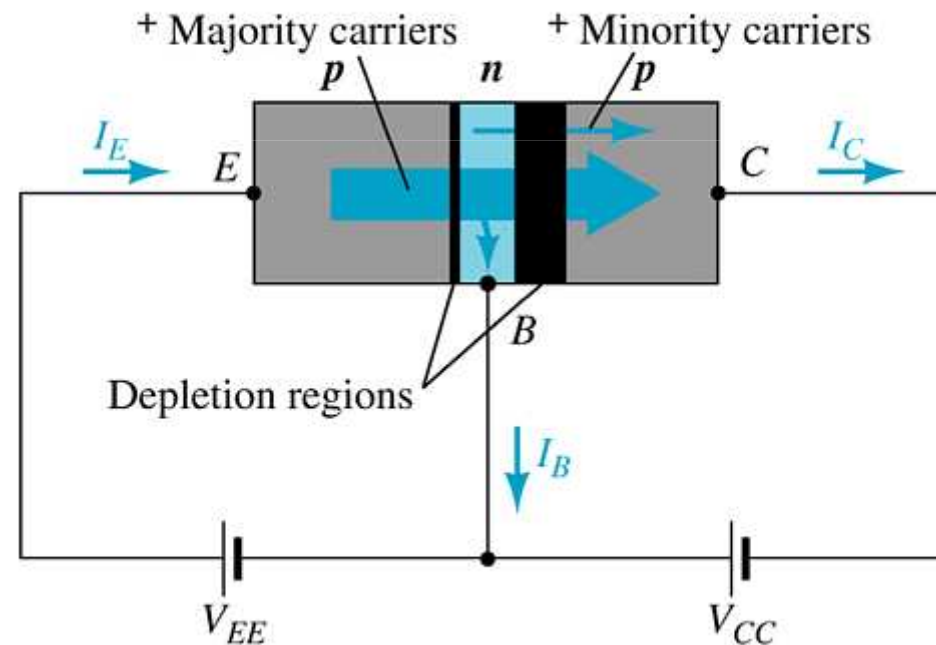

Currents in a Transistor

Emitter current is the sum of the collector and base currents:

$$I_E = I_C + I_B$$

The collector current is comprised of two currents:

$$I_C = I_{C_{\text{majority}}} + I_{C_{\text{minority}}}$$

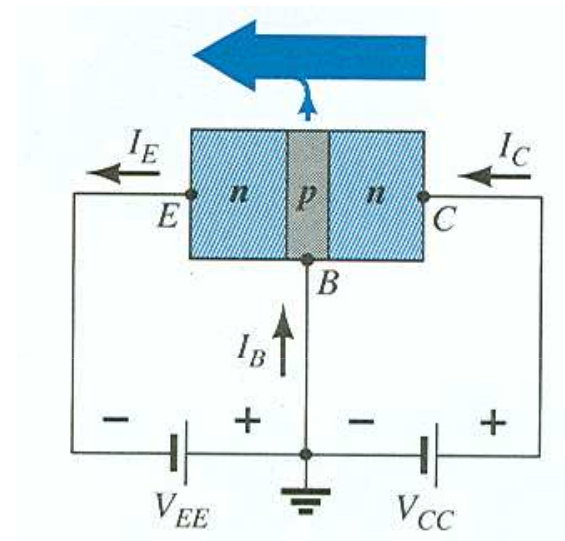

Common-Base Configuration

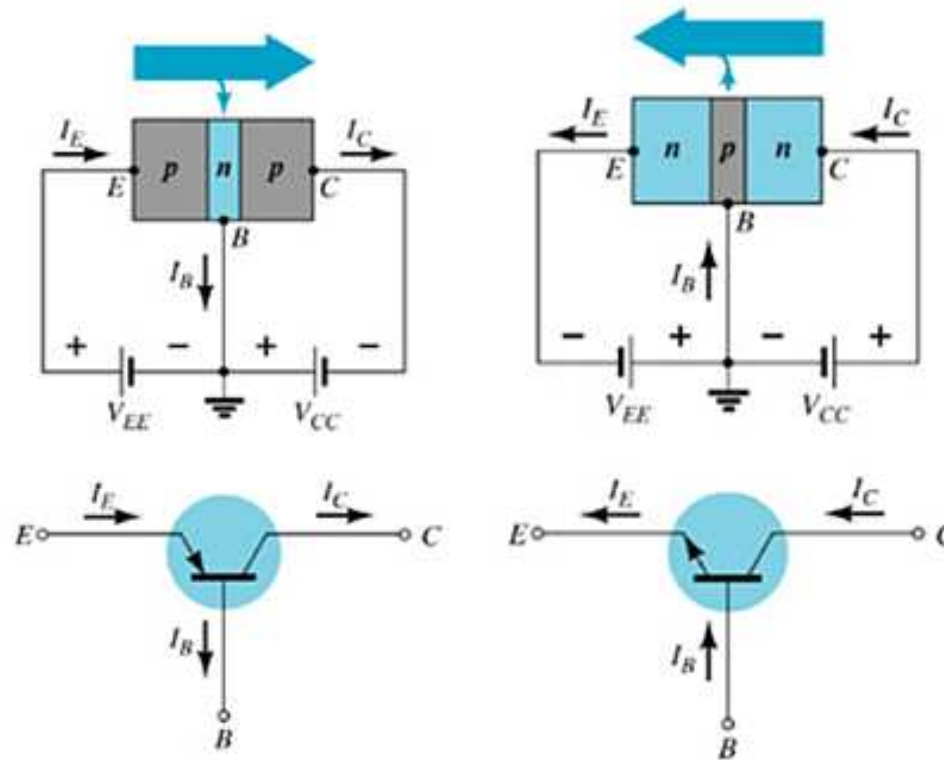

The base is common to both input (emitter–base) and output (collector–base) of the transistor.

Common-Base Amplifier

Input Characteristics

This curve shows the relationship between of input current (I_E) to input voltage (V_{BE}) for three output voltage (V_{CB}) levels.

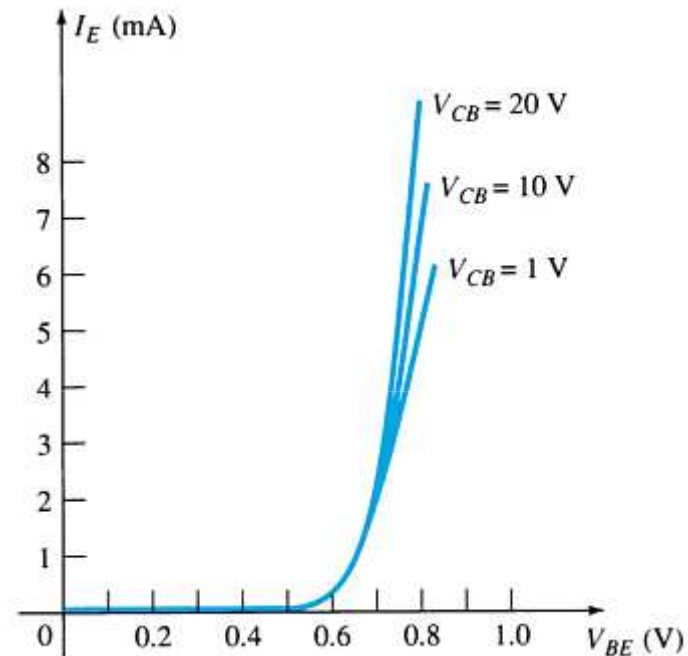

Common-Base Amplifier

Output Characteristics

This graph demonstrates the output current (I_C) to an output voltage (V_{CB}) for various levels of input current (I_E).

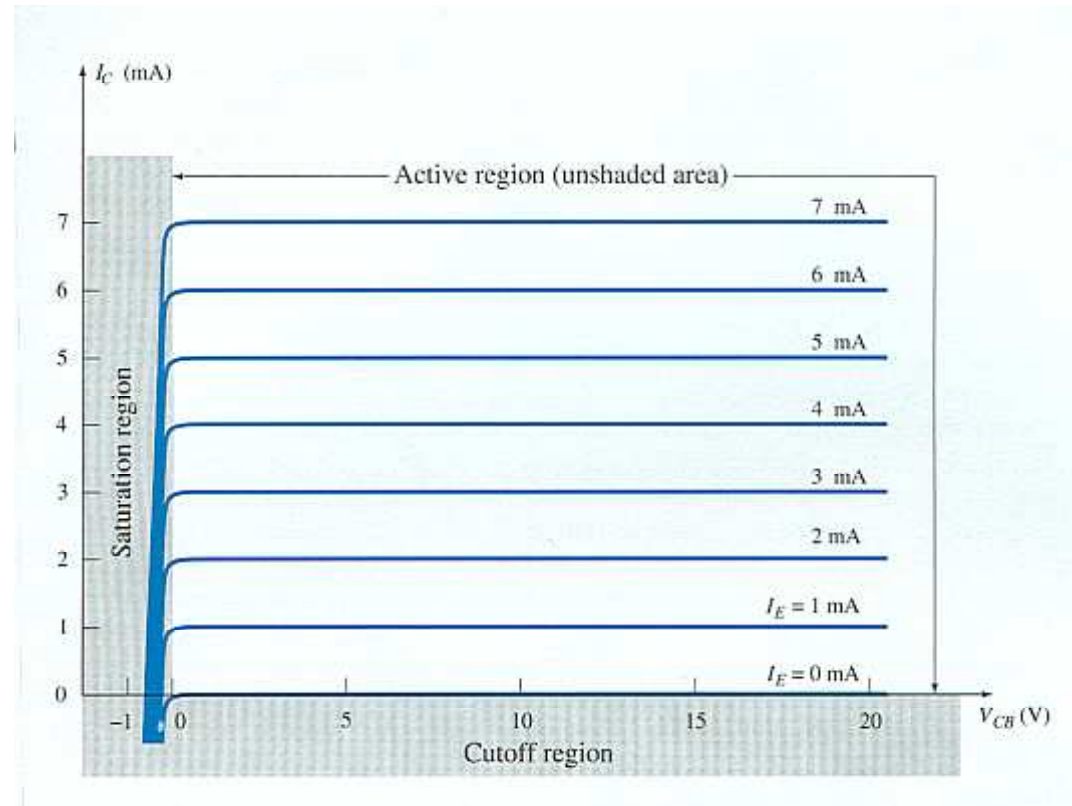

Operating Regions

- **Active** – Operating range of the amplifier.
- **Cutoff** – The amplifier is basically off. There is voltage, but little current.
- **Saturation** – The amplifier is full on. There is current, but little voltage.

Approximations

Emitter and collector currents:

$$I_C \cong I_E$$

Base-emitter voltage:

$$V_{BE} = 0.7 \text{ V (for Silicon)}$$

Alpha (α)

Alpha (α) is the ratio of I_C to I_E :

$$\alpha_{\text{dc}} = \frac{I_C}{I_E}$$

Ideally: $\alpha = 1$

In reality: α is between 0.9 and 0.998

Alpha (α) in the AC mode:

$$\alpha_{\text{ac}} = \frac{\Delta I_C}{\Delta I_E}$$

Transistor Amplification

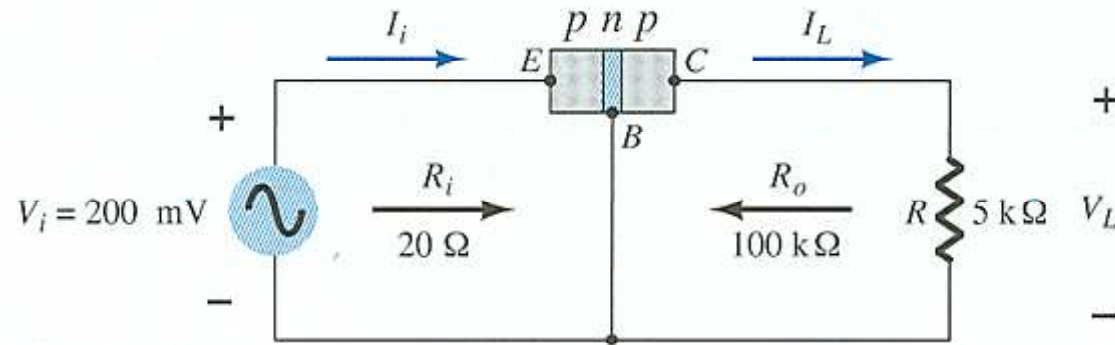

Currents and Voltages:

$$I_E = I_i = \frac{V_i}{R_i} = \frac{200\text{mV}}{20\Omega} = 10\text{mA}$$

$$I_C \cong I_E$$

$$I_L \cong I_i = 10 \text{ mA}$$

$$V_L = I_L R = (10 \text{ ma})(5 \text{ k}\Omega) = 50 \text{ V}$$

Voltage Gain:

$$A_v = \frac{V_L}{V_i} = \frac{50\text{V}}{200\text{mV}} = 250$$

Common-Emitter Configuration

The emitter is common to both input (base-emitter) and output (collector-emitter).

The input is on the base and the output is on the collector.

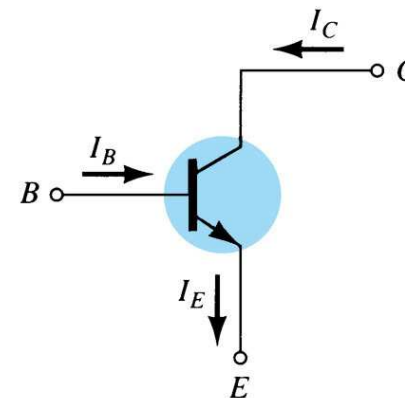
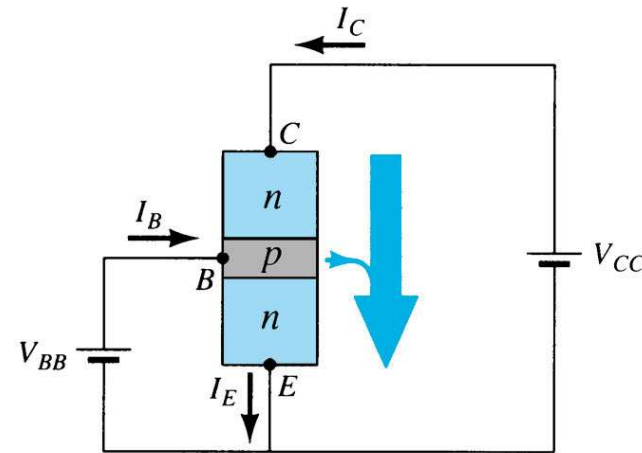

(a)

Common-Emitter Characteristics

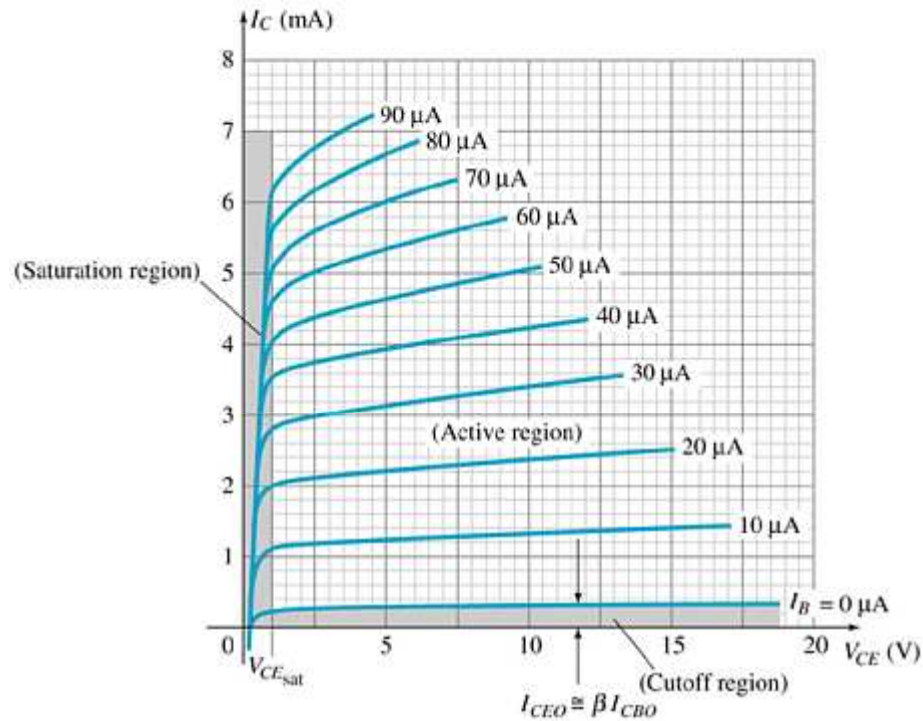

Collector Characteristics

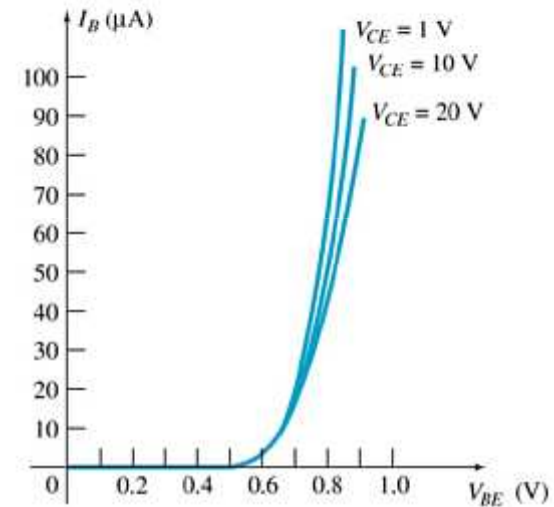

Base Characteristics

Common-Emitter Amplifier Currents

Ideal Currents

$$I_E = I_C + I_B$$

$$I_C = \alpha I_E$$

Actual Currents

$$I_C = \alpha I_E + I_{CBO} \quad \text{where } I_{CBO} = \text{minority collector current}$$

I_{CBO} is usually so small that it can be ignored, except in high power transistors and in high temperature environments.

When $I_B = 0 \mu\text{A}$ the transistor is in cutoff, but there is some minority current flowing called I_{CEO} .

$$I_{CEO} = \frac{I_{CBO}}{1 - \alpha} \Big|_{I_B = 0 \mu\text{A}}$$

Beta (β)

β represents the amplification factor of a transistor. (β is sometimes referred to as h_{fe} , a term used in transistor modeling calculations)

In DC mode:

$$\beta_{dc} = \frac{I_C}{I_B}$$

In AC mode:

$$\beta_{ac} = \left. \frac{\Delta I_C}{\Delta I_B} \right|_{V_{CE} = \text{constant}}$$

Beta (β)

Determining β from a Graph

$$\begin{aligned}\beta_{AC} &= \frac{(3.2\text{mA} - 2.2\text{mA})}{(30\mu\text{A} - 20\mu\text{A})} \\ &= \frac{1\text{mA}}{10\mu\text{A}} \Big|_{V_{CE}=7.5} \\ &= 100\end{aligned}$$

$$\begin{aligned}\beta_{DC} &= \frac{2.7\text{mA}}{25\mu\text{A}} \Big|_{V_{CE}=7.5} \\ &= 108\end{aligned}$$

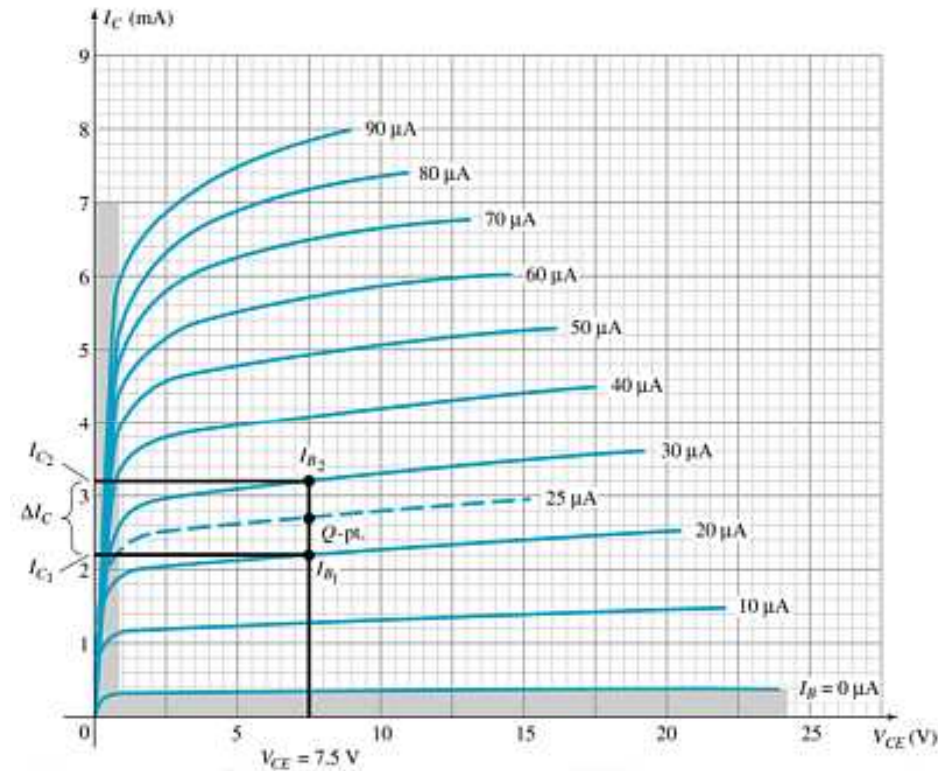

Beta (β)

Relationship between amplification factors β and α

$$\alpha = \frac{\beta}{\beta + 1} \qquad \beta = \frac{\alpha}{\alpha - 1}$$

Relationship Between Currents

$$I_C = \beta I_B \qquad I_E = (\beta + 1) I_B$$

Common-Collector Configuration

The input is on the base and the output is on the emitter.

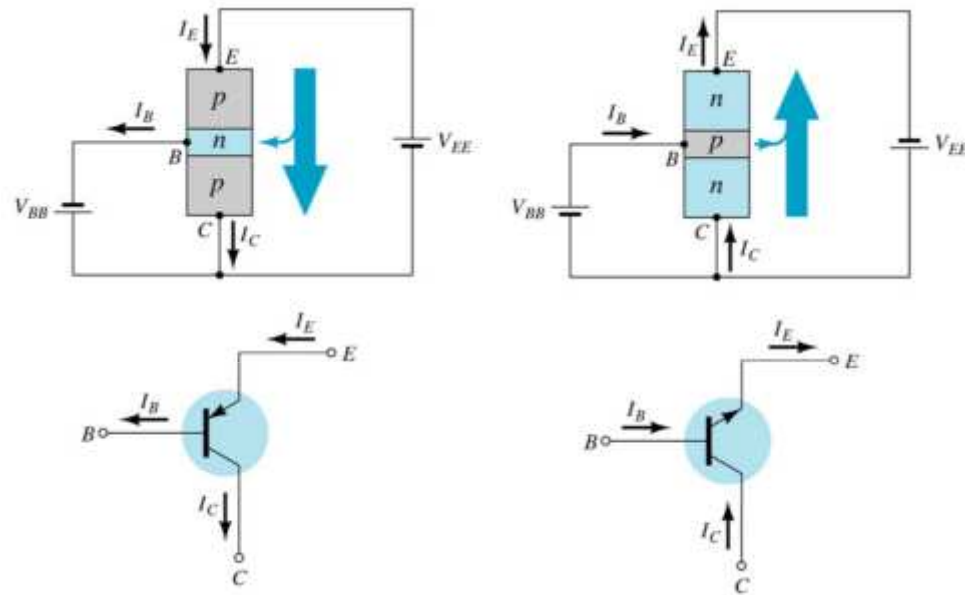

Common–Collector Configuration

The characteristics are similar to those of the common-emitter configuration, except the vertical axis is I_E .

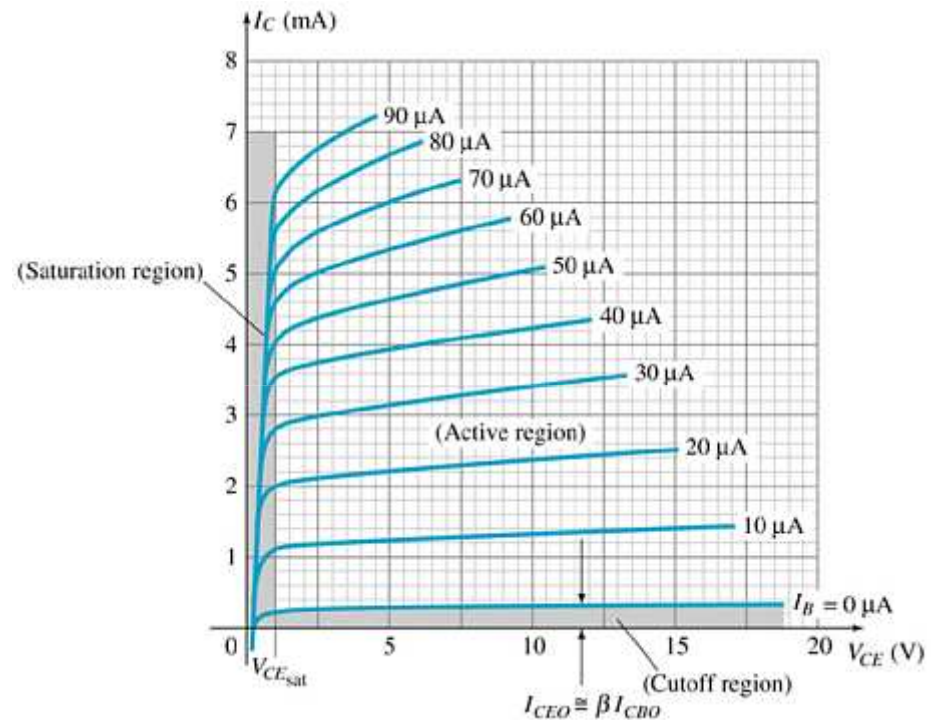

Operating Limits for Each Configuration

V_{CE} is at maximum and I_C is at minimum ($I_{C_{max}} = I_{CEO}$) in the cutoff region.

I_C is at maximum and V_{CE} is at minimum ($V_{CE_{max}} = V_{CE_{sat}} = V_{CEO}$) in the saturation region.

The transistor operates in the active region between saturation and cutoff.

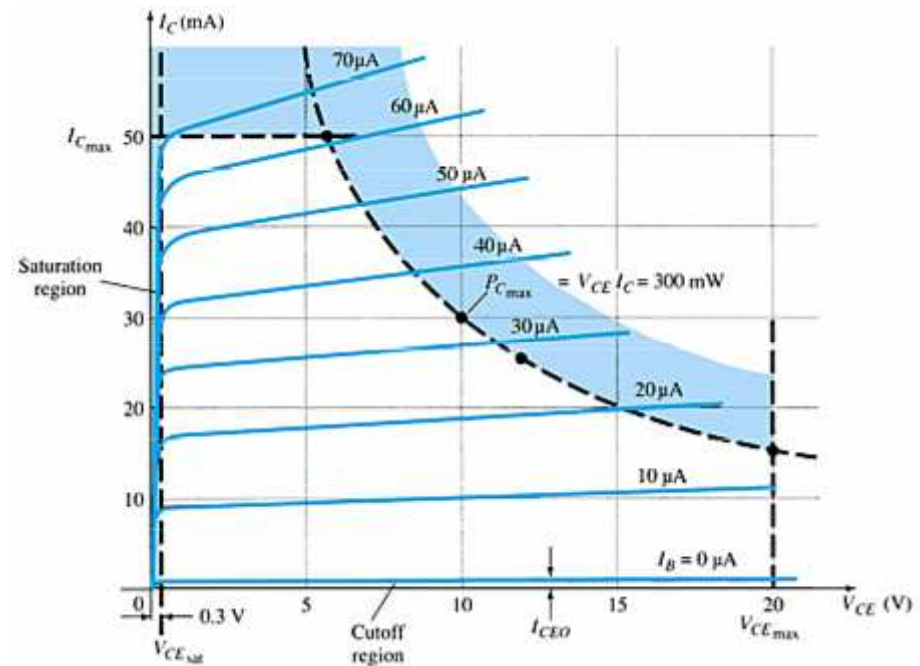

Power Dissipation

Common-base:

$$P_{Cmax} = V_{CB}I_C$$

Common-emitter:

$$P_{Cmax} = V_{CE}I_C$$

Common-collector:

$$P_{Cmax} = V_{CE}I_E$$

Transistor Specification Sheet

MAXIMUM RATINGS

Rating	Symbol	2N4123	Unit
Collector-Emitter Voltage	V_{CE0}	30	Vdc
Collector-Base Voltage	V_{CB0}	40	Vdc
Emitter-Base Voltage	V_{EB0}	5.0	Vdc
Collector Current – Continuous	I_C	200	mAdc
Total Device Dissipation @ $T_A = 25^\circ\text{C}$ Derate above 25°C	P_D	625 5.0	mW mW/°C
Operating and Storage Junction Temperature Range	T_j, T_{stg}	-55 to +150	°C

THERMAL CHARACTERISTICS

Characteristic	Symbol	Max	Unit
Thermal Resistance, Junction to Case	$R_{\theta JC}$	83.3	°C/W
Thermal Resistance, Junction to Ambient	$R_{\theta JA}$	200	°C/W

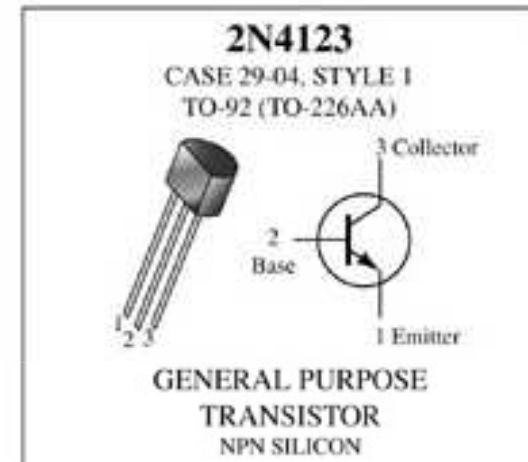

Transistor Specification Sheet

ELECTRICAL CHARACTERISTICS ($T_A = 25^\circ\text{C}$ unless otherwise noted)

Characteristic	Symbol	Min	Max	Unit
OFF CHARACTERISTICS				
Collector-Emitter Breakdown Voltage (1) ($I_C = 1.0\text{ mAdc}$, $I_E = 0$)	$V_{(BR)CEO}$	30		Vdc
Collector-Base Breakdown Voltage ($I_C = 10\text{ }\mu\text{Adc}$, $I_E = 0$)	$V_{(BR)CBO}$	40		Vdc
Emitter-Base Breakdown Voltage ($I_E = 10\text{ }\mu\text{Adc}$, $I_C = 0$)	$V_{(BR)EBO}$	5.0	-	Vdc
Collector Cutoff Current ($V_{CE} = 20\text{ Vdc}$, $I_E = 0$)	I_{CBO}	-	50	nAdc
Emitter Cutoff Current ($V_{BE} = 3.0\text{ Vdc}$, $I_C = 0$)	I_{EBO}	-	50	nAdc
ON CHARACTERISTICS				
DC Current Gain(1) ($I_C = 2.0\text{ mAdc}$, $V_{CE} = 1.0\text{ Vdc}$) ($I_C = 50\text{ mAdc}$, $V_{CE} = 1.0\text{ Vdc}$)	h_{FE}	50 25	150 -	-
Collector-Emitter Saturation Voltage(1) ($I_C = 50\text{ mAdc}$, $I_B = 5.0\text{ mAdc}$)	$V_{CE(sat)}$	-	0.3	Vdc
Base-Emitter Saturation Voltage(1) ($I_C = 50\text{ mAdc}$, $I_B = 5.0\text{ mAdc}$)	$V_{BE(sat)}$	-	0.95	Vdc
SMALL-SIGNAL CHARACTERISTICS				
Current-Gain – Bandwidth Product ($I_C = 10\text{ mAdc}$, $V_{CE} = 20\text{ Vdc}$, $f = 100\text{ MHz}$)	f_T	250		MHz
Output Capacitance ($V_{CE} = 5.0\text{ Vdc}$, $I_E = 0$, $f = 100\text{ MHz}$)	C_{obo}	-	4.0	pF
Input Capacitance ($V_{BE} = 0.5\text{ Vdc}$, $I_C = 0$, $f = 100\text{ kHz}$)	C_{ibo}	-	8.0	pF
Collector-Base Capacitance ($I_E = 0$, $V_{CB} = 5.0\text{ V}$, $f = 100\text{ kHz}$)	C_{cb}	-	4.0	pF
Small-Signal Current Gain ($I_C = 2.0\text{ mAdc}$, $V_{CE} = 10\text{ Vdc}$, $f = 1.0\text{ kHz}$)	h_{fe}	50	200	-
Current Gain – High Frequency ($I_C = 10\text{ mAdc}$, $V_{CE} = 20\text{ Vdc}$, $f = 100\text{ MHz}$) ($I_C = 2.0\text{ mAdc}$, $V_{CE} = 10\text{ V}$, $f = 1.0\text{ kHz}$)	h_{fe}	2.5 50	- 200	-
Noise Figure ($I_C = 100\text{ }\mu\text{Adc}$, $V_{CE} = 5.0\text{ Vdc}$, $R_S = 1.0\text{ k ohm}$, $f = 1.0\text{ kHz}$)	NF	-	6.0	dB

(1) Pulse Test: Pulse Width = 300 μs , Duty Cycle = 2.0%

Transistor Testing

- **Curve Tracer**
Provides a graph of the characteristic curves.
- **DMM**
Some DMMs measure β_{DC} or h_{FE} .
- **Ohmmeter**

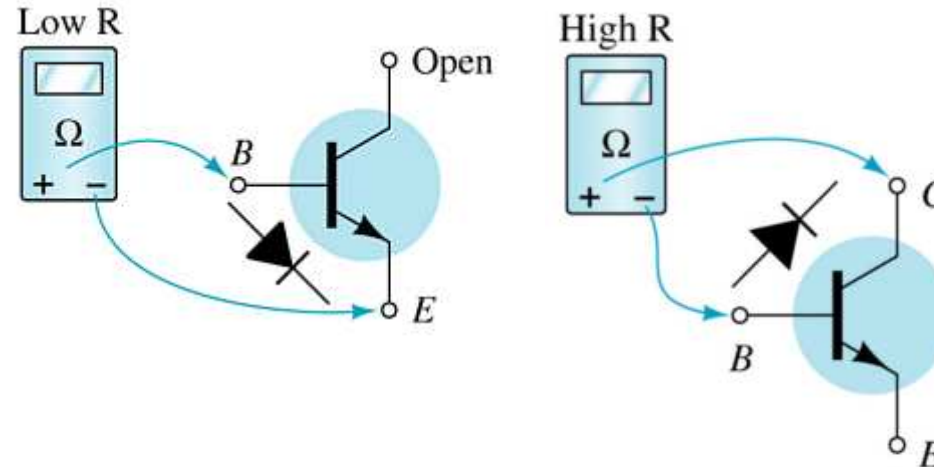

Transistor Terminal Identification

