

A 3D molecular model of DNA and RNA. The DNA is shown as a double helix with blue spheres representing the sugar-phosphate backbone and green and orange cylinders representing the nitrogenous base pairs. The RNA is shown as a single strand with a similar backbone and a different base pairing scheme. The model is set against a white background with a green border on the left and top edges.

Structure Of DNA & RNA

By Himanshu Dev
VMCC & SJH

DNA

random|plai|id

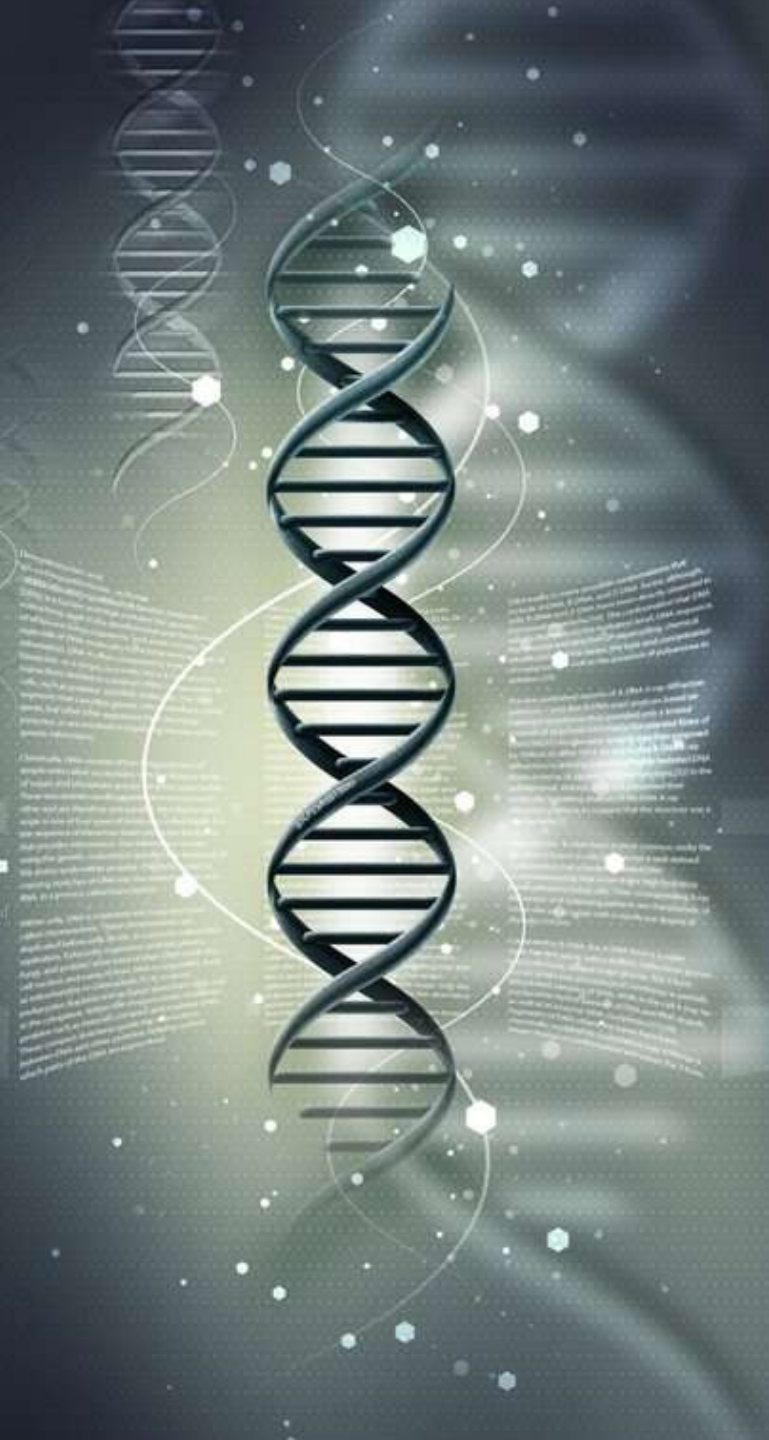



DNA

- Deoxyribonucleic acid
- DNA - a polymer of deoxyribonucleotides.
- Usually double stranded.
- And have double-helix structure.
- found in chromosomes, mitochondria and chloroplasts.
- It acts as the genetic material in most of the organisms.
- Carries the genetic information

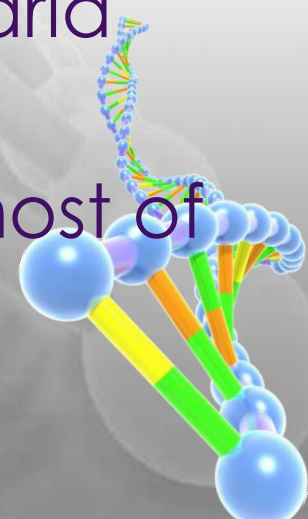

A Few Key Events Led to the Discovery of the Structure of DNA

- DNA as an acidic substance present in nucleus was first identified by **Friedrich Meischer** in 1868.
- He named it as 'Nuclein'.

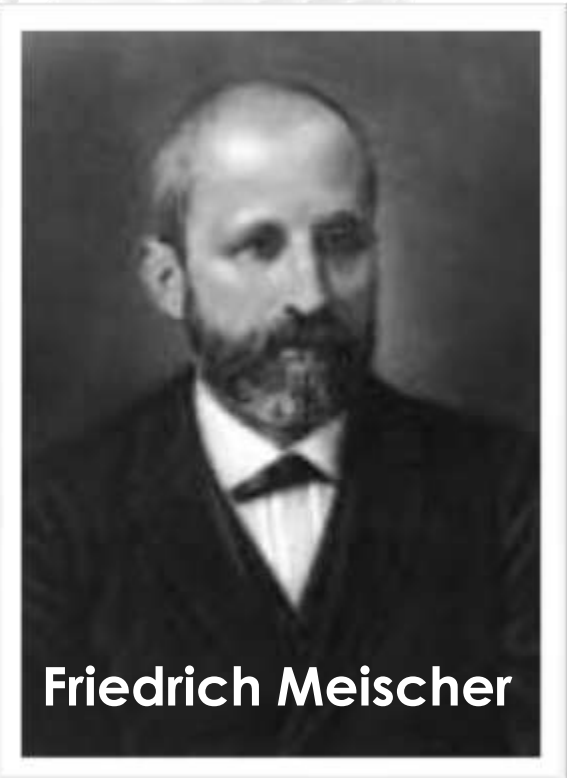
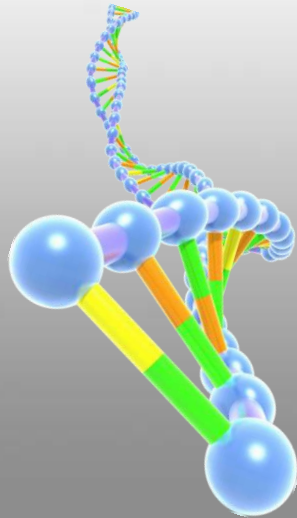

Friedrich Meischer

➤ In 1953, **James Watson and Francis Crick**, described a very simple but famous **Double Helix** model for the structure of DNA.



FRANCIS CRICK AND JAMES WATSON



- The scientific framework for their breakthrough was provided by other scientists including
 - Linus Pauling
 - Rosalind Franklin and Maurice Wilkins
 - Erwin Chargaff



❖ Rosalind Franklin

- She worked in same laboratory as Maurice Wilkins.
- She study X-ray diffraction to study wet fibers of DNA.

X-ray diffraction
of wet DNA fibers

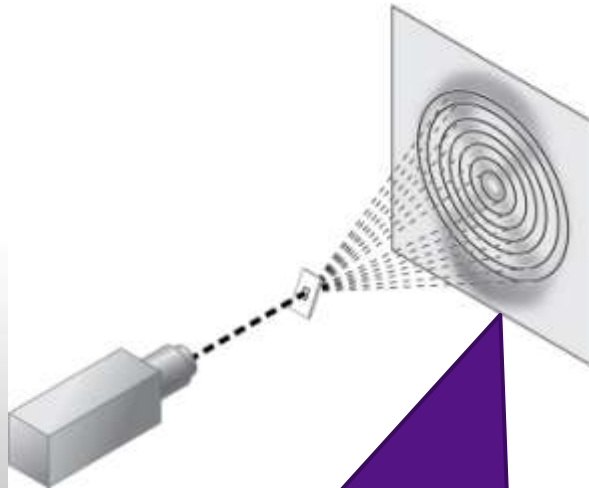

The diffraction pattern is interpreted
(using mathematical theory)
This can ultimately provide
information concerning the structure
of the molecule

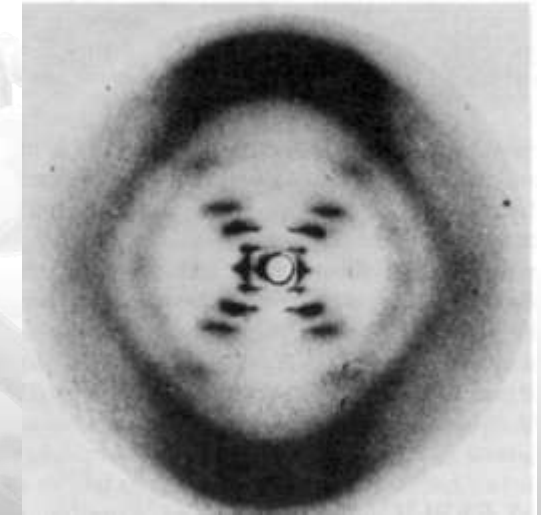

X Ray
Crystallography
Rosalind
Franklin's photo

- She made marked advances in X-ray diffraction techniques with DNA
- The diffraction pattern she obtained suggested several structural features of DNA
 - Helical
 - More than one strand
 - 10 base pairs per complete turn

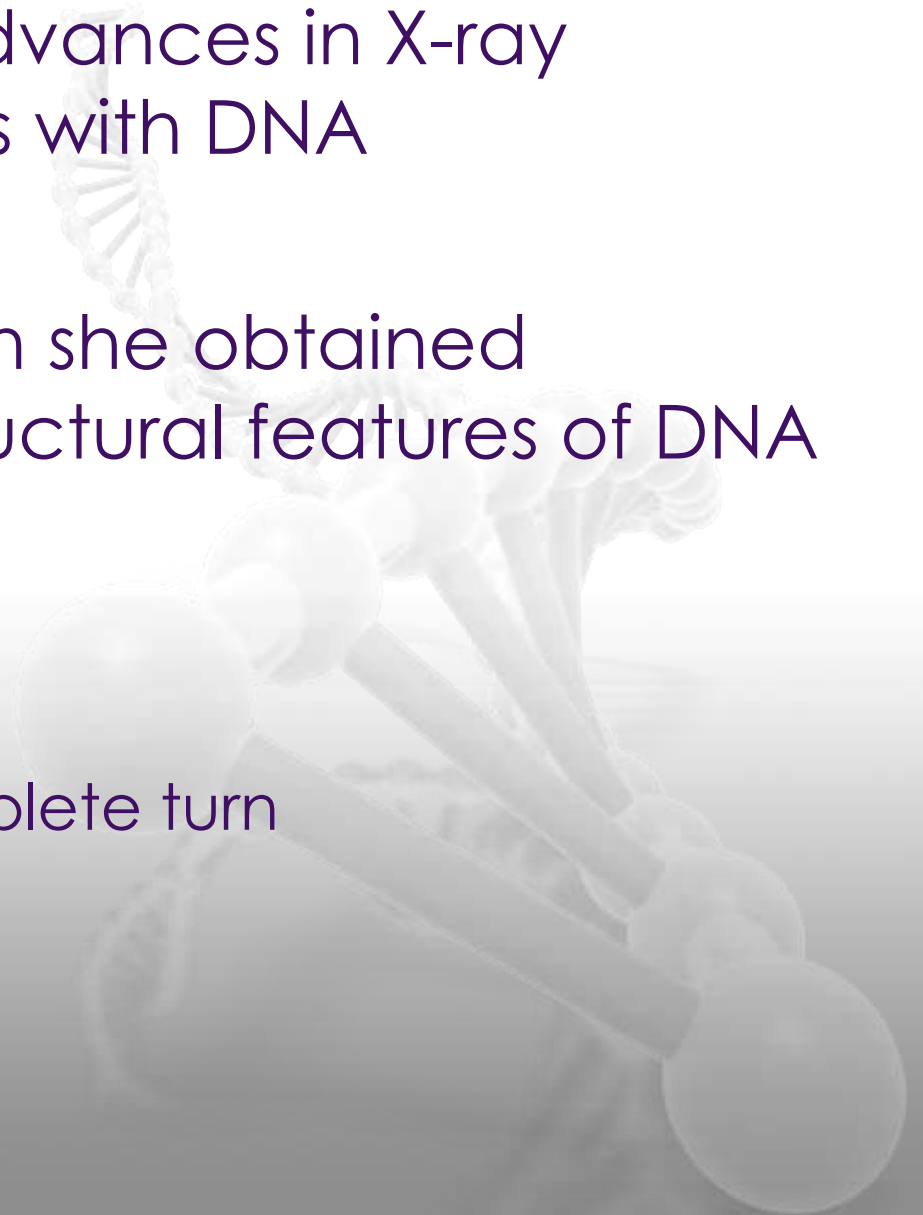

Rosalind Franklin



Maurice Wilkins

❖ DNA Structure

- DNA structure is often divided into four different levels primary, secondary, tertiary and quaternary.
- DNA has three main components
 - 1. Deoxyribose (a pentose sugar)
 - 2. Base (there are four different ones)
 - 3. Phosphate

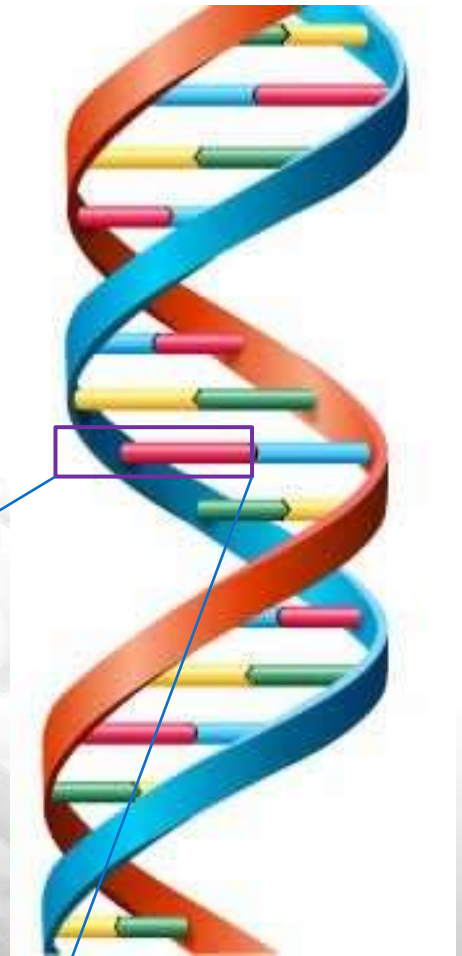
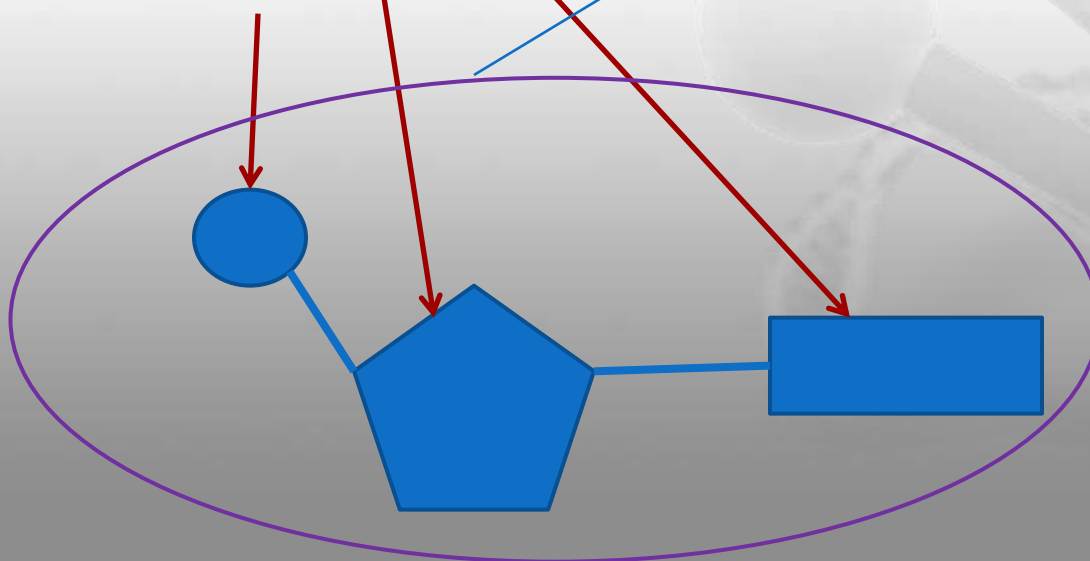

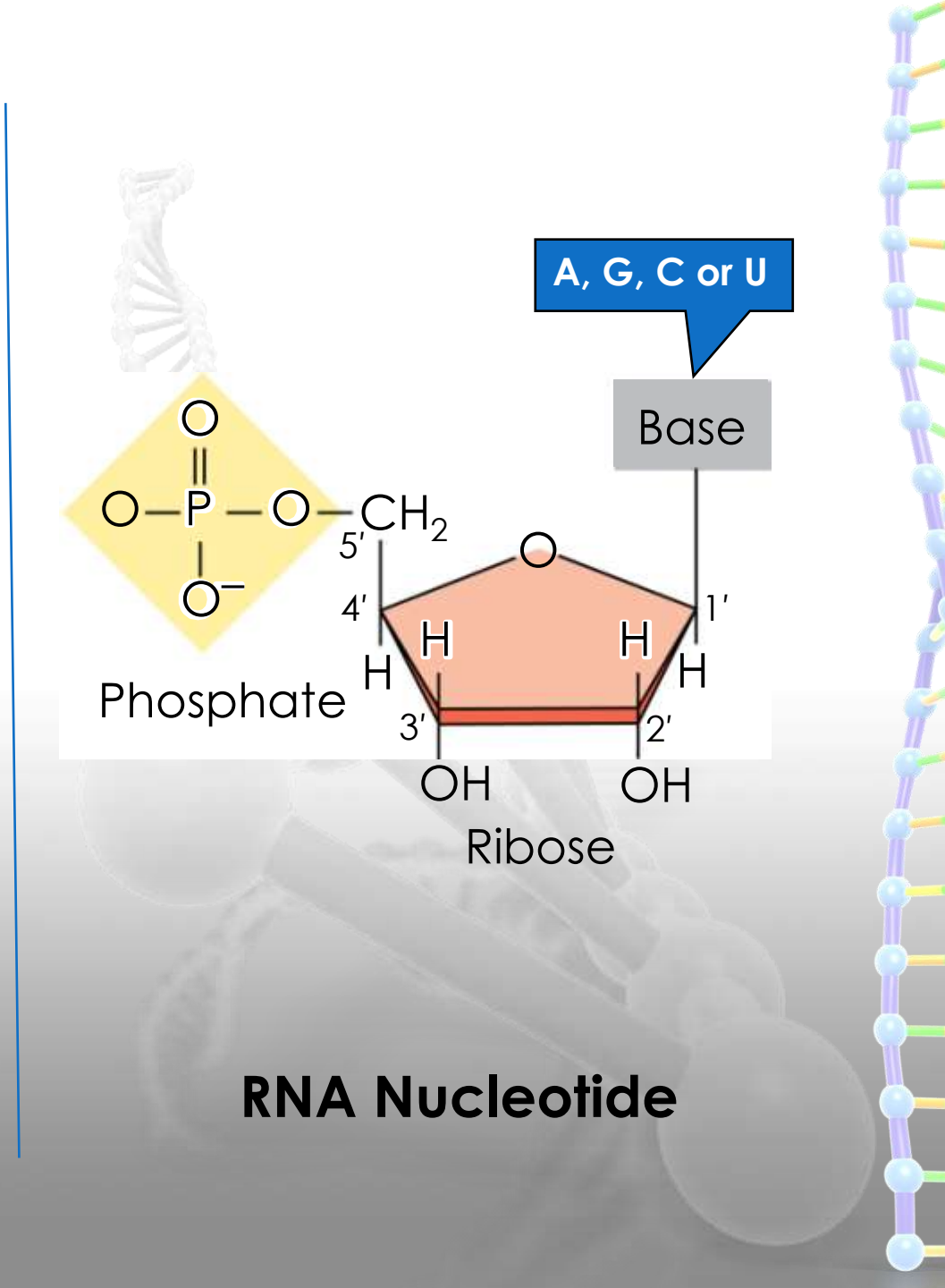
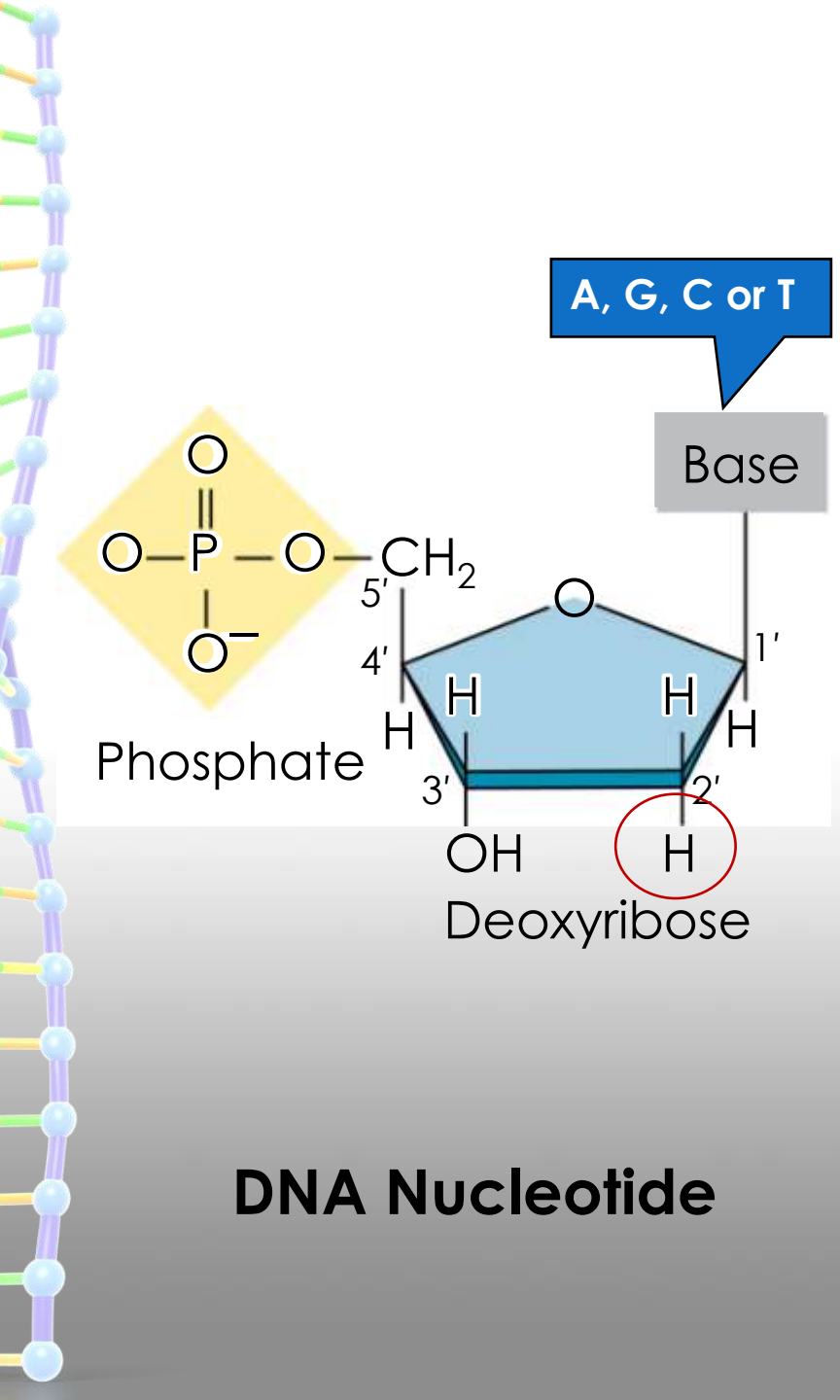

❖ The Nitrogenous Bases

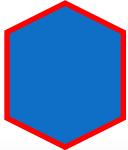
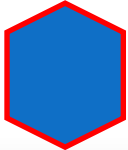
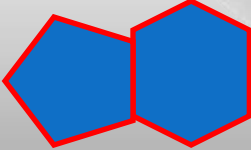
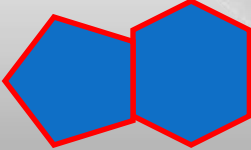
- THEY ARE DIVIDED INTO TWO GROUPS
 - Pyrimidines and purines
- PYRIMIDINES (MADE OF ONE 6 MEMBER RING)
 - Thymine 
 - Cytosine 
- PURINES (MADE OF A 6 MEMBER RING, FUSED TO A 5 MEMBER RING)
 - Adenine 
 - Guanine 
- THE RINGS ARE NOT ONLY MADE OF CARBON

❖ Nitrogenous bases of DNA & RNA

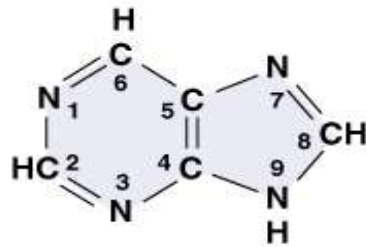

Purine
(parent compound)

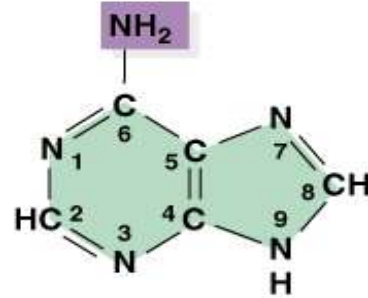

Adenine (A)

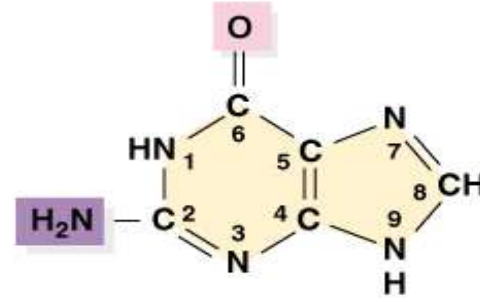

Guanine (G)

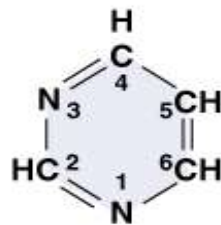

Pyrimidine
(parent
compound)

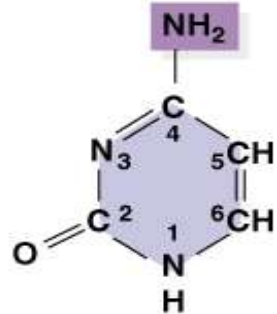

Cytosine (C)

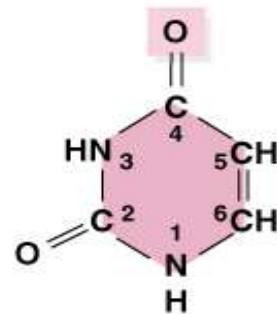

Uracil (U)
(found in RNA)

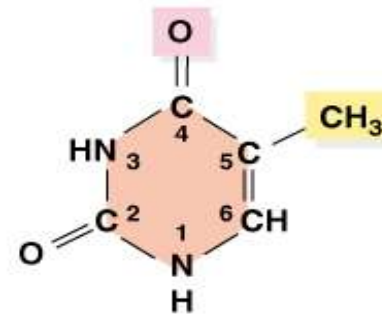

Thymine (T)
(found in DNA)

❖ Nucleotide Structure

- Nucleotides are formed by the condensation of a sugar, phosphate and one of the 4 bases
- The following illustration represents one nucleotide

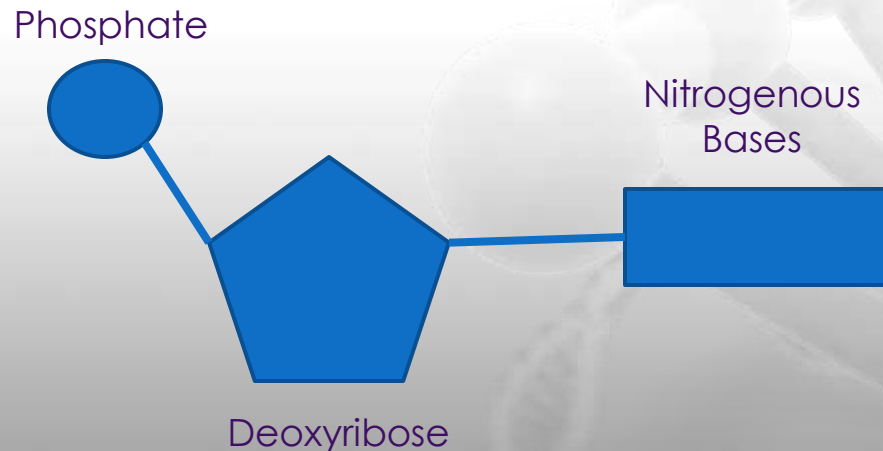

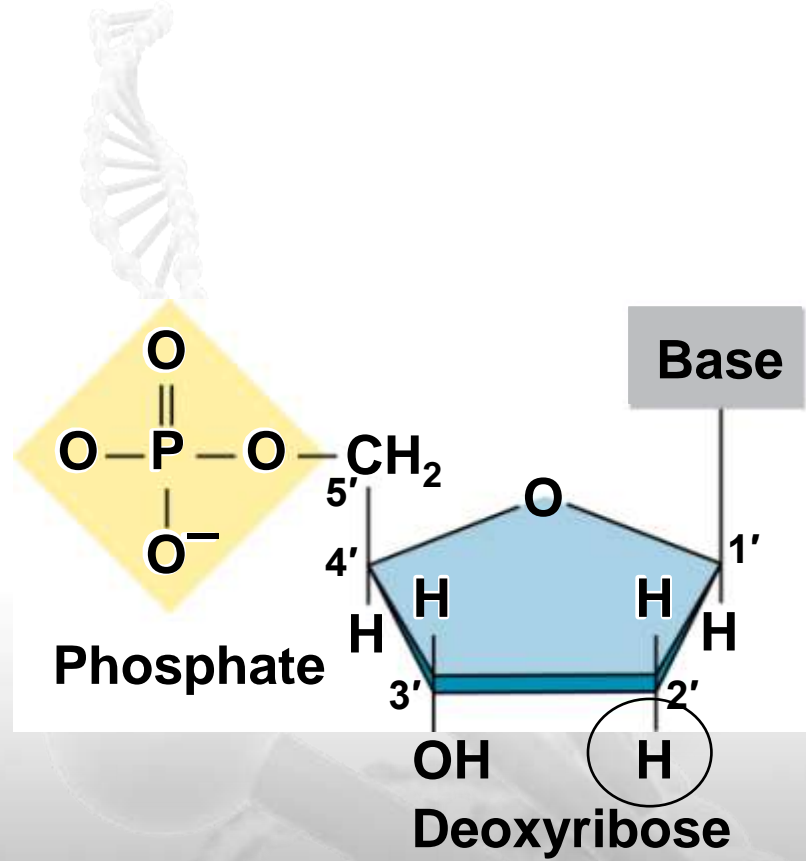
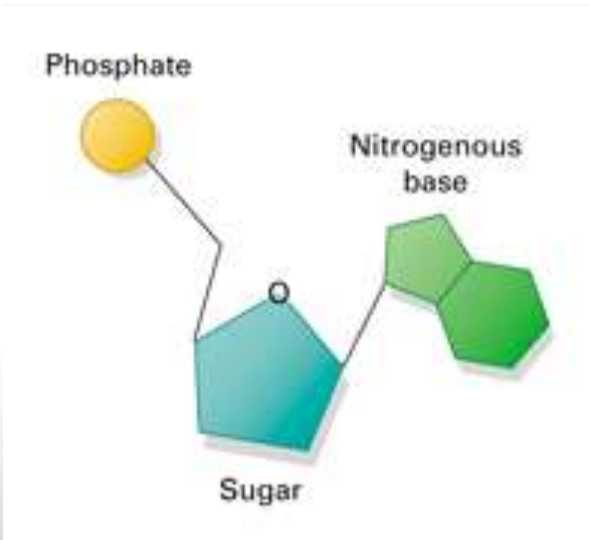

DNA nucleotide

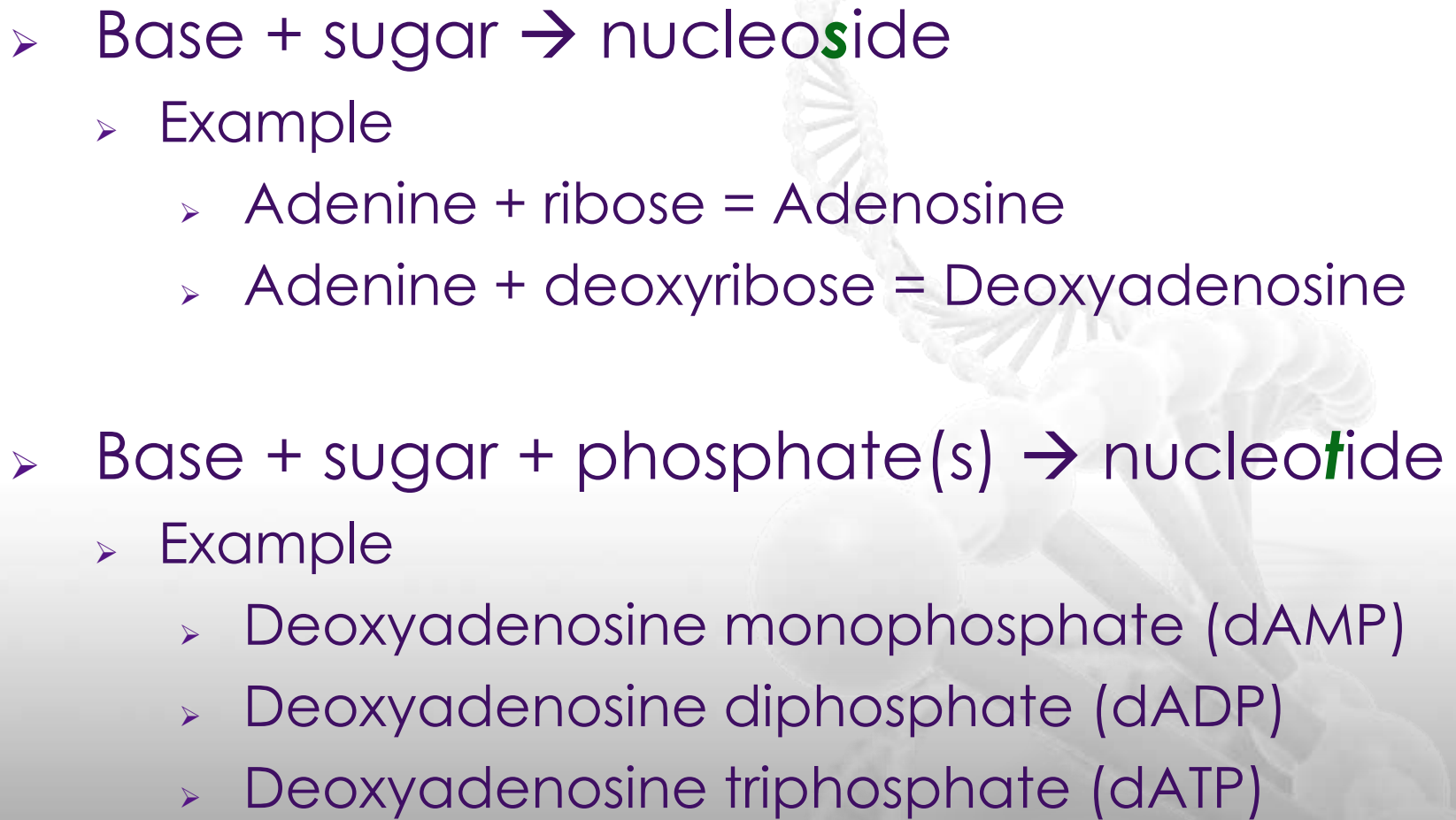
- 
- Base + sugar → nucleoside
 - Example
 - Adenine + ribose = Adenosine
 - Adenine + deoxyribose = Deoxyadenosine
 - Base + sugar + phosphate(s) → nucleotide
 - Example
 - Deoxyadenosine monophosphate (dAMP)
 - Deoxyadenosine diphosphate (dADP)
 - Deoxyadenosine triphosphate (dATP)

Deoxyadenosine triphosphate

Doxyadenosine diphosphate

Deoxyadenosine monophosphate

Deoxyadenosine

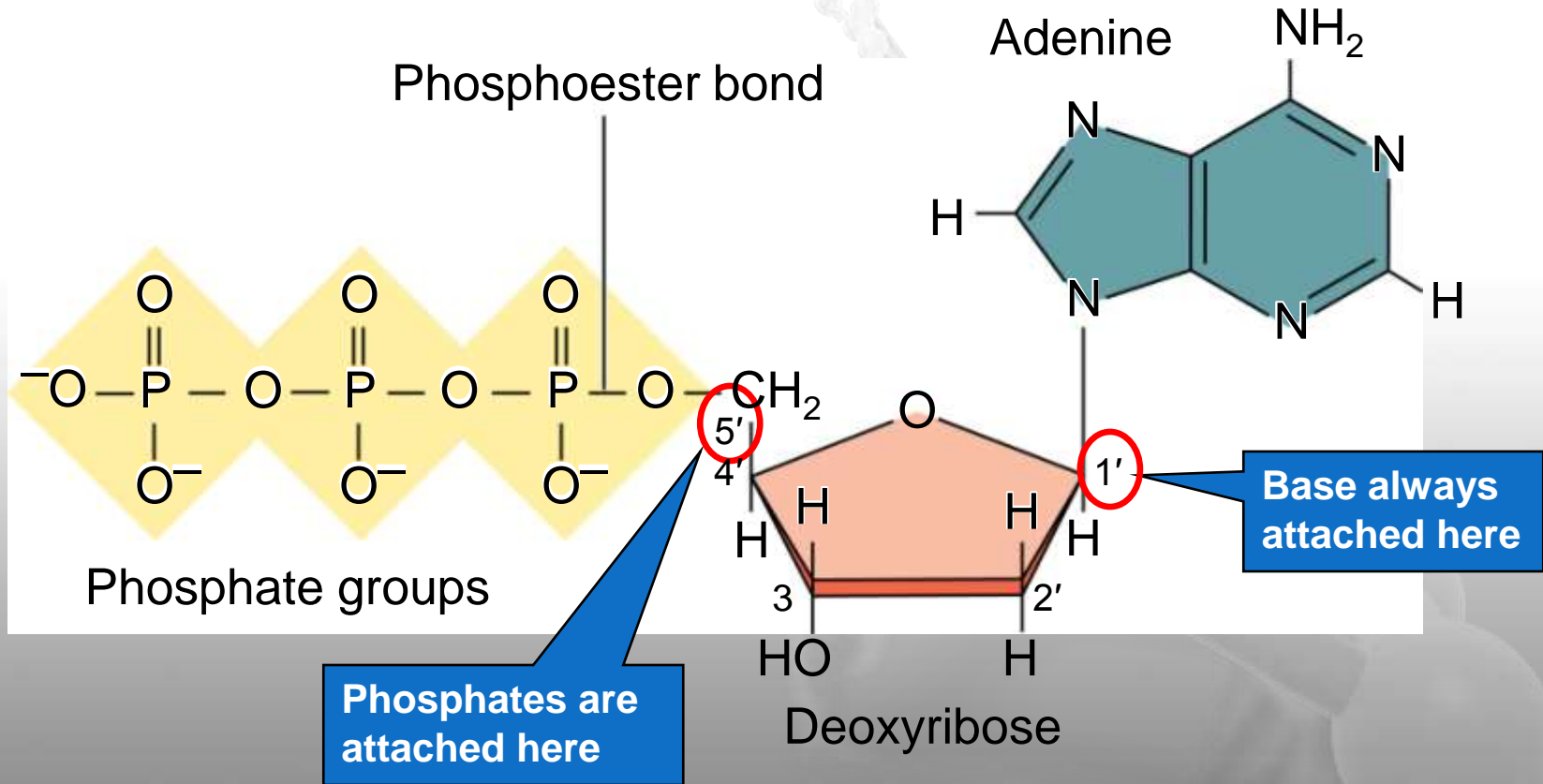

- Nucleotides are linked together by covalent bonds called phosphodiester linkage.

A chemical bond that involves sharing a pair of electrons between atoms in a molecule.

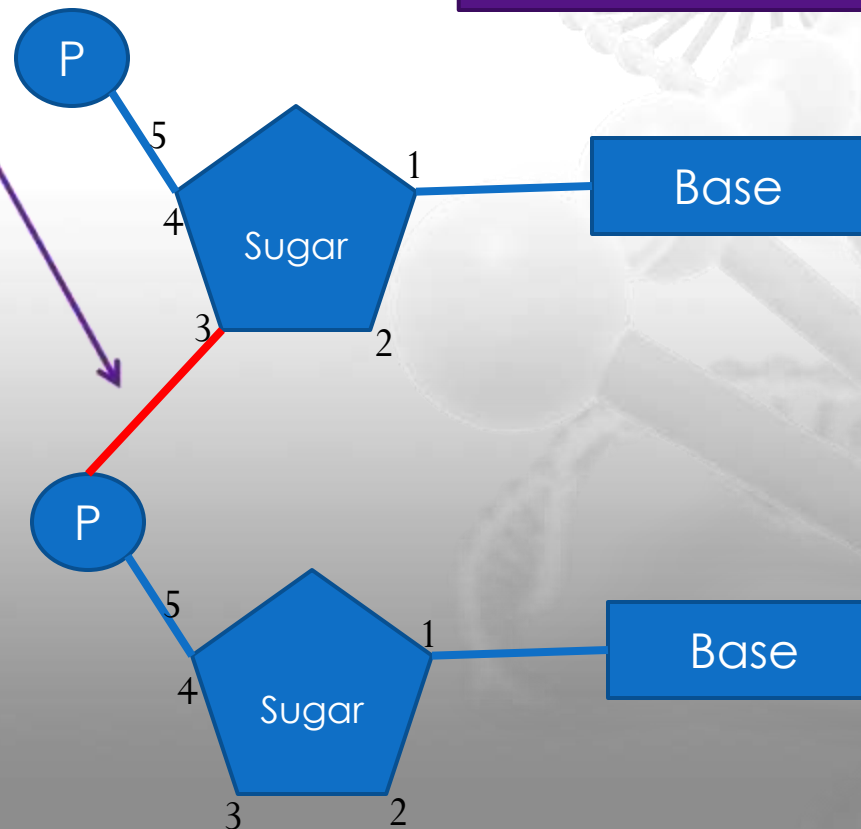

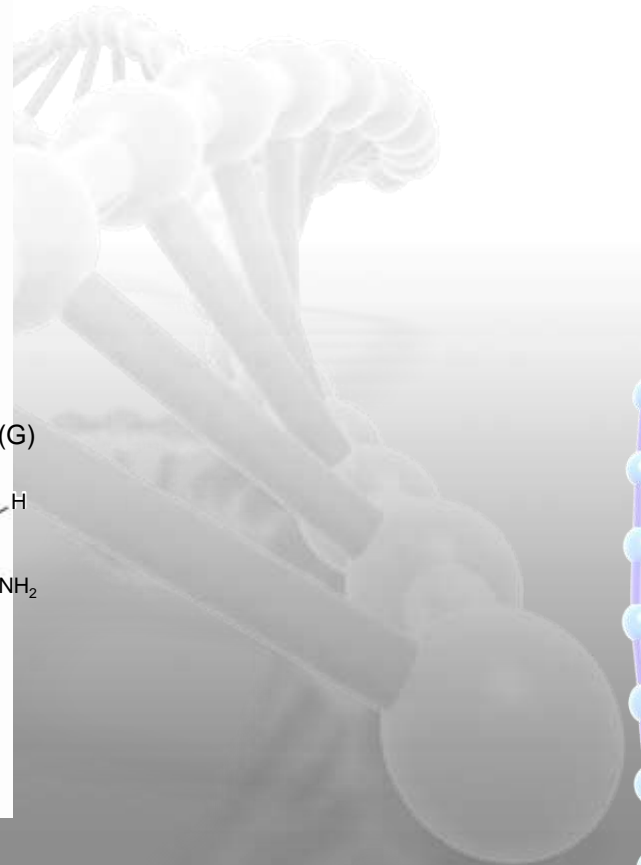
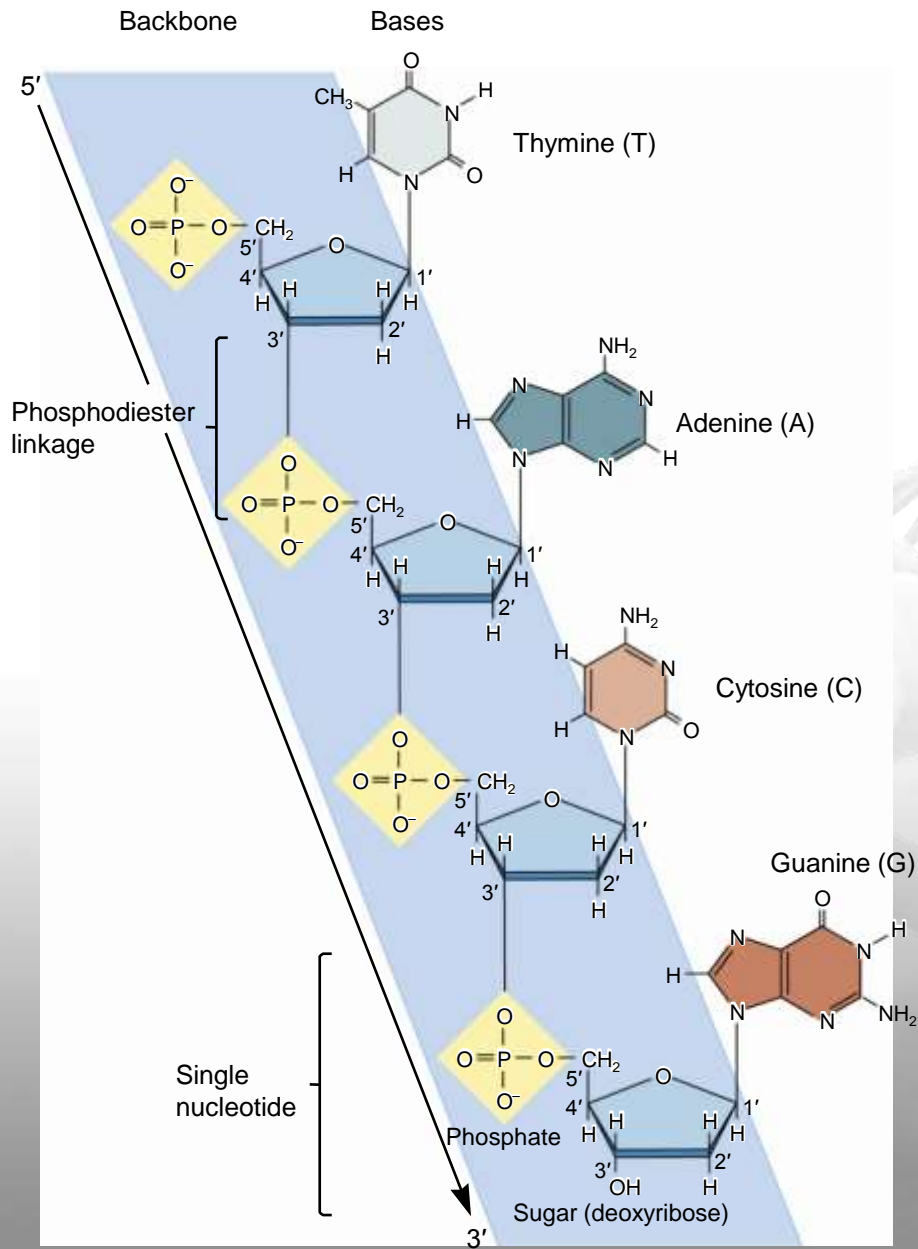

❖ DNA Double Helix & Hydrogen bonding

Salient features of the Double-helix structure of DNA:

- It is made of two polynucleotide chains, where the backbone is constituted by sugar-phosphate, and the bases project inside.
- The two chains have anti-parallel polarity. It means, if one chain has the polarity $5' \rightarrow 3'$, the other has $3' \rightarrow 5'$.

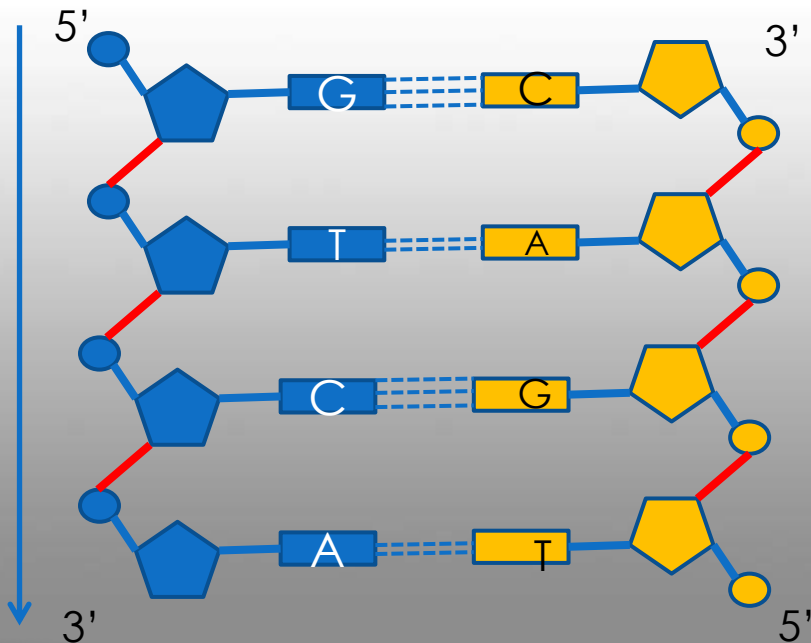

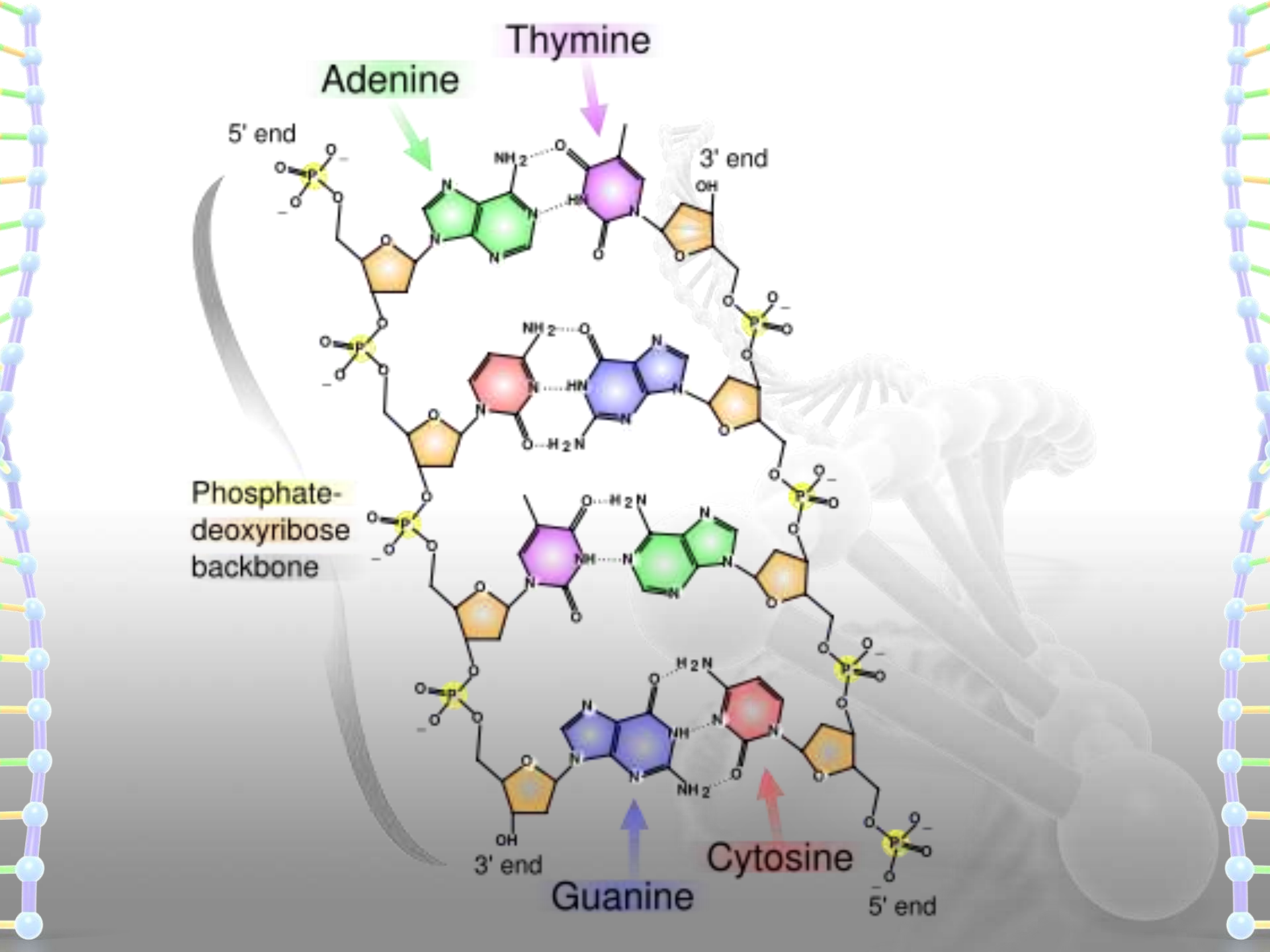

❖ DNA Double Helix & Hydrogen bonding

- The bases in two strands are paired through hydrogen bond (H-bonds) forming base pairs (bp). **Adenine** forms **two** hydrogen bonds with **Thymine** from opposite strand and vice-versa. Similarly, **Guanine** is bonded with **Cytosine** with **three** H-bonds.
- Based on the observation of **Erwin Chargaff** that for a double stranded DNA, the ratios between **Adenine** and **Thymine**; and **Guanine** and **Cytosine** are constant and equals one.
- **Hydrogen bond**: -A chemical bond consisting of a hydrogen atom between two electronegative atoms (e.g., oxygen or nitrogen) with one side be a covalent bond and the other being an ionic bond.

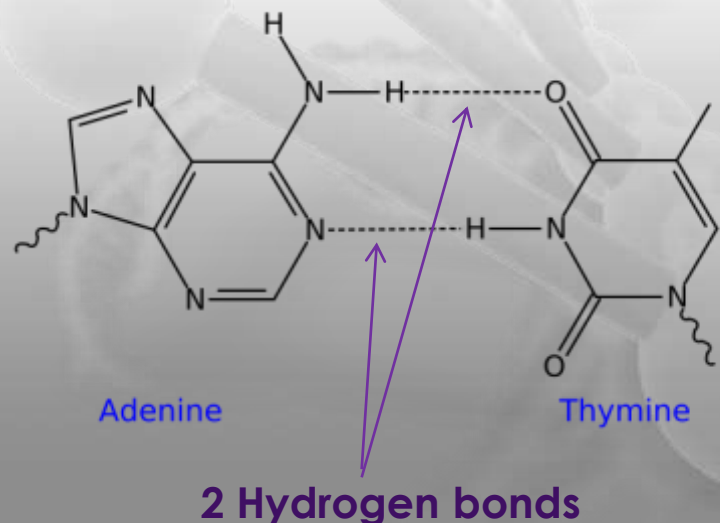
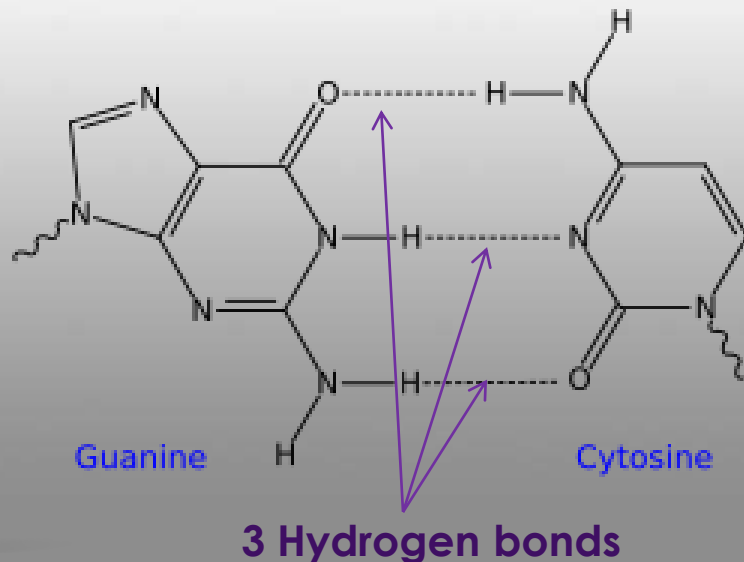

❖ Erwin Chargaff's Experiment



- Chargaff pioneered many of biochemical technique for the isolation, purification and measurement of nucleic acids from living cells.
- It was known that DNA contained the four bases: A, G, C & T.
- Chargaff analyzed the base composition DNA isolated from many different species.

❖ THE HYPOTHESIS

- An analysis of the base composition of DNA in different species may reveal important features about structure of DNA.

1. For each type of cell, extract the chromosomal material. This can be done in a variety of ways, including the use of high salt, detergent, or mild alkali treatment. Note: The chromosomes contain both DNA and protein.

2. Remove the protein. This can be done in several ways, including treatment with protease.

3. Hydrolyze the DNA to release the bases from the DNA strands. A common way to do this is by strong acid treatment.

4. Separate the bases by chromatography. Paper chromatography provides an easy way to separate the four types of bases. (The technique of chromatography is described in the Appendix.)

5. Extract bands from paper into solutions and determine the amounts of each base by spectroscopy. Each base will absorb light at a particular wavelength. By examining the absorption profile of a sample of base, it is then possible to calculate the amount of the base. (Spectroscopy is described in the Appendix.)

6. Compare the base content in the DNA from different organisms.

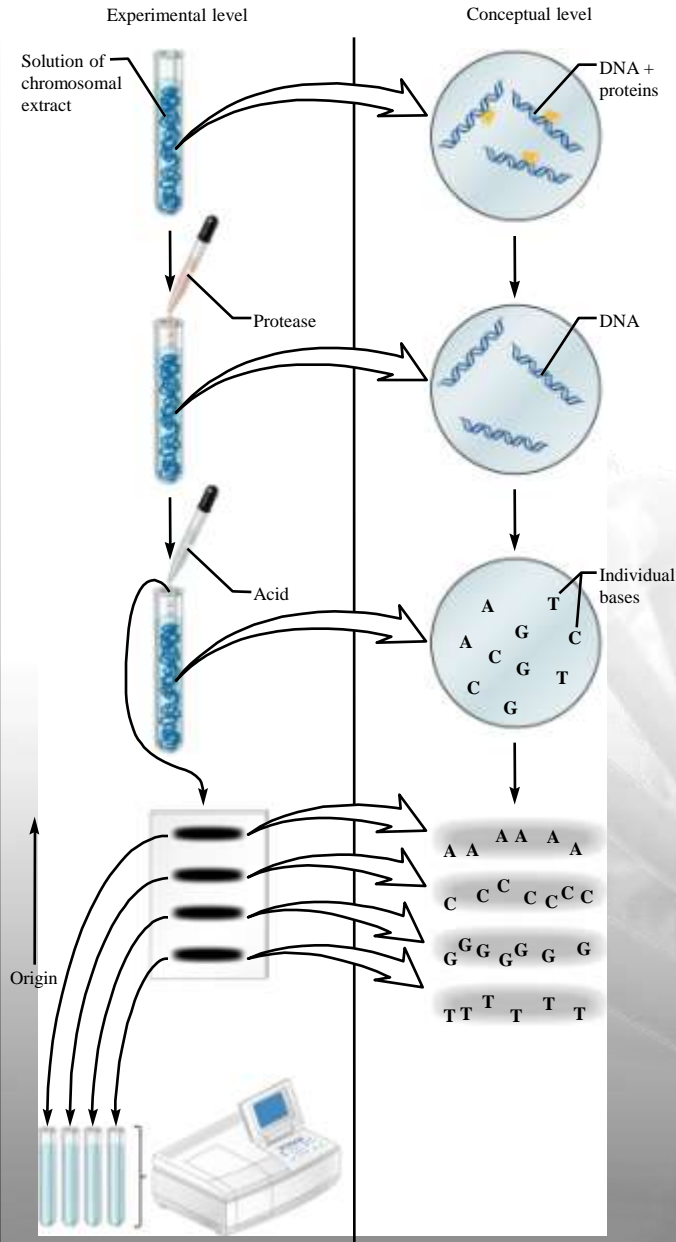

The Data



THE DATA

Base Content in the DNA from a Variety of Organisms*

Percentage of Bases (based on molarity)

| <i>Organism</i> | <i>Adenine</i> | <i>Thymine</i> | <i>Guanine</i> | <i>Cytosine</i> |
|---------------------------------|----------------|----------------|----------------|-----------------|
| <i>Escherichia coli</i> | 26.0 | 23.9 | 24.9 | 25.2 |
| <i>Streptococcus pneumoniae</i> | 29.8 | 31.6 | 20.5 | 18.0 |
| Yeast | 31.7 | 32.6 | 18.3 | 17.4 |
| Turtle red blood cells | 28.7 | 27.9 | 22.0 | 21.3 |
| Salmon sperm | 29.7 | 29.1 | 20.8 | 20.4 |
| Chicken red blood cells | 28.0 | 28.4 | 22.0 | 21.6 |
| Human liver cells | 30.3 | 30.3 | 19.5 | 19.9 |

*When the base compositions from different tissues within the same species were measured, similar results were obtained. These data were compiled from several sources. See E. Chargaff and J. Davidson, Eds. (1995) *The Nucleic Acids*. Academic Press, New York.

Interpretation of Data

- The compelling observation was that:
 - ✓ Percentage of adenine=percentage of thymine
 - ✓ Percentage of Cytosine=percentage of Guanine
- This observation became known as a **Chargaff's Rule.**

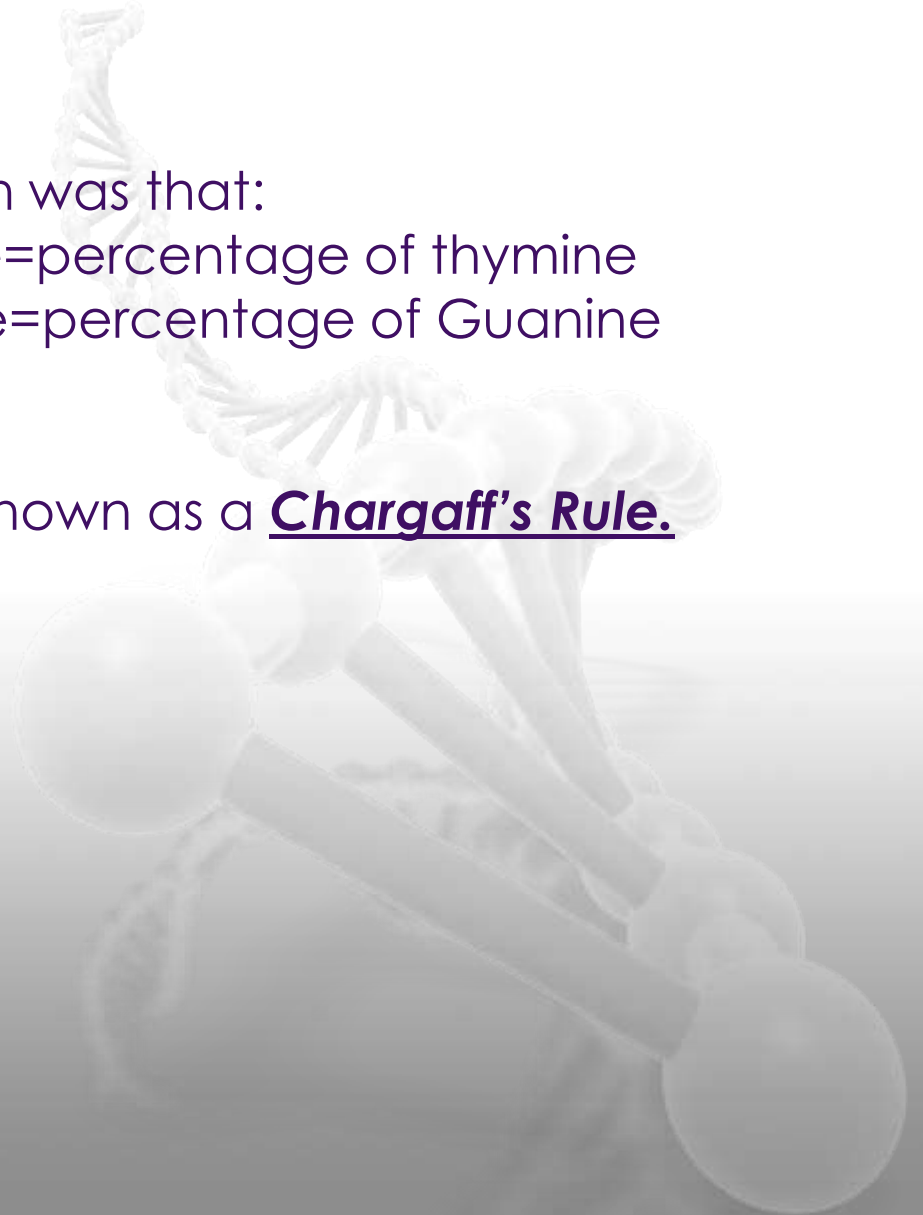

Erwin Chargaff

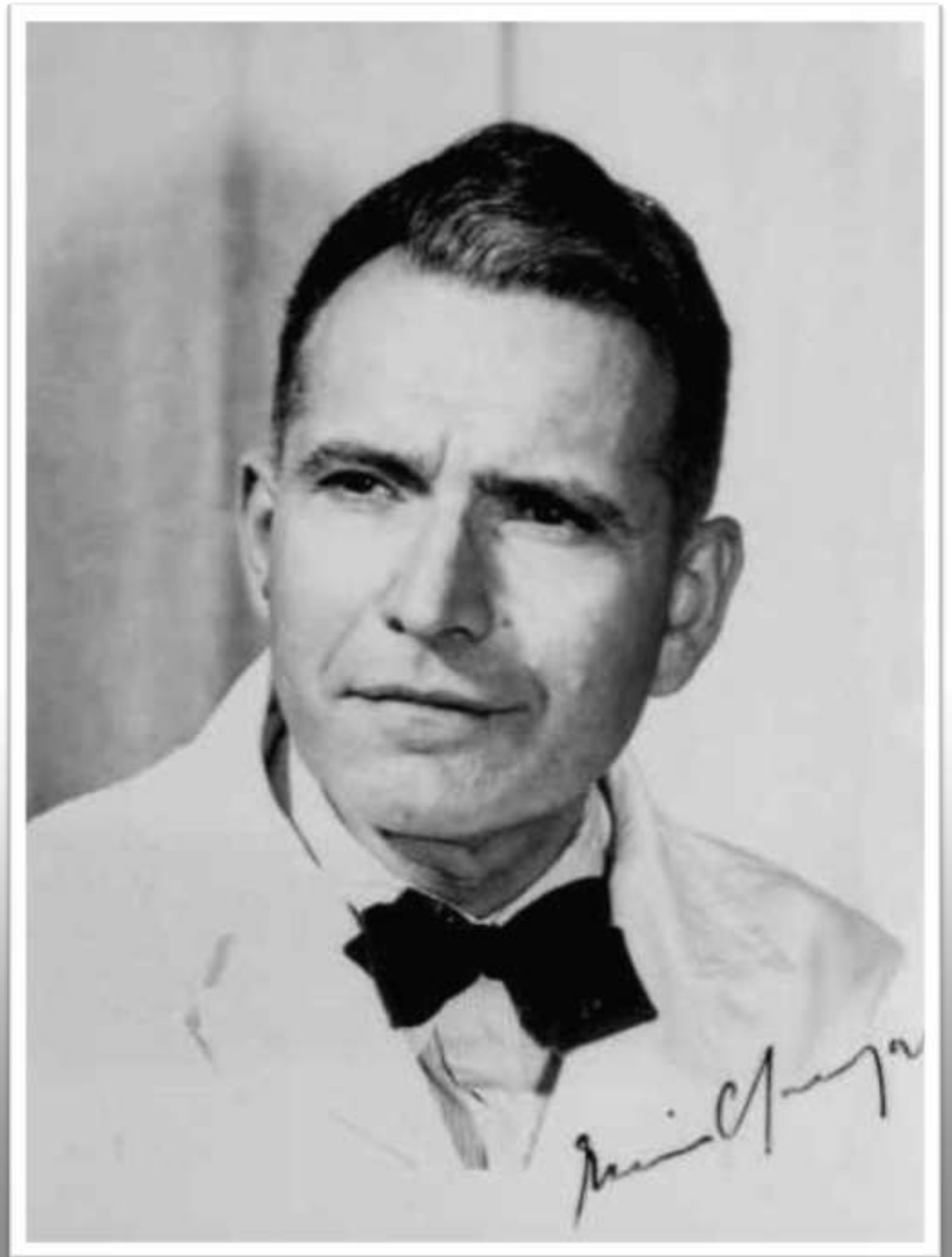

❖ DNA Double Helix & Hydrogen bonding

- The two strands are coiled in a ***right-handed fashion (Clockwise)***. The pitch of the helix is **3.4 nm** (a nanometer is one billionth of a meter, that is 10^{-9} m) and there are roughly **10 bp** in each turn. Consequently, the distance between a bp in a helix is approximately equal to **0.34 nm**.
- The plane of one base pair stacks over the other in double helix. This, in addition to H-bonds, confers stability of the helical structure.

(a) Complementary base pairing

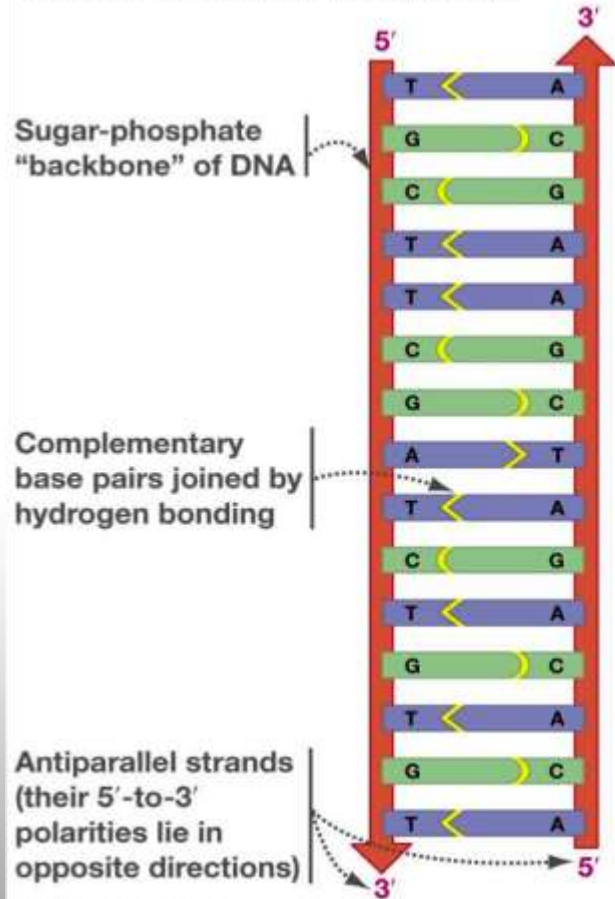

(b) The double helix

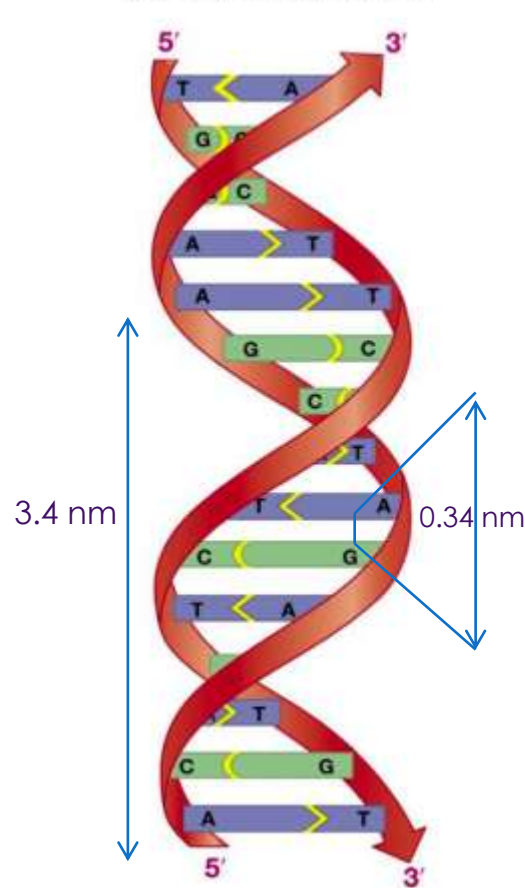

(c) A space-filling model

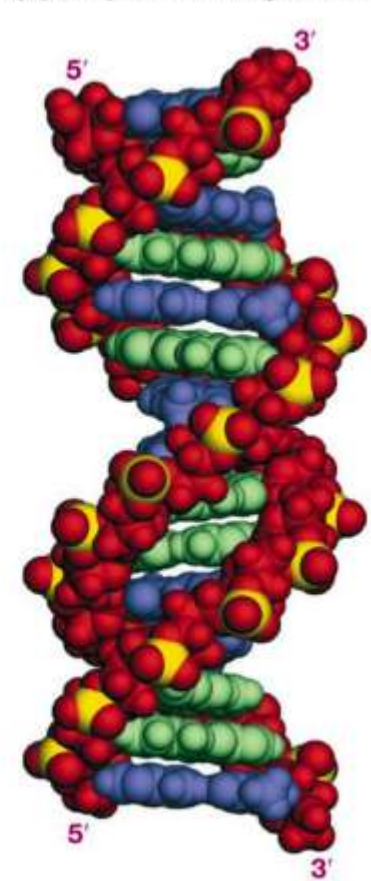

❖ DNA Double Helix & Hydrogen bonding

- There are two asymmetrical grooves on the outside of the helix:
 - a) Major groove
 - b) Minor groove

Groove:- any furrow (slight depression in the smoothness of a surface) or channel on a bodily structure or part.

- ✓ Certain proteins can bind within these groove
 - ✓ They can thus interact with a particular sequence of bases.

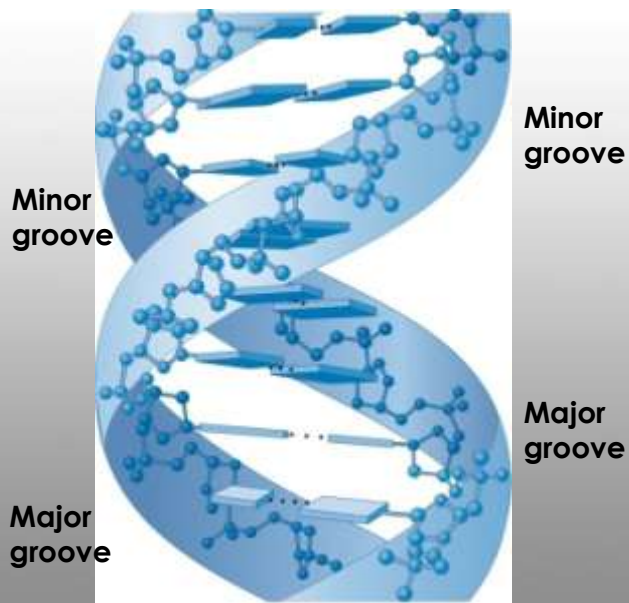

(a) Ball-and-stick model of DNA



(b) Space-filling model of DNA

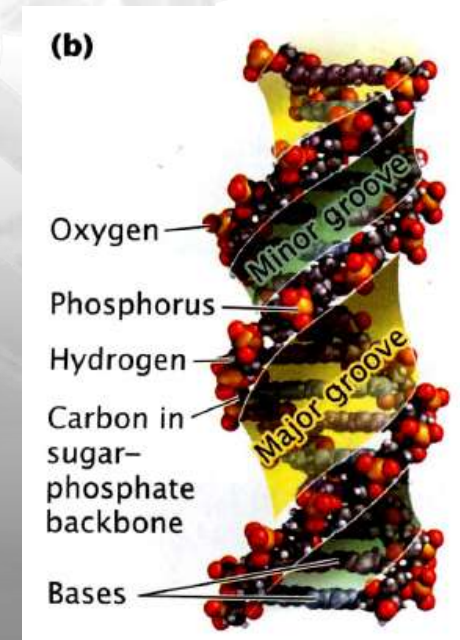

❖ Structure of Double-helix

➤ Three major forms:

- ✓ B-DNA
- ✓ A-DNA
- ✓ Z-DNA

❖ B-DNA

is biologically THE MOST COMMON

- ✓ It is a α -helix meaning that it has a Right handed, or clockwise, spiral.
- ✓ Complementary base pairing
 - A-T
 - G-C
- ✓ Ideal B-DNA has 10 base pair per turn (360° rotation of helix)
- ✓ So each base is twisted 36° relative to adjacent bases.
- ✓ Base pair are 0.34 nm apart.
- ✓ So complete rotation of molecule is 3.4 nm.
- ✓ Axis passes through middle of each basepairs.

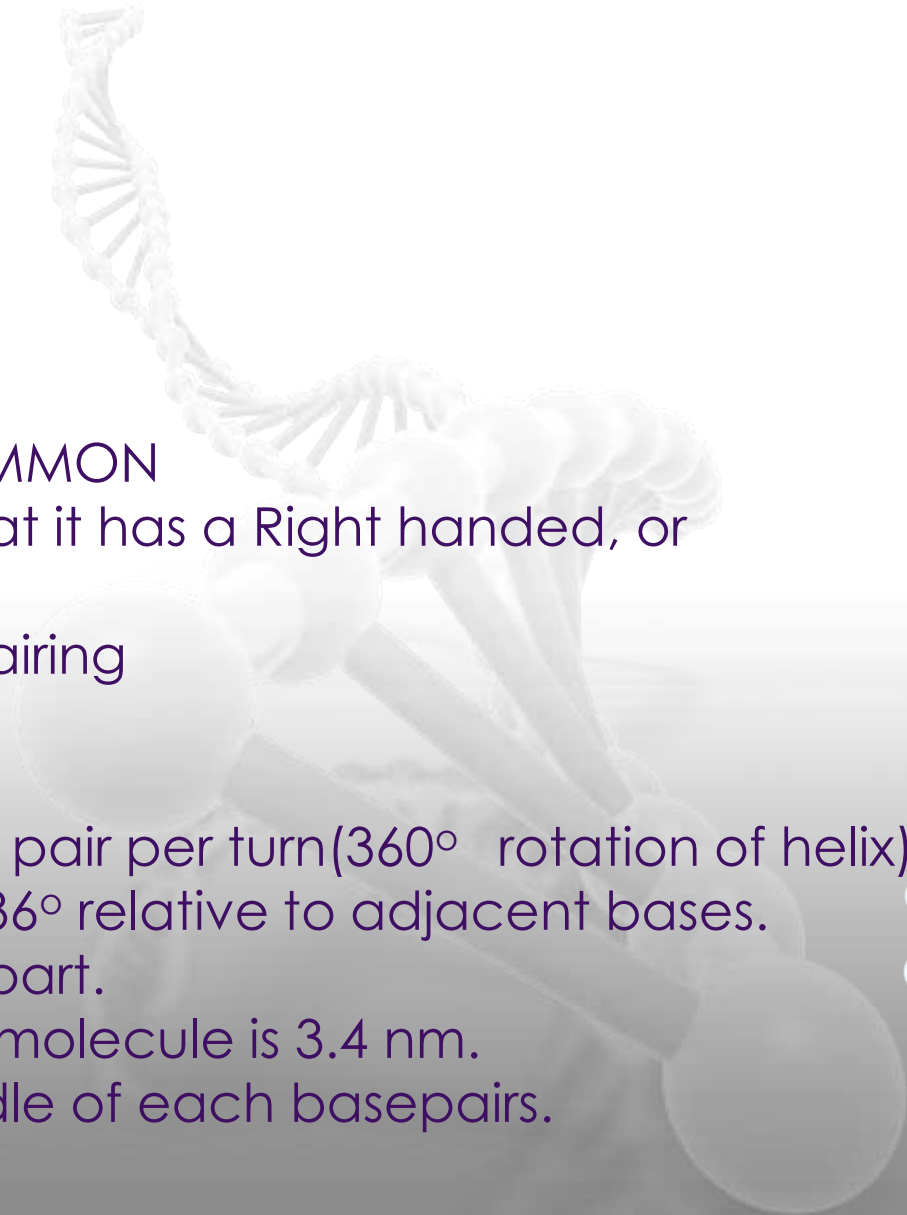

❖ B-DNA

- ✓ Minor Groove is Narrow, Shallow.
- ✓ Major Groove is Wide, Deep.
- ✓ This structure **exists** when **plenty of water** surrounds molecule and there is no unusual base sequence in DNA-Condition that are likely to be present in the cells.
- ✓ B-DNA structure is most stable configuration for a random sequence of nucleotides under physiological condition.

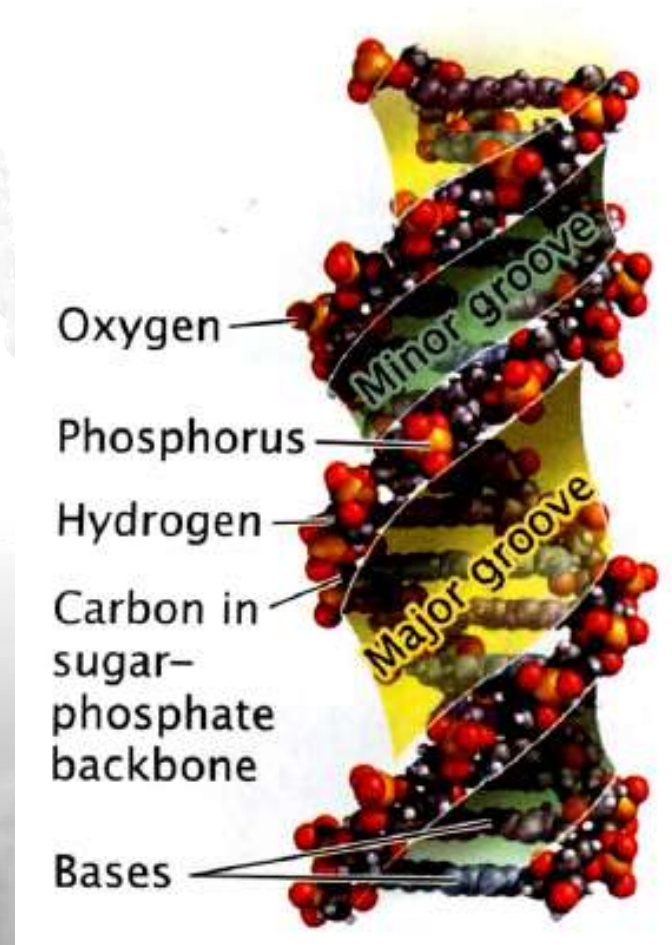

❖ A-DNA

- ✓ Right-handed helix
- ✓ Wider and flatter than B-DNA
- ✓ 11 bp per turn
- ✓ Its bases are tilted away from main axis of molecule
- ✓ Narrow Deep major Groove and Broad, Shallow minor Groove.
- ✓ Observed when less water is present. i.e. **Dehydrating condition.**
- ✓ A-DNA has been observed in two context:
 - Active site of DNA polymerase (~3bp)
 - Gram (+) bacteria undergoing sporulation

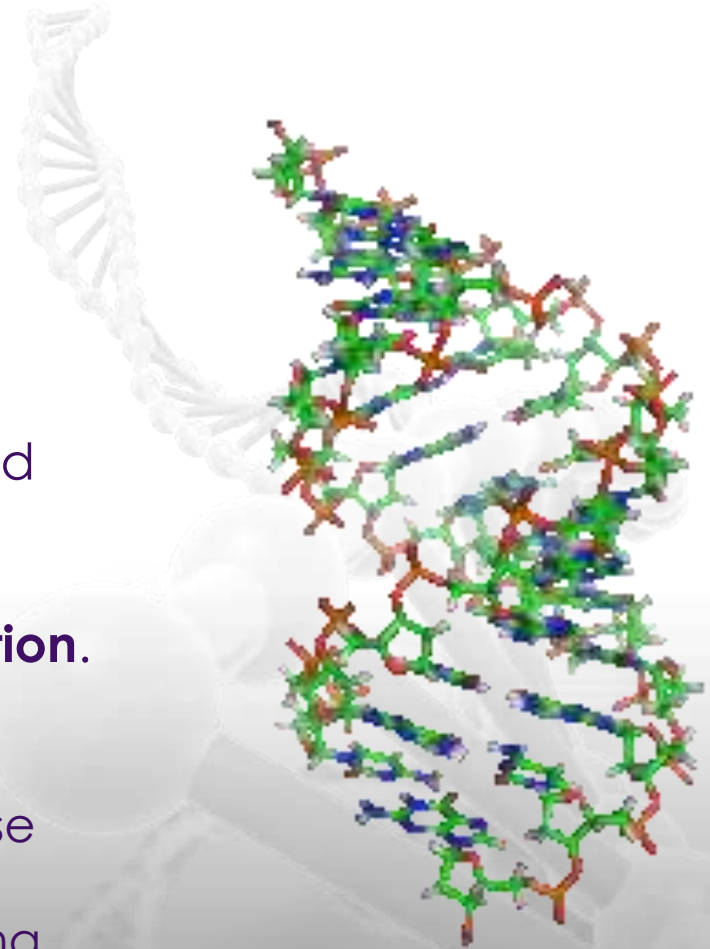

❖ Z-DNA

- ✓ A left-handed helix
- ✓ Seen in Condition of **High salt concentration**.
- ✓ In this form sugar-phosphate backbones zigzag back and forth, giving rise to the name Z-DNA (for zigzag).
- ✓ 12 base pairs per turn.
- ✓ A deep Minor Groove.
- ✓ No Discernible Major Groove.
- ✓ Part of some active genes form Z-DNA, suggesting that Z-DNA may play a role in regulating gene transcription.

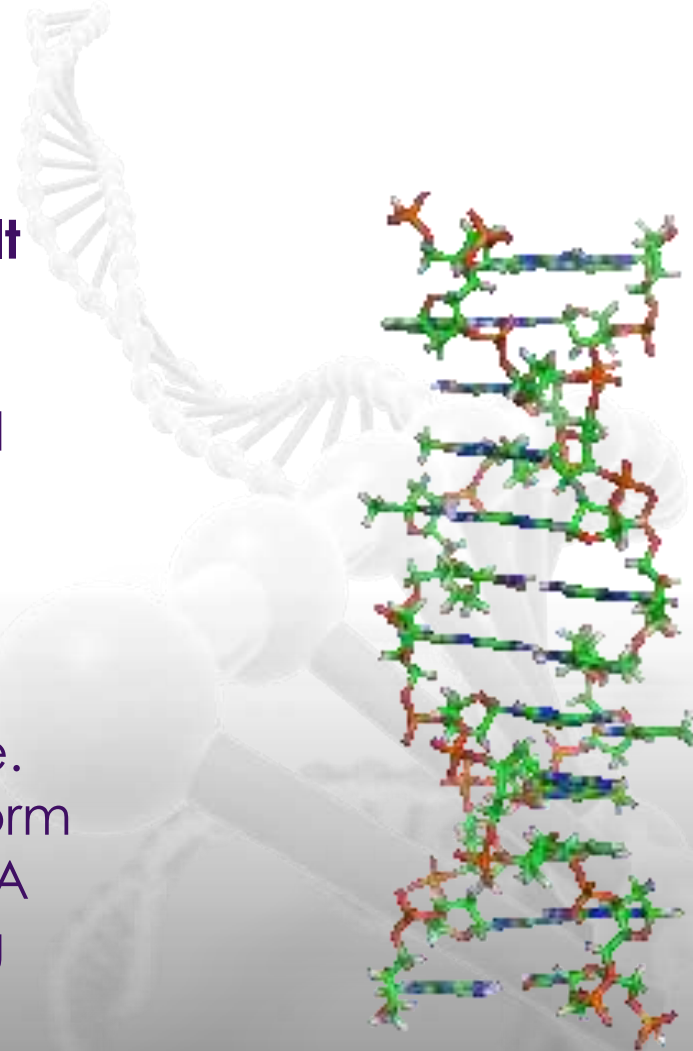

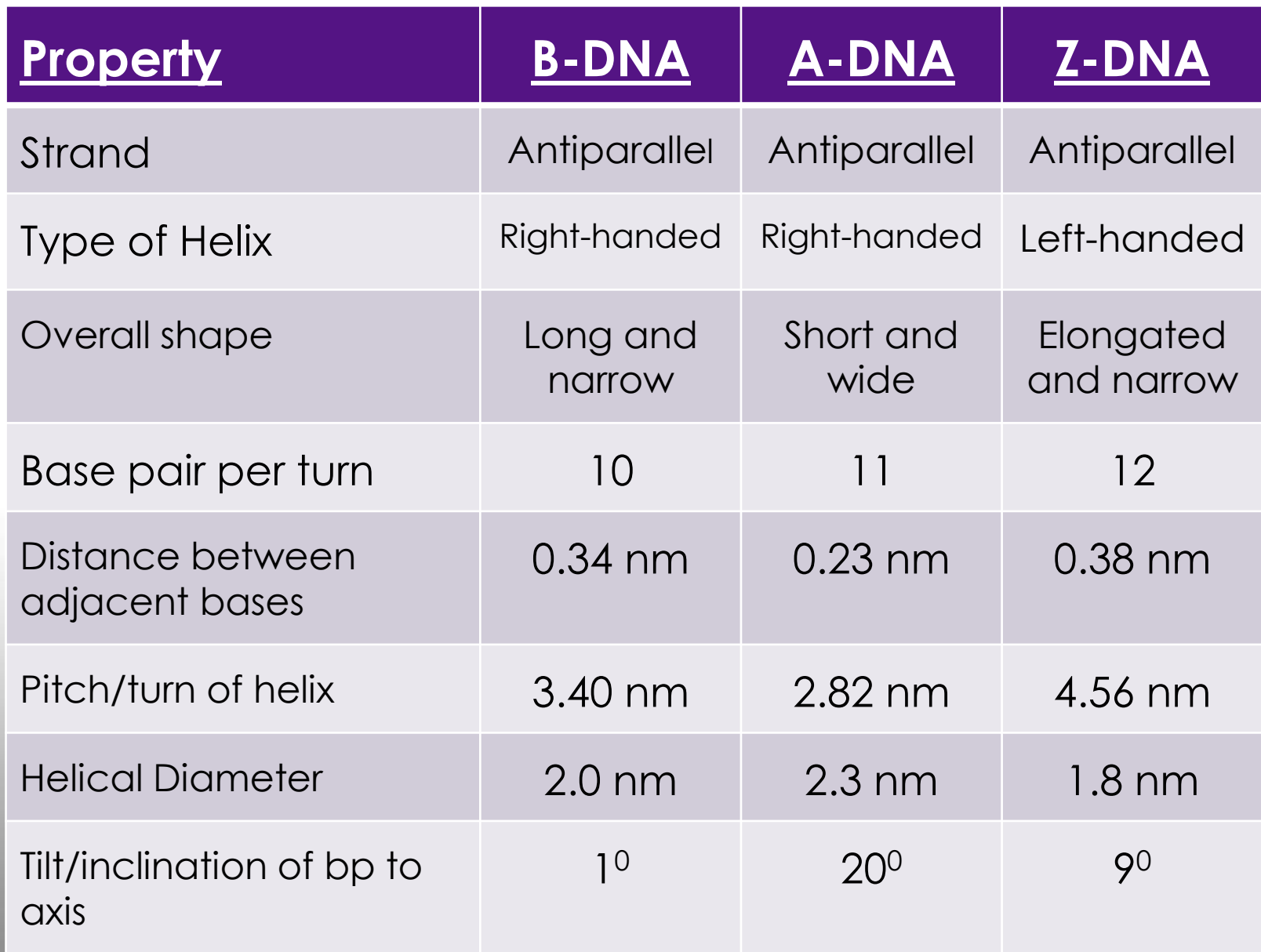

| <u>Property</u> | <u>B-DNA</u> | <u>A-DNA</u> | <u>Z-DNA</u> |
|---------------------------------|-----------------|-----------------|----------------------|
| Strand | Antiparallel | Antiparallel | Antiparallel |
| Type of Helix | Right-handed | Right-handed | Left-handed |
| Overall shape | Long and narrow | Short and wide | Elongated and narrow |
| Base pair per turn | 10 | 11 | 12 |
| Distance between adjacent bases | 0.34 nm | 0.23 nm | 0.38 nm |
| Pitch/turn of helix | 3.40 nm | 2.82 nm | 4.56 nm |
| Helical Diameter | 2.0 nm | 2.3 nm | 1.8 nm |
| Tilt/inclination of bp to axis | 1 ⁰ | 20 ⁰ | 9 ⁰ |

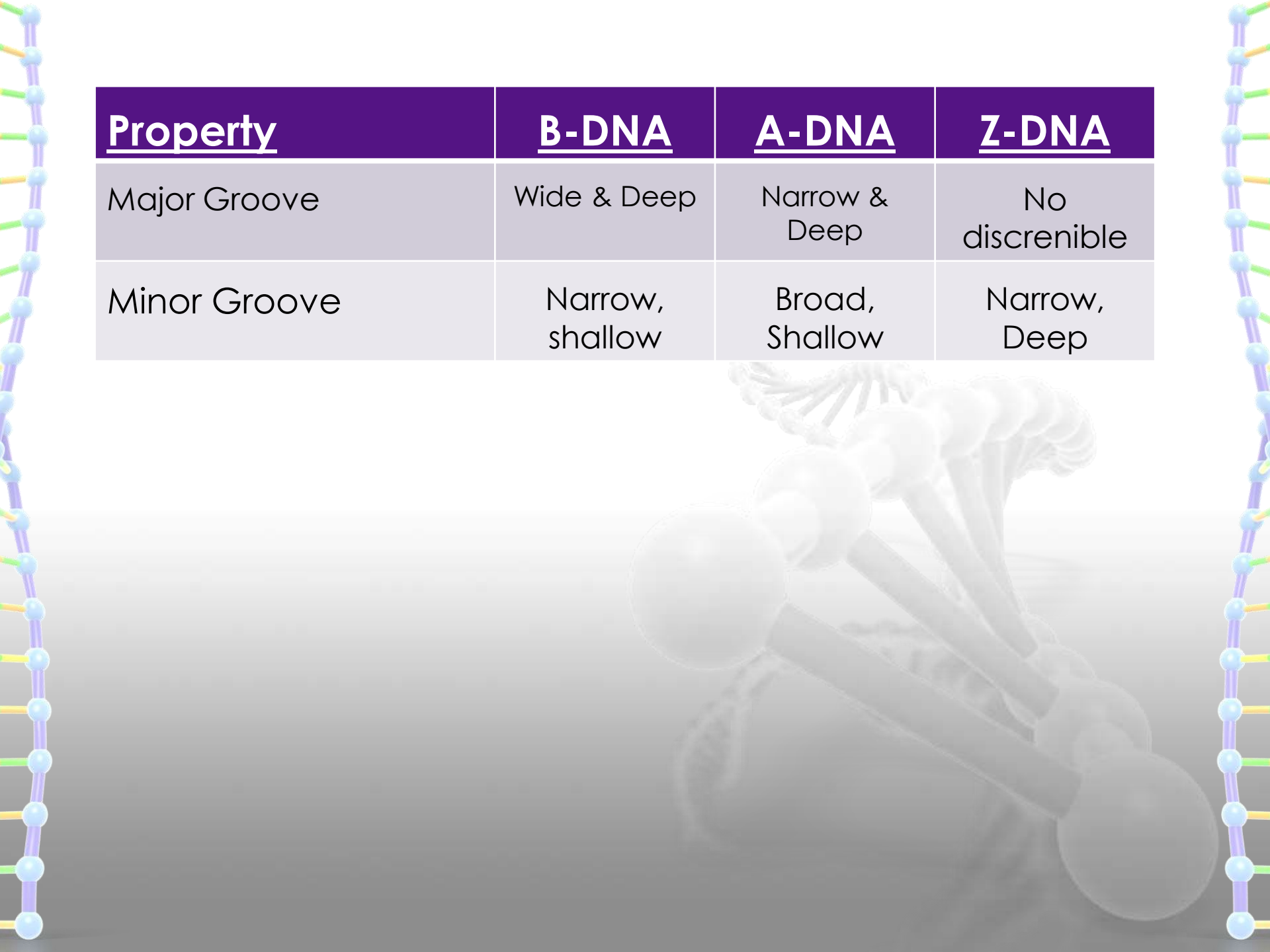

| <u>Property</u> | <u>B-DNA</u> | <u>A-DNA</u> | <u>Z-DNA</u> |
|-----------------|-----------------|----------------|----------------|
| Major Groove | Wide & Deep | Narrow & Deep | No discredible |
| Minor Groove | Narrow, shallow | Broad, Shallow | Narrow, Deep |



❖ DNA Supercoiling

- **DNA supercoiling** refers to the over or under-winding of strands.
- DNA supercoiling is important for DNA packaging within all cells. Because the length of DNA can be of thousands of times that of a cell, packaging this material into the cell or nucleus (in Eukaryotes) is a difficult feat.
- Supercoiling of DNA reduces the space and allows for much more DNA to be packaged.

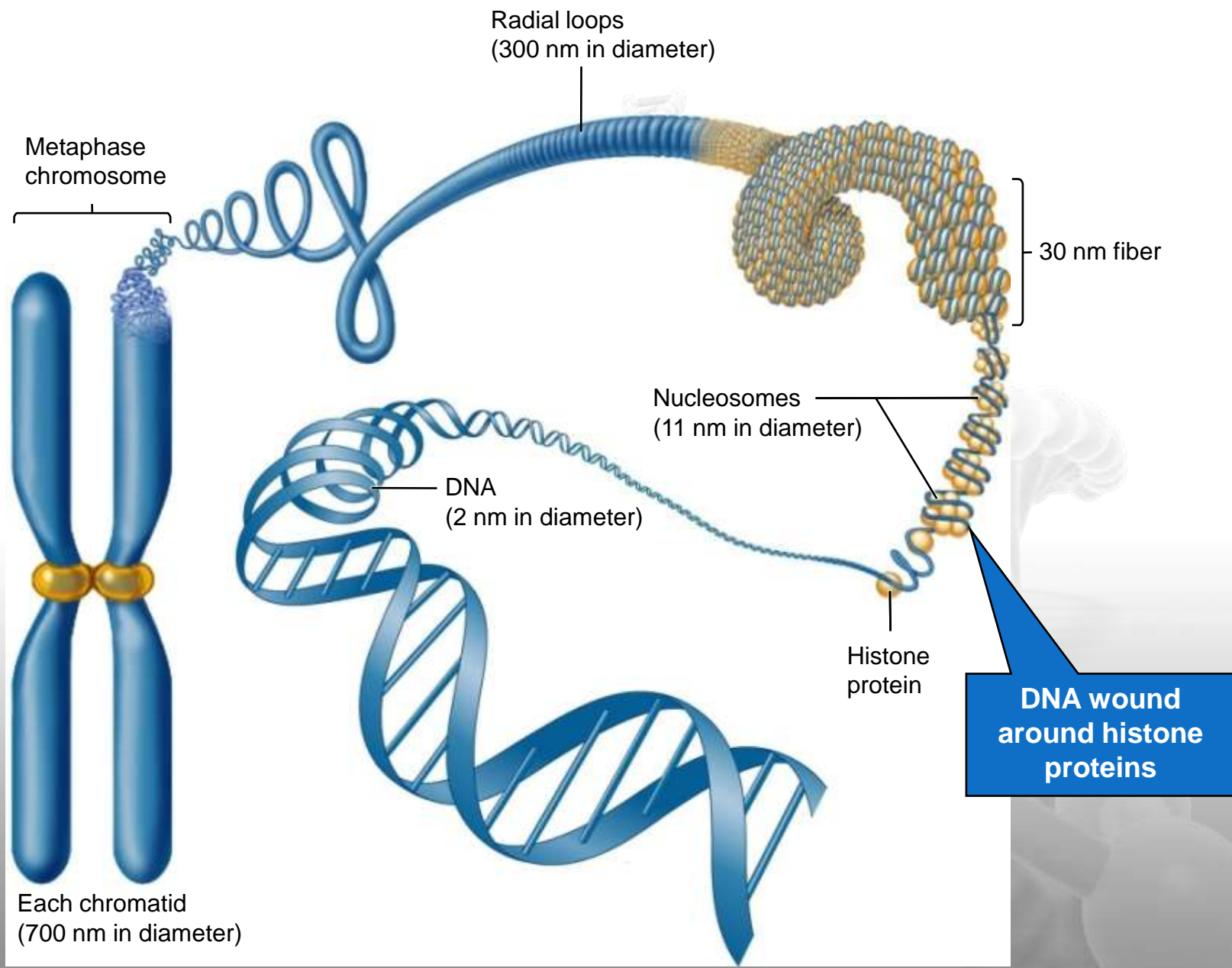

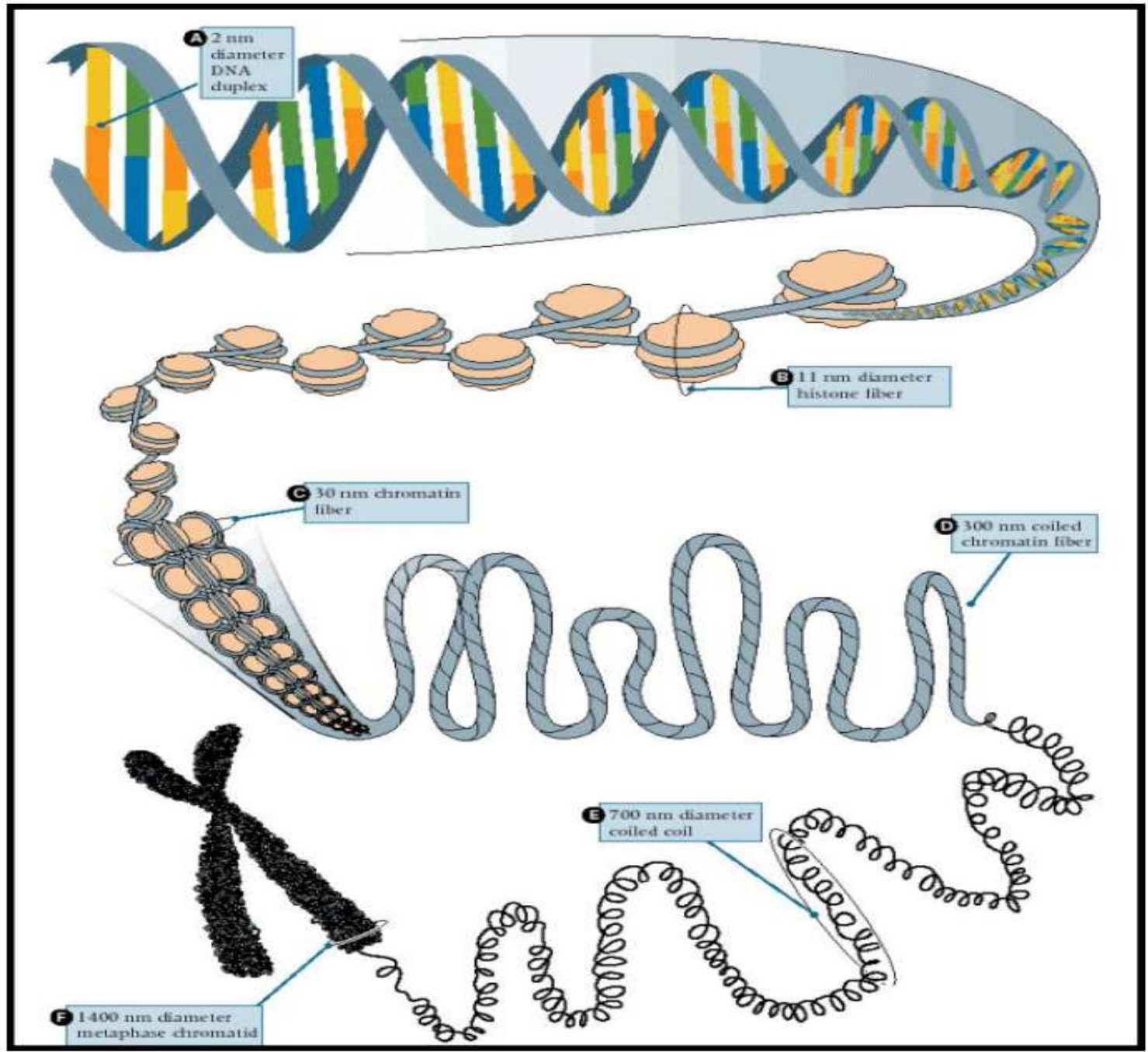

❖ Nucleosome Structure

- Nucleosome are the basic unit of the chromatin organization.
- In Eukaryotes DNA associated with Proteins.
(In prokaryotes DNA is naked)
- Nucleosomes= basic bead like unit of DNA packing
 - ✓ Made of segment of DNA wound around a protein core that is composed of 2 copies of each 4 types of Histones.
- Nucleosomes have:
 - ✓ 8 Histones in the core
 - ✓ DNA wrapped twice around the core
 - ✓ One Histone holding the Nucleosome together
 - ✓ A DNA 'linker' continues towards the next nucleosome.
- The DNA has a negatively charged backbone (because of PO_4^{3-} group)
- The Protein (Histones) are positively charged.
- The DNA and Protein are Electromagnetically attracted to each other to form chromatin.

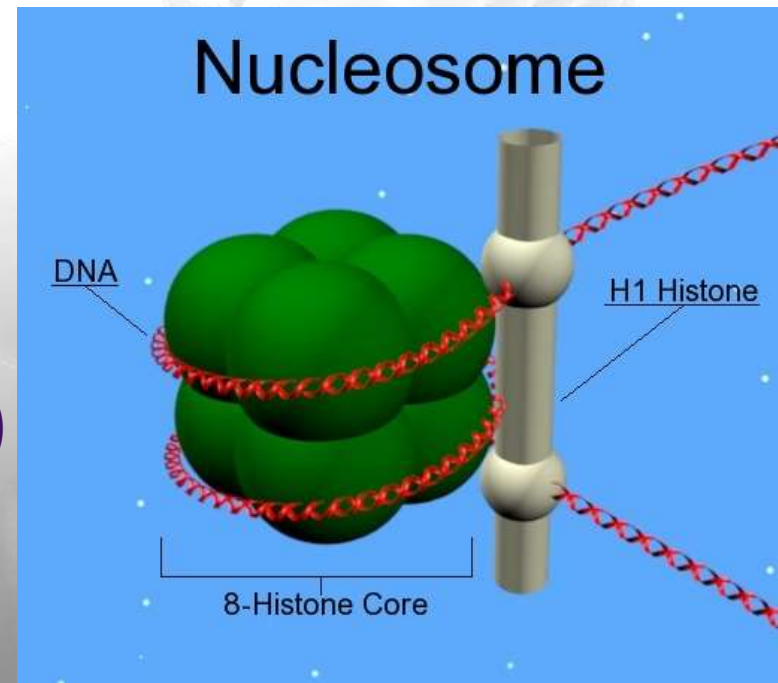

RNA

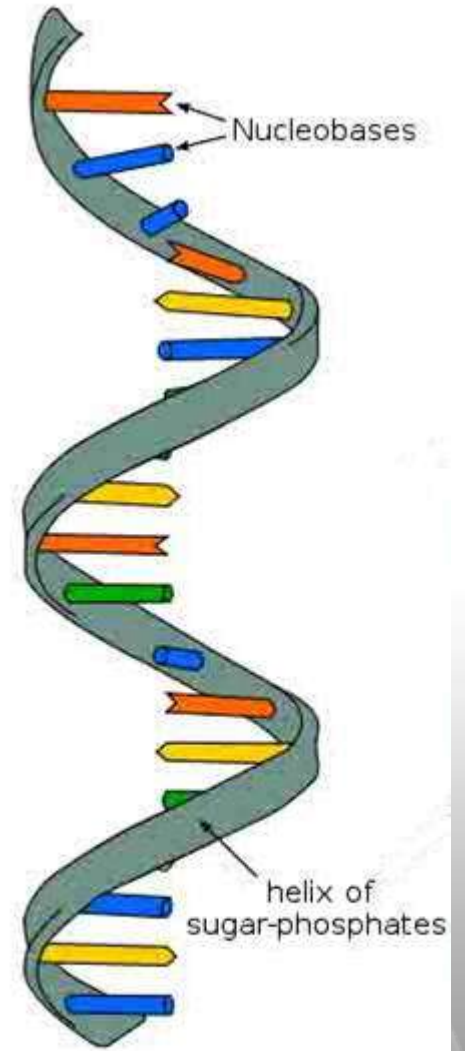

RNA
Ribonucleic acid



RNA

- Ribonucleic Acid
- RNA is a polymer of ribonucleotides linked together by **phosphodiester linkage**.
- RNA was first genetic material.
- **In 1967 Carl Woese** found the **catalytic** properties of RNA and speculated that the **earliest forms of life** relied on RNA both to carry genetic information and to catalyse biochemical reactions.
- Their theories were not validated until the work of Nobel Prize laureate **Thomas R. Cech**. In the **1970s, Cech** was studying the splicing of RNA in a single-celled organism, *Tetrahymena thermophila*, when he **discovered** that an **unprocessed RNA molecule could splice itself**. He announced his discovery in **1982** and became the first to show that RNA has **catalytic functions**.
- Usually single stranded and helical in structure.
- But double stranded also present in some viruses.

- RNA exists in several different single-stranded structures, most of which are directly or indirectly involved in protein synthesis or its regulation.
- It also acts as the genetic material in some viruses.
- It function as messenger(mRNA), adapter(tRNA), structural(rRNA) and in some cases as a catalytic molecule(Ribozyme).
- RNA strands are typically several hundred to several thousand nucleotides in length.

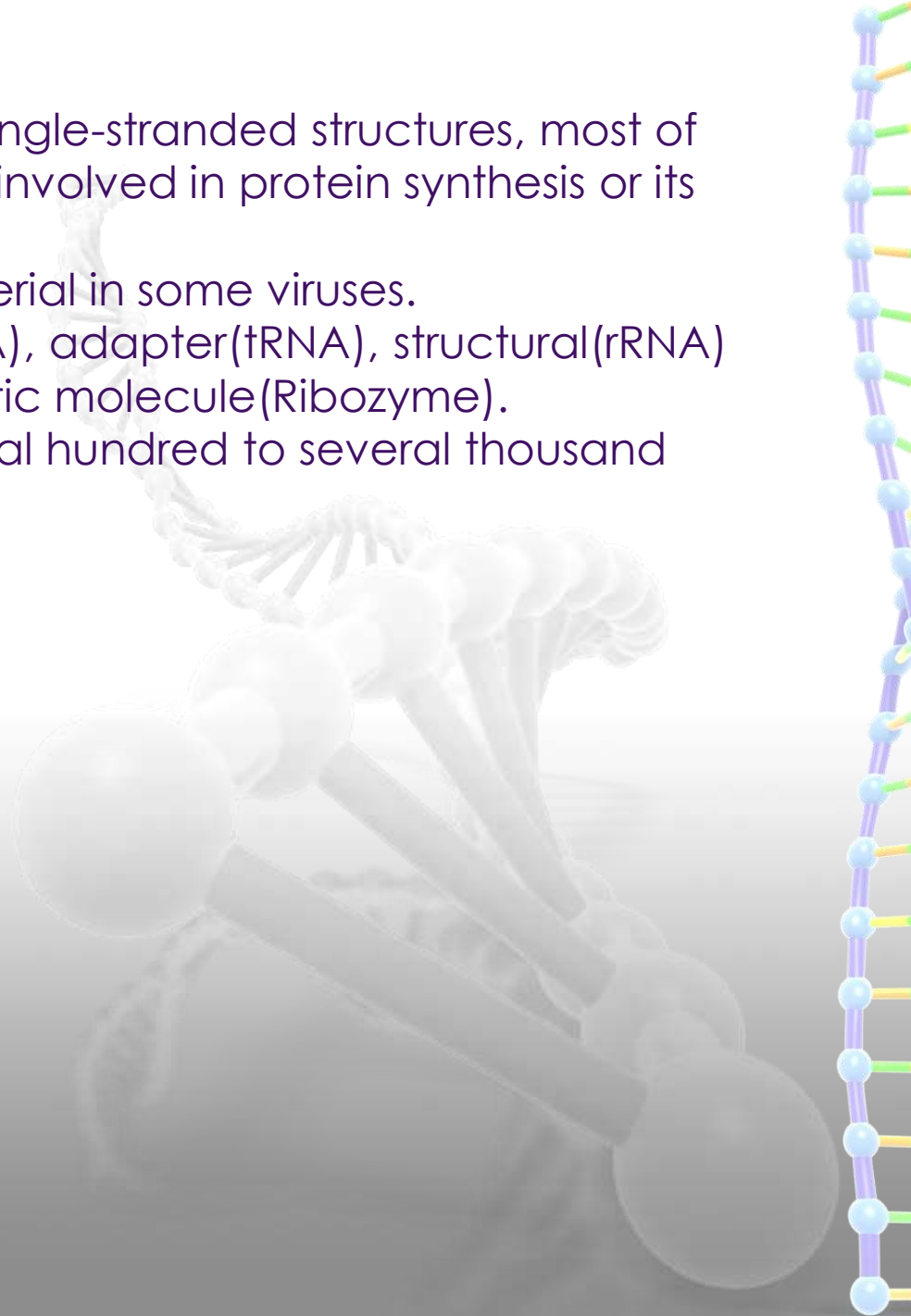

❖ RNA V/S DNA

Cytosine **C**

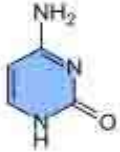

Guanine **G**

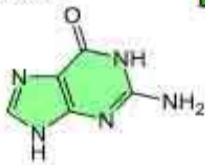

Adenine **A**



Uracil **U**



Nucleobases
of RNA

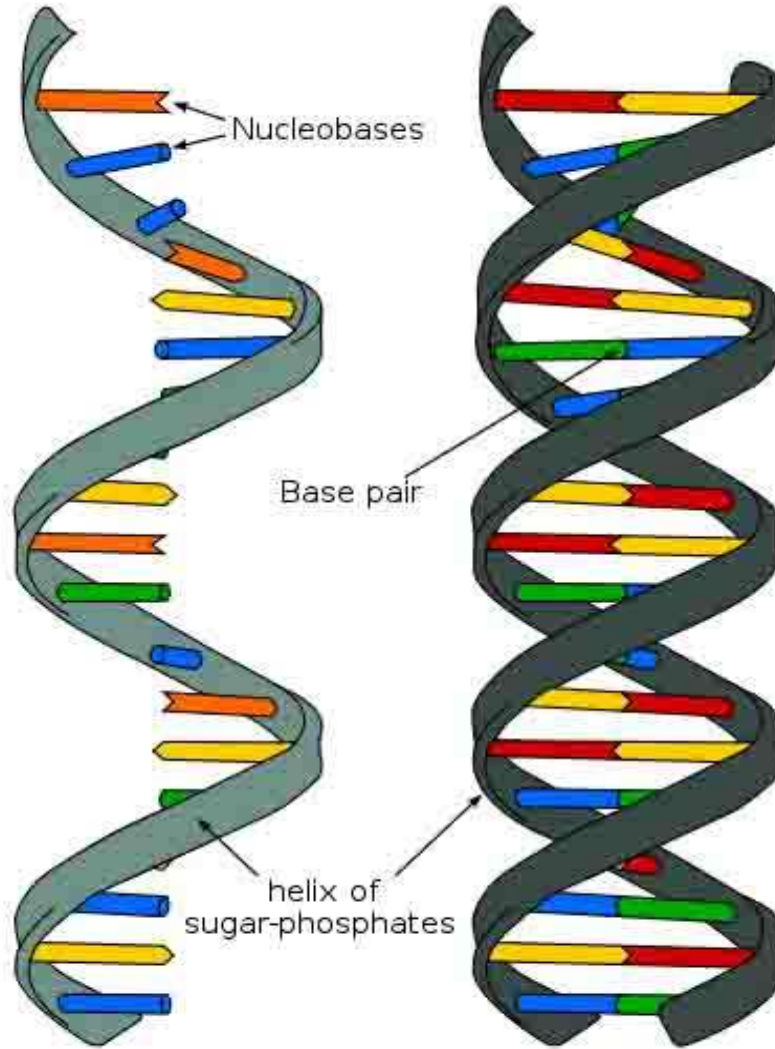

RNA

Ribonucleic acid

DNA

Deoxyribonucleic acid

Cytosine **C**

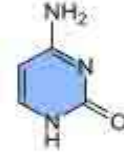

Guanine **G**

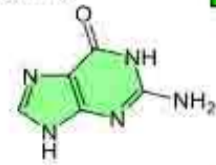

Adenine **A**



Thymine **T**



Nucleobases
of DNA

❖ RNA structure

- There are also three main component
 - a) Phosphate Group
 - b) Sugar(Ribose)
 - c) And Nitrogenous base

❖ The Nitrogenous Bases

- They are divided into two groups:
 - i. Purine
 - ii. Pyrimidine
- Purines (made of a 6 member ring, fused to a 5 member ring)
 - ✓ Adenine
 - ✓ Guanine
- Pyrimidine (made of a 6 member ring)
 - ✓ Cytosine
 - ✓ Uracil

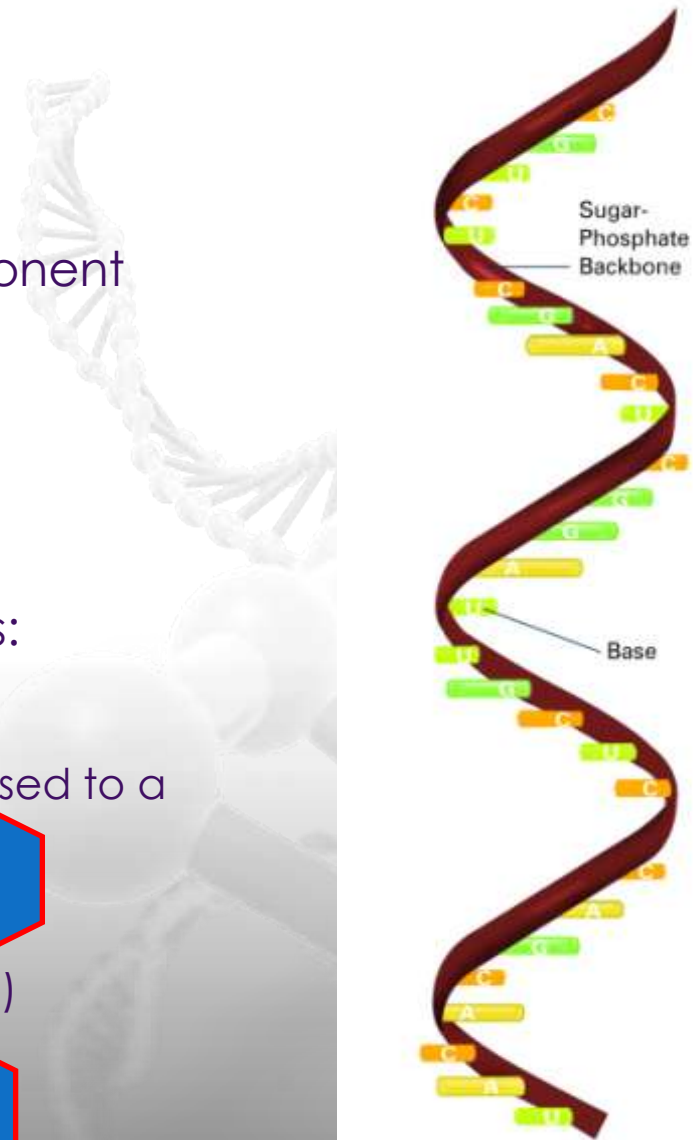
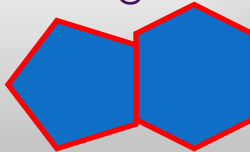

❖ RNA Structure

❖ Nucleotide

- Nucleotides are formed by the condensation of a sugar, phosphate and one of the 4 bases
- The following illustration represents one nucleotide

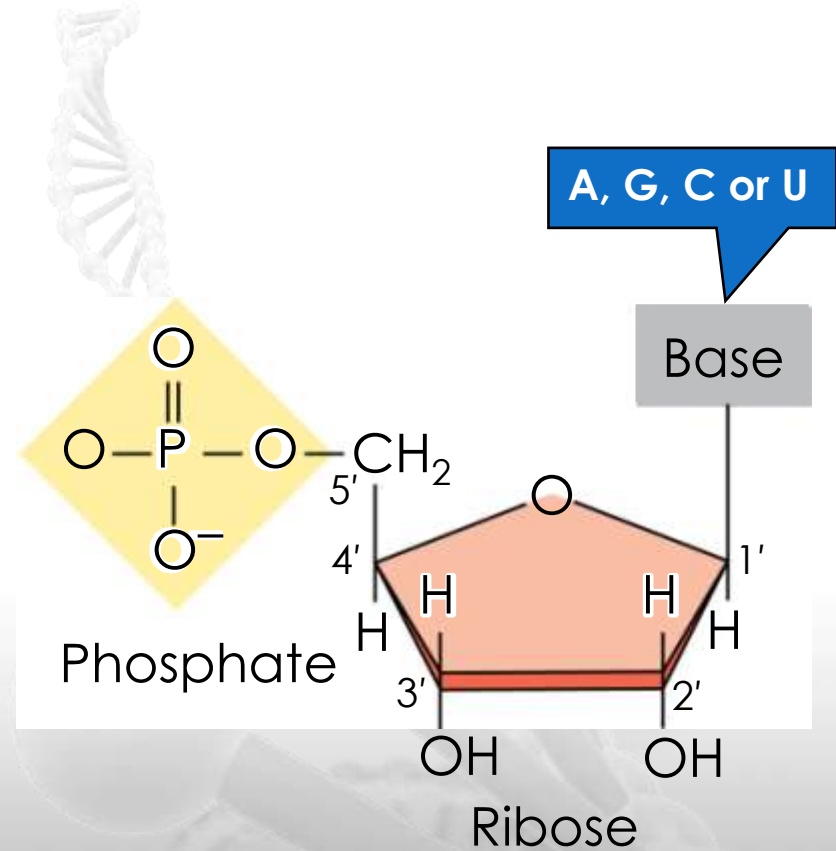

RNA Nucleotide



➤ Base + sugar → nucleoside

➤ Example

➤ Adenine + ribose = Adenosine

➤ Base + sugar + phosphate(s) → nucleotide

➤ Example

➤ Adenosine monophosphate (AMP)

➤ Adenosine diphosphate (ADP)

➤ Adenosine triphosphate (ATP)

Adenosine triphosphate

Adenosine diphosphate

Adenosine monophosphate

Adenosine

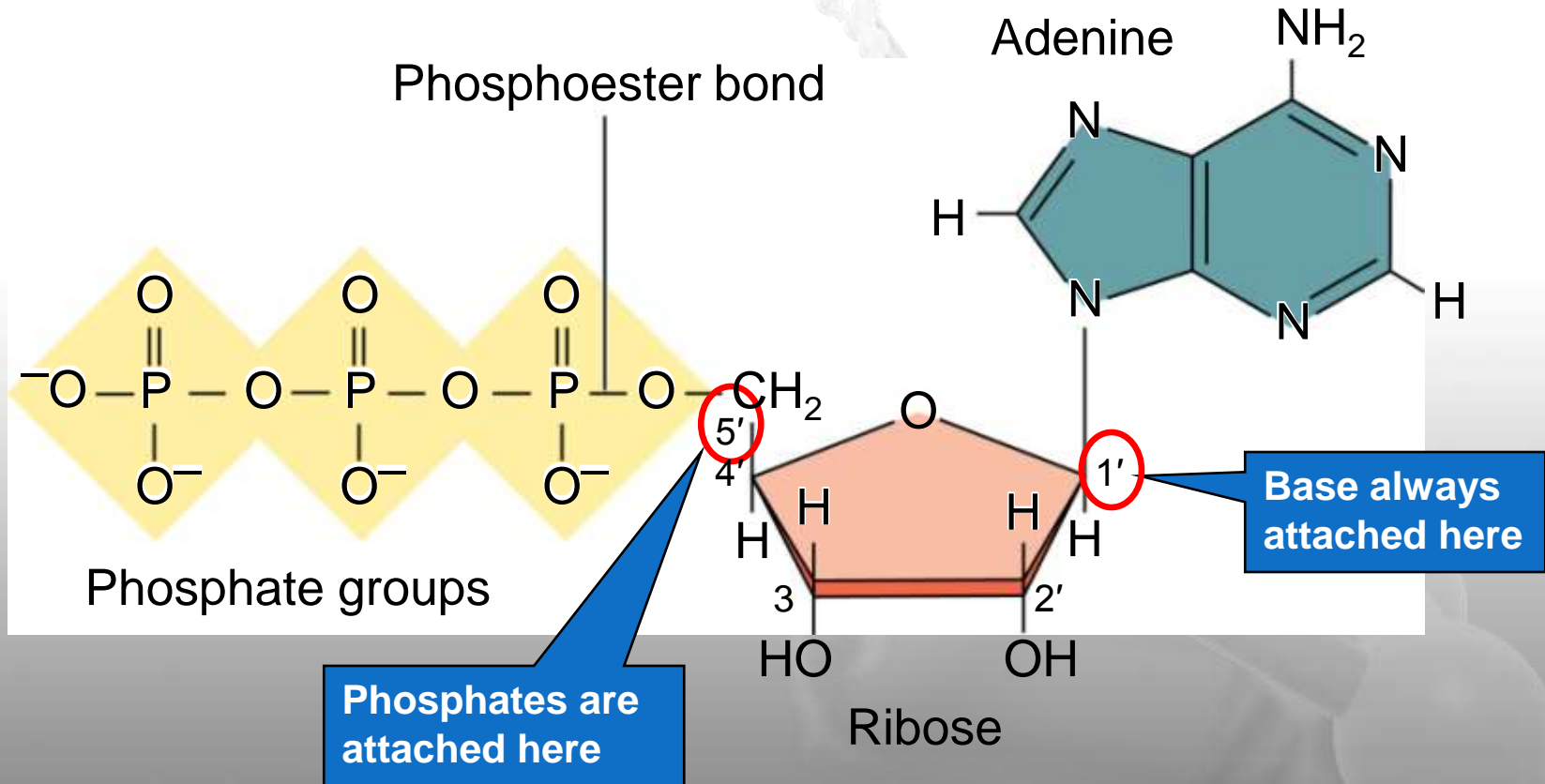

❖ Covalent bonding B/W Nucleotides

- Nucleotides are linked together by covalent bonds called phosphodiester linkage.

A chemical bond that involves sharing a pair of electrons between atoms in a molecule.

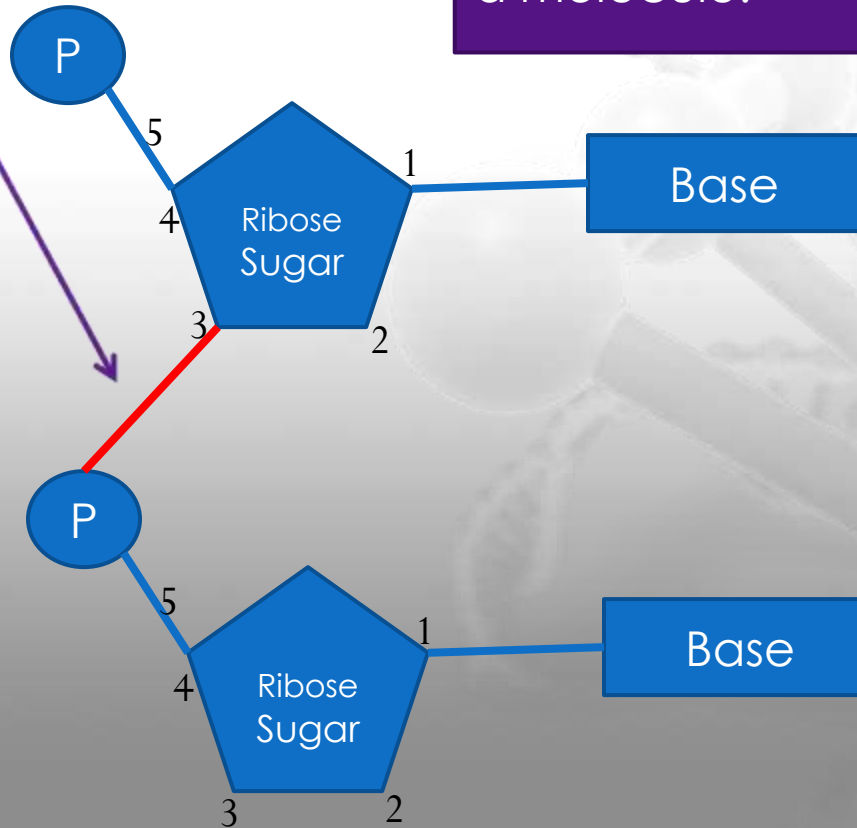

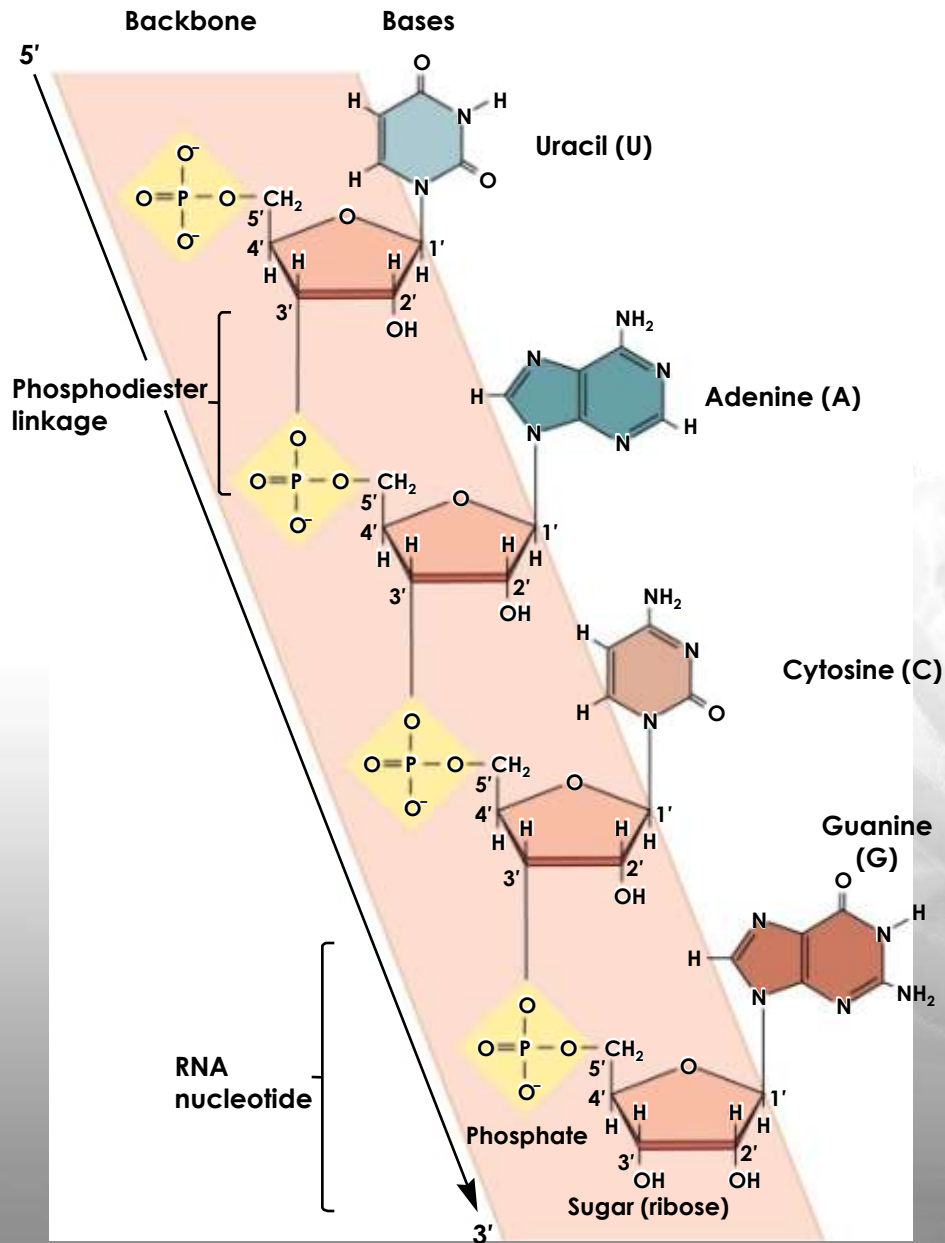

❖ Hydrogen bonding

- Usually RNA is single stranded, But in some viruses RNA present in double stranded form.
- The bases in two strands are paired through hydrogen bond (H-bonds) forming base pairs (bp). **Adenine** forms **two** hydrogen bonds with **Uracil** from opposite strand and vice-versa. Similarly, **Guanine** is bonded with **Cytosine** with **three** H-bonds.

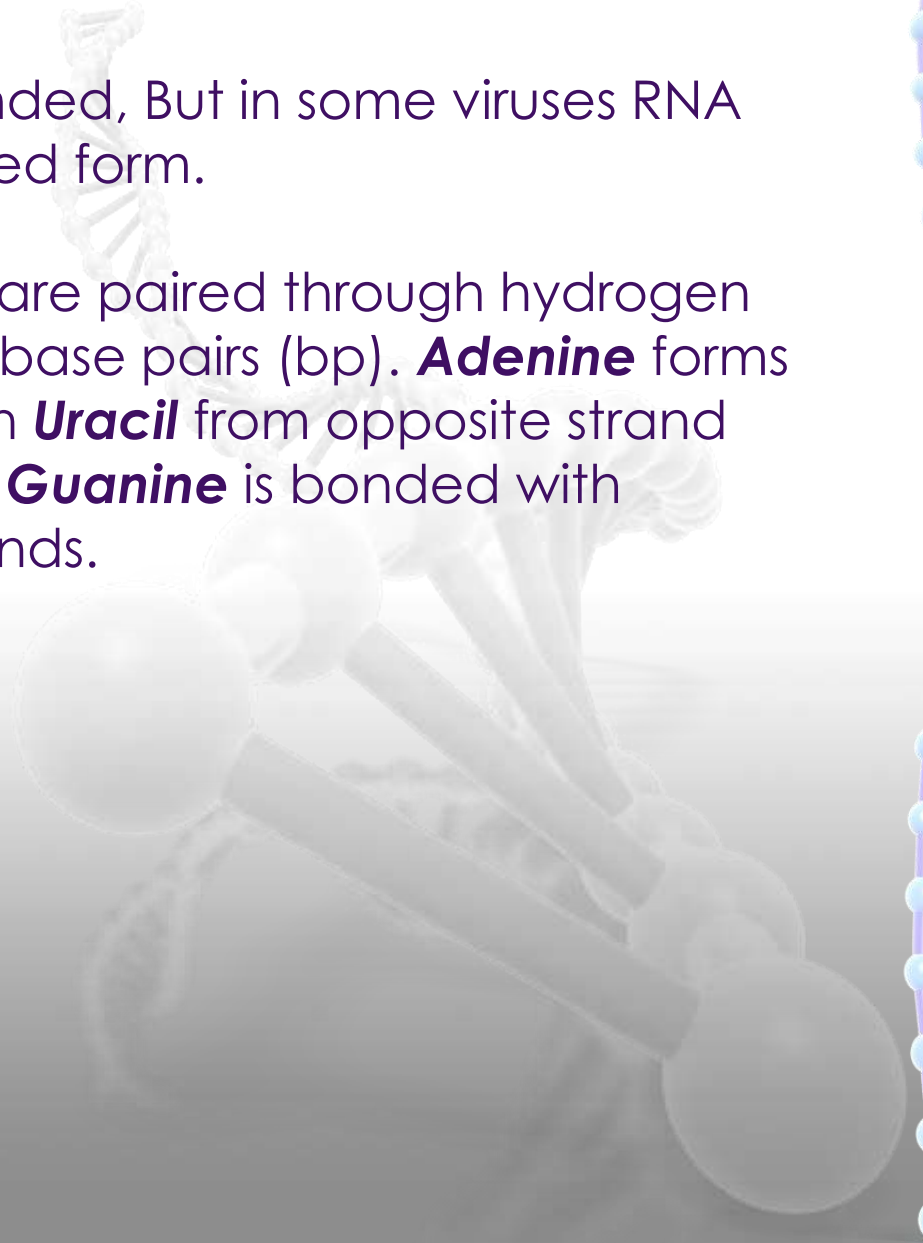

❖ dsRNA Structure

- There are double-stranded RNA structures
 - ✓ RNA can fold back on itself
 - ✓ Depends on base sequence
 - ✓ Gives stem (double-strand) and loop (single-strand structures)
- ds RNA has an A-like conformation
 - ✓ Steric clashes between 2'-OH groups prevent the B-like conformation.

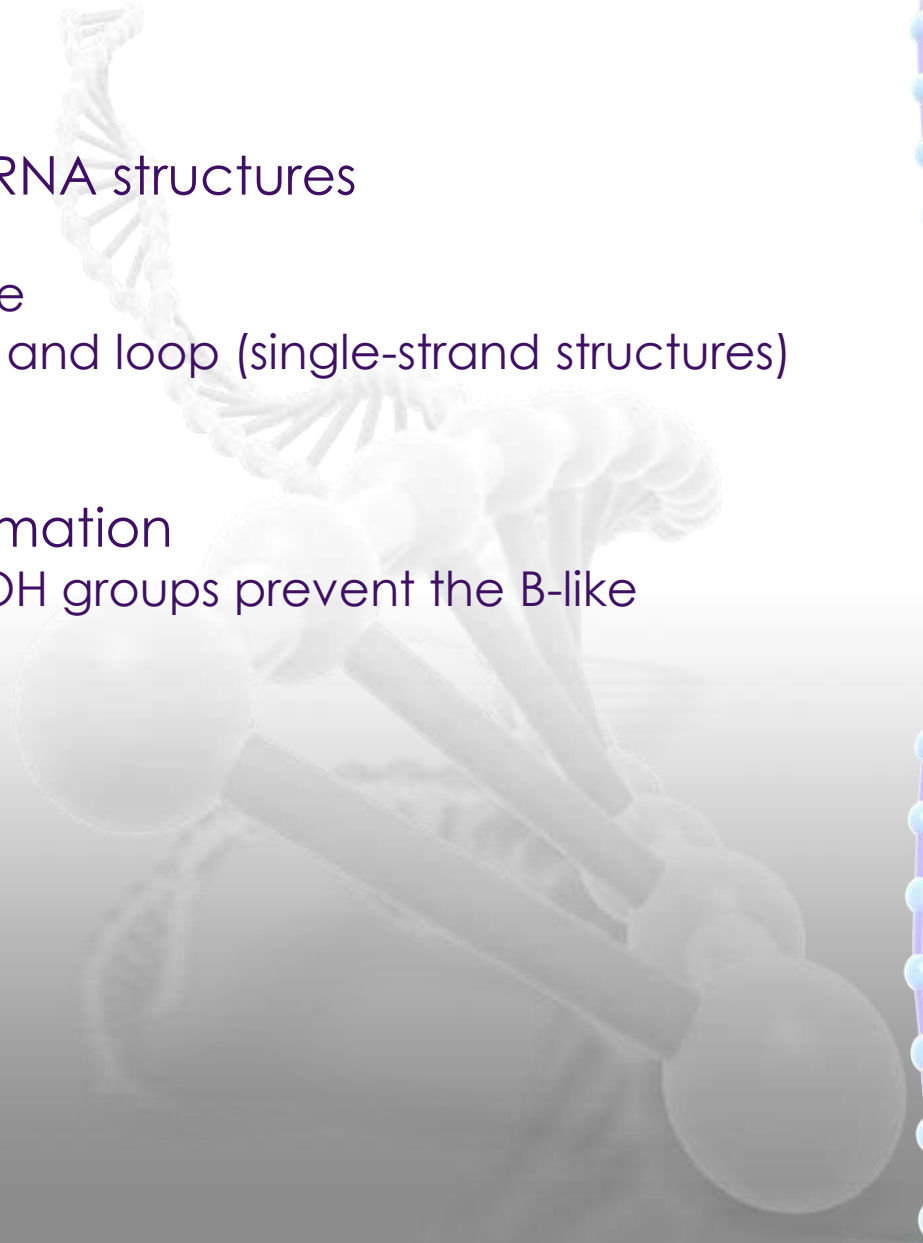

**Complementary regions
Held together by
hydrogen bonds**

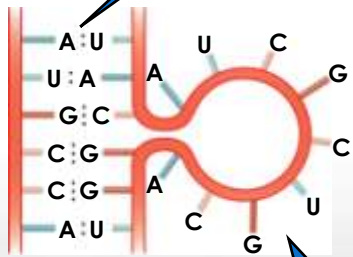

(a) Bulge loop

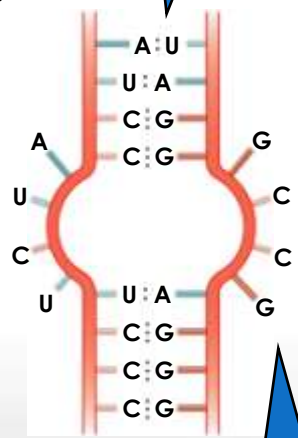

(b) Internal loop

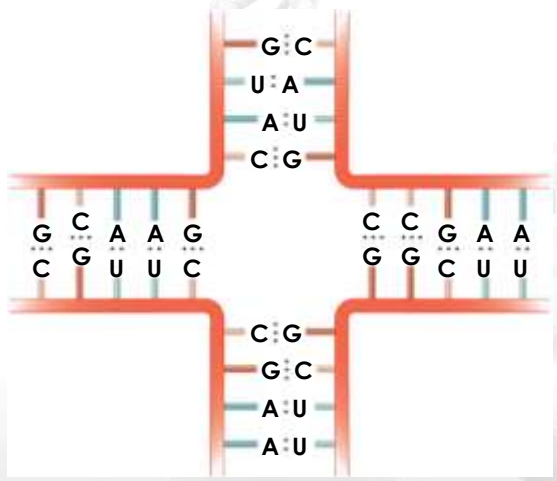

(c) Multibranched junction

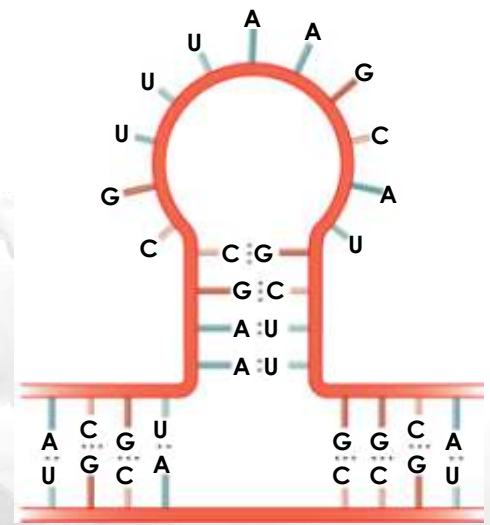

(d) Stem-loop

**Non-complementary regions
Have bases projecting away
from double stranded regions**

**Also called
hair-pin**

❖ Types of RNA

- In all prokaryotic and eukaryotic organisms, three main classes of RNA molecules exist-
 - 1) Messenger RNA (m RNA)
 - 2) Transfer RNA (t RNA)
 - 3) Ribosomal RNA (r RNA)
- The other are –
 - ✓ small nuclear RNA (SnRNA),
 - ✓ micro RNA (mi RNA) and
 - ✓ small interfering RNA (Si RNA) and
 - ✓ heterogeneous nuclear RNA (hnRNA).

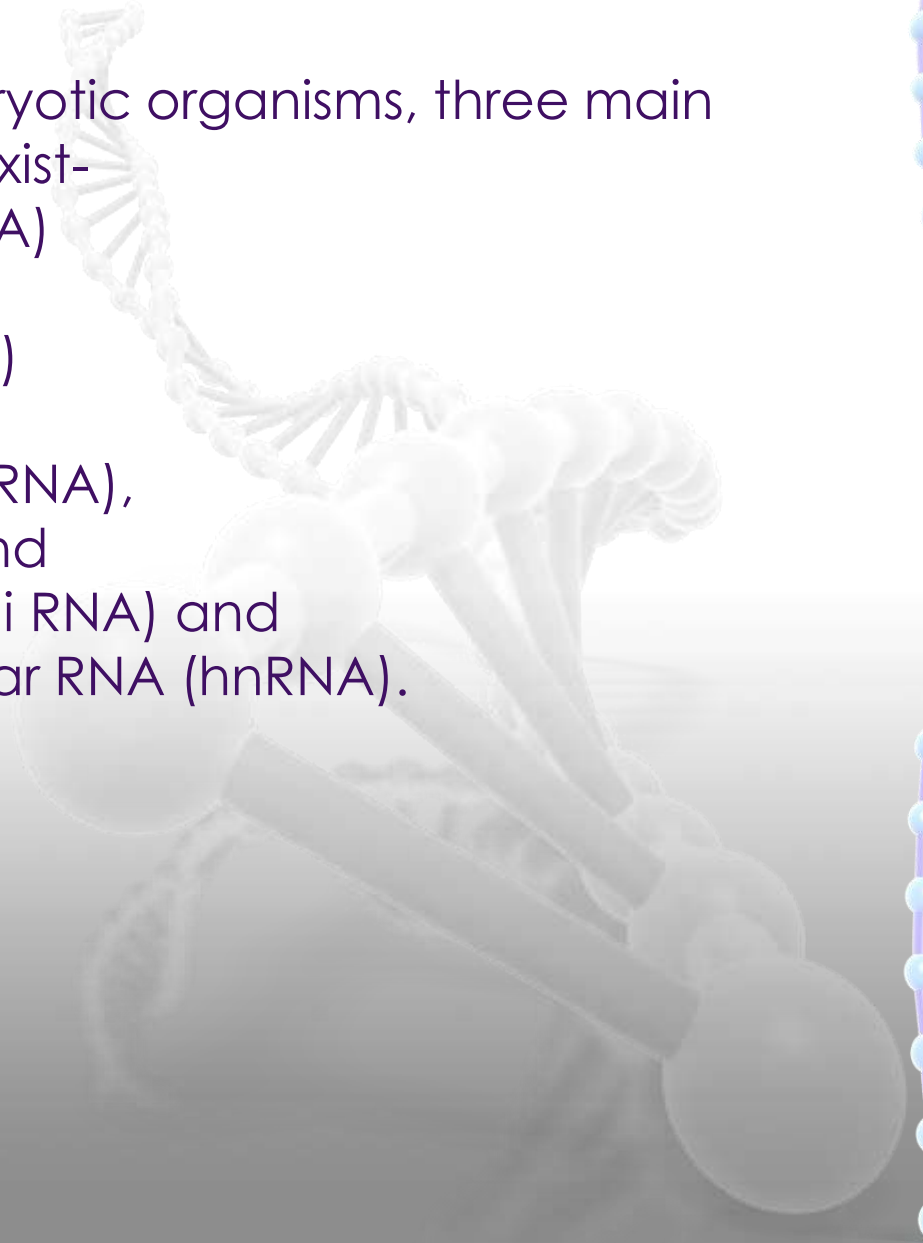

❖ Messenger RNA (m-RNA)

- All members of the class function as messengers carrying the information in a gene to the protein synthesizing machinery

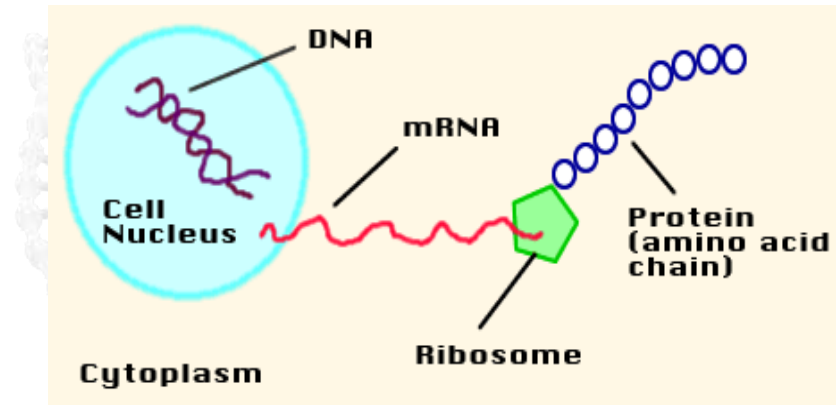

❖ Structure

- The 5' terminal end is capped by **7- methyl guanosine triphosphate cap**.
- The cap is involved in the **recognition of mRNA** by the translating machinery.
- It stabilizes m RNA by protecting it from 5' **exonuclease**.
- The 3' end of most m-RNAs have a polymer of Adenylate residues(20-250).
- The tail prevents the attack by 3' exonucleases.
- On both 5' and 3' end there are non coding sequences which are not translated (NCS)

- The intervening region between non coding sequences present between 5' and 3' end is called coding region. This region encodes for the synthesis of a protein.

The structure of a typical human protein coding mRNA including the untranslated regions (UTRs)

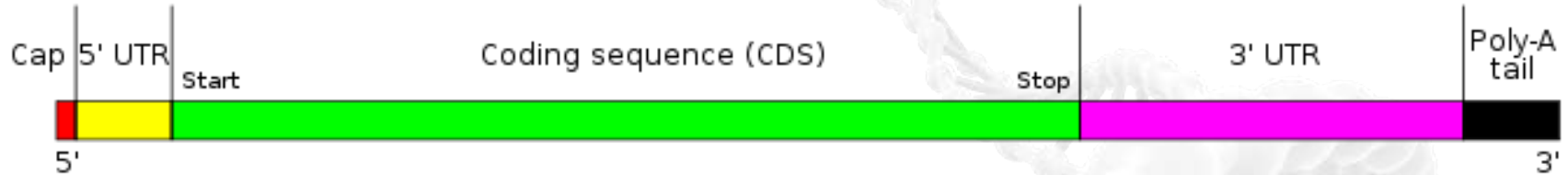

Eukaryotic mRNA molecule

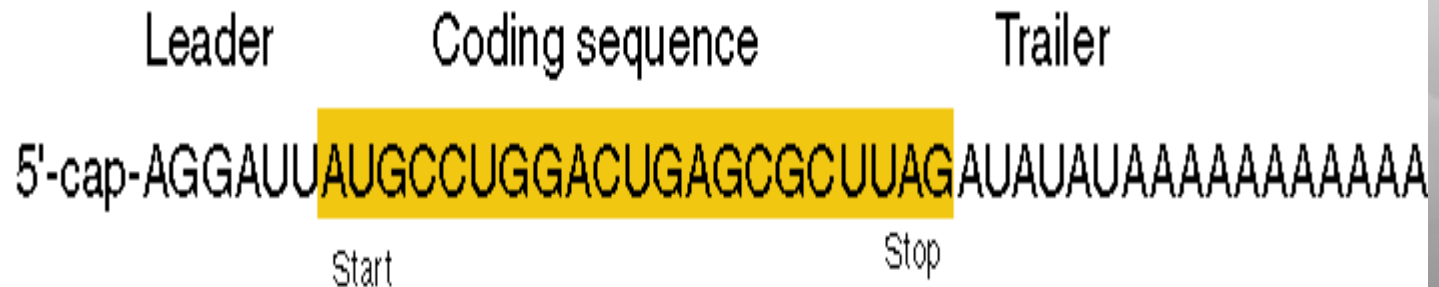

❖ Heterogeneous nuclear RNA (hnRNA) [Precursor mRNA]

- In mammalian nuclei , hnRNA is the immediate product of gene transcription
- The nuclear product is heterogeneous in size (Variable) and is very large.
- 75 % of hnRNA is degraded in the nucleus, only 25% is processed to mature m RNA.
- Mature m –RNA is formed from primary transcript by capping, tailing, splicing and base modification.

❖ Transfer RNA (t-RNA)

- Transfer RNA are the smallest of three major species of RNA molecules
- They have 74-95 nucleotide residues
- They transfer the amino acids from cytoplasm to the protein synthesizing machinery, hence the name t RNA.
- They are also called Adapter molecules, since they act as adapters for the translation of the sequence of nucleotides of the m RNA in to specific amino acids
- There are at least 20 species of tRNA one corresponding to each of the 20 amino acids required for protein synthesis.
- **tRNA** is the only RNA species that contains the **nucleoside thymidine**.

❖ Structure

1) Primary structure- The nucleotide sequence of all the t RNA molecules allows extensive intrastand complementarity that generates a secondary structure.

2) Secondary structure- Each single t- RNA shows extensive internal base pairing and acquires a clover leaf like structure. The structure is stabilized by hydrogen bonding between the bases and is a consistent feature.

Secondary structure (Clover leaf structure)

All t-RNA contain 5 main arms or loops which are as follows-

- Acceptor arm
- Anticodon arm
- D HU arm (***DihydroUracil***)
- T Ψ C arm (***Thymidine Pseudouridine Cytosine***)
- Extra arm

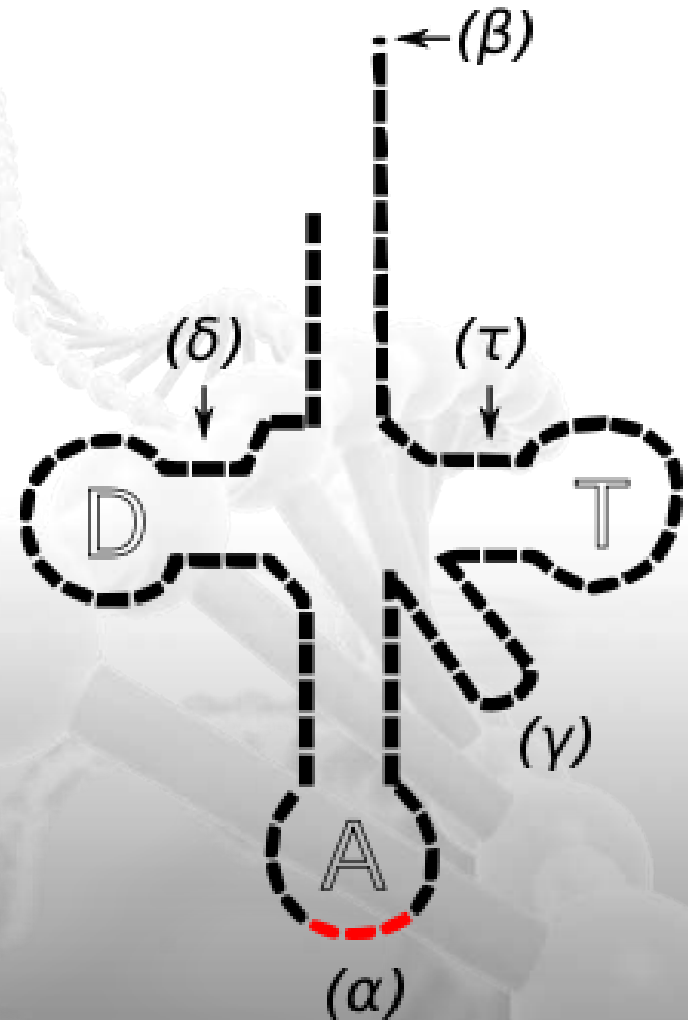

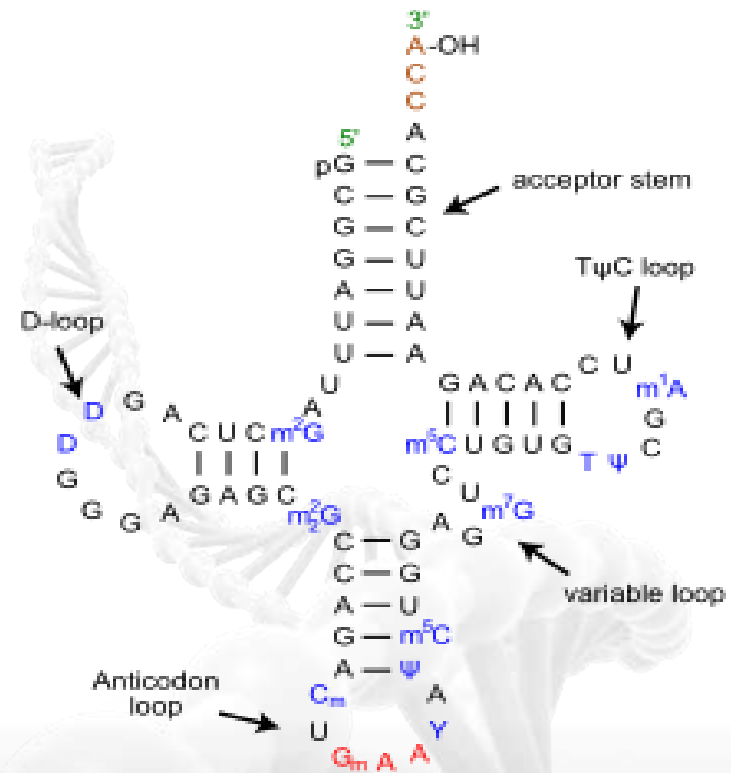
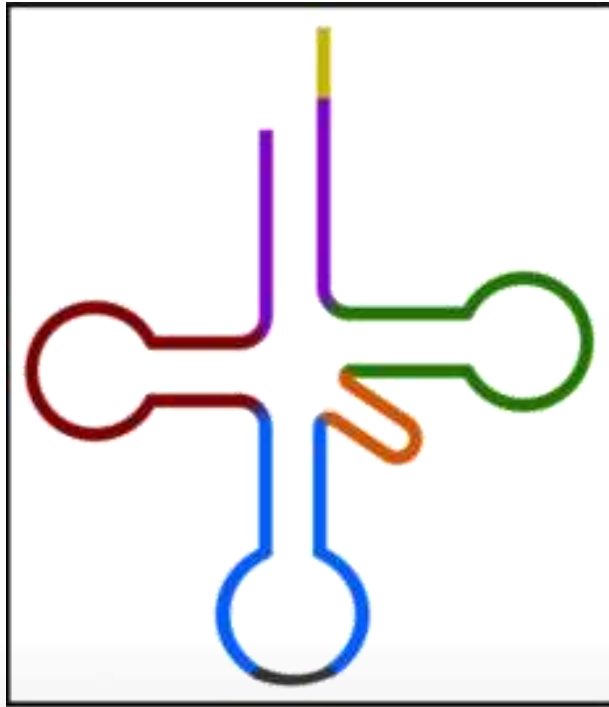

Secondary structure of tRNA. **CCA tail** in **yellow**, **Acceptor stem** in **purple**, **Variable loop** in **orange**, **D arm** in **red**, **Anticodon arm** in **blue** with **Anticodon** in **black**, **T arm** in **green**.

3) Tertiary structure of t-RNA

- The L shaped tertiary structure is formed by further folding of the clover leaf due to hydrogen bonds between T and D arms.
- The base paired double helical stems get arranged in to two double helical columns, continuous and perpendicular to one another.

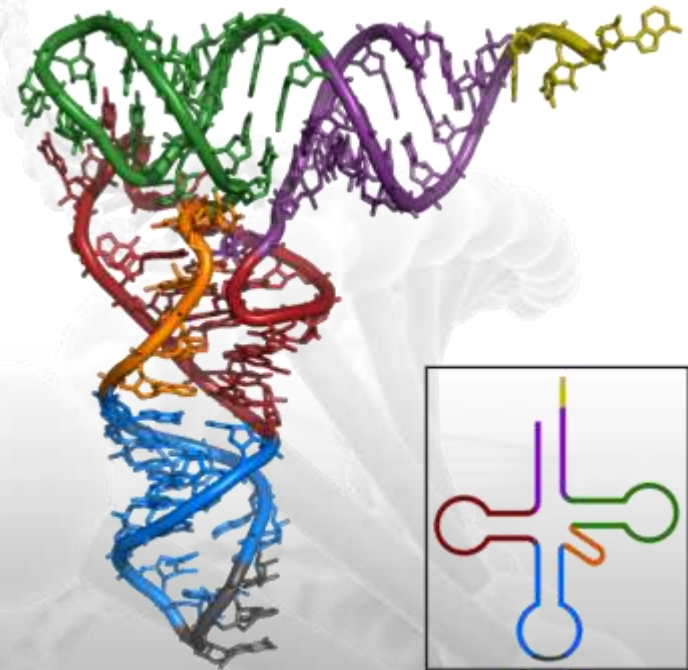

❖ Ribosomal RNA (rRNA)

- **Ribosomal ribonucleic acid (rRNA)** is the **RNA** component of the **ribosome**, and is essential for **protein synthesis** in all living organisms.
- The functions of the ribosomal RNA molecules in the ribosomal particle are not fully understood, but they are necessary for ribosomal assembly and seem to play key roles in the binding of mRNA to ribosomes and its translation
- Recent studies suggest that an rRNA component performs the peptidyl transferase activity and thus is an enzyme (a ribozyme).
- It constitutes the predominant material within the ribosome, which is approximately 60% rRNA and 40% protein by weight.
- Ribosomes contain two major rRNAs and 50 or more proteins.
- The ribosomal RNAs form two subunits, the large subunit (LSU) and small subunit (SSU). The LSU rRNA acts as a **ribozyme**, catalysing **peptide bond formation**.

❖ Small RNA molecules

□ Major types of small RNA molecules:

- Small nuclear RNA (snRNA) - involved in mRNA splicing.
- Small nucleolar RNA (snoRNA) - directs the modification of ribosomal RNAs.
- Micro RNA (miRNA) and short interfering RNA (siRNA) - regulate gene expression.

❖ Differences between RNA and DNA

| S.No. | RNA | DNA |
|-------|---|--|
| 1) | Single stranded mainly except when self complementary sequences are there it forms a double stranded structure (Hair pin structure) | Double stranded (Except for certain viral DNA s which are single stranded) |
| 2) | Ribose is the main sugar | The sugar moiety is deoxy ribose |
| 3) | Pyrimidine components differ. Thymine is never found (Except tRNA) | Thymine is always there but uracil is never found |
| 4) | Being single stranded structure- It does not follow Chargaff's rule | It does follow Chargaff's rule. The total purine content in a double stranded DNA is always equal to pyrimidine content. |

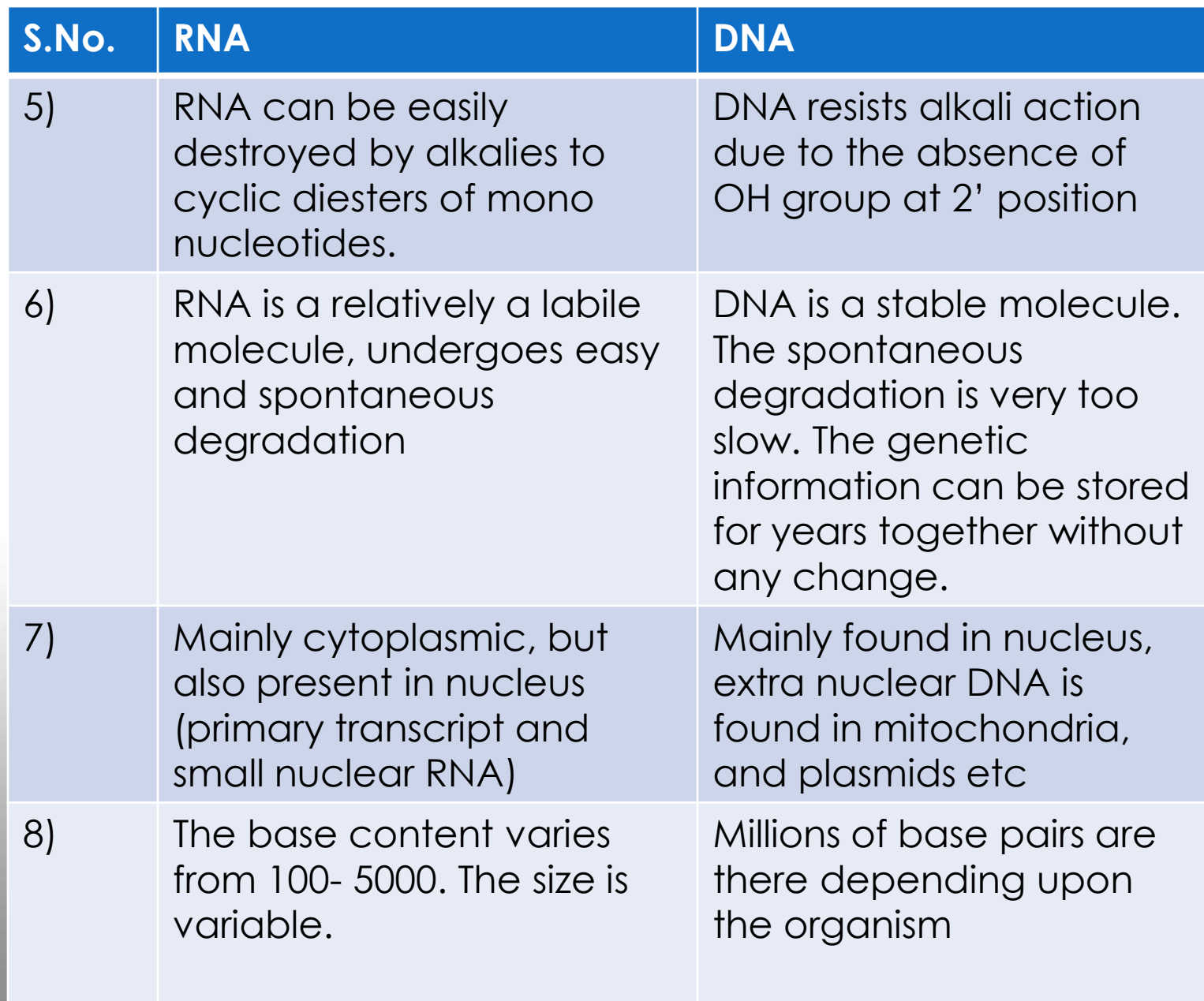

| S.No. | RNA | DNA |
|-------|--|--|
| 5) | RNA can be easily destroyed by alkalis to cyclic diesters of mono nucleotides. | DNA resists alkali action due to the absence of OH group at 2' position |
| 6) | RNA is a relatively a labile molecule, undergoes easy and spontaneous degradation | DNA is a stable molecule. The spontaneous degradation is very too slow. The genetic information can be stored for years together without any change. |
| 7) | Mainly cytoplasmic, but also present in nucleus (primary transcript and small nuclear RNA) | Mainly found in nucleus, extra nuclear DNA is found in mitochondria, and plasmids etc |
| 8) | The base content varies from 100- 5000. The size is variable. | Millions of base pairs are there depending upon the organism |

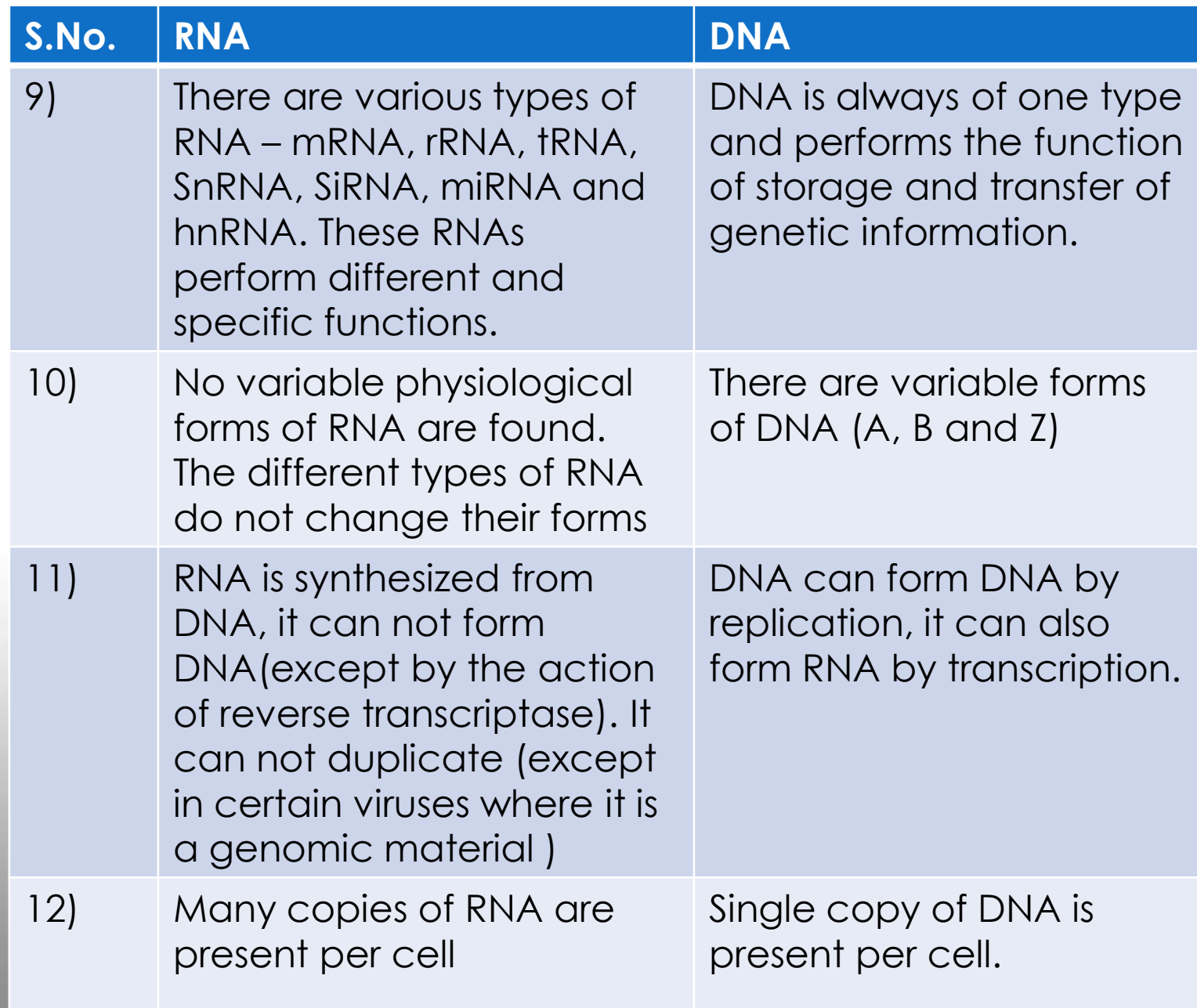

| S.No. | RNA | DNA |
|-------|---|---|
| 9) | There are various types of RNA – mRNA, rRNA, tRNA, SnRNA, SiRNA, miRNA and hnRNA. These RNAs perform different and specific functions. | DNA is always of one type and performs the function of storage and transfer of genetic information. |
| 10) | No variable physiological forms of RNA are found. The different types of RNA do not change their forms | There are variable forms of DNA (A, B and Z) |
| 11) | RNA is synthesized from DNA, it can not form DNA(except by the action of reverse transcriptase). It can not duplicate (except in certain viruses where it is a genomic material) | DNA can form DNA by replication, it can also form RNA by transcription. |
| 12) | Many copies of RNA are present per cell | Single copy of DNA is present per cell. |

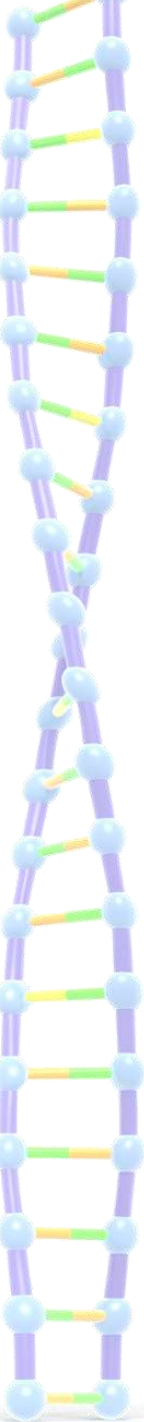

Thank

You

