

LARGE SCALE PRODUCTION FERMENTER DESIGN AND ITS VARIOUS CONTROLS

**Suman Kumar Meikap
CUTM BHUBANESWAR**

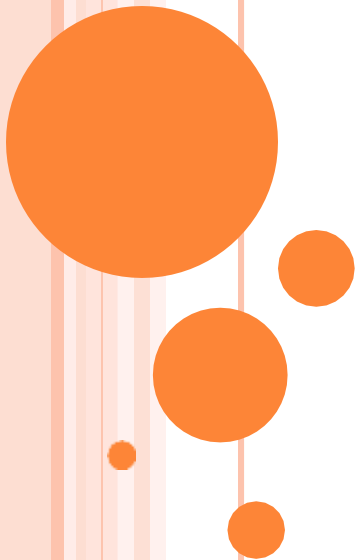

INTRODUCTION

- Fermentor - industrial usage microbes grown in large vessels.
- Bioreactor
- Complicated in design



IDEAL FERMENTOR PROPERTIES

- Supports maximum growth of the organism
- Aseptical operation
- Adequate aeration and agitation
- Low power consuming
- Temperature control system
- pH control system
- Sampling facilities
- Minimum evaporation loss
- Minimum use of labour
- Range of processes
- Smooth internal surfaces
- Similar in geometry to both smaller & larger vessels in pilot plant



- Cheapest material usage
- Adequate service provisions
- Provision for control of contaminants
- Provision for intermittent addition of antifoams
- Inoculum introduction facility
- Mechanism for biomass/ product removal
- Setting for rapid incorporation of sterile air
- Withstands pressure
- Ease of manipulation



BASIC DESIGN OF A FERMENTOR

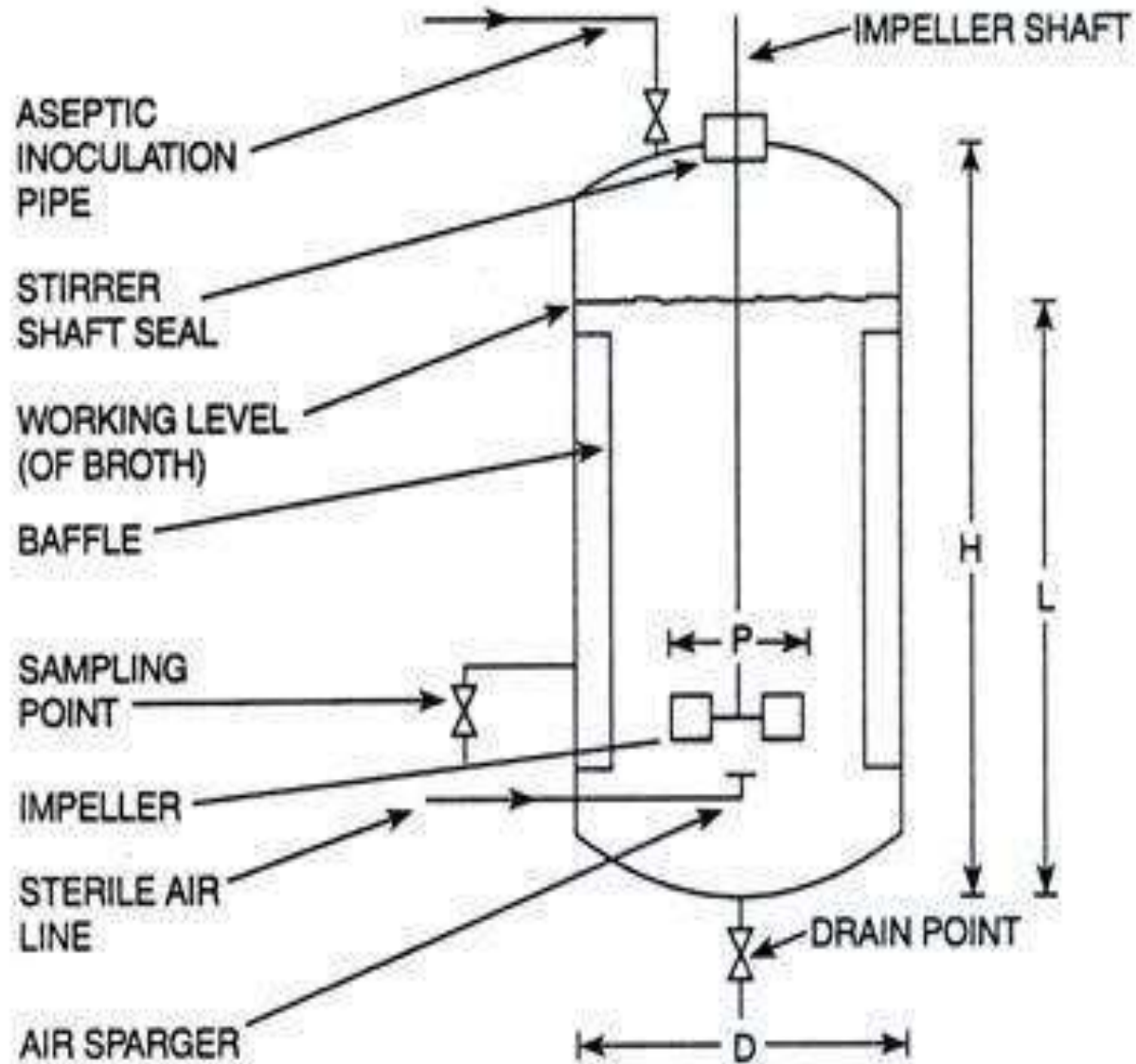

FIG. 14.3. Diagram of a fermenter with one multi-bladed impeller. H, fermenter height; L, liquid height; D, tank diameter; P, impeller diameter.

Various components of an ideal fermenter for batch process are

S.No.	Part	Purpose
1	Top plate	cover (made of steel)
2	Clamp	top plate compressed onto vessel using clamp
3	Seal	separates top plate from vessel (glass) to prevent air leakage
4	Vessel	glass, jacketed, steel with ports for various outputs, inputs, probes etc
5	Drive motor	used to drive mixing shaft
6	Drive shaft	mixes the medium evenly with its impeller
7	Marine impeller	for plant tissue culture
8	Baffles	prevent sedimentation on sides and proper mixing
9	Sparger	air supplier / after filtration via membranes – ensures efficient dispersal – by attached to impeller
10	Exit gas cooler	like condenser remove as much moisture as possible from exhaust
11	Inoculation needle	port to add inoculum
12	Feed pumps	regulates the flow rates of additives (medium, nutrients) variable speed
13	Peristaltic pumps	fixed speed pumps – used for continuous sampling
14	Syringe pump	using a syringe – mostly used in batch
15	Exit gas analysis	CO ₂ analyzer, O ₂ analyzer, mass spectrometer
16	Sample pipe	through which samples are drawn
17	3 way inlet	to insert different probes

Monitoring and controlling parts of fermenter are

S.No	Part	Use
1	Pt100	temperature sensor (platinum resistance electrode)
2	Foam probe	kept above the medium level to sense foam formation
3	pH electrode	senses pH
4	O ₂ sensor	Monitors dissolved oxygen level
5	Heater pad	directly heats the medium
6	Cold finger	after direct heating – used to cool the vessel contents (closed coil/pipe to pass cool water)
7	Rotameter	variable air flow meter – indicates rate of air flow into vessel – attached to air sparger
8	Pressure valve	attached to rotameter for safer operation
9	Air pump	supply of air
10	Peristaltic pump	to pump in medium, acids, bases, antifoam



SHAPE OF FERMENTER:

Fermentation Are Available In Different Shapes Like

Conical Fermenter

Cylindrical fermenter

Spherical fermenter

Pear In Shape Fermenter

SIZES OF FERMENTER :

The sizes of the fermenter are divided into the following groups.

1. The microbial cell (mm cube)
2. Shake flask (100-1000ml)
3. Laboratory fermenter (1-50 L)
4. Pilot scale (0.3 -10m cube)
5. Industrial scale (2-500m cube)



MATERIAL OF CONSTRUCTION

Laboratory scale bioreactor:

In fermentation with strict aseptic requirements it is important to select materials that can withstand repeated sterilization cycles. On a small scale, it is possible to use glass and/or stainless steel.

Glass is useful because it gives smooth surfaces, is non-toxic, corrosion proof and it is usually easy to examine the interior of vessel. The glass should be 100% borosilicate, e.g. Pyrex® and Kimax®.

The following variants of the laboratory bioreactor can be made:

1. Glass bioreactor (without the jacket) with an upper stainless steel lid.
2. Glass bioreactor (with the jacket) with an upper stainless steel lid.
3. Glass bioreactor (without the jacket) with the upper and lower stainless steel lids.
4. Two-part bioreactor - glass/stainless steel. The stainless steel part has a jacket and ports for electrodes installation.
5. Stainless steel bioreactor with peepholes.

Vessels with two stainless steel plates cost approximately 50% more than those with just a top plate



Pilot scale and large scale bioreactors:

When all bioreactors are sterilized in situ, any materials use will have to assess on their ability to withstand pressure sterilization and corrosion and their potential toxicity and cost.

Pilot scale and large scale vessels are normally constructed of stainless steel or at least have a stainless steel cladding to limit corrosion.

The American Iron and Steel Institute (AISI) states that steels containing less than 4% chromium are classified as steel alloys and those containing more than 4% are classified as stainless steel.

Mild steel coated with glass or phenolic epoxy materials has occasionally been used. Wood, concrete and plastic have been used when contamination was not a problem in a process.

Vessel shape: -

Typical tanks are vertical cylinders with specialized top plates and bottom plates. In some cases, vessel design eliminates the need for a stirrer system especially in air lift fermenter. A tall, thin vessel is the best shape with aspect ratio (height to diameter ratio) around 10:1. Sometimes a conical section is used in the top part of the vessel to give the widest possible area for gas exchange.



Stainless steel top plates.

The top plates are of an elliptical or spherical dish shape. The top plates can be either removable or welded. A removable top plate provides best accessibility, but adds to cost and complexity. Various ports and standard nozzles are provided on the stainless plate for actuators and probes. These include pH, thermocouple, and dissolved oxygen probes ports, defaming, acid and base ports, inoculum port, pipe for sparging process air, agitator shaft and spare ports.

Bottom plates:

Tank bottom plates are also customized for specific applications. Almost most of the large vessels have a dish bottom, while the smaller vessels are often conical in shape or may have a smaller, sump type chamber located at the base of the main tank. These alternate bottom shapes aid in fluid management when the volume in the tank is low. One report states that a dish bottom requires less power than a flat one.

In all cases, it is imperative that tank should be fully drainable to recover product and to aid in cleaning of the vessel. Often this is accomplished by using a tank bottom valve positioned to eliminate any “dead section” that could arises from drain lines and to assure that all content will be removed from the tank upon draining.



If the bioreactor has a lower cover, then the following ports and elements should be placed and fastened there:

1. Discharge valve;
2. Sampling device;
3. Sparger;
4. Mixer's lower drive;
5. Heaters.

Height-to-diameter ratio (Aspect ratio).

The height-to-diameter ratio is also a critical factor in vessel design. Although a symmetrical vessel maximizes the volume per material used and results in a height-to-diameter ratio of one, most vessels are designed with higher ratio. The range of 2-3:1 is more appropriate and in some situation, where stratification of the tank content is not an issue or a mixer is used, will allow still higher ratio to be used in design.

The vessels for microbiological work should have an aspect ratio of 2.5-3:1, while vessels for animal cell culture tend to have an aspect ratio closer to 1. The basic configuration of stirred tank bioreactors for mammalian cell culture is similar to that of microbial fermenter but the major difference is there in aspect ratio, which is usually smaller in mammalian cell culture bioreactor.

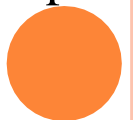

FERMENTOR'S STRUCTURAL COMPONENTS IN AERATION & AGITATION SYSTEM:

- The agitator
- Stirrer glands & bearings
- Baffles
- The aeration system



AGITATOR

- Synonym : impeller
- Mounted to a shaft through a bearing in the lid
- Driven by an external power source or direct drive
- Direct drive - action varied by using different impeller blades
- Recent designs – driven by magnetic coupling to a motor mounted beneath the fermenter
- High speed of rotation marked vortex occurs
- Spinning of medium in circular direction
- **MIXING OBJECTIVES IT ACHIEVE**
- Bulk fluid & gas
- Heattransfer phase mixing
- Air dispersion
- Suspension of solid particles
- O₂ transfer
- Maintenance of uniform environment throughout the vessel



CLASSIFICATION

- Disc turbine
- Vanned disc
- Variable pitch open turbine
- Marine propellers

DISC TURBINE:

- A disc with series of rectangular vanes set in a vertical plane around the circumference.
- Break up a fast air stream without itself becoming flooded in air bubbles



VANED DISC

- A series of rectangular vanes attached vertically to the underside
- Air from sparger hits its underside & the air gets displaced towards the vanes
- Results in destruction of air bubbles

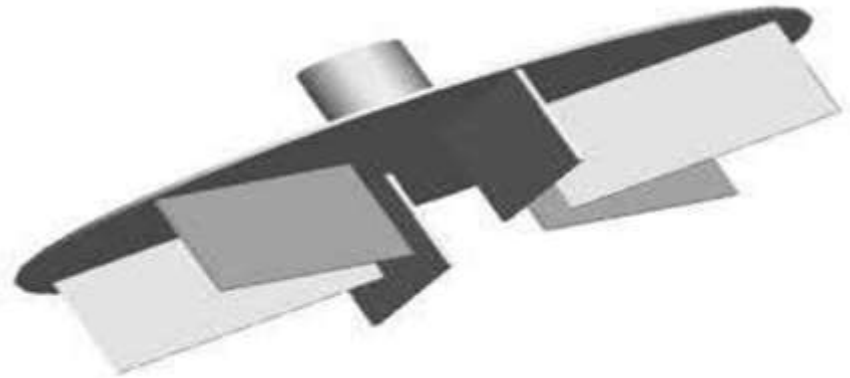

VARIABLE PITCH OPEN TURBINE:

- Vanes are attached directly to a boss on the agitator shaft
- Air bubbles hit any surface by its action
- Flood when superficial velocity exceed 21m/h

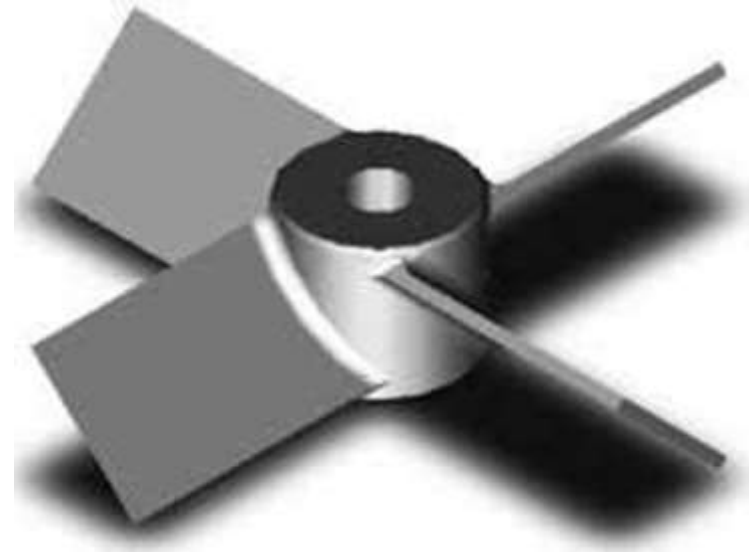

Kaplan - Variable Pitch Propeller Turbine

SIDE VIEW



TOP VIEW

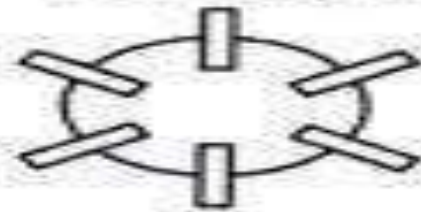

A. DISC TURBINE

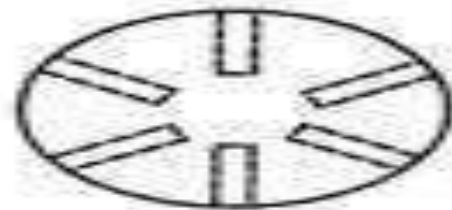

B. VANED DISC TURBINE



C. VARIABLE PITCH OPEN TURBINE



D. MARINE PROPELLER

FIG. 14.1. Different types of agitators : **A.** disc turbine; **B.** vaned disc; **C.** open turbine, variable pitch; and **D.** marine propeller agitators.

MARINE PROPELLER

- Blades are attached directly to a boss on the agitator shaft
- Air bubbles hit surface
- A single low shear impeller
- Mainly used in animal cell culture vessel
- Flood when superficial velocity exceed 21m/h



MODERN AGITATORS

- Rushton disc turbine
- Scaba 6SRGT
- Prochem max flow T
- Lightning A315
- Ekato intermig

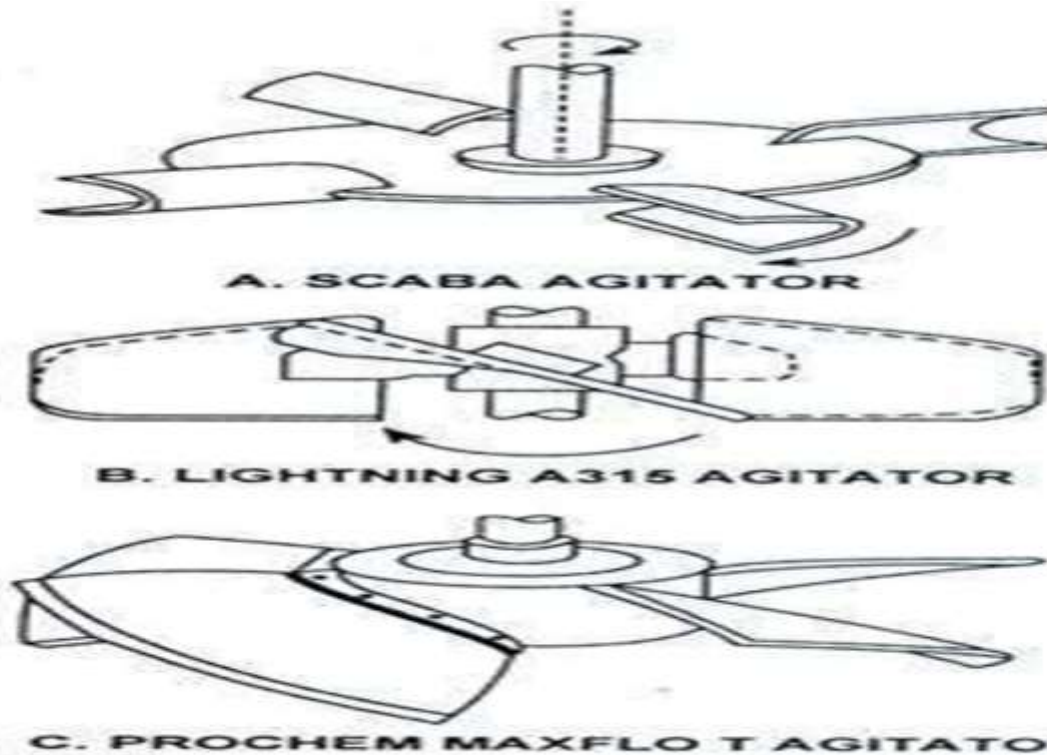
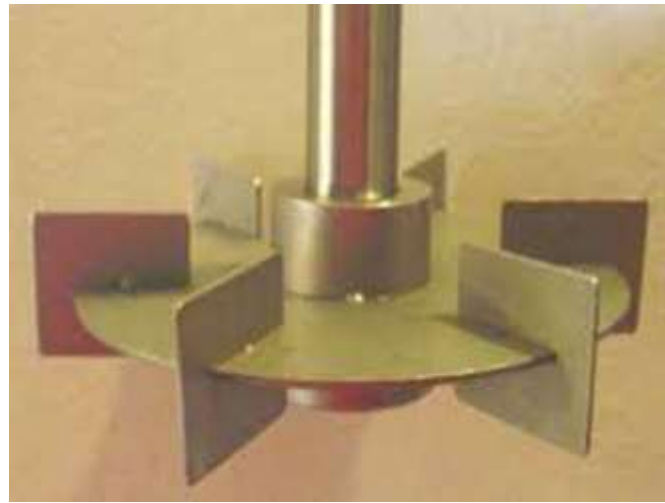
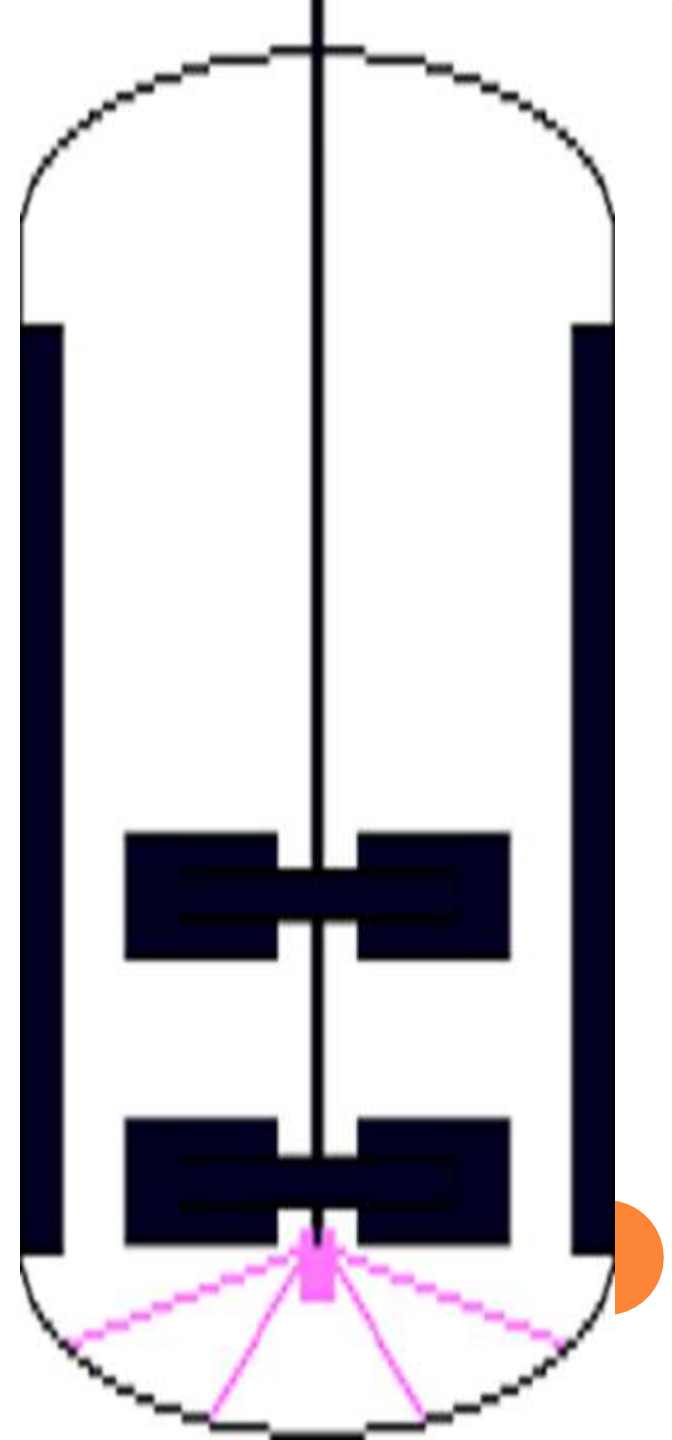

FIG. 14.2. Diagram of A. Scaba agitator; B. Lightning A315 agitator (four blades) and C. Prochem Maxflo T agitator (four, five or six blades).



BAFFLES

- Metal strips
- 1/10th of the vessel diameter
- Attached radially to wall
- 4 baffles (normal)
- Wider baffles -high agitation effect
- Narrower baffles – low agitation effect
- Can be attached with cooling coils
- Not found in lab scale fermentors.
- Vertical baffles – increased aeration



AERATION SYSTEM

- Syn : sparger
- A device that introduce air into medium
- Has a pipe with minute holes (1/64 - 1/32 inch or large)
- Hole – allows air under P to escape into medium
- For mycelial growth – 1/4 inch holes
- Impeller blades disperses air released through sparger into medium

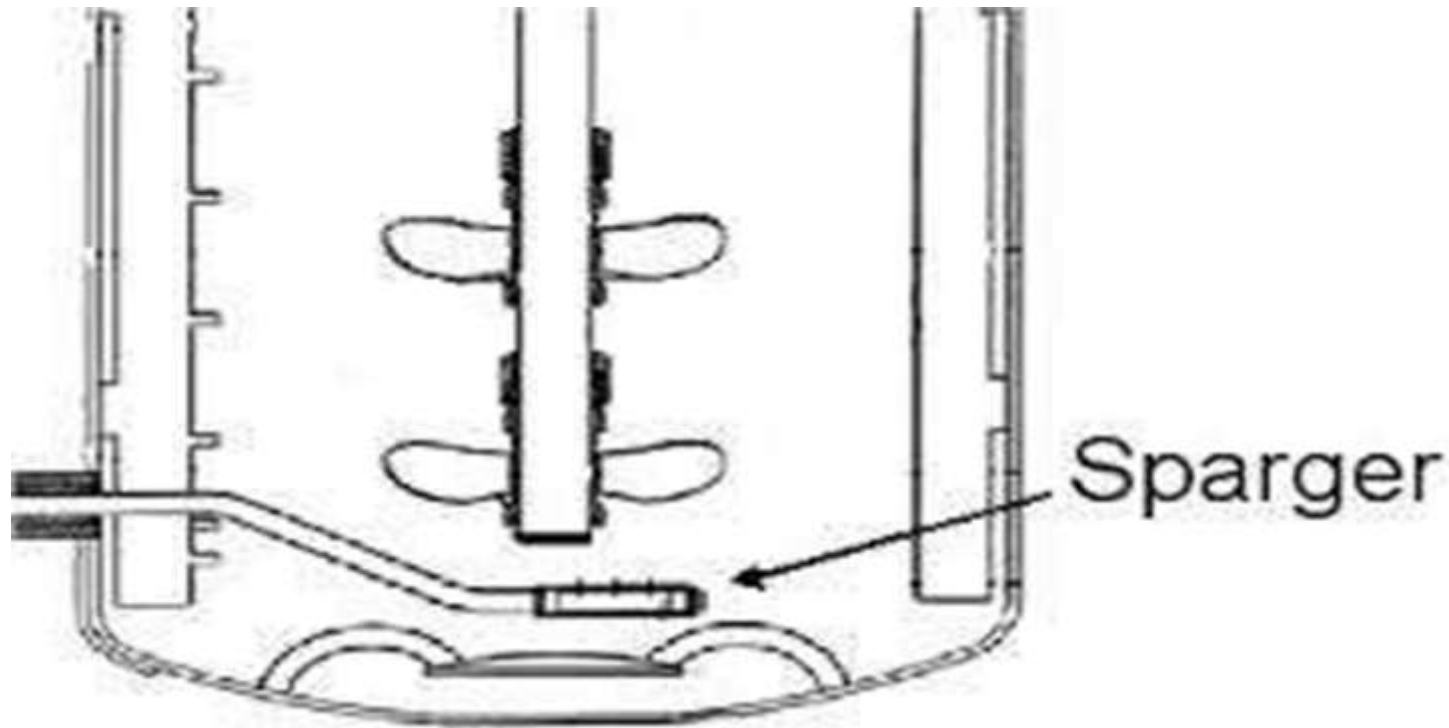

SPARGER TYPES

- Porous
- Orifice
- Nozzle

POROUS SPARGER:

- Made of sintered glass, ceramics or metal
- Used mainly on a large scale fermenters
- Bubble size produced – 10-100 times larger than pores
- Throughput of air is low – P drop across it
- Clogging of pores

ORIFICE SPARGER

- Those with drilled air holes on their under surface of the tubes making up ring or cross
- Without agitation used to a limited extend in yeast manufacture & effluent treatment

NOZZLE SPARGER

- Modern mechanically stirred fermentors use them
- Single open or partially closed pipes
- Ideally, positioned centrally below impeller
- Causes lower P drops
- no clogging of pore



Common Measurement And Control Systems

1. Speed Control
2. Temperature Control
3. Control of Gas Supply
4. Control of pH
5. Control of Dissolved Oxygen
6. Anti-Foam Control
7. Feed Control



STIRRED TANK REACTOR

- Mixing method: Mechanical agitation
- High input required
- Baffles are constructed within the built-in.
- Applications include production of antibiotics and free/immobilized enzymes
- Draw back is that high shear forces may break the cells

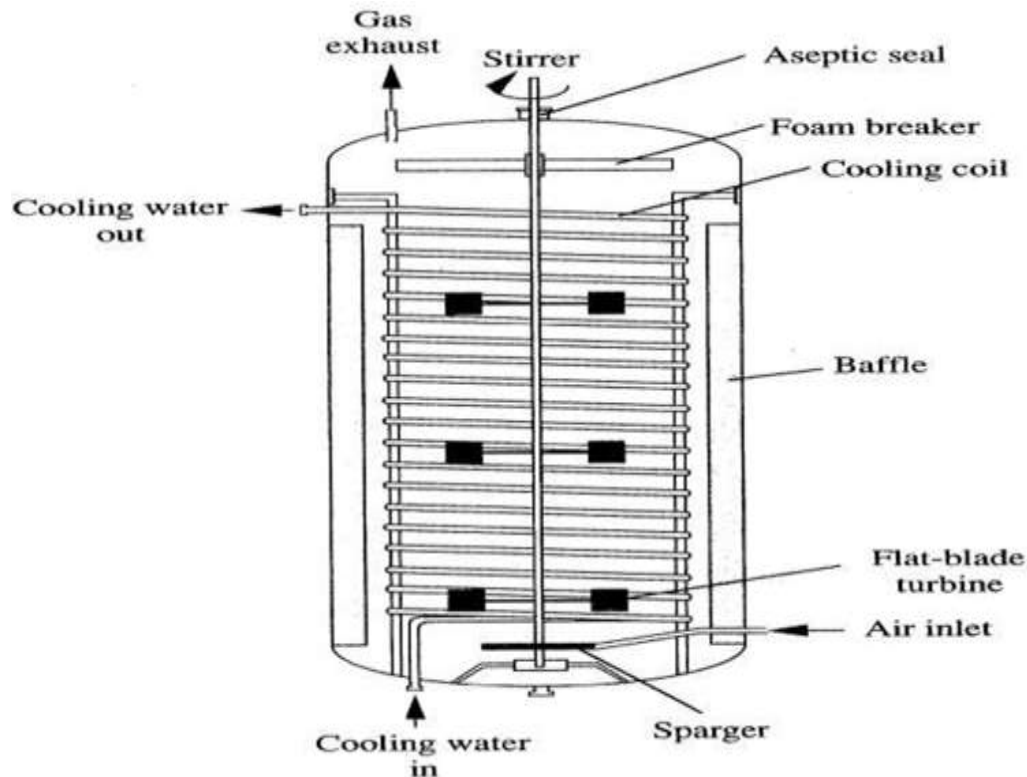

AIR LIFT REACTORS

- Mixing method: airlift
- Central draft tube
- Up-flowing stream and down flowing stream
- Homogenization of all
- components present
- Applications include bacterial, animals, plants, fungi and yeast cells

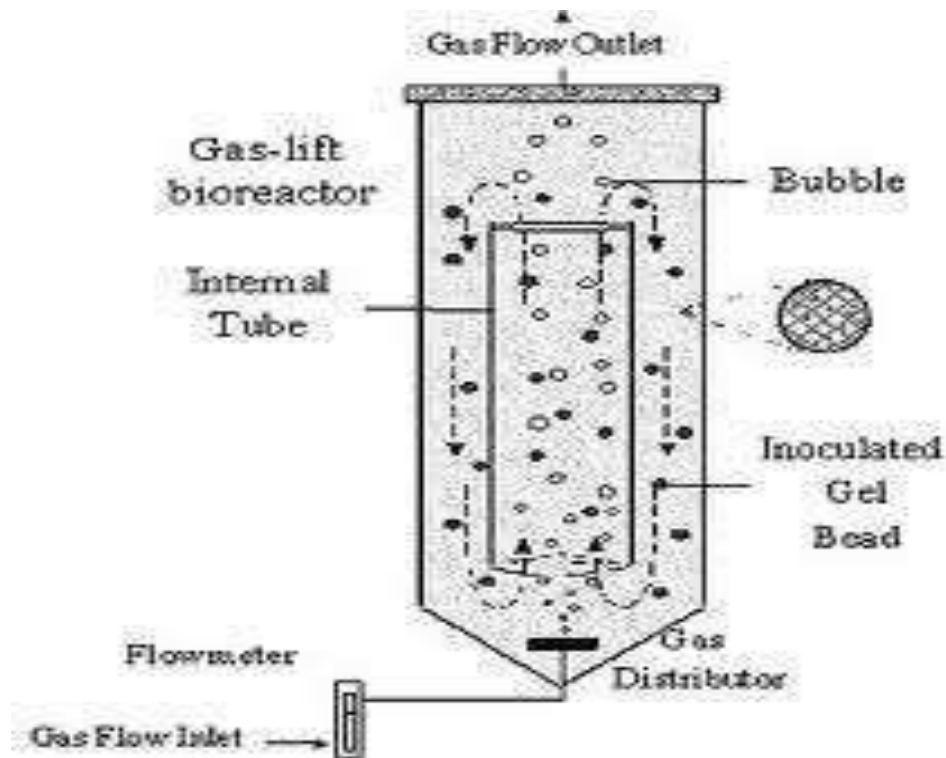

FLUIDIZED BED REACTOR

- When the packed beds are operated in up-flow mode, the bed expands at high liquid flow rates due to upward motion of the particles.
- Energy is required
- Waste water treatment

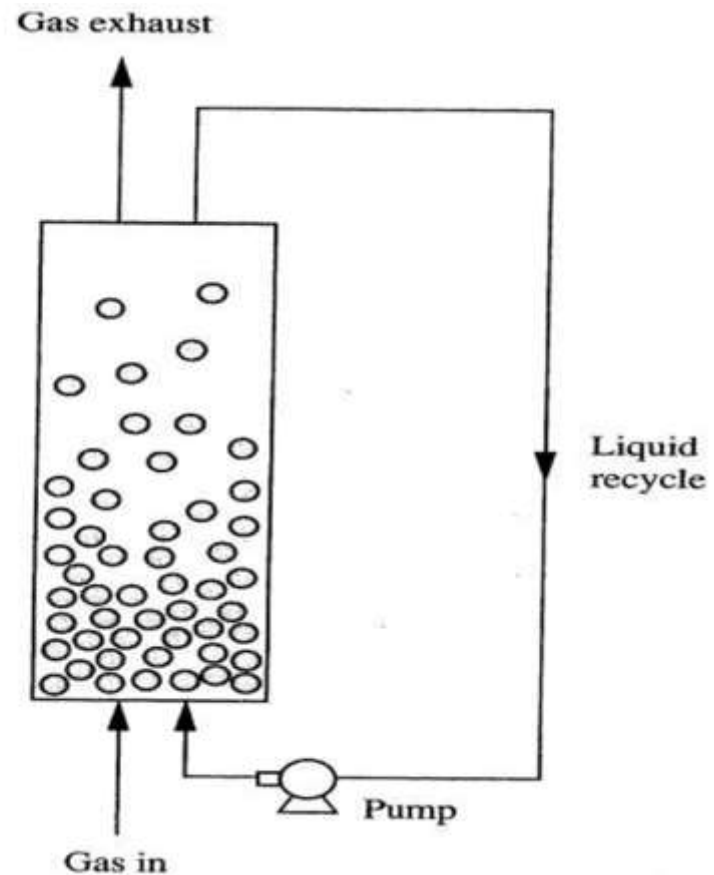

PACKED BED REACTOR

- Column with attached biofilm
- Biocatalysts
- Pump is required to make fluid move through the packed bed.
- Applications include waste water treatment

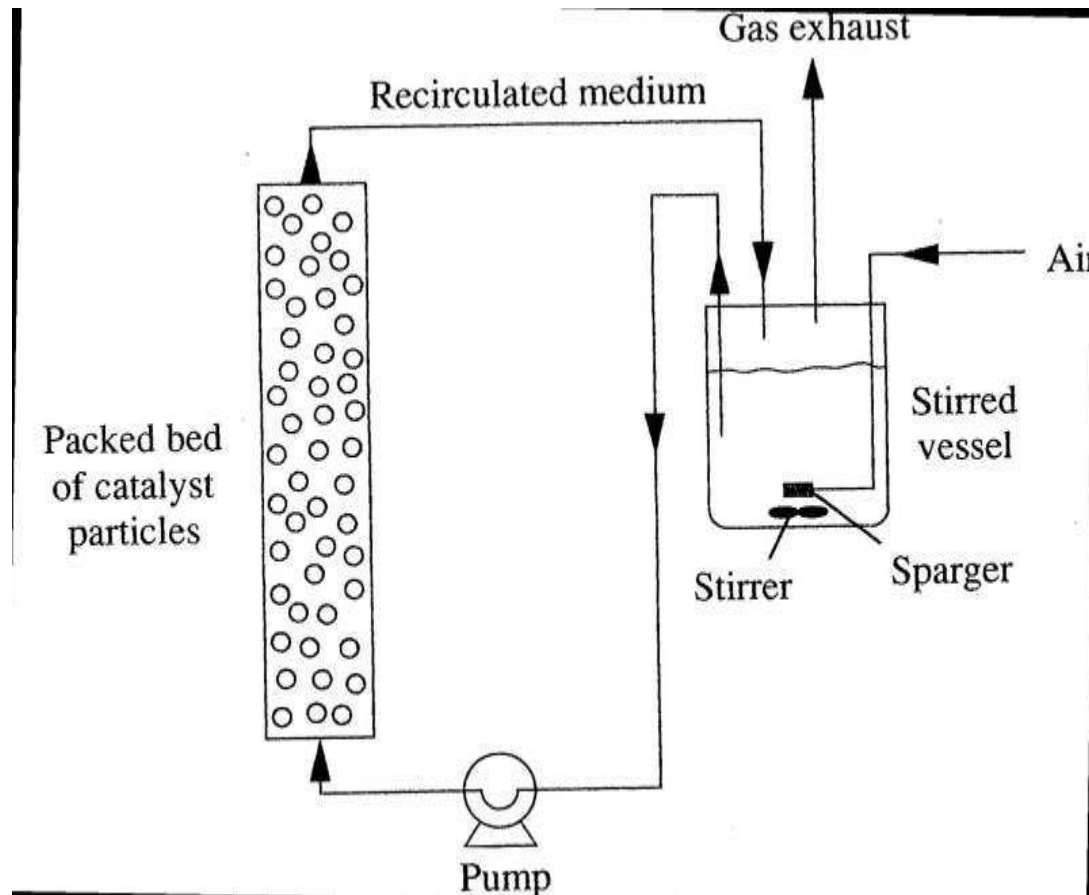

BUBBLE COLUMN REACTOR

Mixing method:

- Gas sparging
- Simple design
- Good heat and mass transfer rates
- Low energy input
- Gas-liquid mass transfer coefficients depend largely on bubble diameter and gas hold-up

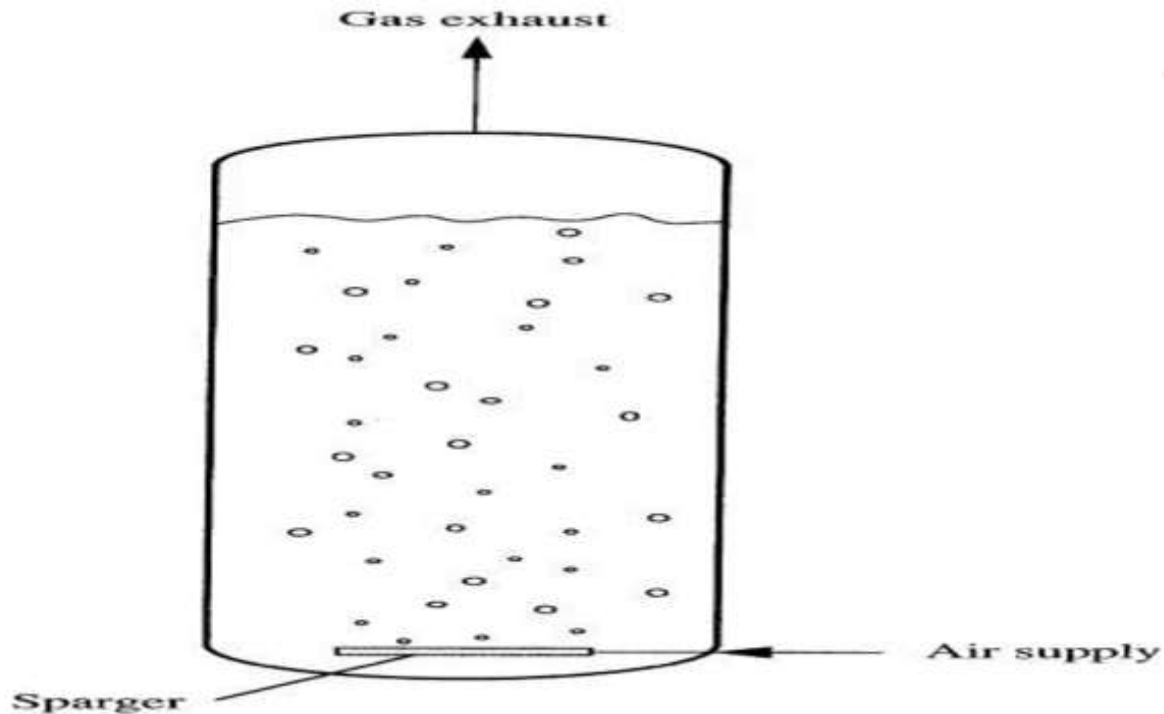

TRICKLE BED REACTORS

- Liquid is sprayed onto the top of the packing and trickles down through the bed in small rivulets.
- In the process, the gaseous pollutants on the surface of the carriers is adsorbed and immediately biologically mineralized (degraded) by the microorganisms

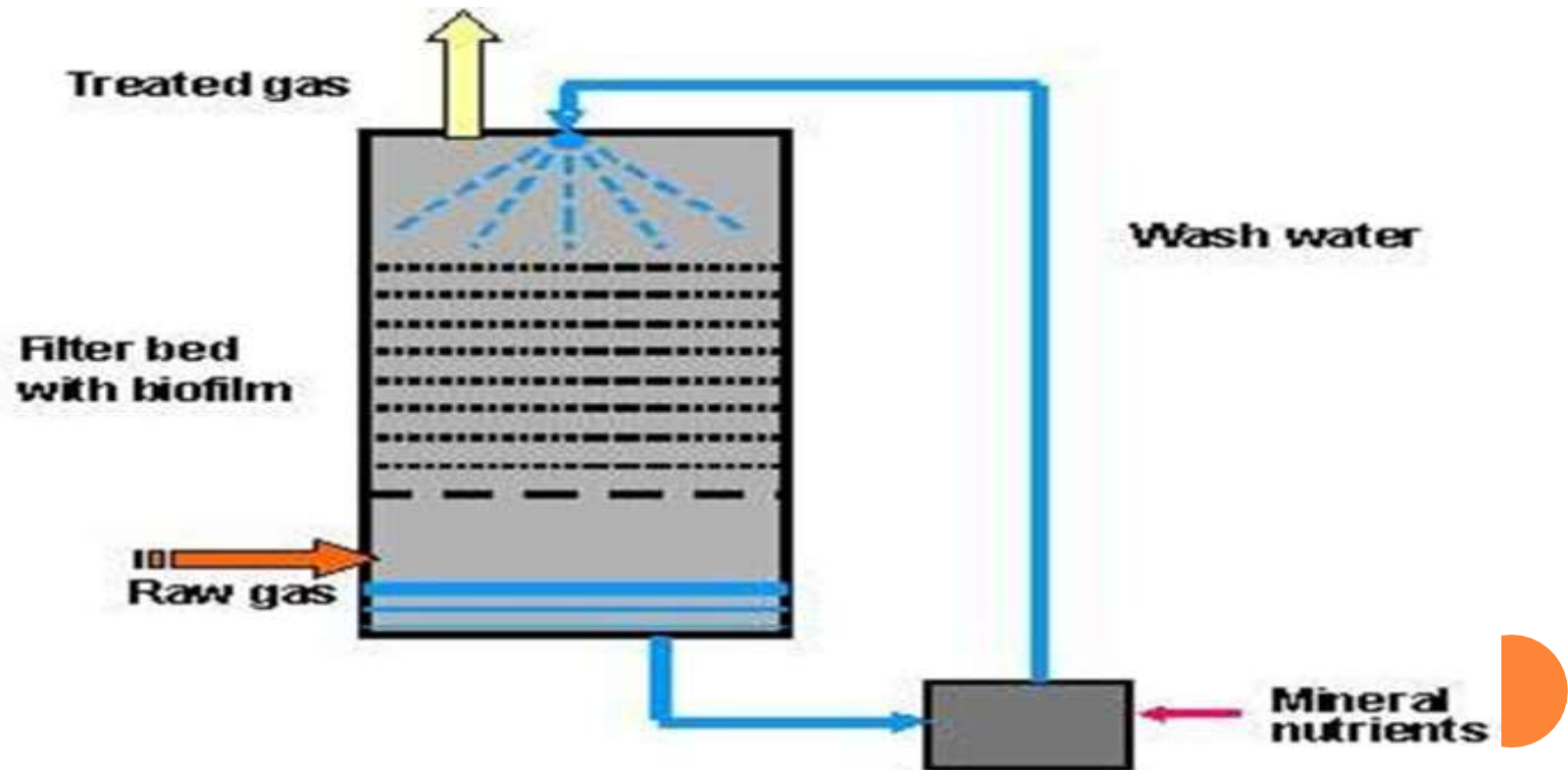

Thank

you.....

