

# WELCOME

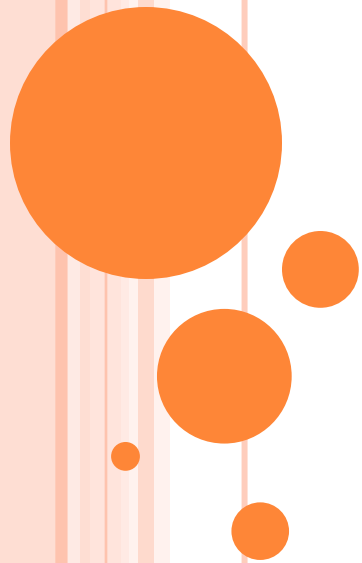

# **ELECTROPHORESIS**

## **TECHNIQUES**

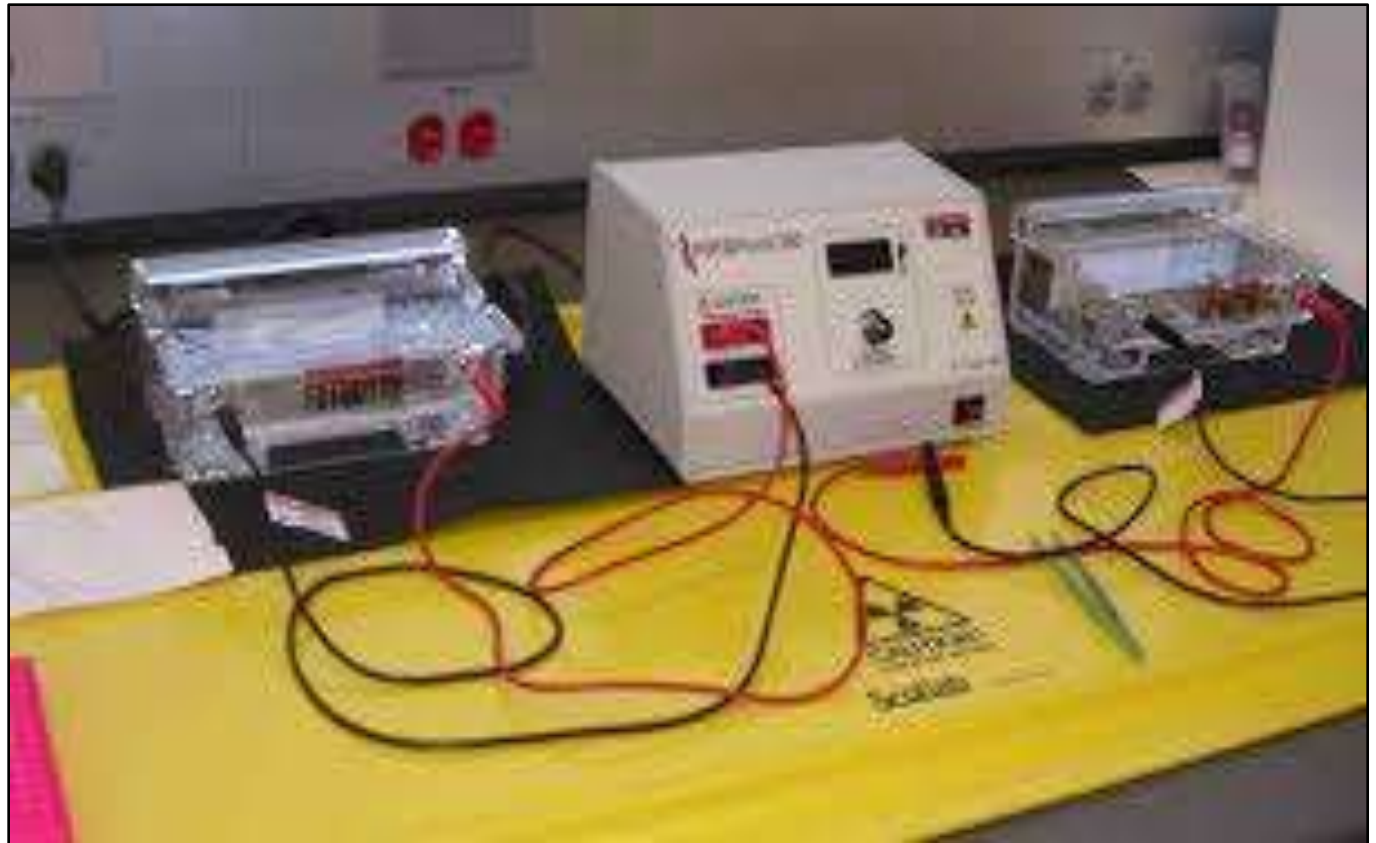

**PRESENTED BY:**

**MISS SAYANTI SAU**

**I M. PHARM**

**DEPT. OF PHARMACOLOGY**

**PESCP, BANGALORE**

**FACILITATED TO:**

**DR. NAGRAJ GOWDA**

**H.O.D.**

**DEPT. OF PHARMACEUTICAL ANALYSIS**

**PESCP, BANGALORE**

# THEORY OF ELECTROPHORESIS

## INTRODUCTION:

Electrophoresis is a physical method of analysis which involves separation of the compounds that are capable of acquiring electric charge in conducting electrodes.

## DEFINITION:

- **Electrophoresis may be defined as the migration of the charged particle through a solution under the influence of an external electrical field.**
- Ions that are suspended between two electrodes tends to travel towards the electrodes that bears opposite charges.

# TYPES OF ELECTROPHORESIS

## 1) Zone Electrophoresis

- a) Paper Electrophoresis
- b) Gel Electrophoresis
- c) Thin Layer Electrophoresis
- d) Cellulose acetate Electrophoresis

## 2) Moving Boundary Electrophoresis

- a) Capillary Electrophoresis
- b) Isotachopheresis
- c) Isoelectric Focussing
- d) Immuno Electrophoresis

# ZONE ELECTROPHORESIS

- It involves the migration of the charged particle on the supporting media.
- Paper, Cellulose acetate membrane, Starch Gel, Poly acrylamide.
- Components separated are distributed into discrete zone on the support media.
- Supporting media is saturated with buffer solution, small volume of the sample is applied as narrow band.
- On application of PD at the ends of a strip components migrates at a rate determined by its electrophoretic mobility.

## ADVANTAGES:

- Useful in biochemical investigations.
- Small quantity of sample can be analysed.
- Cost is low and easy maintenance.

## DISADVANTAGES:

- Unsuitable for accurate mobility and isoelectric point determination.
- Due to the presence of supporting medium, technical complications such as capillary flow, electro osmosis, adsorption and molecular sieving are introduced.

# GENERAL METHOD OF OPERATION

Saturation of the medium with the buffer.

↓  
Sample application.

↓  
Electrophoretic separation.

↓  
Removal of the supporting media.

## INSTRUMENTATION

- Electrophoretic chamber.
- Electrodes.
- Diffusion barriers.
- Supporting/ Stabilizing media.  
(inert to sample and to any developing reagents).

# PAPER ELECTROPHORESIS

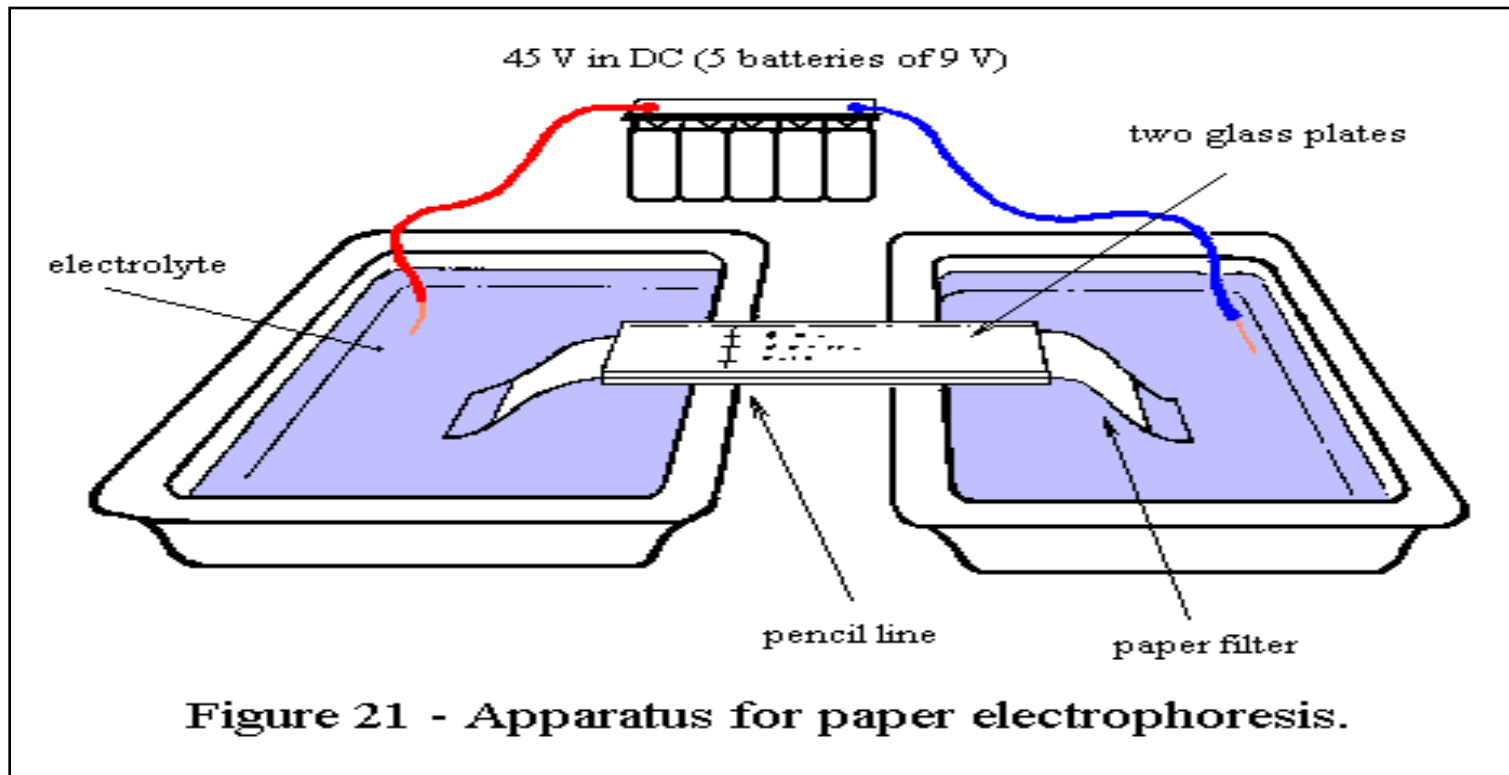

1. Horizontal paper Electrophoresis
2. Vertical paper Electrophoresis

# HORIZONTAL PAPER ELECTROPHORESIS

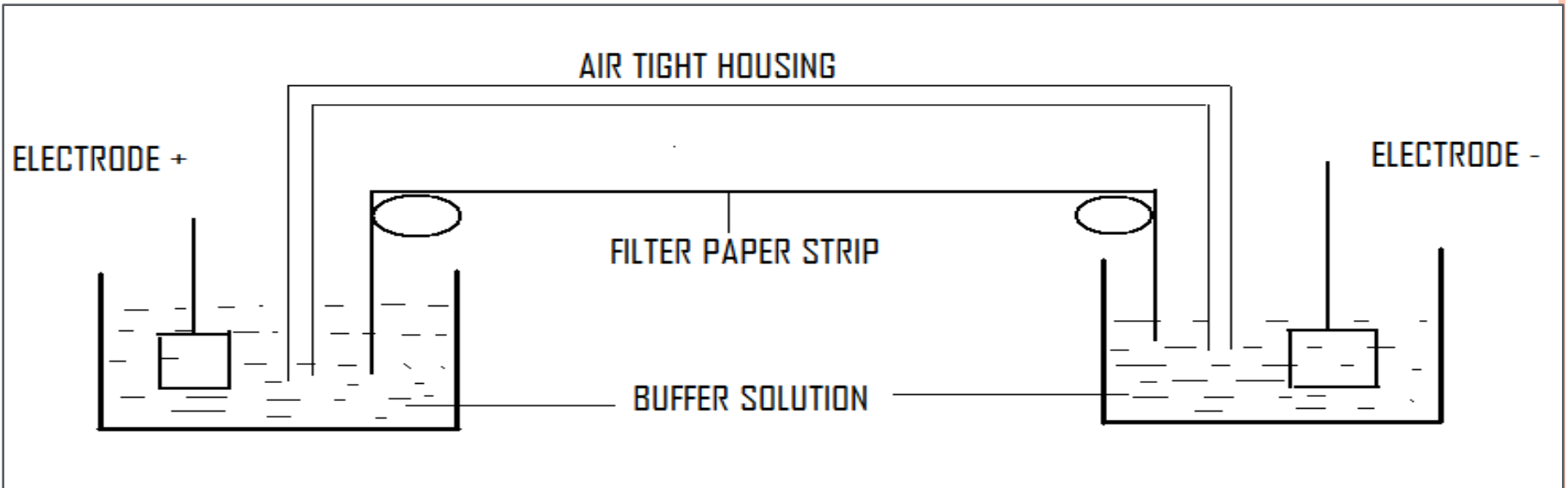

# VERTICAL PAPER ELECTROPHORESIS

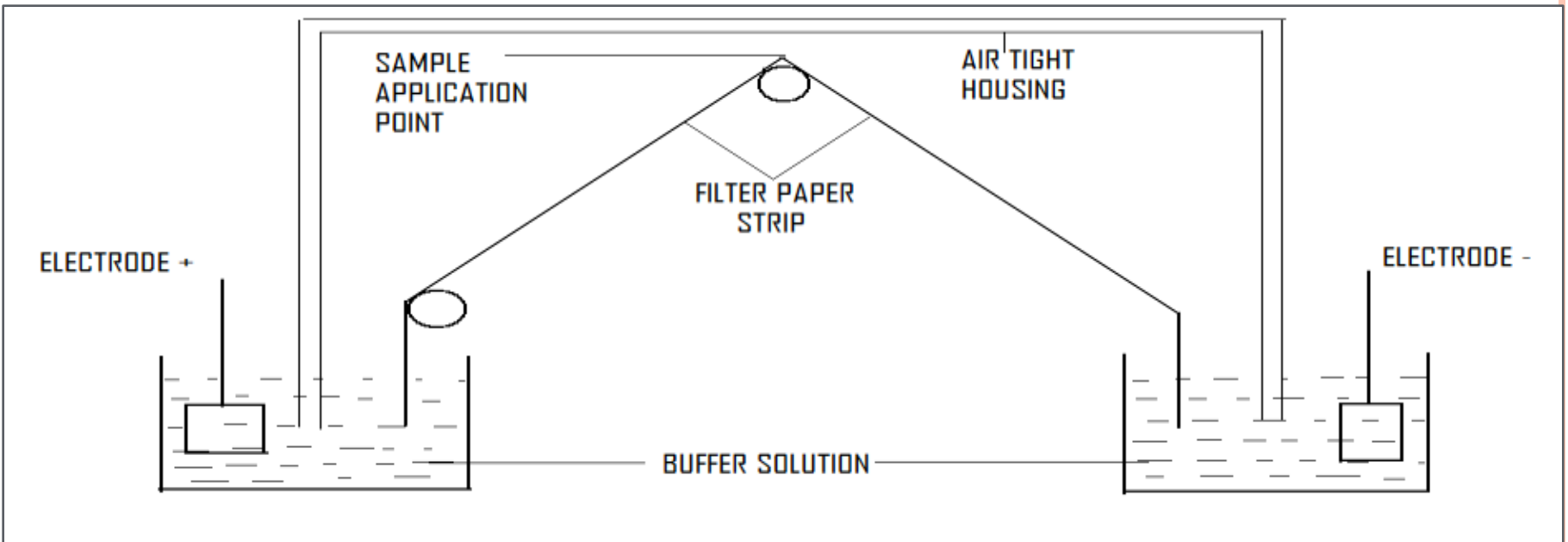



- Filter paper such as **Whatmann no1** and no 3mm in strip of 3 or 5cm wide have been used to good effect.
- Separation takes place in **12 to 14hrs.**

### **ADVANTAGES:**

- It is economical.
- Easy to use.

### **DISADVANTAGES:**

- Certain compounds such as proteins, hydrophilic molecules cannot be resolved due to the adsorptive and ionogenic properties of paper which results in tailing and distortion of component bands.
- Electro osmosis.

# CONTINUOUS ELECTROPHORESIS

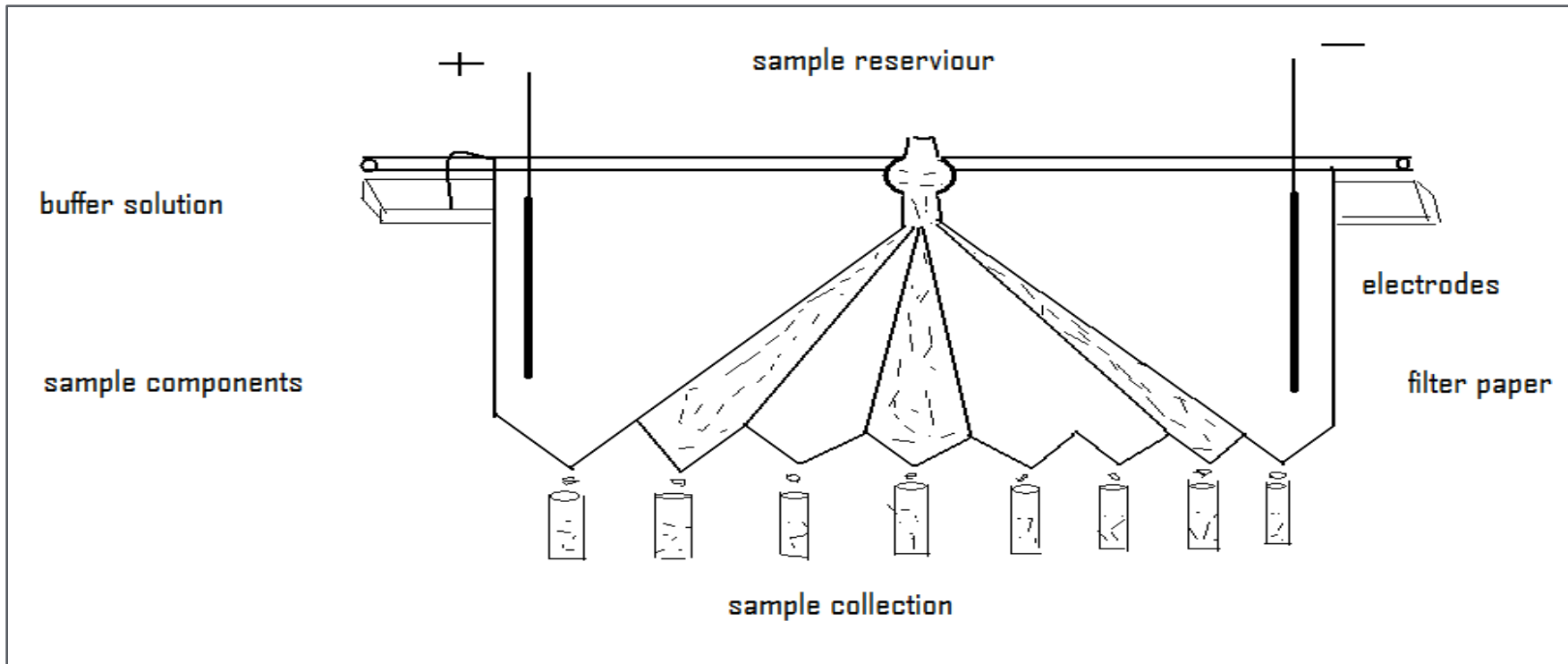

- Used for preparative scale purpose.
- Predetermined sample volume of 0.2 ml/min through the valve device is applied continuously on the centre of the paper.
- Silica gel, powdered glass, sand & agar gel can be used.
- A PD of 500V is applied.
- Pure compounds are collected in separate containers, the solvent is evaporated and pure fractions are reused.
- After complete electrophoresis the filter is removed from apparatus and stained to locate the separated components.

# GEL ELECTROPHORESIS

- Separation is brought about through molecular sieving technique, based on the molecular size of the substances. Gel material acts as a "molecular sieve".
- Gel is a colloid in a solid form (99% is water).
- **It is important that the support media is electrically neutral.**
- Different types of gels which can be used are; **Agar and Agarose gel, Starch, Sephadex, Polyacrylamide gels.**
- **A porous gel acts as a sieve by retarding or, in some cases, by completely obstructing the movement of macromolecules while allowing smaller molecules to migrate freely.**

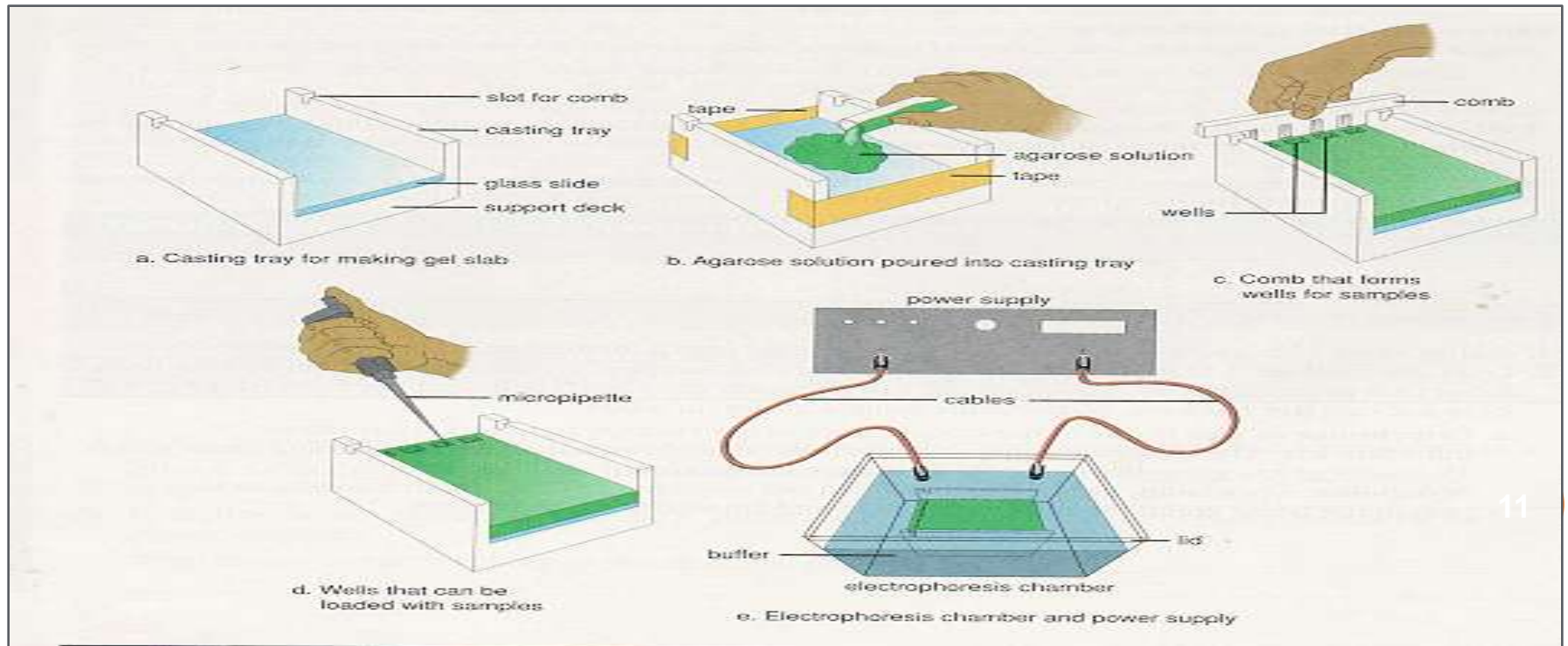

# GEL ELECTROPHORESIS

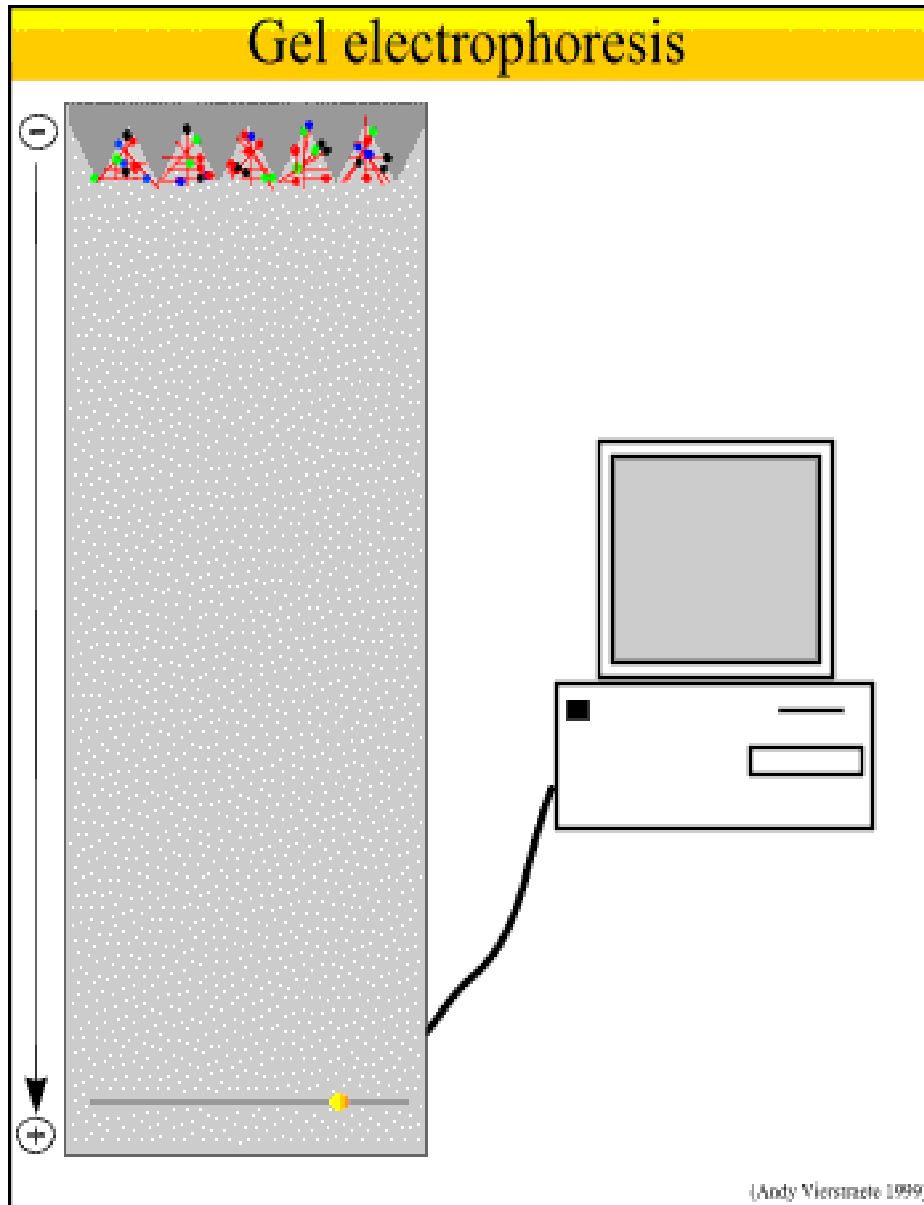

Gel Electrophoresis is carried out in **two** methods:

1. **Vertical** starch gel electrophoresis
2. **Horizontal** starch gel electrophoresis

# AGAR AND AGAROSE GEL

- **Agar is a mixture of poly saccharides extracted from sea weeds.**
- **Agarose is a highly purified uncharged polysaccharide derived from agar.**
- Agarose is **chemically basic disaccharide repeating units of 3,6-anhydro-L-galactose.**
- Agarose dissolves when added to boiling liquid. It remains in a liquid state until the temperature is lowered to about 40° C at which point it gels.
- The pore size may be predetermined by adjusting the concentration of agarose in the gel.
- **Agarose gels are fragile. They are actually hydrocolloids, and they are held together by the formation of weak hydrogen and hydrophobic bonds.**
- The pores of an agarose gel are large, agarose is used to separate macromolecules such as nucleic acids, large proteins and protein complexes.

## ADVANTAGES:

- Easy to prepare and small concentration of agar is required.
- Resolution is superior to that of filter paper.
- Large quantities of proteins can be separated and recovered.
- Adsorption of negatively charged protein molecule is negligible.
- It adsorbs proteins relatively less when compared to other medium.
- Sharp zones are obtained due to less adsorption.
- Recovery of protein is good, good method for preparative purpose.

## DISADVANTAGES:

- Electro osmosis is high.
- Resolution is less compared to polyacrylamide gels.
- Different sources and batches of agar tend to give different results and purification is often necessary.

## APPLICATION:

- Widely used in Immuno electrophoresis.

## GEL STRUCTURE OF AGAROSE:

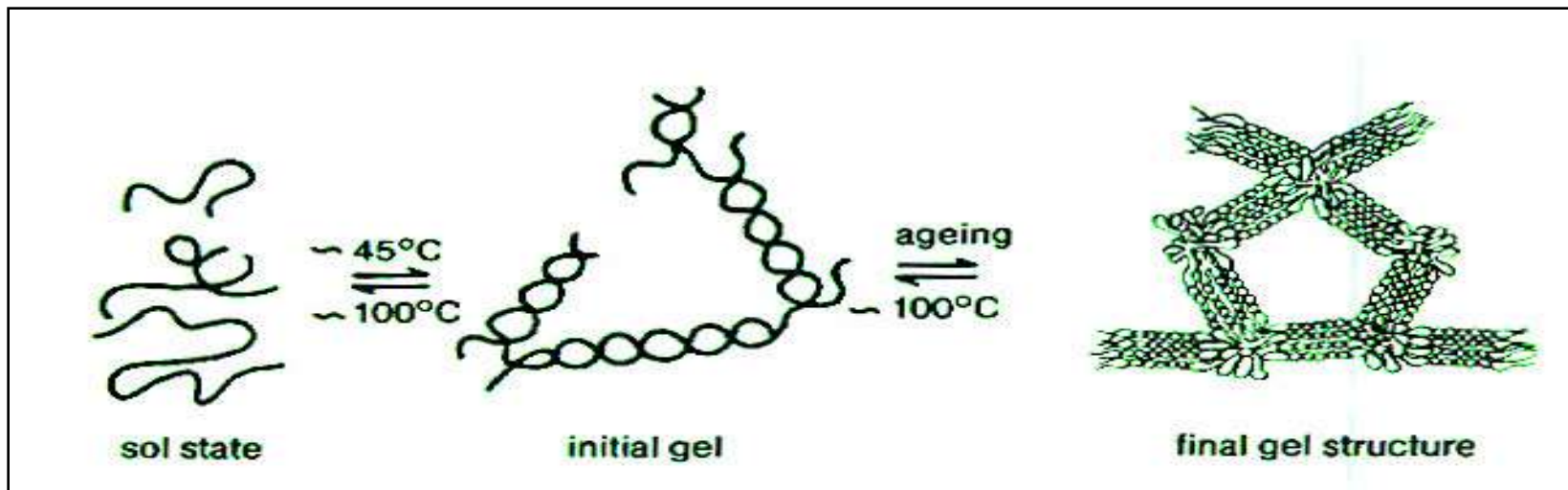

# POLYACRYLAMIDE GEL ELECTROPHORESIS (PAGE)

It is prepared by polymerizing acryl amide monomers in the presence of methylene-bis-acrylamide to cross link the monomers.

- Structure of acrylamide ( $\text{CH}_2=\text{CH}-\text{CO}-\text{NH}_2$ )
- **Polyacrylamide gel structure held together by covalent cross-links.**
- Polyacrylamide gels are tougher than agarose gels.
- It is thermostable, transparent, strong and relatively chemically inert.
- Gels are uncharged and are prepared in a variety of pore sizes.
- **Proteins are separated on the basis of charge to mass ratio and molecular size, a phenomenon called Molecular sieving.**

## ADVANTAGES:

- Gels are stable over wide range of pH and temperature.
- Gels of different pore size can be formed.
- Simple and separation speed is good comparatively.

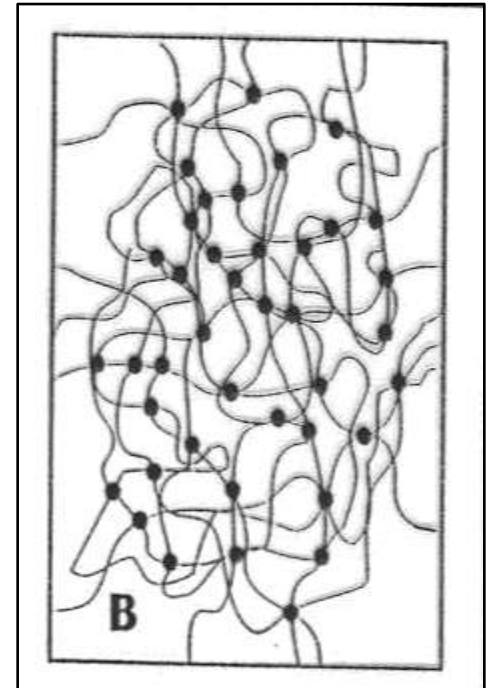
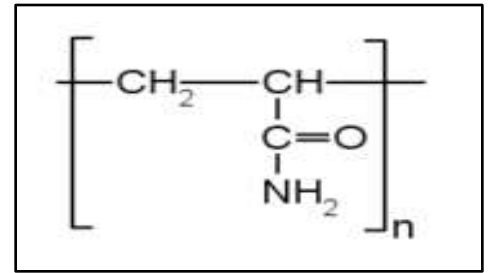

# TYPES OF PAGE

PAGE can be classified according the separation conditions into:

## ○ NATIVE-PAGE:

- Native gels are run in non-denaturing conditions, so that the analyte's natural structure is maintained.
- Separation is based upon **charge, size, and shape** of macromolecules.
- Useful for separation or purification of mixture of proteins.
- This was the original mode of electrophoresis.

## ○ DENATURED-PAGE OR SDS-PAGE:

- Separation is based upon the **molecular weight** of proteins.
- The common method for determining MW of proteins.
- Very useful for checking purity of protein samples.

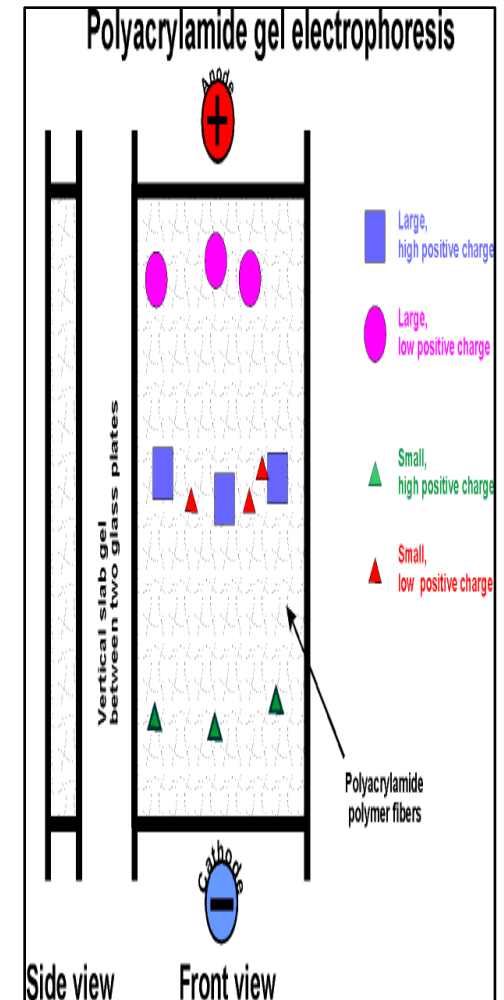



# PAGE-PROCEDURE

- The gel of different pore sizes is cast into a column inside a vertical tube, often with large pore gel at the top and small pore gel at the bottom.
- Microgram quantity of the sample is placed over the top of the gel column and covered by a buffer solution having such a pH so as to change sample components into anions.
- The foot of the gel column is made to dip in the same buffer in the bottom reservoir.
- Cathode and anode are kept above and below the column to impose an electric field through the column.
- Macromolecular anions move towards the anode down the gel column.
- There is no external solvent space, all the migratory particles have to pass through the gel pores.
- Rate of migration depends on the **charge to mass ratio**.
- Different sample components get separated into discrete migratory bands along the gel column on the basis of electrophoretic mobility and gel filtration effect.

# PAGE PROCEDURE

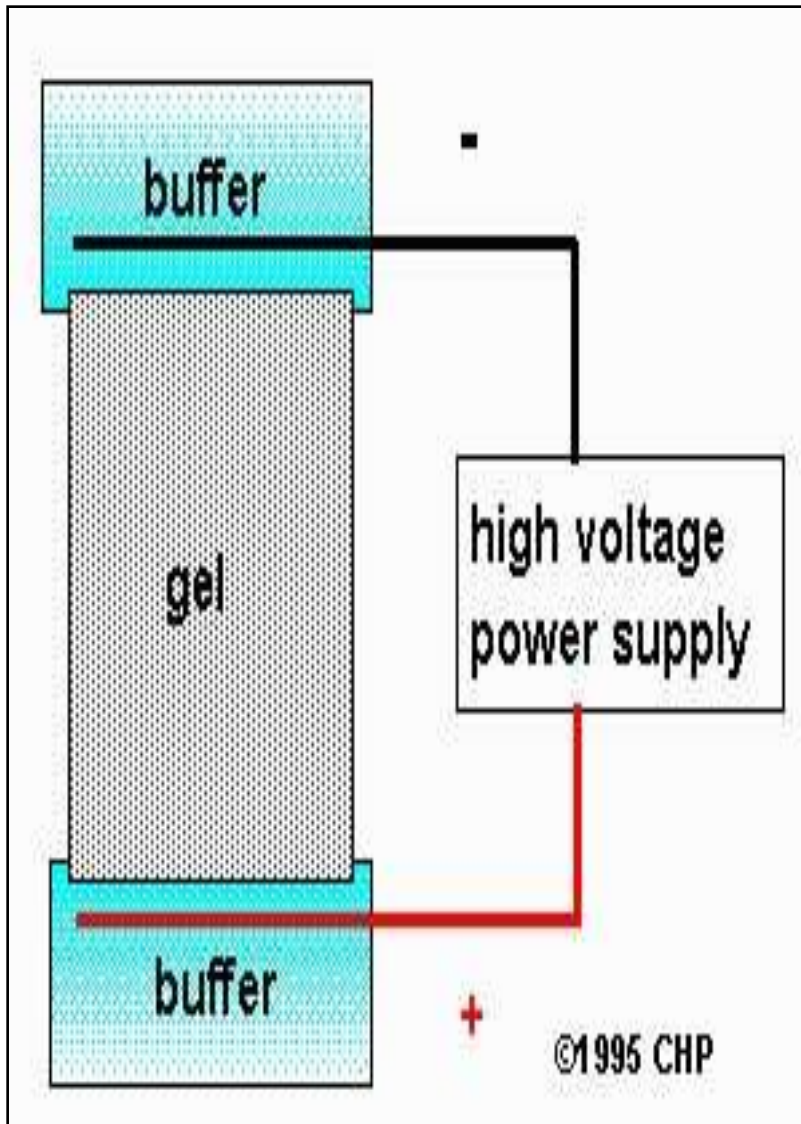

# SLAB PAGE

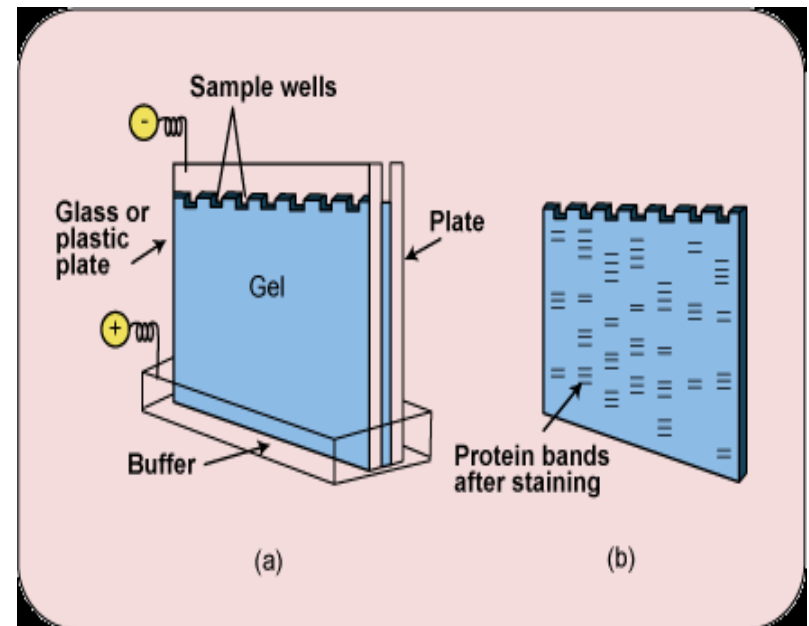

Polyacrylamide Gel Electrophoresis (PAGE)

a) The gel is poured vertically between two glass plates.

b.) Protein bands are separated on the basis of relative molecular weight and visualized with stains.

# SLAB PAGE

- The Polyacrylamide gel is cast as thin rectangular slab inside a plastic frame and this slab is placed vertically on a buffer solution taken in a reservoir.
- Several samples dissolved in dense sucrose solution or glycerol are placed in separate wells cut in to the upper edge of the slab and are covered by the same buffer solution. Cathode and anode are above and below to produce electric field effect. Different components migrate simultaneously down parallel lanes in the slab and get separated into bands.

## VISUALIZATION

- After the electrophoresis is complete, the molecules in the gel can be stained to make them visible.
- **Ethidium bromide, silver, or coomassie blue dye** may be used for this process.
- If the analyte molecules fluoresce under **ultraviolet light**, a photograph can be taken of the gel under ultraviolet lighting conditions. If the molecules to be separated contain radioactivity added for visibility, an **autoradiogram** can be recorded of the gel.

# SDS-POLYACRYLAMIDE GEL ELECTROPHORESIS (SDS-PAGE)

- **SDS-PAGE**, sodium dodecyl sulfate polyacrylamide gel electrophoresis, is a technique widely used in biochemistry, forensics, genetics and molecular biology to separate proteins according to their **electrophoretic mobility**.
- When a detergent SDS added to PAGE the combined procedure is termed as SDS PAGE.
- **SDS coats protein molecules giving all proteins a constant charge-mass ratio.**
- **Due to masking of charges of proteins by the large negative charge on SDS binding with them, the proteins migrate along the gel in order of increasing sizes or molecular weights.**
- SDS is an anionic detergent which denatures secondary and non-disulfide-linked tertiary structures by wrapping around the polypeptide backbone. In so doing, SDS confers a net negative charge to the polypeptide in proportion to its length.
- Molecules in solution with SDS have a net negative charge within a wide pH range.
- A polypeptide chain binds amounts of SDS in proportion to its relative molecular mass
- The negative charges on SDS destroy most of the complex structure of proteins, and are strongly attracted toward an anode in an electric field.

# SODIUM DODECYL SULFATE (SDS-PAGE)

- Native protein is unfolded by heating in the presence of  $\beta$ -mercaptoethanol and SDS.
- SDS binds to the protein so that it stays in solution and denatures.
- Large polypeptides bind more SDS than small polypeptides, so proteins end up with negative charge in relation to their size.
- When treated with SDS and a reducing agent, the polypeptides become rods of negative charges with equal "charge densities" or charge per unit length.
- Thus, we can separate the proteins based on their mass.

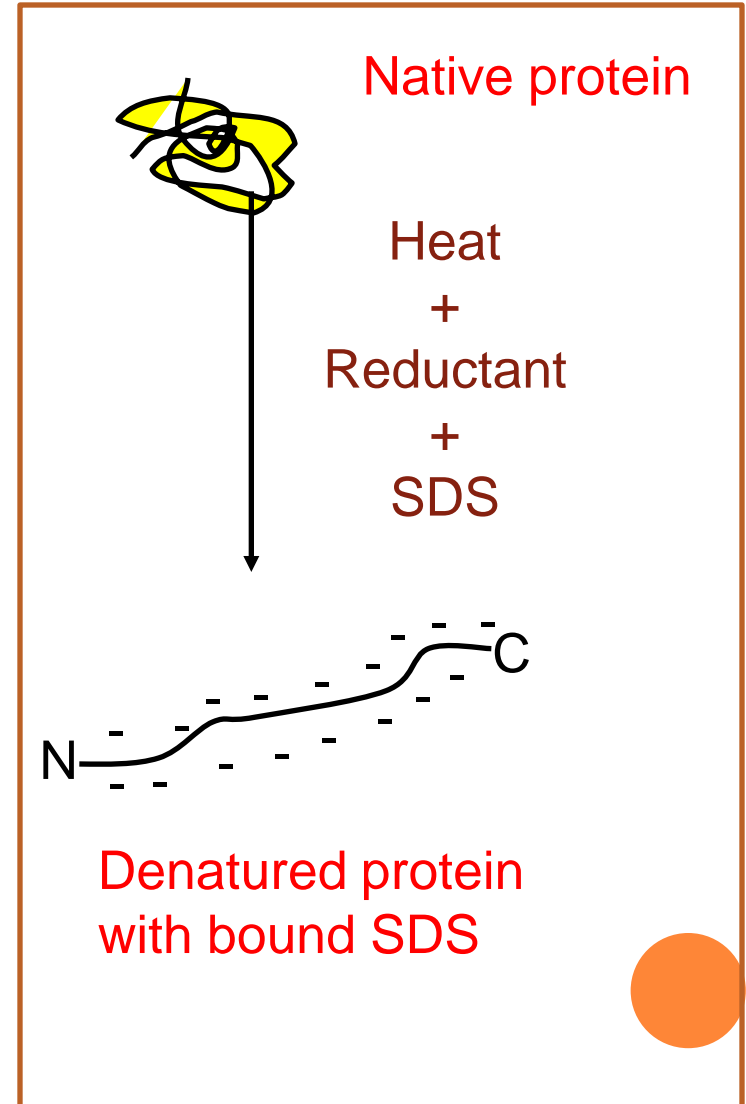

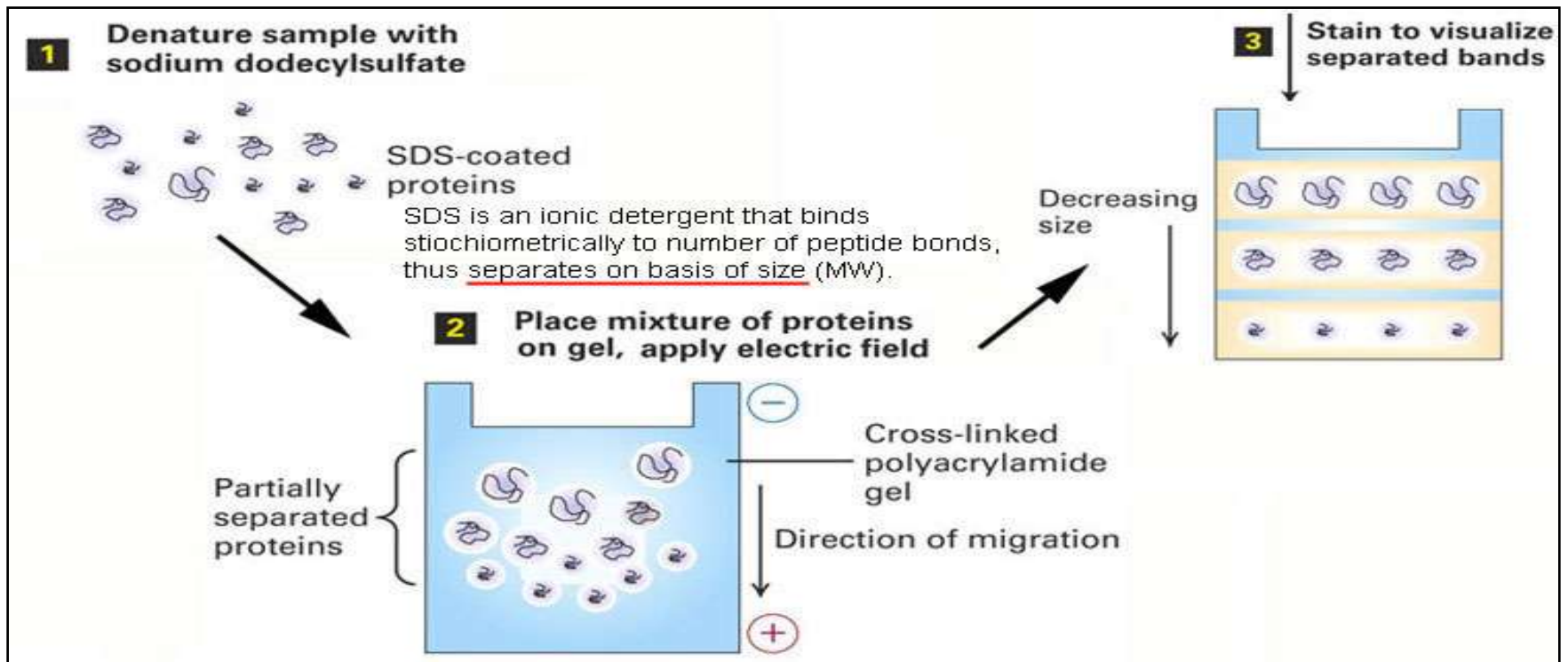

- Also called laurylsulfate
- A common ingredient of shampoos
- Forms micelles in water



Micelles are three-dimensional, *i.e.* roughly spherical.

- Most proteins bind SDS at a constant ratio:  $\approx 1.4$  g SDS per g protein.
- Complexes are rod shaped.
- Polypeptides form  $\alpha$ -helical structures in SDS.
- A possible structure of SDS-protein complexes:

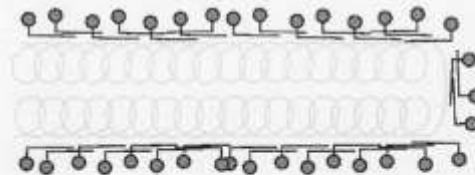

# STARCH

- A suspension of granular starch should be boiled in a buffer to give a clear colloidal suspension.
- The suspension on cooling sets as a semisolid gel due to intertwining of the branched chains of amylopectin.
- In order to avoid swelling and shrinking petroleum jelly is used.

## ADVANTAGES:

- High resolving power and sharp zones are obtained.
- The components resolved can be recovered in reasonable yield especially proteins.
- Can be used for analytical as well as preparative electrophoresis.

## DISADVANTAGES:

- Electro osmotic effect.
- Variation in pore size from batch to batch.

# VERTICAL AND HORIZONTAL GEL ELECTROPHORESIS

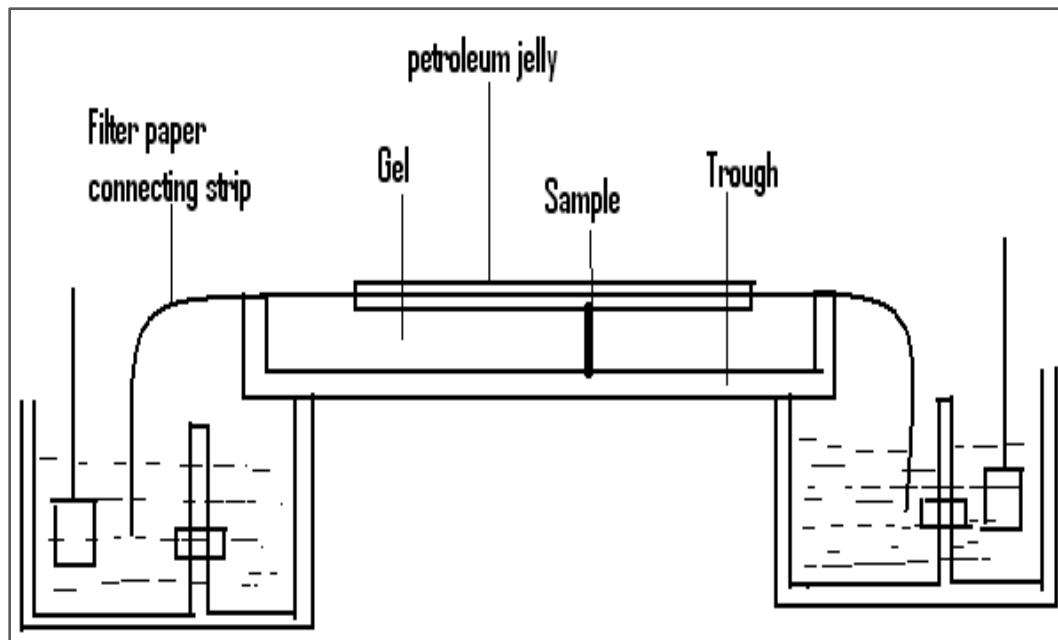
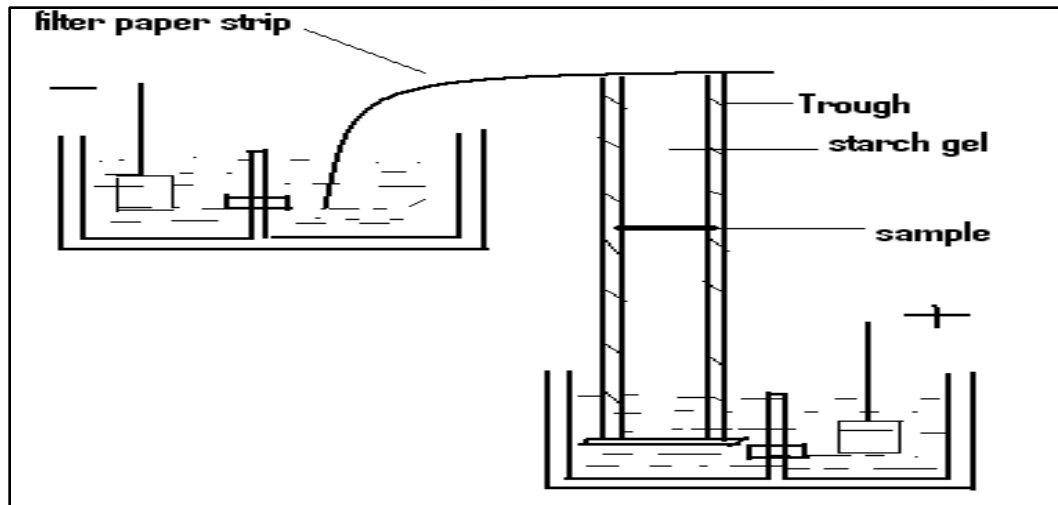

## Methods for application of sample:

- Sample is mixed with the gel.
- By soaking a bit of filter paper in sample and pressing it into the gel.
- Detection by staining or by Direct gravimetry or by UV absorption, etc.



# PULSED-FIELD GEL ELECTROPHORESIS

- Pulsed field gel electrophoresis is a technique used for the separation of large DNA molecules by applying to a gel matrix an electric field that periodically changes direction.
- While in general small fragments can find their way through the gel matrix more easily than large DNA fragments, a threshold length exists above 30–50 kb where all large fragments will run at the same rate, and appear in a gel as a single large diffuse band. **However, with periodic changing of field direction, the various lengths of DNA react to the change at differing rates.** Over the course of time with the consistent changing of directions, each band will begin to separate more and more even at very large lengths. Thus separation of very large DNA pieces using PFGE is made possible.
- **The voltage is periodically switched among three directions; one that runs through the central axis of the gel and two that run at an angle of 60 degrees either side. The pulse times are equal for each direction resulting in a net forward migration of the DNA.**
- This procedure takes longer than normal gel electrophoresis due to the size of the fragments being resolved and the fact that the DNA does not move in a straight line through the gel.

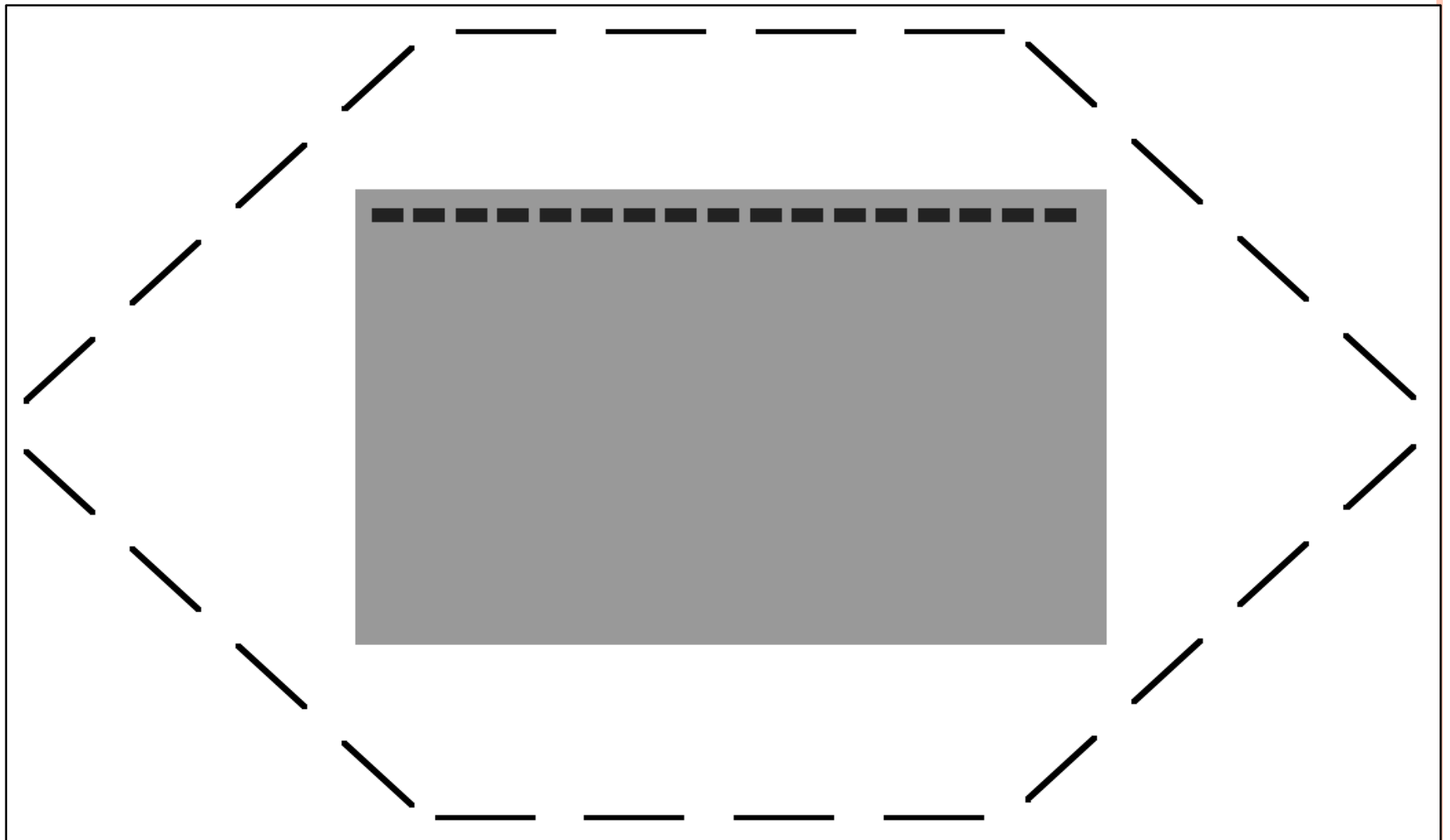

## APPLICATIONS:

PFGE may be used for genotyping or genetic fingerprinting . It is commonly considered a gold standard in epidemiological studies of pathogenic organisms.

# THIN LAYER ELECTROPHORESIS

- Studies can be carried out in thin layer of silica, keisulguhr, alumina.

## ADVANTAGES:

- Less time consuming and good resolution.

## APPLICATION:

- Widely used in combined electrophoretic-chromatography studies in two dimensional study of proteins and nucleic acid hydrolysates.

# CELLULOSE ACETATE ELECTROPHORESIS

- It contains 2-3 acetyl groups per glucose unit and its adsorption capacity is less than that of paper.
- It gives sharper bands.
- Provides a good background for staining glycoproteins.

## ADVANTAGE:

- No tailing of proteins or hydrophilic materials.
- Available in wide range of particle size and layer thickness.
- Give sharp bands and offer good resolution.
- High voltage can be applied which will enhance the resolution.

## DISADVANTAGE:

- Expensive.
- Presence of sulphonic and carboxylic residue causes induced electroosmosis during electrophoresis.

## APPLICATION:

- Widely used in analysis of clinical and biological protein samples (albumin and globulins).
- Alternative to paper electrophoresis.

# MOVING BOUNDARY ELECTROPHORESIS

## PRINCIPLE:

The moving boundary method allows the charged species to migrate in a free moving solution without the supporting medium.

## INSTRUMENTATION:

- Consists of a U shaped glass cell of rectangular cross section, with electrodes placed on the one each of the limbs of the cell.
- Sample solution is introduced at the bottom or through the side arm, and the apparatus is placed in a constant temp. bath at 40° C.
- Detection is done by measuring refractive index throughout the solution.(Schlieren optical system).

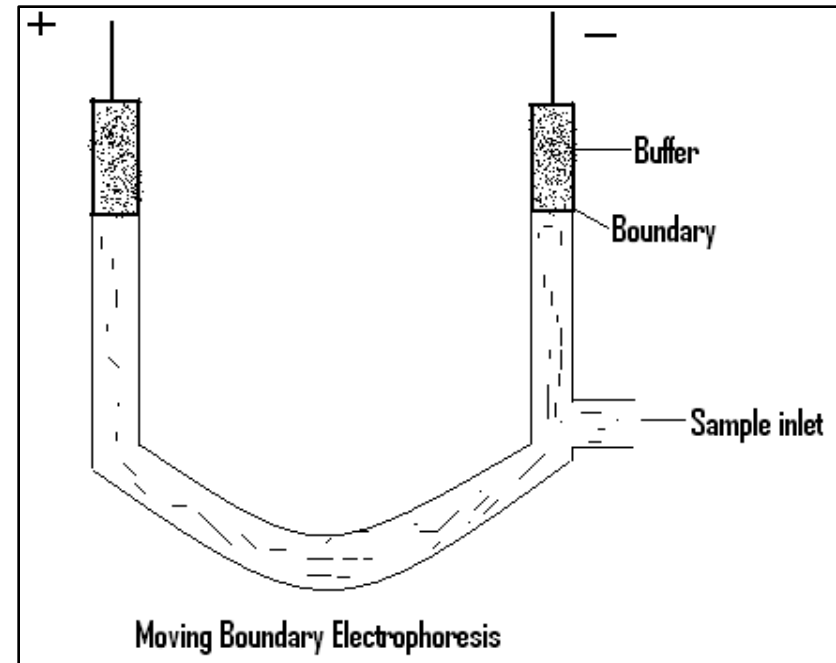
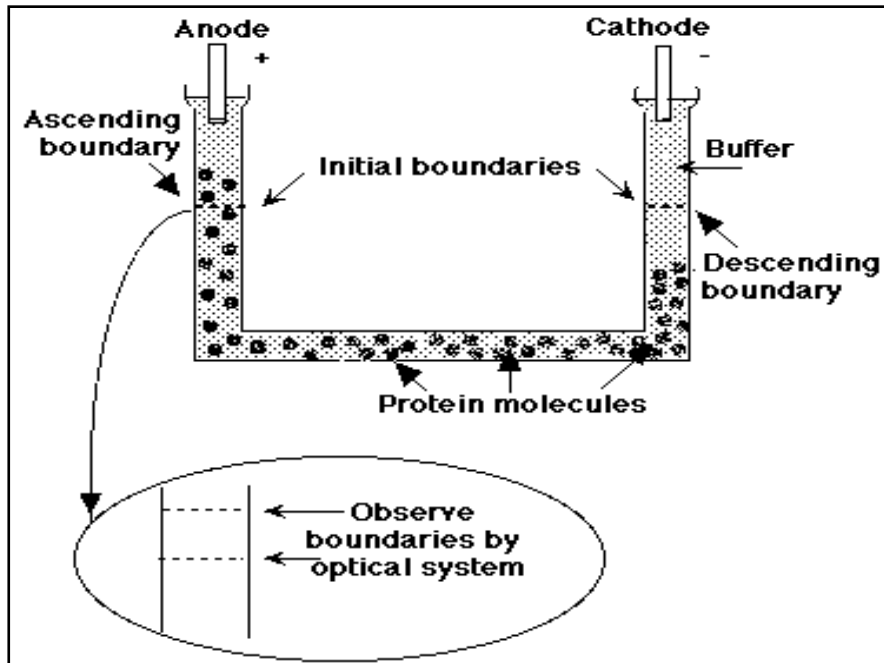

## **ADVANTAGES:**

- Biologically active fractions can be recovered without the use of denaturing agents.
- A reference method for measuring electrophoretic mobilities.
- Minute concentrations of the sample can be detected.(0.05mg/ml by Interferometric optical system).

## **DISADVANTAGES:**

- Costlier.
- Elaborate optical system are required.

## **APPLICATION:**

- To study homogeneity of a macromolecular system.
- Analysis of complex biological mixtures.

# CAPILLARY ELECTROPHORESIS

- The principle behind electrophoresis is that charged molecules will migrate toward the opposite pole and separate from each other based on **physical characteristics**.
- Capillary electrophoresis has grown to become a collection of a range of separation techniques which involve the application of high voltages across buffer filled capillaries to achieve separations .
- **Capillary electrophoresis, then, is the technique of performing electrophoresis in buffer-filled, narrow-bore capillaries**, normally from 25 to 100  $\mu\text{m}$  in internal diameter (ID).
- A high voltage (typically 10-30 kV) is applied.
- Capillaries are typically of 50  $\mu\text{m}$  inner diameter and 0.5 to 1 m in length.
- Due to electroosmotic flow, all sample components migrate towards the negative electrode.
- The capillary can also be filled with a gel, which eliminates the electroosmotic flow. Separation is accomplished as in conventional gel electrophoresis but the capillary allows higher resolution, greater sensitivity, and on-line detection.
- The capillary is filled with electrolyte solution which conducts current through the inside of the capillary. The ends of the capillary are dipped into reservoirs filled with the electrolyte.
- Electrodes (platinum) are inserted into the electrolyte reservoirs to complete the electrical circuit.

# Capillary Electrophoresis

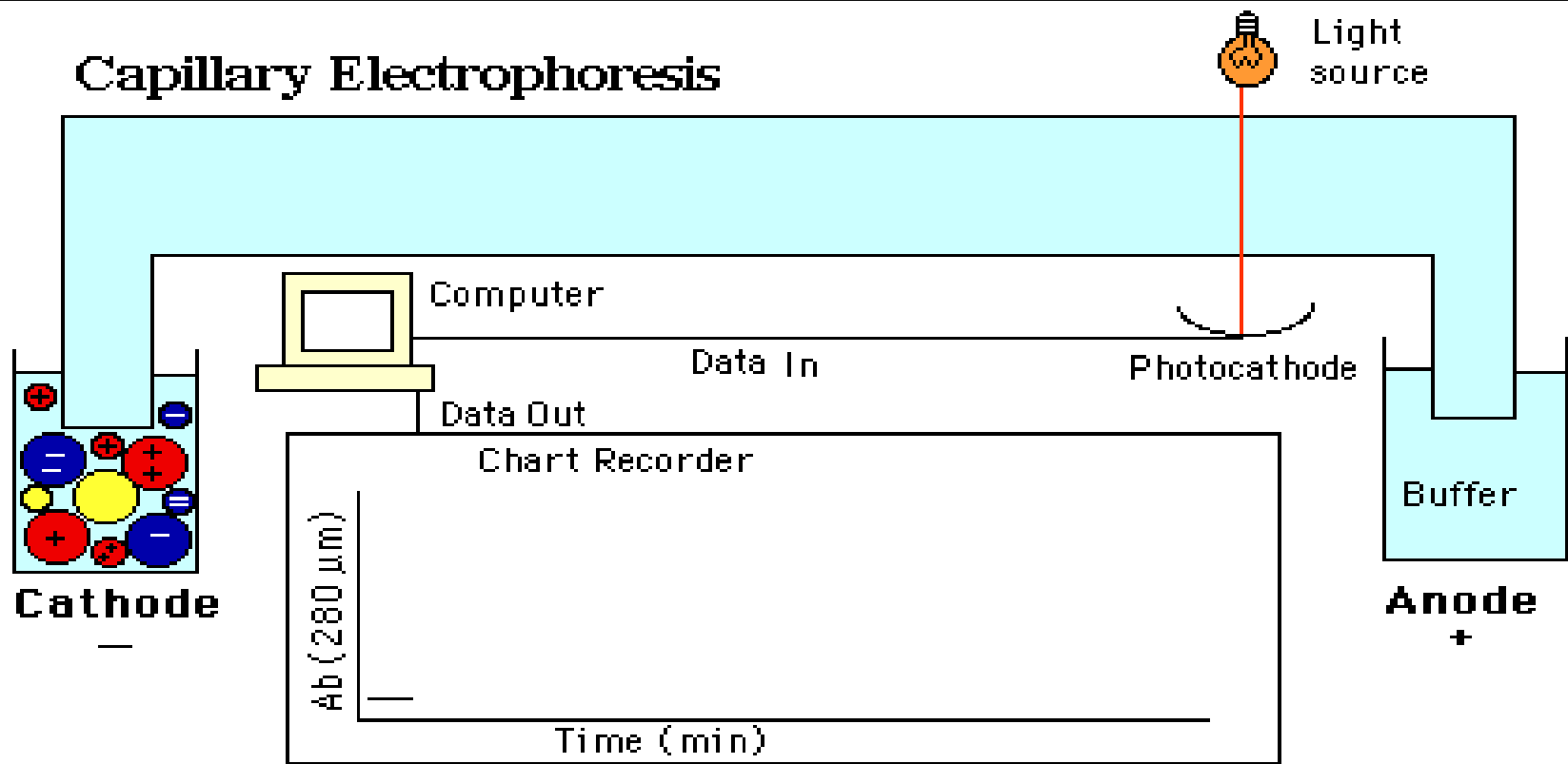

Sample application is done by either

**a) High voltage injection**-potential is applied causing the sample to enter capillary by combination of ionic attraction and electroosmotic flow.

**b) Pressure injection**-pressure difference is used to drive the sample into capillary by applying vacuum.

- When PD is applied net migration occurs in the direction of cathode.
- Even substance with net negative charge migrate in the direction of cathode due to the phenomenon called as Electro Osmotic Flow.
- Neutral molecule moves at the same speed as the EOF. Positively charged species move faster, speed is sum of EOF and Electrophoretic mobility. Negatively charged molecules lag behind.



# ELECTROOSMOTIC FLOW

The surface of the silicate glass capillary contains negatively-charged functional groups that attract positively-charged counterions. The positively-charged ions migrate towards the negative electrode and carry solvent molecules in the same direction. This overall solvent movement is called electroosmotic flow. During a separation, uncharged molecules move at the same velocity as the electroosmotic flow (with very little separation). Positively-charged ions move faster and negatively-charged ions move slower.

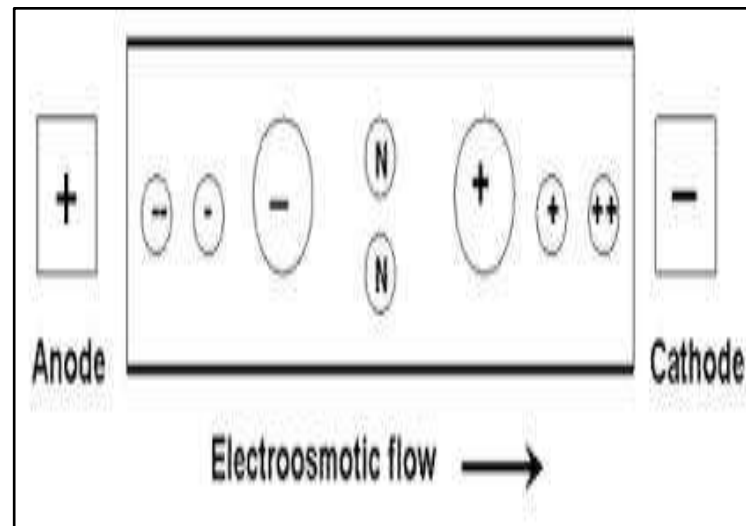
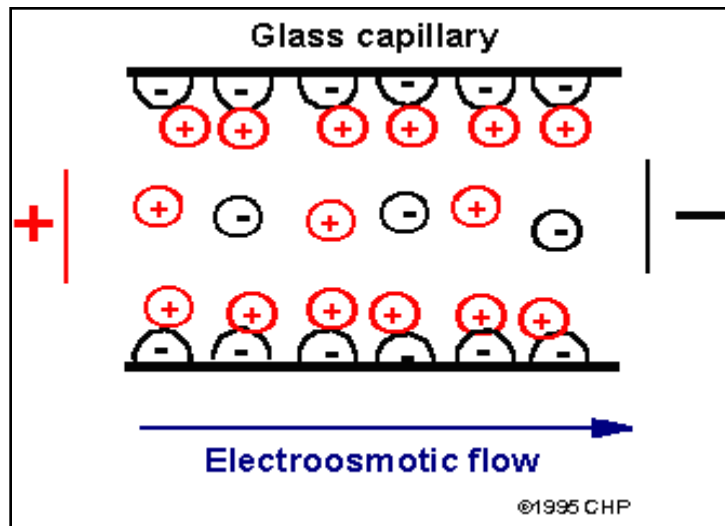

- A small volume of sample is moved into one end of the capillary. The capillary passes through a detector, usually a UV absorbance detector, at the opposite end of the capillary.
- Application of a voltage causes movement of sample ions towards their appropriate electrode usually passing through the detector.
- A plot of detector response with time is generated which is termed an electropherogram.

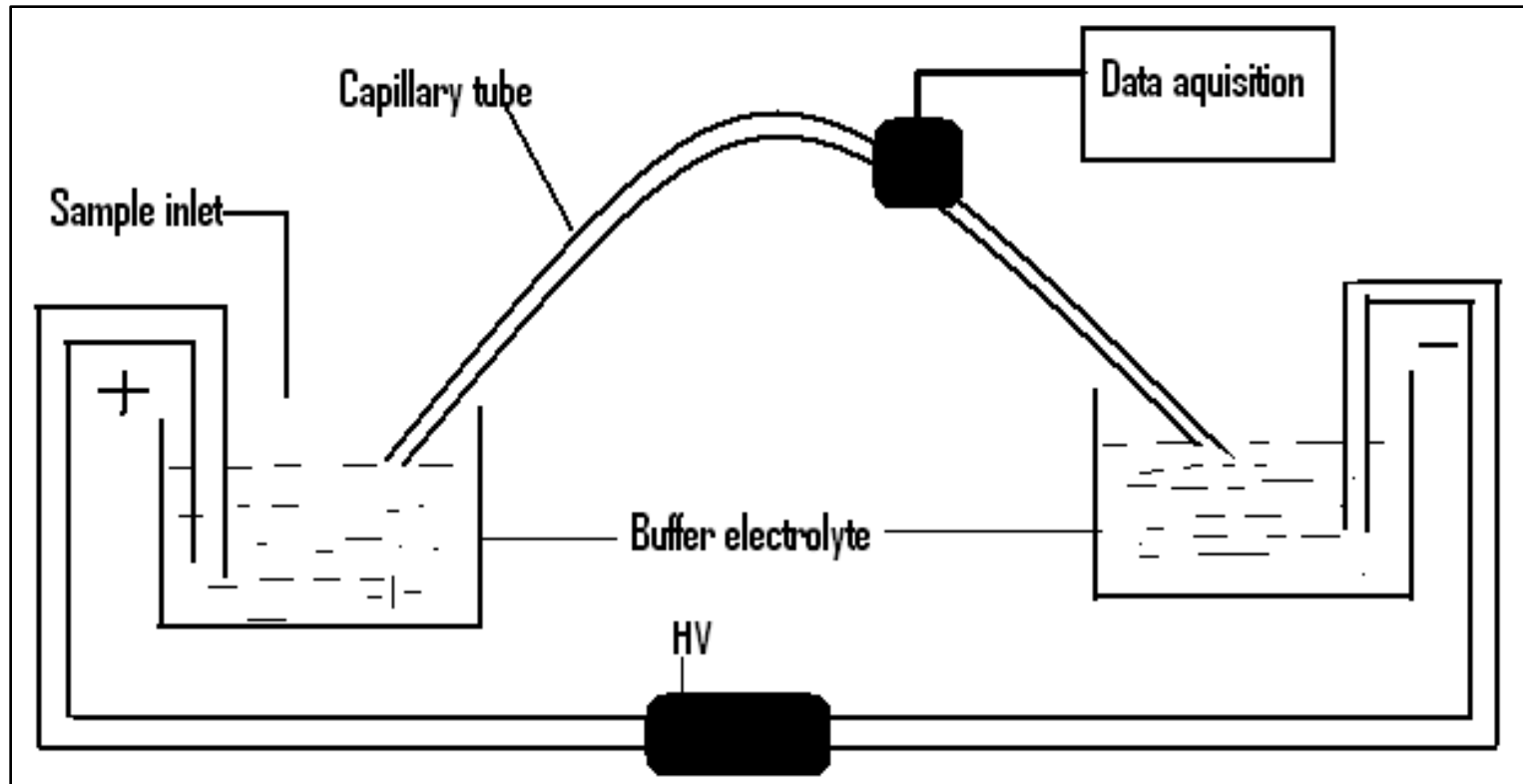

# ISOTACHOPHORESIS

The technique of isotachophoresis depends on the **development of potential gradient**.

## PRINCIPLE:

- Based on principle of moving boundary electrophoresis.
- A **leading electrolyte**(e.g. chloride) with a higher mobility than the analytes, and a **trailing electrolyte**(e.g. glycinate) with a lower mobility are used.
- Solution in which the separation takes place is normally an aqueous medium, which contains sucrose to provide a higher density to the solution.
- **Where the separation by Isoelectric focusing depends on the existence of a pH gradient in the system. The technique of Isotachophoresis depends on the development of a potential gradient.**
- Separation of the ionic components of the sample is achieved through stacking them into discrete zones in order of their mobilities, producing very high resolution.



In the example shown here three particle classes with different charges are being separated and preconcentrated via electrophoresis. After the separation is concluded all particles move at a constant speed (Isotachophoresis)

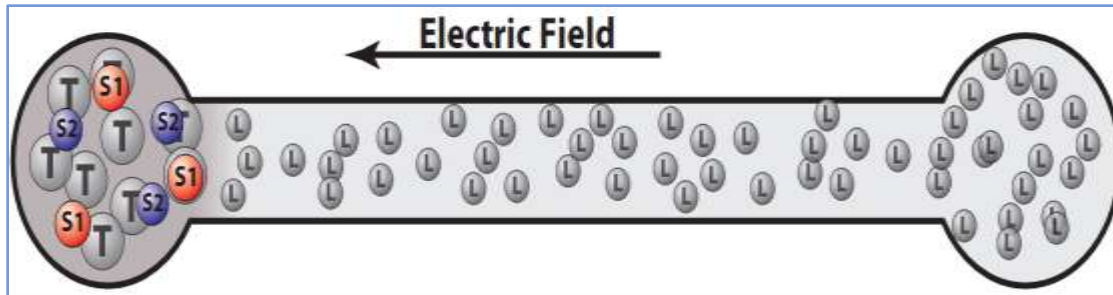

We fill one well with slow trailing electrolyte (T) mixed with samples (S1,S2), and the other well with fast leading electrolyte (L). When we apply an electric field, ions electromigrate through a microchannel according to their electrophoretic mobilities.

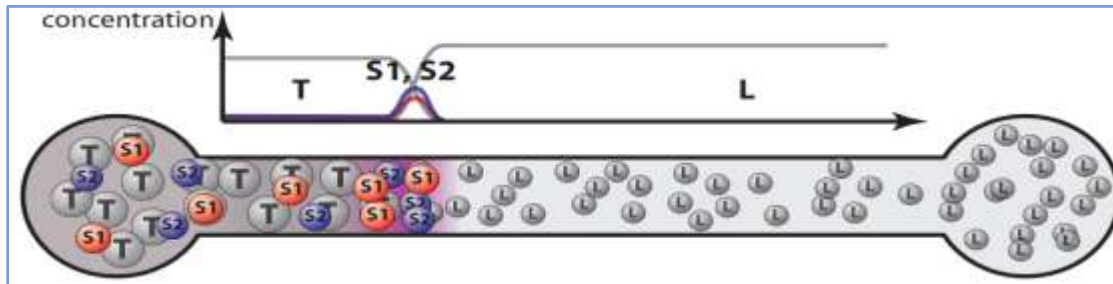

Sample ions overspeed the slow trailing electrolyte, but cannot overspeed the fast leading electrolyte ; consequently, they focus at the interface.

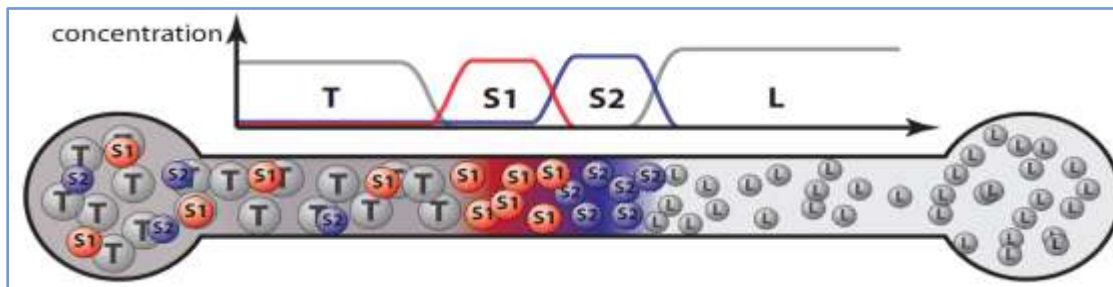

Sample continues to accumulate. If sample concentration approaches the concentration of the leading electrolyte, samples self-segregate into discrete zones.

- The analytes are positioned between the electrolytes and, when the voltage is applied, they migrate in order of decreasing mobility.
- This establishes the potential gradient; from that point on, all the analytes move at the same speed.
- Individual zones border one another but represent completely separated components with out overlap.
- In isotachopheresis no background electrolyte(buffer) is mixed with the sample, so current flow is carried only by charged sample ions.
- **Once a faster moving component separates completely from a slower moving one, It creates a region of depleted charge between the two that increases the resistance and therefore local voltage in that region.**
- **This increased voltage causes the slower component to migrate faster and close the gap, thereby concentrating it and increasing the conductivity of its zone until it matches that of the faster ion.**
- Ultimately all ions migration at the rate of the faster ion in the zones that differ in thickness, depending on their original concentrations.

## **APPLICATION:**

- Isotachopheresis that been used for the separation of proteins as well as inorganic substances.

# IMMUNO ELECTROPHORESIS

- Antibodies are produced by immune system in response to foreign macromolecules. Each antibody binds specifically to one feature(epitope) on one macromolecule(antigen).This allows the use of antibodies for detection and quantitation of specific proteins in a complex mixture.
- When Electrical potential is applied to study of antigen-antibody reactions, it is called Immunoelectrophoresis. The antibody are electrophoretically separated and antigens diffuse towards each other resulting in precipitin arcs where antigen antibody complexes form. This technique has been referred to as immunoelectrophoresis.**
- Antibody is placed in trough cut parallel to the direction of the electrophoresis.
- Run the electrophoresis as a result precipitin arcs will be formed due to Ab-Ag complex formation.**
- A fluid containing proteins antigens is placed in a well in a thick layer of buffered agar and an electric current is applied, antigens will be distributed in separate spots along a line passing through the well and parallel to the direction of current flow.

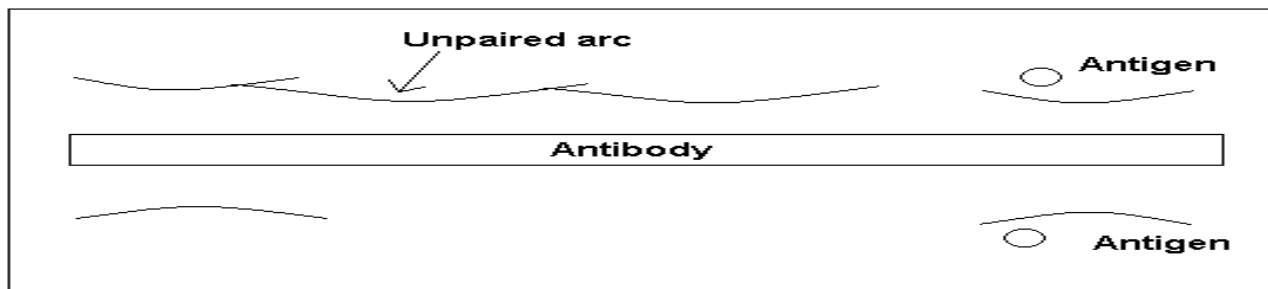

# METHOD

- It is usually carried out in 2% agar gel medium.
- The antigen mixture is applied into a small circular wells cut out of agar and the initial electrophoretic separation is carried out depending on their charge and molecular weight.
- After the initial separation; the antibody mixture is then introduced into a narrow slot in the gel about 0.5 to 1.0 cm from the separated antigens.
- During this period, the antigen components diffuse radially outwards, towards the diffusing antibody and precipitation takes place in elliptical arcs as related antigens and antibodies diffuse into one another.

## ADVANTAGES:

- Spreading of bands is minimized due to the application of the applied field and the pH gradient, high resolution can be achieved.

## DISADVANTAGES:

- Carrier ampholytes generally are used in relatively high concentration, a high voltage power source (up to 2000V) is necessary and power is in the vicinity of 2 to 50 W. As a result the electrophoretic matrix must be cooled.

## APPLICATION:

- Mainly used for separating protein and peptides.
- Used in clinical, forensic and human genetics laboratories for the separation and identification of serum protein in research in enzymology, membrane biochemistry, microbiology and immunology.

# ISOELECTRIC FOCUSING

## PRINCIPLE:

- **All proteins have an isoelectric point pH .**
- When electrophoresis is run in a solution buffered at constant pH , proteins having a net charge will migrate towards the opposite electrode so long as the current flows.
- The use of pH gradient across the supporting medium causes each protein to migrate to an area of specific pH. The pH of the protein equals the pH of the gradient, thus resulting in sharp well defined protein bands.
- **A procedure to determine the isoelectric point (PI) of proteins thus, a mixture of proteins can be electrophorised through a solution having a stable pH gradient in from the anode to the cathode and a each protein will migrate to the position in the pH gradient according to its isoelectric point. This is called isoelectric focusing.**
- **Protein migrate into the point where its net charge is zero – isoelectric pH.**
- Protein is positively charged in solutions at pH below its PI and will migrate towards the cathode.
- Protein is negatively charged in solution at pH above its PI will migrate towards the anode.
- They will be in the Zwitter ion form with no net charge so the further movement will cease.
- **Ampholytes** (amphoteric electrolytes)- low molecular mass (600-900D) oligomers with aliphatic amino and carboxylic acid groups with a range of isoelectric points. Ampholytes help maintain the pH gradient in the presence of high voltage.
- Can also use gels with immobilized pH gradients - made of acrylamide derivatives that are covalently linked to ampholytes.



# METHOD

- pH gradient is established in gel by addition of ampholytes which increases the pH from anode to cathode.
- A protein mixture is placed in a well on the gel.
- With an applied electric field, proteins enter the gel migrate until each reaches its pH equivalent to its (PI).
- Each species of proteins is thereby focussed into a narrow band about its PI.
- **The Anode of the column is connected to a reservoir containing an acidic solution like phosphoric acid and Cathode is connected to a reservoir containing alkaline solution like sodium hydroxide.**
- **On opening the two reservoir valves the two solutions are allowed to diffuse into the column from their respective ends , setting up a PH gradient between the acidic anode and the alkaline cathode.**
- The valves are then closed and the current is switched on , causing the carrier ampholytes to migrate until they reach the PH regions where they have no net charge. They will then remain stationary at these points.

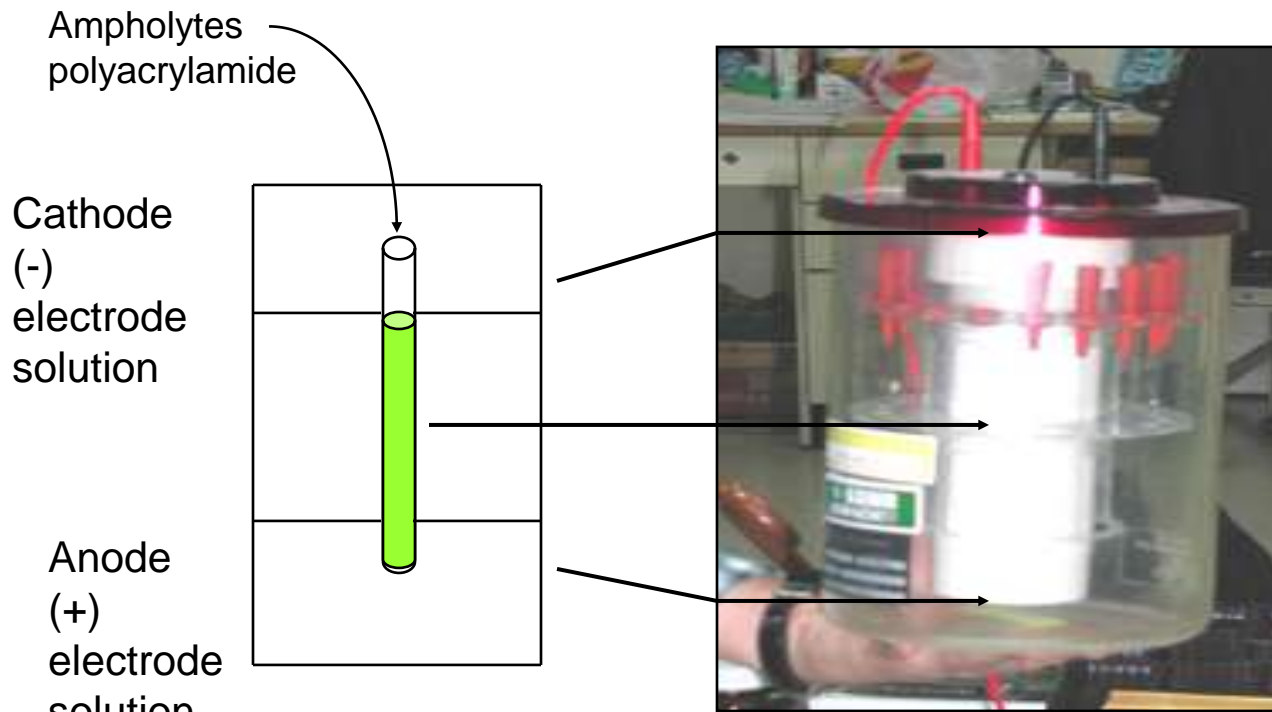

# Stable pH gradient

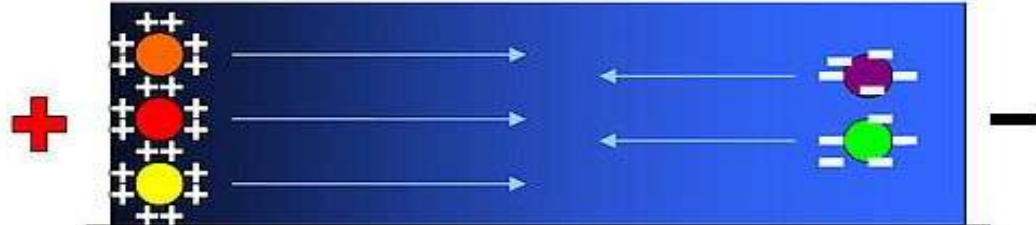

At low pH, most proteins have a positive charge while at high pH, most proteins have a negative charge.

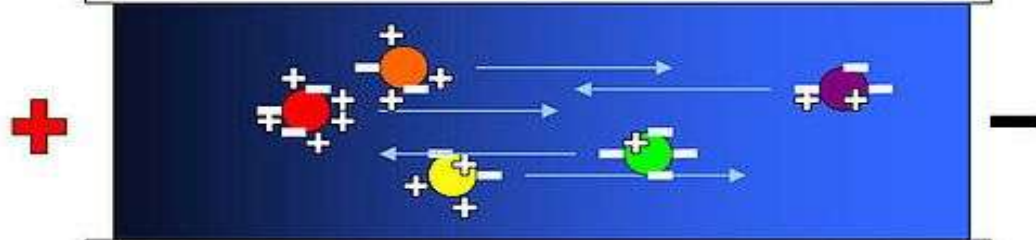

When an electric field is present, the cathode and anode ends pull the proteins to their isoelectric point where each individual protein possesses a neutral charge.



The proteins stopped migrating because they've reached their isoelectric point at a unique pH level.

Sample applied at pH region below isoelectric points

Sample components migrate as cations

Sample components are focused at their isoelectric points

Sample components migrate as anions

Sample applied at pH region above isoelectric points

Anode

$A^+$   $B^+$   $C^+$

$A^+$

$B^+$

$C^+$

$A^-$

$B^-$

$C^-$

$A^-$   $B^-$   $C^-$

Cathode

Lower pH

Increasing pH

Higher pH

## **ADVANTAGES:**

- 1) As spreading of bands is minimized due to application of the applied field and the PH gradient , high resolution can be achieved.
- 2) Proteins that differ by as little as 0.001 PH units can be separated.

## **DISADVANTAGES:**

- 1) Because carrier ampholytes are generally used in high concentration, a high voltage (upto 2000v ) is necessary . As a result the electrophoretic matrix must be cooled which sometimes makes it difficult.

## **APPLICATIONS:**

- 1) For separating proteins and peptides.
- 2) For research in enzymology , immunology, cytology and taxonomy.

# TWO-DIMENSIONAL GEL ELECTROPHORESIS (2-D ELECTROPHORESIS)

- In the first dimension, proteins are resolved according to their **isoelectric points (PI)** using **immobilized pH gradient electrophoresis (IPGE)**, **isoelectric focusing (IEF)**, or **non-equilibrium pH gradient electrophoresis**. (**Horizontal separation**)
- In the second dimension, proteins are separated according to their approximate **molecular weight** using **SDS-PAGE**. (**Vertical separation**).

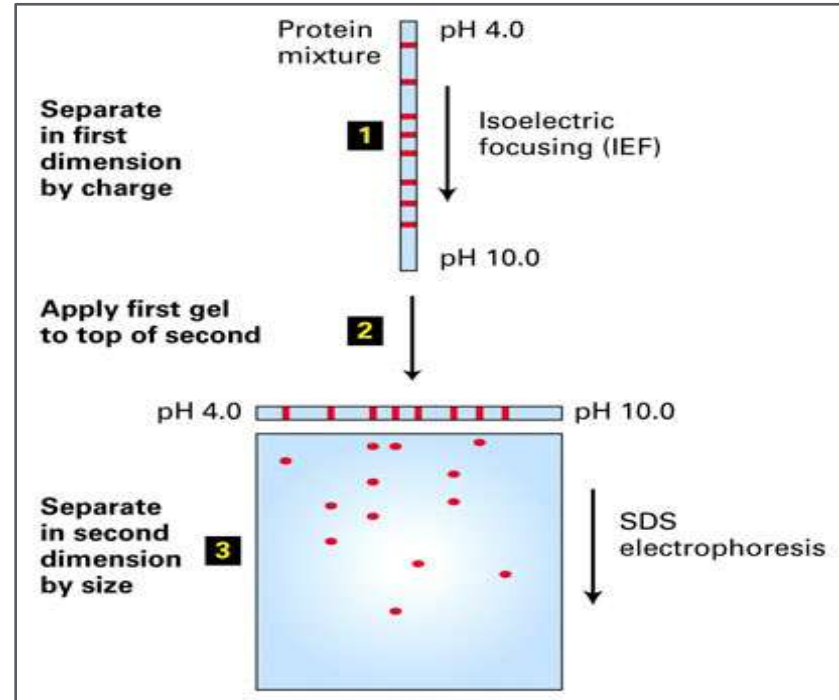
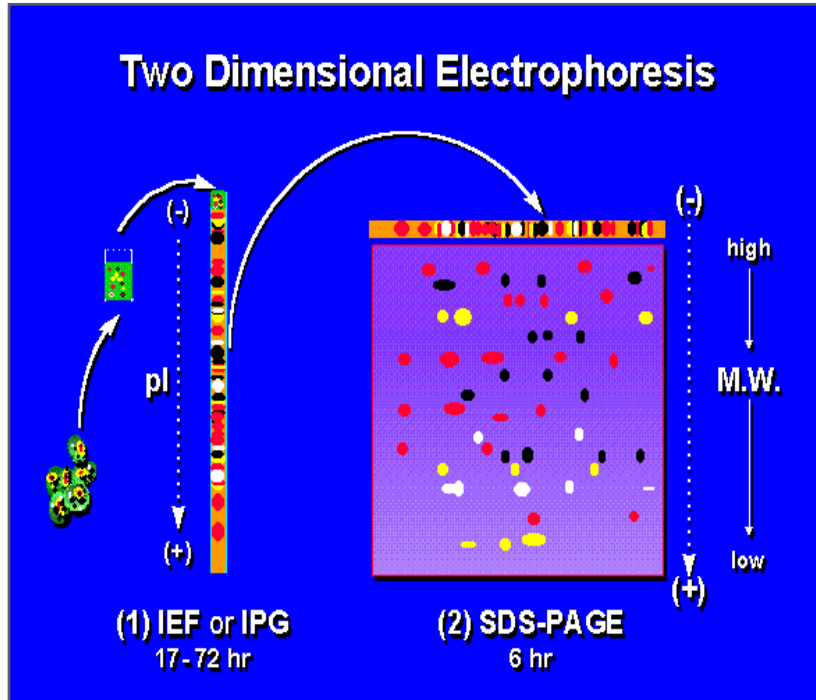

# APPLICATIONS OF ELECTROPHORESIS

1. DNA Sequencing
2. Medical Research
3. Protein research/purification
4. Agricultural testing
5. Separation of organic acid, alkaloids, carbohydrates, amino acids, alcohols, phenols, nucleic acids, insulin.
6. In food industry
7. It is employed in biochemical and clinical fields i.e. in the study of protein mixtures such as blood serum, haemoglobins and in the study of antigen- antibody interactions.
8. Electrophoresis in combination with autoradiography is used to study the binding of iron to serum proteins.
9. Used for analysis of terpenoids , steroids and antibiotics.
10. For testing purity of thyroid hormones by zone electrophoresis.
11. Paper chromato-electrophoresis is used to separate free Insulin from plasma proteins.
12. It is used for diagnosis of various diseases of kidney , liver and CVS.
13. It is also used for separation of Scopolamine and Ephedrine using buffer at PH 4.2.
14. Electrophoresis is also used for separation of carbohydrates and vitamins.
15. Quantitative separation of all fractions of cellular entities, antibiotics, RBC, Enzymes etc is possible.



THANK  
YOU!

The image features the words "THANK YOU!" in a bold, red, 3D sans-serif font. The letters are arranged in two lines: "THANK" on top and "YOU!" below it. The background is a light green color with a subtle, repeating pattern of white floral and leaf motifs. At the bottom of the image, there is a thick, curved green line that sweeps across the frame from the bottom left towards the right. The overall style is clean and celebratory.