

(v) Isomers and epimers

- Compounds that have the same chemical formula but have different structures are called isomers. For example, fructose, glucose, mannose, and galactose are all isomers of each other, having the same chemical formula,  $C_6H_{12}O_6$ .
- Carbohydrate isomers that differ in configuration around only one specific carbon atom are defined as epimers of each other. For example, glucose and galactose are C-4 epimers – their structures differ only in the position of the -OH group at carbon 4. [Note: The carbons in sugars are numbered beginning at the end that contains the carbonyl carbon – that is, the aldehyde or keto group]
- Glucose and mannose are C-2 epimers. However, galactose and mannose are **not** epimers – they differ in the position of -OH groups at two carbons (2 and 4) and are, therefore, defined only as isomers.

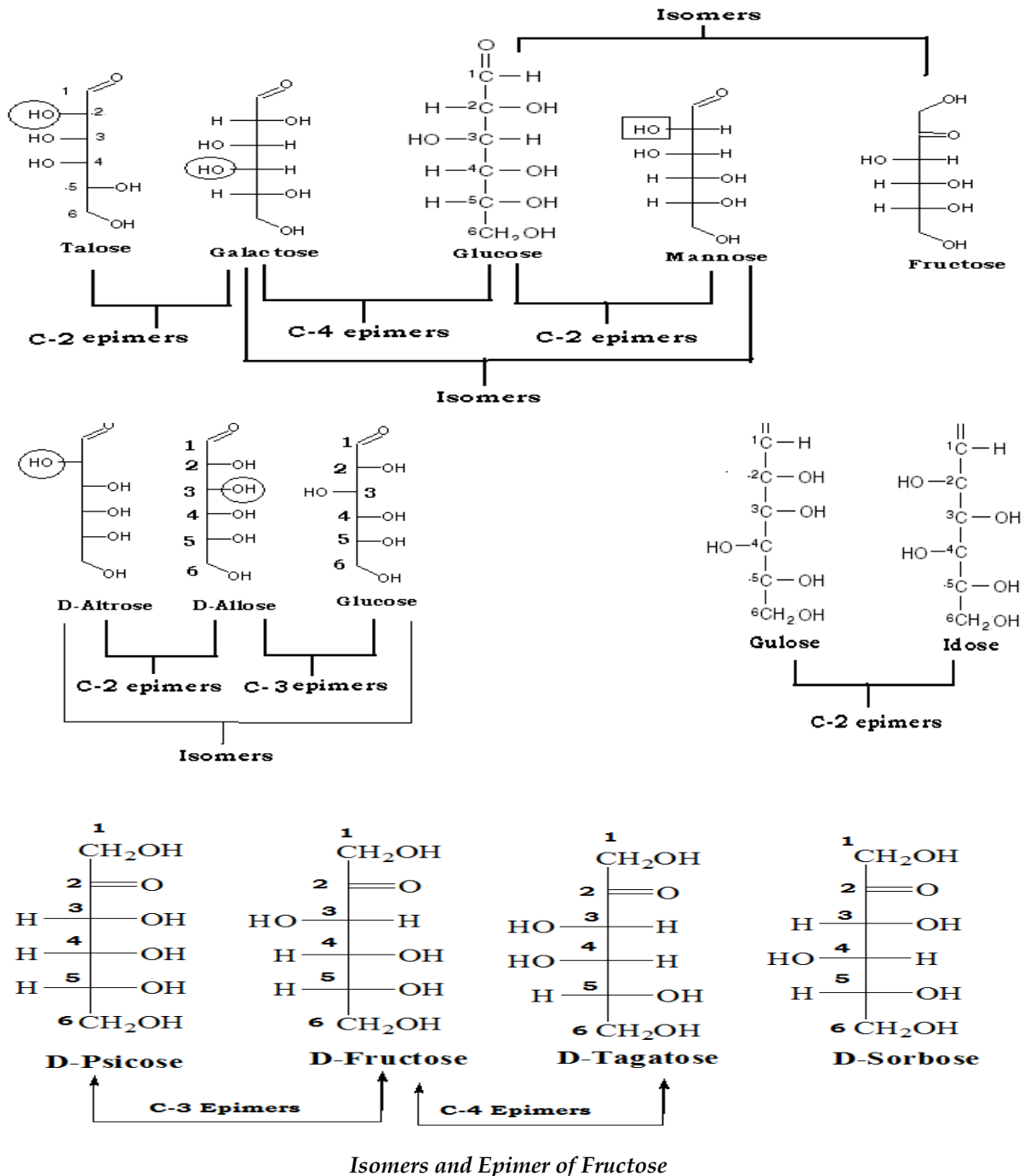

**(vi) Enantiomers**

- A special type of isomerism is found in the pairs of structures that are mirror images of each other. These mirror images are called enantiomers and the two members of the pair are designated as a **D-** and an **L-sugar**.
- The vast majority of the sugars in humans are **D-sugars**.
- In the D isomeric form, the OH group on the asymmetric carbon (a carbon linked to four different atoms or groups) farthest from the carbonyl carbon is on the right, while in the L-isomer it is on the left.
- Enzymes known as *racemases* are able to interconvert D- and L-isomers.

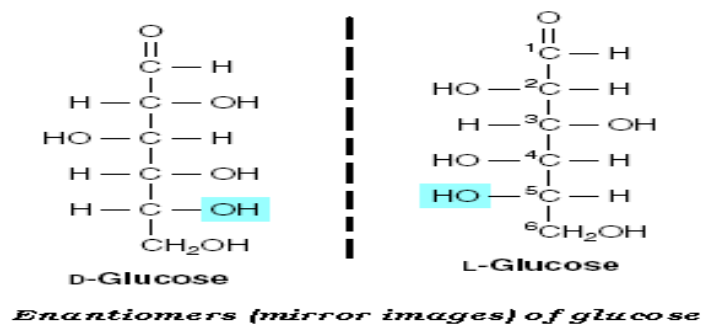
**(vii) Glycosidic bonds**

- Monosaccharides can be joined to form disaccharides, oligosaccharides and polysaccharides.
- Important disaccharides include lactose (galactose + glucose), sucrose (glucose + fructose) and maltose (glucose + glucose).
- The bonds that link sugars are called glycosidic bonds. These are formed by enzymes known as *glycosyltransferases* that use nucleotide sugars such as UDP-glucose as substrates.
- Glycosidic bonds between sugars are named according to the numbers of the connected carbons and also with regard to the position of the anomeric hydroxyl group of the sugar involved in the bond.
- If this anomeric hydroxyl is in the  $\alpha$  configuration, the linkage is an  $\alpha$ -bond. If it is in the  $\beta$  configuration, the linkage is a  $\beta$ -bond.
- Lactose, for example, forming a glycosidic bond between carbon 1 of  $\beta$ -galactose and carbon 4 of glucose. The linkage is, therefore, a  $\beta$  (1 $\rightarrow$ 4) glycosidic bond.

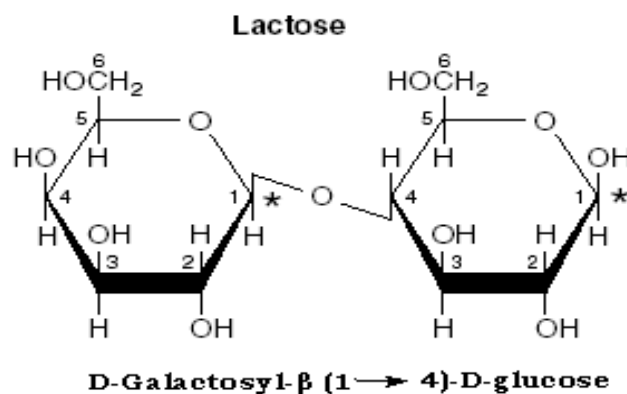
**(viii) Mutarotation In Sugars**

- Mutarotation is the change in the optical rotation because of the change in the equilibrium between two anomers, when the corresponding stereocenters interconvert. Cyclic sugars show mutarotation as  $\alpha$  and  $\beta$  anomeric forms interconvert.
- The optical rotation of the solution depends on the optical rotation of each anomer and their ratio in the solution.
- Mutarotation was discovered by French chemist **Sir Dubrunfaut** in 1846, when he noticed that the specific rotation of aqueous sugar solution changes with time. [The organic fructose molecule was subsequently discovered by **Dubrunfaut** in 1847].

- Sugars in the ring form can exist in two states, one where the C-1 hydroxy group is above the plane of the ring ( $\beta$ ) and one where it is below ( $\alpha$ ).
- In aqueous solution there is a constant interchange between the various conformations via the breaking open of the hemiacetal structure and its subsequent reforming.

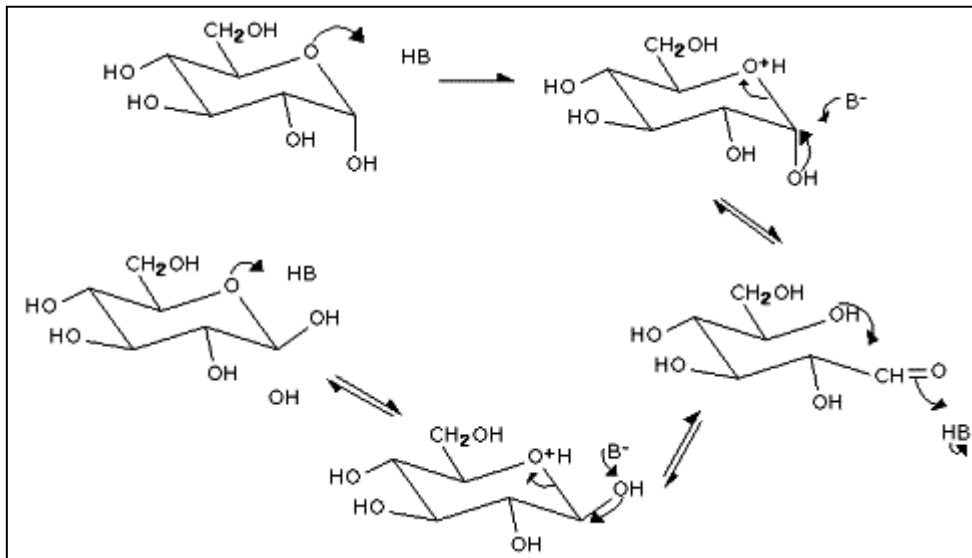

- Glucose is a mixture of  $\alpha$ - and  $\beta$ -anomers, primarily the  $\alpha$ -anomer. The optical rotation of the  $\alpha$ -anomer is  $+112.2^\circ$  ( $c = 10\%$  in water,  $20^\circ\text{C}$ ) and the  $\beta$ -anomer is  $+18.7^\circ$  ( $c = 10\%$  in water,  $20^\circ\text{C}$ ). When D-glucose is dissolved in water, the optical rotation gradually changes (mutarotates) with time and approaches a final equilibrium value of  $+52.7^\circ$  ( $c = 10\%$ ,  $20^\circ\text{C}$ ) due to the formation of an equilibrium mixture consisting of approximately one-third  $\alpha$ - and two-thirds  $\beta$ -D-glucose.

### General methods of analysis of food carbohydrates

- Carbohydrates are a significant component of many meals and raw materials. Food carbohydrate analytical techniques are important for food quality assurance and product uniformity.
- The classical methods are mainly divided into three categories:
  - Total sugar analysis** (phenol-sulfuric acid assay, anthrone-sulfuric acid methods, and methodology for uronic acid and reducing sugar analysis)
  - Monosaccharide's analysis** (enzymatic methods, anion-exchange chromatography, and gas-liquid chromatography)
  - Structure characterization** (partial acid hydrolysis, smith degradation, and methylation analysis).

#### Total carbohydrate:

**By difference:** 100 - (weight in grams [protein + fat + water + ash + alcohol] in 100 g of food)

**By direct analysis:** weight in grams (monosaccharides + disaccharides + oligosaccharides + polysaccharides, including fibre)

#### Available carbohydrate:

**By difference:** 100 - (weight in grams [protein + fat + water + ash + alcohol + fibre] in 100 g of food)

**By direct analysis:** weight in grams (monosaccharides + disaccharides + oligosaccharides + polysaccharides, excluding fibre)\*

\*May be expressed as weight (anhydrous form) or as the monosaccharide equivalents (hydrous form including water).

## ❖ Carbohydrate Assay

- The enzymatic assay of sucrose, fructose and starch are based on the enzymatic determination of glucose. The first step is the conversion or degradation of the carbohydrate to glucose or glucose derivative. The glucose concentration is then determined according to the two different detection systems: glucose oxidase (GO) or hexokinase (HK) in combination with the glucose-6-phosphate dehydrogenase reaction.

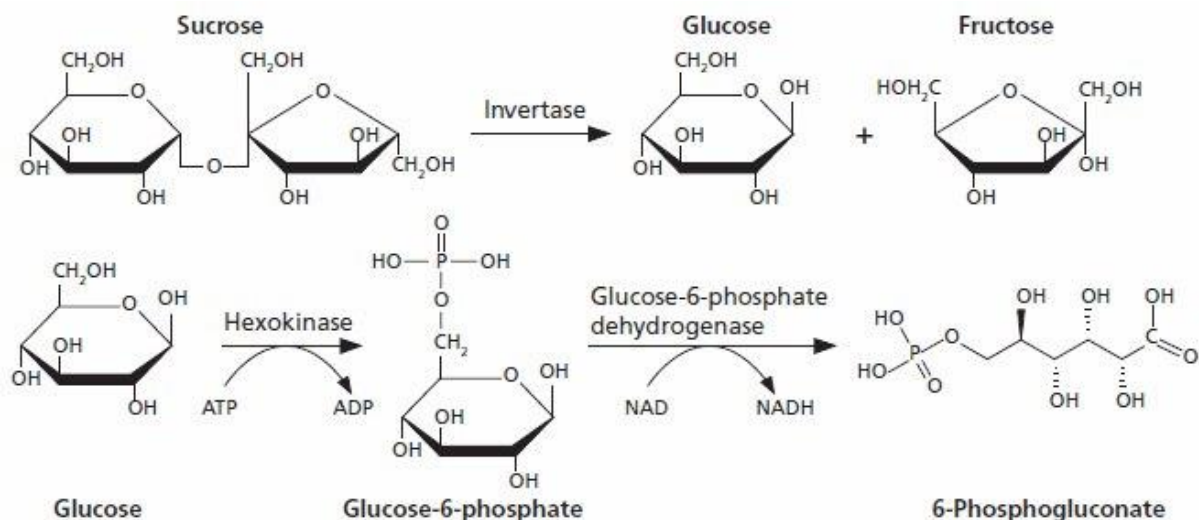
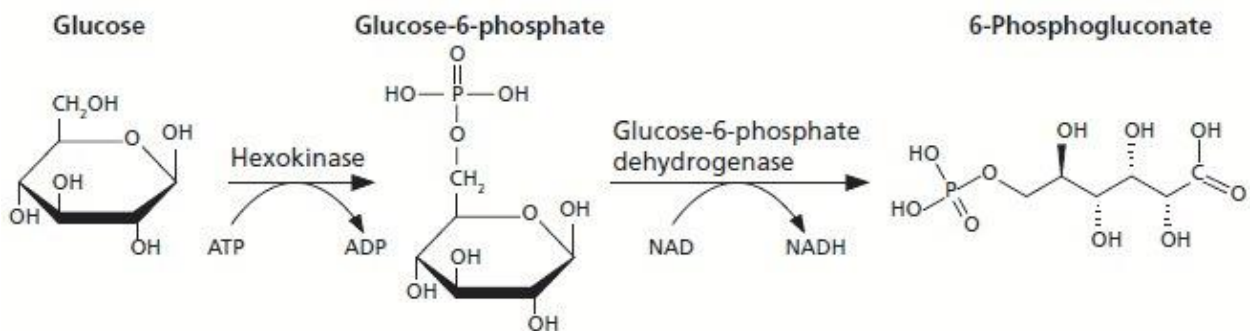
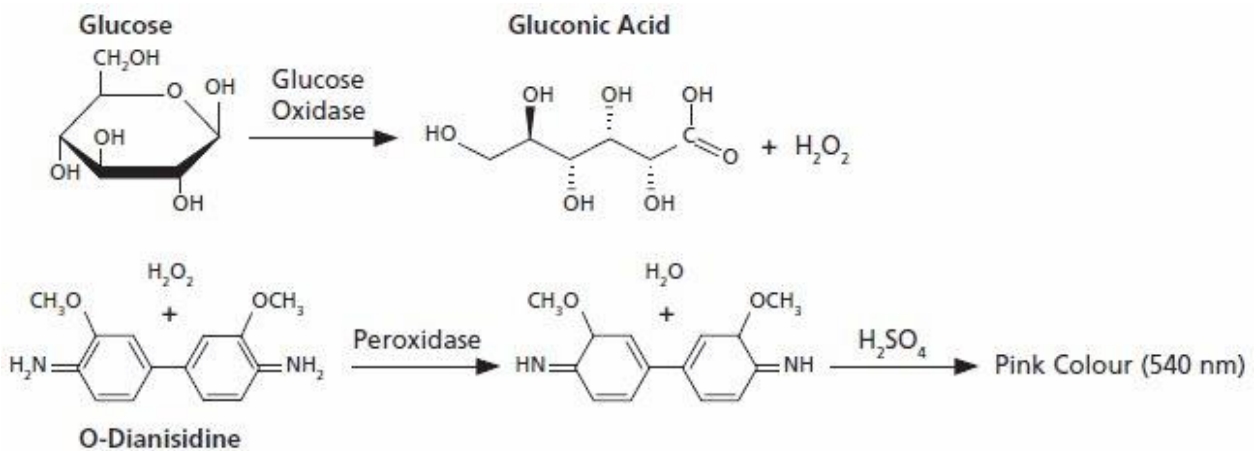

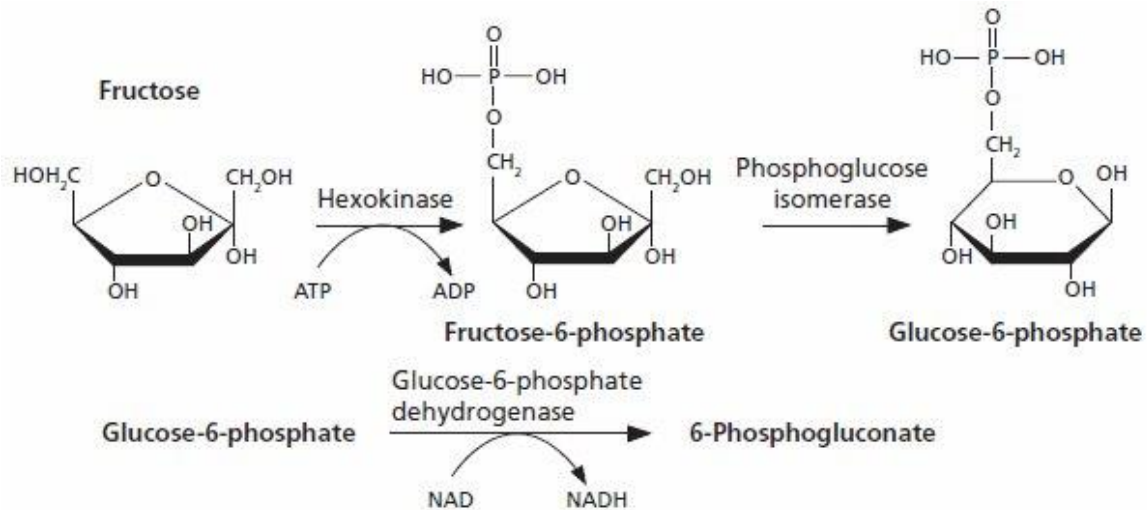

**Fructose assay:** Fructose is phosphorylated by ATP in a reaction catalysed by hexokinase. The resulting fructose-6-phosphate is then converted to glucose-6-phosphate by phosphoglucose isomerase. Glucose-6-phosphate and NAD is converted to 6-phosphogluconate and NADH, monitored at 340 nm.

- **General methods of analysis of food carbohydrates**

