

Mechanization of machine tools

Degree of freedom (DOF)

- In mechanical system
- It is the number of independent parameters that define its configuration.
- It is the number of parameters that determine the state of a physical system
- And is important to the analysis of systems of bodies in
 - Mechanical engineering
 - Aeronautical engineering
 - Robotics
 - Structural engineering etc.

Six degrees of freedom

- Moving up and down (elevating/heaving);
- Moving left and right (strafing/swaying);
- Moving forward and backward (walking/surging);
- Swivels left and right ([yawing](#));
- Tilts forward and backward ([pitching](#));
- Pivots side to side ([rolling](#)).

Translational Movement in Three Perpendicular Axes

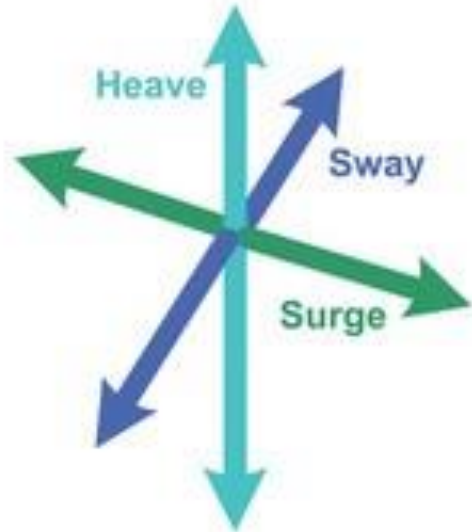

Surge: Moving forward/backward
Heave: Moving up/down
Sway: Moving left/right

+

Rotational Movement about Three Perpendicular Axes

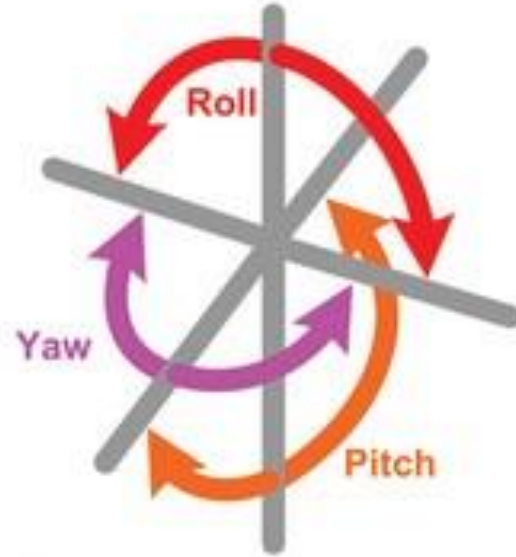

Roll: Tilting side to side
Pitch: Tilting forward and backward
Yaw: Turning left and right

=

Six Degrees of Freedom

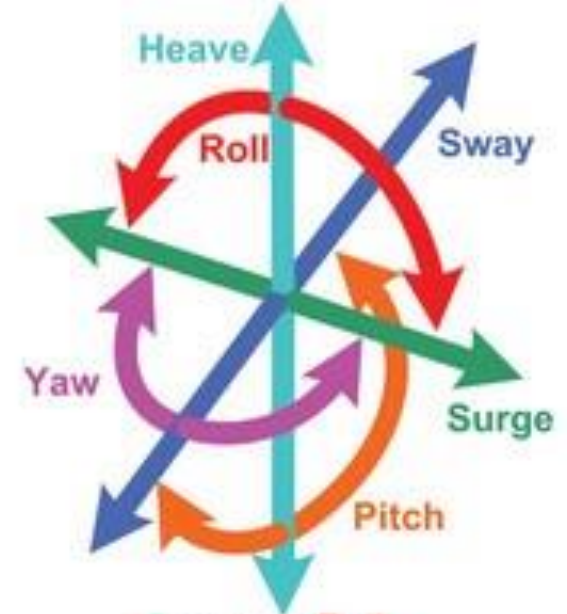

Surge **Roll**
Heave **Pitch**
Sway **Yaw**

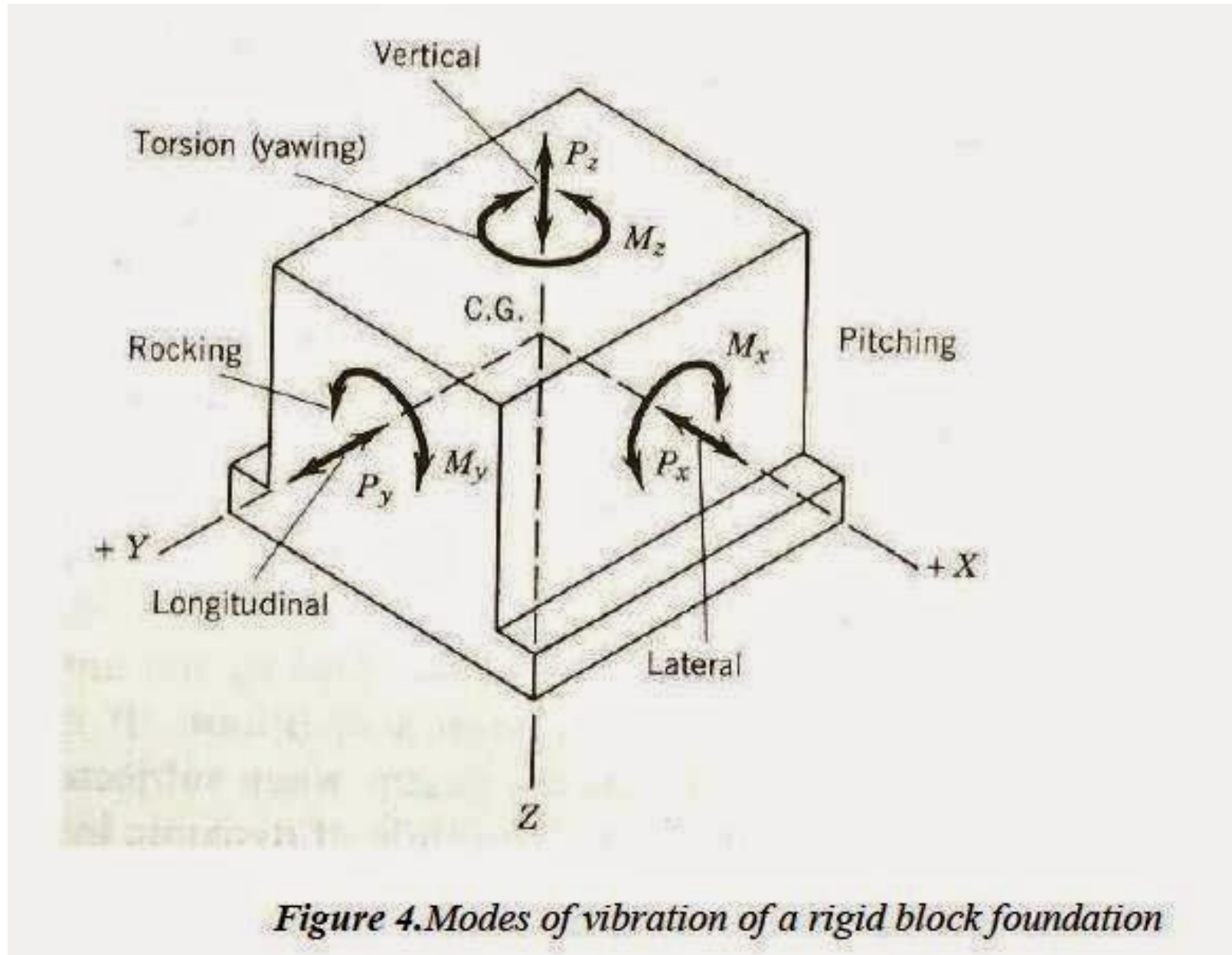
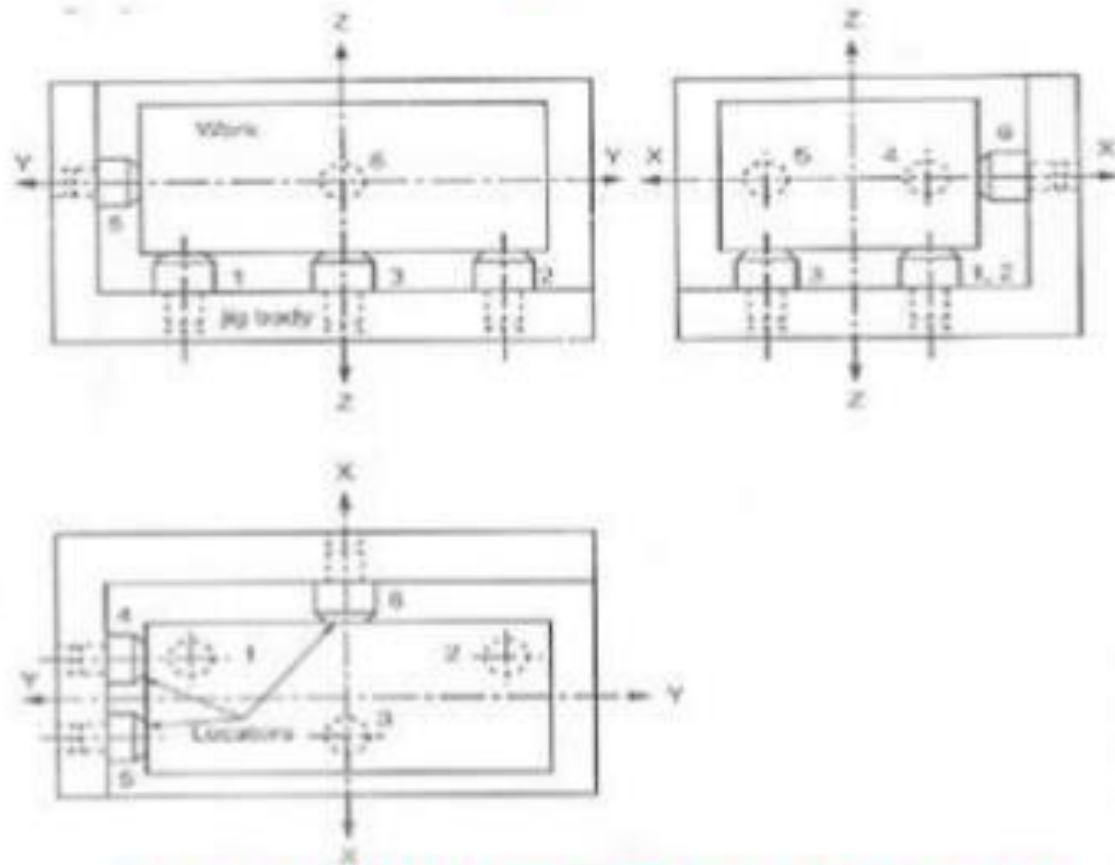

Figure 4. Modes of vibration of a rigid block foundation

The 3-2-1 principle of location (Six point location principle)

- Used to constrain the **movement** of work piece along the three axes
 - XX
 - YY
 - and ZZ
- Achieved by providing six locating points
 - 3 pins in base plate
 - 2 pins in vertical plane and
 - 1 pin in a plane perpendicular to first two planes

Six point Location Principles



Pin 1,2 and 3

for z-z axis translation
y-y axis rotation
x-x axis rotation

Pin 4 and 5

for y-y axis translation
z-z axis rotation

Pin 6

for x-x translation

3-2-1 PRINCIPLE OF LOCATION

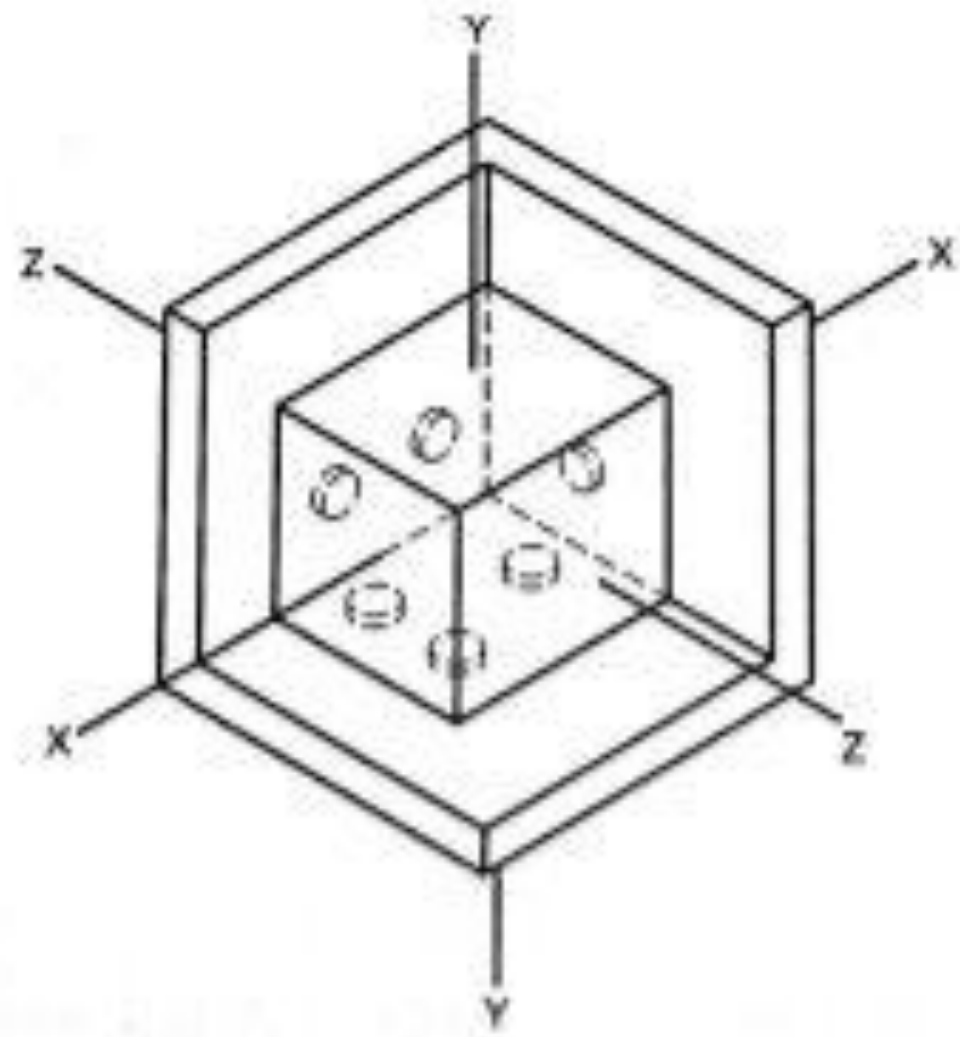

(a)

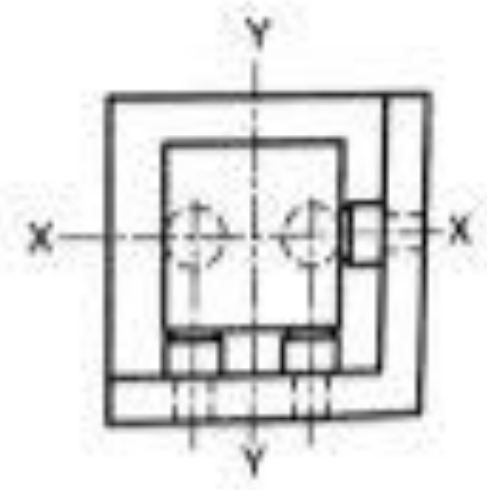
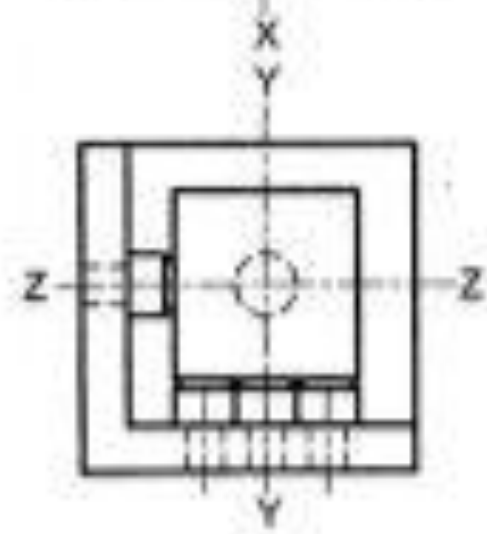
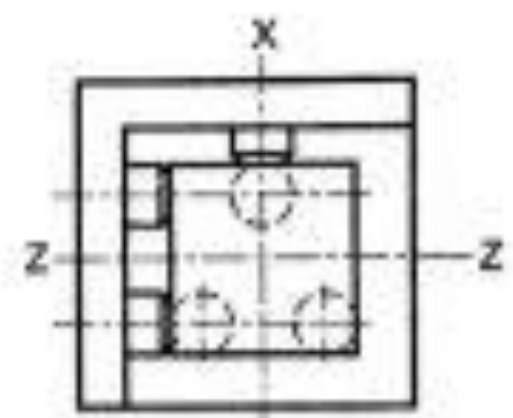

(b)

Jigs & Fixtures

Jigs & Fixtures

- Jigs: Primary purpose is to provide in the manufacturing of products
 - Repeatability
 - Accuracy
 - Interchangeability
 - Often confused with a fixture
- Fixture: holds the work in a fixed location.
- A device that does both functions
 - holding the work
 - and guiding a tool)
 - is called a jig.



Jigs

Fixtures

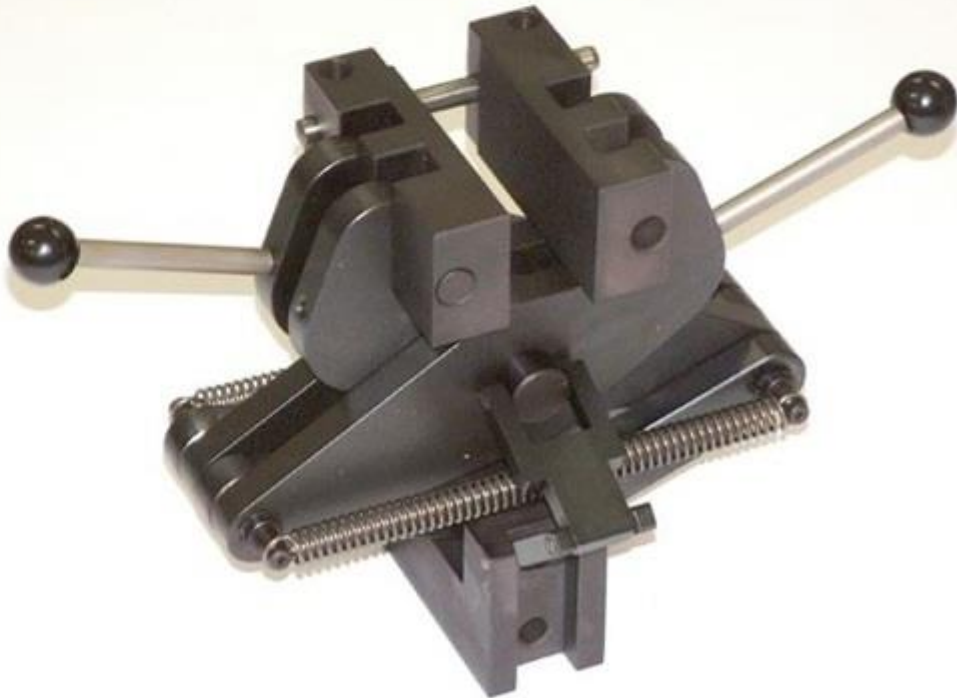



Cast Iron Welding Jigs



Drill Jig

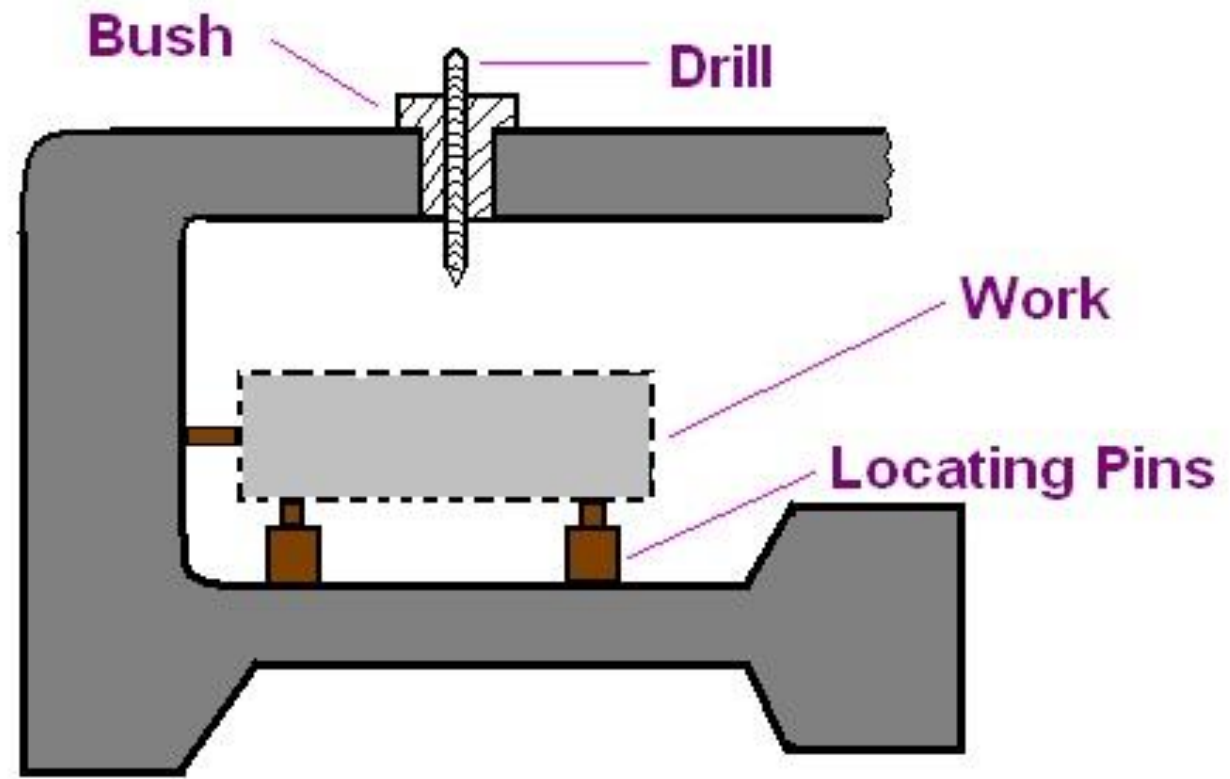

∴ Jig ∴

Lathe Fixtures

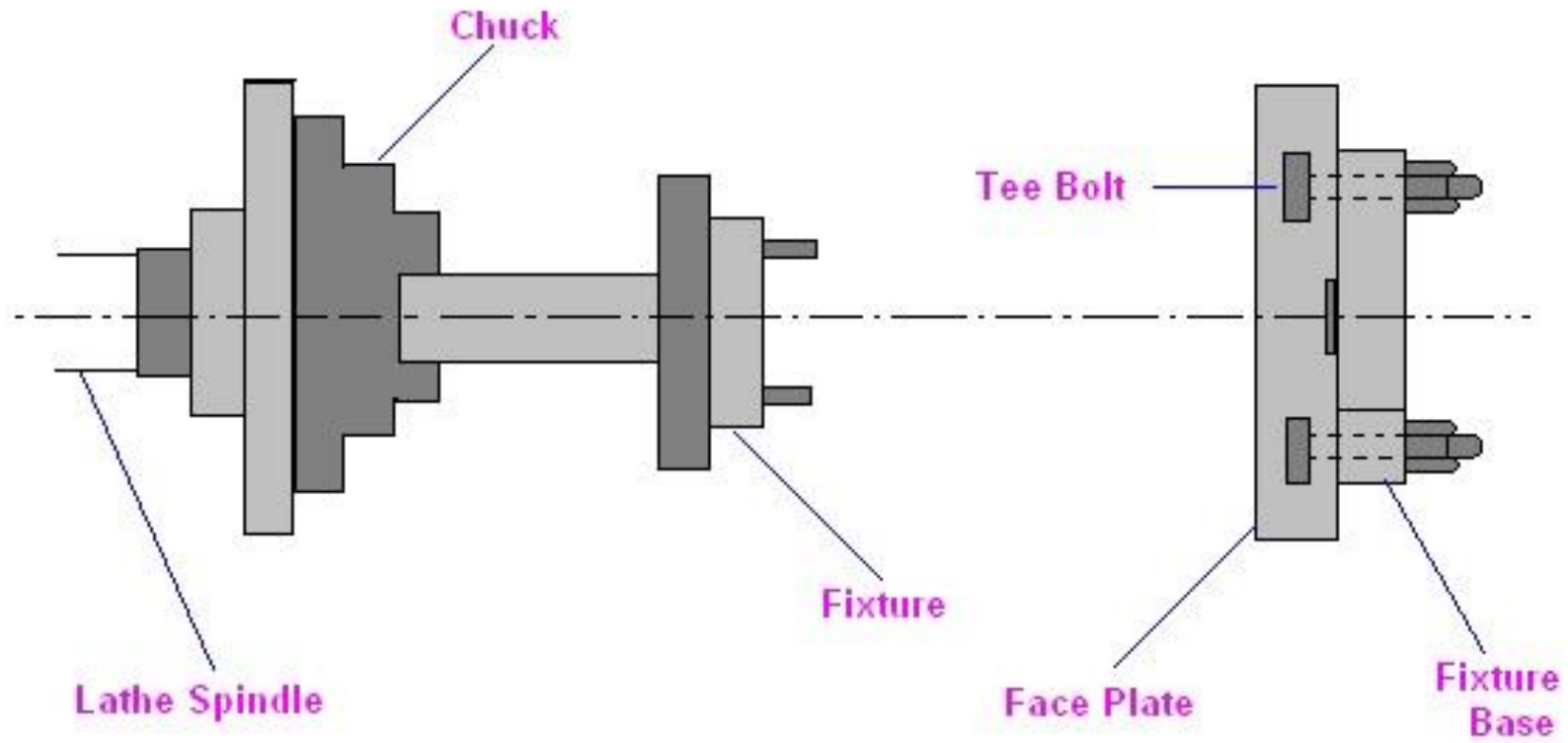

Elements of Jigs and Fixtures

- Body
- Locating devices
- Clamping devices
- Tool guide(jigs bushing)

Body

- Generally made of cost iron
- May be heat treated to relief the stresses
- Main purpose is to support and house the job

Locating devices

- Used to locate a work piece in a jig or fixture
- Made of hardened steel
- The shank of the pin is press fitted into the body of jig or fixture.
- The locating diameter of the pin is made larger than the shank
 - To prevent it from being forced into the jig or fixture body due to the weight of the work piece or cutting forces.

Locating Pins

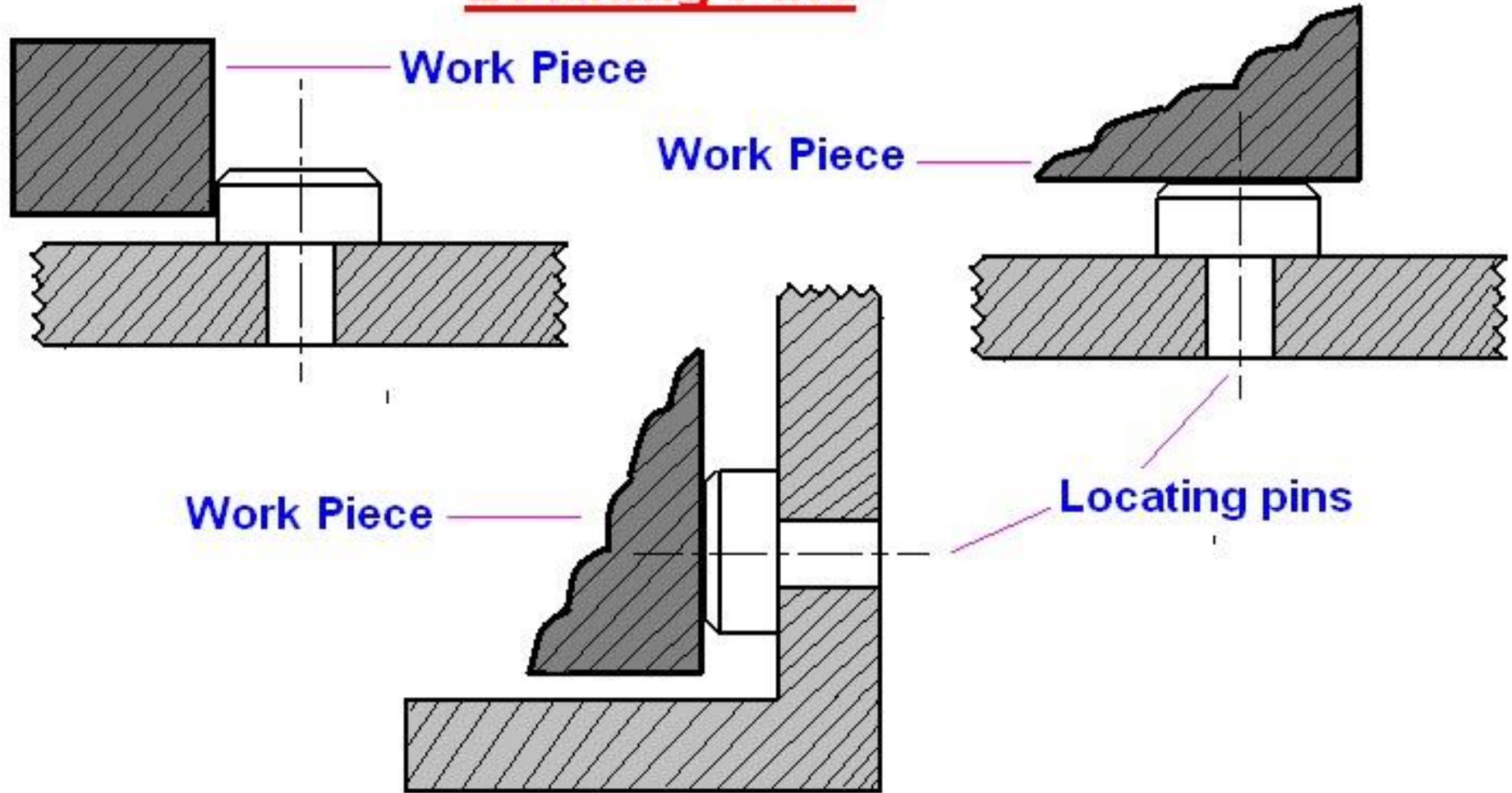

Clamping devices

- To clamp the work piece in jig or fixture body e.g.
 - Bench vice
 - Clamping screw
- Exert pressure to press a work piece against the locating surfaces
- Hold the work piece there in a position to the cutting forces.

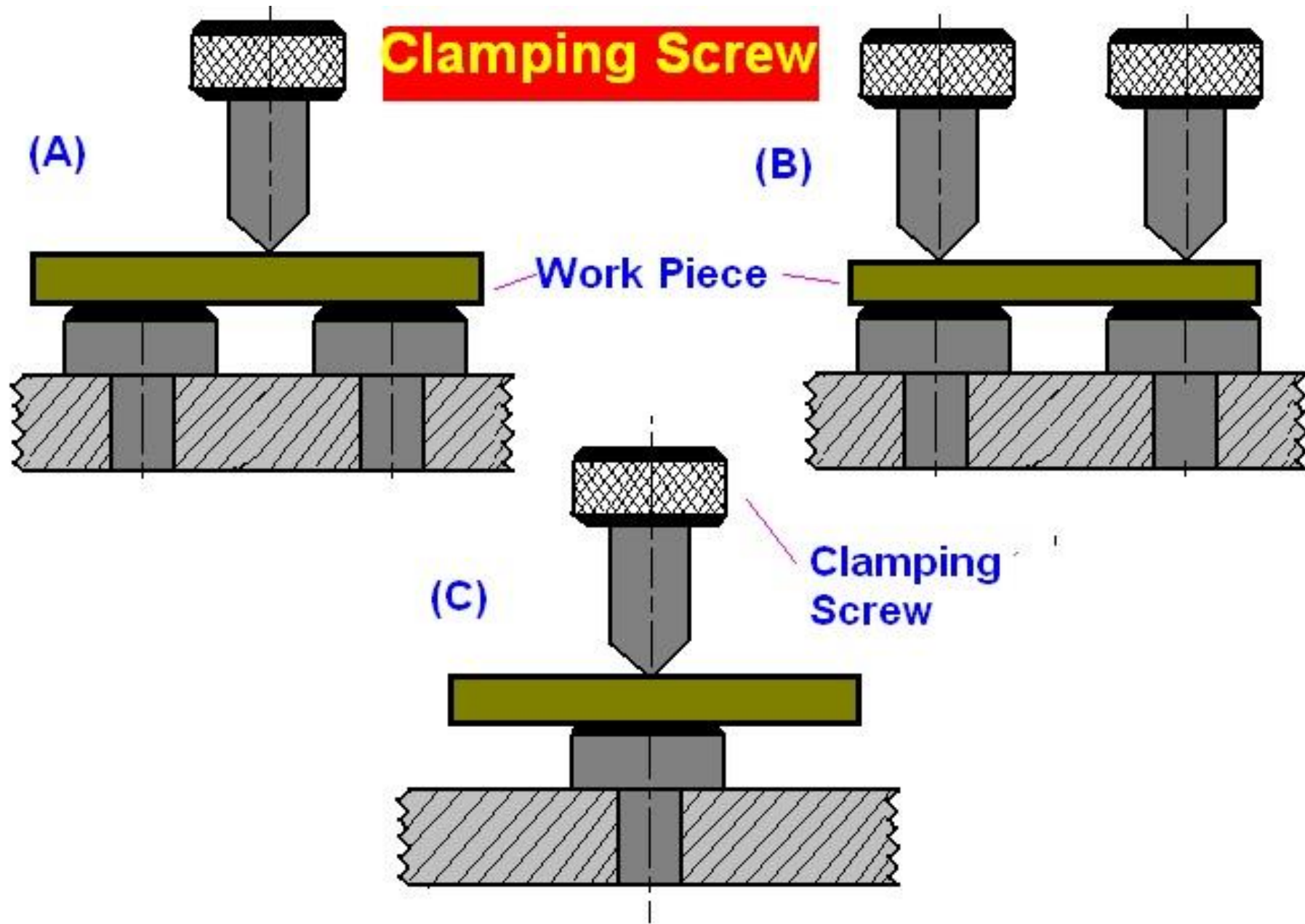

Hook Bolt Clamp

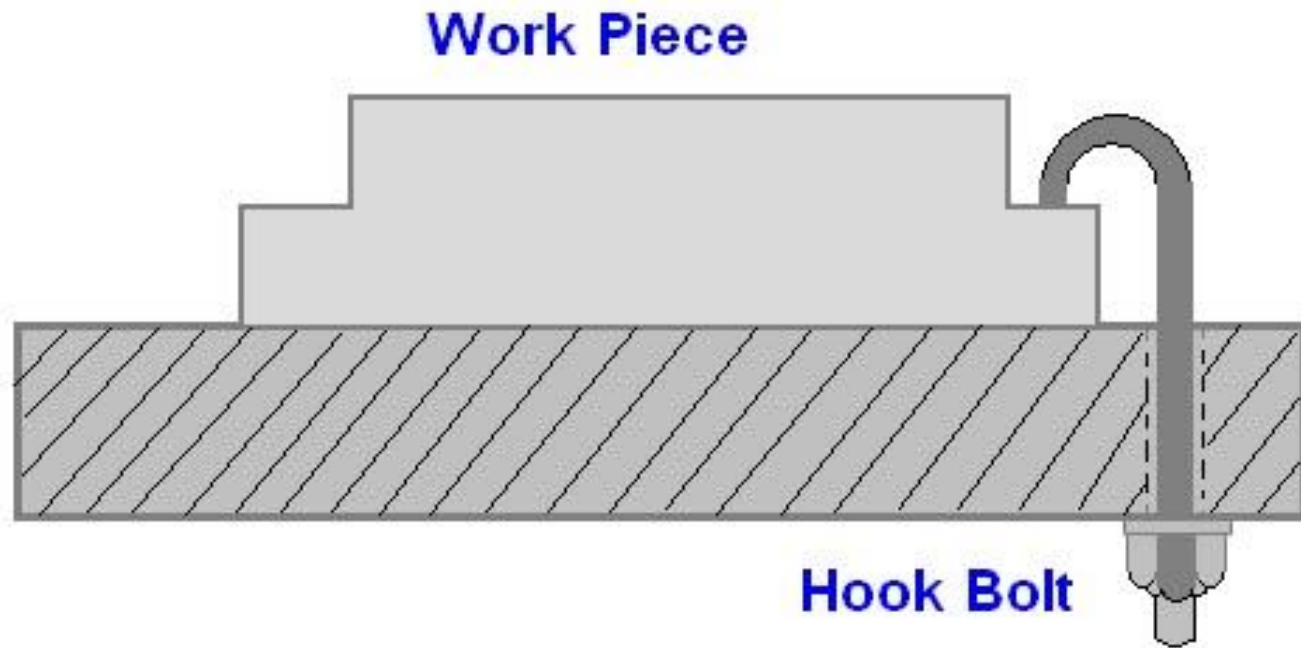

Bridge Clamp

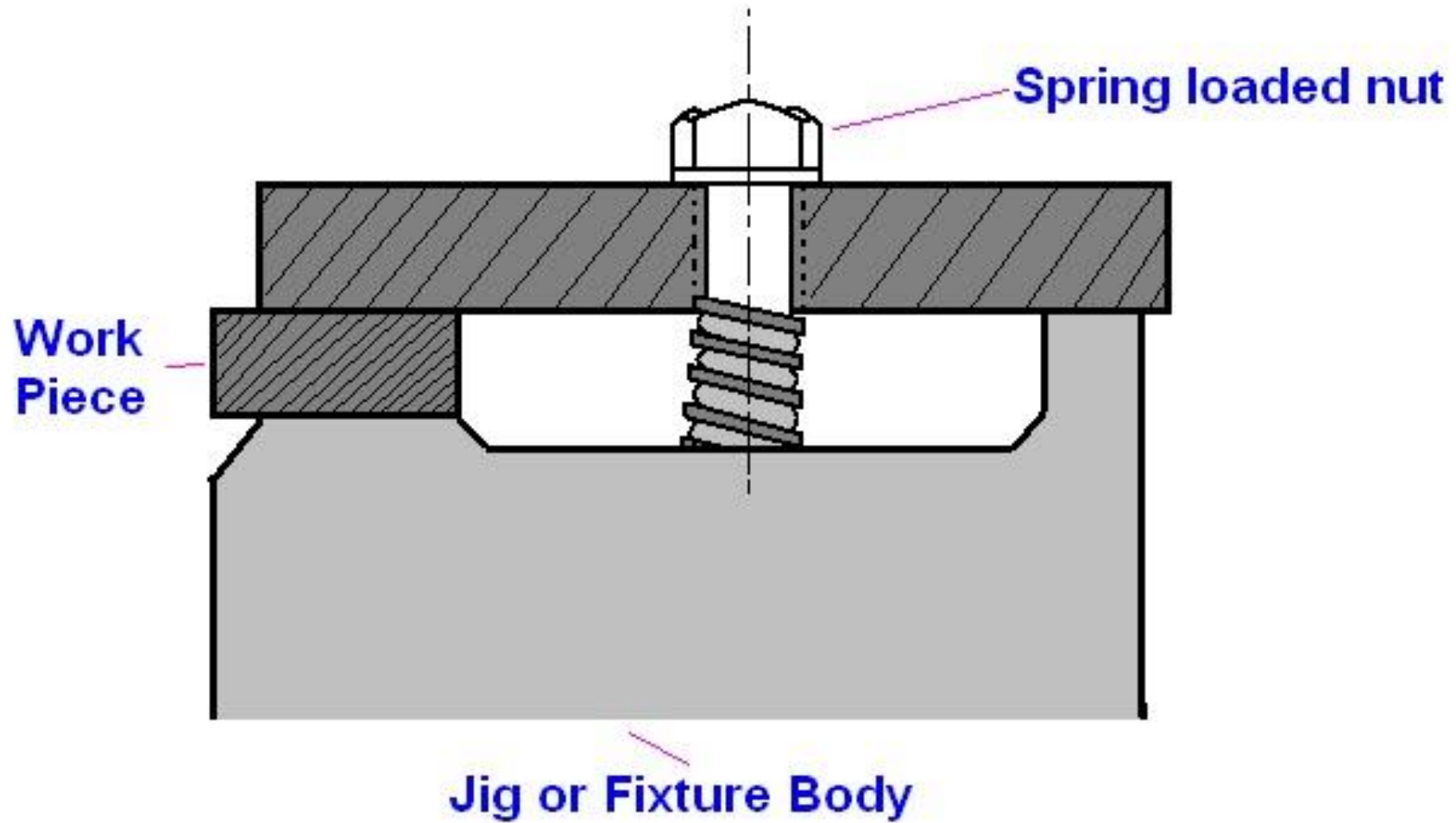

Heel Clamp

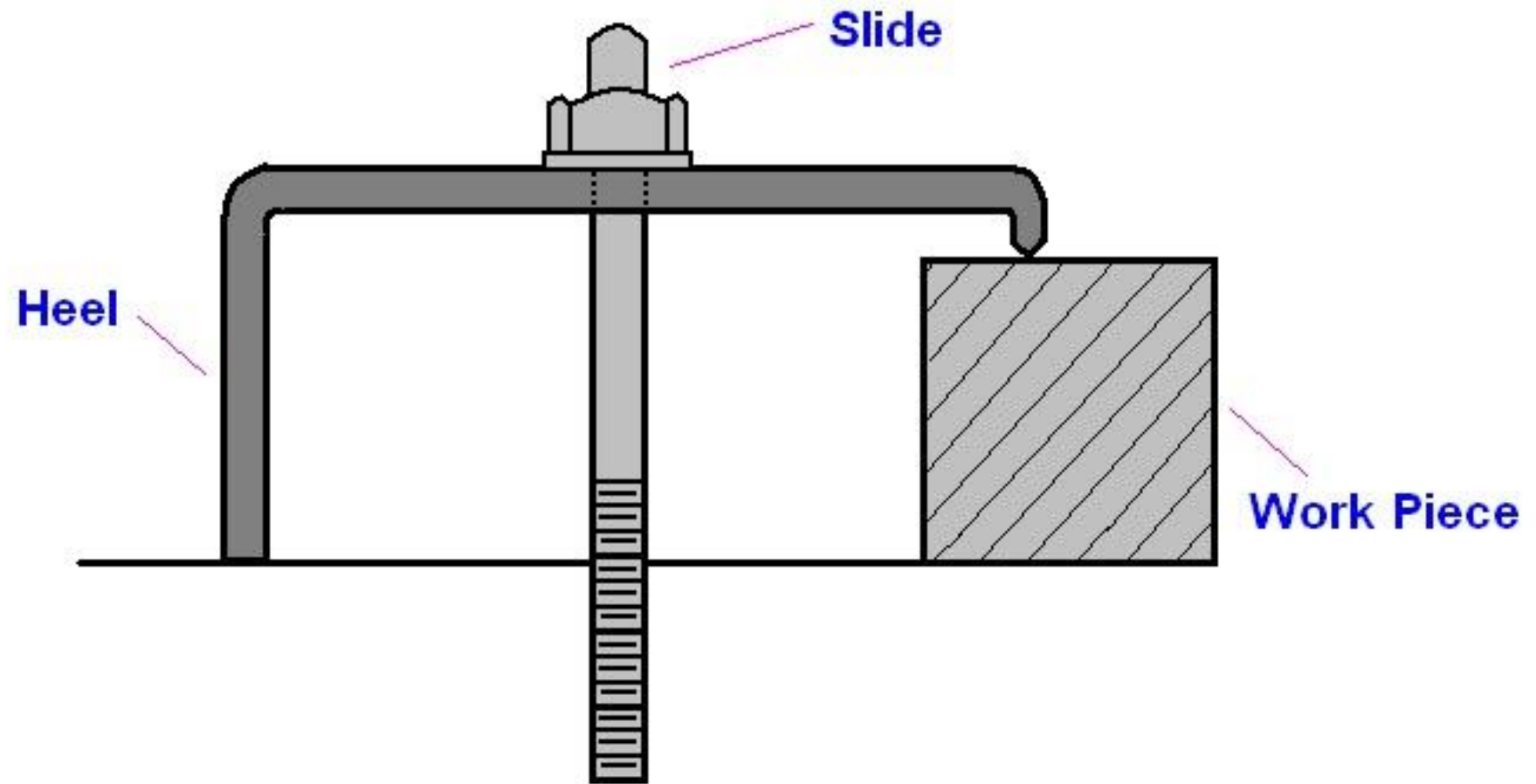

**Latch Or
Swing Strap
Clamp**

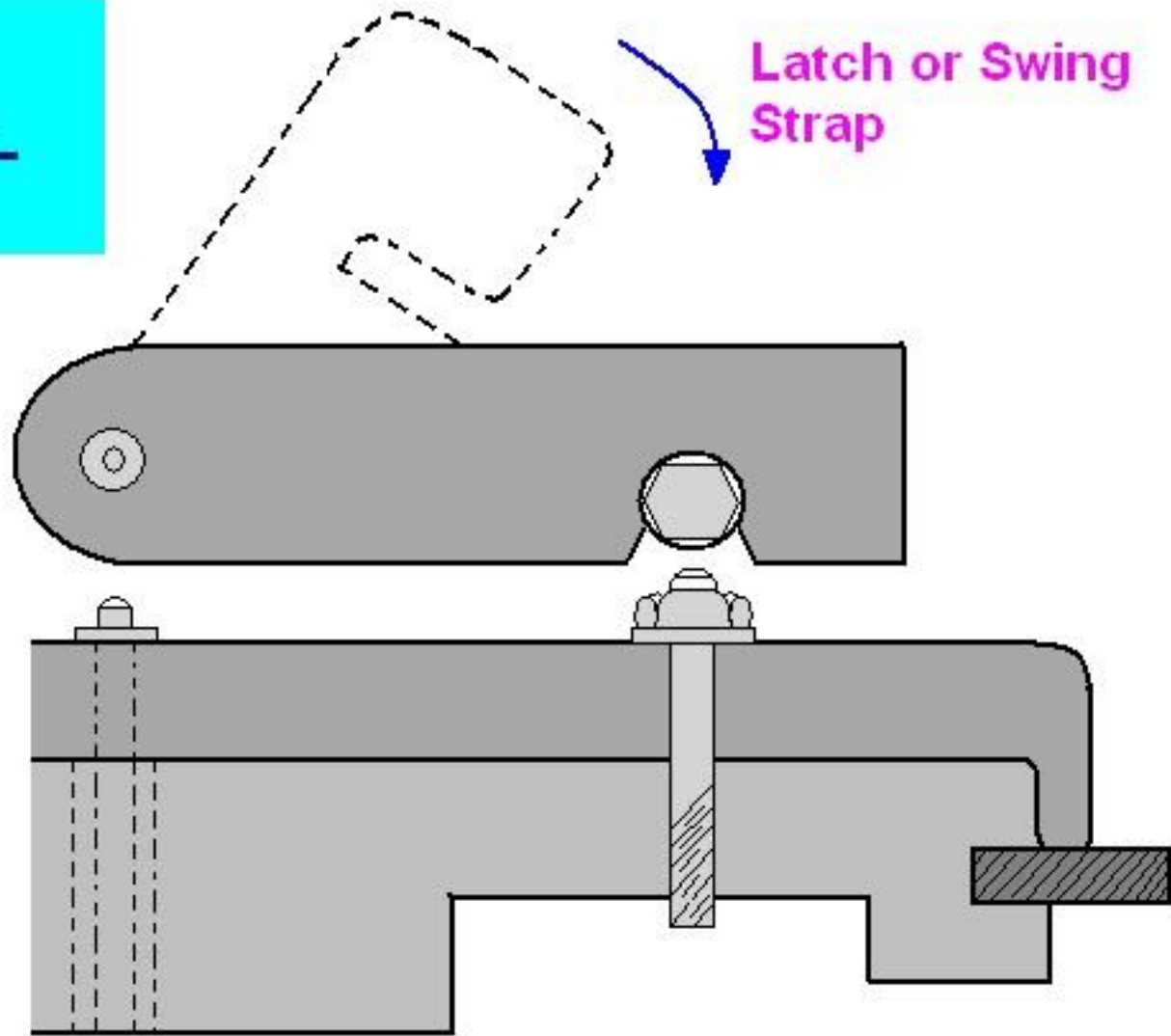

C-Clamp

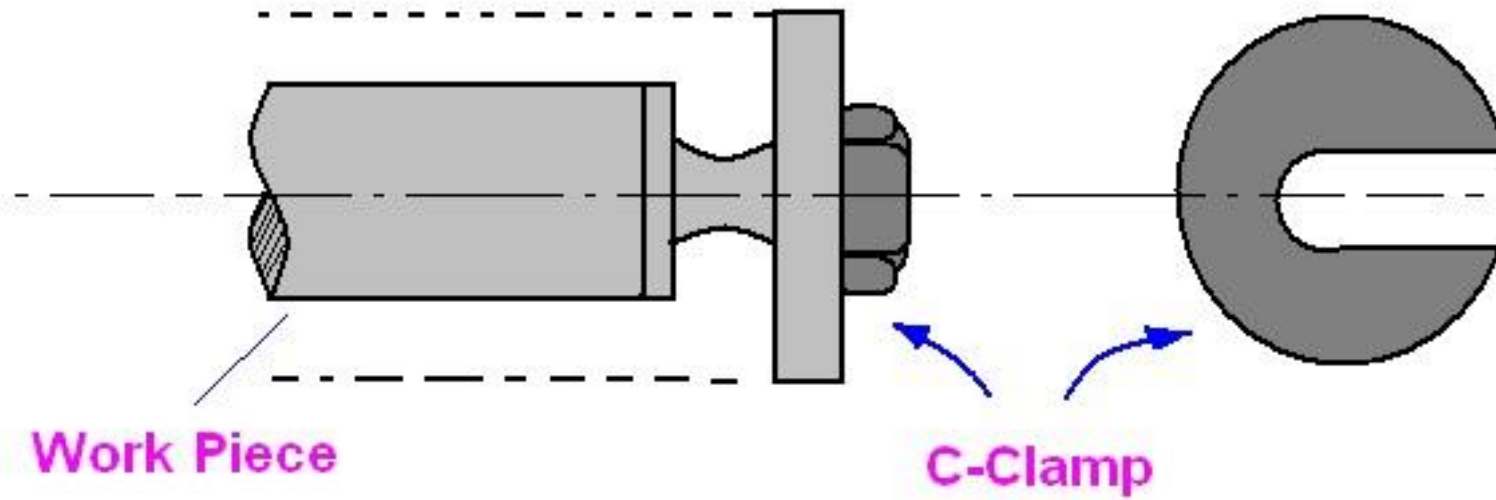

Tool Guide or Jig Bushing

- To locate the tool relative to the work
- Uses guiding parts such as jigs bushing and templates
- Must be
 - Precise
 - Wear resistance and
 - Changeable
- May be of cast iron
- Hardened steel bushes are preferable for guiding drills, reamers and taps etc.

Types Of Drilling Jigs

- Template jig
- Plate type jig
- Open type jig
- Channel jig
- Leaf Jig
- Box type jig

Template Jig

- A simplest type of jig
- Simply a plate made to
 - the shape and
 - size of the work piece
 - with the require number of holes
- Placed on the work piece
- The hole will be made by the drill
 - Guided through the holes in the template plate
 - Hardened to avoid its frequent replacement
- This type of jig is suitable if only a few part are to be made

Template Jig

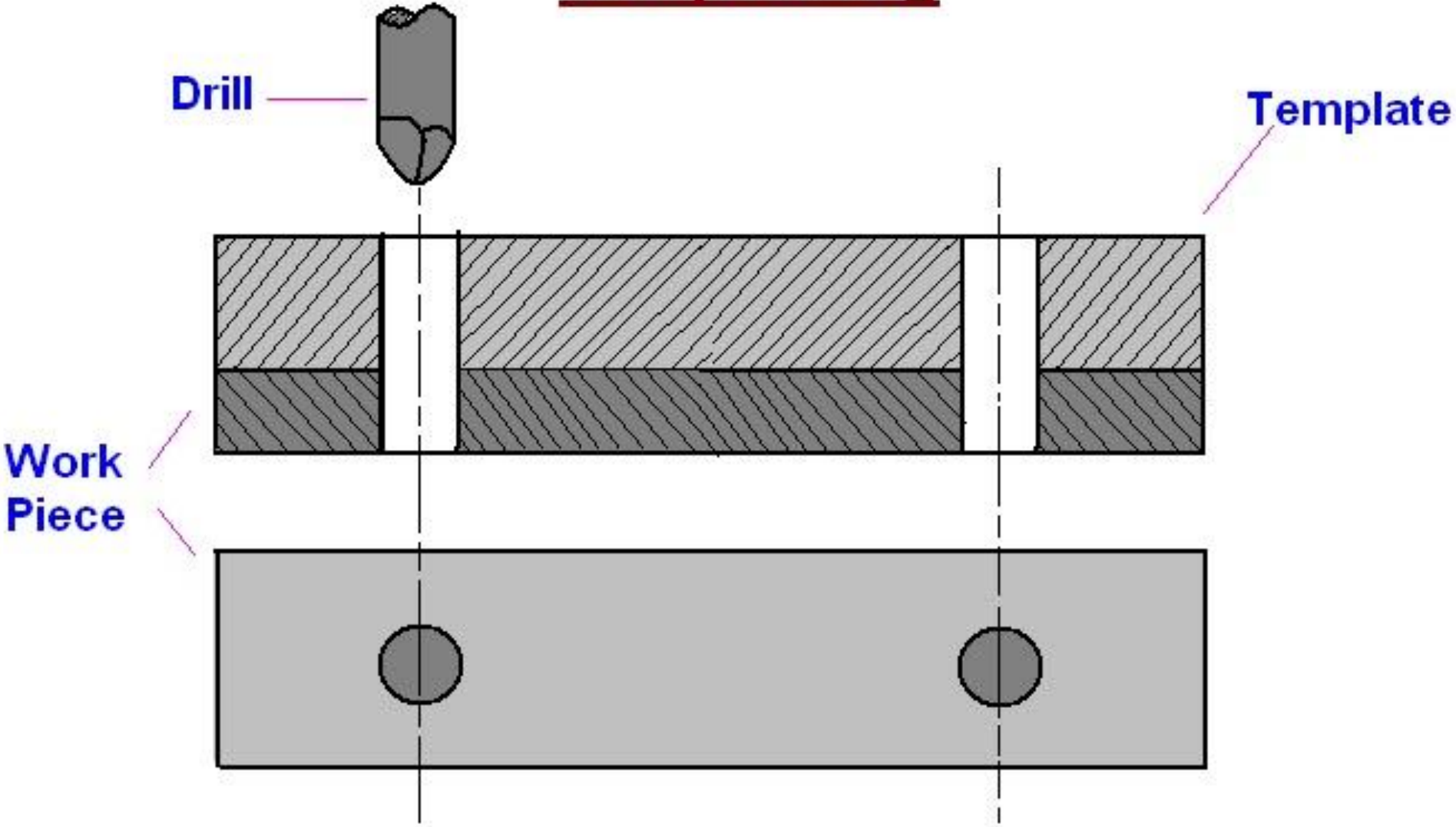
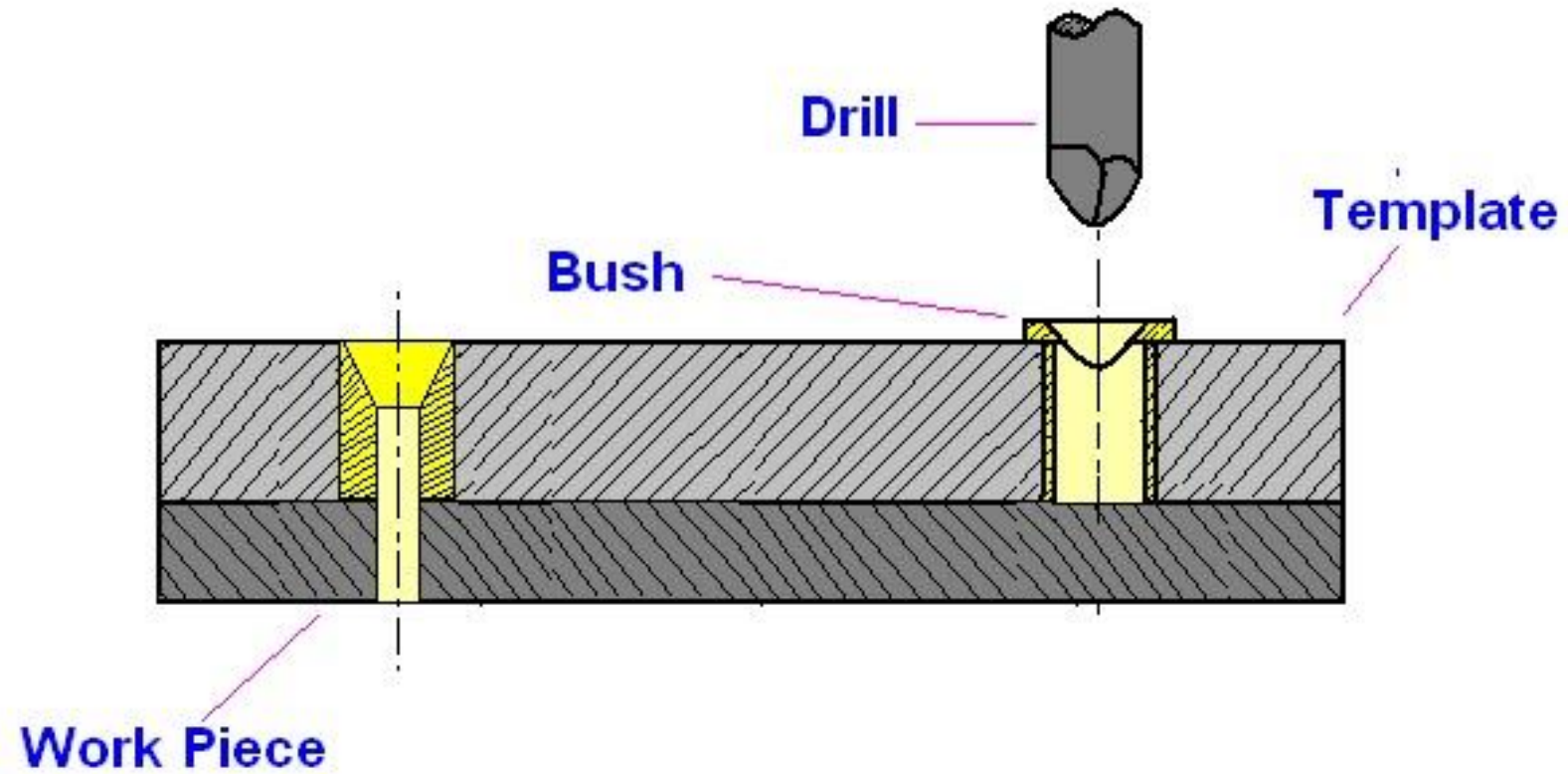

Plate Type Jig

- An improvement of the template type of jig
- Drill bushes are provided in the plate to guide the drill
- The work piece can be clamped to the plate
- Employed to drill holes in large parts, maintaining accurate spacing with each other

Plate Type Jig



Open Type Jig

- The top of the jig is open
- The work piece is placed on the top

Open Type Jig

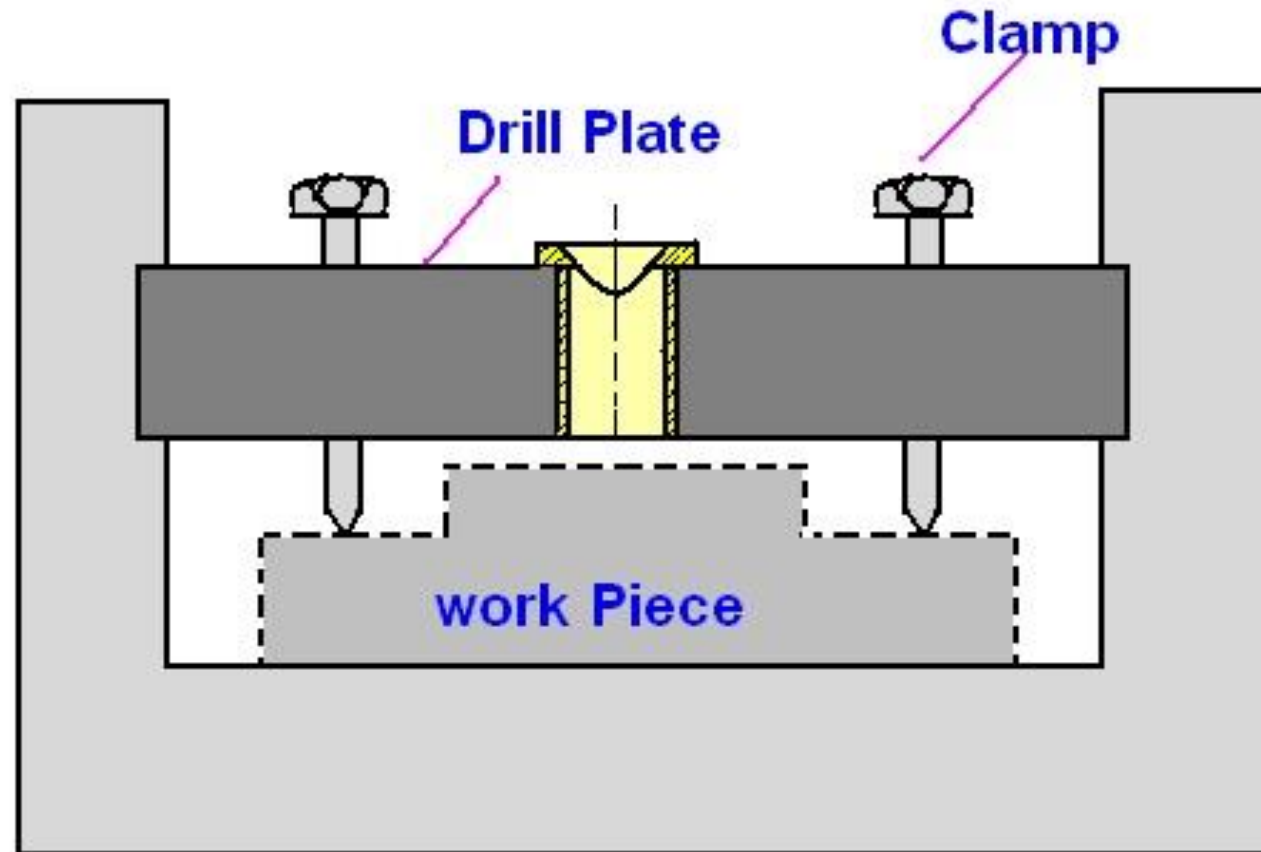

Channel jig

- A simple type of jig having channel like cross section
- The work piece is fitted within the channel
 - Located
 - And clamped by locating the knob
- The tool is guided through the drill bush.

Channel Jig

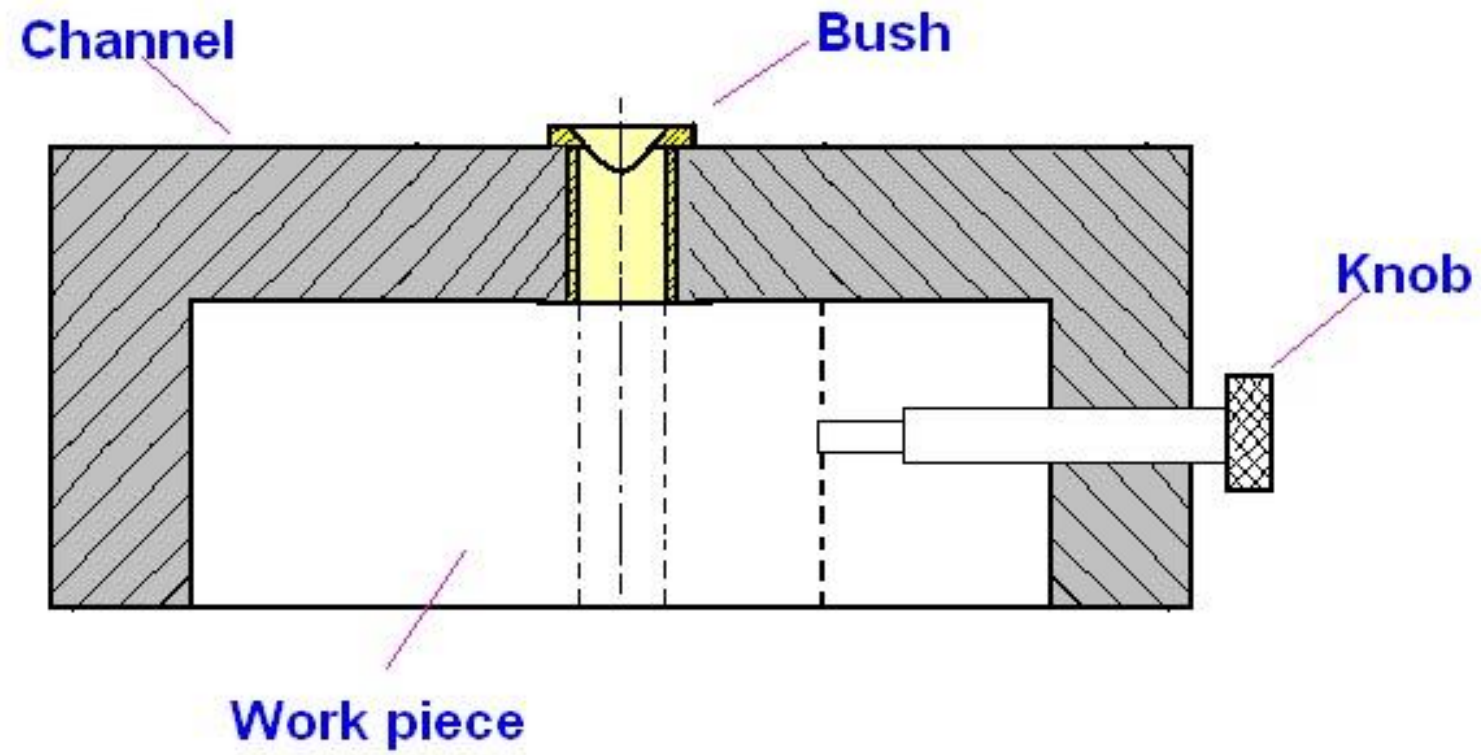

Leaf Jig

- A sort of open type jig
- The top plate is arrange to swing about a fulcrum point
- It completely clears the jig for easy loading and unloading of the work piece
- The drill bushes are fitted into the plates
 - Also known as leaf , latch or lid

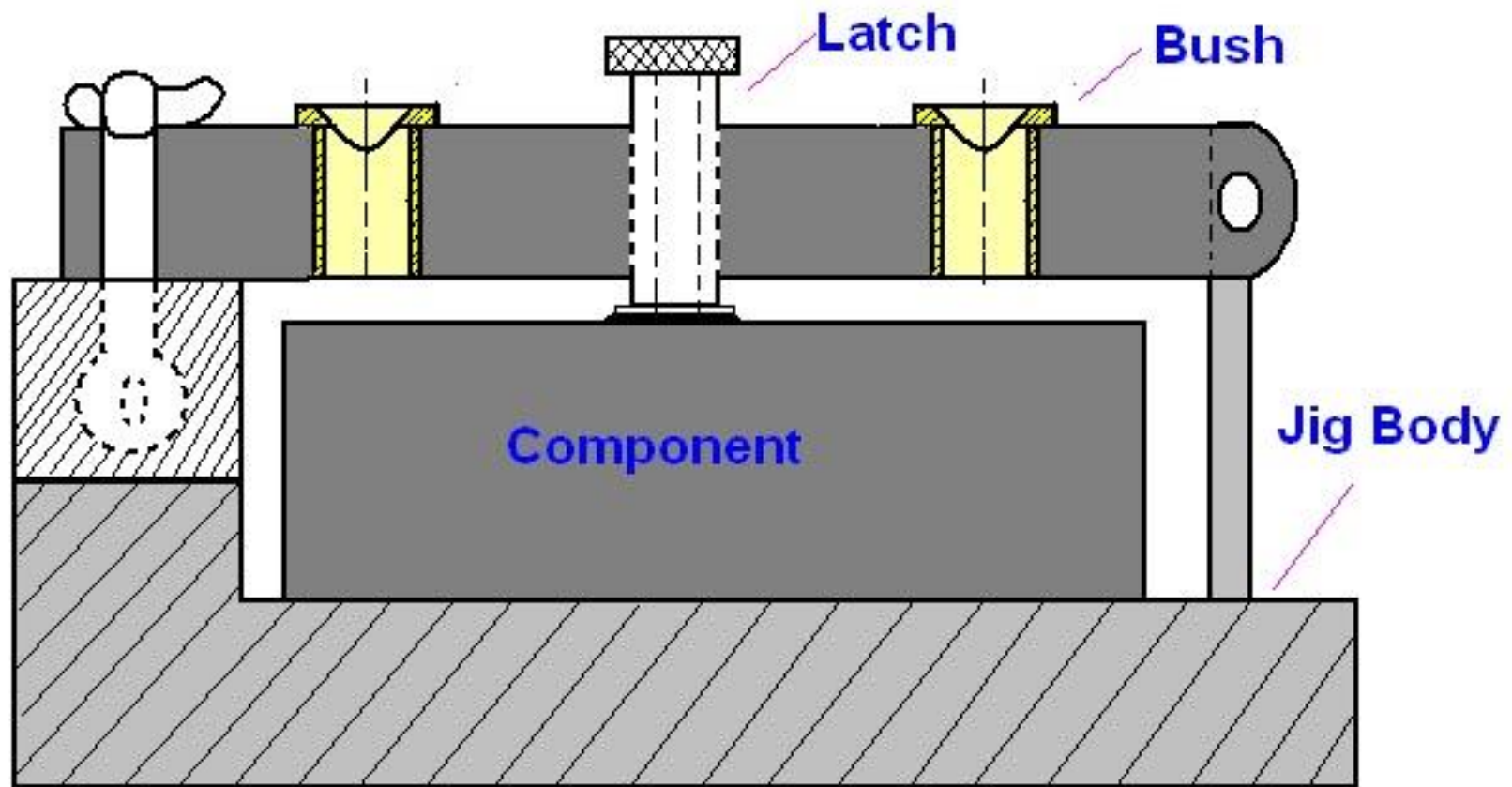

Leaf Jig

Box Type Jig

- When the holes are to drill
 - More than one plane of the work piece
 - The jig has to be provided with equivalent number of bush plates.
- For positioning jig on the machine table
 - Feet have to be provided opposite each drilling bush plate.
- One side of the jig will be provided with a swinging leaf
 - For loading and unloading the work piece
 - Take the form of a box.
- Jig should be as light as possible

Box type Jig

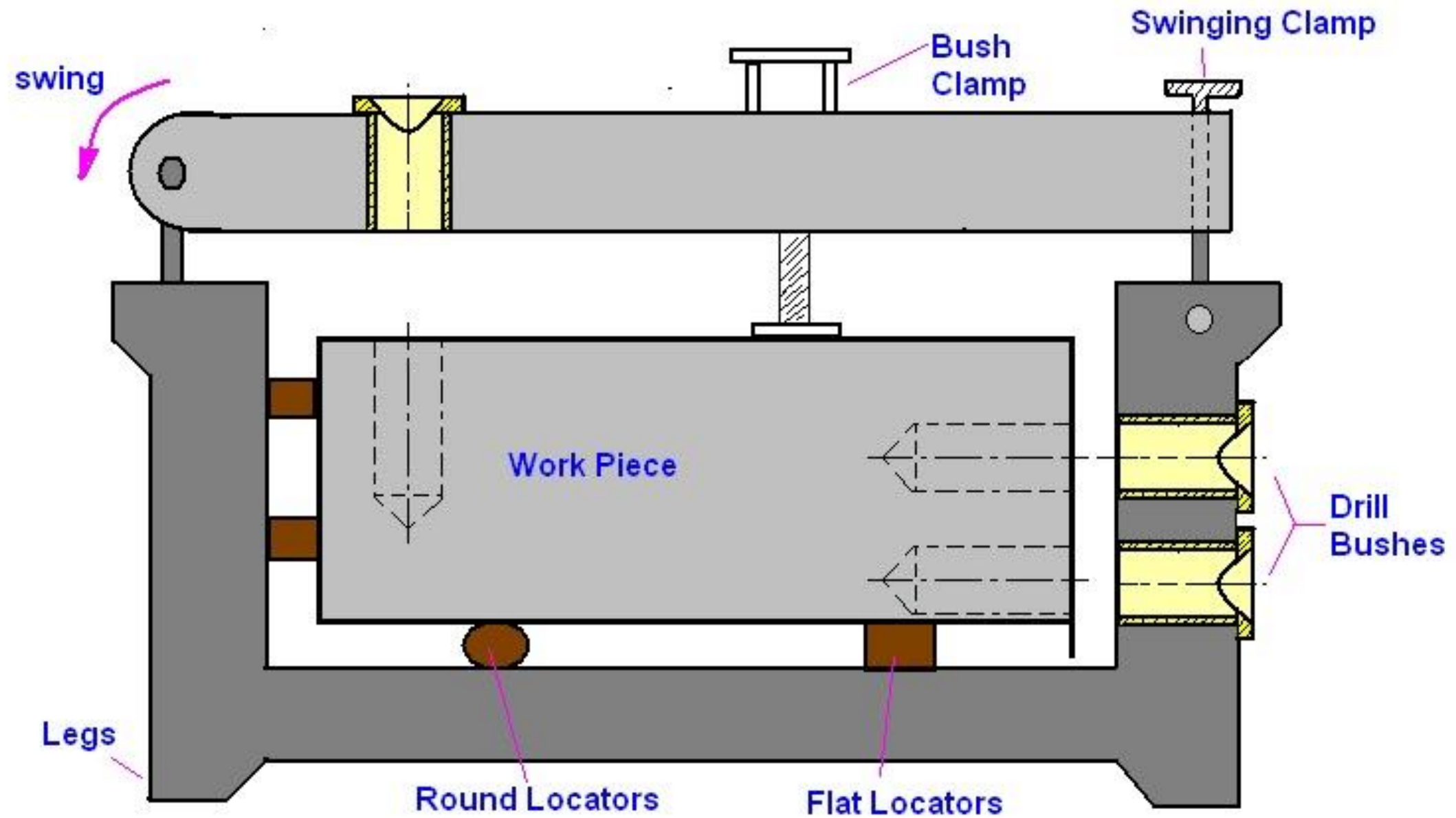

Types Of Fixtures

- Lathe Fixtures(Turning fixtures)
 - Three and four jaw chucks
 - Collets
 - Face plate
 - Mandrels
 - Machine vice
- Milling Fixtures

Lathe Fixtures

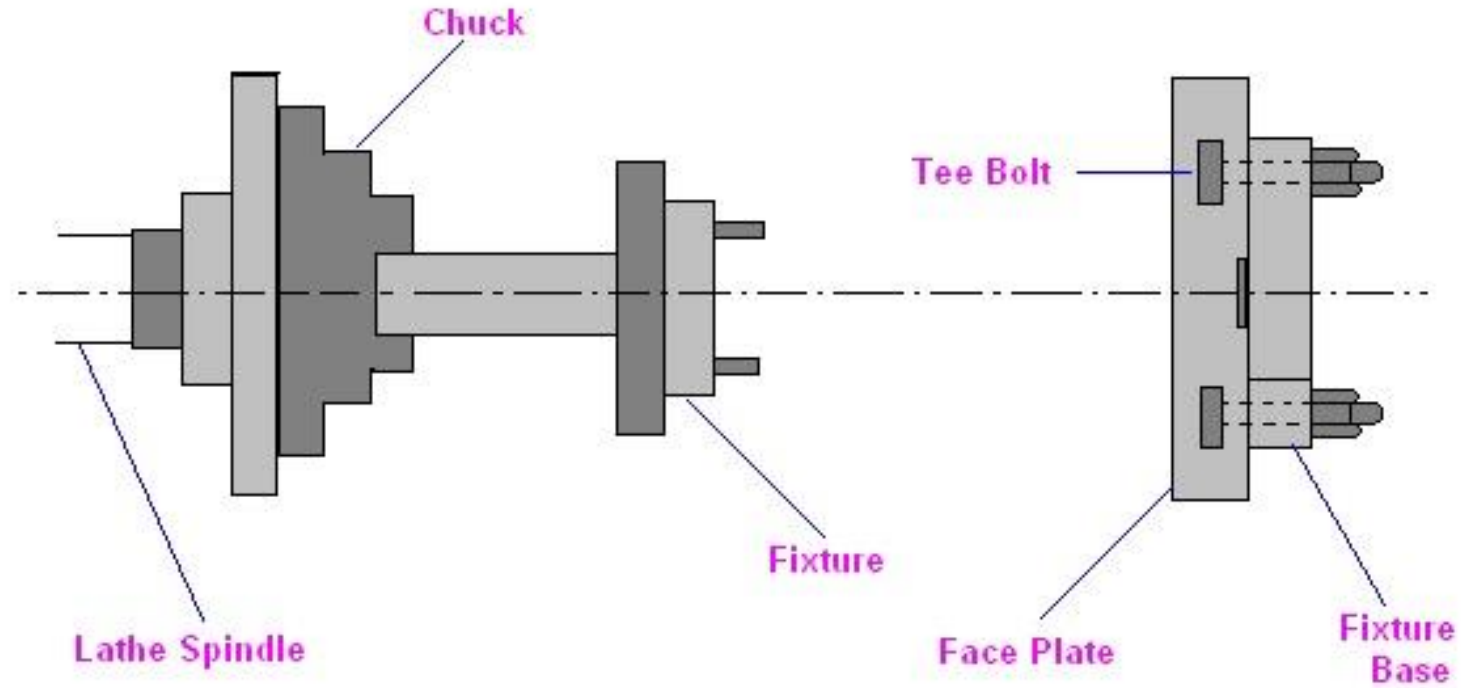

Grinding Fixtures

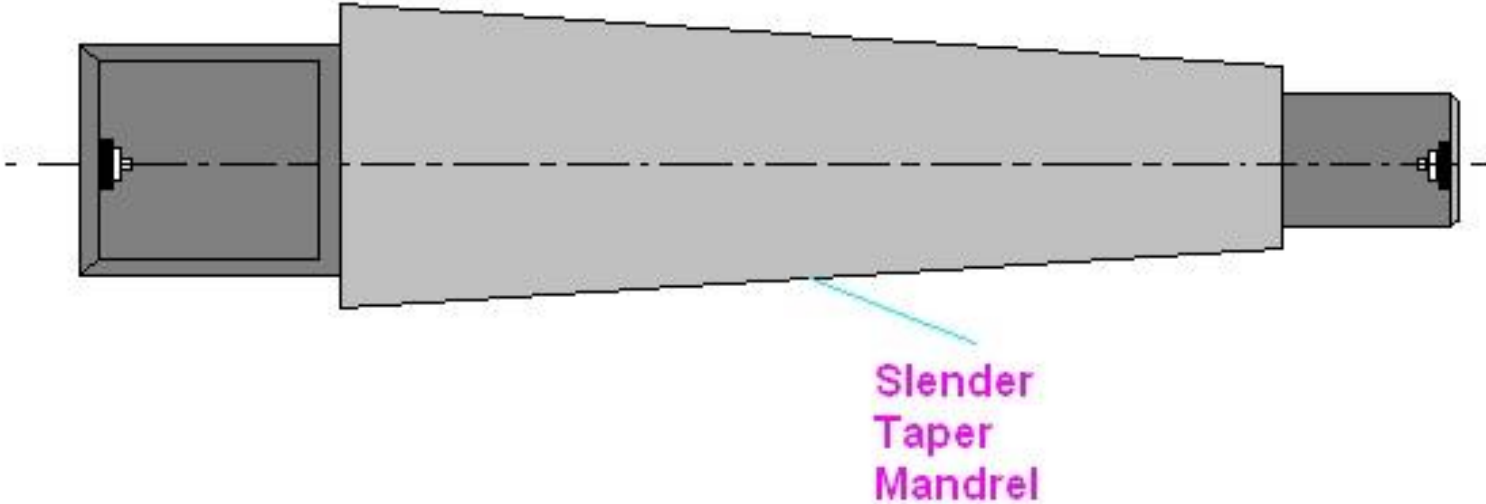

NC and CNC machines



NC

CNC

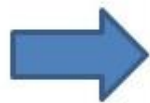

The various difference between NC and CNC machine in tabular form are as follows:

S. No.	NC Machine	CNC Machine
1.	Here NC stands for Numerical Control	CNC stands for Computer Numerical Control.
2.	It is defined as the machine which is controlled by the set of instructions in the form of numbers, letters and symbols. The set of instructions is called as program.	It is defined as the machine which is used to control the motions of the work piece and tool with the help of prepared program in computer. The program is written in alphanumeric data.

S. No.	NC Machine	CNC Machine
3.	In NC machine the programs are fed into the punch cards.	In CNC machine the programs are fed directly into the computer by a small key board similar to our traditional keyboard.
4.	Modification in the program is difficult.	Modification in the program is very easy.
5.	High skilled operator is required.	Less skilled operator is required.
6.	Cost of the machine is less.	Cost of the CNC machine is high.
7.	Maintenance cost is less	Maintenance cost is high.
8.	The programs in the NC machine cannot be stored.	In CNC machines, the programs can be stored in the computer and can be used again and again.

S. No.	NC Machine	CNC Machine
9.	It offers less flexibility and computational capability.	It offers additional flexibility and computational capability.
10.	The accuracy is less as compared with the CNC.	It has high accuracy.
11.	It requires more time for the execution of the job.	It takes very less time in the execution of the job.
12.	It is not possible to run it continuously.	It can be run continuously for 24 hours of a day.

The comparison of NC and CNC machine are:

- NC stands for Numerical Control whereas CNC stands for Computer Numerical Control.
- In NC Machine the programs are fed into the punch cards. But in CNC machine the programs are fed directly into the computer with the help of a small keyboard similar to our traditional keyboard.
- In NC machine if an error occurs in the program than its debugging and modification is not easy. In CNC machine the debugging and modification is very easy.

Cont.....

- High skilled operator is required to operate the NC machine whereas to operate a CNC machine, a semiskilled operator may work.
- The cost of the NC machine is less as compared with the computer control machines.
- The maintenance cost of NC is less whereas it is costly in the case of CNC machine.
- No programs can be stored in the NC machine. In CNC machine, numbers of programs can be stored and can be used again and again for the production.

Cont.....

- The accuracy of the NC is less as compared with the CNC.
- In NC machine the execution of the job takes more time but the CNC machine executes the job without taking much time.
- NC cannot be run continuously for 24 hours but CNC machine can be run for 24 hours continuously.



CNC turning Lathe



CNC Milling



CNC Laser Cutting



CNC
PLASMA
cutting

Products of CNC machine tools



Elements of NC machines

- Program Instructions
- Machine Control Unit, MCU
- Processing Equipment

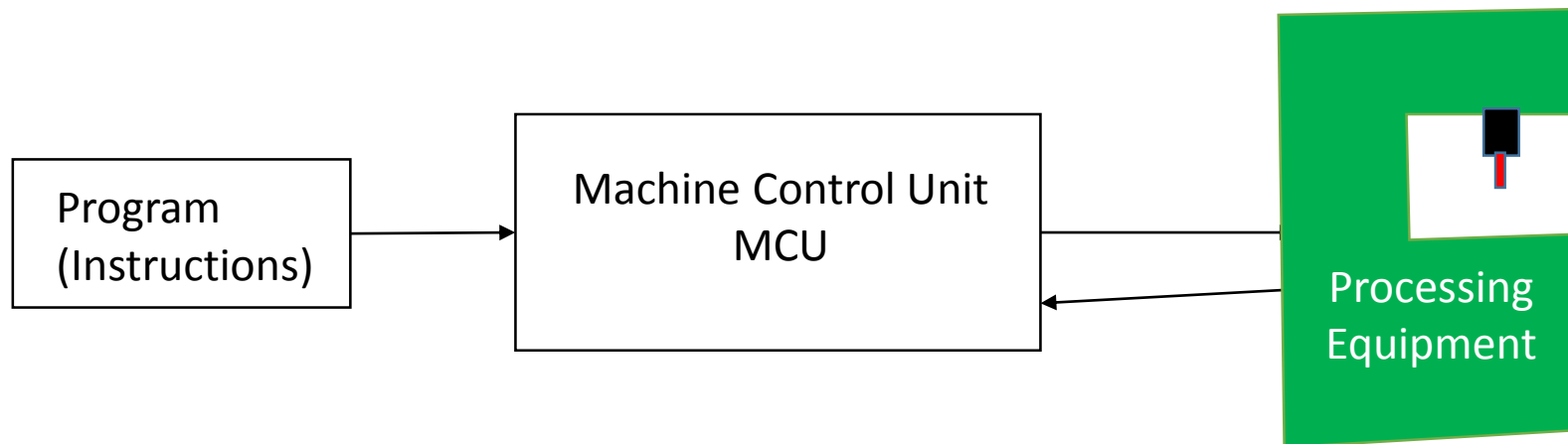

NC Coordinate system

- 2 axes system
 - One for flat and prismatic work piece
 - Other for rotational parts
 - Both axis systems are based on the Cartesian coordinate system

Informations needed for CNC machines

1. Preparatory Information: units, incremental or absolute positioning
2. Coordinates: X,Y,Z, RX,RY,RZ
3. Machining Parameters: Feed rate and spindle speed
4. Coolant Control: On/Off, Flood, Mist
5. Tool Control: Tool and tool parameters
6. Cycle Functions: Type of action required
7. Miscellaneous Control: Spindle on/off, direction of rotation, stops for part movement

This information is conveyed to the machine through a set of instructions arranged in a desired sequence – Program

Zero point and Target point

- The part programmer must decide where the origin of the coordinate axis system should be located.
- This decision is usually based on programming convenience.
- For example
 - One of the corners of the part. Or,
 - If the work piece is symmetrical, the zero point might be most conveniently defined at the centre of symmetry.

Motion Control Systems

- Point-to-point
- Continuous path

Point-to-point motion control system

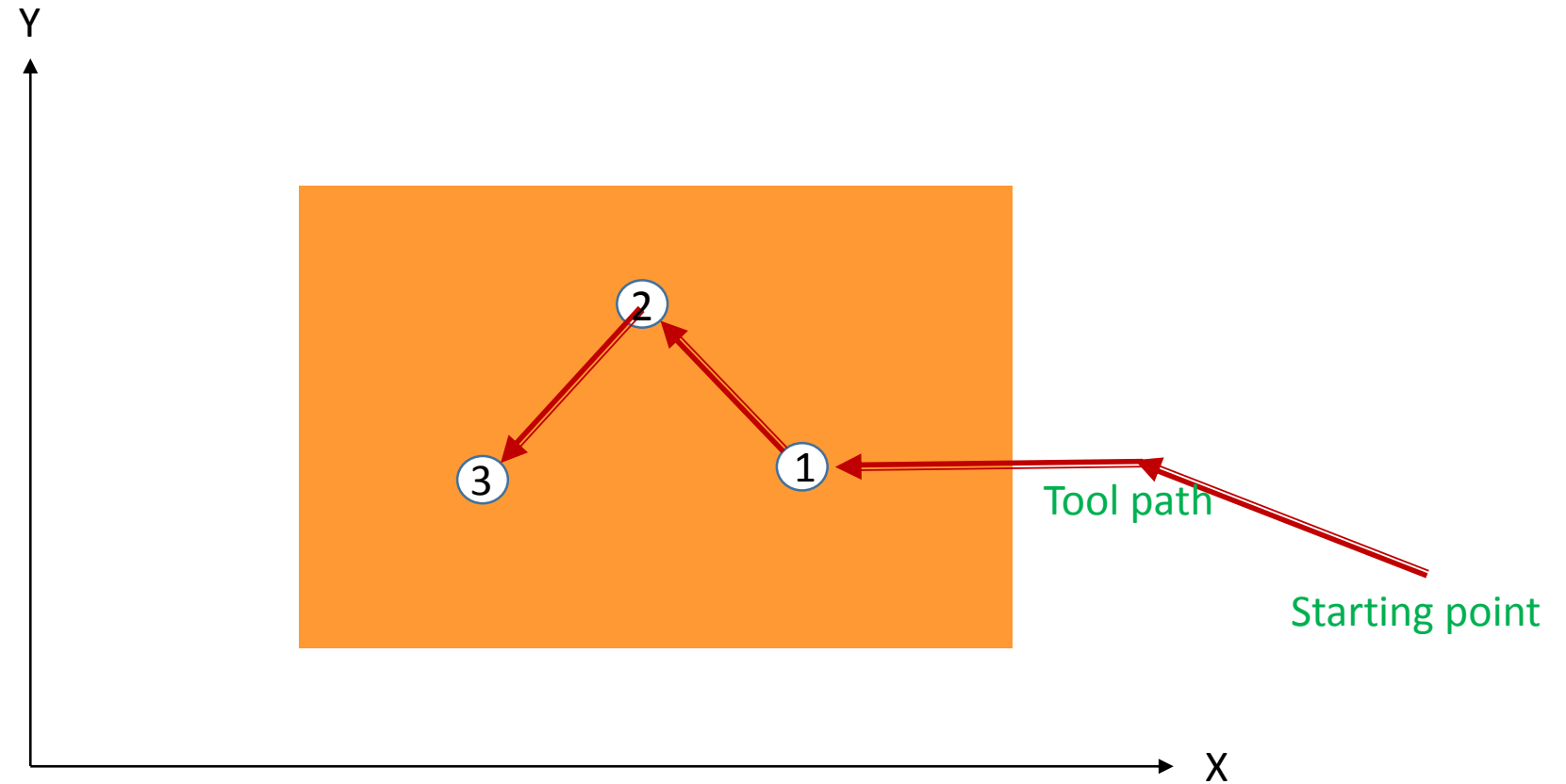

Continuous path motion control system

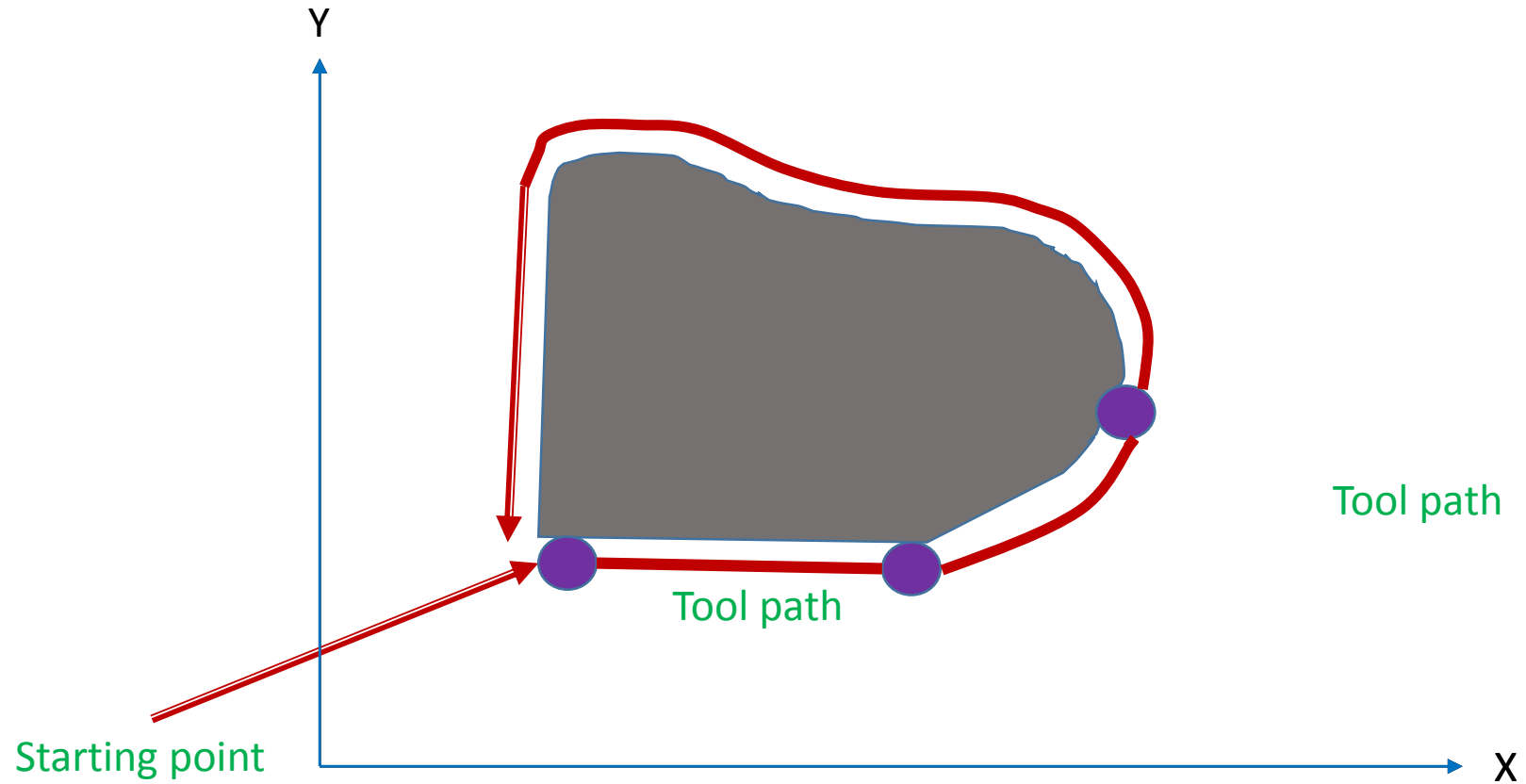

Absolute versus Incremental Positioning

- Positions are defined relative to the origin of the coordinate system or
- Relative to the previous location of the tool
- For example:
 - The work piece is presently at point (20, 20) and is to be moved to point (40, 50).
 - In absolute positioning, the move is specified by $x=40$, $y=50$
 - Whereas in incremental positioning, the move is specified by $x=20$, $y=30$.

Interpolation or contouring

Interpolation methods:

1. Linear interpolation (G01)
2. Circular interpolation (G02, G03)
3. Helical interpolation
4. Parabolic interpolation, and
5. Cubic interpolation.

G Codes for CNC machines

G170	Ø	Circular Pocket Canned Cycle
G171	Ø	Circular Pocket Canned Cycle
G172	Ø	Rectangular Pocket Canned Cycle
G173	Ø	Rectangular Pocket Canned Cycle

Code listing full and correct at the time of printing.

Note - Not all G codes apply to each machine.

G Code.	Group.	Function.
G00	1	Positioning (Rapid Traverse)
G01	1	Linear Interpolation (Cutting Feed)
G02	1	Circular Interpolation CW
G03	1	Circular Interpolation CCW
G04	0	Dwell, Exact Stop
G20	6	Imperial Data Input (Inches)
G21	6	Metric Data Input (Millimetres)
G28	0	Reference Point Return
G40	7	Cutter Compensation Cancel
G41	7	Cutter Compensation Left
G42	7	Cutter Compensation Right
G73	9	High Speed Peck Drilling Cycle
G74	9	Counter Tapping Cycle
G76	9	<i>Fine Boring Cycle(not recommended on Denford Machines)</i>
G80*	9	Canned Cycle Cancel
G81	9	Drilling Cycle, Spot Boring
G82	9	Drilling Cycle, Counter Boring
G83	9	Deep Hole Peck Drilling Cycle
G84	9	Tapping Cycle
G85	9	Boring Cycle
G86	9	Boring Cycle
G87	9	<i>Back Boring Cycle(not recommended on Denford Machines)</i>
G89	9	Boring Cycle
G90*	3	Absolute Zero Command
G91	3	Incremental Command
G94*	5	Feed per Minute
G95	5	Feed per Revolution
G98*	10	Return to Initial Level in Canned Cycle
G99	10	Return to R Point Level in Canned Cycle

G-FUNCTION

STANDARD G CODE	SPECIAL G CODE	GROUP	FUNCTION
#G00 G01 G02 G03	G00 G01 G02 G03	01	Positioning (Rapid feed) Straight interpolation Circular interpolation (CW) Circular interpolation (CCW)
G04	G04	00	Dwell
G20 #G21	G20 G21	06	Data input (inch) Data input (mm)
#G22 G23	G22 G23	04	Stored distance limit is effective (Spindle interference check ON) Stored distance limit is ineffective (Spindle interference check OFF)
G27 G28 G29 G30	G27 G28 G29 G30	00	Machine reference return check Automatic reference return Return from reference Tie 2nd reference return
#G32	G33	01	Thread process
G40 G41 G42	G40 G41 G42	07	Cancel of compensation Compensation of the left Compensation of right
G50 G70 G71 G72 G73 G74 G75 G76	G92 G70 G71 G72 G73 G74 G75 G76	00	Creation of virtual coordinate/Setting the rotating time of principal spindle Compound repeat cycle(Finishing cycle) Compound repeat cycle(Stock removal in turning) Compound repeat cycle(Stock removal in facing) Compound repeat cycle(Pattern repeating cycle) Compound repeat cycle(Peck drilling in Z direction) Compound repeat cycle(Grooving in X direction) Compound repeat cycle(Thread process cycle)
G90 G92 G94	G77 G78 G79	01	Fixed cycle(Process cycle in turning) Fixed cycle(Thread process cycle) Fixed cycle(Facing process cycle)
G96 #G97	G96 #G97	02	Control the circumference speed uniformly(mm/min) Cancel the uniform control of circumference speed. Designate r.p.m
G98 #G99	G94 #G95	05	Designate the feedrate per minute(mm/min) Designate the feedrate per the rotation of principal spindle(mm/rev.)
- -	G90 G91	03	Absolute programming Incremental programming

Note) 1 # mark instruction is the modal indication of initial condition which is immediately available.

Note - Not all M codes apply to each machine.

M code.	Function.
M00*	Program Stop
M01*	Optional Stop
M02*	Program Reset
M03	Spindle Forward (clockwise)
M04	Spindle Reverse (counter clockwise)
M05*	Spindle Stop
M06	Automatic Tool Change
M08	Coolant On
M09*	Coolant Off
M10	Vice/Work Clamp Open
M11	Vice/Work Clamp Close
M13	Spindle Forward and Coolant On
M14	Spindle Reverse and Coolant On
M19	Spindle Orientation
M20	ATC Arm In
M21	ATC Arm Out
M22	ATC Arm Down
M23	ATC Arm Up
M24	ATC Drawbar Unclamp
M25	ATC Drawbar Clamp
M27	Reset Carousel to Pocket One
M30*	Program Reset and Rewind
M32	Carousel CW
M33	Carousel CCW
M38	Door Open
M39	Door Close
M62	Auxiliary Output 1 On
M63	Auxiliary Output 2 On

M Codes for CNC machines

continued....

M code.	Function.
M64	Auxiliary Output 1 Off
M65	Auxiliary Output 2 Off
M66*	Wait for Auxiliary Output 1 On
M67*	Wait for Auxiliary Output 2 On
M70	Mirror in X On
M71	Mirror in Y On
M76	Wait for Auxiliary Output 1 Off
M77	Wait for Auxiliary Output 2 Off
M80	Mirror in X Off
M81	Mirror in Y Off
M98	Sub Program Call
M99	Sub Program End and Return

Code listing full and correct at the time of printing.

NC LATHE M-CODE LIST

M-CODE	DESCRIPTION	REMARK	M-CODE	DESCRIPTION	REMARK
M00	PROGRAM STOP		M39	STEADY REST 1 UNCLAMP	OPTION
M01	OPTIONAL STOP		M40	GEAR CHANGE NETURAL	
M02	PROGRAM END		M41	GEAR CHANGE LOW	
M03	MAIN-SPINDLE FORWARD		M42	GEAR CHANGE MIDDLE	
M04	MAIN-SPINDLE REVERSE		M43	GEAR CHANGE HIGH	
M05	MAIN-SPINDLE STOP		M46	PTS BODY UNCL & TRACT-BAR ADV.	OPTION
M07	HIGH PRESSURE COOLANT ON	OPTION	M47	PTS BODY CL & TRACT-BAR RET.	OPTION
M08	COOLANT ON		M50	BAR FEEDER COMMAND 1	OPTION
M09	COOLANT OFF		M51	BAR FEEDER COMMAND 2	OPTION
M10	PARTS CATCHER ADVANCE	OPTION	M52	SPLASH GUARD DOOR OPEN	OPTION
M11	PARTS CATCHER RETRACT	OPTION	M53	SPLASH GUARD DOOR CLOSE	OPTION
M13	TURRET AIR BLOW	OPTION	M54	PARTS COUNT	OPTION
M14	MAIN-SPINDLE AIR BLOW	OPTION	M58	STEADY REST 2 CLAMP	OPTION
M15	AIR BLOW OFF	OPTION	M59	STEADY REST 2 UNCLAMP	OPTION
M17	MACHINE LOCK ACT	(ONLY) MDI	M61	SWITCHING LOW SPEED (N.J)	☒ P60
M18	MACHINE LOCK CANCEL	(ONLY) MDI	M62	SWITCHING HIGH SPEED (N.J)	☒ P60
M19	MAIN-SPINDLE ORIENTAION	OPTION	M63	MAIN-SPDL CW & COOLANT ON	
M24	CHIP CONVEYDR RUN	OPTION	M64	MAIN-SPDL CCW & COOLANT OFF	
M25	CHIP CONVEYDR STOP	OPTION	M65	MAIN-SPDL & COOLANT OFF	
M30	PROGRAM END & REWIND		M66	DUAL CHUCKING LOW CLAMP	OPTION
M31	INTERLOCK BY-PASS(SPDL & T/S)		M67	DUAL CHUCK HIGH CLAMP	OPTION
M32	INTERLOCK BY-PASS(SPDL & S/R)	3 AXIS	M68	MAIN-CHUCK CLAMP	
M33	REV.-TOOL-SPINDLE FORWARD	3 AXIS	M69	MAIN-CHUCK UNCLAMP	
M34	REV.-TOOL-SPINDLE REVERSE		M70	DUAL TAILSTOCK LOW ADVANCE	OPTION
M35	REV.-TOOL-SPINDLE STOP		M74	ERROR DETECT ON	
M38		OPTION	M75	ERROR DETECT OFF	

NC LATHE M-CODE LIST

M-CODE	DESCRIPTION	REMARK	M-CODE	DESCRIPTION	REMARK
M76	CLAMFERING ON		M131	INTERLOCK BY-PASS (SUB-SPDL)	
M77	CLAMFERING OFF		M163	SUB-SPDL CW & COOLANT ON	
M78	TAILSTOCK QUILL ADVANCE		M164	SUB-SPDL CCW & COOLANT OFF	
M79	TAILSTOCK QUILL RETRACT		M165	SUB-SPDL & COOLANT STOP	
M80	Q-SETTER SWING ARM DOWN	OPTION	M168	SUB-CHUCK CLAMP	
M81	Q-SETTER SWING ARM UP	OPTION	M169	SUB-CHUCK UNCLAMP	
M84	TURRET CW ROTATION		M203	FORWARD SYNCHRONOUS COM.	
M85	TURRET CCW ROTATION		M204	REVERSE SYNCHRONOUS COM.	
M86	TORQUE SKIP ACT	B AXIS	M205	SYNCHRONOUS STOP	
M87	TORQUE SKIP CANCEL	B AXIS	M206	SPINDLE ROTATION RELEASE	
M88	SPINDLE LOW CLAMP				
M89	SPINDLE HIGH CLAMP				
M90	SPINDLE UNCLAMP				
M91	EXTERNAL M91 COMMAND	3 AXIS			
M92	EXTERNAL M92 COMMAND	3 AXIS			
M93	EXTERNAL M93 COMMAND				
M94	EXTERNAL M94 COMMAND	OPTION			
M98	SUB-PROGRAM CALL	OPTION			
M99	END OF SUB-PROGRAM	OPTION			
M103	SUB-SPINDLE FORWARD				
M104	SUB-SPINDLE REVERSE				
M105	SUB-SPINDLE STOP				
M110	PARTS CATCHER ADVANCE(SUB)	OPTION			
M111	PARTS CATCHER RETRACT(SUB)	OPTION			
M114	SUB-SPINDLE AIR BLOW	OPTION			
M119	SUB-SPINDLE ORIENTATION	OPTION			

Programming for CNC Lathe

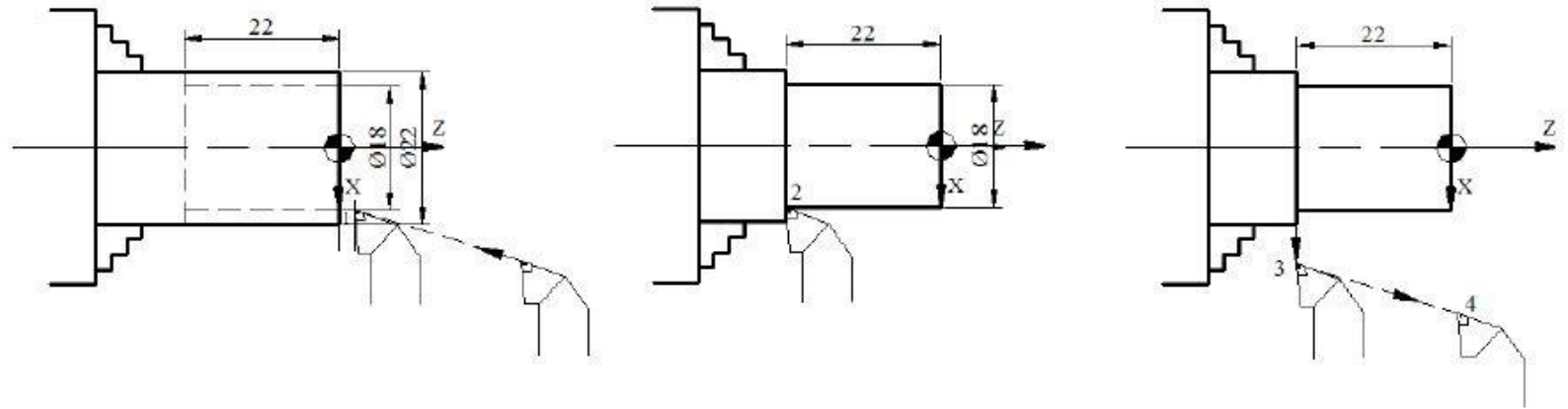

%

```
N10 T104 M06  
N20 G97 S2000 G95 F0.1 M03  
N30 G00 X18 Z2 M08  
N40 G01 Z-22 N50 G01 X26  
N60 G00 X200 Z200 M09  
N70 M30
```

%

%

```
N10 T104 M06  
N20 G97 S2000 G95 F0.1 M03  
N30 G00 X18 Z2 M08  
N40 G01 Z-22  
N50 G01 X26  
N60 G00 X200 Z200 M09  
N70 M30
```

%

Explanations:

N – Block number

T – Tool used

M06 – Tool change

G97 – Spindle speed in RPM

G95 – Feed mm/revolution

F – feed

M03 - Circular interpolation

G00 – Rapid traverse

X, Z – X, Z axes

M08 – Coolant on

G01 – Linear interpolation

M09 – Coolant off

M30 – Program End & Rewind

Programming for CNC Lathe

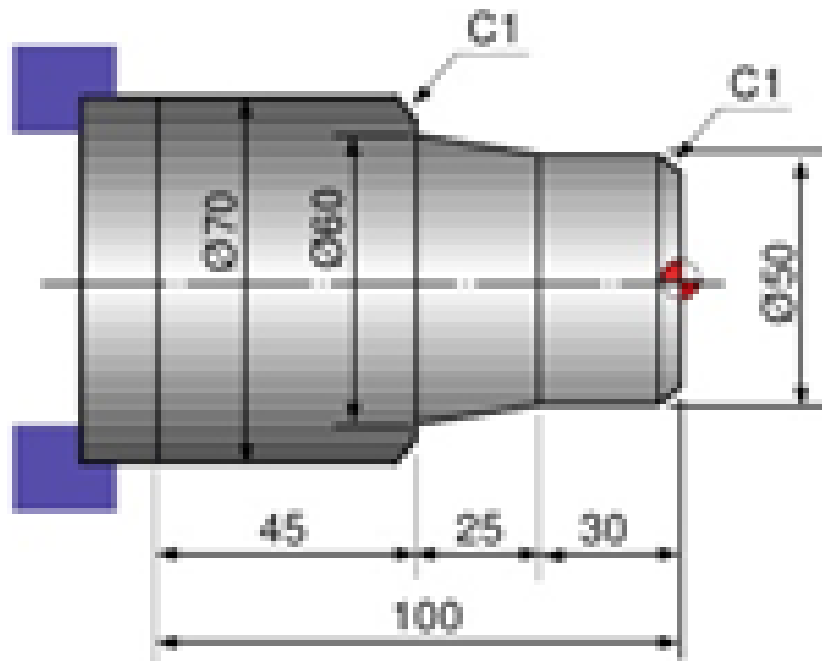

```

O0002 :
  N10 G50 S2000 T0100 :
    G96 S180 M03 :
    G00 X70.5 Z5.0 T0101 M08 :
    G01 Z-100.0 F0.25 :
    G00 U2.0 Z0.5 :
    G01 X-1.6 F0.23 :
    G00 X65.0 W1.0 :
    G01 Z-54.5 F0.25 :
    G00 U2.0 Z1.0 :
      X60.0 :
    G01 Z-54.5 :
    G00 U2.0 Z1.0 :
      X55.0 :
    G01 Z-30.0 :
      X60.0 Z-54.5 :
    G00 U2.0 Z1.0 :
      X50.5 :
    G01 Z-30.0 :
      X60.3 Z-54.7 :
      X72.0
    G00 X150.0 Z200.0 T0100 :
    M01 :
  N20 G50 S2300 T0300 :
    G96 S200 M03 :
    G00 X55.0 Z5.0 T0303 M08 :
      Z0 :
    G01 X-1.6 F0.2 :
    G00 X46.0 Z3.0 :
    G42 Z1.0 :
    G01 X50.0 Z-1.0 F0.15 :
      Z-30.0 :
      X60.0 Z-55.0 :
      X68.0 :
      X70.0 W-1.0 :
      Z-100.0 :
    G40 U2.0 W1.0
    G00 X150.0 Z200.0 M09 T0300 :
    M30 :
  
```

References

<http://www.philadelphia.edu.jo/academics/aateyat/uploads/4.pdf>

Non conventional machining processes

Electro-chemical machining (ECM)





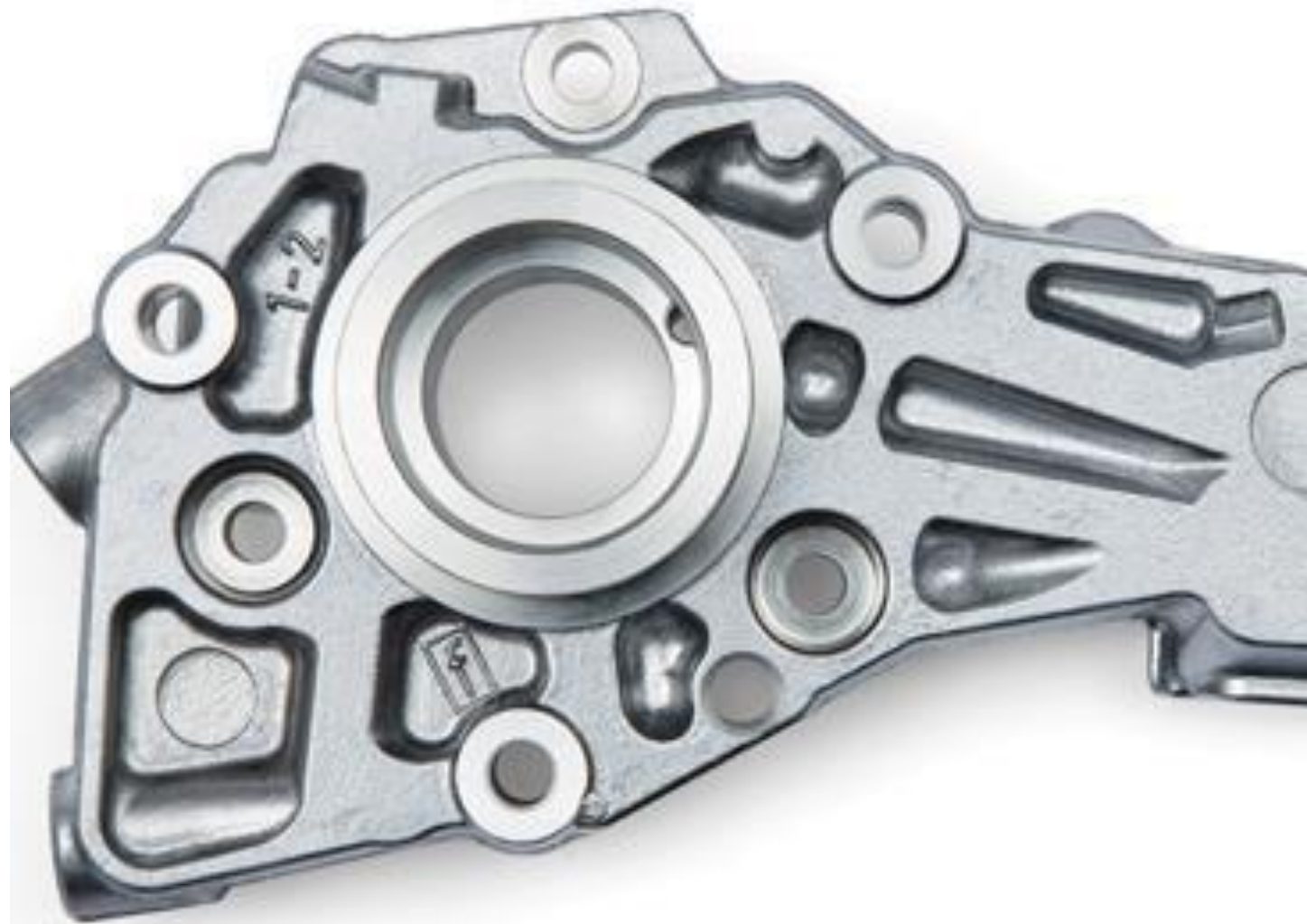







Advantages

- Low-level tool wear (cathode), an ideal precondition for batch production
- Surface finishes
 - Up to Ra 0.05
- Precision machining
- No thermal and mechanical effects
 - therefore, no changes in the material properties
- Hardness, toughness and magnetic qualities of the material remain unchanged
- Possibility to machine diminutive and thin-walled contours
- A high degree of repeat accuracy in the machining of the surface structure
- Simple but highly efficient production process
 - no need for subsequent deburring or polishing
- Rough-machining, finish-machining and polishing in a single operation
- Possibility to machine superalloys
- Possibility to simultaneously machine macro and micro structures

Disadvantages

- High energy consumption.
- Non conducting material cannot be machined.
- Corrosion and rust of ECM machine can be hazardous
 - But preventive measures can help in this regard.

Electrochemical machining equipment

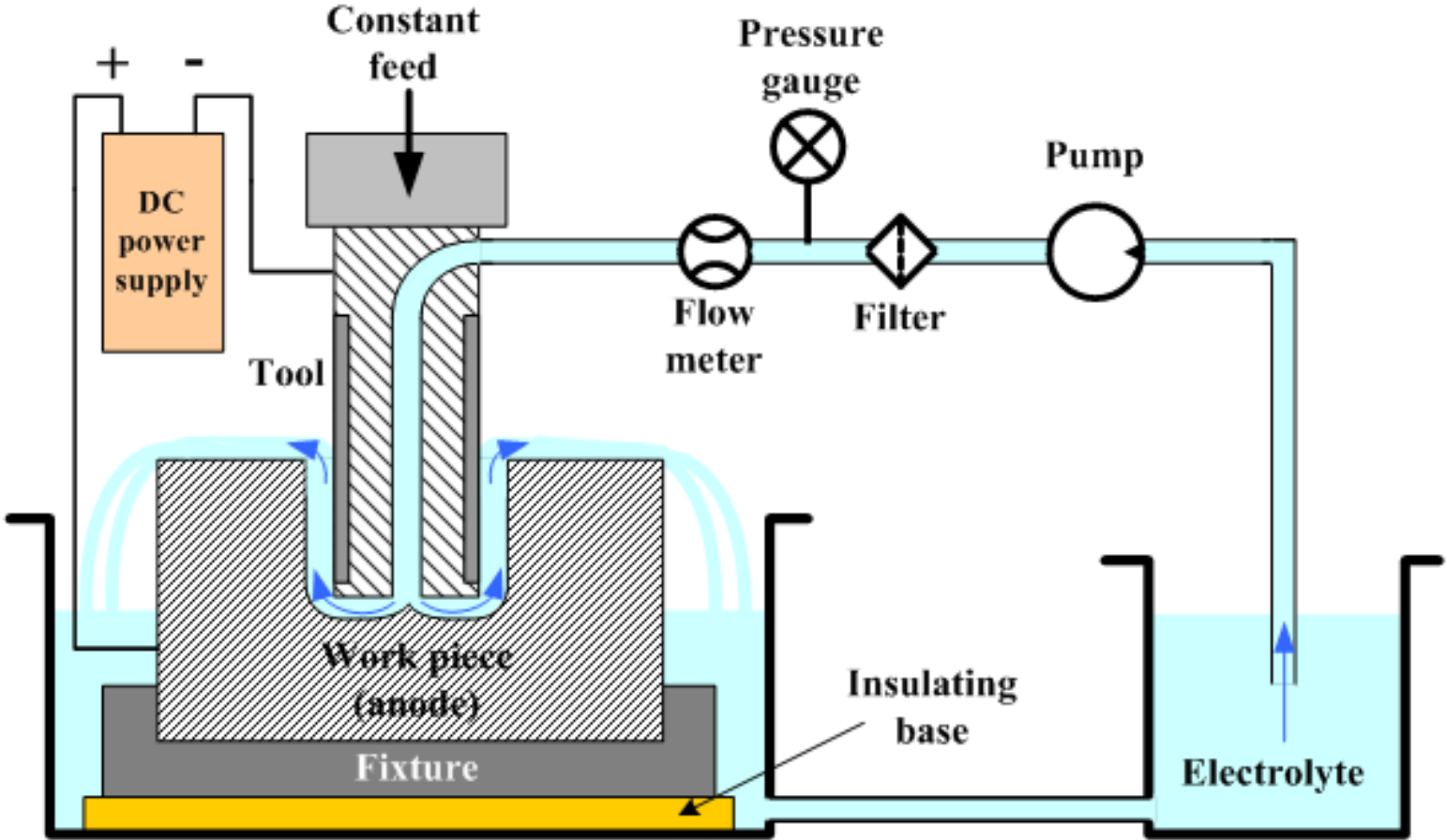

ELECTROCHEMICAL MACHINING

Reverse of Electroplating

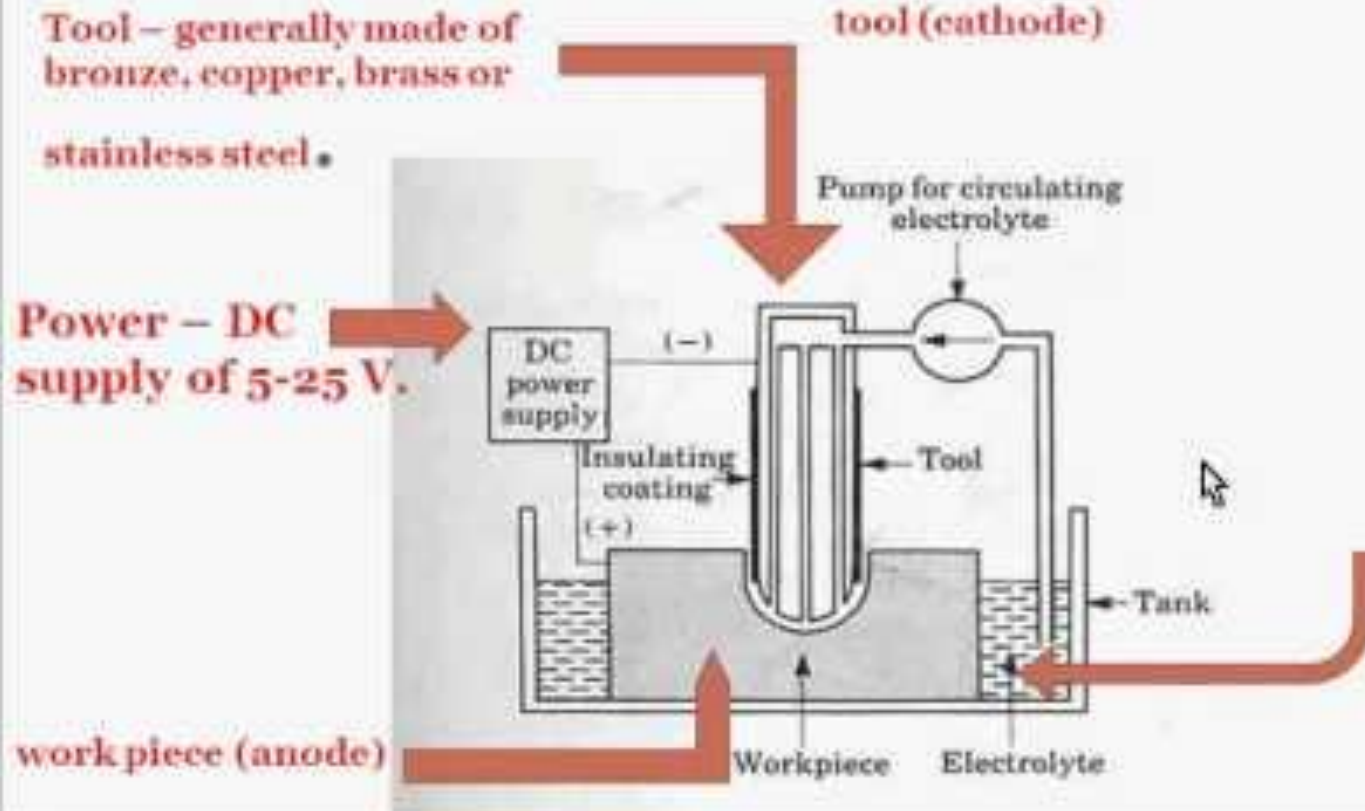

Electrochemical machining process

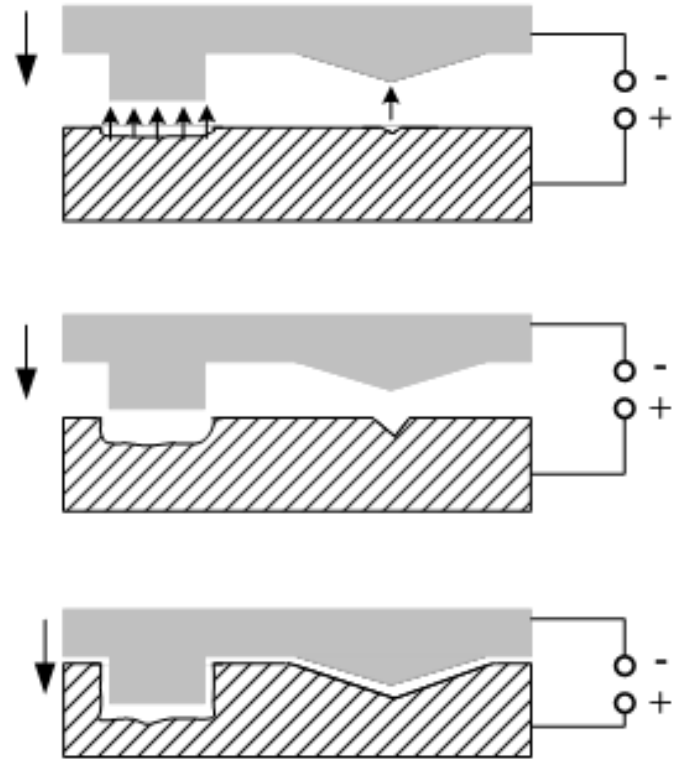
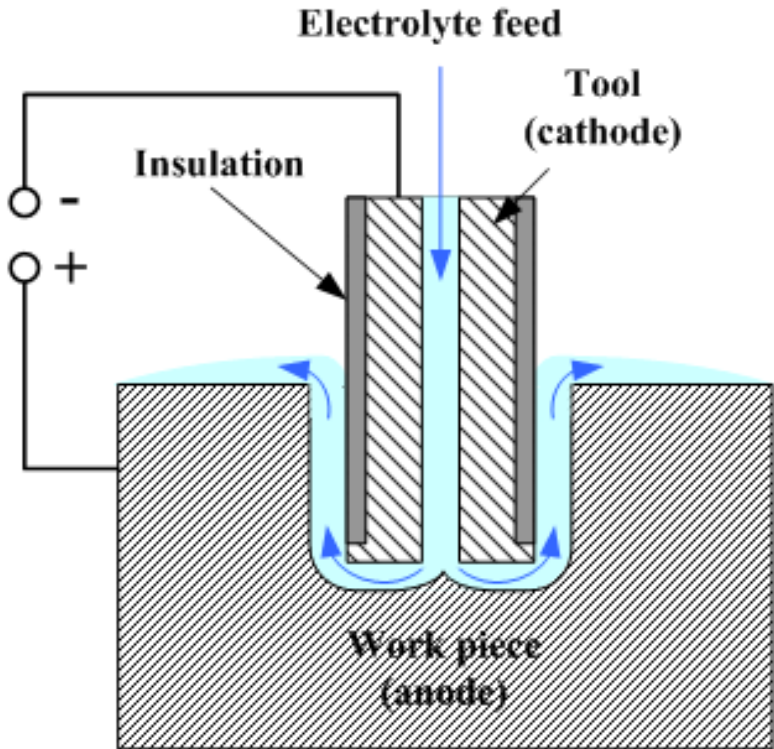

www.substech.com

Introduction

- ❖ Electrochemical Machining (ECM) is one of the newest and most useful non-traditional machining (NTM) process belonging to Electrochemical category.
- ❖ Electrochemical machining (ECM) is used to remove metal and alloys which are difficult or impossible to machine by mechanical machining process.
- ❖ The reverse of electroplating.
- ❖ This machining process is based Michael Faraday's classical laws of electrolysis, requiring basically two electrodes, an electrolyte, a gap and a source of D.C power of sufficient capacity.

Electro-Chemical Machining (ECM)

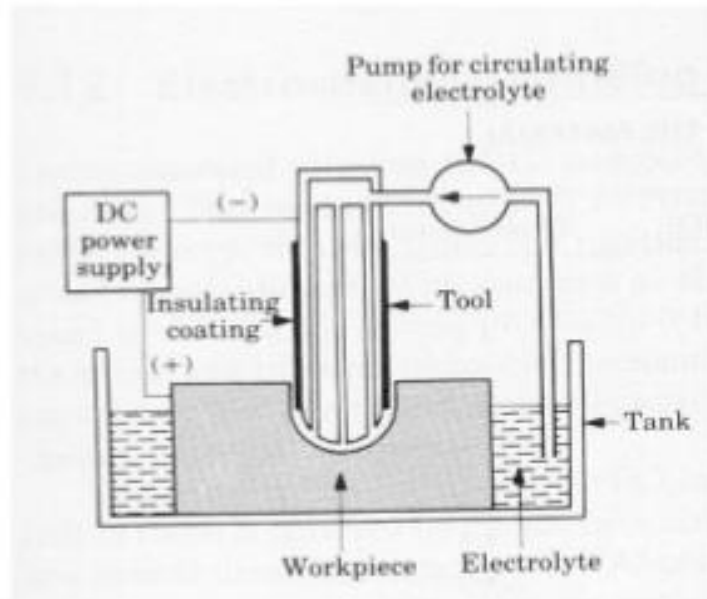

- Works on the principle of electrolysis
- Die is progressively lowered into workpiece as workpiece is dissociated into ions by electrolysis
- Electrolytic fluid flows around workpiece to remove ions and maintain electrical current path
- Low DC voltage, very High current (700 amps).
- Material removal rate is 2.5-12 mm/min depending on current density.

Principle

- Faraday's law of electrolysis :
The Weight of the substance produced during electrolysis process is directly proportional to
 1. the current which passes
 - 2.the length of time of process
 - 3.The equivalent weight of the material
- Two dissimilar metals are in contact with an electrolyte and anode loses metal to cathode

Electrochemical Machining (ECM)

- Electrochemical machining is one of the most unconventional machining processes.
- The process is actually the reverse of electroplating with some modifications.
- It is based on the principle of electrolysis.
- In a metal, electricity is conducted by free electrons but in a solution the conduction of electricity is achieved through the movement of ions.
- Thus the flow of current through an electrolyte is always accompanied by the movement of matter.
- In the ECM process the work-piece is connected to a positive electrode and the tool to the negative terminal for metal removal.
- The figure below shows a suitable work-piece and a suitably shaped tool, the gap between the tool and the work being full of a suitable electrolyte.

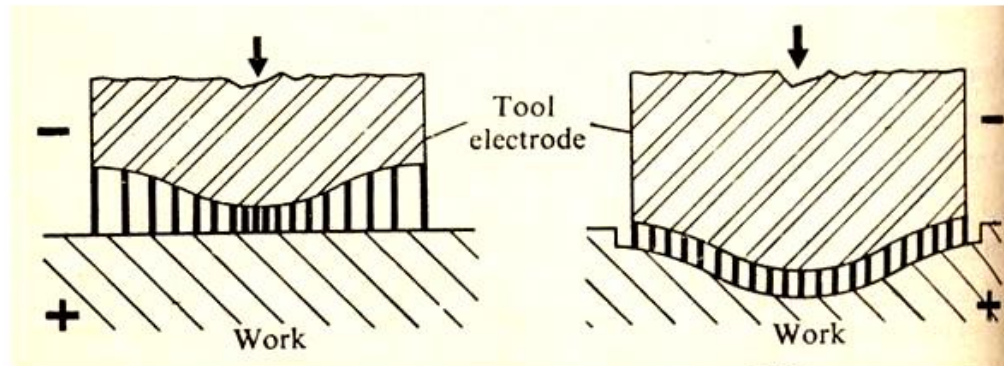

Electrochemical Machining (ECM)

- Work-piece is connected to
 - Positive (+ve)
- Tool is connected to
 - Negative (-ve)
- Current density is
 - Inversely proportional to gap
- Gap is
 - 0.1 to 0.2 mm
- Energy required
 - 30 times the conventional process
- MRR is
 - Independent of work piece hardness
- Tool and work are subjected
 - Large force exerted by high fluid pressure

Electro chemistry of ECM

- Faraday's law of electrolysis
 - The amount of chemical change produced by an electric current i.e. the amount of any material dissolved or deposited , is proportional to the quantity of electricity passed.
 - The amounts of different substances dissolved or deposited by the same quantity of electricity are proportional to their chemical equivalent weight

Mathematically

- $m \rightarrow It\epsilon$
- Or,

$$m = It\epsilon/F$$

where

m = weight (in grams) of a material dissolved or deposited

I = current (in amperes)

t = time (in Seconds)

ϵ = gram equivalent weight of the material

F = Faraday constant

=96,500 coulombs

Also as

$$\text{MRR} = \dot{m} = \frac{IA}{FZ}$$

Where,

F = faraday's constant = 96,500 Columns = 26.8 amp-hours

I = current flowing in amperes,

Z = Valances of metal dissolved,

A = atomic weight of material in grams,

MRR = Material removal rate in grams per second.

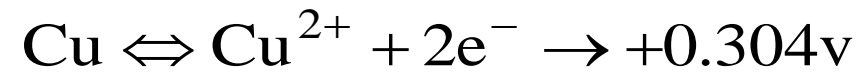

Difference between electrode potential
= 0.713 v

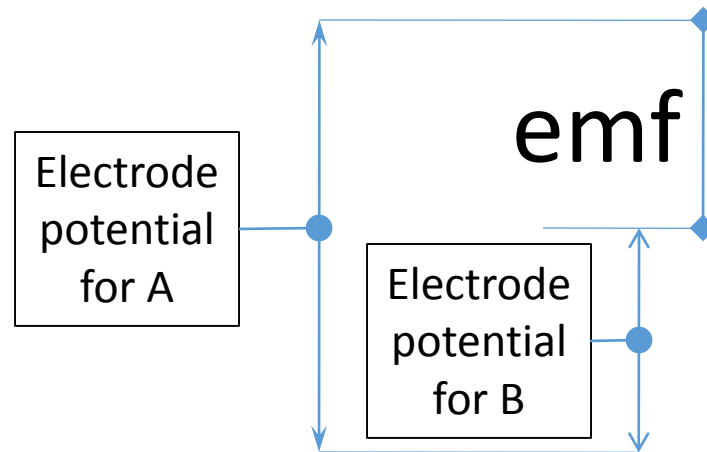

Fig. Cell emf

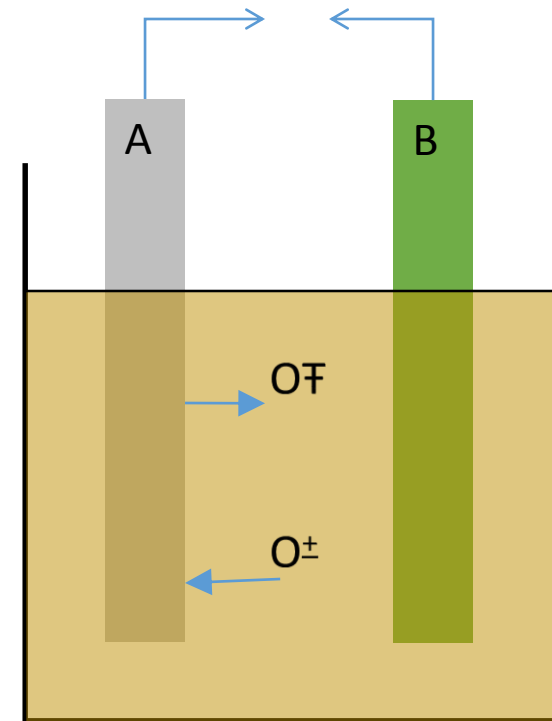
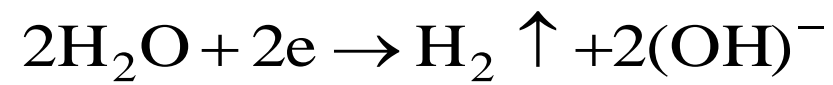

Fig. (a). Material dissolution
and deposition

Realization of ECM

- Aqueous solution of NaCl
 - The electrolyte
- Voltage difference applied
 - Across electrodes
- Reactions
 - at anode
 - At cathode $\text{Fe} \rightarrow \text{Fe}^{2+} + 2e$



Cont-----

- +ve metal ions move towards cathode
- -ve hydroxyl ions move towards anode
- Form ferrous hydroxide

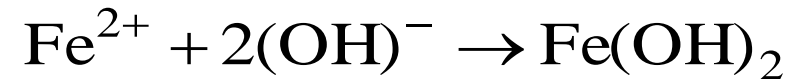

- Ferrous hydroxides form insoluble ppts
- H₂ is generated at cathode
- In ECM, proper choice of
 - Electrodes
 - ElectrolyteBe such that
- No deposition at either electrode can take place

Cont-----

- When anode is an alloy with
 - Atomic weight of
 - A_1, A_2, A_3, \dots
 - Valencies
 - Z_1, Z_2, Z_3, \dots
 - Composition (by weight)
 - $x_1\%, x_2\%, x_3\%, \dots$
 - Mass(m_i) of element x_i in v volume of alloy of density ρ is:

$$m_i = \frac{v \rho x_i}{100} \text{ gram}$$

Metal	Atomic weight	Valency of dissolution	Specific gravity
Aluminium	26.97	3	2.67
Chromium	51.99	2/3/6	7.19
Cobalt	58.93	2/3	8.85
Copper	63.57	1/2	8.96
Iron	55.85	2/3	7.86
Nickel	58.71	2/3	8.90
Tin	118.69	2/4	7.30
Titanium	47.9	3/4	4.51
Tungsten	183.85	6/8	19.3
Zinc	65.37	2	7.13
Silicon	28.09	4	2.33
Manganese	54.94	2/4/6/7	7.43

Electric discharge machining (EDM)

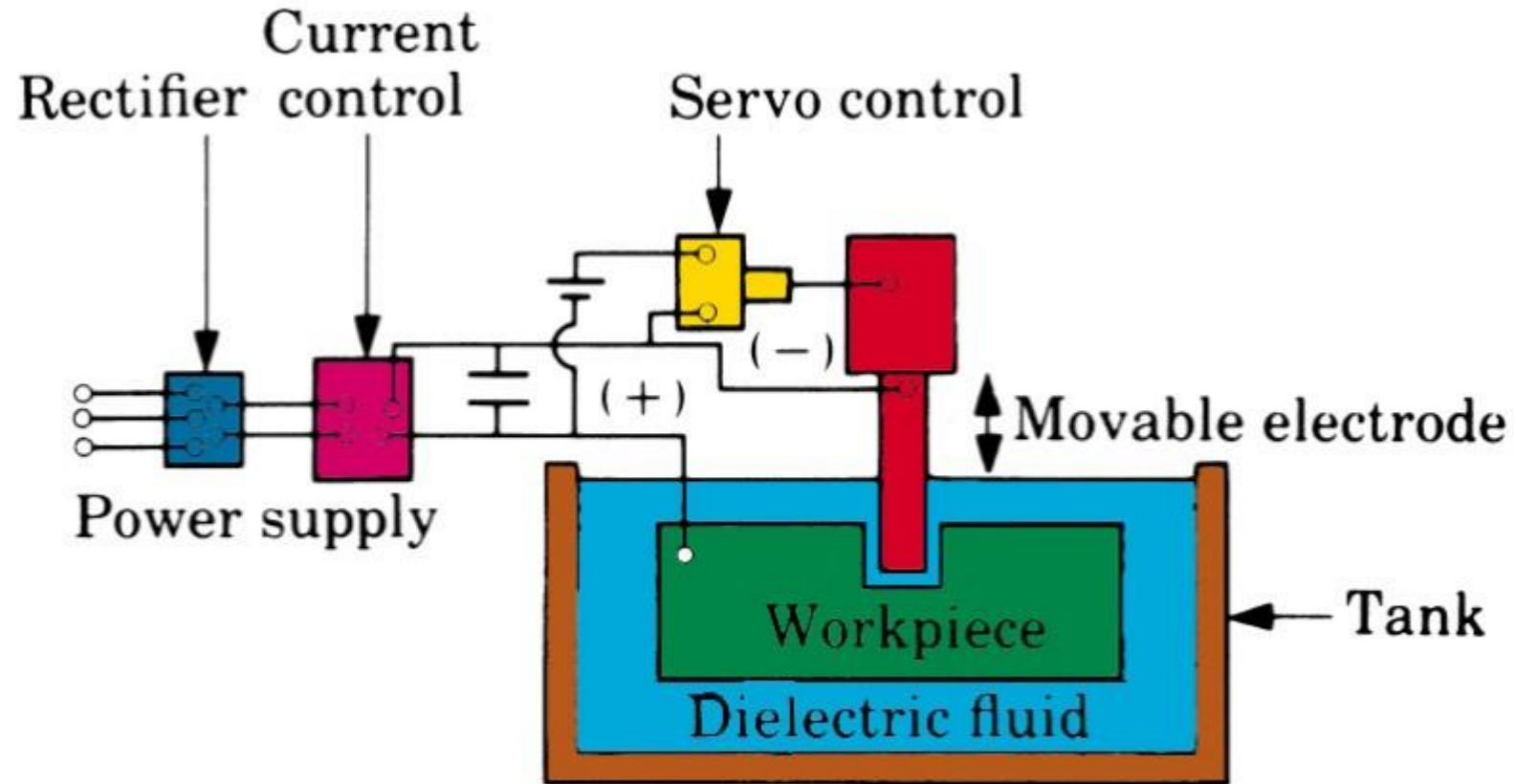









Electric discharge machining (EDM)

- Started in USSR, 1943
- Controlled erosion
- Series of electric sparks
- Discharge takes place between anode and cathode
 - Intense heat generated
 - In sparking zone
 - Melts material
 - Evaporates material
- To improve effectiveness
 - Submerged in dielectric fluid
 - Hydrocarbon
 - Mineral oils etc
- Anode erodes faster
 - Work , positive terminal

Cont.....

- Suitable gap, spark gap
- High frequency
- Spark appear at the spot where work and tool are the closest (as shown in the figure)
- Sparks travel all over the surface
 - Results uniform material removal
 - Work conforms to the tool
- Servo-control unit to control a uniform gap
 - Sense the voltage across it
 - Compares with preset value
 - Difference is used to control the servomotor
 - Or stepper motor
 - Solenoid control

Mechanics of EDM

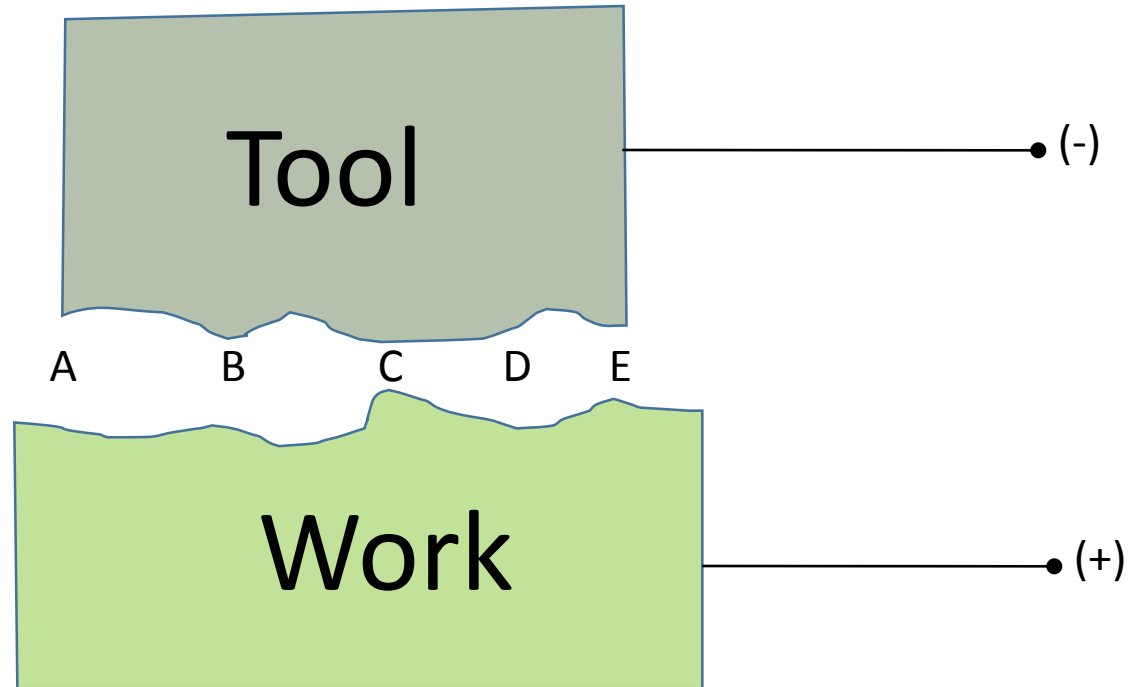

Cont.....

- Spark frequency: 200 to 500,000 Hz
- Spark gap: 0.025 mm to 0.05 mm
- Peak voltage across the gap: 30 V to 250 V
- Metal removal rate: 300 mm³/min with specific power of 10 W/mm³/min
- Efficiency and accuracy: improved with forced circulation of dielectric
- Common dielectric: kerosene
- General tool material: brass or copper alloy

Cont.....

- Asperities and irregularities are always present on the surfaces
- Local gap varies
- Say, minimum at C
- Suitable voltage builds up
- Emission of electron from cathode at C
- Electron accelerated towards anode
- Collides molecules of dielectric at high velocity
- Breaks them into electrons and positive ions
- These electrons collides with other
- Avalanche of electrons
- Seen as spark

Cont.....

- A very high temperature rise 10,000 – 12,000°C
 - Evaporation
 - Melting
 - Development of Small crater
 - Increase in gap
 - Next location with the shortest gap
 - Cycle is repeated
- Material removal rate
 - More at anode
 - Less at cathode

Reasons for mrr at anode

- Momentum of electrons striking anode $>$ momentum of heavier +ve ions striking cathode
- Pyrolysis (breaking at high temperature) of dielectric fluid (normally hydrocarbons) creates a thin film on cathode
- A compressive force is developed on cathode surface

Tool material

- Depends up on
 - Material removal rate
 - Wear ratio
 - Ease of shaping the tool
 - Cost
- Common electrode material
 - Brass
 - Copper graphite
 - Aluminium alloy
 - Copper-tungsten alloy
 - Silver-tungsten alloy

Fabrication of tool

- Conventional machining
 - Copper
 - Brass
 - Cu-W alloys
 - Ag-W alloys
 - Graphite
- Casting
 - Zn base die casting alloys
 - Zn-Sn alloys
 - Aluminium alloys
- Metal spray
- Press forming
- Flow holes are provided for dielectric circulation
 - Large for rough cuts to allow large flow at low pressure

Dielectric fluids

- Basic requirements
 - Low viscosity
 - Absence of toxic vapours
 - Chemical neutrality
 - Absence of inflaming tendency
 - Low cost

Cont.....

- Ordinary water
 - Possesses all properties
 - Causes rusting
 - Work
 - machine
 - Electrodes are constantly under some potential difference
 - Starts distorting the work
 - Wastage of power
- Hydrocarbon (petroleum) oil
- Kerosene
- Liquid paraffin
- Silicon oils
- etc

Operating principles

- Require
 - Pulsating dc current
- Classification of dc supply
 - Resistance-capacitance relaxation circuit with a constant dc source
 - Rotary impulse generator
 - Controlled pulse circuit

Ultra sonic machining (USM)

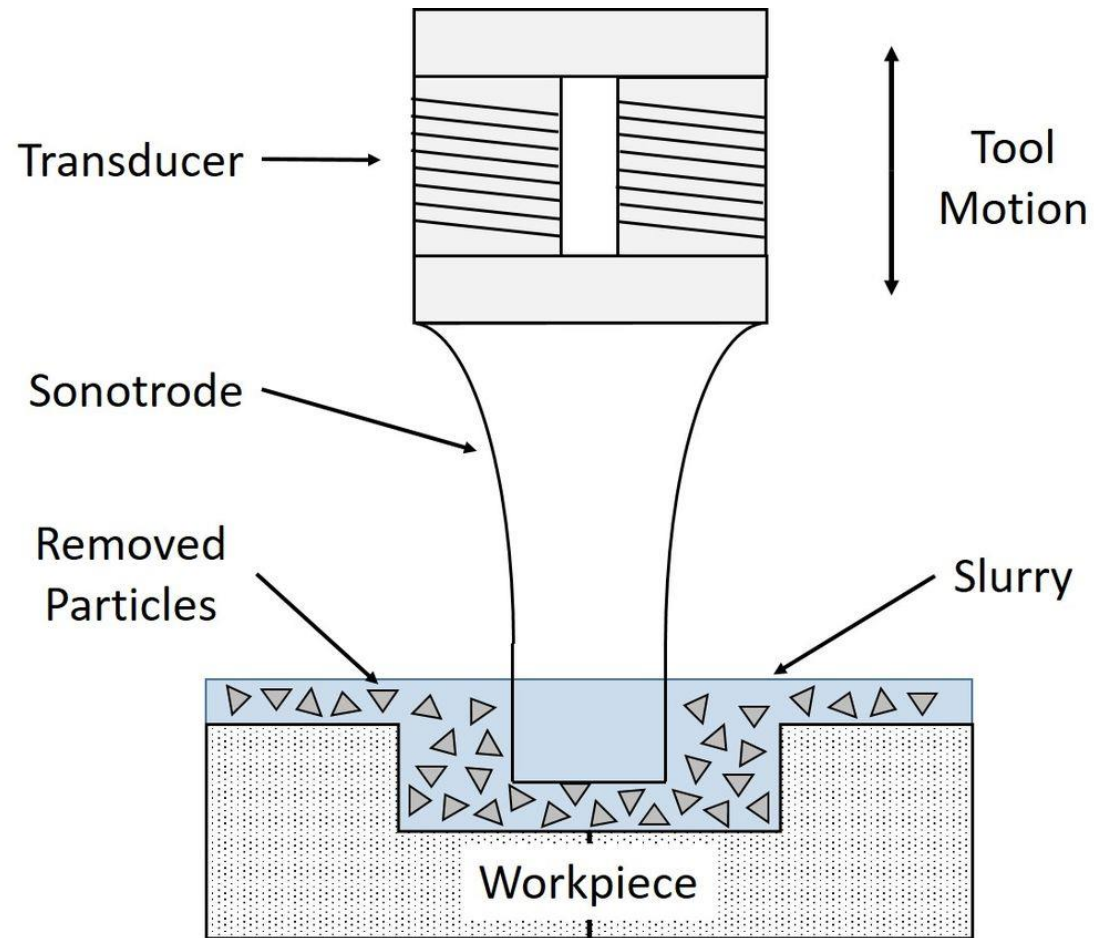



Ultra sonic machining (USM)

Material removal with abrasive particles through

- Micro-chipping
- Erosion
- Tool, sonotrode vibrates at
 - Amplitude of 0.05 to 0.125 mm
 - Frequency 20 kHz
 - Grain size of grain number
 - 100 (for roughing) to 1000 (finishing)

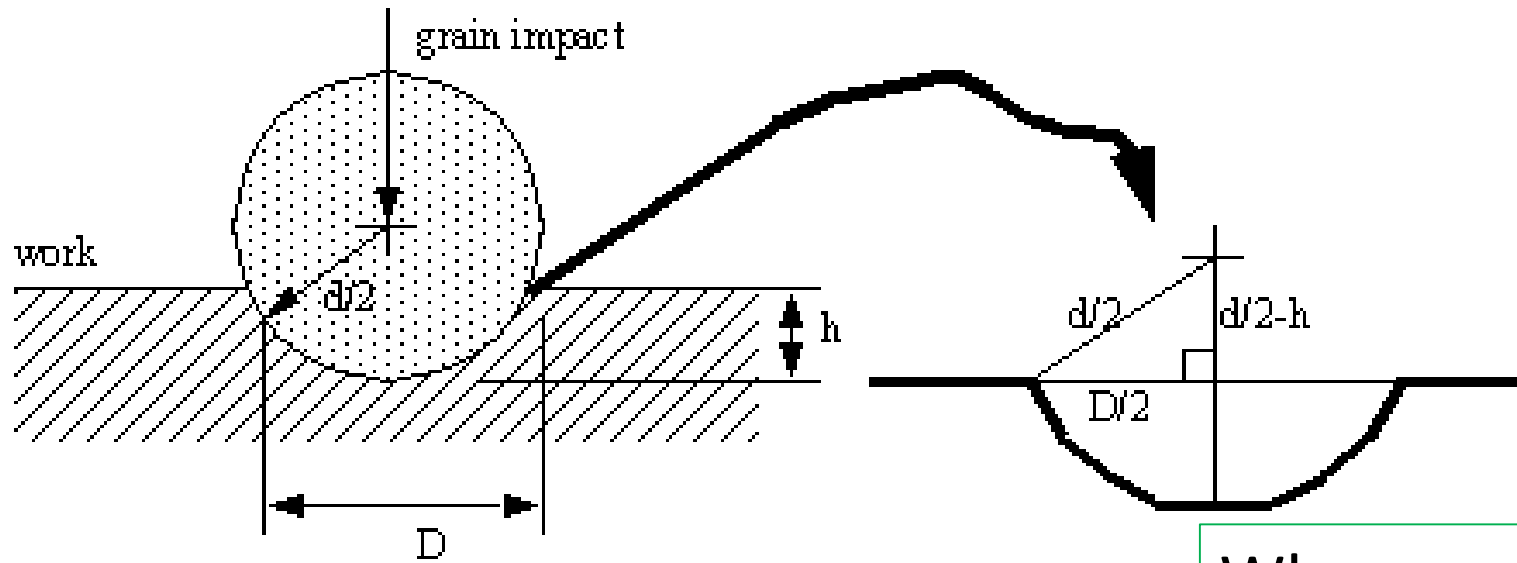

$$\left(\frac{D}{2}\right)^2 = \left(\frac{d}{2}\right)^2 - \left(\frac{d}{2} - h\right)^2$$

$$\therefore D^2 = 4dh - 4h^2$$

assume the impact depth 'h' is small compared to d.

$$D \approx 2\sqrt{dh}$$

now assume

$$D^3(\text{volume}) \propto v(\text{volume per impact})$$

$$\therefore Q \propto vZf \propto D^3 Zf \propto (dh)^{\frac{3}{2}} \propto (dh)^{\frac{3}{2}} Zf$$

Where

D = diameter of the indentation

d = diameter of the indenter

h = depth of penetration/

Z = number of impacting particles

f = frequency of indentation

Q = volumetric material removal
rate

Abrasive

- B_4C
- SiC
- Al_2O_3
- 200—400 grit size for roughing
- 800 — 1000 grit size for finishing

Medium

- Slurry of water
- With 30—60% be volume of the abrasives

—

Toll material

- Soft steel

Surface finish

- 0.2—0.8 μm with finer sizes of abrasives

Shapes produced

- Micro holes of up to 0.1 mm diameters round and
- Irregular holes
- Coining

Materials machined

- Economical for materials having hardness > 50 HRC
- Like stainless steel
- Germanium
- Glass
- Ceramic
- Quartz
- Etc.

Limitations

- Low metal removal rate
- High rate of tool wear
- Hole depth to diameter ratio of 10 : 1

Thanks