

# CT scan



# Introduction

- **At the annual Congress of British institute of radiology** , in April of **1972** , **Godfrey Newbold Hounsfield**, a senior research scientist **At EMI limited** (Electric and Musical Industries), **middlesex, England** , announced the revolutionary imaging technique called **computerized axial Transverse Scanning**.
- **Allan MacLeod Cormack developed the mathematics used to reconstruct the CT image in 1963.**
- **Noble prize was given to the discovery in 1979, for both GN hounsfield (UK) and Alan coremack (USA).**
- **Perhaps the first significant technical development came in 1974 when **Dr. Robert Ledley**, a professor of radiology, physiology, and biophysics at Georgetown University, developed the first whole-body CT scanner. (Hounsfield's EMI scanner scanned only the head.)**

- In 1989, **Dr. Willi Kalender** has made significant contributions to the introduction and development of volume spiral CT scanning.

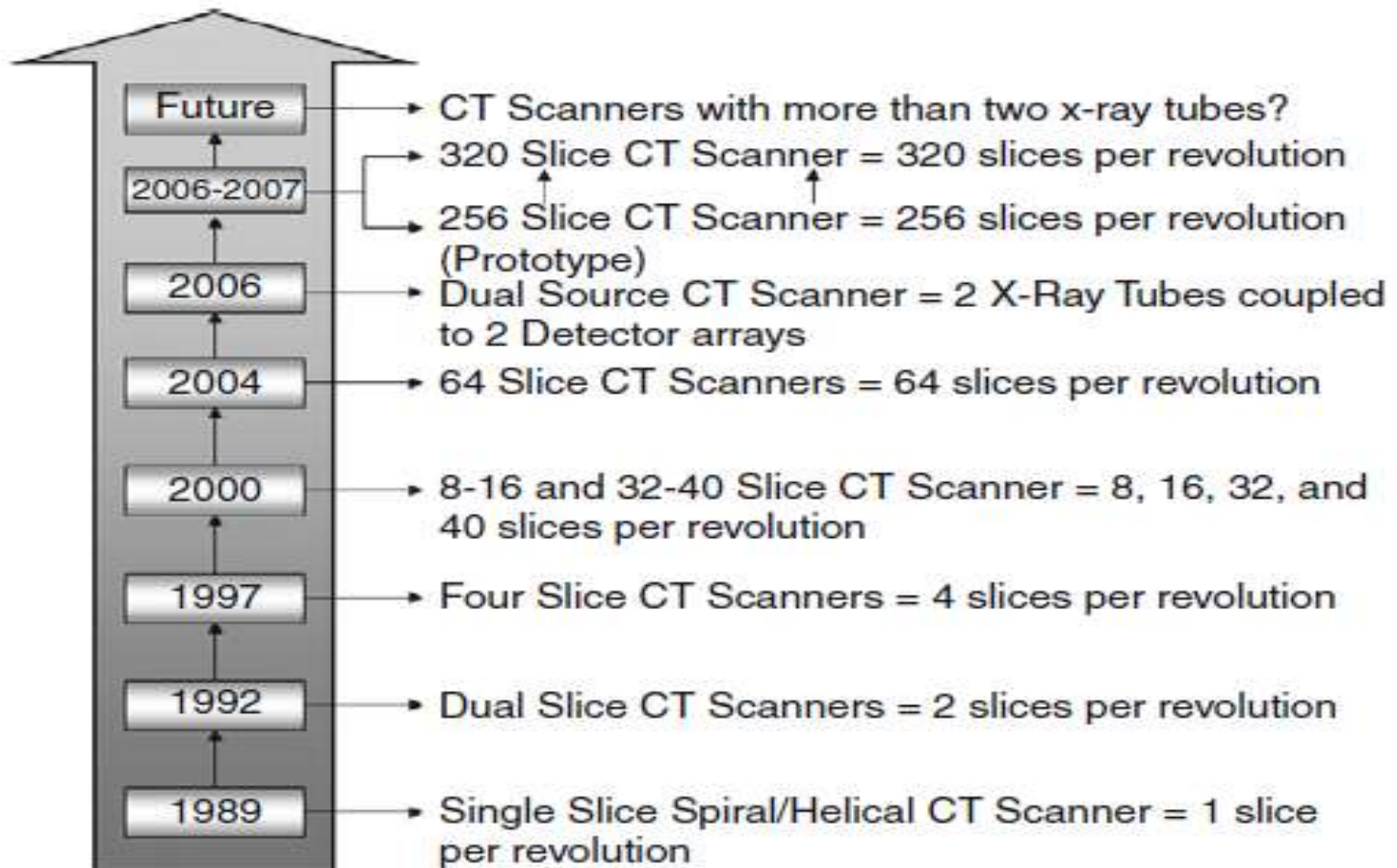

**FIGURE 1-15** The evolution of MSCT scanners, including the DSCT scanner.

# Terminology

- Translation is the linear movement of X ray tube and detector.
- Rotation is the rotatory movement of X ray tube and detector.
- Ray refers single transmission measurement.
- Projection refers series of X rays passes through the patient at the same orientation.
- Pitch is the ratio of distance travelled by patient table in Gantry and slice thickness.

- ❑ Pitch = table movement per axial scan(table feed) / slice thickness.
- ❑ If pitch increases Radiation dose, Image quality and Scanning time decreases.
- ❑ If increment increases No of images decreases and If increment decreases no of images increases.
- ❑ CT number or hounsfield unit :

- Numerical value for each pixel.

$$\text{CT Number} = K \left[ \frac{\mu_{\text{tissue}} - \mu_{\text{water}}}{\mu_{\text{water}}} \right]$$

- The CT number is directly related to the x-ray linear attenuation coefficient for the tissue contained in the voxel.

Where K constant = 1000  
 $\mu$  = Tissue attenuation value  
 CT number = HU

## Hounsfield Units for human body

<i>Bone</i>	<i>1000</i>
<i>Liver</i>	<i>40 to 60</i>
<i>White Matter</i>	<i>46</i>
<i>Grey Matter</i>	<i>43</i>
<i>Blood</i>	<i>40</i>
<i>Muscle</i>	<i>10 to 40</i>
<i>Kidney</i>	<i>30</i>
<i>Cerebrospinal Fluid</i>	<i>15</i>
<i>Water</i>	<i>0</i>
<i>Fat</i>	<i>-50 to -100</i>
<i>Air</i>	<i>-1000</i>

**In CT, a high-kilovolt technique (about 120 kV) is generally used for the following reasons:**

- 1. To reduce the dependence of attenuation coefficients on photon energy.**
- 2. To reduce the contrast of bone relative to soft tissues.**
- 3. To produce a high radiation flux at the detector.**

**These reasons are important to ensure optimum detector response (e.g., to reduce artifacts caused by changes in skull thickness, which can conceal small changes in attenuation in soft tissues and to minimize artifacts resulting from beam-hardening effects).**

# Basic principle Of CT

- The fundamental concept is the internal structure of an object can be reconstructed from multiple projections of the object.
- **Computerized tomography means A method Of producing three dimensional images Of internal body structure by two dimensional images (axial images)**
- The Ray projections are formed by scanning a thin cross section of the body with a narrow x ray beam and measuring the transmitted radiation with a sensitive radiation detector.
- The detector does not form the image.
- It adds up the energy of all the transmitted photons.
- **The numerical data ray sums are then computer processed to reconstruct an image.**
- Human body is imagined as a matrix and is divided into number of columns and rows.
- In general, CT scanners used 512 x 512 and 1024 x 1024 columns and rows.
- Each matrix element is named as picture element ( pixel) in a 2- dimensional concept.



- Pixel size is 0.625 mm, Detector size – 0.625 mm and minimal slice thickness called pixel size.
- Volume element (voxel) represents a volume of tissue in the patient and it is three dimensional concept.
- Voxels are scanned in different directions.
- Each pixel on the monitor display represents a voxel in the patient.
- When the voxel dimensions of length, width, and height are equal, that is, describe a perfect cube, the imaging process is referred to as Isotropic imaging.
- Finally, each pixel in the CT image can have a range of gray shades. The image can have 256 ( $2^8$ ), 512 ( $2^9$ ), 1024 ( $2^{10}$ ), or 2048 ( $2^{11}$ ) different grayscale values.
- Because these numbers are represented as bits, a CT image can be characterized by the number of bits per pixel.
- CT images can have 8, 9, 10, 11, or 12 bits per pixel.
- The image therefore consists of a series of bit planes referred to the bit depth.

# Matrix of image

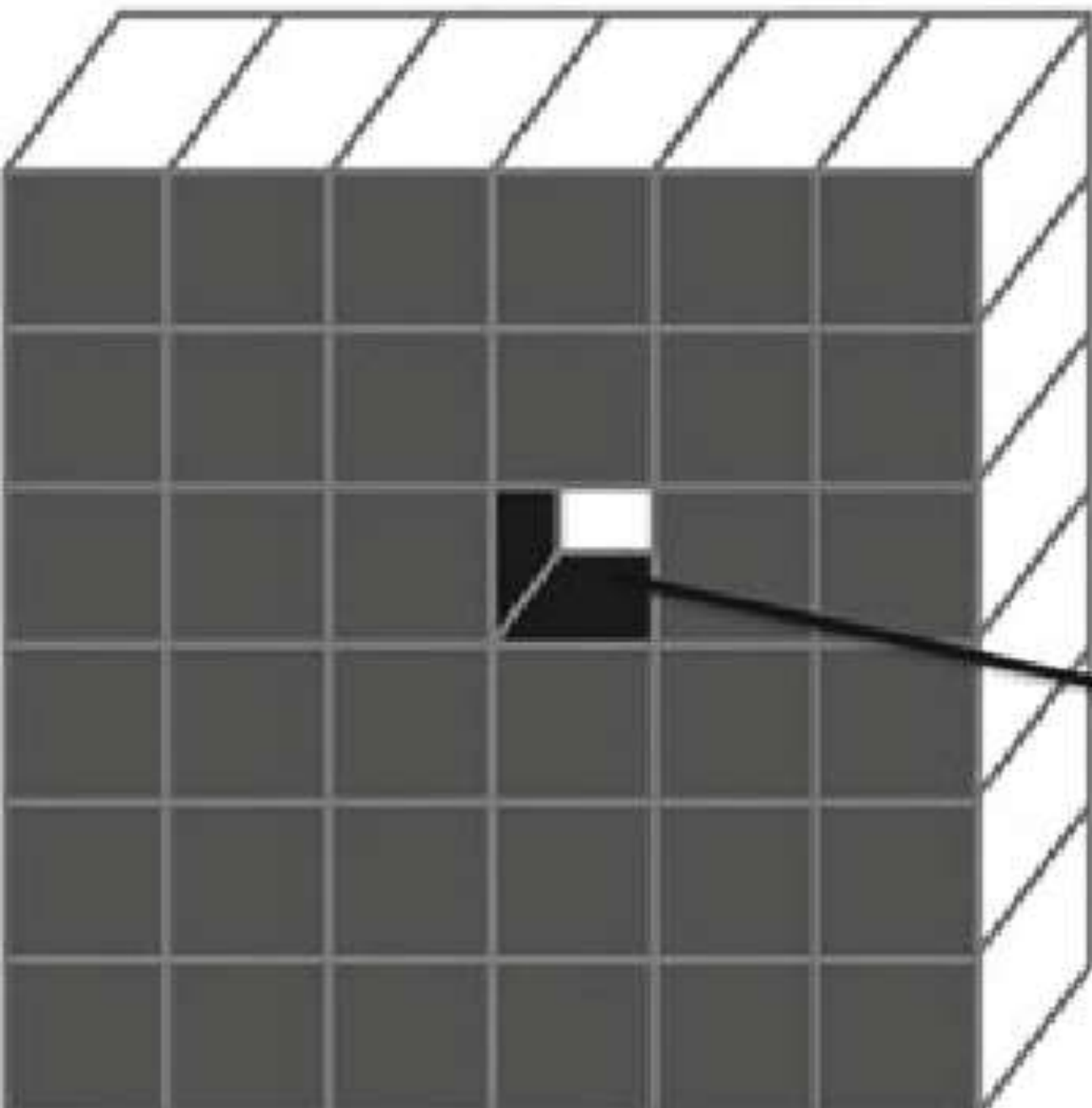

**Pixel**



**Voxel**

# CT Slice Divided into Matrix of Voxels

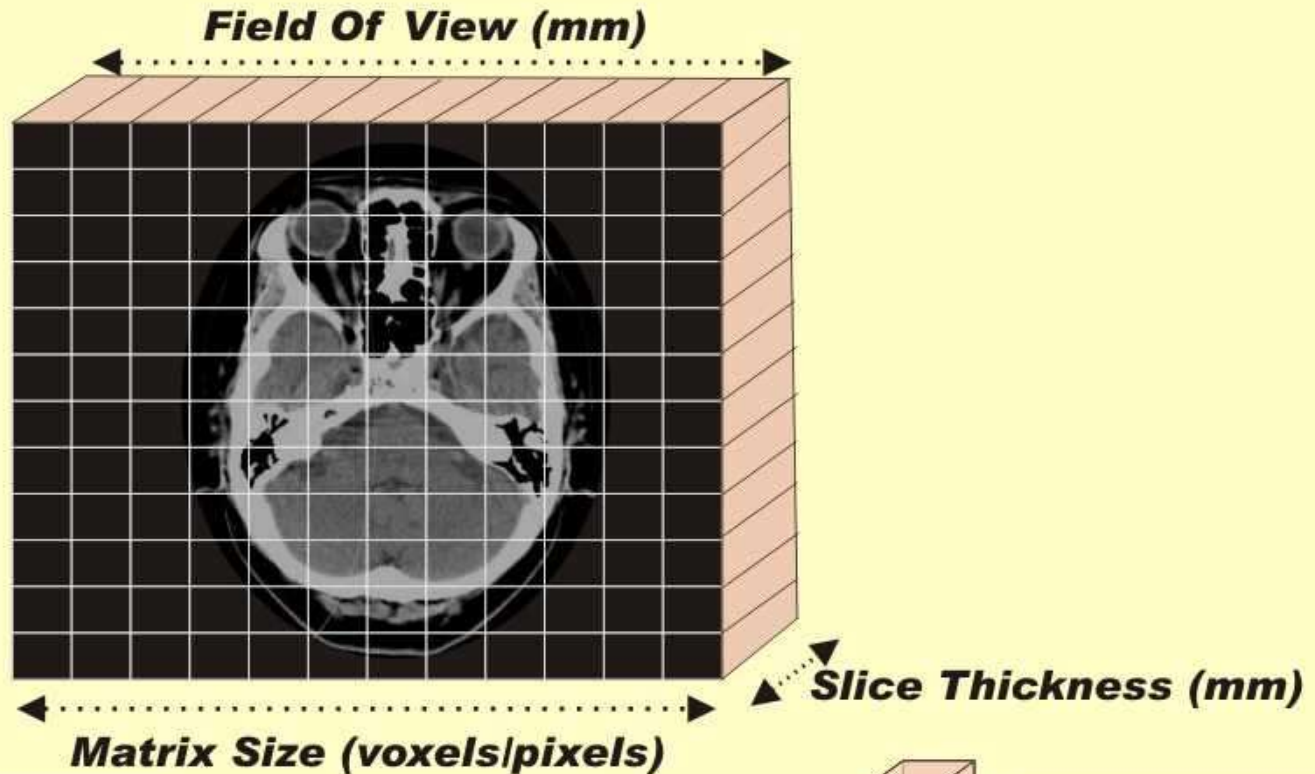

$$\text{FOV} \div \text{Matrix} \dots \text{Slice Th.}$$

**Voxel Size Controlled By**

# SPATIAL CHARACTERISTICS

VOLUME OF SLICES

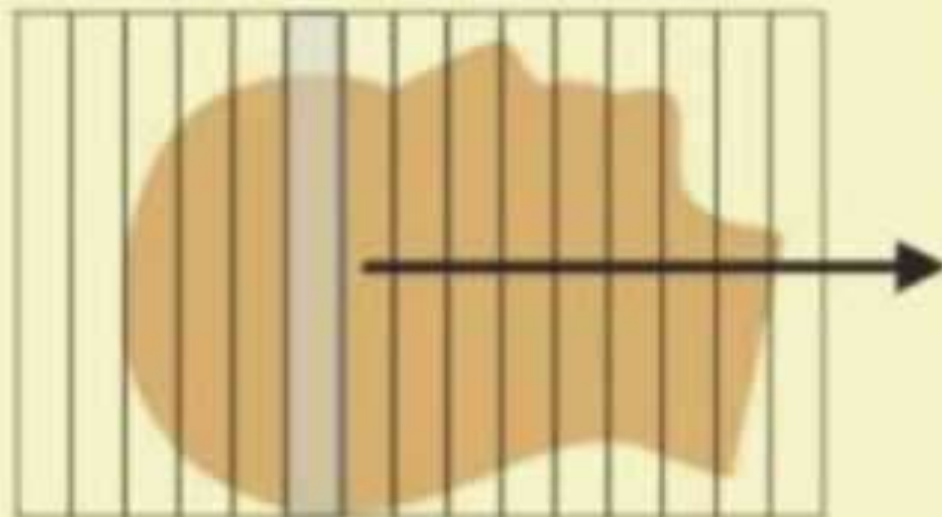

SLICE OF VOXELS



IMAGE OF PIXELS

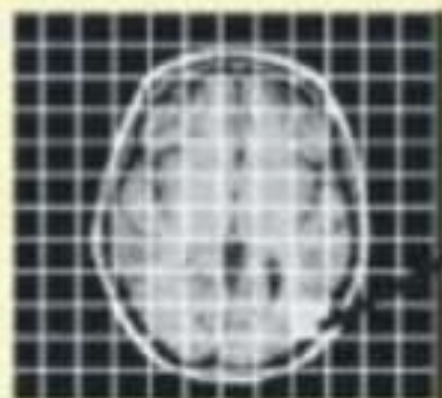

# Windowing :

- The CT image is composed of a range of CT numbers (e.g., +1000 to -1000, for a total of 2000 numbers) that represent varying shades of gray.
- The range of CT numbers is referred to as the window width (WW), and it controls the contrast.
- The center of the range is the window level (WL) or window center (C), and it controls image brightness.
- Both the WW and WL are located on the control console. With a WW of 2000 and a WL of 0, the entire gray scale is displayed and the ability of the observer to perceive small differences in soft tissue attenuation will be lost because the human eye can perceive only about 40 shades of gray.
- The WL or C increases the image goes from white (bright) to dark (less bright); and the image contrast changes for different values of WWs.
- The image contrast is optimized for the anatomy under study, and therefore specified values of WW and WL or C must be used during the initial scanning of the patient.

CT value, HU

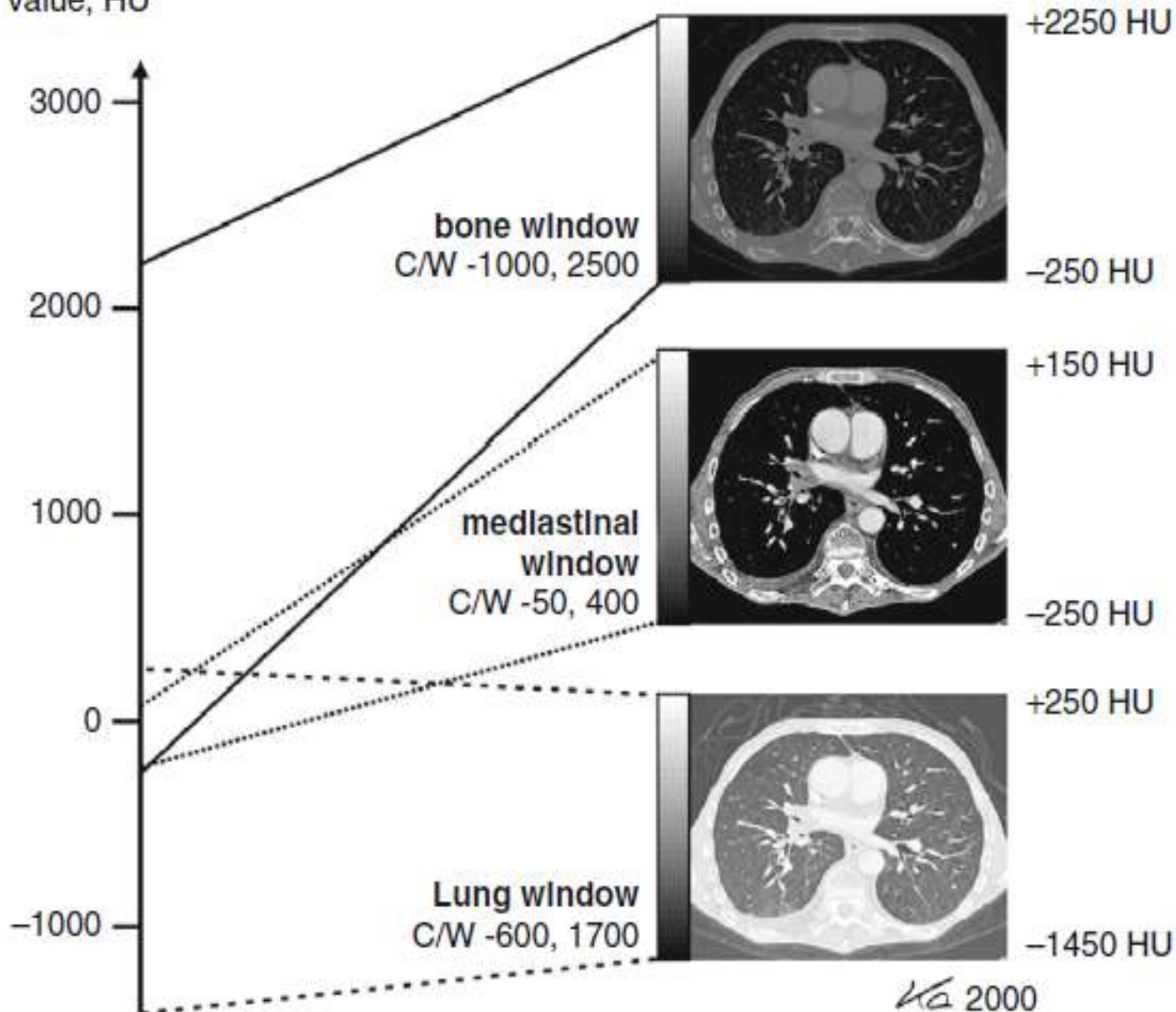

# Image quality

- In CT, image quality is directly related to its usefulness in providing an accurate diagnosis.
- Types of image quality
  1. Contrast resolution.
  2. Spatial resolution.
  3. Temporal resolution.
  4. Noise
  5. Image blur or Unsharpness

## 1. Contrast resolution:

- It is the ability to distinguish between multiple densities in the radiographic image.
- Its depends on matrix size.

**This two types : Subject contrast and Display contrast.**

- **CT subject contrast** is determined by different attenuation. This is depend on HU.
- **Display contrast** is Arbitrary ( depending only on window level & window width selected. Nothing but windowing (LUNG AND SOFT TISSUE)

## 2. Spatial resolution

- It is the ability of imaging system to differentiate between two near by objects.
- it is depend on the size of the pixel.
- It is measured in **linepairs per millimeter (lp/mm)**. A line pair is a pair of equal-sized black-white bars. Therefore, a bar pattern representing 10 lp/cm is a set of uniformly spaced combshaped bars with 0.5-mm wide teeth.

## 3. Temporal resolution

- It is the ability to see the fast moving objects.
- It is the minimal time necessary to compile all X-ray data that are required to calculate or reconstruct one cross-sectional CT data set.
- A high temporal resolution is required in coronary CTA to ensure motion-free image quality of the fast-moving coronary arteries.
- Dual CT scan improved temporal resolution.



**4. Noise(Quantum mottle):** Unwanted change in the pixel values that shows grainy appearance on cross-sectional image.

- It is a random process due to fluctuations in the number of photons reaching the detector from point to point.
- Noise in CT measured via SNR : comparing the level of desired signal to level of background noise.
- Higher the SNR, less noise on image.

**5. Image blur or Unsharpness :**

- The distortion of objects in an image, resulting in poor spatial resolution.
- In order to determine the image quality the image must be sharp. Blurring will reduce the image quality.
- **Types of blur:**
  1. Geometric blur – limited by focal spot size.
  2. detector blur – limited by detectors.
  3. motion blur – caused by voluntary/involuntary movements of patient.
  4. absorption blur – blurring at edge of round/tapered stricture.

## The special features of CT image includes

1. Images are crosssectional.
2. Eliminates the superimposition of structures.
3. Sensitivity of CT to subtle difference in x ray attenuation is at least factor 10 higher than x ray film.
4. Higher contrast due to elimination of scatter





Success is the sum of small efforts,  
repeated day-in and day-out.

— *Robert Collier* —

AZ QUOTES

# System components in ct

■ CT scan contains following components.

1. Control console.
2. Computer.
3. Coach .
4. Gantry.

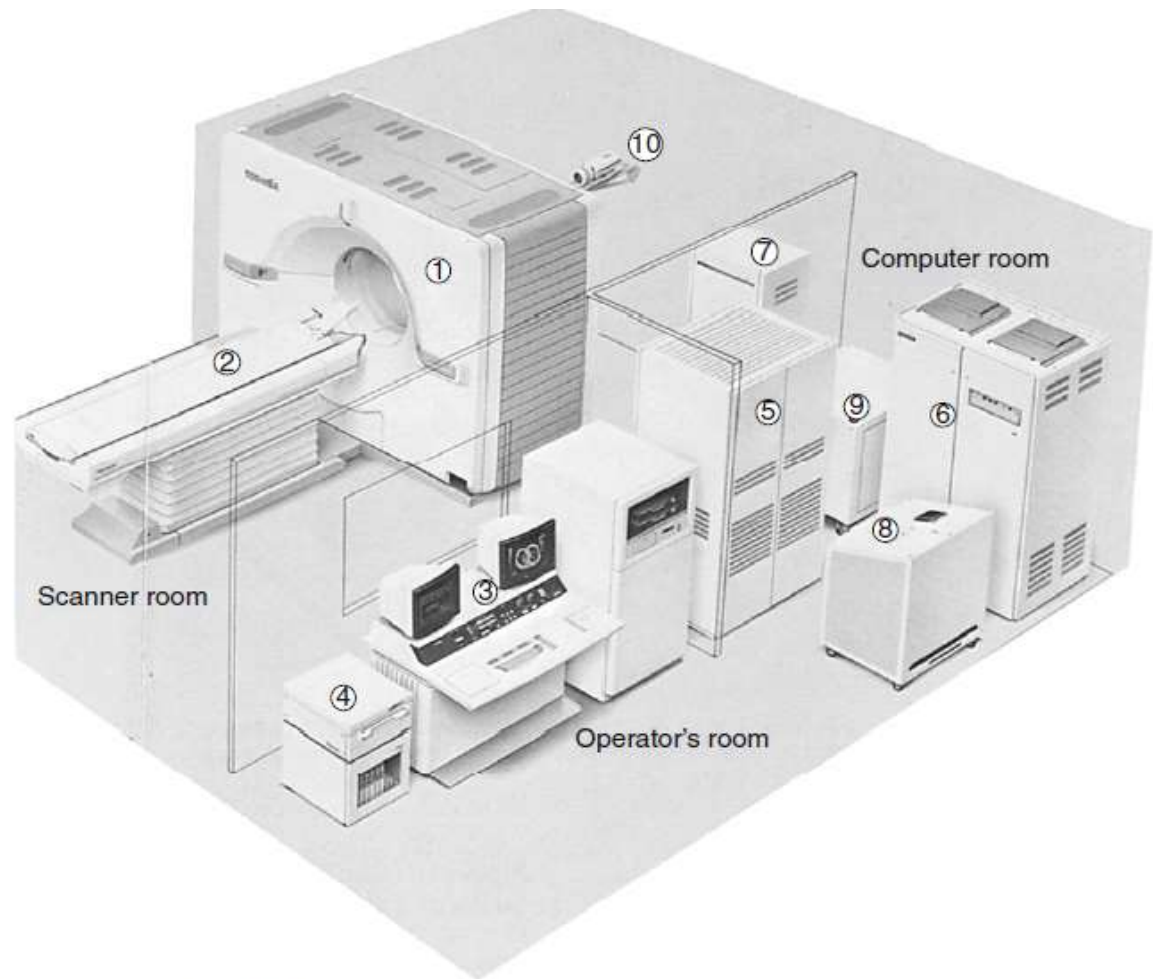

**FIGURE 7-2** Components of a CT imaging system. 1, Gantry; 2, patient couch; 3, integrated console; 4, optical disk system including cassette storage; 5, high-speed processor system; 6, x-ray high-voltage generator; 7, couch control unit; 8, system transformer I; 9, system transformer II; 10, patient observation system. (Courtesy Toshiba America Medical Systems, Tustin, Calif.)

# Control console

- There are 3 consoles in ct, one for the technologist to operate the imaging system, one for the technologist to post process images and the other for the physician to view images.

Ex : GE CT scan.

- The operating console is provided with meters , controls for selection of technique factors , movement of Gantry and table couch, image reconstruction commands, selection of kvp and mAs and slice thickness.
- The Radiologist in control console is used to see the images and write reports. In some institutions, work station provided for reporting of patient scans.

# Computer

- The computer is used to solve more than 2,50,000 equations with the help of microprocessor.
- the computer system performs image manipulation and various image processing operations such as windowing, image enhancement, image enlargement and measurements, multiplanar reconstruction, three-dimensional (3D) imaging, and quantitative measurements.
- The computer system generally includes input/output devices, central processing units, array processors, interface devices, back-projector processors, storage devices, and communications hardware. The computer system also includes software that allows each hardware component to perform specific tasks.
- The software includes plot of CT numbers, mean and standard deviation of CT values of , ROI subtraction techniques , reconstruction of images in coronal ,sagittal and oblique.

# Couch

- **The couch supports the patient comfortably and it is made up of low Z material like carbon material.**
- **It has a motor for smooth patient Positioning.**
- **It moves longitudinally through Gantry aperture , indexed automatically and the table top can be removable.**
- **The vertical movement should provide a range of heights to make it easy for patients to mount and dismount the table This feature is especially useful in the examination of geriatric, trauma, and pediatric patients. Horizontal or longitudinal couch movements should enable the patient to be scanned from head to thighs without repositioning**

# Gantry

- ❑ The gantry is a mounted framework that surrounds the patient in a vertical plane. It contains a rotating scan frame onto which the x-ray generator, X ray tube, and other components are mounted.
- ❑ The generator in the gantry is usually a small, solid-state, high-frequency generator mounted on the rotating scan frames.
- ❑ Because it is located close to the x-ray tube, only a short high-tension cable is required to couple the x-ray tube and generator. This design eliminates external x-ray control cabinets and long high-tension cables as was typical of the older CT imaging systems.
- ❑ Gantry cooling is a prime consideration because the ambient air temperature affects several components. In the past, air conditioners were placed in the gantry. Modern cooling systems circulate ambient air from the scanner room throughout the gantry.
- ❑ **Most scanners have a 70-cm aperture that facilitates patient positioning and helps provide access to patients in emergency situations.**



CT Gantry has the following gadgets.

- X-ray tube.
- Collimators.
- Filters .
- Detectors.
- High voltage generator.

# X ray tube

- Ideally , the radiation source for CT should supply a monochromatic x ray beam. With monochromatic x ray beam image reconstruction is simpler and more accurate.
- Kvp of x ray used : 120 to 140 kvp.
- mAs of x ray used : 400 to 1000 mA.
- Tubes are operated for prolonged exposure time at high mA.
- There are two focal spot sizes . Hrct uses small focal spot size.
- High speed rotors in tubes for best heat dissipation.

# Collimators

- Collimation in CT serves to ensure good image quality and to reduce unnecessary radiation doses for the patient.
- Collimators are present between the X - ray source and the patient (tube or pre - patient collimators) and between the patient and the detectors (detector or post - patient collimators).
- The tube collimator is used to shape the X - ray fan beam before it penetrates the patient.
- it consists of a set of collimator blades made of highly absorbing materials such as tungsten or molybdenum.
- The opening of these blades is adjusted according to the selected slice width and the size and position of the focal spot.

# Filteration

- The X - ray photons emitted by the X - ray tube exhibit a wide spectrum. The soft, low - energy X - rays, which contribute strongly to the patient dose and scatter radiation but less to the detected signal should be removed.
- To achieve this goal, most CT manufacturers use X - ray filters.
- The inherent filtration of the X-ray tube, typically 3 mm aluminum equivalent thickness, is the first filter.
- In addition, flat or shaped filters can be used. Flat filters, made of copper or aluminum, are placed between the X - ray source and the patient. They modify the X - ray spectrum uniformly across the entire field of view.

- **the cross - section of a patient is mostly oval - shaped,so bowtie filters have an increased thickness from center to periphery, allowing them to attenuate radiation hardly at all in the center but strongly in the periphery.**
- **They are made from a material with a low atomic number and high density, such as Teflon.**

# High voltage generator

- It is mounted on the Gantry which takes 0.3 secs for 360 degrees rotation.
- The generator is a high frequency generator with the capacity of 60 KW
- It provides stable tube current and voltage is controlled by microprocessor.
- The generator can give a tube current of about 800 mA and 125 KV with pulse duration of 2 to 4 Milliseconds.

# Detectors

■ There are two types of detectors used in ct scanners. These are

1. Scintillation detectors.

2. Xenon gas ionization Chambers.

# Scintillation detectors

- **Scintillation crystals** are extremely large number of materials that produce light as a result of some external influence.
- When ionizing radiation reacts with scintillation crystals that produce light (scintillate).
- The number of light photons proportional to the energy of incident x ray photon.
- This is just what intensifying screen does.
- Some of these light photons will be emitted promptly and produce the desired signal.



- Some light photons will be delayed and produce produce afterglow.
- This process done by photomultiplier tubes.
- The first two generations used thallium - activated sodium iodide scintillation crystals attached to photomultiplier tubes.
- Sodium iodide crystals have some disadvantages. They are
  1. Pm tubes are big and not easily fit into the large array of detectors .
  2. Nai is hydroscopic and requiries air tight container and it has a long afterglow.

Scintillator

Photo Multiplier (PMT)

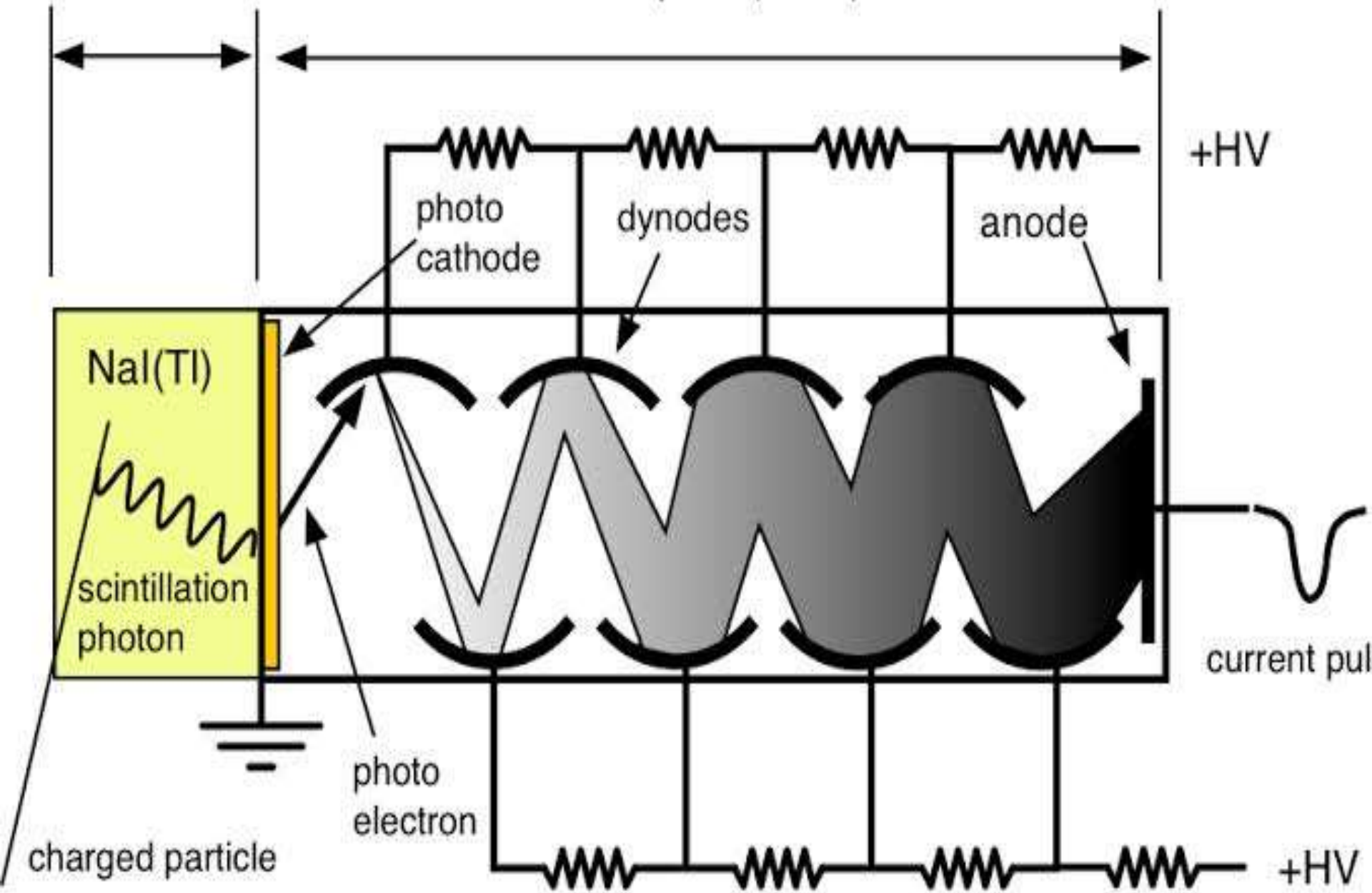

- There are several possibilities for replacing nai.
- These include cesium iodide , bismuth germinate and cadmium tungstate.
- Photomultiplier tubes have been replaced with silicon photodiodes .
- A photo diode convert a light signal into an electric current or signal..
- Photo diodes offer the advantage of smaller size, greater stability and lower cost.



## Detector type

### XENON

Pressurised xenon gas



Ionisation



Signal

### SOLID STATE

Scintillation



Photon capture



Light



Photo-diode



Signal

# Xenon gas ionization Chambers

■ Any gas filled detector contains

1. An anode and cathode.
2. A counting gas ( inert gas ).
3. A voltage between the anode and cathode.
4. Walls that separate the detector from the rest of the world.
5. A window for the radiation photon to enter the detector.

# Xenon gas ionization chamber

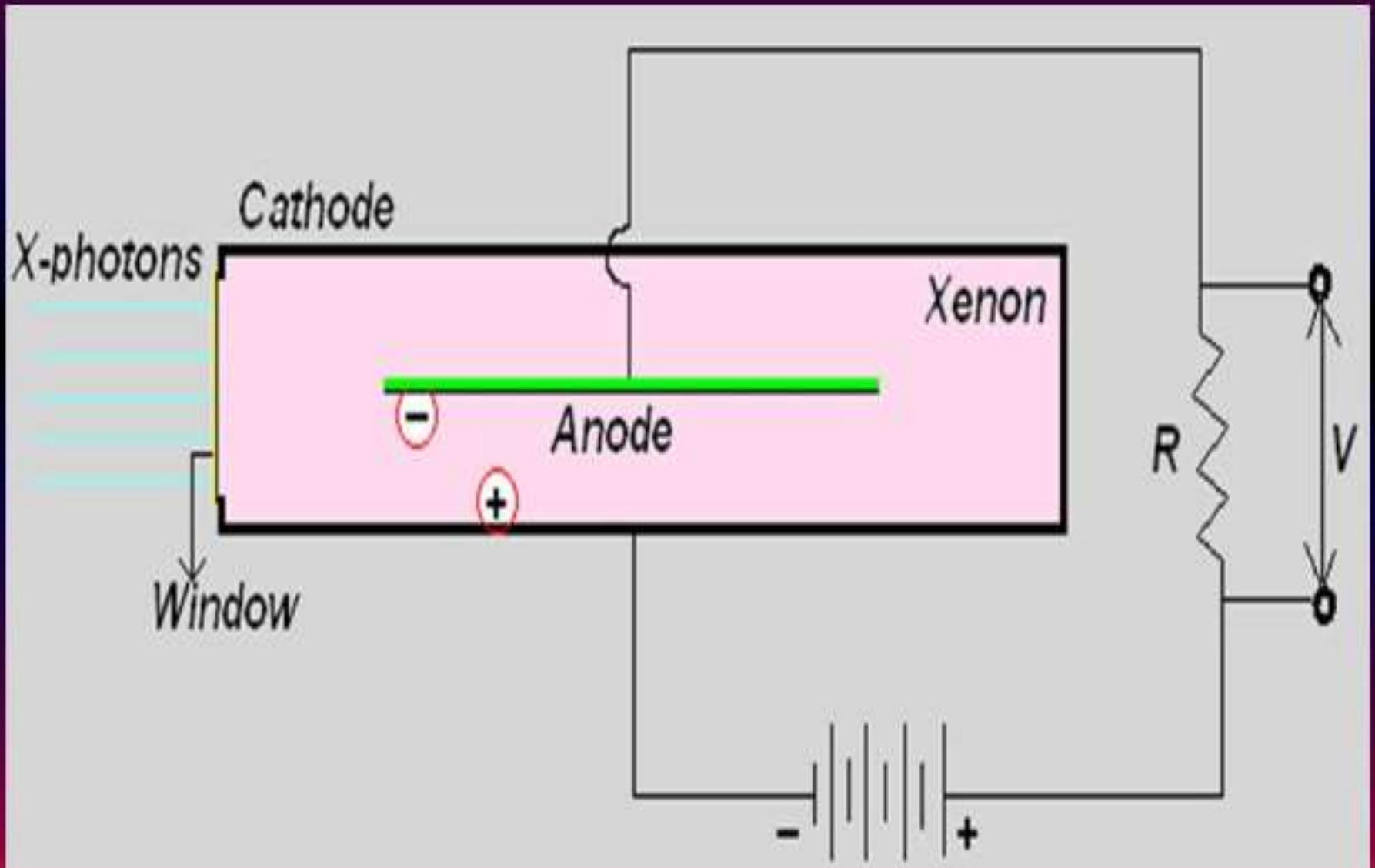

- **The photon enters into detector through a window.**
- **The photon interacts with a gas atom by ionizing the atom into electron pair.**
- **The voltage between the anode and cathode will cause the electron to move toward the anode and the positive ion move towards the cathode.**
- **When the electrons reach the anode , they produce small current in the anode.**
- **This small current is the output signal from the detector.**

- Gas filled detectors may operate in one of three modes.
- 1. **For low voltage, only the negative ions produced by the photon are collected by the anode. A gas filled detector operating in this mode is called ionization chamber. The important characteristics are that the current is directly proportional to the intensity of the incoming radiation.**
- 2. **At the voltage increases, the ions moving under the influence of the voltage acquire sufficient energy to produce secondary ionization of the gas atoms. In this mode gas filled detector is called proportional counter. Its main characteristic is that output signal is proportional to the energy of photon.**



■ **With high voltage** , the secondary ionization is so large that the energy proportionally is lost and all incoming photons register the same size pulse. In this mode, the gas filled detector is called **Geiger Muller counter**.

1. It's main characteristic is large signals that are easily recorded.

2. Hand carried survey meters are this type of detector.

■ The disadvantage of xenon gas detector is a reduced efficacy .

■ The overall detection efficacy is approximately 50 %.

■ **The efficacy can improved by three ways**

- 1. By using xenon , the heaviest of the inert gases. ( Z=54)**
- 2. By compressing the xenon 8 to 10 atmospheric pressure to increase it's density.**
- 3. By increasing the length of the chamber to increase the number of atoms along the path of x ray beam.**

# ADVANCEMENTS

<b>Detector Name</b>	<b>Scintillator</b>	<b>CT Manufacturer</b>
Gemstone Clarity Detector	Lutetium (Lu)-based garnet (gemstone-rare earth-based oxide)	General Electric Healthcare
NanoPanel Prism Detector	Top layer: yttrium-based garnet scintillator Bottom layer: GOS	Philips Healthcare
Stellar Detector	UFC	Siemens Healthcare
Quantum Vi Detector	Pr GOS	Toshiba Medical Systems
PURE Vision CT Detector	Pr is an active additive of Toshiba GOS	Toshiba Medical Systems

# STELLAR DETECTOR(SIEMENS)

- Siemens Healthineers' first fully integrated detector
- Ultra Fast Ceramics (UFC), the detector offers
  1. High X-ray absorption
  2. Short decay times
  3. Extremely low afterglow

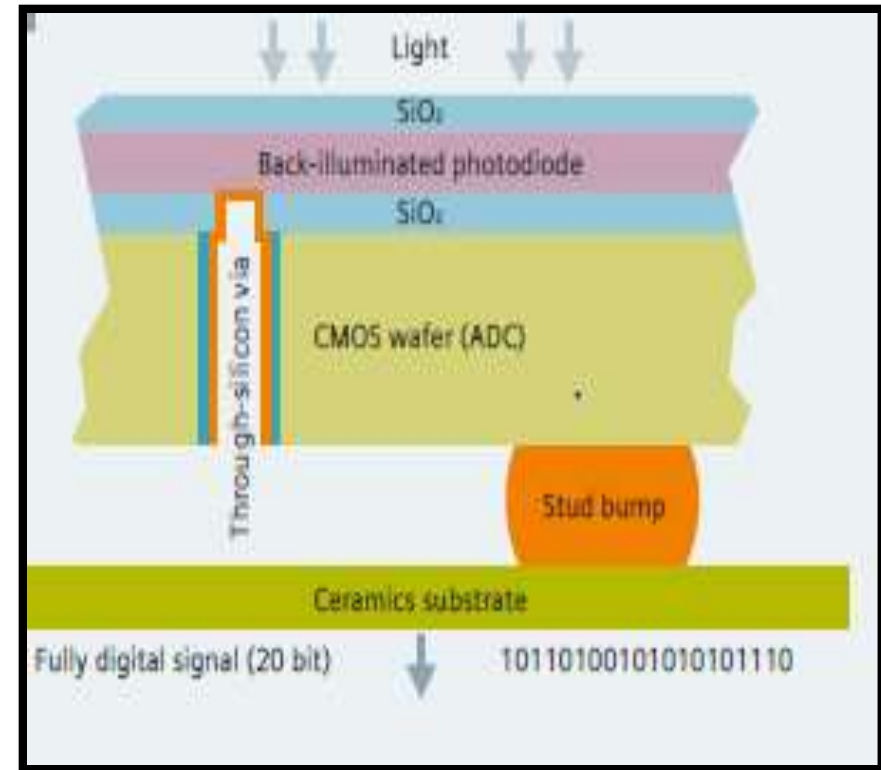

# ADVANTAGES OF STELLAR DETECTOR

- Combines the photodiode and ADC in one ASIC (application specific integrated circuit)
  1. Reduces electronic noise
  2. Low Power consumption (70%)
  3. Good Heat dissipation

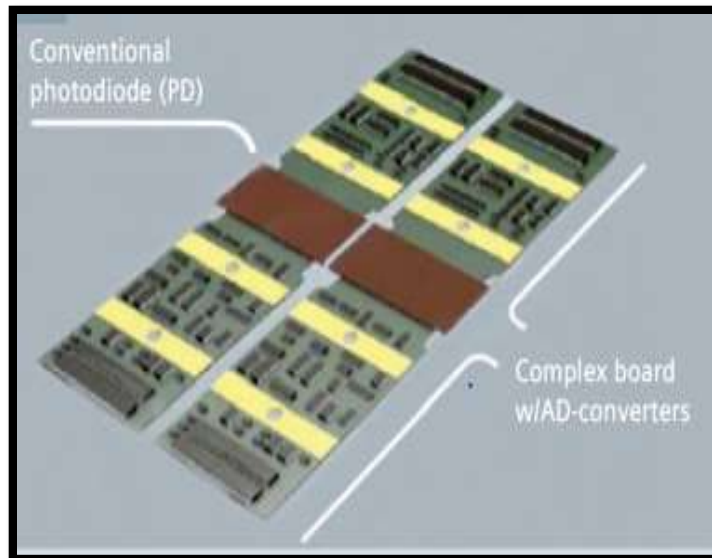

CONVENTIONAL

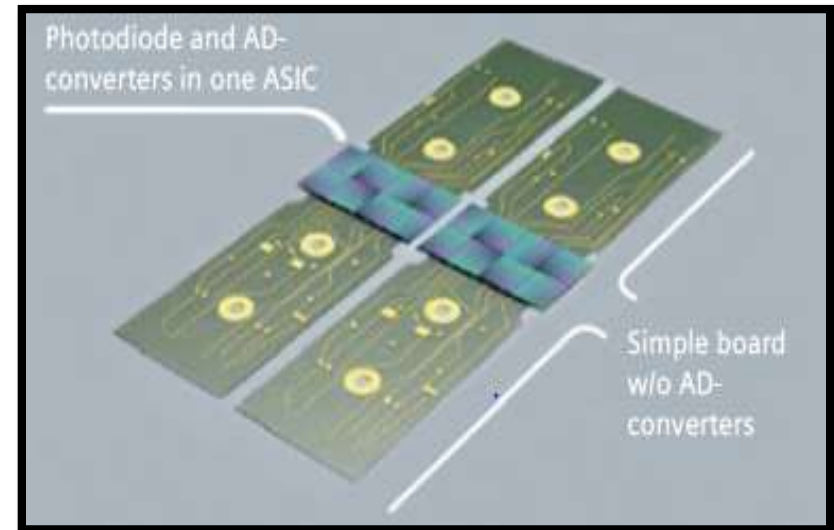

STELLAR

# COMPARISON BETWEEN CONVENTIONAL AND STELLAR DETECTOR

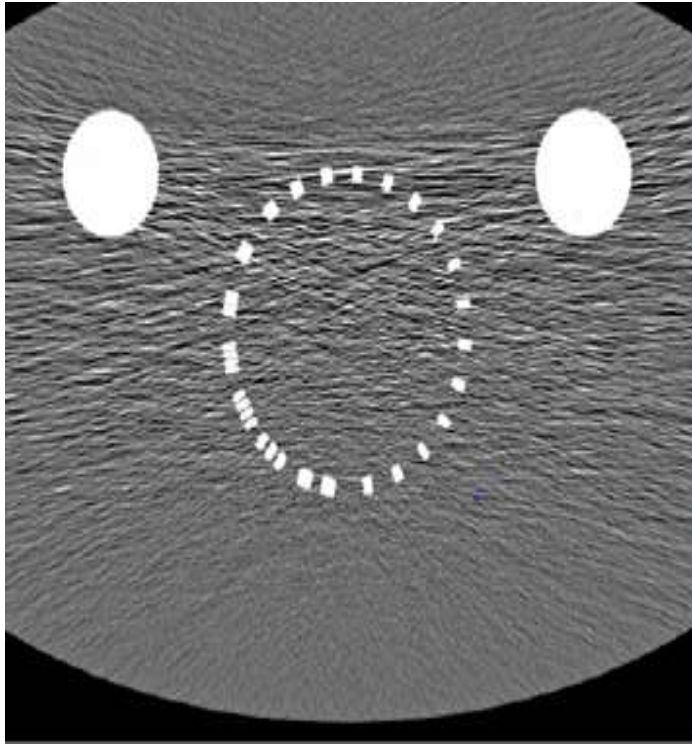

A) CONVENTIONAL

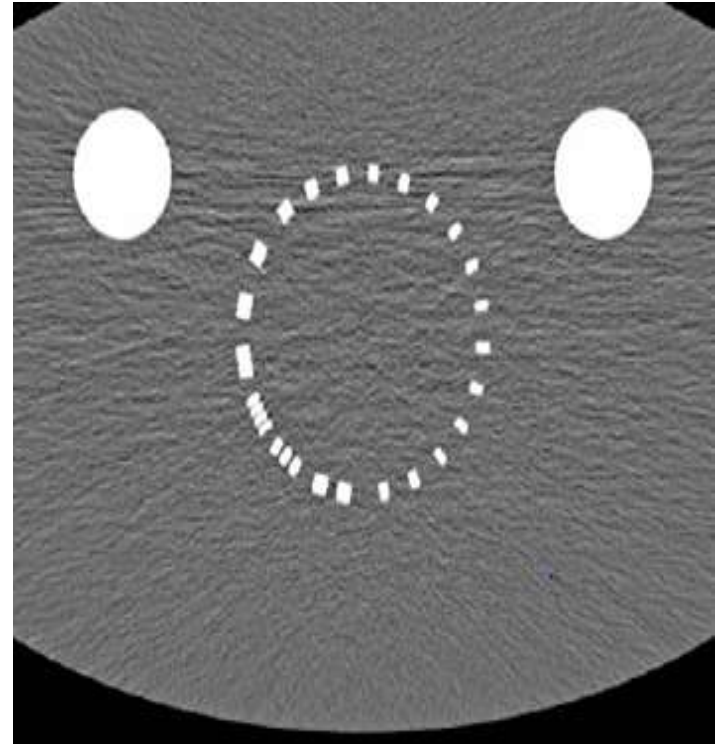

B) STELLAR  
DETECTOR



**A) CONVENTIONAL**



**B) STELLAR  
DETECTOR**

### Detector Noise Measured in a 40 cm Water Phantom

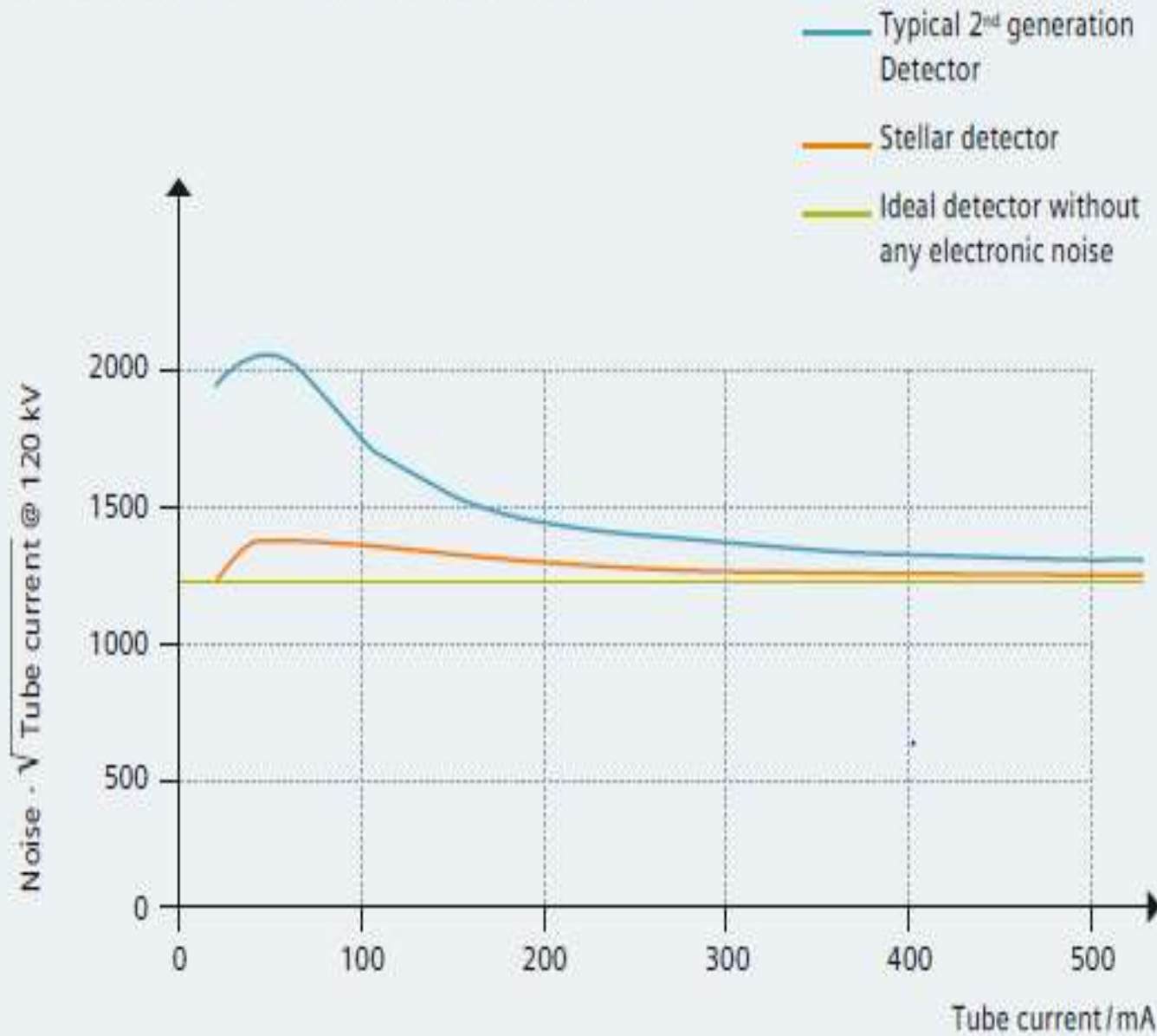



# Nano-Panel Prism Detector (PHILPS)

- ❖ Consists of 3 main components
  - Scintillators** -Top-layer **Yttrium-based garnet** scintillator for detection of lower energies. Bottom-layer **Gadolinium oxysulphide (GOS)** scintillator for detection of higher energies
  - Thin front-illuminated photodiode (FIP)**- maintains overall geometric efficiency of the detector
  - Application Specific Integrated Circuit (ASIC)** –for analog-to-digital conversion

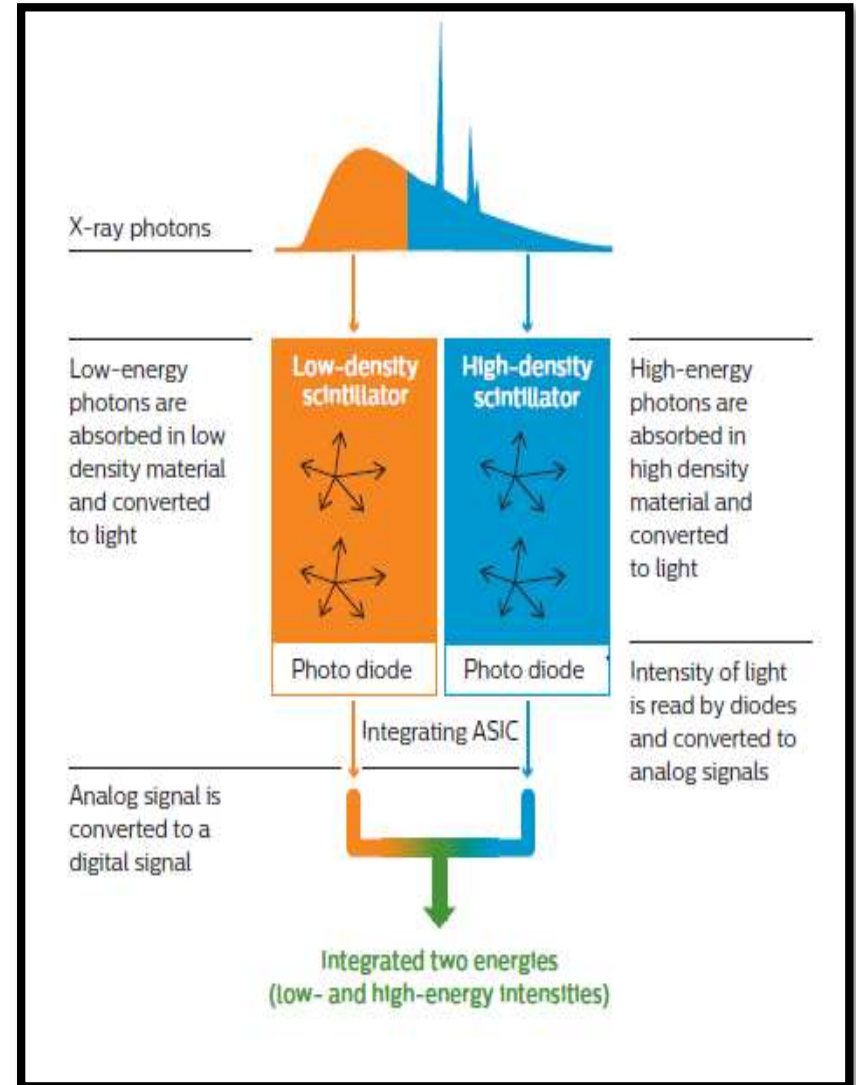

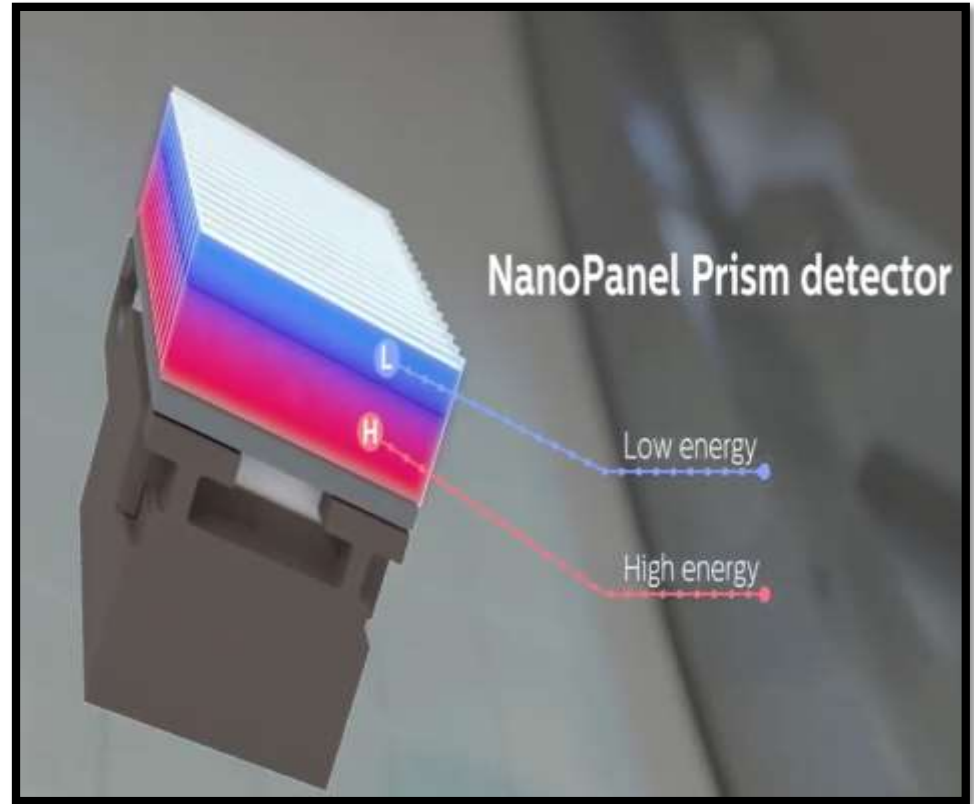
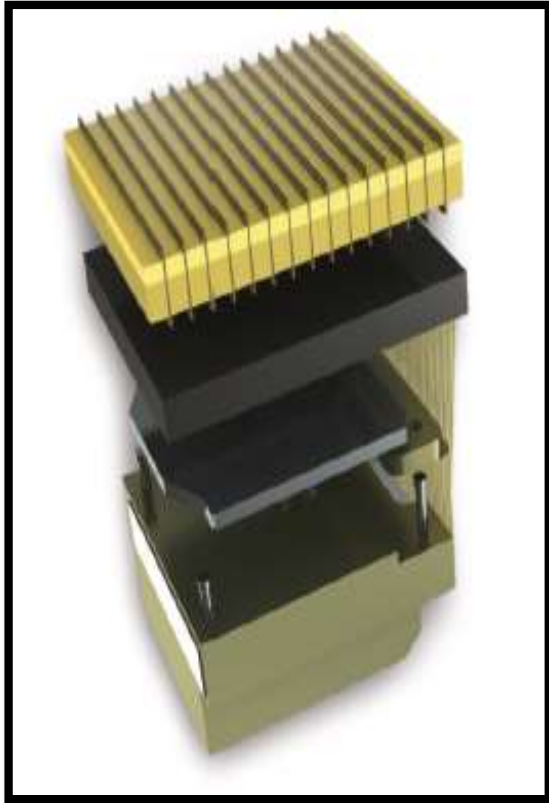

## 3D Tile Patterned Arrangement

# ADVANTAGES

- Wide dynamic range and low noise
- 4 centimeters of detector coverage
- Minimum slice thickness of 0.625 mm
- Supports rotation time as fast as 0.27s
- The FIP usage allow 25% higher light output and 30% less cross talk than previous detectors.
- Delivers color quantification and the ability to characterize structure based on material content



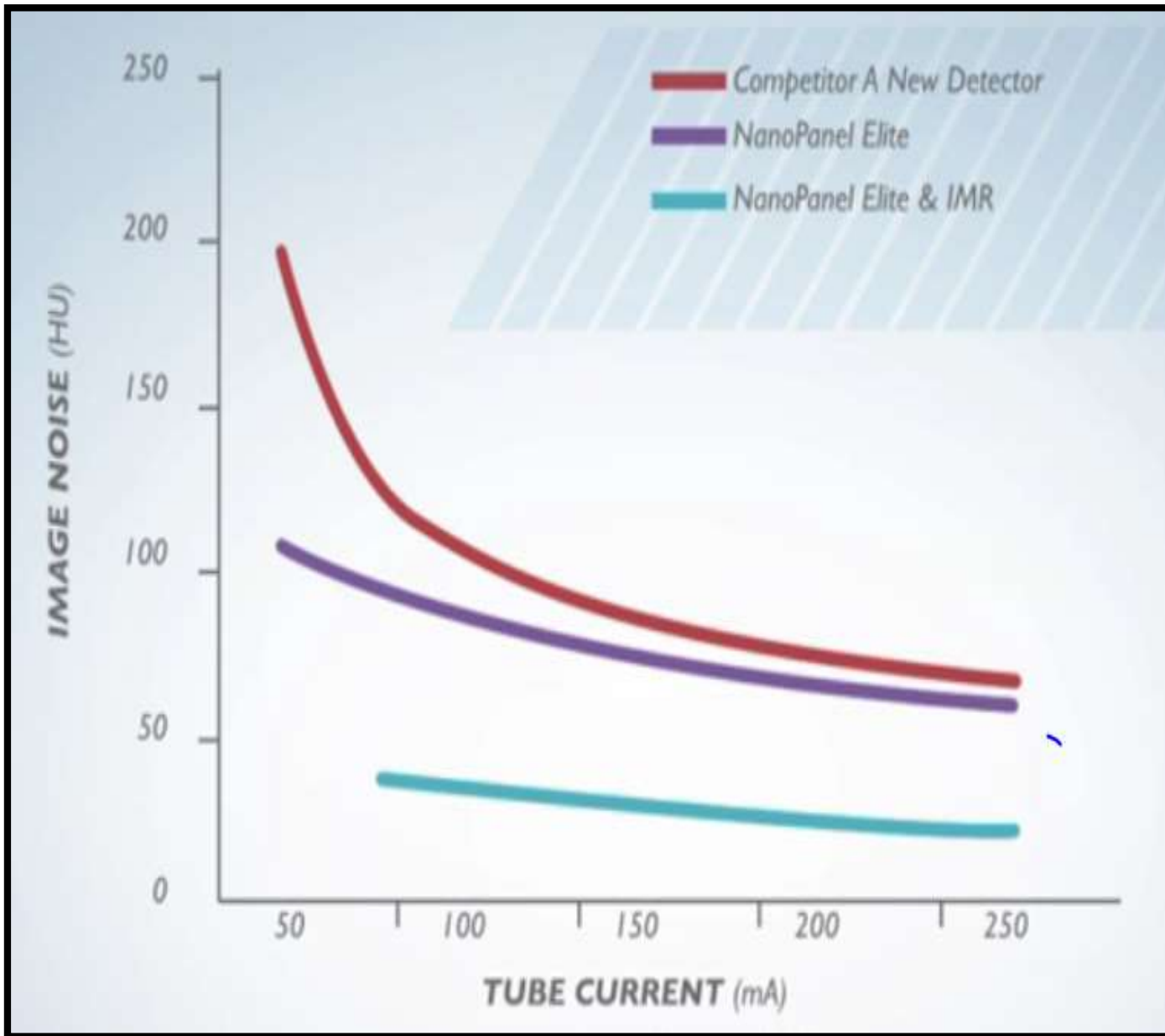

# PURE VISION (TOSHIBA)

3 main goals :-

- a) lower image noise for low dose acquisitions
- b) faster scan times
- c) improved image quality

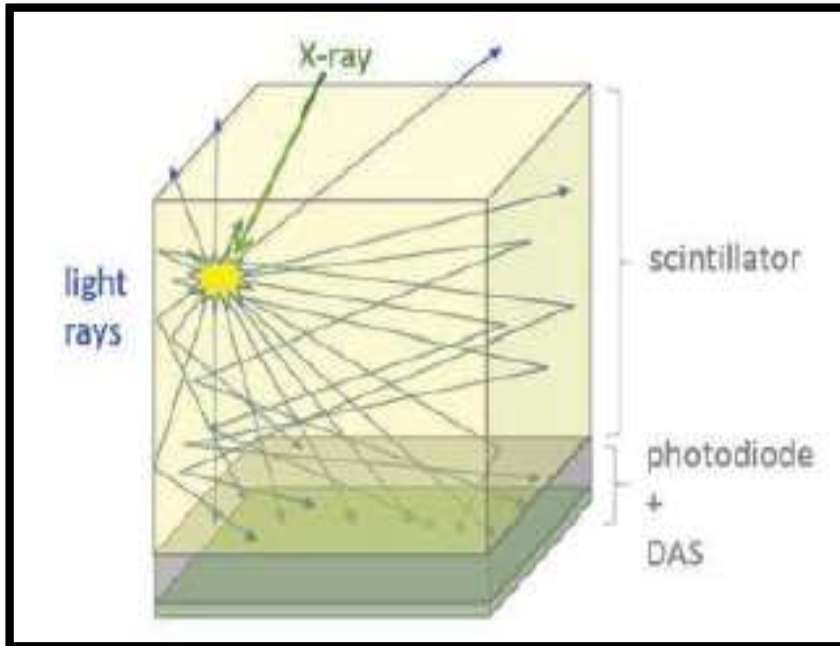

# ADVANTAGES

- Scintillator array of solid ceramic ingot
- Microblade cutting technology
- Maintain straight, smooth edges
- Maximum X-ray absorption surface area
- Minimum septa
- 0.5mm thickness
- Miniaturized integrated circuit(50%)

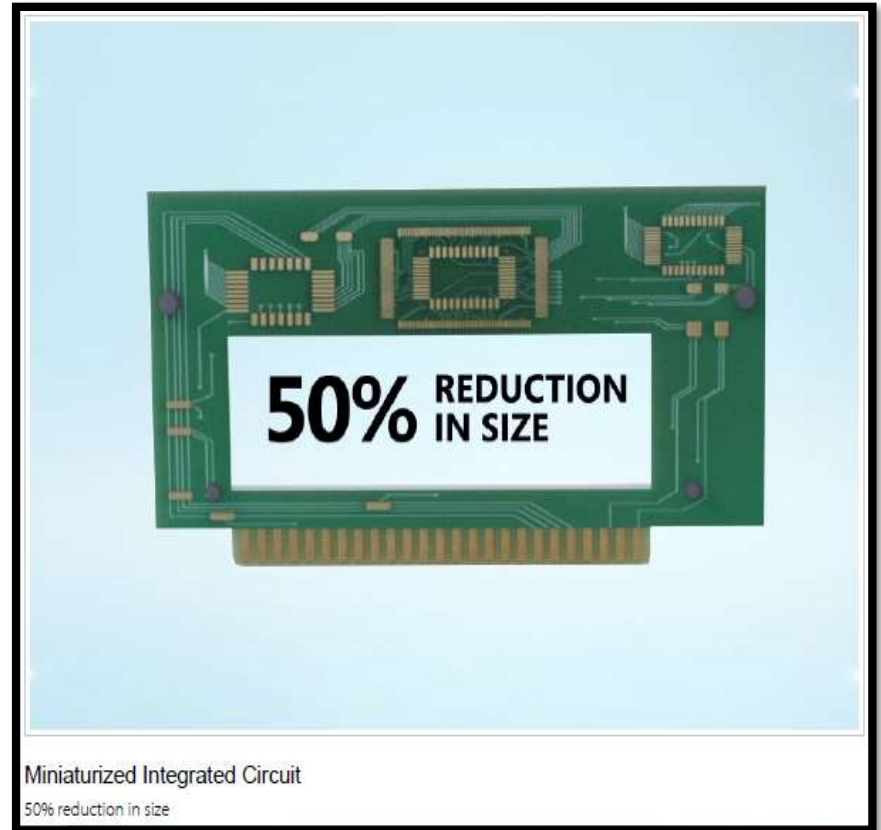
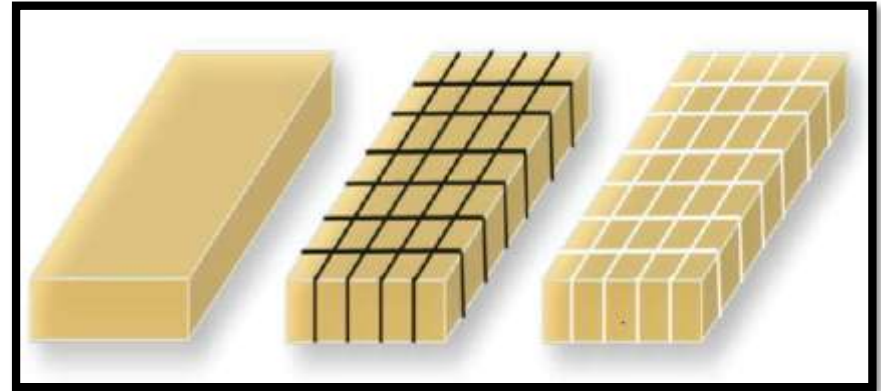

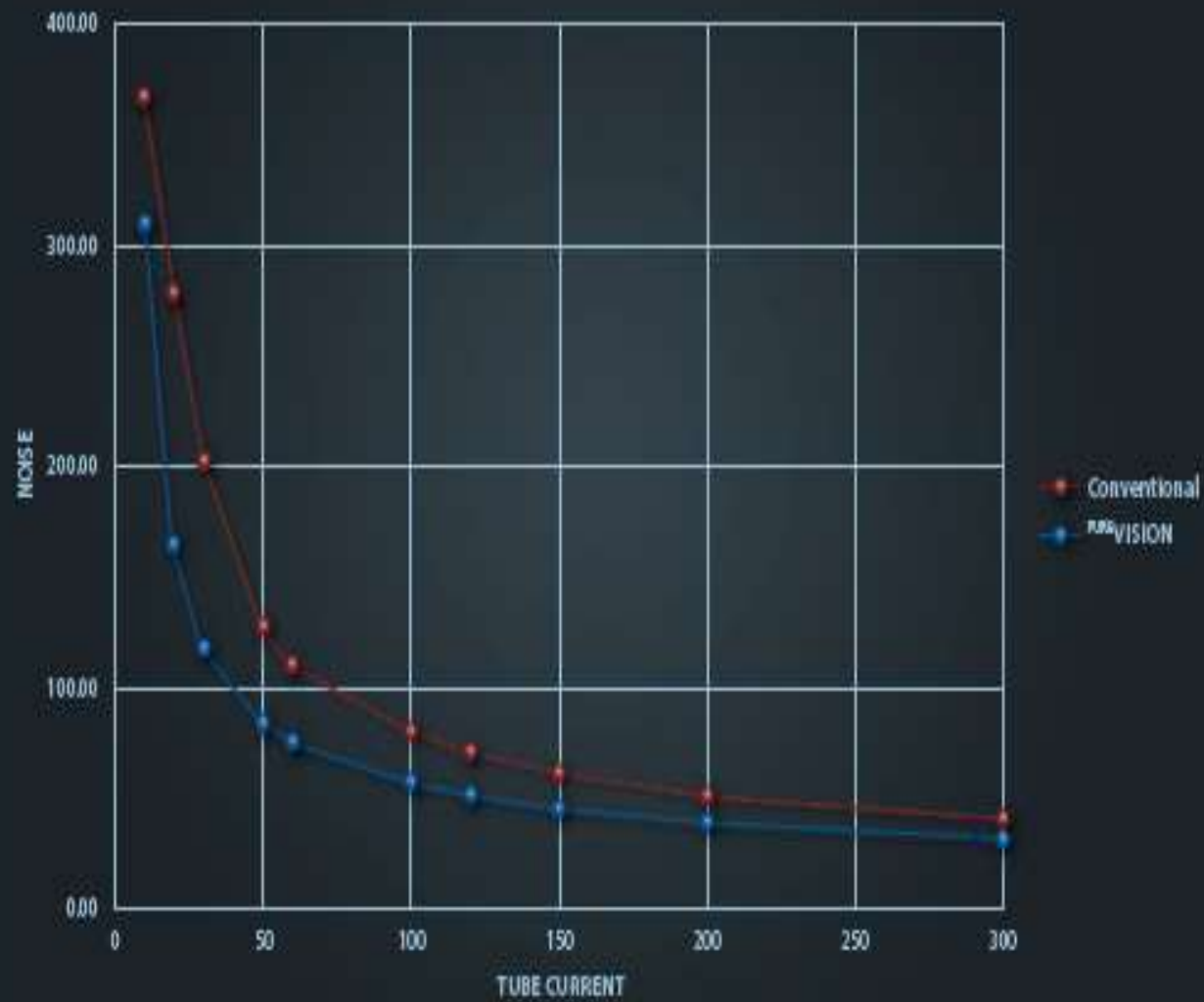

# GEMSTONE DETECTOR(GE)

- 100 times faster than GOS( $0.03\mu\text{s}$ )
- 245mm/s scan speed
- Isotropic ceramic with a highly uniform and translucent cubic structure.
- Faster light emission and shorter after-glow
- Clarity DAS enables 25% reduction in electronic noise





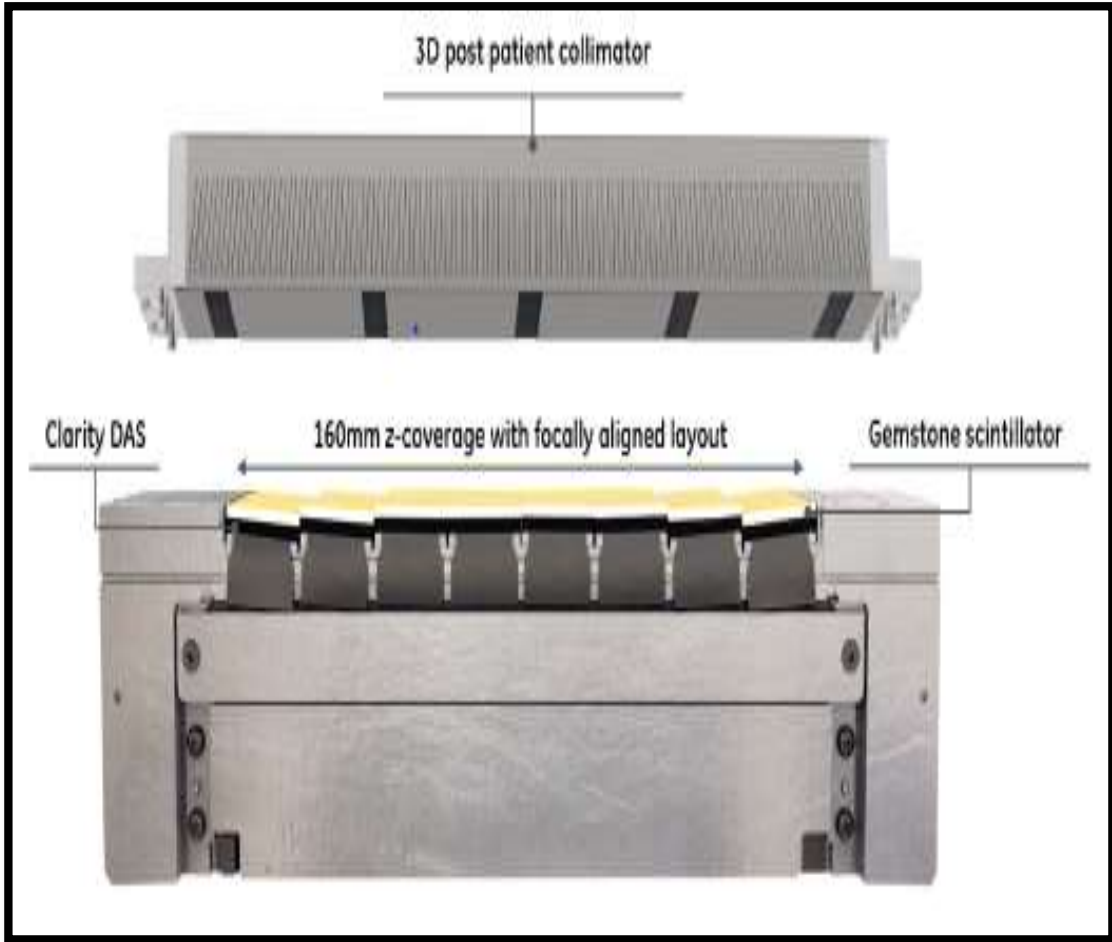

**DETECTOR**



**NEW INTEGRATED  
MODULE**

No poison can kill  
a **positive thinker**,  
and no medicine  
can save a **negative  
thinker.**

[e-buddhism.com](http://e-buddhism.com)

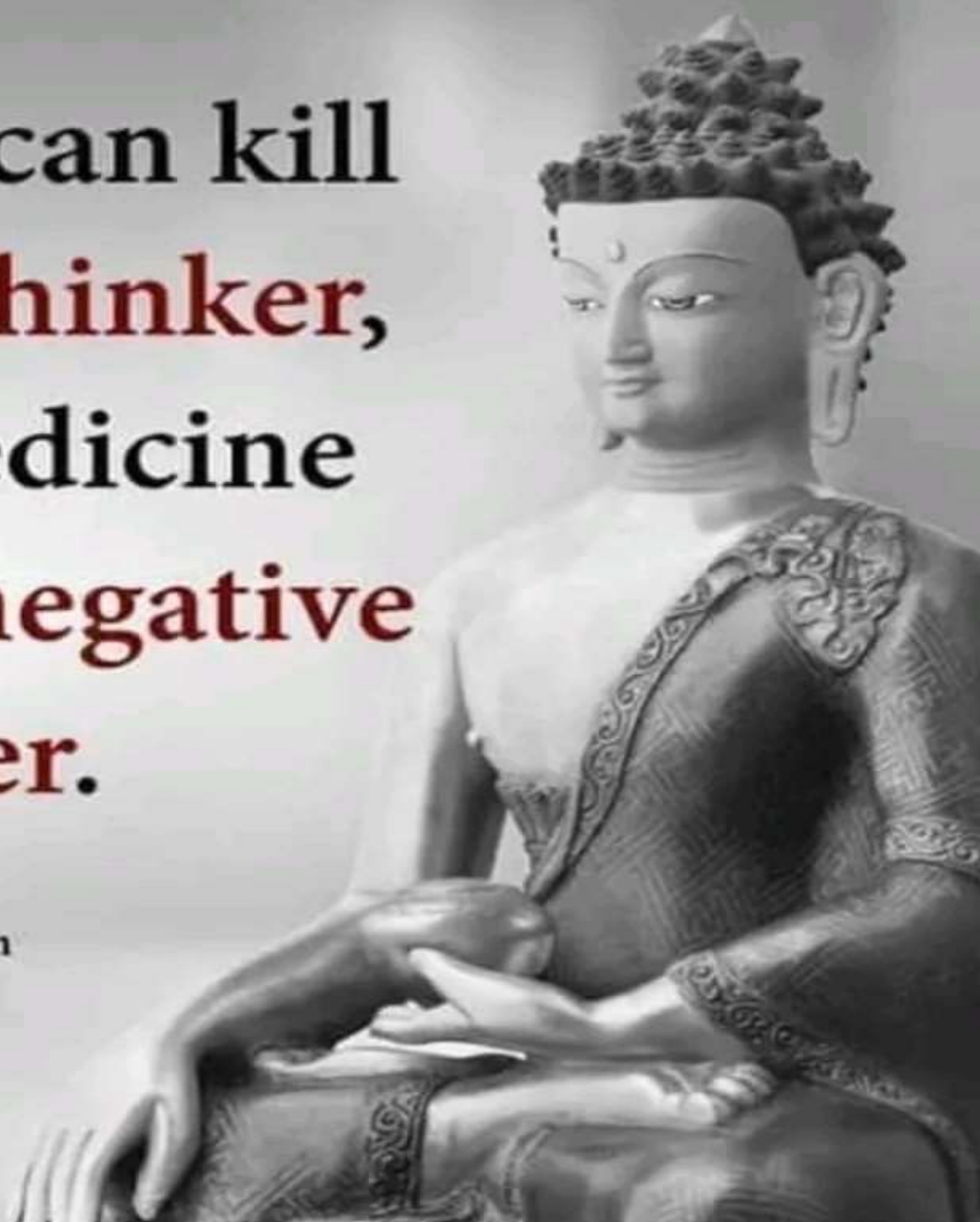

- 1. LINEAR ATTENUATION COEFFICIENT**
- 2. MASS ATTENUATION COEFFICIENT**
- 3. IMAGE RECONSTRUCTION**
- 4. TYPES OF IMAGE RECONSTRUCTION**

- **The basic principle behind CT that the internal structure of an object can be reconstructed from multiple projections of an object.**
- **To carry out the reconstruction, the linear attenuation coefficient of the object is considered as a base.**
- **Attenuation coefficients defined for uncharged particle.**
- **Two types of attenuation coefficients are there.**
  1. **Linear attenuation coefficient.**
  2. **Mass attenuation coefficient.**

# Linear attenuation coefficient

- **Linear attenuation coefficient** is a constant that describes the fraction of attenuated incident photons in a monoenergetic beam per unit thickness of a material.
- **It includes all possible interactions including coherent scatter, Compton scatter and photoelectric effect.**

# Linear Attenuation Coef.

- Why called linear?
  - distance expressed in linear dimension "x"

- Formula

$$N = N_0 e^{-\mu x}$$

where

$N$  = number of incident photons

$N_0$  = number of transmitted photons

$e$  = base of natural logarithm (2.718...)

$\mu$  = linear attenuation coefficient (1/cm); property of  
energy  
material

$x$  = absorber thickness (cm)

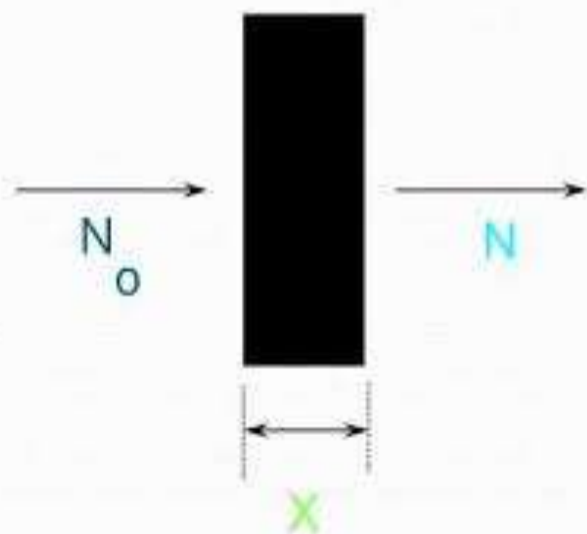

## Monochromatic radiation beam

# MASS ATTENUATION COEFFICIENT

- \* Quantitates the attenuation of materials independent of their physical state .
- \* Obtained by dividing the linear attenuation coefficient by the density .

## MASS ATTENUATION COEFFICIENT : $\mu/\rho$

- \* Unit –  $\text{g}/\text{cm}^2$
- \* Mass attenuation coefficient is independent of the density of the absorber

# Image reconstruction

- In CT , cross sectional layer of body is divided into many tiny blocks already shown in the figure.
- Each block is assigned a number proportional to the degree that the block attenuated the x ray beam.
- The individual blocks called voxels.
- Their composition and thickness along with quality of beam determines the degree of attenuation.
- The linear attenuation coefficient is used to quantitate the attenuation.



- Per example , a single block of homogeneous tissue ( voxel) and a monochromatic x ray beam of x rays:

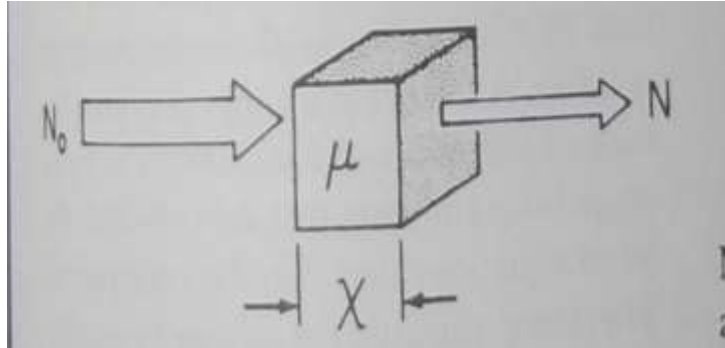

- The value of linear attenuation coefficient is calculated by

$$N = N_0 e^{-\mu x}$$

- If two blocks of tissue with two different linear attenuation coefficients are placed in path of the beam and it is calculated by

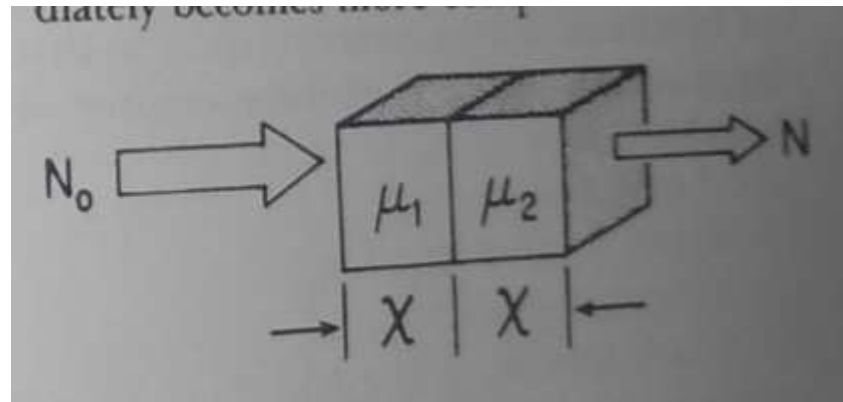

- Now the equation has a two unknowns and it is written as

$$N = N_0 e^{-(\mu_1 + \mu_2)x}$$

- If the number of blocks increased to four, so that each reading represents the composition of two blocks.

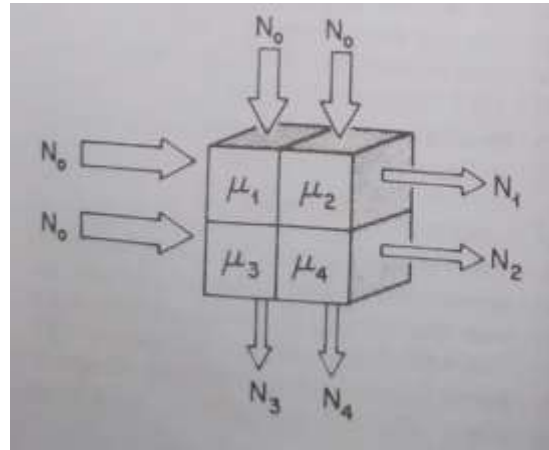

- Then the equations or readings are

$$\begin{aligned} N_1 &= N_0 e^{-(\mu_1 + \mu_2)x} \\ N_2 &= N_0 e^{-(\mu_3 + \mu_4)x} \\ N_3 &= N_0 e^{-(\mu_1 + \mu_3)x} \\ N_4 &= N_0 e^{-(\mu_2 + \mu_4)x} \end{aligned}$$

- For example, the original emi scanner , the matrix in the computer contained  $80 \times 80$  , or 6400 pixels.
- The number of separate equations and unknowns now be comes at least 6400.
- The original emi scanner took 28,000 readings .
- A fan beam scanner may take between 1,00,000 to 2,00,000 reading.
- In a typical commercial CT system, an image is reconstructed from 106 independent projection samples.

# Methods of Reconstruction

- ◆ The CT scan results in the acquisition of A projection set for each CT slice.
- ◆ The computer hardware and software convert the raw data into CT images through the process called image reconstruction.
- ◆ There are three mathematical methods of image reconstruction used in ct
  1. Iterative reconstruction.
  2. Simple back projection.
  3. Analytical method.
    - Filtered back projection.
    - Fourier reconstruction.

# Iterative reconstruction

- Iterative method is the original method used by G. N. Hounsfield.
- This technique uses series of calculations that run repeatedly.
- After each run , the resulting image appears more and more like the actual object.
- After a certain number iterations, the image converges with the image of the the actual object.
- The errors between the measured and calculated CT projections are used update the image for next iteration.

# Simple back projection

- Back projection is a mathematical process, based on trigonometry, which is designed to emulate the acquisition process in reverse.
- In this method, required projections of an object are obtained by multiple scans.
- Then, the projections are back projected image receive density contribution from neighboring structures and creates noise.
- Hence the image quality is very poor and large number of projections are required to improve the image quality.
- The disadvantage of the method is the blurred image of the object and hence not used today.

# Filtered back projection

- It is similar to back projection, but the raw data are mathematically filtered by convolution kernel before being back projected .
- The various types convolution kernel includes
  1. Lak filter .
  2. Sheppe Logan filter.
  3. Hamming filter.
  4. Bone filter.
  5. Soft tissue filter.



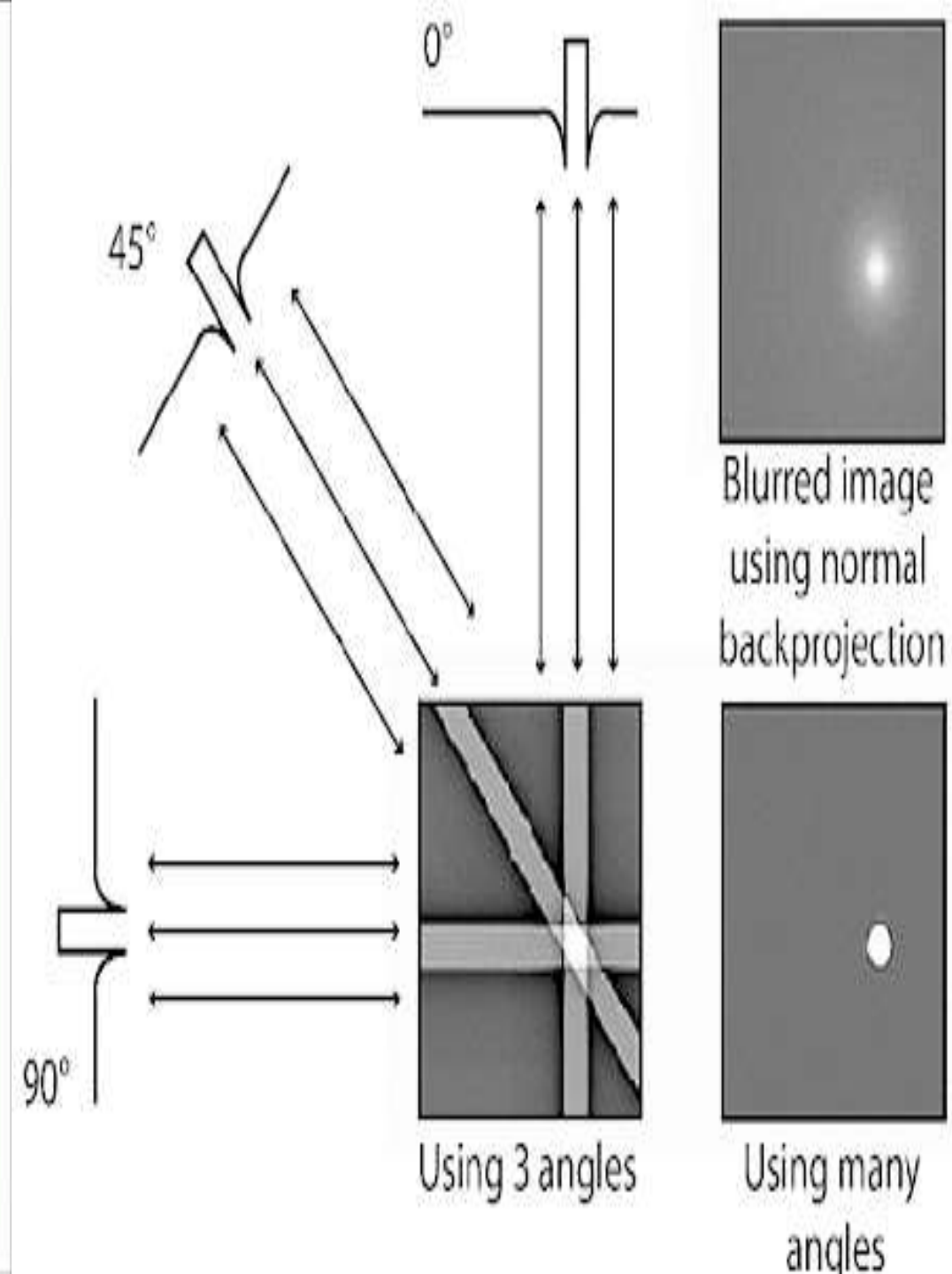
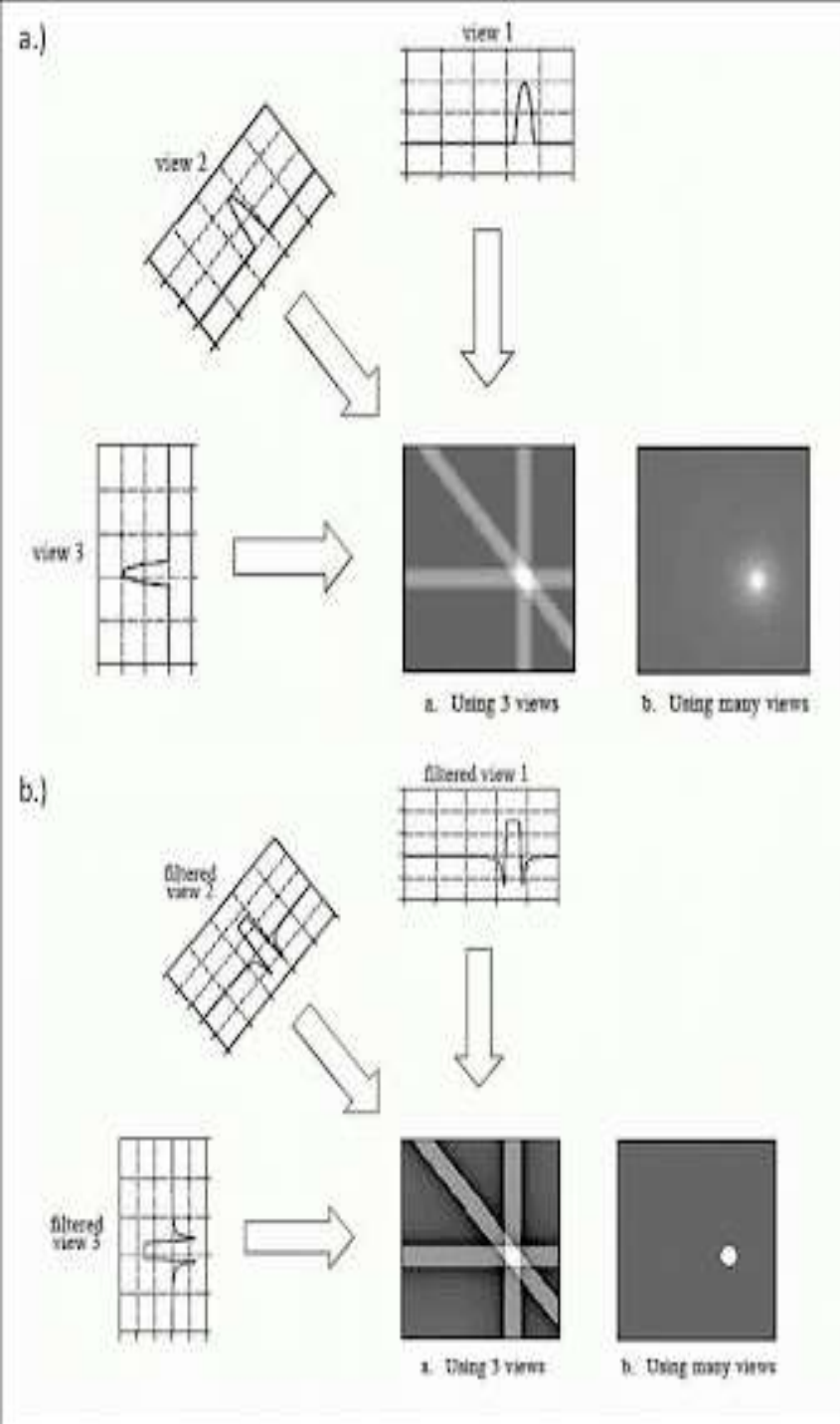

# Fourier transform

- Fourier transform is a mathematical operation which converts a time domain signal into a frequency domain signal.
- Fourier transform is integral to all modern imaging, and is particularly important in MRI. The signal received at the detector (**receiver coils in MRI, piezoelectric disc in ultrasound and detector array in CT**) is a complex periodic signal made of a large number of constituent frequencies (i.e., bandwidth).
- This can be visualized as multiple sine and or cosine waves along a time-axis.



**Don't overthink**  
**overthinking** leads to  
SUNGRACE SCHOOLS PUNE  
**Negative Thoughts**

# CT ARTIFACTS

- Artifacts can degrade image quality, affect the perceptibility of detail, or even lead to misdiagnosis.
- This can cause serious problems for the radiologist who has to provide a diagnosis from images obtained by the technologist.
- Therefore it is mandatory that the technologist understand the nature of artifacts in CT.
- A CT image artifact is defined as “any discrepancy between the reconstructed CT numbers in the image and the true attenuation coefficients of the object”.
- In CT, artifacts arise from a number of sources, including the patient, inappropriate selection of protocols, reconstruction process, problems relating to the equipment such as malfunctions or imperfections, and fundamental limitation of physics.

# TYPES OF ARTIFACTS

1. Patient Motion artifacts.
2. Streak artifacts.
3. Metal artifacts.
4. Beam hardening or Cupping artifacts.
5. Aliasing artifacts.
6. Noise artifacts.
7. Partial volume artifacts.
8. Ring artifacts or band artifacts
9. Truncation artifacts.
10. Cone beam artifacts.
11. Spiral artifacts.
12. Rod artifacts.

# Patient Motion artifacts

- Patient motion can be voluntary or involuntary.
- Both voluntary and involuntary motions appear as streaks that are usually tangential to high-contrast edges of the moving part.
- Additionally, motion artifacts can arise from movement of oral contrast in the gastrointestinal tract.
- For patient movements such as breathing and swallowing, it is important to immobilize patients and use positioning aids to make them comfortable and to ensure that patients understand the importance of remaining still and following instructions during scanning and other is reducing scan time.
- Involuntary movements decreased by Respiratory techniques like ECG gating.

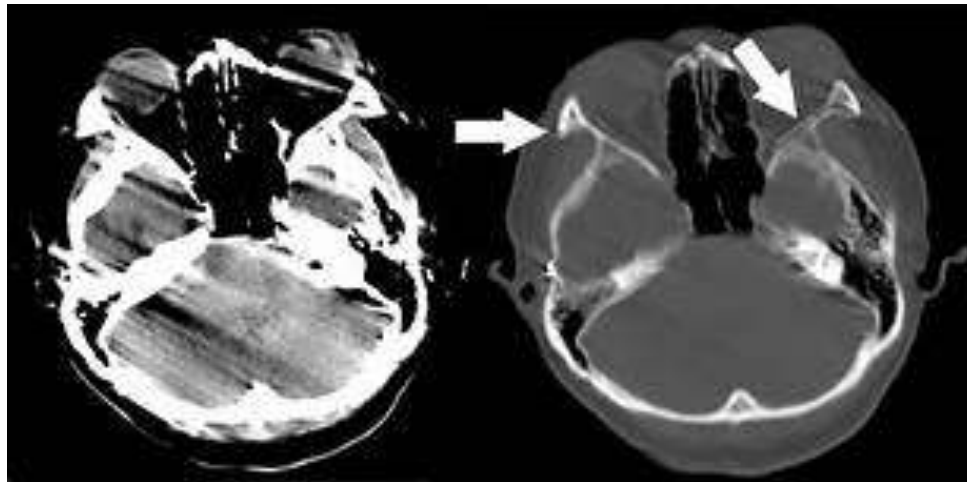

# Streak artifacts

- Streak artifacts due to **absence of transmitted X rays** to the detector and it appears as dark and light lines.
- Most streak artifacts occur near materials such as metal or bone, primarily as a result of beam hardening and scatter.
- These phenomena produce dark streaks between metal, bone, iodinated contrast, barium, and other high-attenuation materials.
- Streak artifacts can be reduced using newer reconstruction techniques or metal artifact reduction software.

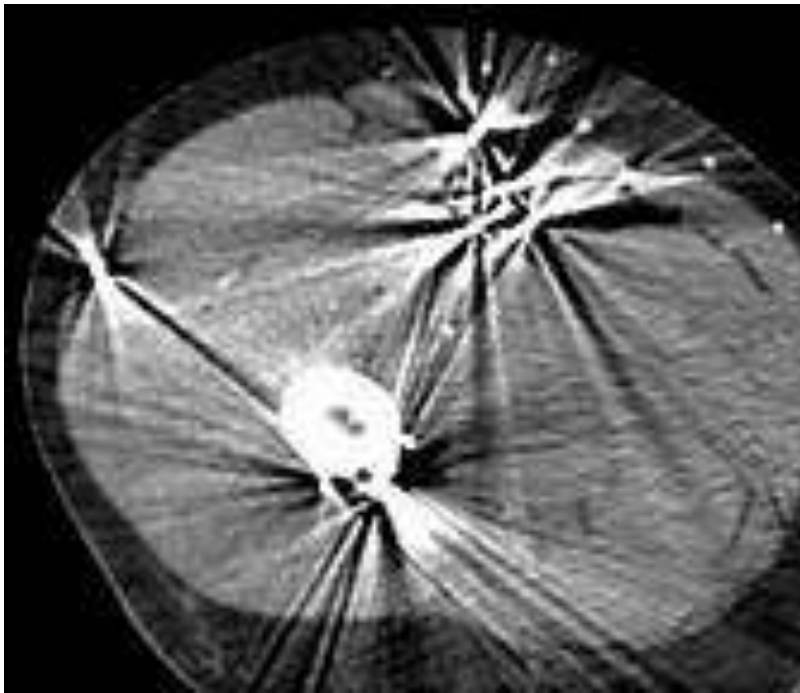

# Metal artifacts

- The presence of metal objects in the patient also causes artifacts.
- Metallic materials such as prosthetic devices, dental fillings, surgical clips, and electrodes give rise to streak artifacts on the image.
- the metal object is highly attenuating to the radiation, which results in significant error in projection profiles.
- The error is the combined effects of signal under range, beam hardening, partial volume, and limited dynamic range of the acquisition and reconstruction systems.
- The loss of information leads to the appearance of typical star-shaped streaks.
- **Metal artifacts can be reduced by the removal of all external metal objects from the patient. Software such as the metal artifact reduction (MAR) program can be used to complete the incomplete profile through interpolation.**

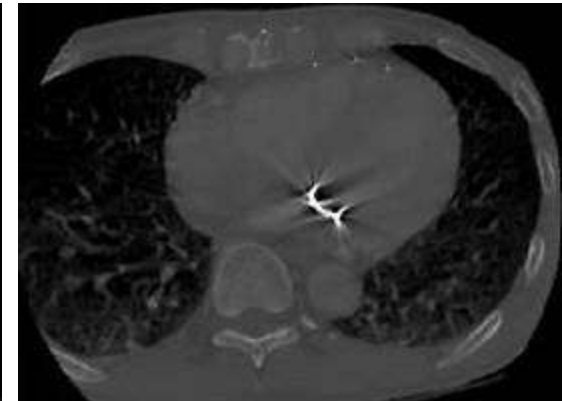



# Beam hardening artifacts.

- These are caused by polychromatic nature of x ray beam.
- As the beam passes through the patient, a low energy absorbed and the mean energy increases.
- As the result the beam become hardened that causes underestimation of  $\mu$  and HU. It is possible to minimize the beam hardening effect by suitable correction algorithm.
- Because of the beam-hardening effect, errors in CT numbers increase gradually from the periphery to the center of the object, as depicted by the present in the beam path, **dark shading artifacts can result** because the beam-hardening correction applied to soft tissue does not work well for bones.
- Eg : bones and iodinated contrast media.

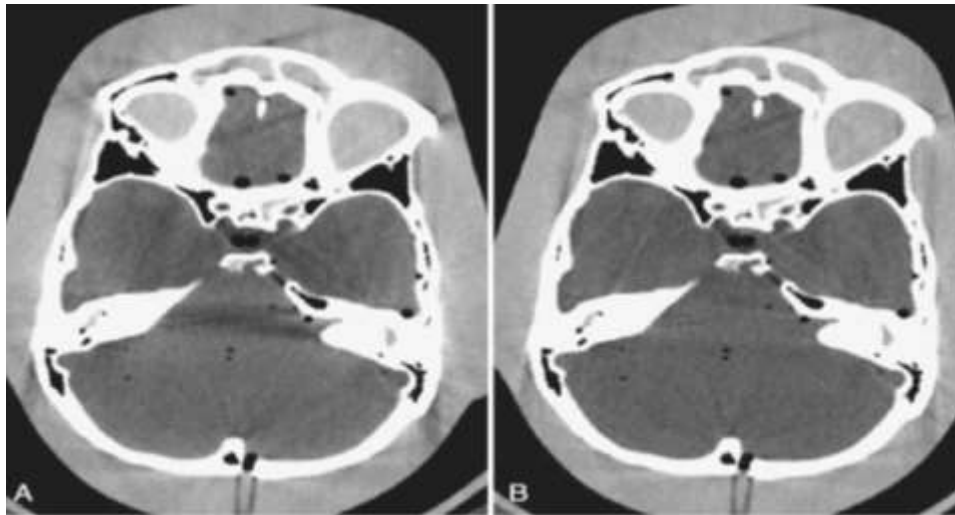

# Aliasing artifacts.

- **Aliasing artifact**, otherwise known as **undersampling**, in CT refers to an error in the accuracy proponent of analog to digital converter (ADC) during image digitization.
- Image digitization has three distinct steps: scanning, sampling, and quantization.
- When sampling, the brightness of each pixel in the image is measured, and via a photomultiplier, creates an output analog signal that is then due to undergo quantization.
- The more samples that are taken the more accurate the representation of the signal will be, hence if a lack of sampling has occurred the computer will process an inaccurate image resulting in an aliasing artifact.



# Noise artifacts

- Noise is influenced partially by the number of photons that strike the detector.
- **More photons mean less noise and a stronger detector signal, whereas fewer photons result in more noise and a weaker detector signal.**
- When it is combined with the electronic noise and the logarithmic operation, photon starvation often leads to severe streak artifacts.
- The technologist should optimize patient positioning, scan speed, and exposure technique factors to correct streak artifacts.

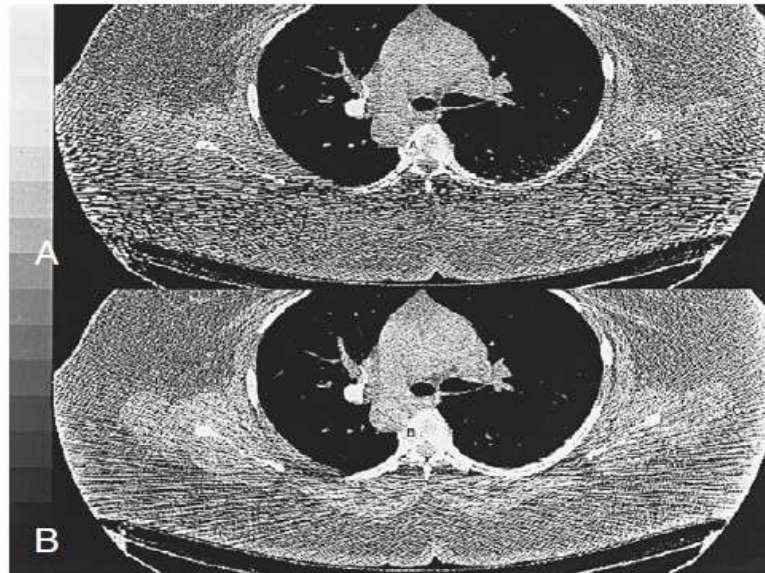

**FIGURE 9-44** **A**, Streak artifacts can arise from an increase in noise resulting from reduced photons at the detector. **B**, Correction of the streaks by adaptive filtering.

# Partial volume artifacts.

- If the voxel contains only one tissue type, the calculation will not be problematic.
- For example, if the tissue in the voxel is gray matter, the CT number is computed at around 43.
- If the voxel contains three similar tissue types in which the CT numbers are close together—for example, blood (CT number 40), gray matter (43), and white matter (46)—then the CT number for that voxel is based on an average of the three tissues. This is known as partial volume averaging.
- Partial volume artifacts can be reduced with thinner slice acquisitions and computer algorithms

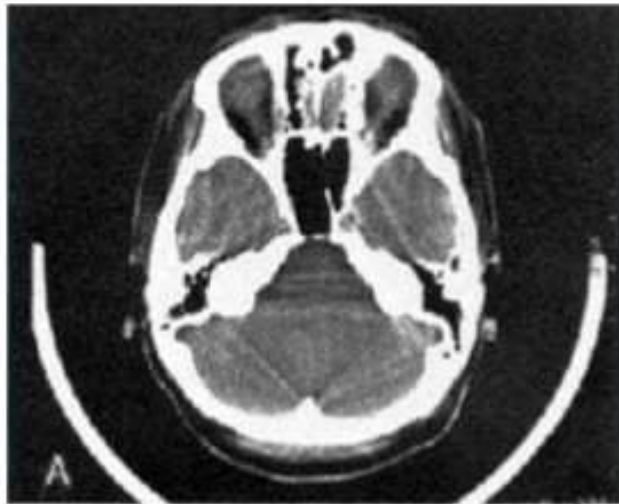

Thick slice



Thin slice

# Ring artifacts or band artifacts

- Ring artifacts are a CT phenomenon that occurs due to miscalibration or failure of one or more detector elements in a CT scanner.
- Less often, it can be caused by insufficient radiation dose or contrast material contamination of the detector cover .
- They occur close to the isocenter of the scan and are usually visible on multiple slices at the same location. They are a common problem in cranial CT.
- **Recalibration of the scanner will usually rectify the artifact. Occasionally detector elements need replacing which can be costly.**

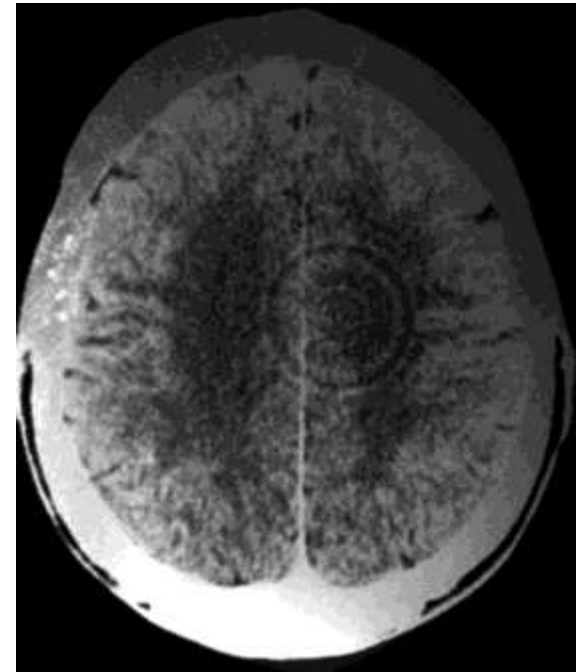

# Truncation artifacts.

- Truncation artifact in CT is an apparently increased curvilinear band of attenuation along the edge of the image.
- This artifact is encountered when parts of the imaged body part remain outside the field of view (e.g. due to patient body habitus), which results in inaccurate measurement of attenuation along the edge of the image.
- The artifact can be reduced - if possible - by using an extended FOV reconstruction of the affected region .

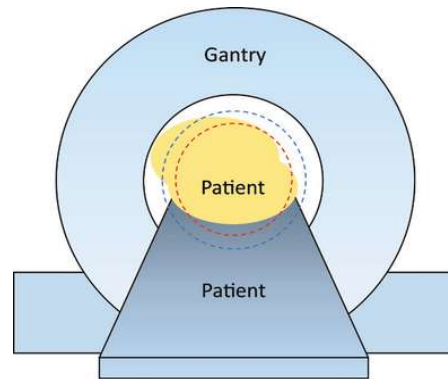

a.

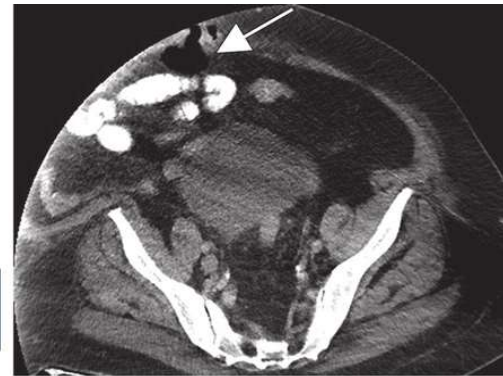

b.

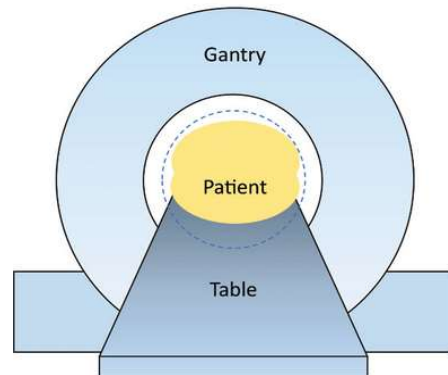

“ If you are born poor  
its not your mistake  
But if you die poor  
its your mistake ”

*Bill Gates*



Let's Learn

[www.youtube.com/LetsLearnCom](http://www.youtube.com/LetsLearnCom)